



 **RAM** **COMMERCIAL**

2013 RAM CHASSIS CAB



Ram 4500 Regular Cab Tradesman with optional wheels and aftermarket Stake Body upfit shown in Bright White.

THE NEW 2013 RAM CHASSIS CABS.

INDUSTRIAL-LEVEL REFINEMENT THAT SETS NEW BENCHMARKS FOR BEST IN THE BUSINESS: VERSATILITY, CAPABILITY, AND POWER.

The team of engineers and designers behind this exceptional line of workhorses know this business inside out — exactly why the many improvements and refinements vault the new Ram Chassis Cabs to first-place consideration when you need a powerful work partner on your team. From new exterior style to strengthened components to interiors that put technology, comfort, and communications at your fingertips, the 2013 Ram Chassis Cabs set a new standard for business. For more, get over to ramtrucks.com

CLASS-LEADING ADVANTAGES WITH ONE GOAL: BUILD OUR ECONOMY BY BUILDING YOUR BUSINESS.

- **BEST-IN-CLASS^[1] MAX GCWRs.** Gross Combined Weight Ratings for 2013 Ram Chassis Cabs are at the top of their game, offering exceptional capability where it counts most.
- **BEST-IN-CLASS^[1] TOWING.** For all classes, new Ram 3500/4500/5500 Chassis Cabs offer superior pulling power.
- **BEST-IN-CLASS^[2] MAX FGAWRs.** Ram 4500/5500 front axles are revised — and offer remarkable strength and capability.
- **BEST-IN-CLASS^[2] AVAILABLE DIESEL TORQUE.** Improvements to the formidable Cummins® Turbo Diesel and the proven AISIN® transmission help achieve new best-in-class^[2] honors for Ram 4500/5500 models, along with enhanced PTO capability, new Next-Gen DEF systems, and the new “smart” diesel exhaust brake.
- **GROUNDBREAKING ESC.^[3]** For 2013, the comprehensive Electronic Stability Control^[3] system is now standard on every new 2013 Chassis Cab model in the Ram portfolio.

The list of assets is extensive — as you're about to see.

DRIVE BUSINESS. WITH THE NEW 2013 RAM CHASSIS CABS.

*A note about this brochure: all disclaimers and disclosures can be found on the back cover.

CAPABILITY DEFINED... AND REFINED.

THIS LEVEL OF QUALITY RULES THE ROAD — AND THE JOB SITE. When our designers and engineers took on reengineering trucks as tough as the new 2013 Ram 4500/5500 Chassis Cabs, it was a big-picture proposition: while our best-in-class figures play a decisive role in meeting today's needs, these are purchase decisions capable of taking on big jobs for years to come. Big investments warrant big payoffs, and new Ram Chassis Cabs deliver purpose-driven engineering that combines the best in capability, durability, maneuverability, and overall comfort. Best of all, they do it *brilliantly*.

WHEN ONLY THE BEST WILL DO, WE'RE AVAILABLE. The demands of the job mean you need capability and strength second to none — and with available Gross Combined Weight Ratings (GCWRs) for all weight classes at best-in-class^[1] levels, only the new 2013 Ram Chassis Cabs will do. Add a revised front suspension — now with frame modifications to better accommodate snowplows and front-mounted systems — and factor in the new available best-in-class^[2] Front Gross Axle Weight Rating (FGAWR) for Ram 4500 and 5500 models; it now reaches a solid 7,250 lb up front when properly equipped. Improvements include a revised camber to help extend tire tread life; shock absorbers now tuned to each wheelbase/engine configuration; enhanced, more precise steering; a modified rear suspension to better handle increased loads; and a class-exclusive^[2] innovation that puts Ram 4500/5500 Chassis Cabs in a class of their own, with new Electronic Stability Control (ESC),^[3] now standard on all Ram Chassis Cab models.

ULTRA-CONTROL FOR TOWING, HAULING, HANDLING: NEW ESC^[3] MEANS ALL SYSTEMS GO. Towing expertise encompasses powertrains, axles, frames, and brakes. New Ram is up for it, with an invaluable advantage: Electronic Stability Control,^[3] now standard on every Ram Chassis Cab. Calibrated precisely to work with the specific horsepower and torque output of each model, the comprehensive four-channel ESC^[3] system includes the **Antilock Brake System (ABS)** — which even comprises a backup brake system. **Electronic Brake Force Distribution** regulates pressures front-to-rear for

Look closely at these no-nonsense work vehicles, and the conclusion is breathtaking: *this is what it takes*. Count on new developments from Cummins® that boost torque in the formidable 6.7-liter Turbo Diesel. A new available AISIN® six-speed automatic transmission. Stronger, tougher frames and beefed-up axles. Reconfigured and stronger suspensions. Modified steering for even greater precision. And more upfitter-friendly PTO capability and control than ever. Add interiors that take sophistication, communications, and comfort to new levels, factor in a transferable Powertrain Limited Warranty,^[4] and you've got quality only Ram can deliver.



optimum braking. When the full-function **All-Speed Traction Control System** senses wheel slip, it signals for throttle control; you can also control it through the all-new Integrated Switch Bank on the center stack. **Ready Alert Braking, Rain Brake Support,** and **Brake Assist** all help improve braking characteristics under varying conditions. **Electronic Roll Mitigation** helps maintain control during severe driving maneuvers, and **Trailer Sway Control^[3]** is indispensable, helping control trailer pitch and yaw while underway. More on this engineering advantage is available at ramtrucks.com

+ **THE NEW AVAILABLE PARKVIEW® REAR BACK-UP CAMERA⁵¹** FOR 2013 RAM CHASSIS CABS OFFERS HIGH-RESOLUTION IMAGING TO HELP ELIMINATE THE NEED FOR AN OUTSIDE SPOTTER. IT'S NOW SHIPPED WITH THE VEHICLE AND INSTALLED BY THE UPFITTER IN THE OPTIMAL LOCATION.

+ **A NEW STEERING DAMPER, NEW BALL JOINT SEALS, AND A NEW STEERING COOLER** (ON DIESEL-EQUIPPED MODELS) START THE LIST OF ENHANCEMENTS TO STEERING. ALL HELP ACHIEVE GREATER EFFICIENCY AND PRECISION, AND RAMP UP DURABILITY. WE ALSO EXTENDED THE TRACK BY 14mm — ENGINEERING THAT HELPS INCREASE ALIGNING TORQUE.

+ **THE PROVEN ONE-PIECE STAMPED C-CHANNEL DESIGN FRAMES** FOR THE NEW 2013 RAM CHASSIS CAB PORTFOLIO ARE ENGINEERED TO LAST. THE CRITICAL REAR FRAME RAILS OFFER DESIGNED-IN QUALITY TO DO THE JOB, DELIVERING BEST-IN-CLASS¹¹ REAR FRAME STRENGTH RATED AT 50k p.s.i.

+ **NEW JOUNCE BUMPER BRACKETS, A NEW PARK BRAKE BRACKET, AND NEW FRONT AND REAR AUXILIARY BRACKETS** ON RAM 4500/5500 MODELS DEMONSTRATE EXTENSIVE RECENT FRAME ENHANCEMENTS. THE AMOUNT OF PAYLOAD AND DEGREE OF CUSTOMIZATION MAKES THIS ONE OF THE MOST UPFITTER-FRIENDLY TRUCKS ON THE ROAD.



+ **WITH ITS HEAVY-DUTY FIVE-LINK COIL SPRING FRONT SUSPENSION DESIGN THAT FEATURES A BEAM AXLE AND TUBULAR LOWER CONTROL ARMS**, RAM 3500/4500/5500 CHASSIS CABS ARE DESIGNED FOR YEARS OF SERVICE. THIS IS CAPABILITY THAT COUNTS, WITH EXCELLENT ON- AND OFF-ROAD PERFORMANCE (WITH OVER 7.5 INCHES OF RIDE TRAVEL) AND DRAMATIC INCREASES IN AVAILABLE FRONT GAWRS FOR 4500/5500 MODELS. IN SHORT: ENHANCED CAPABILITY FOR CONFIDENCE ON THE JOB — AND ON THE ROAD.

+ **MODIFIED HOTCHKISS (OR LEAF) REAR SUSPENSIONS ON RAM 4500/5500 HAVE BEEN RECONFIGURED.** THESE TOUGH COMPONENTS NOW HANDLE INCREASED LOADS WHILE MAINTAINING A LEVEL RIDE ATTITUDE.

+ **STANDARD 17-INCH STEEL WHEELS ON 3500 MODELS, AND HUGE 19.5-INCH STEEL WHEELS FOR 4500/5500 MODELS** OFFER AUTHORITY ON THE STREET AND CAPABILITY ON THE SITE. TO FURTHER ENHANCE THE LOOK, STYLISH POLISHED ALUMINUM WHEELS ARE AVAILABLE FOR ALL RAM CHASSIS CAB MODELS.



Ram 4500 Regular Cab Tradesman with aftermarket Stake Body upfit and optional wheels shown in Bright White. Properly secure all cargo.

Ongoing developments at Cummins® vastly improve performance.

- + **A new “smart” diesel exhaust brake** — think cruise control efficiency — on all versions of the Cummins engine ensures greater control and load management regardless of terrain, especially on downhill grades.
- + **A new engine cooling system** with an improved 11-blade radiator fan achieves 25 percent greater heat reduction.
- + **A top-access fuel filter** (as opposed to the typical bottom-load filter) helps provide optimal fuel filtration and water separation. A new, second frame-mounted fuel filter doubles filtration efficiency.
- + **15,000-mile oil change intervals** help lower maintenance costs and improve your bottom line. This best-in-class^[1] feature gives you a distinct advantage over the competition, helping reduce expenses and downtime.
- + **A revised Engine Control Module** upgrades the processing power and increases flash memory for completely integrated control and outstanding performance.
- + **Biodiesel compatibility** is simple; use the B20 option when ordering, or have the dealer electronically configure the engine, post-sale.

- CONFIGURATION:** 6-cylinder in-line, liquid-cooled turbocharger with intercooler
- DISPLACEMENT:** 408 cu in (6690 cu cm)
- STANDARD OUTPUT:** 320 hp / 650 lb-ft with G56 6-speed manual transmission
- HIGH OUTPUT:** 325 hp / 750 lb-ft with AISIN® AS69RC 6-speed automatic
- BORE / STROKE:** 4.21 x 4.88 in (107 x 8124 mm)
- BLOCK MATERIAL:** Cast iron
- CYLINDER HEAD MATERIAL:** Cast iron
- OIL CAPACITY:** 12 quarts, with filter
- COOLANT CAPACITY:** 29.5 quarts
- VALVETRAIN:** Overhead, with 4 valves per cylinder (24 total)
- FUEL DELIVERY:** Electronic high-pressure common rail
- RECOMMENDED FUEL:** Ultra-low sulfur diesel
- COMPRESSION RATIO:** 17.3:1
- ALTERNATORS:** 180-amp standard, 220-amp available, 440-amp available*
- ADDITIONAL FEATURES:** B20 / biodiesel available; Next-Generation DEF urea system; integrated intake grid heater; outstanding cold-start capability

*Late availability.



5 YEAR / 100,000 MILE
POWERTRAIN LIMITED WARRANTY^[4]

Quality is the backbone of Ram and Cummins, with every 2013 Ram Chassis Cab backed by an unsurpassed^[1] 5-Year/100,000-Mile Powertrain Limited Warranty.^[4]

CUMMINS® POWER.

**NEW FOR 2013: A BOLD AVAILABLE HIGH OUTPUT VERSION,
“SMART” DIESEL EXHAUST BRAKE, ALL-NEW RAM ACTIVE AIR —
AND BEST-IN-CLASS^[2] AVAILABLE TORQUE FOR 4500/5500.**

Supremacy measured by the available Cummins Turbo Diesels boils down to bottom-line real-world advantages: new, improved power and capability; new, best-in-class^[2] available torque for 4500/5500; even new available dual 220-amp alternators.* This is beyond-capable performance focused on minimal downtime, improved quality and durability, with PTO and powertrain capability that set the benchmark.

Two power output variations allow enormous latitude. Packaged with the six-speed manual transmission is the 320 horsepower / 650 lb-ft of torque version, standard for Ram 4500/5500 and available for Ram 3500 Chassis Cab. The available Cummins High Output generates 325 hp and an incredible 750 lb-ft of torque; it's mated to the upgraded six-speed AISIN® automatic transmission and is available for all Ram Chassis Cab models.



New Ram Active Air (shown above), new “smart” diesel exhaust brake, new engine cooling system: this is Cummins at its best.

Exclusive to Cummins powered Ram Chassis Cabs is new Ram Active Air, advanced technology that switches the air intake path between the fender and front grille for optimal power and torque under all grades, climates, and load/towing conditions. A new advanced engine cooling system dissipates heat with 25 percent greater efficiency — a development that directly contributes to better efficiency and increased capability.

Designed specifically to handle the new Cummins higher-output ratings, higher vehicle weight ratings, and related axle ratios is the available AISIN AS69RC six-speed automatic. This fully electronically controlled transmission makes the grade with robust internals, a more aggressive Tow/Haul Mode, and a compact gear train. AISIN PTO capability has been increased to 250 lb-ft of torque and 45 horsepower, with new split-shaft capability* dedicated to higher-output needs. The convenience of PTO availability on the left* or right sides is yet another Ram specific advantage, offering more options to suit each customer's unique business needs.

*Late availability.

CUMMINS MAX JOB RATING INFORMATION†

		REGULAR CAB 60-INCH CA (4x2 / 4x4) SRW	REGULAR CAB 60-INCH CA (4x2 / 4x4) DRW	REGULAR CAB 84-INCH CA (4x2 / 4x4) DRW	CREW CAB 60-INCH CA (4x2 / 4x4) SRW	CREW CAB 60-INCH CA (4x2 / 4x4) DRW
RAM 3500						
MANUAL TRANSMISSION	MAX GVWR	10,200	13,000	13,000	10,200	13,000
	MAX PAYLOAD	3,626 / 3,383	6,080 / 5,837	5,994 / 5,711	3,186 / 2,867	5,602 / 5,317
	MAX GAWR FRONT	5,500	5,500	5,500	5,500	5,500
	MAX GAWR REAR	6,200	9,350	9,350	6,200	9,350
	MAX TRAILER	19,250 / 18,050	18,900 / 18,650	18,800 / 18,550	18,800 / 17,500	18,450 / 18,150
	MAX GCWR	26,000	26,000	26,000	26,000	26,000
AUTOMATIC TRANS- MISSION	MAX GVWR	10,200	13,000	13,000	10,200	13,000
	MAX PAYLOAD	3,456 / 3,213	5,910 / 5,667	5,824 / 5,541	3,016 / 2,697	5,432 / 5,147
	MAX GAWR FRONT	5,500	5,500	5,500	5,500	5,500
	MAX GAWR REAR	6,200	9,350	9,350	6,200	9,350
	MAX TRAILER	19,100 / 17,850	22,750 / 22,500	22,650 / 22,350	18,650 / 17,350	22,250 / 21,950
	MAX GCWR	26,000	30,000	30,000	26,000	30,000

		REGULAR CAB 60-INCH CA (4x2 / 4x4)	REGULAR CAB 84-INCH CA (4x2 / 4x4)	REGULAR CAB 108-INCH CA (4x2 / 4x4)	REGULAR CAB 120-INCH CA (4x2 / 4x4)	CREW CAB 60-INCH CA (4x2 / 4x4)	CREW CAB 84-INCH CA (4x2 / 4x4)
RAM 4500							
MANUAL TRANSMISSION	MAX GVWR	16,000	16,500	16,500	16,500	16,000	16,500
	MAX PAYLOAD	8,391 / 8,002	8,726 / 8,350	8,741 / 8,230	8,711 / 8,170	7,813 / 7,460	8,173 / 7,869
	MAX GAWR FRONT	7,250	7,250	7,250	7,250	7,250	7,250
	MAX GAWR REAR	12,000	12,000	12,000	12,000	12,000	12,000
	MAX GCWR	28,000	28,000	28,000	28,000	28,000	28,000
	MAX TRAILER	20,200 / 19,850	20,050 / 19,700	20,050 / 19,550	20,050 / 19,500	19,650 / 19,300	19,500 / 19,200
AUTOMATIC TRANSMISSION	MAX GVWR	16,000	16,500	16,500	16,500	16,000	16,500
	MAX PAYLOAD	8,326 / 7,937	8,661 / 8,285	8,571 / 8,060	8,541 / 8,000	7,748 / 7,395	8,108 / 7,804
	MAX GAWR FRONT	7,250	7,250	7,250	7,250	7,250	7,250
	MAX GAWR REAR	12,000	12,000	12,000	12,000	12,000	12,000
	MAX GCWR	32,500	32,500	32,500	32,500	32,500	32,500
	MAX TRAILER	24,650 / 24,250	24,500 / 24,100	24,450 / 23,900	24,350 / 23,850	24,050 / 23,700	23,950 / 23,650
RAM 5500							
MANUAL TRANSMISSION	MAX GVWR	18,750	19,500	19,500	19,500	18,750	19,500
	MAX PAYLOAD	11,087 / 10,743	11,711 / 11,361	11,539 / 11,217	11,487 / 11,139	10,580 / 10,227	11,137 / 10,807
	MAX GAWR FRONT	7,250	7,250	7,250	7,250	7,250	7,250
	MAX GAWR REAR	13,500	13,500	13,500	13,500	13,500	13,500
	MAX GCWR	28,000	28,000	28,000	28,000	28,000	28,000
	MAX TRAILER	20,150 / 19,800	20,050 / 19,700	19,850 / 19,550	19,800 / 19,450	19,650 / 19,300	19,450 / 19,150
AUTOMATIC TRANSMISSION	MAX GVWR	18,750	19,500	19,500	19,500	18,750	19,500
	MAX PAYLOAD	11,022 / 10,678	11,646 / 11,296	11,369 / 11,047	11,317 / 10,969	10,515 / 10,162	11,072 / 10,742
	MAX GAWR FRONT	7,250	7,250	7,250	7,250	7,250	7,250
	MAX GAWR REAR	13,500	13,500	13,500	13,500	13,500	13,500
	MAX GCWR	37,500	37,500	37,500	37,500	37,500	37,500
	MAX TRAILER	29,600 / 29,250	29,450 / 29,100	29,200 / 28,850	29,150 / 28,800	29,100 / 28,750	28,900 / 28,550

†Maximum job rating numbers are for a properly equipped vehicle with a 150-lb allowance for the driver. Additional upfits, options, equipment, passengers and cargo weight must be subtracted from tow/payload weight. Please see your dealer for additional information. SRW = Single Rear Wheel. DRW = Dual Rear Wheel. CA = Cab to Axle. Weights given in lb.

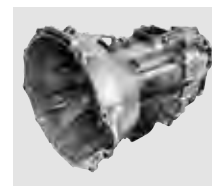

The available class-exclusive^[1] G56 six-speed manual transmission allows the driver the ultimate in vehicle control, and is now modified to handle increased torque loads (was 610 lb-ft, now 650). Its hard-finished gear system aims at exceptional noise, vibration, and harshness (NVH) reductions, with PTO-friendly access on two sides.* The available AISIN six-speed automatic transmission — mated to the new available Cummins High Output — is detailed at left.



Transfer cases are robust and quiet. New 2013 Ram Chassis Cabs offer BorgWarner transfer cases with a larger bolt-flange interface and larger input shaft. The BorgWarner BW 44-46 (electronic shift-on-the-fly) or BW 44-47 (manually actuated) cases have long proven themselves for outstanding on-the-job capability and decades-long durability.



Ram 3500 Crew Cab Laramie with available side steps and aftermarket Rancher Body upfit shown in Bright White. Properly secure all cargo.

The iconic hemispherical combustion chamber is ideal for heavy-duty applications, easily handling those high compression ratios with no fatigue. Further HEMI® V8 assets:

- + **Interactive Deceleration Fuel Shut-Off (iDFSO)**, to seamlessly cease fuel flow during deceleration for real-world fuel efficiency.
- + **A sophisticated electronic throttle control system**, to deliver exact amounts of fuel for premium performance.
- + **Variable Valve Timing (VVT)**, which perfects engine breathing and increases torque over a large rpm range.
- + **Dual spark plugs** — two per cylinder — help increase peak power and torque, reduce exhaust emissions, increase fuel efficiency, and smooth the idle.
- + **An ultra-high compression ratio of 10.5:1**, along with dual knock sensors, translates into outstanding performance and fuel efficiency.

CONFIGURATION: 90-degree V8, liquid-cooled

DISPLACEMENT: 345 cu in (5654 cu cm)

OUTPUT: 383 hp / 400 lb-ft of torque

BORE / STROKE: 3.92 x 3.58 in (99.5 x 90.0 mm)

BLOCK MATERIAL: Deep-skirt cast iron, with cross-bolted main bearing caps

CYLINDER HEAD: Aluminum alloy; hemispherical combustion chambers

OIL CAPACITY: 7 quarts with filter

COOLANT CAPACITY: 18 quarts

VALVETRAIN: VVT; 16 pushrod-operated overhead valves (two per cylinder); hydraulic lifters with roller finger followers

FUEL DELIVERY: Sequential, multi-port injection, electronic, returnless

RECOMMENDED FUEL: Unleaded mid-grade (89 octane) recommended; unleaded regular (87 octane) acceptable

COMPRESSION RATIO: 10.5:1

ALTERNATORS: 160-amp standard, 180-amp available

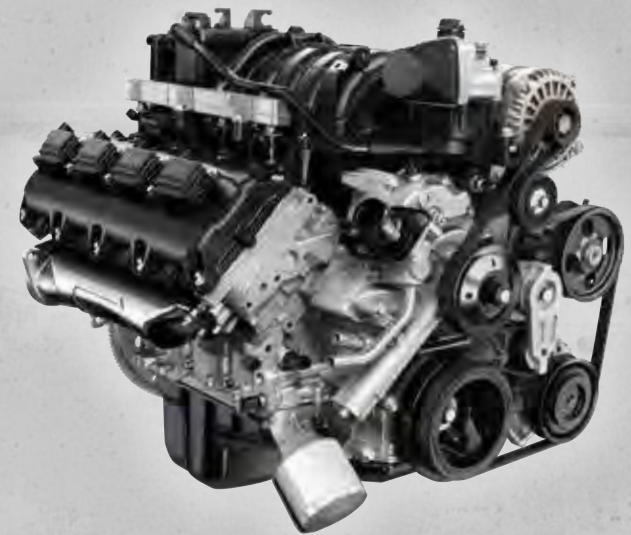

5 YEAR / 100,000 MILE
POWERTRAIN LIMITED WARRANTY^[4]

Ram is in your corner, giving you an unsurpassed^[1] 5-Year/100,000-Mile Powertrain Limited Warranty.^[4]

GAS V8 OF CHOICE.

RAM 3500: BEST-IN-CLASS^(B) STANDARD HORSEPOWER AND TORQUE, WITH VVT AND iDFO FUEL-SAVING ENGINEERING. THAT'S THE LEGENDARY HEMI[®] V8.

The history of the hemispherical head is extraordinary. It propelled WWII Thunderbolt airplanes and now-collectible muscle cars. And any engineering résumé with such impeccable credentials is a natural for the toughest jobs — exactly why it's the standard powerplant for Ram 3500 Chassis Cabs, delivering best-in-class^(B) standard horsepower and torque to accomplish the toughest jobs with ease. The principal dynamics of the 5.7-liter HEMI V8 are custom-designed for industry:

- Exceptional power and torque, managed by a sophisticated electronic throttle control system.
- Incorporation of VVT, to precisely manage opening and closing of valves for optimum performance, and which improves torque over a wide rpm range.
- Utilization of iDFO — interactive Deceleration Fuel Shut-Off — which seamlessly ceases fuel flow for real-world fuel efficiency, and with no noticeable change in performance.
- Engineering that includes a dual-ignition system; two spark plugs per cylinder increase power and torque, reduce emissions, and help increase fuel efficiency.
- Improved and reduced noise, vibration, and harshness (NVH), from a specifically tuned crankshaft damper and redesigned, damperless valve springs.

Proven transmission and transfer case choices expand HEMI V8 capability; all components utilize technologies and engineering protocols created specifically for heavy-duty use and long-term durability. Furthermore, ongoing improvements to the HEMI V8 for better performance and increased fuel efficiency are bold in their aim: excel in every aspect of the job. To that end, the HEMI V8 powertrains put pure capability to work.

The proven partner of the Ram Chassis Cab HEMI V8 is the sophisticated 66RFE six-speed automatic transmission, a component designed to exceed typical demands for anticipated towing and hauling. The transmission offers driver-adaptive shifting, with three multiple clutch packs and a dual-stage hydraulic pump; all contribute to superb road manners and impressive hauling dynamics. The addition of dual filters helps protect the pump and other components, with an independent lubrication/cooler ensuring ample pressure under all conditions.

HEMI MAX JOB RATING INFORMATION*

		REGULAR CAB 60-INCH CA (4x2 / 4x4) DRW	REGULAR CAB 84-INCH CA (4x2 / 4x4) DRW	CREW CAB 60-INCH CA (4x2 / 4x4) DRW
RAM 3500				
AUTOMATIC TRANSMISSION	MAX GVWR	12,500	12,500	12,500
	MAX PAYLOAD	6,543 / 6,286	6,489 / 6,212	6,119 / 5,833
	MAX GAWR FRONT	5,200	5,200	5,200
	MAX GAWR REAR	9,350	9,350	9,350
	MAX TRAILER	11,850 / 10,650	11,800 / 10,400	11,450 / 10,200
	MAX GCWR	18,000	18,000	18,000

*Maximum job rating numbers are for a properly equipped vehicle with a 150-lb allowance for the driver. Additional upfits, options, equipment, passengers, and cargo weight must be subtracted from tow/payload weight. Please see your dealer for additional information. DRW = Dual Rear Wheel. CA = Cab to Axle. Weights given in lb.

TRANSFER CASE CONFIGURATIONS OFFER COMPLETE CAPABILITY.

The transfer cases mated to the 5.7-liter HEMI V8 are the same as those utilized by the Cummins[®] Turbo Diesel — applications that prove unquestionable strength. The BorgWarner BW 44-46 transfer case features responsive electronic shift-on-the-fly engineering with three operating ranges, plus Neutral. The manually actuated BW 44-47 component features three operating ranges, plus Neutral. Both transfer cases offer a low range reduction ratio of 2.64:1.



ENGINEERED FOR STRENGTH. DESIGNED FOR VERSATILITY.



It's all about strength for the job. One-piece, 50k p.s.i. stamped C-channel rear frame rails start the story — because everywhere you look, these are leadership levels of capability backed with an upfitter-friendly design that offers superb versatility. Ram delivers wide, clean, flat frame rails spaced at the 34-inch standard; all components under the frame rails; fuel and DEF ports independent of the cab and at the same location; modified front and rear suspensions for enhanced quality and upfit ease; and outstanding rear frame strength, with modified frame, steering and mounting systems. No matter how you upfit your Ram Chassis Cab, count on a design that's adaptable and flexible — with proven strength.

PURPOSE-DRIVEN INNOVATION.

The new 2013 Ram Chassis Cabs are where the best comes together. Here's where you'll find frame strength and component toughness that exceed the competition — and, in many instances, simply excel with best-in-class honors. Inside, impressive refinements cover every aspect of comfort and convenience, and — with the all-new available 7-inch full-color Multi-View Cluster — offer brilliant and informative visuals. Communication reaches new highs, with sophisticated Uconnect® radios and systems delivering available

voice-activated¹⁶¹ technology and easy navigation capabilities. The thinking here is consistently pragmatic: use every aspect of innovation, ingenuity, experience, and expertise to create super-qualified workhorses that back down from nothing. The results are bottom-line specific, top-of-the-line in quality, and from the user's standpoint, indispensable for business. From improved headlamps to the vibrant new instrument clusters to new Sapphire Blue ambient interior lighting, this is innovation with purpose.

+ **WIPER BLADES ARE NOW PARKED BELOW THE HOOD LINE, AND THE RAISED LIP ON THE FRONT COWL SCREEN** SMOOTHS AIRFLOW TRANSITION FROM HOOD TO WINDSHIELD. BOTH HELP REDUCE AERODYNAMIC DRAG AND LESSEN WIND NOISE.

+ **REVISED SIDE-WINDOW OFFSETS** FROM THE DOOR FRAMES CONTRIBUTE TO A QUIETER INTERIOR BY REDUCING TURBULENCE-INDUCED WIND NOISE.



+ **NEW, BEST-IN-CLASS¹¹¹ MAX GCWRs (GROSS COMBINED WEIGHT RATINGS) AND BEST-IN-CLASS¹¹¹ TOWING**

MODEL	GCWR	TOWING
3500	30,000 lb	22,750 lb
4500	32,500 lb	24,650 lb
5500	37,500 lb	29,600 lb

+ **A 270-DEGREE DOOR-SEAM HEMMING PROCESS** WAS INCORPORATED FOR ALL DOORS. 2013 RAM CHASSIS CABS ALSO UTILIZE A NEW PROCESS TO JOIN INNER AND OUTER PANELS. THE EFFECT: EXCEPTIONAL APPEARANCE, WITH SMARTLY IMPROVED CORROSION RESISTANCE IN THOSE AREAS.

+ **THIS IS ENGINEERING ACCOMPLISHED FROM THE UPFITTER'S POINT OF VIEW:** A FLAT, CLEAN FRAME WITH ALL COMPONENTS AND WIRING BELOW THE FRAME, WITH CRAFTED, PLANNED HOLES TO REDUCE (AND FREQUENTLY ELIMINATE) THE NEED FOR WELDING.



+ **THE NEW FRONT END TREATMENTS** ARE NOW MODEL-SPECIFIC, DISTINGUISHING THEMSELVES THROUGH BOTH STYLE AND FUNCTION. FOR 2013, EACH TRIM LEVEL HAS A DISTINCTIVE GRILLE.



+ **THE HUGE 7 x 11-INCH TRAILER TOW MIRRORS** OFFER MULTIPLE-PERSPECTIVE REAR VIEWS, WITH A SCULPTED AERODYNAMIC DESIGN THAT HELPS IMPROVE FUEL EFFICIENCY.

DUAL-FUNCTION CAPABILITY IS BY DESIGN: WHEN VERTICAL, THEY'RE IDEAL FOR TOWING. FOR EVERYDAY DRIVING CONVENIENCE, FLIP THEM TO HORIZONTAL.

+ **THE NEW, NEXT-GENERATION DEF (UREA) SYSTEM HAS ALL COMPONENTS TUCKED UNDER THE CAB, OUT OF UPFITTER ZONES.** THE SYSTEM IS IN FULL COMPLIANCE WITH STRINGENT NEW 2013 FEDERAL MANDATES, AND IS DESIGNED TO REDUCE UPFIT COSTS AND SAVE THE CUSTOMER MONEY. (ON CUMMINS® EQUIPPED RAM MODELS ONLY.)

+ **ALL EXPOSED BODY PANELS ARE GALVANIZED,** WITH SIDE APERTURES AND STAMPED INNER HOLES RECEIVING A SPECIAL E-COATING PROCESS FOR ADDITIONAL PROTECTION. THE REDESIGN OF RAM CHASSIS CABS TOOK ON CRITICALLY IMPORTANT GOALS. AMONG THEM: PROVIDE YOUR WORK TRUCK WITH UNCOMPROMISING CORROSION PROTECTION.



RUNS RINGS AROUND THE CONVENTIONAL.

Put any typical expectations of a Chassis Cab interior on the back burner. These new Rams leave convention far behind.

Technology in these new interiors encompasses it all: bold available new six-ring instrument cluster designs with vibrant full-color displays for select models. Smartphone-like roller menus with telltales that give you real-time information about dozens of performance functions. More Uconnect® choices and assets than ever. It's all finished off by brilliant new touches of Sapphire Blue interior lighting.



NEW INTEGRATED SWITCH BANK: WE HIT IT ON THE BUTTON. Control new Ram Chassis Cab with fingertip ease: the new switch bank is instrument panel-mounted. Controls for standard features include the new Electronic Stability Control (ESC)⁽³⁾ system, Tow/Haul Mode, and, if equipped, heated/ventilated seats and the heated steering wheel. Five auxiliary switches for PTO and upfits are also included.

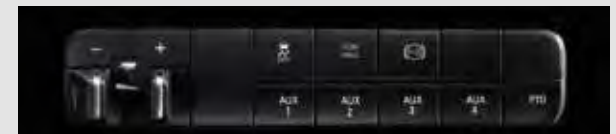

ALL NEW: MENUS, MEDIA HUBS, 3-D, EVEN THE ARCHITECTURE.

The new 2013 Ram Chassis Cabs now feature PowerNet — electrical architecture based on a high- and low-speed telematic system. Advantages here are manifold: count on a new available upfitter electrical interface module with 53 inputs/outputs; a new central media hub; new instrument clusters; new available LED illumination; new available 3-D premium navigation; more available SiriusXM Satellite Radio⁽⁷⁾ options than ever. Screen functionality reaches new heights, with displays for mechanical functions, weather, radio selections... and much more.



RAM. AT THE TOP.

LEADING THE NEW RAM FAMILY ARE THE 4500/5500 CHASSIS CABS:
PHENOMENAL CAPABILITY EVERYWHERE YOU LOOK.

Few things come together as perfectly as the Ram 4500/5500 Chassis Cab models — and given the stunning list of improvements and refinements, few competitive vehicles will even come close.

It's all about providing an ideal worker for the job — and the numbers that back new Ram 4500/5500 are compelling. With the available MAX Tow Package, GCWRs rise to best-in-class^[2] levels: 32,500 lb* on Ram 4500 models, and up to an incredible 37,500 lb* for mighty Ram 5500. When it comes to the upfit of your choice, these workhorses are hungry to ride. Rear frame strength is exceptional, achieving a best-in-class^[2] 50k p.s.i. benchmark. An all-new integrated instrument panel-mounted switch bank controls the new class-exclusive^[2] Electronic Stability Control (ESC)^[3] system and critical Tow/Haul Mode. Add available assets like the dual 220-amp alternators¹ providing best-in-class^[2] power output, and the enhanced PTO capability from the tough AISIN[®] six-speed automatic, and you're good to go.

*When properly equipped.



OUTSTANDING BRAKES. AND THEY'RE THE LARGEST-IN-CLASS.^[2]

Those standard and huge optional wheels for Ram 4500/5500 work with brake rotors that measure up: largest-in-class^[2] they're an authoritative 15.4 inches in diameter, and work with twin-piston calipers and a hydro-boost power assist system; it all adds up to confident control. As well, every Cummins engine now employs the new standard “smart” diesel exhaust brake to aid in deceleration and stopping. Ram delivers robust capability right where you need it.

Wheels for new Ram 4500/5500 round out the story, with impressive standard and optional designs for the 19.5-inch wheels.

ENGINE

6.7L CUMMINS [®] TURBO DIESEL	
Configuration	6-cylinder in-line design
Horsepower	320 @ 2,800 rpm, 325 @ 2,400 rpm (H.O.)
Torque (lb-ft)	650 @ 1,400-2,700 rpm, / 750 @ 1,500-2,100 rpm (H.O.)
Displacement (cu in)	409
Bore (in)	4.21
Stroke (in)	4.88
Compression ratio	17.3 to 1
Number of valves	24
Intake system	Turbocharged (VGT) with intercooler
Fuel system	Common Rail Injection
Emissions	Federally compliant
Oil change intervals (under normal operation)	15,000 miles / 12,000 miles (B20)
Exhaust brake	Standard

DRIVELINE

	Model	
	G-56	AISIN AS69RC
Transmissions	6-speed manual	6-speed automatic
Type	Left-side ¹	Right-side
PTO access	Left-side ¹	Right-side
Gear ratios	1st	5.94 to 1
	2nd	3.28 to 1
	3rd	1.98 to 1
	4th	1.31 to 1
	5th	1.00 to 1
	6th	.74 to 1
	Rev.	5.42 to 1
Standard axle ratios (4500 / 5500)	4.10 / 4.10	4.10 / 4.10
Available axle ratios (4500 / 5500)	4.44 / 4.44	4.44 / 4.44, 4.88
Antisip differential	Standard	Standard

¹Late availability.

TRANSFER CASES

Model	2-speed manual shift BW 44-47 part-time (standard)	2-speed electronic shift-on-the-fly BW 44-46 part-time (available)
Gear ratios	High	1 to 1
	Low	2.64 to 1

BRAKES

Type	Four-wheel hydraulic ABS system with front and rear discs
Rotors	15.4 x 1.5-inch
Calipers	Twin piston
Booster	Hydroboost (Cummins)
Parking brake	Drum-in-hat

LIQUID CAPACITIES¹

Cooling system	29.5 quarts
Transfer case	4 pints
Front axle	172 ounces
Rear axle	238 ounces
Transmission fluid (service fill)	12 pints (G-56), 7.2 quarts (AISIN)
Standard fuel tank	52-gallon rear mounted
Optional fuel tank	22-gallon mid-ship mounted

¹Normal refill capacities are shown. A variation may be observed from vehicle to vehicle due to manufacturing tolerances and refill procedures.

STEERING

Type	Recirculating ball (power)
Maximum wheel cut	Approximately 45 degrees

FRAME

Ladder type	C-channel
Width	34 inches
Yield strength	50k p.s.i.
Thickness	7.7 mm

ELECTRICAL

Batteries	Two, 730-amp
Alternator	180-amp std (220-amp and 440-amp ¹ available)
Standard trailer wiring harness	Seven-pin
Additional feeds to rear of chassis	Five
Power distribution center	Underhood (two fused 25-amp feeds; one fused relay-controlled 20-amp)
Upfitter connector jumper	Standard

WHEELS/TIRES

Wheels	19.5 x 6-inch steel wheel with Argent finish; standard 19.5 x 7-inch forged aluminum wheel; optional
Tires	225/70R19.5F BSW (steering and traction treads are available)



19.5-inch steel wheel with Argent finish
Standard on 4500/5500
Tradesman and SLT
(WP3)



19.5-inch forged aluminum wheel
Standard on 4500/5500 Laramie, Optional
on 4500/5500 Tradesman and SLT
(WP4)



Ram 5500 Regular Cab SLT with optional wheels and aftermarket Tow Truck upfit shown in Bright White. Properly secure all cargo.

UP FOR IT ALL.

NEW RAM 3500 CHASSIS CAB. ACHIEVING NEW HEIGHTS IN PERFORMANCE AND UPFITTER-FRIENDLY ENGINEERING.

When tough industrial needs are completely met by the 3500 weight class, new 2013 Ram 3500 Chassis Cab comes to work at the peak of its development. With versatile, upfitter-friendly design and phenomenal engine and frame strength, Ram 3500 Chassis Cab — with its best-in-class⁽³⁾ GCWR — jumps into first-place consideration for the job.

New developments for 2013 Ram 3500 Chassis Cab include new PowerNet electrical architecture, with an available all-new upfitter electrical interface module embracing upfit needs with 53 inputs/outputs. Add revised steering, new interiors, a sharp new exterior, more than 30 available active and passive safety and security systems — including the comprehensive Electronic Stability Control (ESC)⁽³⁾ system now standard on every model — and you've got every resource you need to get the job done right.



Properly secure all cargo.

ENGINE

5.7L GAS V8 (STANDARD)

Configuration	8-cylinder V-design
Horsepower	383 @ 5,600 rpm
Torque (lb-ft)	400 @ 4,000 rpm
Displacement (cu in)	345
Bore (in)	3.92
Stroke (in)	3.58
Compression ratio	10.5 to 1
Number of valves	16
Intake system	Naturally aspirated
Fuel system	Electronic Fuel Injection
Emissions	Federally compliant
Oil change intervals (under normal operation)	6,000 miles
Exhaust brake	Not available

ENGINE

6.7L CUMMINS® TURBO DIESEL (AVAILABLE)

Configuration	6-cylinder in-line design
Horsepower	320 @ 2,800 rpm, 325 @ 2,400 rpm (H.O.)
Torque (lb-ft)	650 @ 1,400-2,100 rpm 750 @ 1,500-2,100 rpm (H.O.)
Displacement (cu in)	409
Bore (in)	4.21
Stroke (in)	4.88
Compression ratio	17.3 to 1
Number of valves	24
Intake system	Turbocharged (VGT) with intercooler
Fuel system	Common Rail Injection
Emissions	Federally compliant
Oil change intervals (under normal operation)	15,000 miles, 12,000 miles for B20
Exhaust brake	Standard

DRIVELINE

Transmissions	Model		
	G-56	AISIN® AS69RC	66RFE
Type	6-speed manual (Cummins only)	6-speed automatic (Cummins only)	6-speed automatic (gas V8 only)
Clutch diameter	12.5 inches	—	—
PTO access	Left-side*	Right-side	—
Gear ratios	1st	5.94 to 1	3.74 to 1
	2nd	3.28 to 1	2.00 to 1
	3rd	1.98 to 1	1.34 to 1
	4th	1.31 to 1	1.00 to 1
	5th	1.00 to 1	.77 to 1
	6th	.74 to 1	.63 to 1
	Rev.	5.42 to 1	3.54 to 1
Standard axle ratio	3.42	3.42	4.10
Available axle ratios	3.73 / 4.10	3.73 / 4.10	N/A
Antispin differential	Standard	Standard	Standard

TRANSFER CASES

Model	2-speed manual shift BW 44-47 part-time (standard)	2-speed electronic shift-on-the-fly BW 44-46 part-time (available)
Gear ratios	High	1 to 1
	Low	2.64 to 1

FRAME

Ladder type	C-channel
Width	34 inches
Yield strength	50k p.s.i.
Thickness	5.7 mm

*Late availability.

BRAKES

Type	Four-wheel hydraulic ABS system with front and rear discs
Rotors (front / rear)	14.17 x 1.54-inch / 14.09 x 1.34-inch
Calipers	Twin piston
Booster	Vacuum-assisted (gas V8) Hydroboost (Cummins)
Parking brake	Drum-in-hat

STEERING

Type	Recirculating ball (power)
Maximum wheel cut	Approximately 38 degrees

ELECTRICAL

Batteries	730-amp (standard with 5.7L gas V8)
	730-amp (two standard with diesel)
Alternators	160-amp std, 180-amp available (gas)
	180-amp std, 220-amp and 440-amp* available (diesel)
Standard trailer wiring harness	Seven-pin
Additional feeds to rear of chassis	Five
Power distribution center	Underhood (two fused 25-amp feeds; one fused relay-controlled 20-amp)
Upfitter connector jumper	Standard

WHEELS/TIRES

Wheels	17 x 6-inch steel (DRW) / 17 x 7.5-inch steel (SRW)
Tires	LT235/80R17E All-Season; standard (DRW)
	LT235/80R17E On-/Off-road; optional (DRW)
	LT265/70R17E All-Season; standard (SRW)



17-inch Argent steel wheel
Std on 3500 Tradesman SRW models (WD2)



17-inch chrome-clad steel wheel
Std on 3500 SLT; Opt on 3500 Tradesman SRW models (WGS)



17-inch polished aluminum wheel
Std on 3500 Laramie SRW models (WFK)



17-inch Argent steel wheel
Std on 3500 Tradesman DRW models (WFU)



17-inch chrome wheel skins
Std on 3500 SLT; Opt on 3500 Tradesman DRW models (WD4)



17-inch polished aluminum wheel
Std on 3500 Laramie; Opt on 3500 SLT DRW models (WF7)

INTERIOR SEAT FABRICS

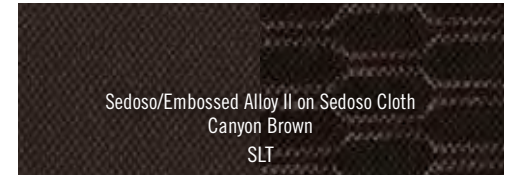
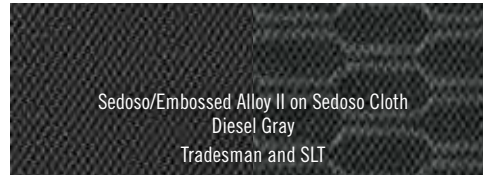

EXTERIOR PAINT COLORS

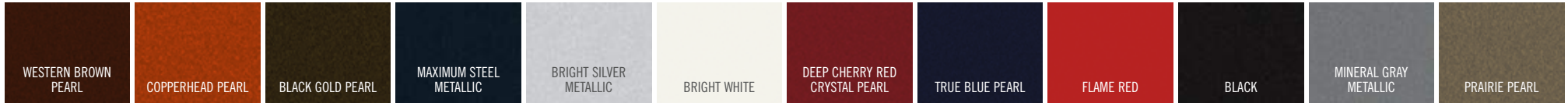

SPECIAL EXTERIOR PAINT COLORS†



†See your dealer for special paint color ordering requirements.

TRIM LEVELS



Ram Tradesman. The 2013 Ram Tradesman Chassis Cabs offer an economical, versatile, and capable answer for all weight class requirements. Come to work in your choice of Regular Cab or Crew Cab spaciousness, in 4x2 and 4x4 drivetrains, with single-rear-wheel (3500) or dual-rear-wheel (3500/4500/5500) configurations providing ample strength for the job at hand.



Ram SLT. Affordability joins an exterior that now offers more chrome and a distinctive grille treatment. Inside, the 2013 Ram SLT Chassis Cabs feature standard cloth seating with carpeted floor covering, a new available six-ring instrument cluster with full-color Multi-View Cluster display, along with a raft of amenities. Ram SLT comes in either Regular Cab or Crew Cab models, in 4x2 and 4x4 drivetrains, in single-rear-wheel (3500) or dual-rear-wheel (3500/4500/5500) configurations.



Ram Laramie. The distinguished Ram Laramie trim level — available for Ram Chassis Cabs in all weight classes in Crew Cab models only — offers the commercial market upscale comfort and outstanding electronics. The interior features top-of-the-line communications with standard heated and ventilated leather-trimmed seating. Choose from 4x2 or 4x4 drivetrains, in single-rear-wheel (3500) or dual-rear-wheel (3500/4500/5500) configurations.

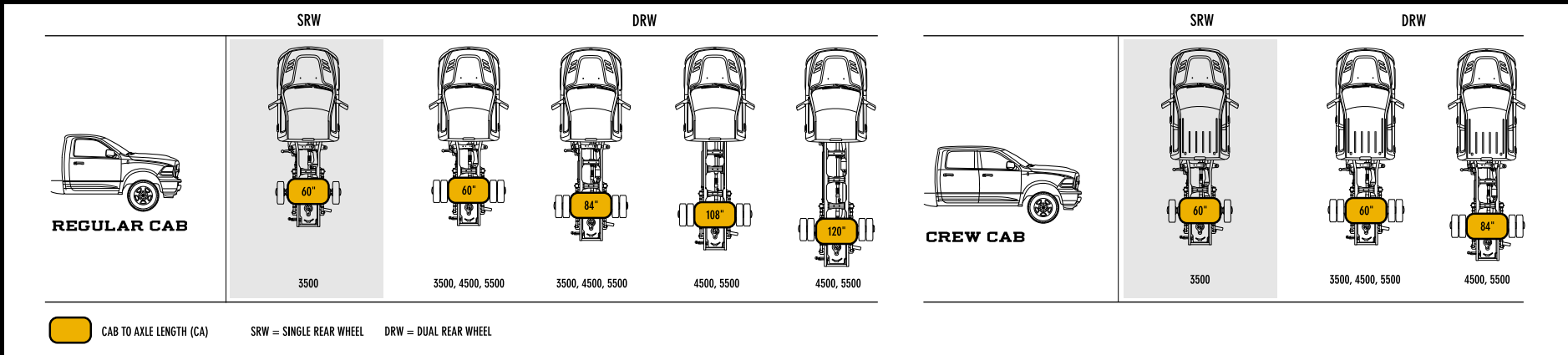

ON THE JOB THE INCENTIVES YOU NEED TO HELP YOUR BUSINESS SUCCEED.

Running a business presents plenty of challenges. Like cutting costs, not corners. The **ON THE JOB*** commercial incentive program provides enormous assistance in purchasing, customizing, and servicing your business vehicles.

See your dealer for specific program rules and details, or call us toll-free at **877-ONTHEJOB (877-668-4356)**.

Among the most popular **ON THE JOB** incentives:

- **NO-EXTRA-CHARGE LUBE/OIL/FILTER** for all Chrysler, Jeep®, Dodge, and Ram Vehicles. Applicable toward Gas and Diesel Engines.
- **COMMERCIAL GRAPHICS ALLOWANCES** \$250/\$500/\$1,000 Commercial Graphics Program Allowances for all Vehicles.
- **COMMERCIAL EQUIPMENT/UPGRADES** \$1,000/\$500 Allowances for Upgrades. \$1,000 Snowplow/Factory Box-Off/Field Box-Off Allowances. \$500 RamBox® Cargo Management System Allowance.



DESTINATION: SUCCESS AND GROWTH. WELCOME TO BUSINESSLINK.

If you're in business, BusinessLink has you covered.

- Free Membership
- Extended Service Hours
- A Dedicated BusinessLink Staff
- Convenient Shuttle Service
- Commercial Vehicles in Stock
- Next-Buy-Up Preferential Service
- Free Loaners¹ for Selected Vehicles
- And much more

For more information, log on to chryslerbusinesslink.com or call us toll-free at **877-2THELINK (877-284-3546)**.

***ON THE JOB** is a retail incentive program; see your dealer for official program rules. Inquire about eligibility by calling 877-ONTHEJOB or by logging on to chryslercommercialvehicles.com. The purchaser or lessee must be a qualified commercial customer for more than 30 days prior to the date of the vehicle purchase. An official **ON THE JOB** Customer Acknowledgement Form must be signed by the customer (provided by the dealer). ¹Some restrictions apply. See dealer for details.



RAM

RAMTRUCKS.COM

[1] Based on Class 3-5 pickup-based conventional cab chassis. When properly equipped. [2] Based on Class 4-5 pickup-based conventional cab chassis. When properly equipped. [3] No system, no matter how sophisticated, can repeal the laws of physics or overcome careless driving actions. Performance is limited by available traction, which snow, ice, and other conditions can affect. When the ESC warning lamp flashes, the driver needs to use less throttle and adapt speed and driving behavior to prevailing road conditions. Always drive carefully, consistent with conditions. Always wear your seat belt. [4] Transferable. See dealer for complete details and a copy of the 5-Year/100,000-Mile Powertrain Limited Warranty. [5] Always look before proceeding, electronic drive aid is not a substitute for conscientious driving, always be aware of your surroundings. [6] Requires Uconnect Phone. [7] SiriusXM services require subscriptions, sold separately after the 12-month trial included with the new vehicle purchase. **If you decide to continue your service at the end of your trial subscription, the plan you choose will automatically renew and bill at then-current rates until you call SiriusXM at 1-866-635-2349 to cancel. See SiriusXM Customer Agreement for complete terms at www.siriusxm.com.** All fees and programming subject to change. Our satellite service is available only to those at least 18 and older in the 48 contiguous USA and D.C. Our Sirius satellite service is also available in PR (with coverage limitations). Our Internet radio service is available throughout our satellite service area and in AK and HI. © 2013 Sirius XM Radio Inc. Sirius, XM and all related marks and logos are trademarks of Sirius XM Radio Inc. [8] Based on Class 3 pickup-based conventional cab chassis, over 10,000 lb GVWR. When properly equipped.

About this catalog: Since the time of printing, some of the information you'll find in this catalog may have been updated. Ask your dealer for details. Some of the equipment shown or described throughout this catalog may be available at extra cost. Specifications, descriptions, illustrative materials, and all competitive comparisons contained herein are as accurate as known at the time this publication was approved for printing. Chrysler Group LLC reserves the right to discontinue models at any time or change specifications without notice or without incurring obligation. Options may be required in combination with other options. For the price of the model with the equipment you desire, or verification of specifications contained here, see your Ram dealer. AISIN is a registered trademark of Aisin Seiki Co., Ltd. Cummins is a registered trademark of Cummins, Inc. Sirius, XM and all related marks and logos are trademarks of Sirius XM Radio Inc. Chrysler, Dodge, Jeep, Ram, the Ram's Head logo, HEMI, Laramie, ParkView, RamBox, Tradesman, and Uconnect are registered trademarks of Chrysler Group LLC. © 2013 Chrysler Group LLC. All rights reserved.

Ram is a registered trademark of Chrysler Group LLC.