

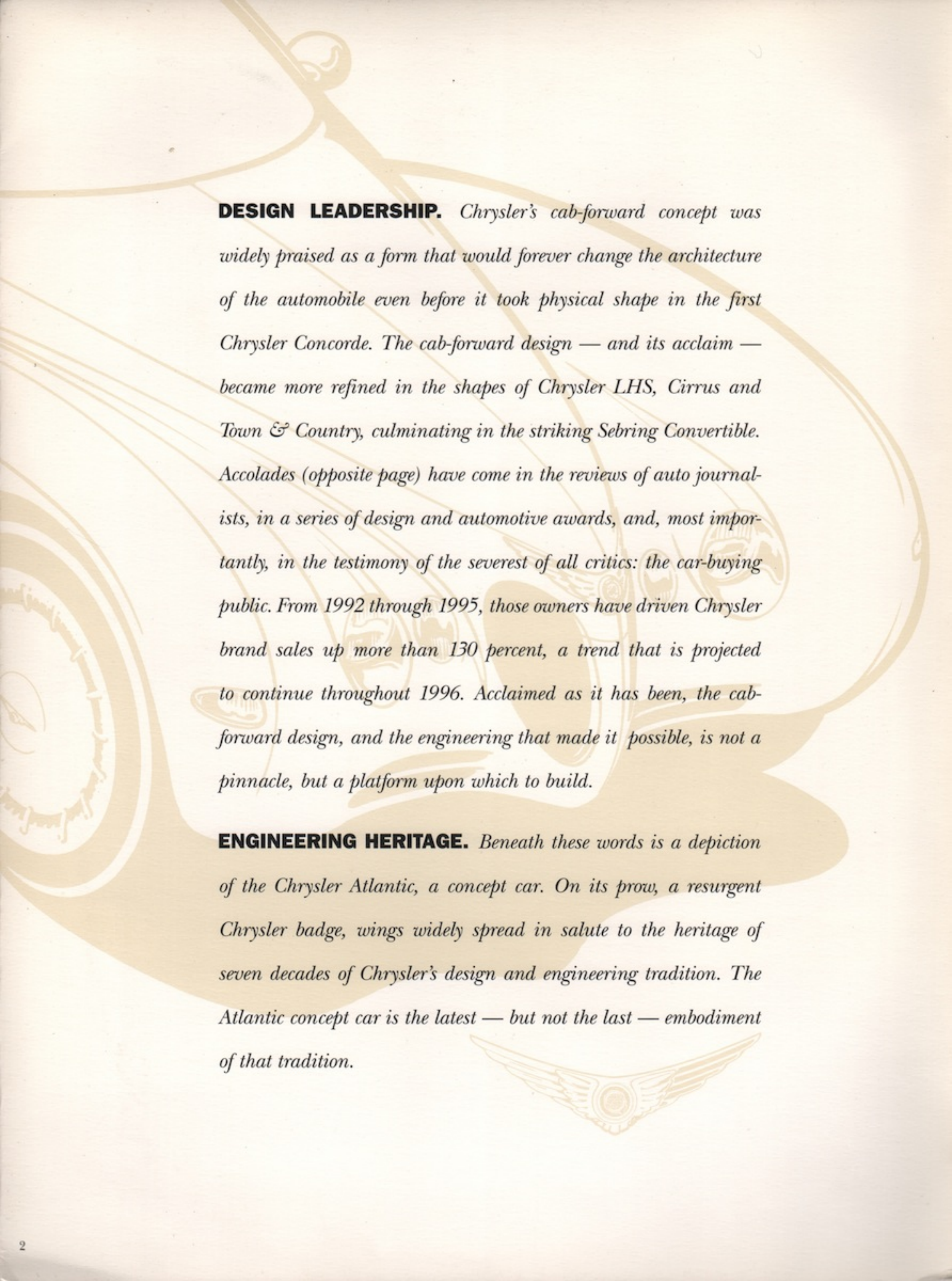



**1997 CHRYSLER SEBRING COUPE • SEBRING CONVERTIBLE**



**DESIGN LEADERSHIP.** *Chrysler's cab-forward concept was widely praised as a form that would forever change the architecture of the automobile even before it took physical shape in the first Chrysler Concorde. The cab-forward design — and its acclaim — became more refined in the shapes of Chrysler LHS, Cirrus and Town & Country, culminating in the striking Sebring Convertible. Accolades (opposite page) have come in the reviews of auto journalists, in a series of design and automotive awards, and, most importantly, in the testimony of the severest of all critics: the car-buying public. From 1992 through 1995, those owners have driven Chrysler brand sales up more than 130 percent, a trend that is projected to continue throughout 1996. Acclaimed as it has been, the cab-forward design, and the engineering that made it possible, is not a pinnacle, but a platform upon which to build.*

**ENGINEERING HERITAGE.** *Beneath these words is a depiction of the Chrysler Atlantic, a concept car. On its prow, a resurgent Chrysler badge, wings widely spread in salute to the heritage of seven decades of Chrysler's design and engineering tradition. The Atlantic concept car is the latest — but not the last — embodiment of that tradition.*



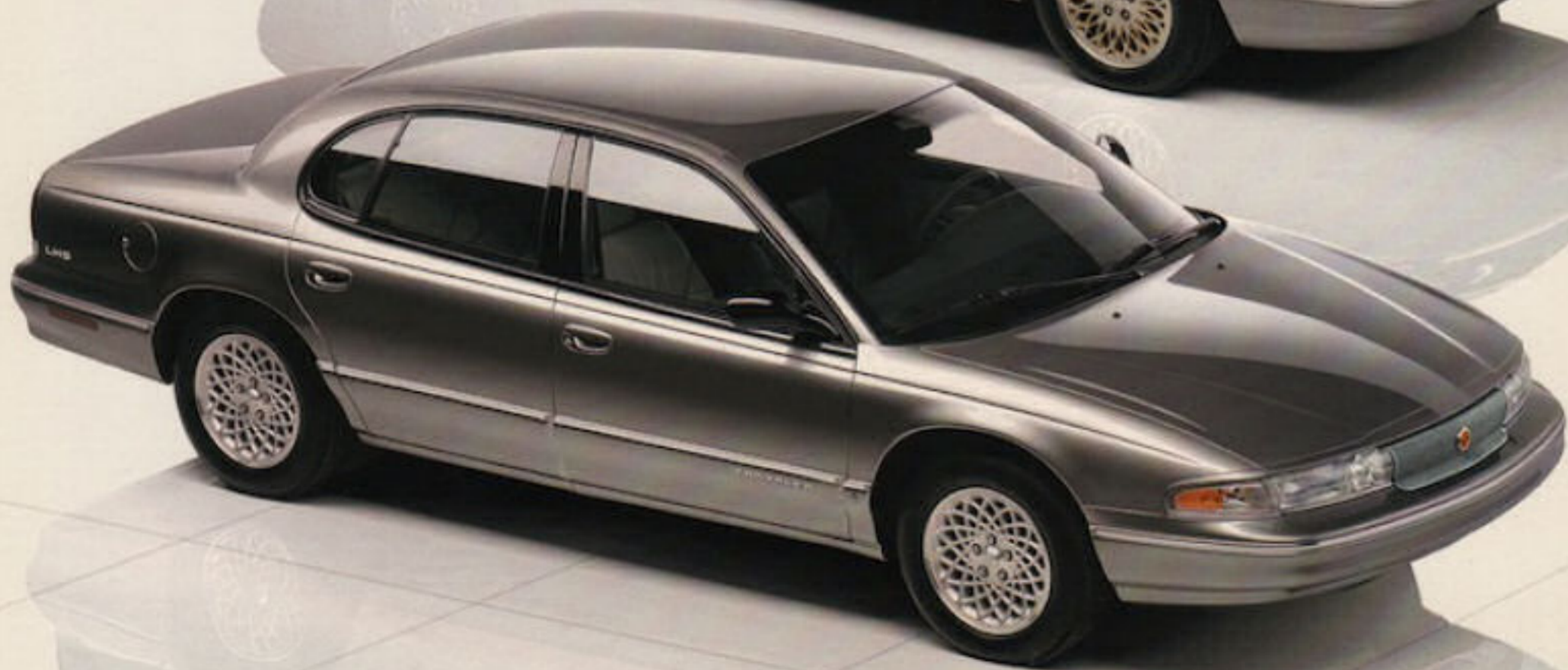

In addition to stunning style, Chrysler measures up as no other contemporary car company:

**A NEW FAMILY** Engineering. Roadability. Quality.

**FROM CHRYSLER** Value-retention. And Safety. Those are the criteria applied to shrewd new car purchases. Compare domestic or import.

Chrysler dared to redefine the very architecture of the automobile — with cab forward and wheels-toward-the-corners original thinking that created spacious interior volume, greater agility on the road, and lent additional grace to many of the most seductive automotive



shapes ever stamped in steel. No other luxury car maker can match this determination to excel, this excellence of design, nor the sheer celebrated pedigree of this Chrysler collection of fine automobiles. Welcome.



What's new in your world?

Clockwise from lower left: Chrysler LHS, Concorde LXi, PT and Country LXi, Sebring LXi, Cirrus LXi, Sebring JXi Convertible.

Since the time of printing, some of the information you'll find in this catalog may have been updated. Ask your dealer for details. Some of the equipment shown or described throughout this catalog is available at extra cost.

## **Acknowledgements**

### **IDEA Awards for Excellence 1995**

*(Industrial Design Society of America)*

Chrysler Atlantic  
Gold, Concept Cars

Chrysler Town & Country  
Gold, Production Vehicle

### **Car and Driver • Ten Best**

*Chrysler Cirrus 1996/1995*

*Chrysler Town & Country 1996*      *Chrysler Concorde 1994/1993*

### **Motor Trend • Car of the Year**

*Chrysler Cirrus 1995*      *Chrysler Concorde 1993*

### **North American Car of the Year**

*(North American Car and Truck Jury)*

*Chrysler Town & Country 1996*      *Chrysler Cirrus 1995*

### **Highest Resale Value in Class\***

*Chrysler Concorde*

### **Automobile Magazine • Automobile of the Year**

*Chrysler Concorde 1993*

### **Popular Science • Best of What's New**

*Chrysler Town & Country 1996*      *Chrysler Cirrus 1995*

### **Home Mechanix • Best Value**

*Chrysler Town & Country 1996*      *Chrysler Cirrus 1996/1995*

### **Business Week • Best New Products**

*Chrysler Cirrus 1995*      *Chrysler Concorde 1993*

### **Popular Mechanics • Design & Engineering**

*Chrysler Town & Country 1996*      *Chrysler Cirrus 1995*

### **Motorweek • Driver's Choice Award**

*Chrysler Town & Country 1996*      *Chrysler Concorde 1994*

### **STRATEGIC VISION 1996 Vehicle Experience Study™**

*1996 Total Quality Award™ for "Best Ownership Experience" in minivans'*

*Chrysler Town & Country*



## CONTENTS

Introduction . . . . .	2
The Chrysler family of fine automobiles . . . . .	3
Chrysler Sebring Convertible . . . . .	8
Cab-forward architecture . . . . .	12
Interior appointments . .	14
Fashionable features . . .	20
Sound systems/ body structure . . . . .	22
Instrumentation . . . . .	24
Engines, suspension, safety . . . . .	26
Radios, wheels, accessories . . . . .	28
Specifications, colors . . .	30
Chrysler Quality . . . . .	32
Chrysler Heritage . . . . .	34
Chrysler Sebring Coupe . . .	36
Instrumentation . . . . .	40
Engines, suspension . . .	42
Interior appointments . .	44
Structure . . . . .	50
Radios, wheels, accessories . . . . .	52
Specifications, colors . . .	54
Leasing, warranties . . . . .	56
Customer One . . . . .	57

*Sebring JXi Convertible and Sebring Coupe*

**For Jere Birkenfeld,  
cruising is pleasure  
and business. She  
teaches art classes  
aboard luxury ships.**

## SEBRING CONVERTIBLE



### **"It saw me and said ... 'Take me home.'"**

*Jere Birkenfeld did as she was told. And she's been cruising the sun-splashed coastal roads around her Titusville, Florida, home since the very day she picked up her shining black, leather-trimmed Sebring Convertible. What day was that? February 14th. "It was the first Valentine's Day in my adult life that I didn't expect a card or candy or jewelry ... **so I went out and bought myself a Sebring.**"* When Jere isn't cruising the oceanfront for pleasure, she's sailing away on business—as an art class teacher for a cruise ship line. And her eye for art is accompanied by an ear for music. Jere's critique of Sebring's sound-balancing Top-Down Audio Equalization System: *"Excellent. I like to listen to Vivaldi's 'Four Seasons' and, as I drive along, **I feel as if I'm in my living room.**"* Sebring has even compensated for those special little attentions Jere missed in February: *"Everyone stops me and says ... it's so elegant." That same reaction was reported by a Car and Driver writer (March 1996): **"Heads turn as you drive by** and folks will indeed stop you in parking lots..."*

**"In almost anybody's book, it's great looking—top up or down."  
—Car and Driver,  
March 1996**

**"The slick shape of the car means the wind feels gentle on your head and never gets offensive."  
—Car and Driver,  
March 1996**





*Sebring JXi Convertible*



**THE 1997 CHRYSLER SEBRING CONVERTIBLE**





**FREEDOM OF MOVEMENT IS WHAT CONVERTIBLES INSPIRE.** Often, however, that freedom is restricted — by an interior so cramped it constricts both driver and companions. **Styling** alone certifies Sebring as a freedom-of-the-road mover. But it is Chrysler's acclaimed **cab-forward** architecture that gives occupants an even more appreciated freedom: freedom from squeeze. By minimizing the space of the engine compartment, Chrysler engineers were able to maximize usable **space for people**. The expanded interior is especially accommodating for the couple in the rear. The same **long wheelbase** that enhances the styling also lengthens fore-to-aft interior room and widens the doorways — allowing rear-seat passenger entry and exit to be as gracefully executed as are the lines and proportions of the convertible itself. Sebring's **spirited design** and refined engineering endorse freedom of movement. Outside. And inside.

The steering wheel is handsomely sporty. Its rigid column imparts strength and a precise feel, and its structure is magnesium to reduce weight and minimize shake.

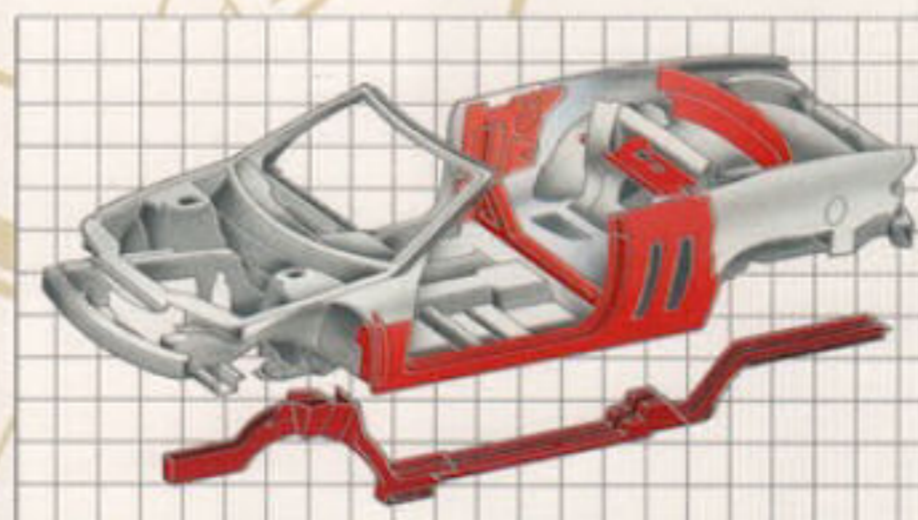
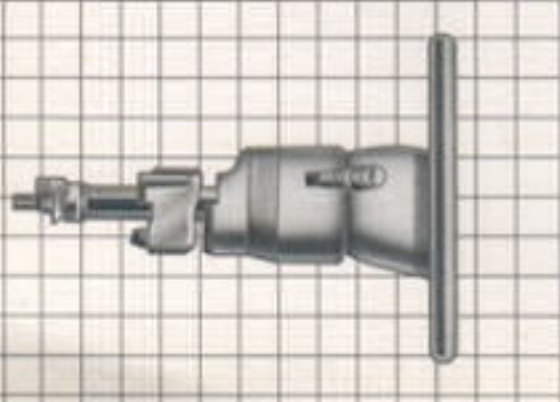

Sebring is engineered with 93 percent more torsional rigidity than its Chrysler convertible predecessor. Translation: a smoother, quieter ride. Sebring's

rigidity rests on rail-through construction, two continuous underbody steel rails that run straight, front to rear, without interruption. The "goal

post" design positions a square-tube crossmember beneath the seats to anchor two high-strength uprights for critical side-impact resistance.



The color-keyed one-piece boot is pliable for easy handling and storage. An electric motor quietly lifts the top's structural components to "stack" into

the sides of the rear recess. The outward-folding design increases rear-seat shoulder room by nearly four inches over the prior model.

*Sabang JXi Convertible leather-trimmed interior*

## SEBRING CONVENIENCES



Shoulder belts retract into the seatback and adjust automatically for height.

**IT'S SO EASY TO GET ALONG WITH SEBRING.** Smoothly cruising down an unexplored road. Or just sitting pretty in JXi's leather-trimmed **six-way power** driver's seat. Or admiring the Strappazini door panels—named for the European one-piece construction process that produces a tighter, rattle-reducing fit as well as a soft, luxuriously textured surface. To further oblige your comfort, front shoulder belts **adjust automatically** to the best position for your height. Attached to seatbacks, not stretched to side posts, the seat belts can't entangle embarking guests. And when passengers tilt the front seat forward to leave, the seat easily slides ahead, clearing the exit path.

Another comforting amenity: When the fresh air outside is too muggy, too wet or just too hot...top-up **air conditioning** is standard. The top itself is Twillfast II® stain-resistant cloth,



standard on JXi. Designed as a formal fashion statement, it's tightly engineered to seal out wind rush. Sebring's luxury-oriented **security** features include the available HomeLink® Universal Transmitter in the driver's visor (top right).

This unit memorizes activation codes enabling users to operate three different home devices—garage door opener, driveway gate, and security lights, for example. Sebring. So easy to get along with.



Three devices (garage door, security lights, etc.) can be activated by transmitters in the driver's visor. Available on JX and JXi.

Cloth interior is available on Sebring JX and JXi Convertible.





Capacious trunk has 11.3-cubic foot capacity. The subtly swept trunk lid is supported by gas struts to ease lifting. The fully opened lid tilts forward, out of harm's way.

*Sabang JXi Convertible leather-trimmed interior*



*Sebring JXi Convertible*



Large foldaway mirrors are Eurostyled.

**SEBRING'S SECOND SIDE: FASHIONABLY CHIC.** *Subtle touches are what separate the refined from the routine. And Sebring is luxuriously loaded with them. A very subtle touch is ergonomically engineered into the quietly smooth operation of switches: the top control is fingertip close at the front of the center console; for security, the power trunk release switch\* is inside the lockable console. The console's courtesy lamp also illuminates the rear floor area. A control on the dash heats the rear glass window defroster and both power foldaway mirrors.\* A day/night mirror that automatically dims the reflected glare of a following car's lights is also available. JXi features a new Compass/Temperature/Traveler display for instant trip computations.*

Powerful fog lights on JXi are alluringly deep set.



\* Standard on JXi, available on JX.



Reading lamps (top) are integrated into mirror. Top control (above left) and trunk release are easily accessed.





**Rigid structure translates to a quieter ride.**

**AN OPEN CONVERTIBLE WILL NEVER BE A SYMPHONY HALL,**

*but Chrysler acoustic engineers do provide Sebring occupants freedom from din. First, by making the "hall" itself—the interior of the convertible—as noise and **vibration-free** as possible (below). Then, by designing an acoustics system (right) that automatically maintains sound quality in both the top-up and top-down environments. Sebring's Top-Down Audio Equalization System\* maintains sound quality, modulating trebles and basses, not merely empowering them, to maintain a proper listening level and distribute the sound evenly. Large rear speakers provide **beefy basses** and the door speakers are as large as any available in passenger cars. Sound, however, can be no better than the structure that contains it. Sebring was engineered **quiet**. To maximize stiffness and minimize buzzes and squeaks, a rigid body structure rests atop solid rail-through construction. In addition to spot welds, structural adhesives permanently bond metal components to reduce the risk of rattles. Foam baffles inside structural pillars **reduce noise**. Dampeners, silencers, baffles and pads are used extensively and a unique four-point engine mount system quiets operation and dampens vibration.*

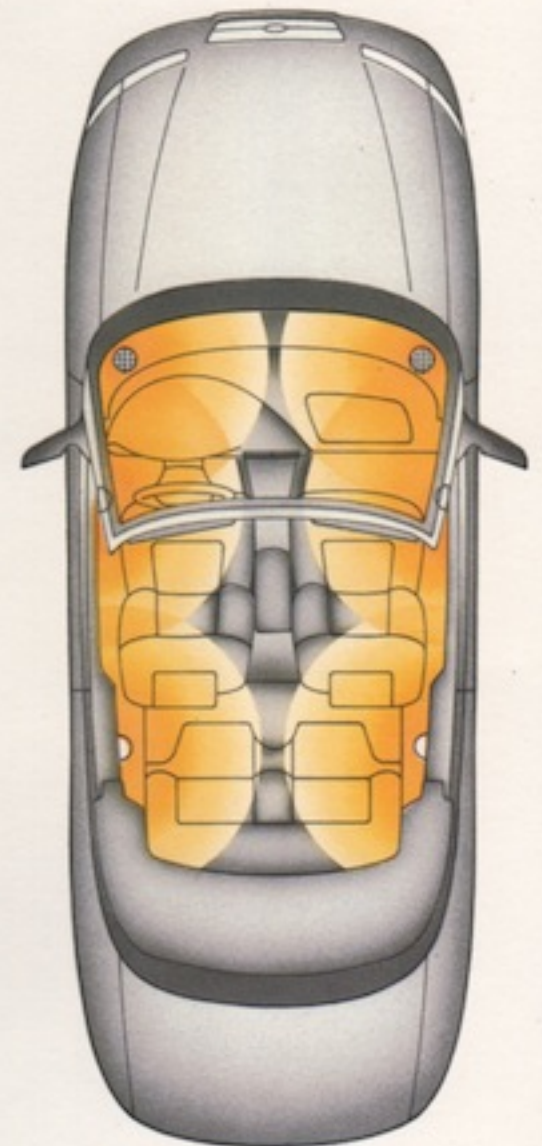

**Large six-by-nine-inch speakers surround occupants with sound.**



\*Available with premium Infinity® Sound System.



**Top-down cruising doesn't diminish the pure sounds produced by the 150 watts of power delivered through the available Infinity® Sound System's six speakers.**

*Sebring JX Convertible*





SU 64°

BRND SL

CHRYSLER

SEBRING

88.7

AUTO HEAD CLEANING

BASS TREBLE

A/C

AUTOSTICK

Sebring JXi Convertible instrument panel



**Responsive 2.4-liter, 16-valve engine is the Sebring standard.**

**THINK OF CHRYSLER ENGINEERING AS A BEHAVIORAL**

**SCIENCE.** *Engineering instilled Sebring with impeccable road manners.*

*But it is Sebring's engines that add the backbone to Sebring's beauty. Standard engine is the 2.4-liter dual overhead cam with 16 valves and 150 horsepower.*

*A 2.5-liter, 24-valve V6\* with single overhead cam is also available. With the V6, drivers can order the available **AutoStick**® transaxle shifter which allows*

*them to select the positive control of a **manual** transaxle or the smoothness of an **automatic**. Sebring's behavior on the open road is equal to the response*

*of its power trains. Meticulously engineered structural rigidity keeps the convertible's body staunchly upright on pretzel-bend roads. And a modified*

***double-wishbone** suspension system (right) does what conventional systems can't do — separate the qualities of "ride" feel from "handling" feel, by tuning*

*each independently, but compromising neither. That driving feel is maximized*

*by Sebring's **speed-sensitive** power steering system that pumps out full power assist at zero or low speeds (for a luxury-car-parking feel), then reduces*

*power assist at highway speeds (for a sports-car-handling feel). Dependable road performance is an important **safety** feature, supporting a host of*

*others: driver and front-passenger air bags<sup>†</sup>; available remote keyless entry; extra-strength side pillars, sills and crossmembers; dynamic side-impact protection, and available antilock brakes (see description opposite).*



**Remote keyless entry system includes lock, unlock and trunk release buttons and a red-button panic alarm. Standard JXi, available JX.**

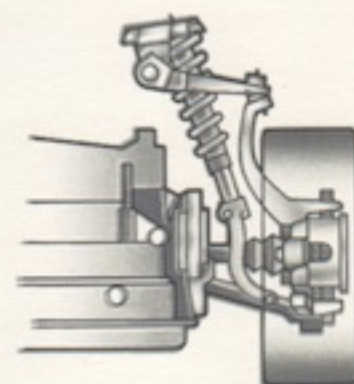

**Choose automatic or manual with AutoStick® transaxle available with V6.**



\*Built by Mitsubishi Motors Corporation. †Always wear your seat belts.



**The four-wheel antilock brake system (standard JXi, available JX) automatically pumps the brakes to prevent wheel lockup**

**in emergency braking situations, providing the stability needed for the driver to better control and maneuver the car.**

## SEBRING CHOICES



### FREEDOM'S JUST ANOTHER WORD FOR CHOOSING THE SOUND SYSTEM

that's perfectly tuned to your audio preferences.

Sebring Convertible sound system choices can be as straightforwardly simple as the six-speaker AM/FM stereo radio (A), or as resoundingly dramatic as the available AM stereo\*/FM stereo radio/cassette/CD combination (D) with the Infinity® Sound System that automatically maintains sound quality in a top-up or top-down environment. Other choices: a CD-ready AM/FM stereo radio (B) with cassette and CD changer controls, and an AM/FM stereo radio (C) with CD player and three-band graphic equalizer. A six-disc CD changer† mounted in the dash (top right) is available for the cassette radio (B), and is operated with CD controls integral to the faceplate. The changer can also be installed by your dealer as a Mopar accessory. Sebring's stylish wheel treatments are designed to accent the convertible's smart appearance. The 15-inch stainless steel, polished-finish 12-spoke-design wheel cover (E) is standard on Sebring JX. The 16-inch Sparkle Silver cast aluminum wheel (F) is standard on JXi. On a Sebring JXi with a white exterior, these wheels are also white with a bright-edged rim. They are available on the JX model only as part of the 16-inch Touring Group.

\* Some AM stereo broadcasting may not be compatible with this radio. † Late availability.



CD Changer† in the instrument panel stacks six discs.



Sebring's wheel treatments are fashionable accents.



### NO ONE BUT MOPAR OFFERS YOU MORE CHOICES

of accessories made exclusively for your new Chrysler Sebring Convertible. For total satisfaction and exceptional quality, there's only one choice—Genuine Mopar Accessories. Here are just a few of the Mopar products that can protect or enhance your car. **Electronic Vehicle Security (EVS II®)** is a remote entry system that locks or unlocks doors at a safe distance and arms/disarms the car's alarm system; includes a "panic" button that sounds the horn and flashes exterior lights. **Envelope-Style Cargo Net (A)** fastens securely to inner panels to keep groceries, sports equipment, etc. contained and to reduce sliding. Mounts easily in vertical position. **Front End Cover With Bug Screen (B)** helps protect your Sebring Convertible from damage caused by insects and debris. Black vinyl material is shaped to fit body panels and two-piece construction allows hood to be opened. **Aerostyle Molded Splash Guards (C)** are custom contoured to the shape of the body panels for stylish, functional appeal and maximum protection against gravel, salt and other road debris. **Black Vinyl Hood Cover (D)** provides low-cost hood edge protection against damage from gravel and road debris. See your Chrysler dealer for a complete listing of available Mopar accessories.



Mopar accessories protect your Sebring Convertible.



This chart is designed to assist you in selecting the model and options that best meet your needs. Begin (Step 1) by choosing the basic equipment you want and determining its availability for the model. Equipment availability is indicated by the letters (S, O, P etc.)

**Step 1 SELECT YOUR MODEL.** The letters in the columns under the model headings indicate the availability of the equipment in the left-hand column. S = Standard. O = Optional. NA = Not Available. P = Included as part of a package.

STANDARD AND OPTIONAL EQUIPMENT	JX	JXi
<b>Air Bags</b> <sup>1)</sup> —Driver and front-passenger	S	S
<b>Air Conditioning</b> —CFC-free refrigerant, manual temperature control	S	S
<b>Alternator</b> —125-ampere	S	S
<b>Antenna</b> —Fixed rear, passenger side	S	S
—Power rear, unbreakable (under normal use)	O <sup>2)</sup>	S
<b>Badging</b> —“Sebring JX” under right taillight	S	NA
—“Sebring JXi” under right taillight	NA	S
<b>Battery</b> —510-ampere, maintenance-free	S	S
<b>Brakes</b> —Power-assisted		
—Front disc/rear drum	S	NA
—Front disc/rear drum with antilock	O <sup>2)</sup>	S
<b>Bumpers</b> —5-mph, front and rear	S	S
<b>Carpeting</b> —Passenger compartment, color-keyed	S	S
—Trunk, gray	S	S
<b>Clock</b> —Digital, integral to all radios	S	S
<b>Compass/Temperature/Traveler Display</b> —Includes compass, outside temperature, driving range, average/instantaneous fuel economy, elapsed time indicator and secondary trip odometer	NA	S
<b>Console</b> —Center, lockable with armrest, storage and courtesy lamp	S	S
<b>Convertible Top</b> —Power-operated with fully-trimmed headliner	S	S
<b>Corrosion Protection</b> —Full antichip protective coating and extensive use of galvanized steel	S	S
<b>Cup Holders</b> —Front (2), integral in center console with removable ash receiver	S	S
<b>Defroster</b> —Electric rear window	S	S
<b>Demisters</b> —Front side windows	S	S
<b>Door Handles</b> —Black	S	NA
—Body-color	NA	S
<b>Door Locks</b> —Power, includes speed-sensitive feature (included in Power Convenience Group)	P	S
<b>Dynamic Side-Impact Protection</b> —Includes steel side-guard door beams and structural reinforcements	S	S
<b>Emissions</b> —Required in California, Massachusetts and New York	O	O
—Maine and states bordering California, Massachusetts and New York	O	O
<b>Engines</b> —2.4-liter DOHC 16-valve SMPI 4-cylinder	S	S
—2.5-liter SOHC 24-valve SMPI V6 <sup>3)</sup> (available with AutoStick <sup>®</sup> )	P	P
<b>Exhaust System</b> —Stainless steel	S	S
<b>Fascias</b> —Front and rear, body-color	S	S
<b>Floor Mats</b> —Front and rear, carpeted	P	S
<b>Fuel Door</b> —Driver-side	S	S
<b>Fuel Tank</b> —16.0-gallon	S	S
<b>Glass</b> —Tinted, all windows	S	S
<b>Glove Box</b> —Locking with lamp	S	S
<b>Grille</b> —Black with chrome bezel and horizontal crossbar with Chrysler seal	S	S
<b>HomeLink<sup>®</sup> Universal Transmitter</b> —Programmable (included in Luxury Convenience Group)	P	P
<b>Instrument Cluster</b> —Analog, includes speedometer, tachometer; gauges for fuel level and engine coolant temperature; fluorescent displays for PRND3L, odometer/trip odometer, door ajar, low washer fluid, deck ajar; warning lamps for brake system, low oil pressure, check engine, speed control, high beam, battery, low fuel, air bag system, coolant temperature	S	S
<b>Light Group</b> —Includes dual illuminated visor vanity mirrors and illuminated entry system	P	S
<b>Lighting</b> — <b>Exterior:</b> Dual aerodynamic composite halogen headlights, integral park and turn, front and rear side markers and 2-color taillights	S	S
—Fog lights	NA	S
— <b>Interior:</b> Front map/courtesy, center console, ignition halo, glove box, rear seat courtesy and trunk	S	S
—Front door courtesy	NA	S
<b>Luxury Convenience Group</b> —Includes automatic electrochromic rearview day/night mirror and HomeLink <sup>®</sup> Universal Transmitter	P	P
<b>Map Pockets</b> —Front doors	S	S
<b>Mirrors</b> — <b>Exterior:</b> Dual foldaway manual control, black	S	NA
—Dual foldaway power heated remote control, black (included in Power Convenience Group)	P	S
— <b>Interior:</b> Rearview day/night	S	S
—Automatic electrochromic rearview day/night (included in Luxury Conv. Group)	P	P
—Dual illuminated visor vanity (included in Light Group)	P	S
<b>Moldings</b> —Bodyside, body-color	S	S
<b>Multifunction Control Levers</b> — <b>Left hand:</b> Includes controls for headlights, turn signals, instrument panel light dimming, lane-change feature, optical horn and fog lights	S	S
— <b>Right hand:</b> Includes controls for windshield wipers/washers, variable intermittent feature and emergency hazard flashers	S	S
<b>Power Convenience Group</b> —Includes dual foldaway power heated outside mirrors and power door locks with speed-sensitive feature	P	S

under the model name. Next, choose the additional equipment you want from either the Customer-Preferred<sup>SM</sup> Packages (Step 2) or the individual options (Step 3). Packaged options (Step 2) group popular high-value options together and offer savings over the same options

STANDARD AND OPTIONAL EQUIPMENT (cont.)	JX	JXi
<b>Remote Keyless/Illuminated Entry System with Panic Alarm</b> —Includes controls for power door locks, illuminated entry system, trunk lid release, panic alarm, includes 2 transmitters	P	S
<b>Seat Belts</b> —Color-keyed, 3-point Unibelt for outboard seating positions; front belts include automatic height-adjustable shoulder belts with traveling inboard buckles; rear, 3-point Unibelt for 2 passengers	S	S
<b>Seats</b> — <b>Front:</b> Ultrahide <sup>TM</sup> with front buckets and reclining seatbacks	S	NA
—Ultrahide <sup>TM</sup> with front buckets and reclining seatbacks, 2-way adjustable head restraints and 6-way power driver seat adjustments	P	NA
—Leather-trimmed with front buckets and reclining seatbacks, 2-way adjustable head restraints, 6-way power driver seat adjustments with manual lumbar support and passenger vinyl seatback map pocket	NA	S
—Premium cloth with front buckets and reclining seatbacks, 2-way adjustable head restraints, 6-way power driver seat adjustments with passenger seatback map pocket	O	O <sup>2)</sup>
— <b>Rear:</b> Ultrahide <sup>TM</sup> with rear bench	S	NA
—Leather-trimmed with rear bench	NA	S
—Premium cloth with rear bench	O	O <sup>2)</sup>
<b>Security Group</b> —Includes Vehicle Theft Security Alarm System with central locking	P	S
<b>Smoker's Group</b> —Includes removable ash receiver and lighter	S	S
<b>Sound Systems</b> —AM/FM stereo and 6 speakers	S	NA
—AM/FM stereo with full logic cassette player, CD changer controls and 6 speakers	O	NA
—AM/FM stereo with CD player, 3-band graphic equalizer and 6 speakers	O	NA
—Premium AM/FM stereo with full logic cassette player, CD changer controls and 6-speaker 150-watt Infinity <sup>®</sup> Sound System with unbreakable <sup>®</sup> power antenna	O	S
—Premium AM stereo <sup>2)</sup> /FM stereo with combination cassette/CD player, band graphic equalizer and 6-speaker 150-watt Infinity <sup>®</sup> Sound System with unbreakable <sup>®</sup> power antenna	O	O
—6-disc CD changer, instrument panel-mounted (late availability)	O	O
<b>Speed Control</b> —Electronic with steering wheel-mounted controls	O	S
<b>Steering</b> —Power-assisted—Rack-and-pinion, speed-sensitive	S	NA
—Firm-feel rack-and-pinion, speed-sensitive	O <sup>2)</sup>	S
<b>Steering Column</b> —Height-adjustable	S	S
<b>Steering Wheel</b> —Luxury	S	NA
—Leather-wrapped	NA	S
<b>Stone Guards</b> —Front wheel well, black	S	S
<b>Sun Visors</b> —Driver and front-passenger	S	NA
—Driver and front-passenger with covered illuminated vanity mirrors	P	S
<b>Suspension</b> —Modified double-wishbone		
—Ride: Fully independent with front and rear stabilizer bars	S	NA
—Touring: Fully independent includes 16" cast aluminum wheels and tires, retuned suspension components, firm-feel rack-and-pinion steering and front and rear stabilizer bars	P <sup>3)</sup>	S
<b>Tires</b> —P205/65R15 BSW, all-season ride (set of 4)	S	NA
—P215/55R16 BSW, all-season touring (set of 4)	P <sup>3)</sup>	S
—Spare, compact	S	S
<b>Transaxles</b> —4-speed electronically-controlled automatic with overdrive	S	S
—4-speed electronically-controlled automatic with AutoStick <sup>®</sup> driver-interactive transaxle shifter	P <sup>3)</sup>	P <sup>3)</sup>
<b>Trunk Lid Release</b> —Power	P	S
<b>Vehicle Theft Security Alarm System with Central Locking</b> —Monitors doors, ignition and trunk key cylinders (included in Security Group)	P	S
<b>Wheel Covers</b> —Set of 4		
—15" 12-spoke, stainless steel	S	NA
<b>Wheels</b> —Set of 4		
—16" Venture, cast aluminum	P <sup>3)</sup>	S
<b>Windows</b> —Power with driver's auto-down feature	S	S
<b>Wiper System</b> —2-speed with speed-sensitive variable intermittent mode	S	S

<sup>1)</sup> Always wear your seat belts. <sup>2)</sup> Included with Infinity<sup>®</sup> Sound System. <sup>3)</sup> Included with V6 engine. <sup>4)</sup> Built by Mitsubishi Motors Corporation. <sup>5)</sup> Delete credit option on JXi. <sup>6)</sup> Under normal use. <sup>7)</sup> Some AM stereo broadcasting may not be compatible with this radio. <sup>8)</sup> Included in 16" Touring Group (Code AY4). <sup>9)</sup> Available with V6 engine only.

**Step 2 SELECT A PACKAGE.** Additional equipment, included in package, is listed in columns beneath each model. S = Standard. \* = Included as part of a package.

CUSTOMER-PREFERRED <sup>SM</sup> PACKAGES	JX	JX	JX	JXi	JXi
<b>POWER TRAIN AVAILABILITY</b>					
<b>ENGINES</b>					
2.4L DOHC 16V I-4	24A	24B		24D	
2.5L SOHC 24V V6		26B	26C	26D	26E
<b>TRANSAXLES</b>					
4-Speed Auto					
4-Speed Auto					
<b>CUSTOMER-PREFERRED<sup>SM</sup> PACKAGE GROUP CODES</b>					
<b>PACKAGE CONTENTS</b>	JX	JX	JX	JXi	JXi
Floor Mats—Front and rear	•	•		S	S
Headlight-Off Time Delay	•	•		S	S
Light Group—Includes dual illuminated visor vanity mirrors and illuminated entry system	•	•		S	S
Power Convenience Group—Includes dual foldaway power heated outside mirrors and power door locks with speed-sensitive feature	•	•		S	S

# SEBRING CONVERTIBLE SPECIFICATIONS

ordered separately. Finally, select exterior/interior colors (right). An experienced sales person at your dealership can now assist you in the selection of the vehicle that perfectly fits your needs.

PACKAGE CONTENTS (cont.)	JX	JX	JX	JXi	JXi
Remote Keyless/Illuminated Entry System with Panic Alarm/Trunk Release		•	•	S	S
Seats—6-way power driver's seat		•	•	S	S
Seats—Ultrahide™	S	S	S		
Sound System—AM/FM stereo with seek, full logic cassette player, CD changer controls and 6 speakers		•	•		
Speed Control—Electronic		•	•	S	S
Trunk Dressup—Flat floor		•	•	S	S
Trunk Lid Release—Power		•	•	S	S
Transaxle—AutoStick® driver-interactive transaxle shifter (with V6 engine only)		•	•		

**Step 3 SELECT ADDITIONAL OPTIONS.** Available only with corresponding Customer-Preferred™ Packages. S = Standard. O = Optional. • = Included as part of a package.

FREESTANDING OPTIONS	JX	JX	JX	JXi	JXi
Brakes—Antilock (included with V6 engine)	O	O	S	S	S
Emissions—Required in CA, MA and NY	O	O	O	O	O
Emissions—Maine and states bordering CA, MA and NY	O	O	O	O	O
Luxury Convenience Group—Includes automatic electrochromic rearview day/night mirror and HomeLink® Universal Transmitter		O	O	O	O
Power Convenience Group—Includes dual foldaway power heated outside mirrors and power door locks with speed-sensitive feature	O	•	•	S	S
Seats—Premium cloth with passenger seatback map pocket	O				
Seats—Premium cloth (delete credit option on JXi), includes 6-way power driver's seat and passenger seatback map pocket		O	O	O	O
Security Group—Includes Vehicle Theft Security Alarm System with central locking		O	O	S	S
Sound System—AM/FM stereo with full logic cassette player, CD changer controls and 6 speakers	O	•	•		
Sound System—AM/FM stereo with CD player, 3-band graphic equalizer and 6 speakers	O	O	O		
Sound System—Premium AM/FM stereo radio with full logic cassette player, CD changer controls, and 6-speaker 150-watt Infinity® Sound System with power antenna		O	O	S	S
Sound System—Premium AM stereo/FM stereo with combination cassette/CD player, 3-band graphic equalizer and 6-speaker 150-watt Infinity® Sound System with power antenna		O	O	O	O
Sound System—6-disc CD changer, instrument panel-mounted (late availability)	O	O	O	O	O
Speed Control—Electronic	O	•	•	S	S
16" Touring Group—Includes 16" cast aluminum wheels, P215/55R16 all-season touring tires, touring suspension and firm-feel rack-and-pinion steering	O	O	O	S	S

## ENGINE SPECIFICATIONS

	2.4L DOHC SMPI 4-Cyl	2.5L SOHC SMPI V6*
Configuration	2.4L DOHC SMPI 4-Cyl	2.5L SOHC SMPI V6*
Displacement	148 CID	152 CID
Compression Ratio	9.4:1	9.4:1
Bore and Stroke	3.44" x 3.98"	3.29" x 2.99"
Fuel System	Sequential Multipoint Electronic Fuel Injection	Sequential Multipoint Electronic Fuel Injection
Horsepower (SAE net @ rpm)	150 @ 5,200	168 @ 5,800
Torque (lb ft @ rpm)	167 @ 4,000	170 @ 4,350

\* Built by Mitsubishi Motors Corporation.

## WEIGHT AND CAPACITIES

	JX/JXi
Curb Weight (lb)	3,350/3,454
Fuel Tank (gal)	16.0
Turning Diameter—Curb-to-curb (ft)	40.0
Maximum Towing Capacity (lb)	2,000

## DIMENSIONS<sup>(1)</sup>

INTERIOR DIMENSIONS		EXTERIOR DIMENSIONS	
Head Room—Front	38.7	Wheelbase	106.0
—Rear	37.0	Overall Length	193.0
Leg Room—Front	42.4	Overall Width	69.2
—Rear	35.2	Overall Height	54.8
Shoulder Room—Front	55.0	Track—Front	60.2
—Rear	49.1	—Rear	60.2
Hip Room—Front	52.4	Coefficient of Drag (Cd)	0.36
—Rear	44.7		
Seating Capacity	4		
Passenger Interior Volume (cu ft)	89.1		
Cargo Volume (cu ft)	11.3/11.0 <sup>(2)</sup>		

<sup>(1)</sup> Dimensions shown in inches unless otherwise specified.

<sup>(2)</sup> With trunk dressup (Flat Floor).

## EXTERIOR COLORS<sup>(1)</sup>/ INTERIOR COLORS TOP COLORS

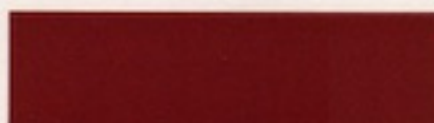

Candy Apple Red Metallic Tint\*  
Interior: Mist Gray, Camel  
Top: Black, Camel  
\*Extra Cost Paint



Light Gold Metallic<sup>(2)</sup>  
Interior: Camel  
Top: Black, Camel<sup>(2)</sup>

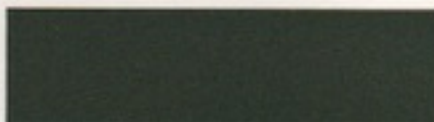

Medium Fern Green Pearl Coat  
Interior: Silver Fern  
Top: Black

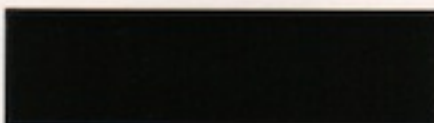

Black  
Interior: Mist Gray, Camel  
Top: Black, Camel

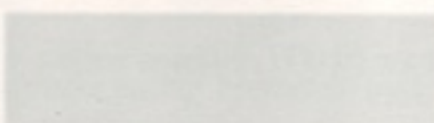

Bright White  
Interior: Mist Gray, Silver Fern, Camel  
Top: Bright White, Black, Camel

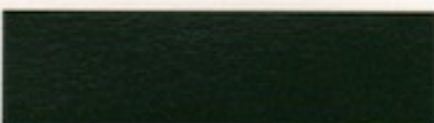

Forest Green Pearl Coat  
Interior: Silver Fern, Camel  
Top: Black, Camel

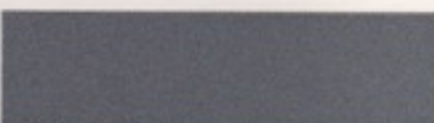

Light Iris Pearl Coat  
Interior: Mist Gray  
Top: Black

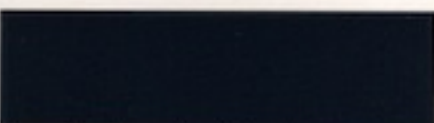

Deep Amethyst Pearl Coat  
Interior: Mist Gray, Camel  
Top: Black, Camel



Flame Red  
Interior: Mist Gray, Camel  
Top: Black, Camel

<sup>(1)</sup> Available interior/top color combinations are listed below exterior color samples.

<sup>(2)</sup> Camel cloth top not available on JXi with Light Metallic Gold exterior paint.

## FABRICS<sup>(1)</sup>



Camel  
Leather-trimmed seat



Mist Gray  
Leather-trimmed seat



Silver Fern  
Leather-trimmed seat



Silver Fern cloth seat

## TOP COLORS<sup>(4)</sup>



Camel Vinyl



Black Vinyl



Bright White Vinyl



Camel Cloth



Black Cloth

<sup>(1)</sup> JX models are equipped with standard Ultrahide™ vinyl seating in Mist Gray and Camel. Ultrahide™ vinyl is available in Silver Fern with six-way power driver's seat. JXi models are equipped with standard leather-trimmed seating in Mist Gray, Silver Fern and Camel. Odyssey cloth seating available on JX and JXi in Mist Gray and Camel. Odyssey cloth seating is available in Silver Fern with six-way power driver's seat.

<sup>(2)</sup> Twillfast II® cloth convertible top standard on JXi in Black and Camel. Vinyl convertible top standard on JX (cloth top not available on JX). White top available only in vinyl with White exterior paint on JX and JXi models. Camel cloth convertible top not available on JXi with Light Metallic Gold exterior paint.



**Chrysler Technology Center is a \$1 billion commitment to quality.**

**QUALITY IS EVERYTHING ABOUT A FINE AUTOMOBILE.**

**THE WAY IT RESPONDS. THE WAY IT ACCOMMODATES.**

**THE WAY IT LOOKS. THE WAY IT ENDURES.** *It is resale value and*

*the good opinions of knowledgeable automotive people whom you respect. It is*

*certainly the manner and expediency of your treatment whenever you have contact*

*with your dealership. Three short years ago, a sprawling new complex was erect-*

*ed. It's called the Chrysler Technology Center, and there's never been anything*

*like it. Part think tank, part assembly line and styling studio, part financial*

*center, and all space station attitude, it blends into 504 acres of woodlands 30*

*miles north of Detroit. This \$1 billion research and development facility is state-*

*of-the-art for 10,000 employees within 4.9-million square feet of floor space. It's*

*where Platform Team **engineers who are also designers** can work on*

*pilot production lines, or drive outside on a 1.8-mile road course for advanced*

*product evaluation. This is the place where the architecture of the automobile has*

*been redefined, where the ways automobiles will be manufactured have been rein-*

*vented—and where defects will be erased in product feasibility testing well*

*before they ever reach consumers. More and more, our passion is being rein-*

*forced by the conviction that if we build a superior all-around car, people will*

*buy it. And like it a lot. The sales chart at the left confirms that conclusion.*



**Chrysler mandates fit and finish to be world-class.**

**Quality has driven Chrysler brand sales up 130% in four years, a trend that's projected to continue.**

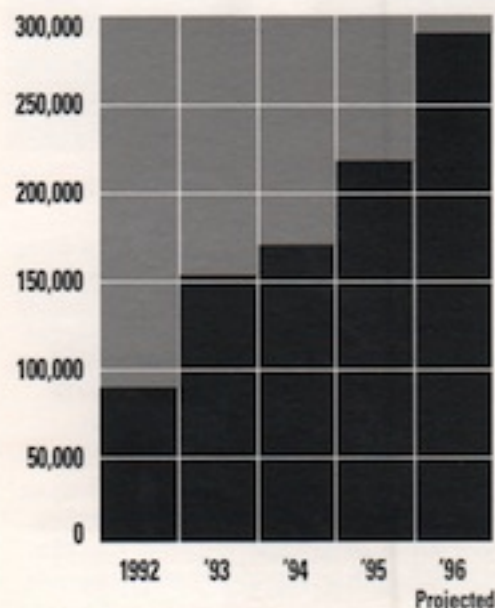

## CHRYSLER'S QUALITY ASSURANCE PROCESS

*Our process to assure satisfaction is based on a continuous evaluation and monitoring of our manufacturing process, and of consumer response to our products. It begins with the most sophisticated CAD/CAM watchdog computerization to guard every step of preproduction evolution. It continues with a meticulous in-plant quality assurance procedure. And, to assure your continuing satisfaction, it extends literally through the lifetime of any model Chrysler through a host of customer-driven programs:*

**Customer Assistance Inquiry Request:** *A formal system for responding to owners' specific questions or issues, and then documenting the action taken for consistent future correction.* **Customer Advocate Group:** *A group operating within the*

*Platform Team structure to identify, define, quantify, and prioritize expressed customer concerns.* **Customer Satisfaction**

**Audits:** *An internal, independent group separate from the manufacturing operation that looks at Chryslers coming off an assembly line the way a new owner would.* **Deep Dive Initiative:** *An in-depth study of the design, manufacturing and*

*warranty aspects of a specific concern or issue, as a response to consumer-generated observations.* **Early Warning Tracking:**

*A subsystem of the Corporate Warranty Information System making for early identification of product or production issues.*

**Fast Feedback Program:** *A process to identify, define, and shorten the cycle times needed to "fix" quality concerns on new model*

*Chryslers before they are sold to consumers.* **First Time Capability:** *A production process measurement used to assure that all*

*Chryslers are built "right" in each station always.* **Owner Clinics:** *Monthly sessions of up to 75 new Chrysler owners and 40*

*Platform Team people discussing things gone right and things gone wrong in mutual experiences with the model.* **Quality**

**Alert Transmittal:** *A formal report by the Customer Advocate Group to an assembly plant identifying and quantifying customer concerns requiring immediate attention.* **Quality Tracking System:** *Monthly customer satisfaction surveys to new*

*owners who have driven their vehicles a minimum of 45 days, seeking to remain in step with consumer product evaluation.*





**Walter P. Chrysler** next to his 1924 namesake, which came with an L-head six — the first high-compression production engine.

**THE FIRST CHRYSLER WAS BORN** *more than 70 years ago. And from the start, design and engineering paved the way. The 1924 Chrysler was made more attractive and stable with its low-slung lines. It was also the **first affordable** car to incorporate four-wheel hydraulic brakes and a high-compression six-cylinder engine — dispensing more power than all other comparable engines. A decade later, the Chrysler Airflow was introduced as the first American production car designed with **scientific**, rather than aesthetic, principles. Ahead of its time, the Airflow was 40 percent more aerodynamically efficient than any car in its class. So much so, it turned conventional thinking completely around: Airflow originator Carl Breer recalled, “A funny feeling overcame us when we looked out of the upper story window and visualized that as far as efficiency was concerned all cars on the streets were **running backwards**.” That kind of foresight continues, with Chrysler’s breakthrough cab-forward architecture leading the way. Today’s cab-forward Chrysler lineup is descended from the Chrysler Portofino concept car, whose looks — now nearly 10 years old — remain show-stopping. Proof positive that Chrysler is at the forefront of **21st Century** design and engineering.*

**The origin of cab forward took shape in the Chrysler Portofino, introduced at international auto shows in 1987.**



**Pioneer aviator Orville Wright lent his expertise to the streamlined 1934 Chrysler Airflow.**



## A HERITAGE OF DESIGN AND ENGINEERING LEADERSHIP

Chrysler recognizes the true measures of automotive excellence are engineering integrity and design innovation. These values override all other contributions a manufacturer can make; they are the nucleus of a distinctive, quality product. The following highlights attest to Chrysler's 73 years of technical prowess ... and progress.



**1927 Chrysler Imperial Series 80 Grand Luxe Cabriolet** America's first true convertible, this top-of-the-line two-seater came with a folding roof operated via carriage-style landau irons.



**1941 Chrysler C-28W Windsor Town & Country** The precursor of the minivan, with optional nine-passenger seating and a rear hatch. Genuine wood exterior panels made Town & Country the original "woody" wagon.



**1955 Chrysler C-300** The first 300-hp stock production car and most powerful full-size car in the world, the Hemi-powered C-300 was so unbeatable it was banned from the NASCAR circuit. This Ghia-inspired "Beautiful Brute" was to serve up the first Detroit V8 to break the one-horsepower-per-cubic-inch barrier.



**1963 Chrysler Turbine** Painted Turbine Bronze and sporting headlight/taillight bezels styled with a rotary-blade motif to emphasize its unusual power source, only 50 of these cars were built. Like aircraft, the world's first gas turbine "production" cars were powered from a rotating turbine wheel.



**1982 Chrysler LeBaron Convertible** In a stunning reversal of fortune, Chrysler revives the American ragtop. Based on the immensely popular K-car platform, the LeBaron was tops with open-air motorists.



**1990 Chrysler Town & Country** In response to consumer demand for a lavishly appointed luxury car alternative, Town & Country — the world's first premium minivan — was introduced; leather trim, woody looks and all.



**1993 Chrysler Concorde** Minimizing engine space to maximize living space, Concorde became the world's first cab-forward production car and forever changed the architecture of the automobile.



**1996 Chrysler Sebring Convertible** The world's first cab-forward convertible offers a passenger-friendly backseat, made more welcoming with its ease of entry and exit.

**Chrysler LHX** A stunning concept of Chrysler's future cab-forward architecture.



## SEBRING COUPE

*"... a surprisingly roomy passenger compartment that accommodates four adults ... five in a pinch."*

— Motor Trend

May 1995

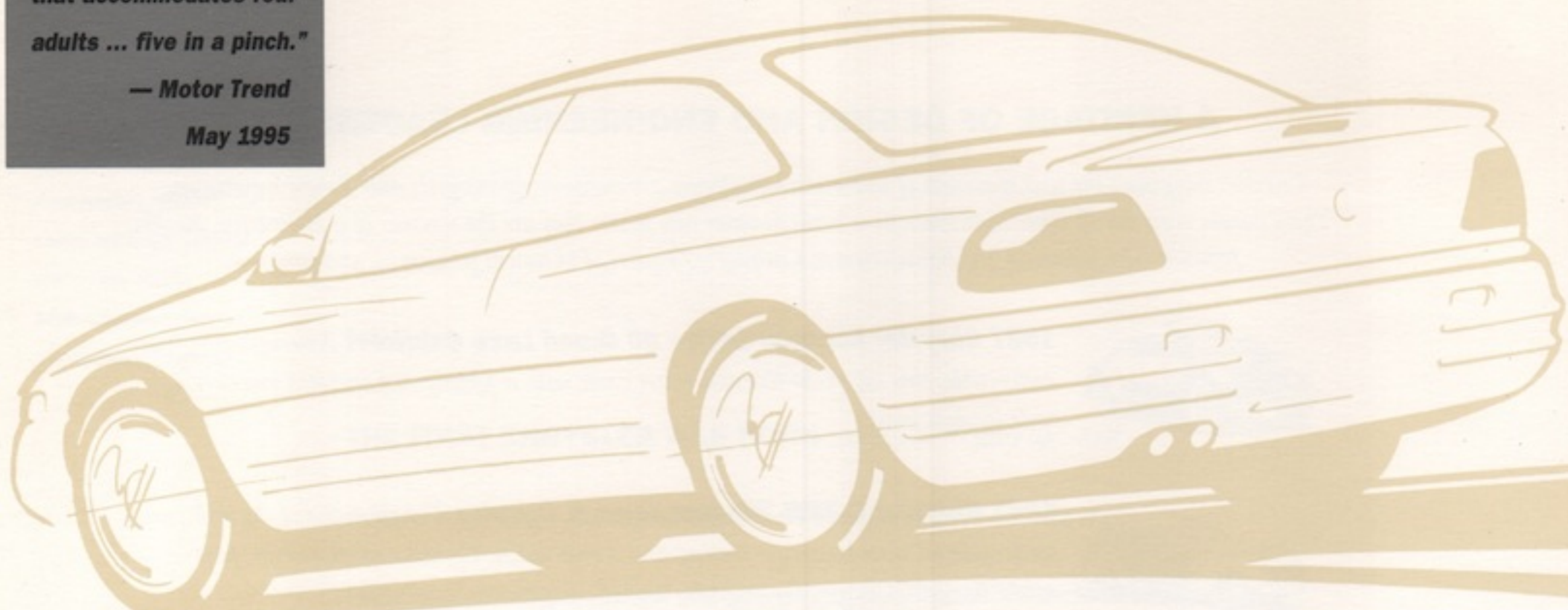

***"I really thought I'd miss my truck.***

***But I don't."***

*Because she loves to take both of her 100-pound-plus Labs along, Jill Rogers was ready to replace her truck with a new one. "Then I saw the Sebring at the auto show and I really liked it. I was still going to get another truck, because of the dogs, but I just kept going back to the Sebring." Ultimately, Sebring's style won her over: "The front is very sharp. **I love the look of those fog lights.**" And Sebring's expandable interior space proved to be just what the vet ordered: "It's very large inside. And the rear seats fold down so I can transport the dogs pretty comfortably." Jill demanded comfort for herself, too. She even opted for the moonroof, she says, "because I wanted it all." And Motor Trend (May 1995) thinks that Sebring LXi pretty much offers it all, too, with "... **a huge roster of standard equipment** including dual airbags, power steering, anti-lock brakes, air conditioning, a tilt steering column, and a lockable split-folding rear seatback."*

**Fog lights provided a stylishly sporty touch for Jill Rogers of Waterford, Michigan.**

**Sebring's roomy interior offers an available six-way power driver's seat.**

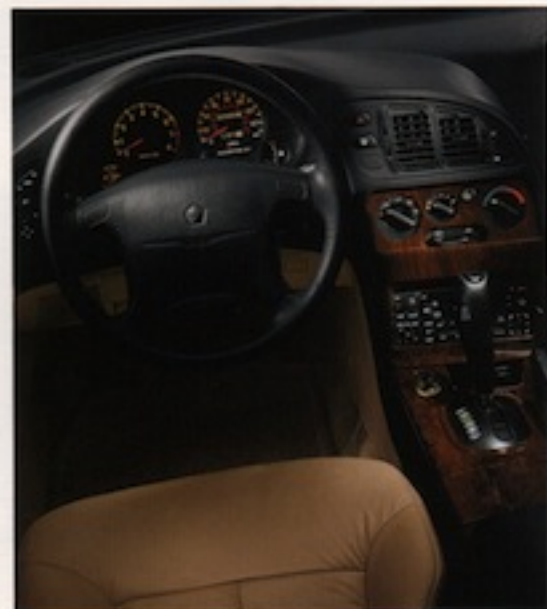



**THE 1997 CHRYSLER SEBRING COUPE**





*Sebring LXi instrument panel*



*Sebring LX cloth interior*

# SEBRING PERFORMANCE

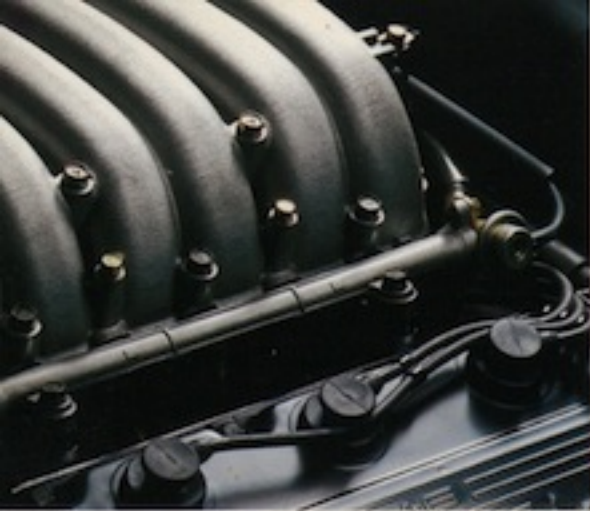

**A 2.5-liter V6\* supplies LXi's power smoothly.**

## SEBRING DRIVERS GET THEIR POWER REFINED.

*The sensations are stirring when you first experience front-wheel-drive performance as served up by the **stylish and sophisticated** Sebring. Put your foot down and delight in the sort of balanced response that demonstrates the difference between a gran turismo and a pony car—the difference between getting there in **style**, and going nowhere fast. Under Sebring LX's sculpted hood sits a work of engineering as contemporary as its sheet metal styling—a 2.0-liter, 16-valve, DOHC inline four. This lightweight, state-of-the-engineering-art power plant delivers plenty of torque for **quick response** to its sequential multipoint electronic fuel injection throttle: 130 pound-feet at 4,800 rpm. Horsepower is 140 at 6,000 rpm. The standard five-speed manual transaxle puts the power to the pavement through a series of carefully selected close-ratio gears. Step up to the touring feel of Sebring LXi and experience an entirely different driving sensation. Here, **smoothness** is foremost with a standard 2.5-liter, single overhead cam V6\* engine mated to a standard four-speed electronically controlled **automatic** transaxle with overdrive that actually "learns" your driving habits. Sebring's well-modulated V6\* delivers a healthy 163 horsepower at 5,500 rpm, in addition to the **low-end acceleration** provided by 170 pound-feet of torque at 4,350 rpm. With Sebring, the power train choices are difficult to make. Ah, but either way, the driving is easy.*

**Aggressive 2.0-liter DOHC and five-speed manual transaxle power Sebring LX.**



**Standard on LXi (with 2.5-liter V6\*) is four-speed auto with overdrive.**

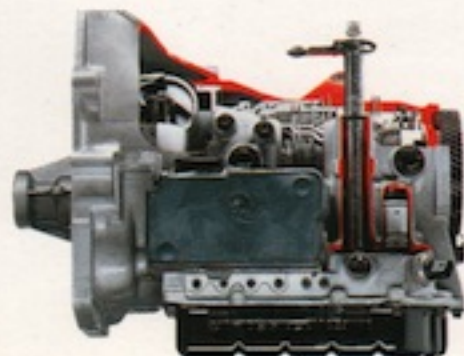

\*Built by Mitsubishi Motors Corporation.





*Sebring LX*



Cargo-containing  
not prevents  
tumble in  
cavernous trunk.

#### SEBRING DRIVERS GET THEIR SPACE.

Sebring affords you the **ultimate** (and most surprising) luxury you'll find in a sport coupe—more sheer interior volume than Acura Integra, Olds Achieva, Pontiac Grand Am, or even Honda Accord. All that and the poised **roadability** of a top-flight touring machine. Sebring's extra room is especially apparent in the rear passenger area. A lockable split-folding seatback simultaneously accommodates a person and more than one pair of skis. Power accessories switches, buttons and levers are **conveniently** located and a pleasure to use. Available HomeLink® Universal Transmitter provides three frequencies for remotes like garage doors from the safety of Sebring's interior. Available premium AM stereo/FM stereo **cassette/CD** with three-band graphic equalizer and eight-speaker Infinity® Sound System in six cockpit locations (below) provides the chase and background music. So, you bet. Sebring is one sport coupe you can stretch out in.

Control placement  
and surfaces are  
designed with key-  
board utility.



\*Some AM stereo broadcasting may not be compatible with this radio.

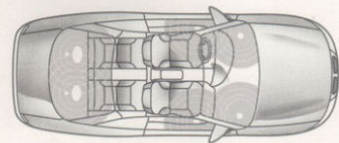

Console has dual  
cup holders and  
hidden storage.

#### SEBRING DRIVERS GET COMFORTABLE.

When it comes to car seats, drivers are often faced with the **Goldilocks phenomenon**. Some are too soft. Some are too hard. It's the ages-old war between comfort and support. But Sebring's seats are just right. Foam padding ensures comfort in the short run, while support plates under the seat pan and in the seatback help alleviate the fatigue of long drives. The standard six-way, manually adjustable Sebring LXi driver's seat includes manually adjustable **lumbar support**, side bolsters that assure lateral positioning under high-speed cornering, reclining seatbacks, two-way head restraints, and even a reclining **memory feature**. Incremental adjustment by power actuation is also available. That sort of convenience carries right through to Sebring's available **power moonroof** that affords a one-touch, open-all-the-way mechanism. Other conveniences include a **lockable** glove box, a simulated woodgrain center console and center stack applique with dual cup holders notched for cup handles, and an area hidden inside the armrest where valuables can be stored. Truly, Sebring is one sport coupe you can comfortably wrap around yourself.

Available moonroof  
opens all the way  
with one touch.



Sebring LXi available leather trimmed interior

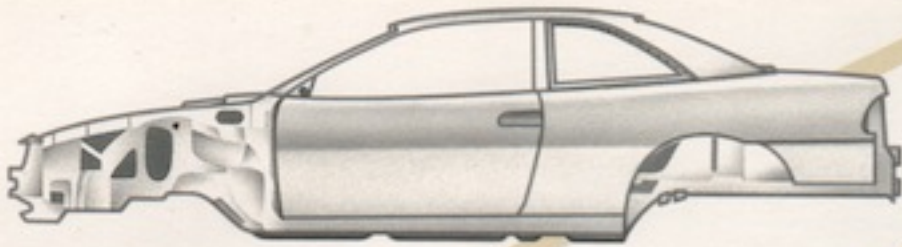

**Sebring's rigid structure makes handling superb.**

### SEBRING DRIVERS GET THE CORNER ON CONFIDENCE.

*That's because Sebring's wheels are planted firmly on the ground. Complex cloverleaves, the apexes of turns, and the cut and thrust of traffic — that's **Sebring turf**. Sebring's fully independent, double-wishbone suspension makes it so. A key component of this design is the ability to tune ride characteristics **separately** from those responsible for handling. The result is a touring suspension that delivers crisp handling without sacrificing a smooth ride. Great care was taken to provide Sebring with an extremely rigid body that improves **stability** and reduces noise significantly. Sebring's "Q" quotient is top notch — **quality and quiet**. Sound abatement insulation is used in 19 areas from instrument panel to trunk. And quality, of course, means longevity. To help ensure your investment, 80 percent of Sebring's durable body is constructed from corrosion-resistant steel. Major components of the chassis and body are made from **high-tensile** steel plate. And all Sebrings are treated to a unique, seven-stage paint process. All this — and extensive testing in the arctic conditions of Northern Canada and the baking heat of Chrysler's Arizona proving grounds — were efforts to assure an extremely satisfying and **long-lasting** relationship between car and driver.*



**Maxi space for people, minimum for mechanicals.**

**Sebring Coupe was tested in extremes of heat and cold.**

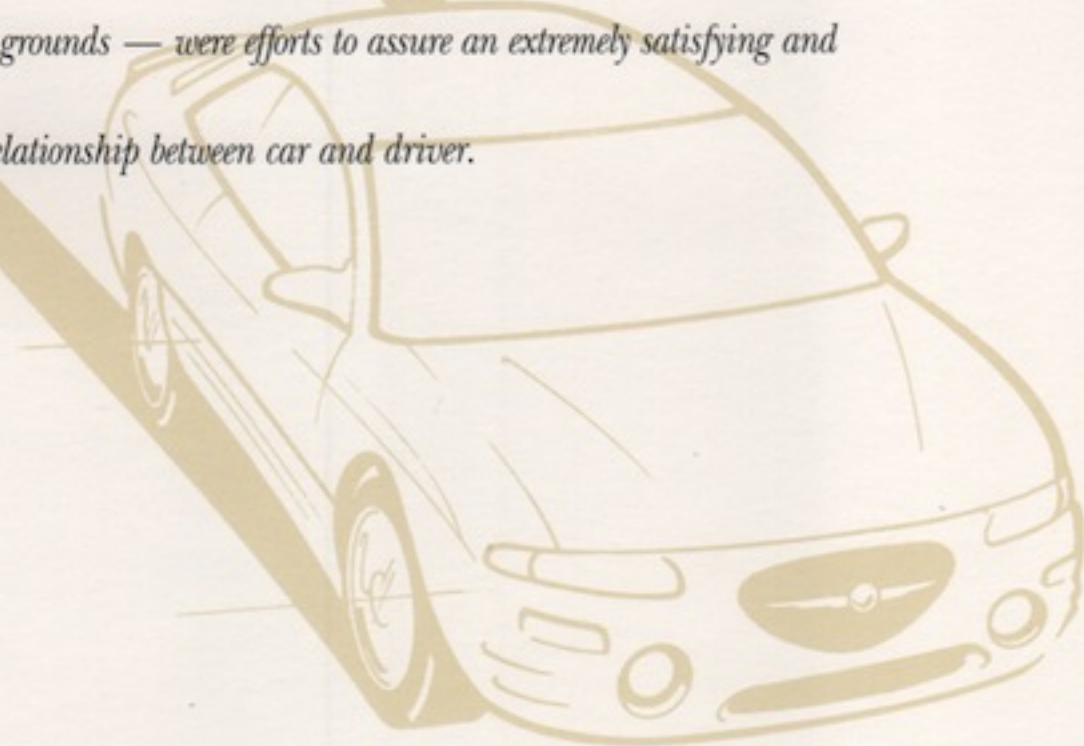



*Sebring LX*

# SEBRING FEATURES



A



B

**SEBRING AS YOU LIKE IT.** *Sebring comes so well equipped with standard features that there are actually fewer options available than you might expect. Radios, for example. Standard equipment on Sebring LX is an AM/FM stereo radio with full logic cassette player and six speakers and digital clock (A). Standard on Sebring LXi is the AM stereo\*/FM stereo cassette/CD players with three-band graphic **equalizer** and six speakers (B). That system is available as an upgrade on Sebring LX. Top of the lineup, and available to either Sebring model, is the premium AM stereo\*/FM stereo radio with combination cassette/CD players, three-band graphic equalizer and Infinity® Sound System with **eight speakers** in six locations. In the hushed quiet of Sebring's interior, chances are your CDs never sounded so good. Available as a **dealer-installed** option through Mopar® is a remote compact disc changer holding six CDs. HomeLink® Universal Transmitter is standard on LXi, and provides three separate frequencies to conveniently actuate, for example, your home garage door opener, driveway gates, and security lights from the security of Sebring's interior. Sebring LXi coupe's standard 17-inch wheels are cast aluminum (C); 16-inch wheel covers (D) are standard with the V6 engine and optional to upgrade LX's standard 14-inch wheel covers (E). 16" cast aluminum wheels (F) are standard with the available 16" Wheel Group on LX.*



C



D



E



F

**Take your CD collection for a ride.**



**Activate three remotes within Sebring's security.**



\*Some AM stereo broadcasting may not be compatible with this radio.



**Multipurpose sport gear rack is multi-useful.**



**NO ONE BUT MOPAR OFFERS** *you more choices of accessories engineered expressly for your new Chrysler Sebring coupe. For total satisfaction and exceptional quality, there's only one choice — **Genuine Mopar Accessories.** Removable Roof Rack installs and removes quickly, easily. And it can be fitted with available Mopar Bike (A) and/or Ski Carriers (top right). The Trunk Lid Rack (B) features gloss finish and is uniquely styled to complement Sebring's aerodynamic lines when not in use. EVS II® Security System includes two transmitters, starter interrupt, shock sensor, remote arm/disarm and more. Black Vinyl Hood Cover (C) provides low-cost hood edge **protection** against damage from gravel and road debris. See your Chrysler dealer for a complete listing of available Mopar Accessories, for the **finest** in fit, finish, and utility designed specifically for your new Sebring coupe.*



This chart is designed to assist you in selecting the model and options that best meet your needs. Begin (Step 1) by choosing the basic equipment you want and determining its availability for the model. Equipment availability is indicated by the letters (S, O, P etc.)

**Step 1 SELECT YOUR MODEL.** The letters in the columns under the model headings indicate the availability of the equipment in the left-hand column. S = Standard. O = Optional. P = Included as part of a package. NA = Not available.

STANDARD AND OPTIONAL EQUIPMENT	LX	LXI
<b>Air Bags<sup>1)</sup></b> —Driver and front-passenger	S	S
<b>Air Conditioning</b> —CFC-free refrigerant, manual temperature control	S	S
<b>Alternator</b>		
—90-ampere	S	NA
—110-ampere	P <sup>2)</sup>	S
<b>Antenna</b> —Fixed rear, passenger-side	S	S
<b>Ash Receiver and Lighter</b>	S	S
<b>Assist Handles</b>		
—Overhead for front passenger	S	S
—In quarter trim panels for rear passengers	NA	S
<b>Badging</b>		
—“Sebring LX” on rear trunk lid	S	NA
—“Sebring LXi” on rear trunk lid	NA	S
—Gold exterior	NA	S
<b>Battery</b>		
—430-ampere, maintenance-free	S	NA
—525-ampere, maintenance-free	P <sup>2)</sup>	S
<b>Brakes</b> —Power-assisted		
—Front disc/rear drum	S	NA
—4-wheel disc	P <sup>2)</sup>	S
—4-wheel antilock	O	S
<b>Bumpers</b> —5-mph, front and rear	S	S
<b>Cargo Net</b> —Trunk	P	S
<b>Carpeting</b>		
—Passenger compartment, color-keyed	S	S
—Trunk, gray	S	S
<b>Cladding</b> —Lower bodyside, body-color	S	S
<b>Climate Control Outlets</b> —Rear, located under front seats	S	S
<b>Clock</b> —Digital, integral to all radios	S	S
<b>Coat Hooks</b> —Rear (2)	S	S
<b>Console</b> —Center, includes armrest with storage area, simulated woodgrain applique	S	S
<b>Corrosion Protection</b> —Extensive use of galvanized steel, antichip protective coating on lower body panels and hood	S	S
<b>Cup Holders</b> —Front (2), integral with front console	S	S
<b>Defroster</b> —Electric rear window	S	S
<b>Demisters</b> —Front side windows	S	S
<b>Door Locks</b> —Power	P	S
<b>Dynamic Side-Impact Protection</b> —Includes steel side-guard door beams and structural reinforcements	S	S
<b>Emissions</b>		
—Required in California, Massachusetts and New York	O	O
—Maine and states bordering California, Massachusetts and New York	O	O
<b>Engines</b>		
—2.0-liter DOHC 16-valve SMPI 4-cylinder	S	NA
—2.5-liter SOHC 24-valve SMPI V6 <sup>3)</sup>	P	S
<b>Exhaust System</b> —Stainless steel	S	S
<b>Fascias</b> —Front and rear, body-color	S	S
<b>Floor Mats</b> —Front and rear, carpeted	S	S
<b>Fuel Door</b> —Passenger-side, remote release	S	S
<b>Fuel Tank</b> —16.9-gallon	S	S
<b>Glass</b> —Tinted, all windows	S	S
<b>Glove Box</b> —Locking with lamp	S	S
<b>HomeLink<sup>®</sup> Universal Transmitter</b> —Programmable	NA	S
<b>Instrument Cluster</b> —Analog, includes speedometer, tachometer, odometer, trip odometer; gauges for fuel level, engine coolant temperature, oil pressure (V6 engine only); warning lamps for brakes, parking brake, low oil pressure, check engine, charging system, low fuel, seat belts, air bags; and indicator lamps for high beam headlights, turn signals, hazard flashers and PRND2L	S	S
<b>Lighting</b> — <b>Exterior:</b> Dual aerodynamic composite multireflector halogen headlights, integral park and turn, front and rear side markers and 3-color taillights	S	S
—Fog lights	S	S
— <b>Interior:</b> Rear courtesy, instrument panel courtesy, ignition halo, glove box and trunk	S	S
—Dual overhead front reading lamps with courtesy function (moonroof uses integral rearview mirror lamps)	S	S

under the model name. Next, choose the additional equipment you want from either the Customer-Preferred<sup>SM</sup> Packages (Step 2) or the individual options (Step 3). Packaged options (Step 2) group popular high-value options together and offer savings over the

STANDARD AND OPTIONAL EQUIPMENT	LX	LXI
<b>Map Pockets</b> —Front doors	S	S
<b>Mirrors</b> — <b>Exterior:</b> Dual manual remote control, black	S	NA
—Dual power heated remote control, black	P	S
— <b>Interior:</b> Automatic electrochromic rearview day/night	O	S
—Dual covered visor vanity	S	S
—Dual covered illuminated visor vanity <sup>4)</sup>	P	S
<b>Molding</b> —Water channeling around windshield	S	S
<b>Moonroof</b> —Power	O	O
<b>Multifunction Control Levers</b> —Mounted on steering column		
— <b>Left hand:</b> Includes controls for headlights, turn signals, lane-change feature and optical horn	S	S
— <b>Right hand:</b> Includes controls for windshield wipers/washers and variable intermittent feature	S	S
<b>Remote Keyless/Illuminated Entry System</b>		
—Includes controls for power door locks, illuminated entry system, panic alarm, vehicle theft security alarm; includes 1 transmitter	O	S
<b>Seat Belts</b> —Color-keyed, 3-point Unibelt for outboard seating positions, front outboard positions include height-adjustable shoulder belts, traveling inboard buckles; lap belt in rear center location	S	S
<b>Seats</b>		
—Front: Cloth buckets with 2-way adjustable head restraints and reclining seatbacks, 6-way manual driver-side adjustment (dual height), reclining memory; passenger-side 2-way adjustment with easy entry feature	S	S
—Premium cloth buckets with driver-side manually adjustable lumbar support	NA	S
—6-way power driver-side	O	O
—Leather-trimmed front buckets with 6-way power driver-side	NA	P
—Rear: Cloth bench with locking split-folding seatbacks and integral head restraints	S	S
<b>Sound Systems</b>		
—AM/FM stereo radio with full logic cassette player and 6 speakers	S	NA
—AM stereo <sup>5)</sup> /FM stereo radio with combination cassette/CD player, 3-band graphic equalizer and 6 speakers	O	S
—Premium AM stereo <sup>5)</sup> /FM stereo radio with combination cassette/CD player 3-band graphic equalizer and Infinity <sup>®</sup> Sound System with 8 speakers in 6 locations	O	O
<b>Speed Control</b> —Electronic	P	S
<b>Spoiler</b> —Trunk lid	NA	S
<b>Steering</b> —Power-assisted, speed-sensitive, rack-and-pinion	S	S
<b>Steering Column</b> —Height-adjustable	S	S
<b>Steering Wheel</b>		
—Luxury	S	NA
—Leather-wrapped	NA	S
<b>Sun Visors</b>		
—Driver and front-passenger covered vanity mirrors	S	NA
—Driver <sup>6)</sup> and front-passenger with illuminated covered vanity mirrors	P	S
<b>Suspension</b> —Double-wishbone		
—Touring: Fully independent with front stabilizer bar	S	NA
—Handling: Fully independent with front and rear stabilizer bars	NA	S
<b>Tires</b>		
—P195/70HR14 BSW, all-season touring (set of 4)	S	NA
—P205/55HR16 BSW, all-season performance (set of 4)	P <sup>2)</sup>	NA
—P215/50HR17 BSW, all-season performance (set of 4)	NA	S
—Spare, compact	S	S
<b>Transaxles</b>		
—5-speed manual with overdrive	S	NA
—4-speed electronically-controlled automatic with overdrive	P	S
<b>Trunk Lid Release</b> —Remote	S	S
<b>Wheel Covers</b> —Set of 4		
—14" Luxury	S	NA
—16" Luxury	P <sup>2)</sup>	NA
<b>Wheels</b> —Set of 4		
—16" cast aluminum	O <sup>6)</sup>	NA
—17" cast aluminum	NA	S
<b>Windows</b> —Power with driver's one-touch-down feature	P	S
<b>Wiper System</b> —2-speed with variable intermittent mode	S	S

<sup>1)</sup>Always wear your seat belts. <sup>2)</sup>Included with V6 engine. <sup>3)</sup>Built by Mitsubishi Motors Corporation. <sup>4)</sup>Driver-side illuminated visor vanity mirror is deleted with HomeLink<sup>®</sup> Universal Transmitter. <sup>5)</sup>Some AM stereo broadcasting may not be compatible with this radio. <sup>6)</sup>Included with 16" Wheel Group.

# SEBRING COUPE SPECIFICATIONS

same options ordered separately. Finally, select exterior/interior colors. An experienced sales person at your dealership can now assist you in the selection of the vehicle that perfectly fits your needs.

**Step 2 SELECT A PACKAGE.** Additional equipment, included in some of these packages, is listed in columns beneath each model. S = Standard. • = Included as part of a package.

## CUSTOMER-PREFERRED™ PACKAGES

POWER TRAIN AVAILABILITY		CUSTOMER-PREFERRED™ PACKAGE GROUP CODES		
ENGINES	TRANSAXLES	LX	LX	LXi LXi
2.4L DOHC 16V I-4	5-Speed Manual	21G	21H	
2.4L DOHC 16V I-4	4-Speed Auto	22G	22H	
2.5L SOHC 24V V6 <sup>††</sup>	4-Speed Auto	24H	24J	24K

<sup>††</sup>Built by Mitsubishi Motors Corporation.

## PACKAGE CONTENT

PACKAGE CONTENT	LX	LX	LXi	LXi
Cargo Net—Trunk		•	S	S
Speed Control—Electronic		•	S	S
Door Locks—Power		•	S	S
Mirrors—Dual power heated		•	S	S
Mirrors—Dual illuminated visor vanity		•	S	S
Windows—Power with driver's one-touch-down feature		•	S	S
Seats—6-way power driver's seat				•
Seats—Leather-trimmed front buckets				•

**Step 3 SELECT ADDITIONAL OPTIONS.** Available only with Customer-Preferred™ Packages. S = Standard. O = Optional. • = Included as part of a package.

## FREESTANDING OPTIONS

FREESTANDING OPTIONS	LX	LX	LXi	LXi
Brakes—Antilock	0	0	S	S
Emissions—Required in California, Massachusetts and New York	0	0	0	0
Emissions—Maine and states bordering CA, MA and NY	0	0	0	0
Mirror—Automatic electrochromic rearview day/night without reading lamps (not available with moonroof)		0	S	S
Mirror—Automatic electrochromic rearview day/night with reading lamps (must have moonroof)		0	S	S
Moonroof—Power		0		
Remote keyless/illuminated entry with panic and security alarm system		0	S	S
Seats—6-way power driver-side		0	0	•
Sound System—AM stereo <sup>††</sup> /FM stereo radio with combination cassette/CD player, 3-band graphic equalizer and 6 speakers		0	S	S
Sound System—Premium AM stereo <sup>††</sup> /FM stereo with combination cassette/CD player, 3-band graphic equalizer and Infinity® Sound System		0	0	0
16" Wheel Group—Includes 16" cast aluminum wheels, and P205/55R16 tires		0		

<sup>††</sup>Some AM stereo broadcasting may not be compatible with this radio.

## SPECIFICATIONS

SPECIFICATIONS	LX	LXi
Engine Configuration	2.0-liter DOHC SMPI 4-Cylinder	2.5-liter SOHC SMPI V6 <sup>††</sup>
Displacement	120 CID	152 CID
Compression Ratio	9.8:1	9.5:1
Bore and Stroke	3.45 x 3.27	3.28 x 2.99
Fuel System	Sequential Multipoint Electronic Fuel Injection	Sequential Multipoint Electronic Fuel Injection
Horsepower (SAE net @ rpm)	140 @ 6,000	163 @ 5,500
Torque (lb ft @ rpm)	130 @ 4,800	170 @ 4,350

<sup>††</sup>Built by Mitsubishi Motors Corporation.

## WEIGHTS AND CAPACITIES

Curb Weight (lb)	2,959 <sup>††</sup> /3,197 <sup>††</sup>
Fuel Tank (gal)	16.9
Turning Diameter—Curb-to-curb (ft)	38.0
Maximum Towing Capacity (lb)	Not Recommended

<sup>††</sup>LX with standard engine and transaxle.

<sup>††</sup>LXi with standard engine and transaxle.

## DIMENSIONS<sup>(1)</sup>

INTERIOR DIMENSIONS	EXTERIOR DIMENSIONS
Head Room—Front	Wheelbase
—Rear	Overall Length
Leg Room—Front	Overall Width
—Rear	Overall Height
Shoulder Room—Front	Track—Front
—Rear	—Rear
Hip Room—Front	Coefficient of Drag (Cd)
—Rear	<sup>††</sup> Dimensions shown in inches unless otherwise specified.
Seating Capacity	
Passenger Interior Vol. (cu ft)	
Cargo Volume (cu ft)	

## EXTERIOR COLORS/ INTERIOR COLORS

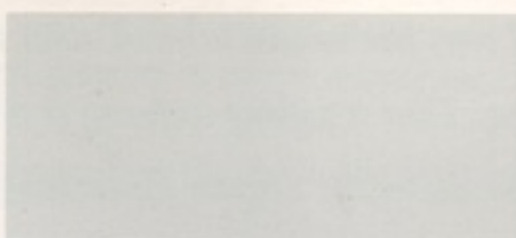

Bright White  
Interior: Gray, Black/Tan



Black  
Interior: Gray, Black/Tan



Wildberry Pearl Coat  
Interior: Gray, Black/Tan



Pewter Blue Metallic  
Interior: Gray

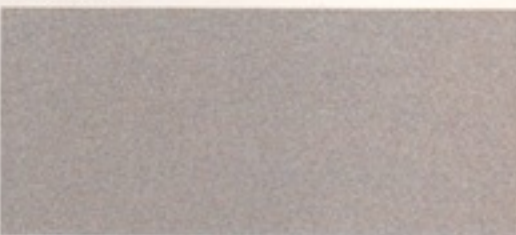

Silver Mist Pearl Coat  
Interior: Gray

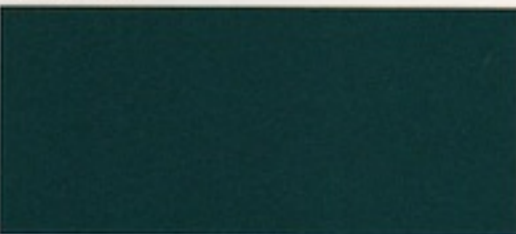

Polo Green Pearl Coat  
Interior: Gray, Black/Tan

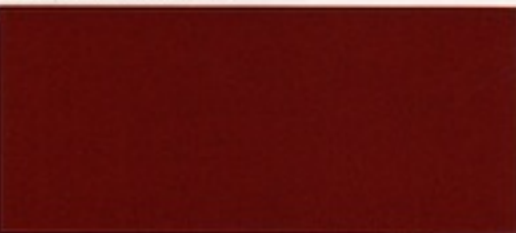

Paprika Pearl Coat  
Interior: Gray, Black/Tan



Indy Red  
Interior: Gray, Black/Tan

## FABRICS<sup>†</sup>



Gray leather-trimmed seat



Gray Jaeger cloth seat



Black/Tan Mirage cloth seat

<sup>†</sup>LX model is equipped with standard Mirage cloth seating. LXi model is equipped with premium Jaeger cloth interior. Leather-trimmed front bucket seats available only on LXi in Tan and Gray.



*Synonymous with engineering leadership for seven decades, this  
Chrysler seal embodies the thoughtful design, functional luxury and enduring  
value of the Chrysler collection of refined automobiles.*

*What's new in your world?*



# Sebring Coupe Engine Availability

## UPDATE

The "Customer-Preferred Packages" chart, which appears beneath the "Step 2" section on page 55 of the Sebring Catalog, contains incorrect engine designations. The engine which is listed as "2.4L" is actually a 2.0-Liter engine.

The chart below contains all of the correct information for the "Customer-Preferred Packages" chart. Please refer to this chart when selecting your package contents.

<b>CUSTOMER-PREFERRED<sup>SM</sup> PACKAGES</b>		<b>LX</b>	<b>LX</b>	<b>LXi</b>	<b>LXi</b>
<b>POWER TRAIN AVAILABILITY ENGINES</b>	<b>TRANSAXLES</b>	<b>CUSTOMER-PREFERRED<sup>SM</sup> PACKAGE GROUP CODES</b>			
2.0L 16-Valve DOHC I-4	5-Speed Manual 4-Speed Automatic	21G 22G	21H 22H		
2.5L 24-Valve SOHC V6*	4-Speed Automatic		24H	24J	24K

\*Built by Mitsubishi Motors Corporation.