

1960

CHEVROLET

*El Camino and
Sedan Delivery*



new!
El Camino
styling
pages 2 & 5

new!
El Camino
features
page 3

new!
Sedan Delivery
features
page 4

new!
engine and
chassis features
page 6

Chevrolet...
first choice of
truck buyers
since 1937!

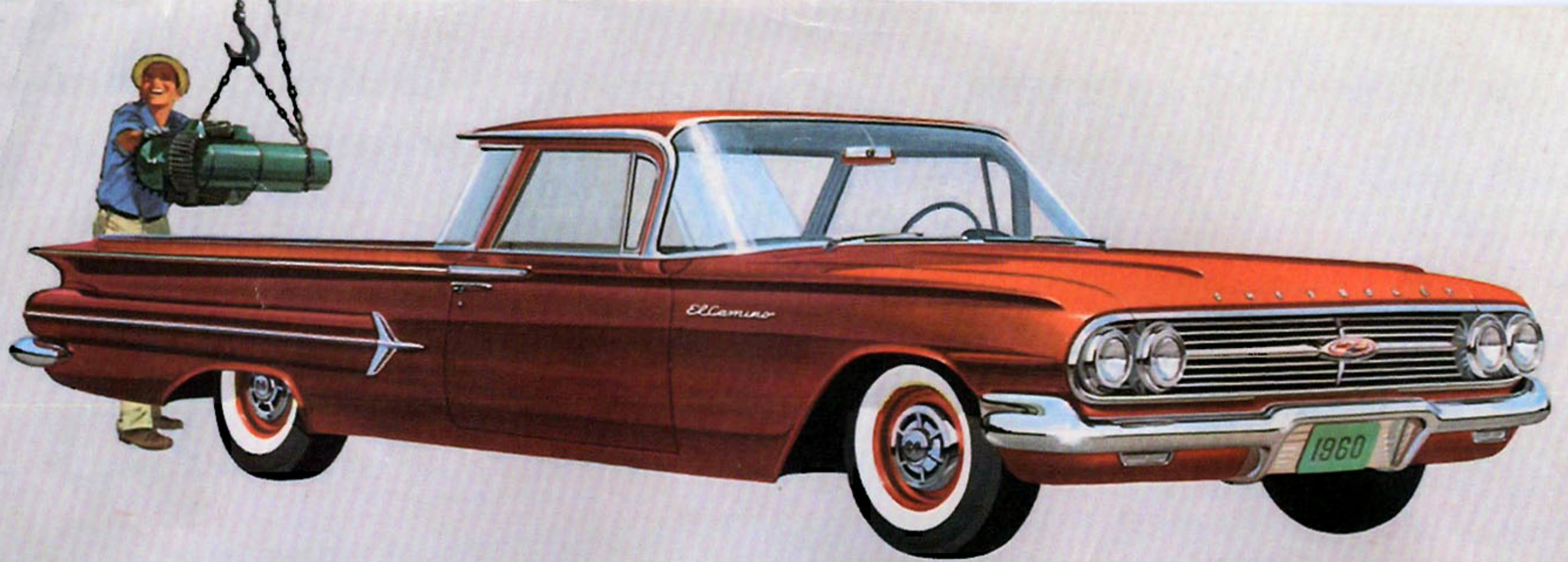

The magnificent 1960 Chevrolet **El Camino**...

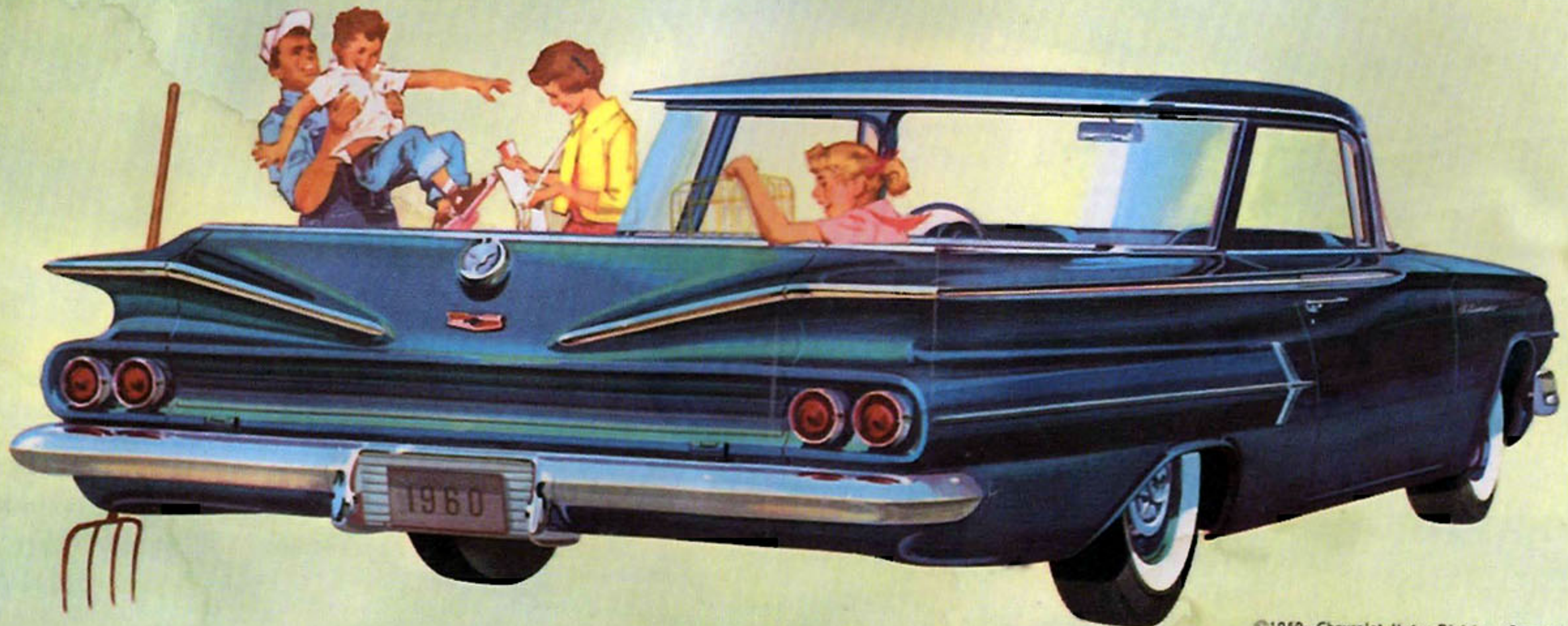



Luxurious new El Camino interiors feature passenger-car styling, new foot-operated parking brake with convenient release handle, tough, yet fashionable, pattern-cloth upholstery and matching colors.

There's loads of room for man-sized hauls in this 32½-cu.-ft. pickup box. Double-walled side panels add extra strength . . . protect the lustrous exterior beauty from inside bumps and knocks during loading.



Chevrolet has a new winner in the 1960 El Camino—a commercial vehicle that's a prize combination of business ability and beauty. You can see the glamor at a glance . . . the new passenger car styling and low silhouette (available in 13 high-fashion exterior colors and 10 glowing two-tone color combinations) . . . the luxurious executive interiors with harmonizing decorator colors.

But this fleet, new dazzler is all business, too. It's built for hard work with a rugged X-built Safety-Girder frame . . . a big capacity pickup box with graintight tailgate . . . and tough, economical 6-cylinder or V8 power. El Camino model 1280 gives you your choice of *seven* great V8 engines. With up to 335 horsepower and short-stroke design, they're built to breeze through the toughest light-duty tasks—keep costs down, too. In the new 283-cu.-in. Turbo-Fire V8, a new economy-contoured camshaft and economy carburetor squeeze extra miles from every tankful of gas.

With G.V.W.'s up to 4,900 lbs., Full Coil suspension, big safe brakes and rugged Synchro-Mesh transmission, the 1960 Chevrolet El Camino is ready to bring new highs in hauling pleasure and prestige to hard-working businessmen, ranchers, farmers, suburbanites and many more.

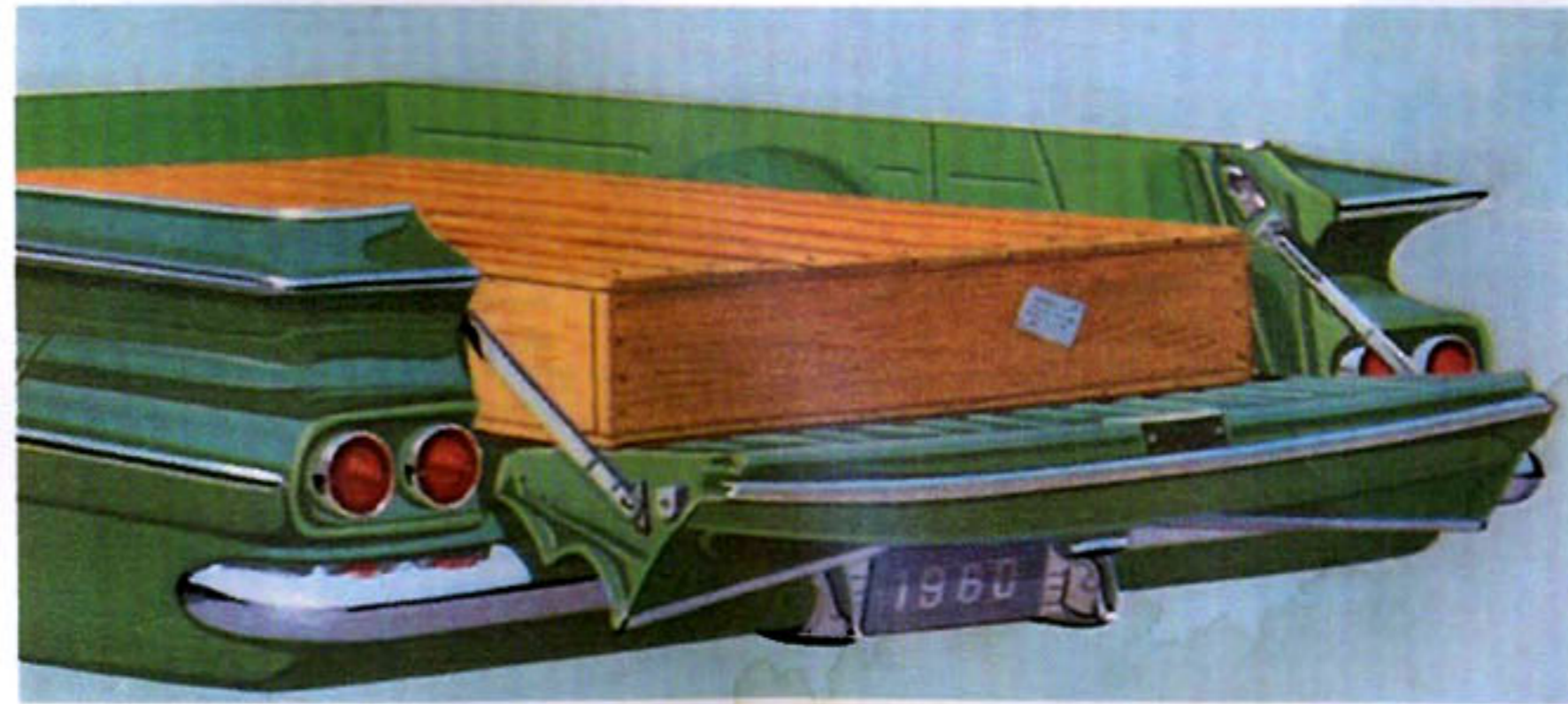

The 1960 El Camino's strong, tailgate supports extra long, extra heavy loads; tailgate's double-walled construction helps keep the sculptured rear looking like new. When lowered flush with the floor, it forms a platform nearly 8' long. Closed, it forms a graintight seal.

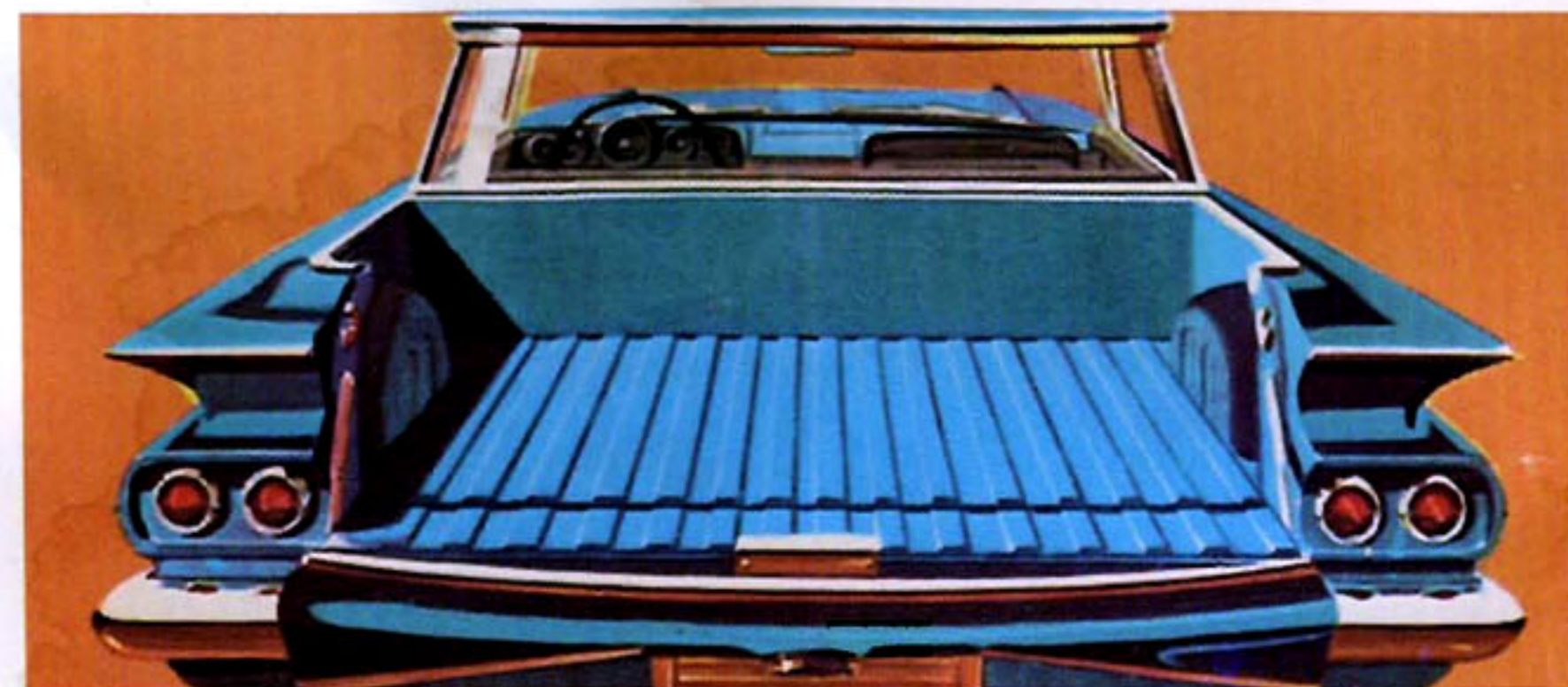

This smooth-lined beauty is built for work! All-steel body has an 18-gauge ribbed-steel floor. Spacious pickup box is 76¼" long, 64¼" wide and 12⅞" deep. Rear license plate is hinged for vehicle identification when tailgate is lowered.

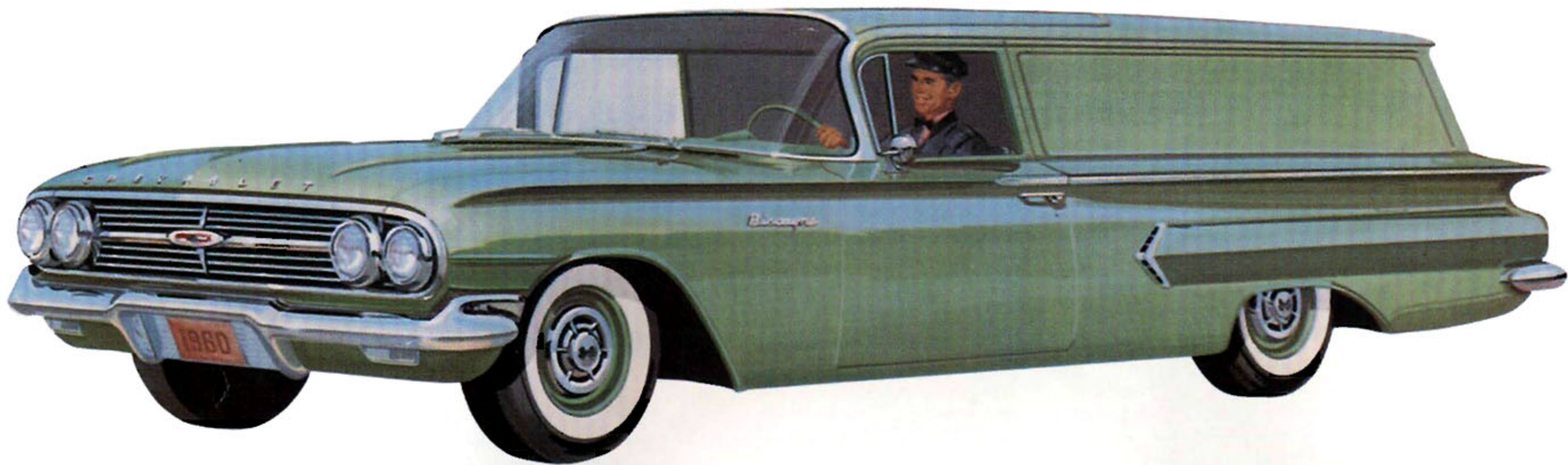

**1960 Chevrolet *Sedan Delivery*
combines high style with high capacity**

The 1960 Chevrolet Sedan Delivery, with its handsome passenger-car styling, will do any delivery business proud, including *yours!*

Interior appointments are practical as well as luxurious. They include stylish passenger-car instrument panel . . . adjustable, form-fitting seat . . . and a *large* load compartment that's paneled in smooth no-warp masonite.

You get space to spare in the new Sedan Delivery load compartment (93 cu. ft.!). Also, there's more room up front that can be utilized for extra packages. And there's more economy, too! Chevy's 1960 Turbo-Fire V8 provides a new economy-contoured camshaft for extra gas savings every mile you travel. And other engine choices, the Super Turbo-Fire V8 and Hi-Thrift 6, are first class cost-cutters, too. With all it offers in good looks and functional designing, the 1960 Sedan Delivery is a smart new answer to *many* delivery needs.

A comfortable auxiliary seat, optional at extra cost, folds out of the way for easy entrance to the load compartment. It lets you carry an extra man when needed.

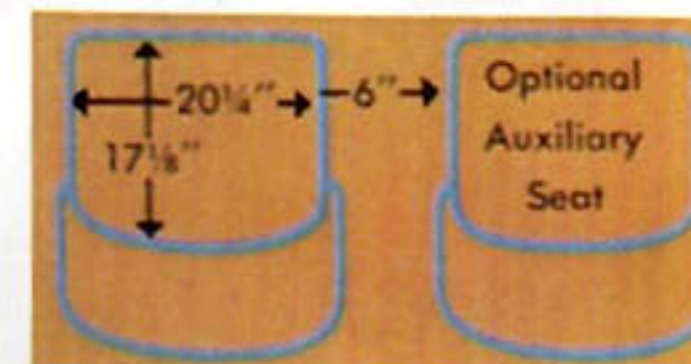

You get extra beauty and convenience, both, with that 1960 passenger-car-styled instrument panel. And you sit in a deep-cushioned seat that's steel sheathed at the back for added safety. Also, there's a new interior spaciousness: more leg room and more package space!

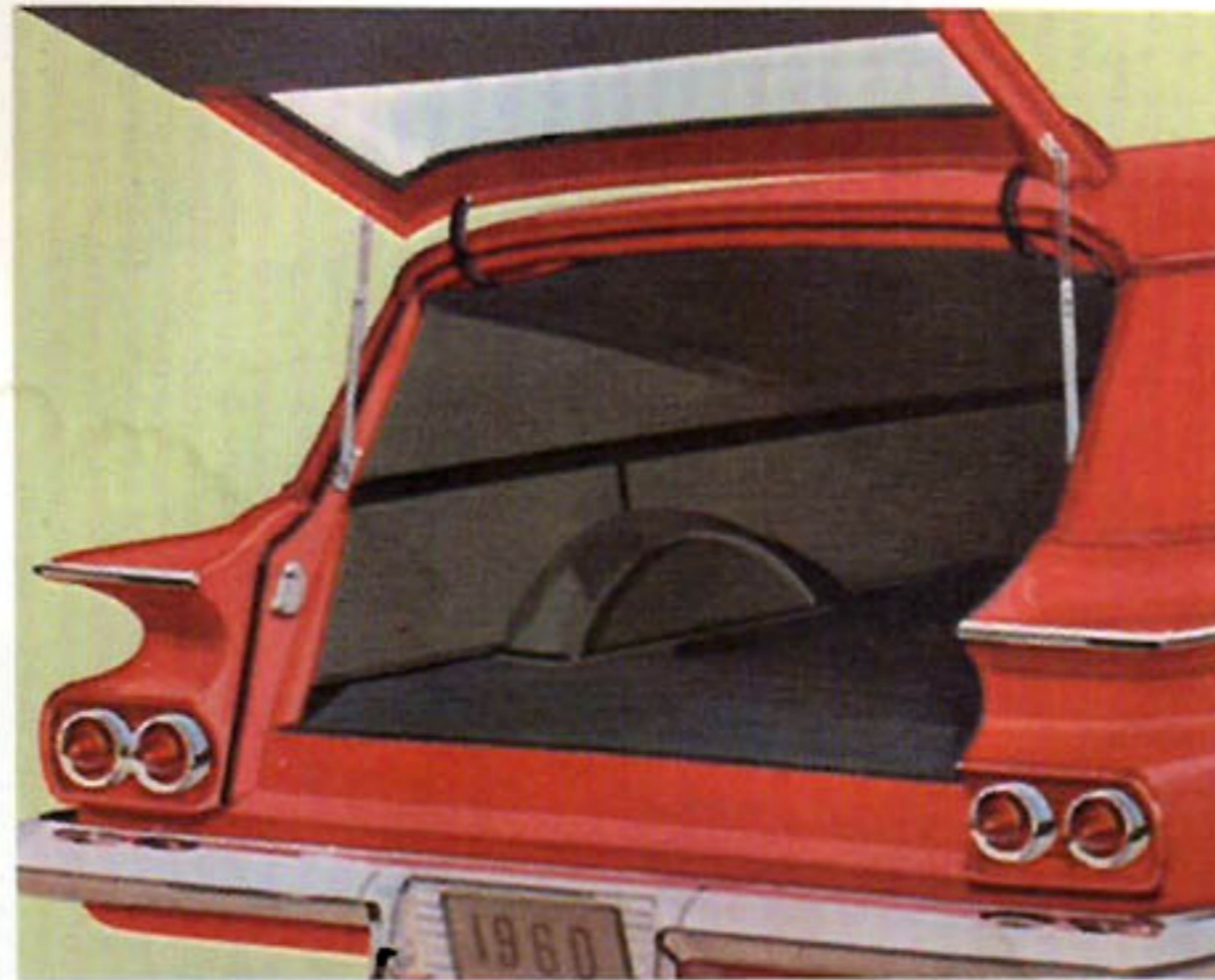

Full-width rear door swings up and out of the way. The roomy interior, with up to 93 cu. ft. of load space, can handle out-sized cargoes with ease. Maximum G.V.W. of 4,900 lbs. lets you pile heavy cargoes roof high! A tough, washable vinyl headlining extends from front to rear.

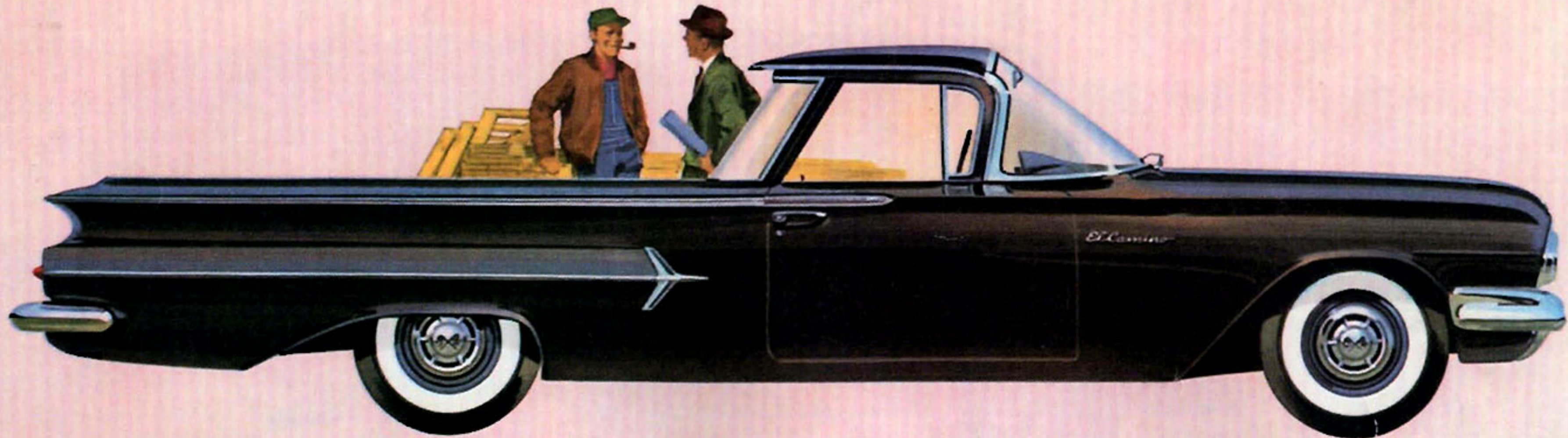

here with new highs in style and sturdiness



Big-saving engine power

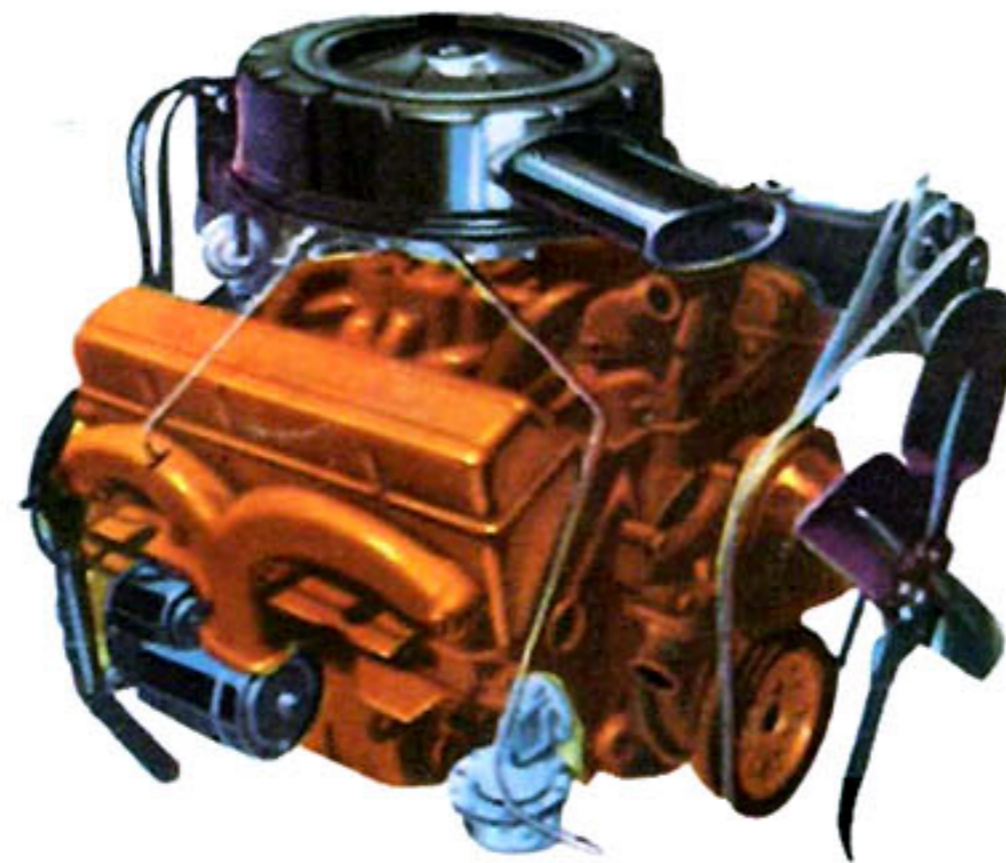
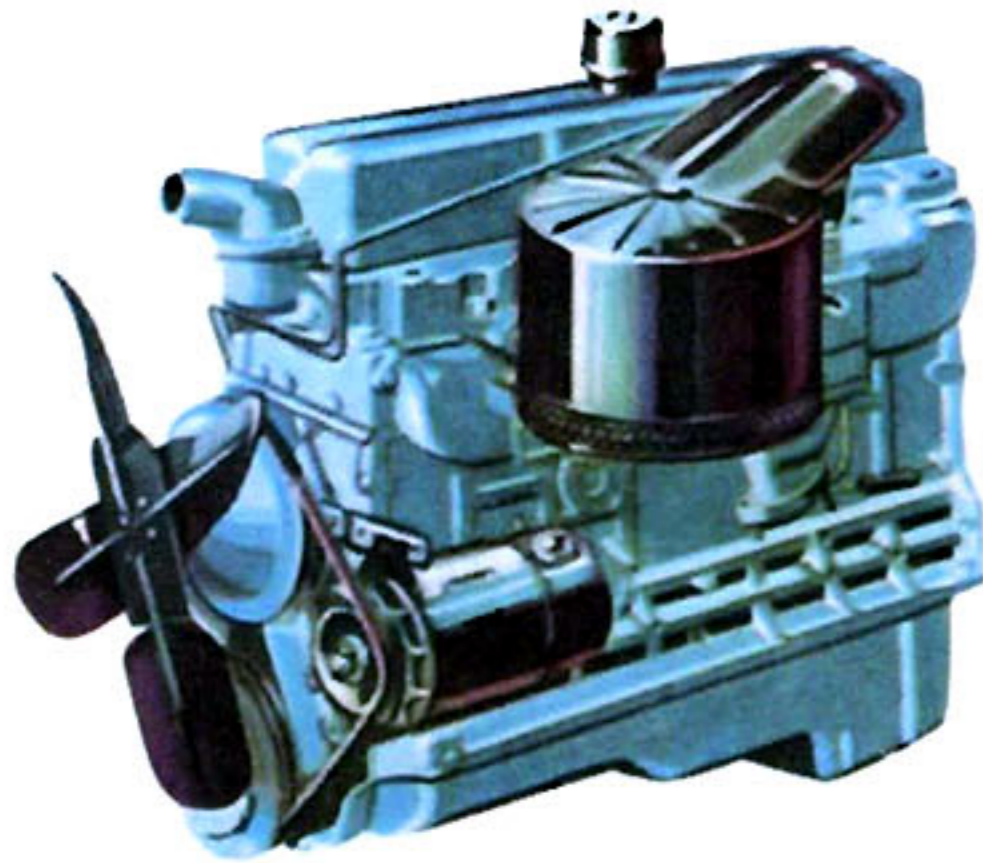

Dependable Hi-Thrift 6—This economy-minded 235-cu.-in. engine is now standard in El Camino model 1180 and Sedan Delivery model 1170. On-the-job dependability and long-lasting durability are assured by such premium features as forged steel crankshaft, precision alloy bearings, high quality steel valves and pressurized cooling. High 8.25 to 1 compression ratio gets extra power from every tankful of regular gas.

Eight Efficient V8's!—Fuel economy is even better than ever in 1960, thanks to the new economy-contoured camshaft in the tough 170-h.p. 283-cu.-in. Turbo-Fire V8—now standard in the Sedan Delivery model 1270 and El Camino model 1280. Optional at extra cost in these models is the 230-h.p. 283-cu.-in. V8 engine. Five extra-high performance 348-cu.-in. V8's, with up to 335-h.p. are optional at extra cost in El Camino model 1280.

CHASSIS DIMENSIONS

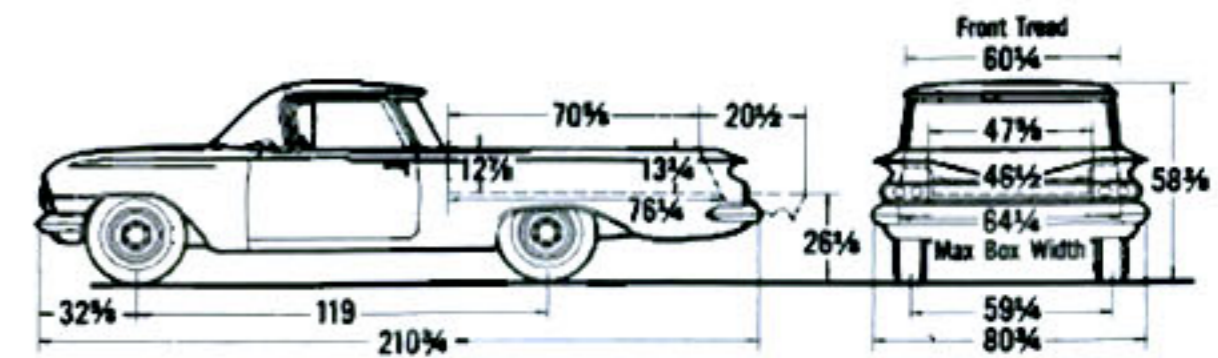

El Camino Models

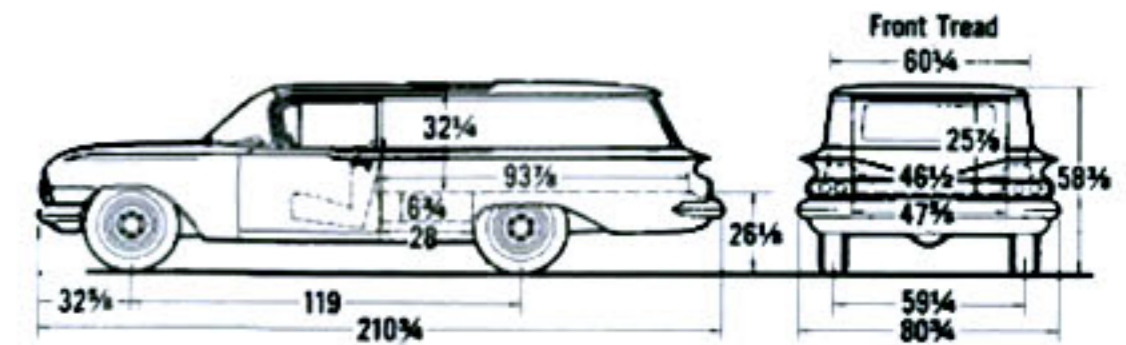

Sedan Delivery Models

SPECIFICATIONS

STANDARD EQUIPMENT—AXLE, REAR: Ratio 3.55 (Series 11), 3.36 (Series 12); capacity 3,000 lb. BRAKES: Hydraulic, front 11" x 2 3/4", rear 11" x 2"; lining area 199 sq in; parking brakes on rear wheels. CLUTCH: 9 1/2" dia (Series 11); 10" dia (Series 12). DIRECTIONAL SIGNALS: Front & rear. ENGINE: 135-hp Hi-Thrift 6 (Series 11); 170-hp Turbo-Fire V8 (Series 12). FUEL TANK: Capacity 17 gallons. GENERATOR: 12-Volt, 30-ampere. SPRINGS, FRONT: Coil, capacity 1,030 lb each. SPRINGS, REAR: Coil, capacity 1,315 lb each. STEERING: Ball-gear, ratio 28:1. TIRES: Five tubeless 8.00-14/4PR. TRANSMISSION: 3-Speed Synchro-Mesh. WINDSHIELD WIPERS: Dual electric; single-speed.

OPTIONAL EQUIPMENT*—AXLE, POSITRACTION REAR. BRAKES, POWER. DE LUXE EQUIPMENT: Armrests, right sunshade, fender ornaments, cigarette lighter. ENGINE, V8: (Models 1270, 1280) 230 hp; (Model 1280 only) 250 hp, 280 hp, 305 hp, 320 hp or 335 hp. E-Z-EYE GLASS. GENERATOR: 35 amp, 40 amp or 50 amp. HEATER: Recirculating or De Luxe. OIL FILTER. PAINT, TWO-TONE EXTERIOR: (El Camino only). Choice of 10 combinations. PADDED INSTRUMENT PANEL. RADIO: Manual or pushbutton. SEAT, FOAM RUBBER. SPRINGS, REAR: 1,530 lb. each. STEERING, POWER. TRANSMISSIONS: Powerglide; Overdrive; (Series 12 only) Turboglide. WINDSHIELD WASHERS. WINDSHIELD WIPERS: 2-speed electric, includes washers. TIRES: 8.50-14/4PR blackwall or whitewall.

*Extra-cost equipment.

ACCESSORIES

Chevrolet offers a full range of accessories to meet your needs for on-the-job comfort, safety and convenience. Here are some of the many top-quality Chevrolet accessories: air conditioner, arm rests, bumper guard, back-up lights, heaters, mirrors, power brakes, radios, safety-lights, seat belts, speedminder, wheel covers, and windshield washers.

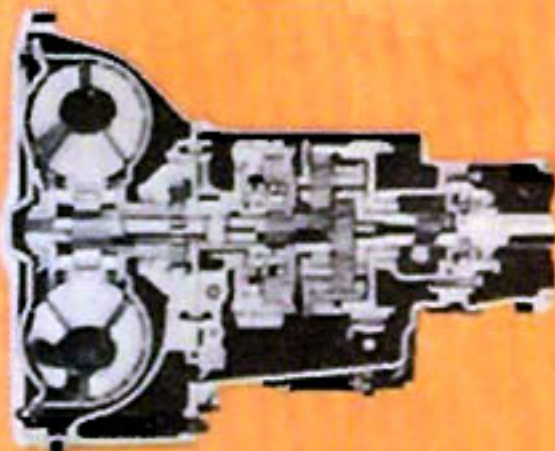

Powerglide—You can concentrate on driving and leave the gear shifting to this smooth, fully automatic transmission—owner proved over millions of highway miles. Powerglide speeds deliveries, reduces driver fatigue. Optional at extra cost.



Positraction—Snow, mud or slippery roads don't slow deliveries when you use Chevy Positraction. Positraction rear axle (optional at extra cost) directs power to whichever wheel is getting the better traction. Helps wheels to grip any road surface for more positive, safer control.



X-Girder Frame—Sturdy X-Built Safety-Girder frame provides a solid foundation that resists the stresses from maximum loads and rough roads. Box section side members and box girder center beam give extra rigidity.



Safety-Master Brakes—Quicker, safer stops with 199 sq. in. of bonded lining area. Wheel slots allow cool air to flow over the drums, while special flanges carry away the heat. Large lining and drum areas and the relatively cool operation all combine to give longer lining life.

All illustrations and specifications contained in this literature are based on the latest product information available at the time of publication approval. The right is reserved to make changes at any time without notice in prices, colors, materials, equipment, specifications and models, and also to discontinue models.