

1965  
CORVETTE  
STING RAY

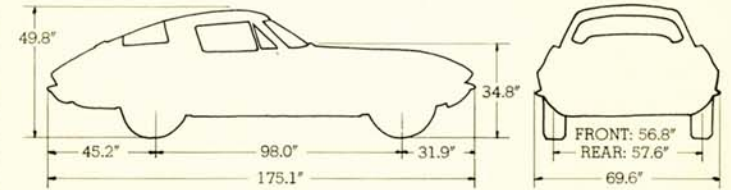



We think it's unwise to just tinker with an American classic like the Corvette Sting Ray. Changes should be meaningful. This fine road machine was and still is America's only true sports car. So for 1965, Sting Ray underwent subtle refinements in styling that only enhance its unique looks. And performance, always a basic measure of Sting Ray's appeal, has been improved still further. A new "street" engine develops 350 horsepower and answers most enthusiasts' needs for traffic and highway driving. The two top V8 power plants offer 365- and 375-horsepower for those who specify all-out go. Best of all, the Sting Ray now has Sport-Master disc brakes on all four wheels that naturally complement the tremendous performance capabilities of



External dimensions, Sport Coupe

**this is a  
different  
kind of car...**

**BODY:** Styling changes for the 1965 Sting Ray are simple and effective. A smooth hood without depressions or distractions in the contour. New louvers behind the front wheels that help increase air flow through the engine compartment. A new grille with three black horizontal bars highlighting the center of the grille. New body sill moldings of bright aluminum. These changes only serve to refine what is aerodynamically one of the more efficient cars in the world.

Both Sting Ray models, Sport Coupe and Convertible, use the same one-piece underbody. The Convertible uses 31 fiber glass panels, the Sport Coupe 35. Where rivets can be exposed, the fiber glass parts are riveted to the metal framework; elsewhere, a bonding strip of fiber glass is riveted to the framework and the fiber glass is bonded to this. Sport Coupe bodies are attached to the chassis at six points with rubber "biscuit" mounts, the Convertible at four points.

In comfort and livability, the Sting Ray hasn't changed. Twin retracting headlamps, 3-speed ventilation blower in the Sport Coupe, the wrap-over doors in the Sport Coupe for easy entry and exit, wrap-around bumpers, compound

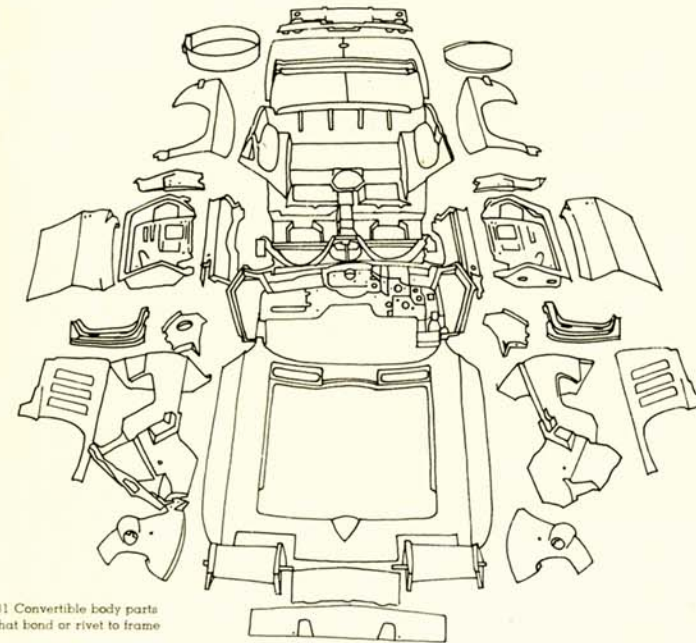

31 Convertible body parts that bond or rivet to frame

the car. The '65 Sting Ray stops smoothly, surely and firmly with braking reserve far beyond normal requirements. More than ever the Corvette Sting Ray is luxurious transportation for two, a different kind of driving experience.

*A wide range of extra-cost Options and Custom Features is offered for the Sting Ray to fit individual tastes. The illustrations and text of this catalog present some of them; pages 12 and 14 list the options for your convenience.*

**a true  
all-American  
sports car...**

curved side windows, 2-speed electric windshield wipers, weather-shielded door locks and separate tire storage space—these and many others are standard conveniences.

There's still the pleasant task of selecting a Sting Ray from two body styles—and three choices in accommodation. The Sport Coupe is a roomy, tightly unified, enclosed model. The Convertible offers either the folding soft top or a removable hard top. (Many people order both tops, for summer convenience and winter snugness.) The soft top folds completely away and disappears

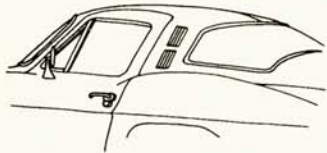

Sport Coupe

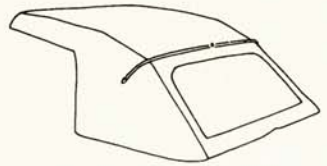

Soft top

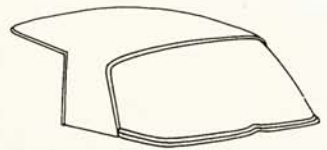

Hard top

**designed for  
enthusiastic  
driving...**

beneath a cover behind the seats. Pictured on this page are the three "birdcage" frameworks that form the basis of the Sting Ray's fiber glass reinforced plastic body. Each framework gives structural strength to the body, backs up the plastic panels, provides firm attachment points for door hinges and locks, and adds firmness to the entire structure.

The result of this method of construction is a very solid structure with light weight, freedom from corrosion, ease of repairs, high impact resistance, and general longevity.

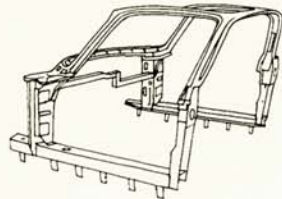

Sport Coupe framework

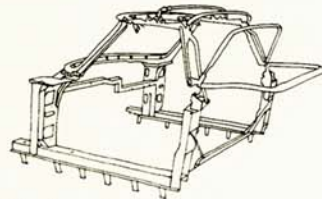

Soft top framework

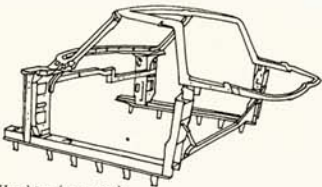

Hard top framework

**FINISH:** Six sparkling new colors complement the popular Tuxedo Black and Ermine White for Sting Ray in 1965. They are Silver Pearl, Rally Red, Milano Maroon, Nassau Blue, Goldwood Yellow and Glen Green. Magic-Mirror acrylic lacquers are standard on all Sting Rays because of the very high resistance of the finish to fading, staining, chalking and chipping. Minor damage can be refinished

**built for  
the rigors of  
the road...**

without the necessity of re-doing entire panels. The folding top for the Convertible is available in black, white, beige, in combination with any exterior color.

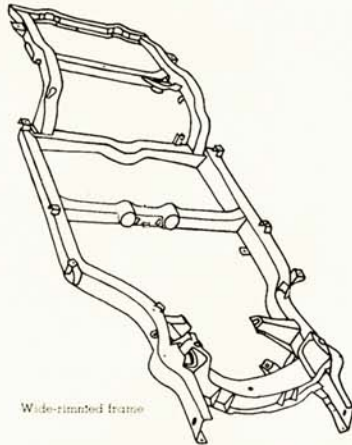

Wide-shouldered frame

**CHASSIS:** Sting Ray's broad-shouldered frame ties all the working components of the car properly together. Frame rails are spaced widely apart to allow the seats to be positioned between them, contributing to a lower height for the car and a lower center of gravity. And the Sting Ray chassis, with its independent suspension at all four wheels, has the weight distributed for superb balance and handling. With a greater rearward weight distribution (approximately 47/53%), traction is improved by increasing the weight on the driving wheels. Braking is improved under the most severe conditions; and steering effort is reduced by the reduction of load on the front wheels.

**FRONT SUSPENSION:** The Sting Ray's independent front suspension uses variable-rate coil springs to give soft and gentle action on tiny bumps while maintaining firm control for the more rigorous ones. Front-end "dive" under braking is controlled by a sophisticated front suspension design that gives impeccable handling and a ride that suits either the boulevard or the countryside.

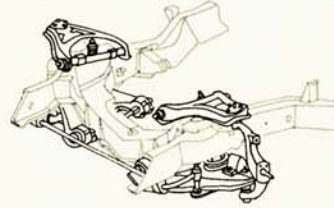

Front suspension

**REAR SUSPENSION:** The fully independent rear suspension of the Corvette Sting Ray allows much finer ride control to be built into the car. Each of the rear wheels can react to changes in road surface individually without affecting the other wheel. And without the weight of the differential suspended between the rear wheels (it's mounted on the frame), reaction of the wheels

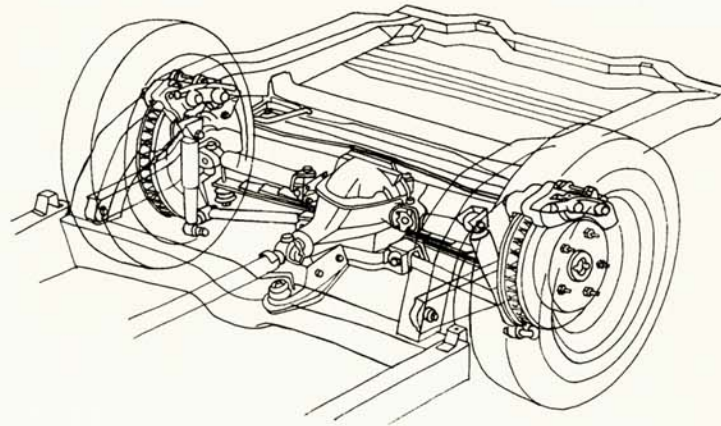

Rear suspension

**able to  
handle  
any kind of  
terrain...**

is quicker and smoother. Thus, road-holding is improved markedly, and "axle tramp," wheel-lifting under acceleration, and torque steering are virtually eliminated.

The major components of the rear suspension are a strut rod from wheel hub to differential case, a torque control arm from hub to frame, and the tubular axle shaft (double universal-jointed) from differential to wheel spindle. Springing is handled by a 9-element variable-rate transverse leaf spring. The system holds tread and camber changes to a minimum, and all driving and braking loads are distributed properly to the frame.

**STEERING:** A combination of excellent balance and low-friction spherical joint suspension components gives the 1965 Corvette Sting Ray steering that is highly responsive and precisely accurate. And a provision for faster steering is included as standard equipment. A new adjustable steering wheel can be ordered—lets you move the wheel away or pull it closer, through an adjustable range of three inches, without leaving the driver's seat. Power steering can be ordered also. The standard steering gives a ratio of 20.2:1; the faster steering is 17.6:1. Power steering uses the same ratio as the fast steering provision.

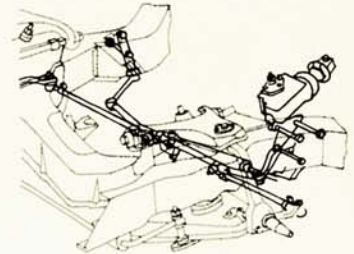

Steering system

*Looking for those specific touches that will make a new Sting Ray fit your desires exactly? Check the extra-cost Options and Custom Features on pages 12 and 14, some of which are presented in the text and illustrations elsewhere in this catalog.*

**gripping,  
cornering,  
steering  
beautifully...**

**STABILIZERS:** For flatter cornering and better handling, a stout stabilizer bar (0.687-inch diameter) is fitted to the front suspension of the Sting Ray. The bar is rubber-isolated to control harshness and give it a smoother effect. For special performance purposes, a heavier (0.94-inch) stabilizer bar is available as a part of the special front and rear suspension package.

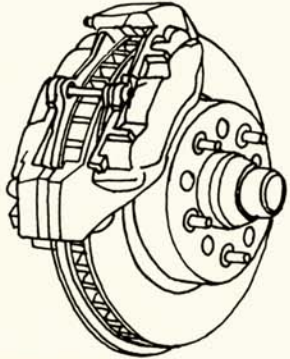

Left front brake unit

**BRAKES:** For 1965, the Sting Ray has Sport-Master disc brakes at all four wheels, the greatest improvement in Corvette braking power since the inception of the Sting Ray design. These new disc brakes are hydraulic, caliper type and give amazingly smooth, sure stops. Virtually fade-free, Sport-Master disc brakes constantly keep themselves clean, dry and in adjustment under all road conditions. During maximum braking from higher speeds, 65% of the braking action occurs at the front wheels, 35% at the rear

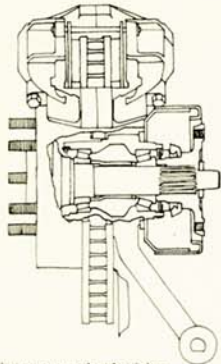

Rear brake linings on each side of disc

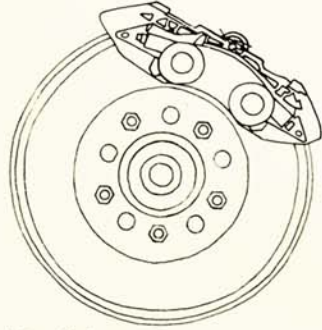

Left rear brake unit

wheels—to balance forward weight shift. Brake discs are cast iron, 11.75 inches in diameter and finned internally for maximum cooling. Brake force is applied equally to each side of the disc by woven asbestos linings, 86.3 sq. inches in total area and bonded to the brake shoes. The rear parking brakes are an independent mechanical system consisting of brake shoes, riveted linings and a smaller internal-type drum. Conventional self-adjusting Safety-Master brakes can be specified, if desired, in place of Sport-Master disc brakes.

*In order to provide the maximum satisfaction for personal tastes, a full line of Options and Custom Features is available for the Sting Ray at extra cost. These are presented in illustrations and text throughout the catalog, and listed for your convenience on pages 12 and 14.*

**with strictly  
a new kind  
of sports  
car ride...**

**with strictly  
sports car  
handling and  
control.**

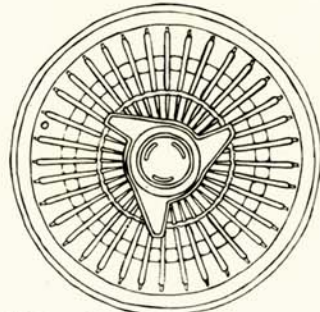

Wide-base aluminum wheel

**WHEELS AND TIRES:** New wheel covers highlight the 1965 Sting Ray, simulating cast magnesium racing wheels with knock-off hubs. Cast aluminum wheels can be specified with wide-base six-inch rims, pin drive, and genuine knock-off type hubs. Standard wheels are 15 x 5.5K welded steel slotted disc type with 7.75 x 15 tires.

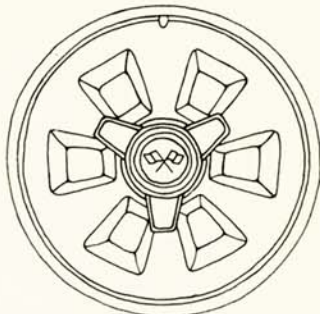

Standard wheel cover

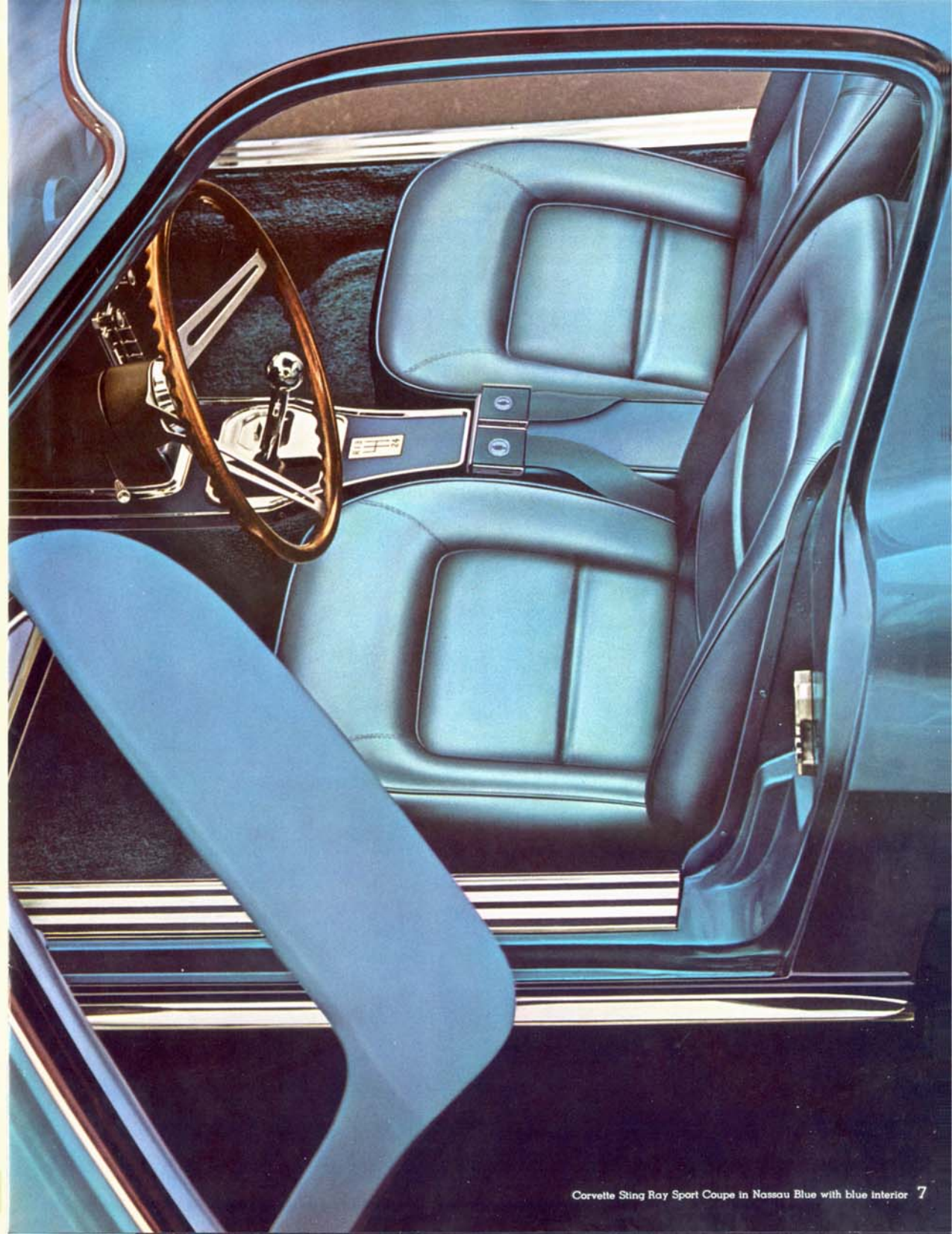



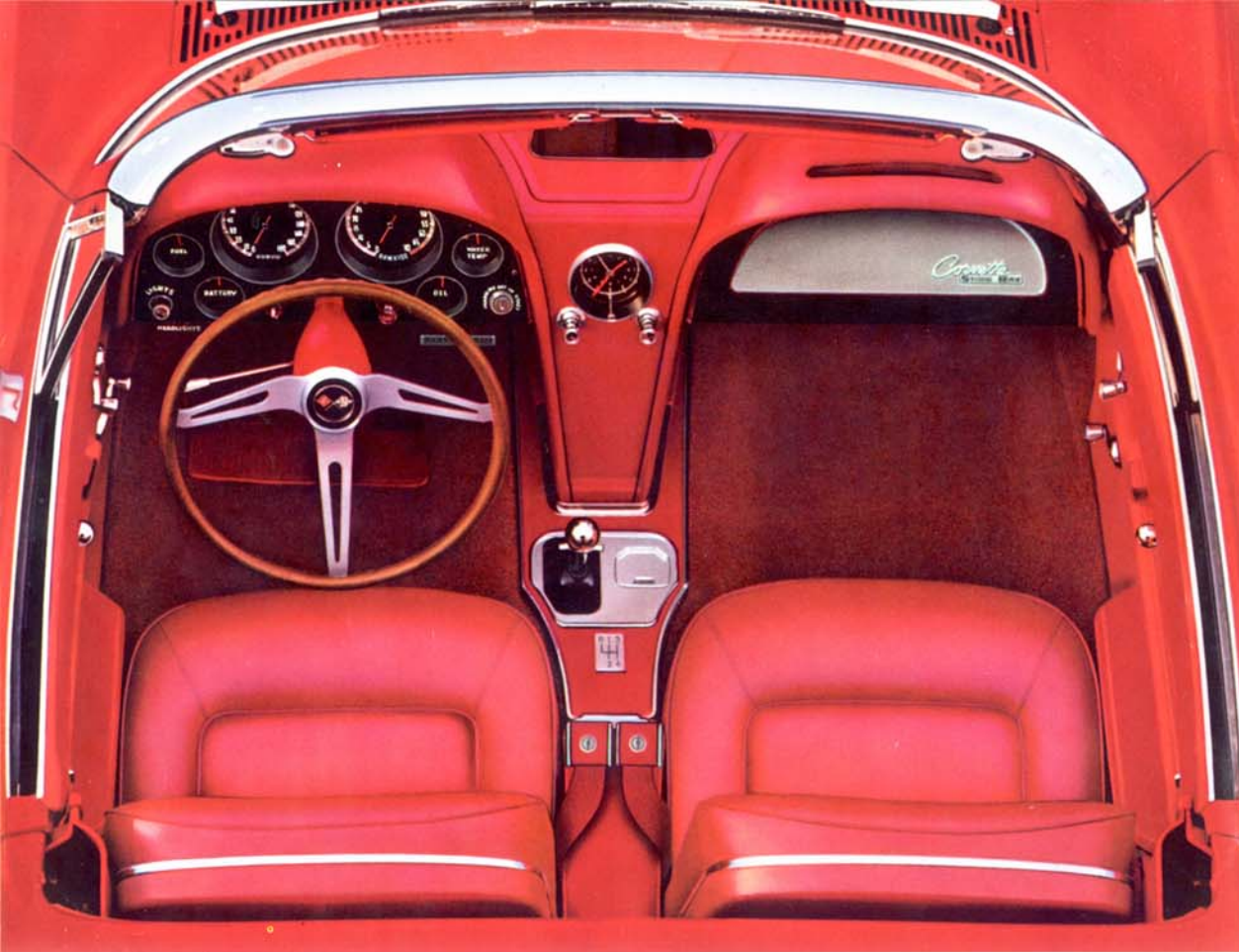

Corvette Sting Ray Convertible with red interior



Retractable headlights



4-Speed manual transmission



Standard wheel cover



Convertible soft top



Outside rearview mirror



Sport Coupe luggage space

**ELECTRICAL SYSTEM:** The electrical system of the Sting Ray is based on the powerful 12-volt Delcotron diode-rectified air-cooled generator. A transistor ignition system can be ordered which provides electronic ignition control rather than mechanical. A flashing red warning lamp warns if the electrically operated retracting headlamps have been left on after retraction; a similar warning light is supplied for the hand brake. The wiring system itself is color-coded for ease of maintenance. Ignition system components are shielded in radio-equipped cars to prevent interference. Accessories are fused except for the headlamps and parking lamps; these have circuit breakers rather than fuses.



S-wire spring construction

**INTERIOR:** A true sports car in every sense, the Sting Ray still offers a completely luxurious driving environment. For 1965, the interior features new trim of durable

**yet this car is plush, convenient...**

expanded vinyl with a more subtle texture. Two new interior colors, maroon and green, and striking two-tone combinations of silver/black, white/black, white/red and white/blue complement the other choices of black, red, blue and saddle. Genuine leather upholstery is available for 1965 Corvettes in all of these colors.

The individual bucket-type seats are of "S-wire" spring construction, and have a new bolster-like design for more seating comfort and better lateral support. Both seats are adjustable fore and aft through a range of four inches. New molded panels covering the back of the seats offer protection against scuffing. Carpet for the 1965 Sting Ray is molded to shape for better fit, a more finished appearance and fewer seams. The luggage compartment is completely carpeted; and an under-the-floor storage compartment tucks valuables out of sight. Interior door panels are of a new molded construction; the armrest is integral with the panel and the door pull-handle is separate. Dual sun visors are standard.

Controls for the outside-air-type heater and defroster are located on the central console along with the electric clock and radio controls; vent controls are located under the instrument panel on each side of the steering column.

Matched speedometer and tachometer are the primary instruments in the Sting Ray. Supplementing these are an electric fuel gauge, electric coolant temperature gauge, ammeter, and an oil pressure gauge. A re-settable trip odometer, headlight switch, cigarette lighter, headlamp retractor switch, hood release, and four-position ignition switch complete the instrument panel. On

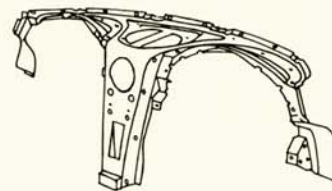

Instrument panel construction

the passenger side, a built-in passenger assist grip is part of the instrument panel hood. The new ignition switch makes it impossible to remove the ignition key from the lock except when the switch is in the "off" or locked position.

DIMENSIONS (in inches)	Sport Coupe	Convertible
Torso	37.0	38.5
Leg	42.7	42.7
Hip	50.9	50.9
Shoulder	48.4	48.4
Entrance room	31.4	30.2

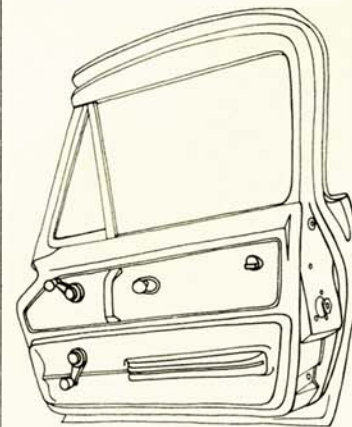

Sport Coupe door

*Options and Custom Features to personalize the Sting Ray precisely to customers' wishes are available at extra cost. Some of them are presented throughout this catalog in illustrations and in text. A listing of them will be found on pages 12 and 14.*

**loaded with creature comforts...**

# does it go? with a certainty...

**ENGINES:** Five great powerhouses supply the performance for any kind of Corvette go the owner desires. The successful 327-cubic-inch five-main-bearing V8, rated at 250 horsepower, is standard. This engine gives sprightly around-town performance and cruises at highway speeds at no more than an easy loaf. Any of four other big V8s can be ordered: a 300-hp version that provides more go without sacrificing any tractability; a new 350-hp engine that gives near all-out performance while remaining perfectly at ease in stop-and-go traffic; and two high-performance engines with top horsepower for '65: the 365-hp engine and the 375-hp Ramjet Fuel Injection engine that extract the last full measure of performance from the husky 327.

New cylinder heads with bigger inlet valves are featured for the standard engine. The 250-, 300-, and 350-horsepower versions use hydraulic valve lifters; the 365 and 375 have mechanical lifters. The latter three engines require six quarts of lubricant (including oil filter), the 250- and 300-hp engines

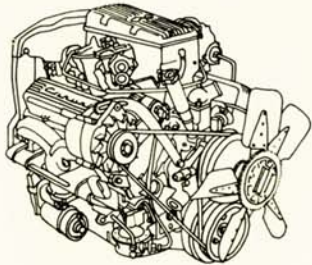

327-cubic-inch V8 engine

five. All engines have 19-quart-capacity cooling systems. Modern thin-wall casting techniques enable Chevrolet to offer this large displacement in an engine that still maintains a relatively low over-all weight (starting at 575 lbs. for the standard engine with fly-wheel, minus clutch and pressure plate). Extensive use of aluminum components (radiator and expansion tank, transmission case, etc.) also helps keep total weight low. Other engine features include wedge-type combustion chambers; controlled-pressure lubricating system with full-flow oil filter; pressurized cooling system with high-capacity water pump; long-life dual exhaust system; and fuel systems tailored to individual engines.

4-Speed manual transmission

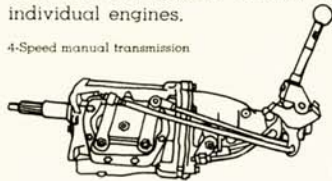

## STING RAY POWER TEAMS

ENGINE BORE & STROKE	HORSEPOWER & TORQUE	INDUCTION SYSTEM	C.R.	CAM & LIFTERS	TRANS. MISSIONS	AXLE RATIOS		
						STD.	POSI-TRACTION	
STANDARD ENGINE								
327 cu. in. V8	250 @ 4400	4-BBL Carburetor	10.5:1	General Purpose	3-Speed 2.58:1 first	3.36:1	3.36:1	
4.00 x 3.25 in.	350 @ 2800	Dual-Intake Air Cleaner			4-Speed 2.56:1 first	3.36:1*	3.08:1	3.36:1
					Powerglide	3.36:1	3.36:1	

## EXTRA-COST OPTIONAL ENGINES

327 cu. in. V8	300 @ 5000	Large 4-BBL Carburetor	10.5:1	General Purpose	4-Speed 2.56:1 first	3.36:1*	3.08:1
4.00 x 3.25 in.	360 @ 3200	Dual-Intake Air Cleaner			Powerglide	3.36:1	3.36:1
327 cu. in. V8	350 @ 5800	Special 4-BBL Carburetor	11.0:1	General Purpose	4-Speed 2.20:1 first	3.70:1	3.08:1
4.00 x 3.25 in.	360 @ 3600	High-Flow Air Cleaner					3.36:1
							3.55:1
							4.11:1
							4.56:1
327 cu. in. V8	365 @ 6200	Special 4-BBL Carburetor	11.0:1	Special Purpose	4-Speed 2.20:1 first	3.70:1	3.08:1
4.00 x 3.25 in.	350 @ 4000	High-Flow Air Cleaner					3.36:1
							3.55:1
							4.11:1
							4.56:1
327 cu. in. V8	375 @ 6200	Ramjet Fuel Injection	11.0:1	Special Purpose	4-Speed 2.20:1 first	3.70:1	3.08:1
4.00 x 3.25 in.	350 @ 44-4800	Special Air Cleaner					3.36:1
							3.55:1
							4.11:1
							4.56:1

\*3.08:1 Performance Cruise axle ratio can be specified.

**TRANSMISSIONS:** The Sting Ray line-up of transmissions lets you gear up to just the kind of driving that suits you best. The proven 3-Speed manual transmission is the standard gearbox. You can order the smooth and easy Powerglide with a new straight-line shift pattern for more direct shift selection if you prefer. Or specify a 4-Speed manual transmission for a wider selection of manual gears.

# on power trains precision- engineered...

All are floor-mounted with shift levers in the console. The 4-Speed has a lockout to help prevent inadvertent shifting to reverse gear. Check the power team chart for the availability of engine and transmission combinations.

In the 3-Speed, second and third gears are synchronized; in the 4-Speed, all forward gears are synchronized. The automatic Powerglide transmission has a 2-speed planetary gear set and a 3-element torque converter.

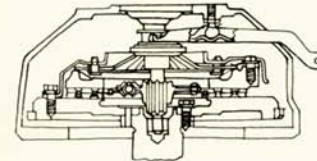

Clutch cutaway

**CLUTCH:** Sting Rays fitted with manual transmissions have a special clutch action that gives velvet-smooth engagement with low pedal pressure, minimum effort for the driver and quick response. The clutch action is firm and sure, yet easy to manage for gentle starts. The dry disc clutch is of the centrifugally assisted diaphragm spring type with a driven disc diameter of 10 inches and an area of 90.7 square inches. Effective plate pressure is 2100-2300 lbs. Release bearing has sealed-in lubricant.

**DIFFERENTIAL:** Part of the reason for the Sting Ray's great ride and handling is the location of the differential and final drive gear assembly. Mounted on the frame—a design feature possible with the Sting Ray's independent rear suspension—the differential reacts to bumps in conjunction with the body, not the wheels, for much smoother going. This also helps the engine put all its power onto the ground, particularly when Positraction is ordered with the car. A wide range of rear axle ratios is available for the Sting Ray, as shown in the power team chart on the opposite page. These ratios give approximate speeds in the following range:

# on power trains picked for flexibility...

MPH X RPM, AVAILABLE AXLE RATIOS  
(Figures are estimated, with no allowance for slippage or tire expansion.)

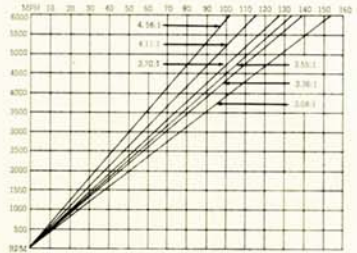

MILES PER HOUR PER 1000 ENGINE RPM IN FINAL DRIVE  
(Figures are estimated with no allowance for slippage or tire expansion)

- 3.08:1 = 25.6
- 3.36:1 = 23.1
- 3.55:1 = 22.2
- 3.70:1 = 21.3
- 4.11:1 = 19.2
- 4.56:1 = 17.0

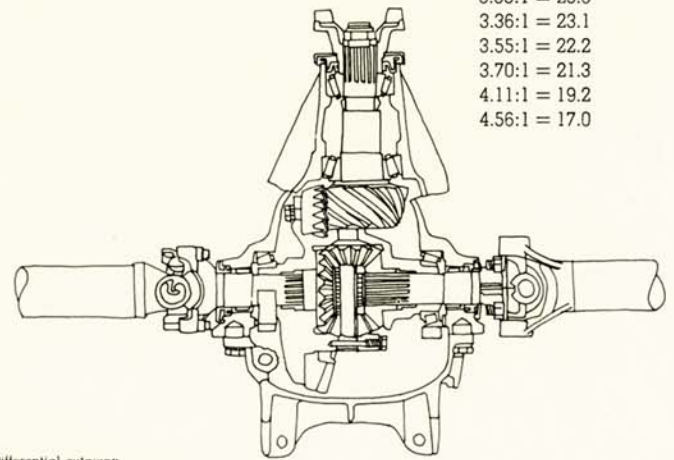

Differential cutaway

# on power trains test-track & street proven...

**SHOCK ABSORBERS:** Sting Ray shock absorbers are direct double-acting hydraulic type especially designed to fulfill the combined needs of soft ride and firm handling. Special freon-filled bags are enclosed in each shock absorber to help maintain proper action during extreme use.

To assure that your new Sting Ray is exactly right for your particular requirements, a complete line of Options and Custom Features is available at extra cost. They are described on pages 12 and 14, and some of them are presented throughout the text and illustrations of this catalog.

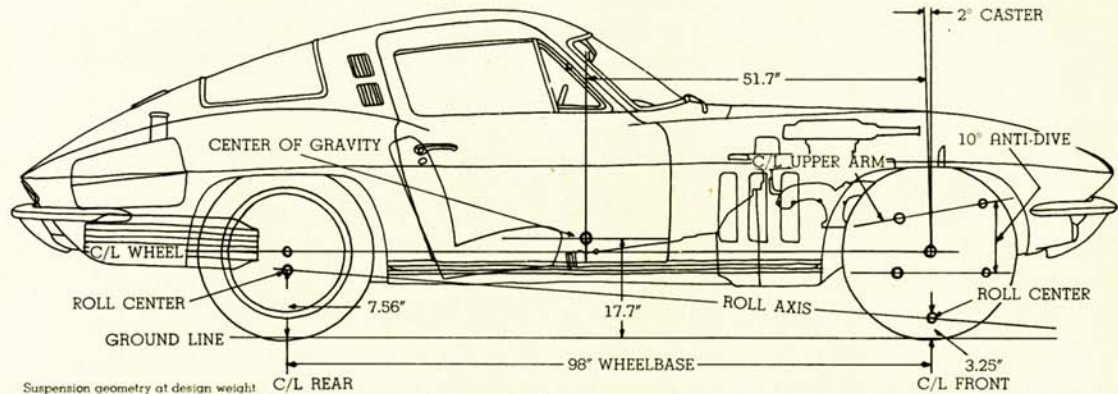

Suspension geometry at design weight

**DESIGN CONCEPT:** The key to Sting Ray's roadability and handling lies in its 4-wheel independent suspension and its greater rearward weight distribution. Chevrolet engineers chose the fully independent suspension so that optimum use could be made of the great power available. The rearward weight distribution makes it possible to achieve excellent handling and still maintain an acceptably gentle ride. The major vehicle masses—the heavier components of the Sting Ray—are located so that the suspension and steering systems can work with the design, rather than having to compensate for imbalance. The Sting Ray has been basically *right* from its original concept. Constant refinement and continual development have gone forward to make the 1965 Corvette Sting Ray more than ever one of

**from  
rubber  
to roof, a  
sports car...**

the most deeply satisfying driving experiences available in the world.

**EXTRA-COST  
OPTIONAL EQUIPMENT**

The following equipment, shown previously in illustrations or described in the text, is available at extra cost for the Corvette Sting Ray. These options add driving pleasure, or prepare the car for special uses. They allow the Sting Ray owner to equip his car to his own particular tastes.

**CHASSIS:** Heavy-duty suspension. (Rear spring rate: 305 lb./in. Rear shock absorbers: 1 3/4 in. Front spring rate: 550 lb./in. Front shock absorbers: recalibrated. Stabilizer bar: 0.94-inch diameter.) Positraction; power brakes; telescopic steering column; power steering; optional axle ratio; nylon tires; white-wall tires; cast aluminum wheels with wide-base six-inch rims and knock-off hubs.

**ENGINE:** Off-road service exhaust system; exposed, side-mounted exhaust system; 36-gallon fuel tank (Sport Coupe only). (Note: when 36-gallon fuel tank is fitted, luggage compartment is partially carpeted); transistor ignition and voltage regulator; 300-horsepower engine; 350-horsepower engine; 365-horsepower engine; 375-horsepower Ramjet Fuel Injection engine.

**TRANSMISSION:** 4-Speed; 4-Speed close ratio; Powerglide.

**BODY:** Soft-Ray tinted glass; back-up lights and non-glare inside rear-view mirror; Four-Season air con-

ditioning; genuine leather seat upholstery; wood-rimmed steering wheel; electric windows; AM/FM pushbutton radio with remote control power antenna; removeable hard top. (Convertible only. You can, however, specify either hard top or soft top at no extra cost—or order both with hard top at extra cost.)

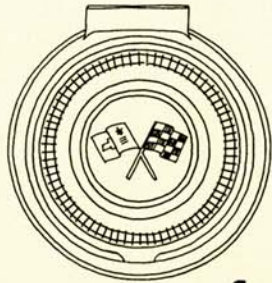

Gas filler door emblem

**for  
performance  
-and  
style-minded  
individuals.**



Corvette Sting Ray Convertible with removable hard top in Glen Green  
Shown on back cover. Corvette Sting Ray Convertible in Goldwood Yellow 15



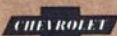

All illustrations and specifications contained in this literature are based on the latest product information available at the time of publication approval. The right is reserved to make changes at any time without notice in prices, colors, materials, equipment, specifications and models, and also to discontinue models.

Chevrolet Motor Division, General Motors Corp., Detroit, Michigan.

Litho in U.S.A.