

1962

CHEVROLET TRUCK
ENGINEERING FEATURES

1962 CHEVROLET TRUCK ENGINEERING FEATURES



CHEVROLET ENGINEERING CENTER



ENGINEERING PRODUCT INFORMATION DEPARTMENT
WARREN, MICHIGAN • SEPTEMBER, 1961

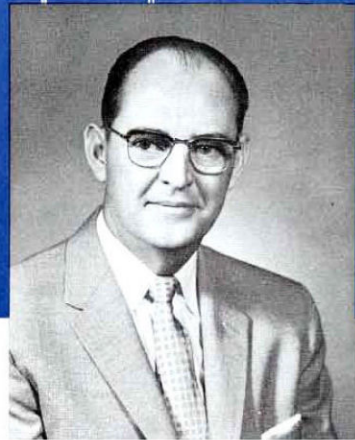
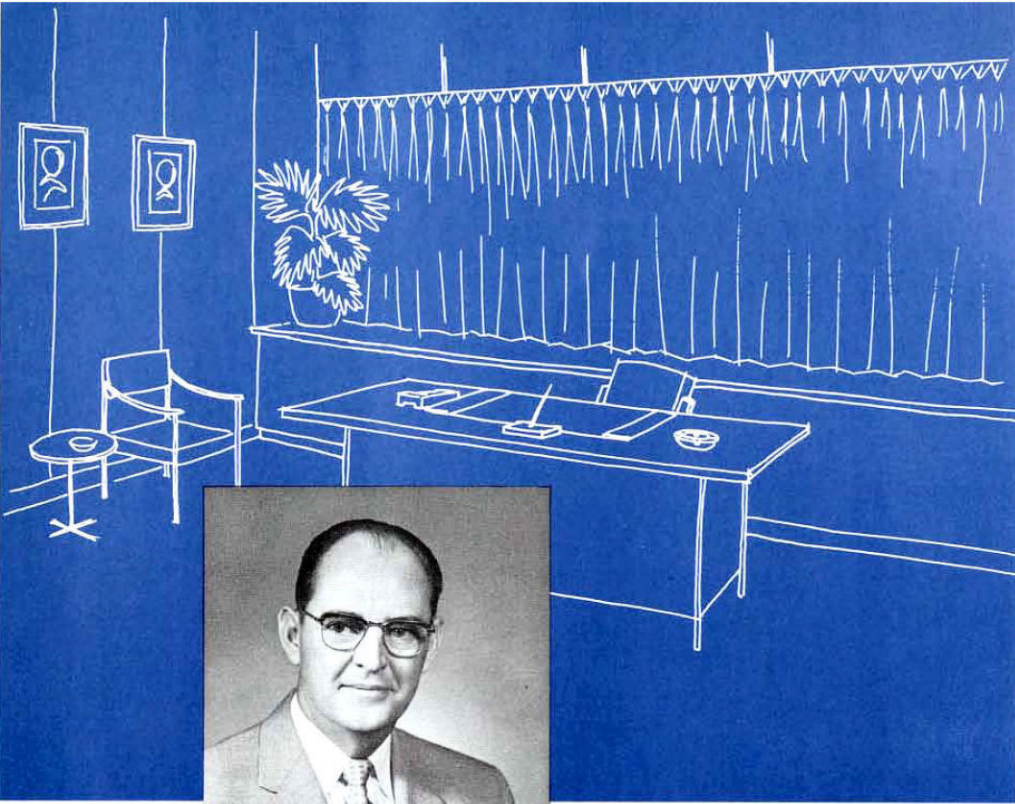

HARRY F. BARR / CHIEF ENGINEER



FOREWORD

The truck line for 1962 is designed to maintain the traditional Chevrolet high level of customer satisfaction and competitive supremacy.

Besides the many important improvements made in mid-season 1961, the new truck program offers expanded model line-up and power team availability, new body and styling features, and significant new chassis and engine refinements. Option availability is revised for greater versatility.

The following pages detail all changes for the coming model year, including the new diesel engine units.

THE 1962 CHEVROLET TRUCK

The truck program for 1962 includes an enhanced appearance factor, numerous chassis refinements, and expanded power train availability. The most important aspect, however, is represented by the 203 individual models which comprise the largest line-up in Chevrolet's history. Newcomers to the line include 20 new diesel engine powered vehicles in the 60 and 80 Series, school bus model S6902, and six Series C36S models with a special 3/4-ton rating. All previously available units are released for the coming year with the exception of the entire Series 70 which is cancelled. The former M70 models, however, are transferred to the 80 Series.

Conventional models feature styling revisions important both from the standpoint of identification and utility. The greater slope of the new hood design increases driver forward visibility to the ground by as much as 10-1/2 feet. Radiator grilles are restyled for all conventional models and include the single headlamp treatment. Other changes provide for new series designation plates, six new exterior colors, a new two-toning method, and new interior colors and seat trim.

Both the Corvair 95 and conventional line cabs and bodies are basically unchanged from the previous design. Several notable refinements, however, contribute to product improvement. Typical of these is the availability of directional signals as standard equipment for all models but the Step-Vans; the use of improved body mounts in most conventional model applications; new seat cushion construction for Custom cabs; improved Corvan side door locking; a new Suburban seat and window option; a new single passenger seat option for the Corvan; and an accessory sliding rear window for cabs. Tilt-cabs are now equipped with an adjustable torsion bar for improved tilting action.

The chassis program provides further improvements in the interest of greater durability and versatility. Independent front suspensions are continued unchanged. However, two optional I-beam suspensions of 9000 and 11,000 pound capacity are available for certain 80 Series models. New 17,000 pound capacity rear axles, both single and 2-speed, are offered for Series 60 models. Improved front wheel piloting on Series 10-30 models minimizes transmittal of road shocks to the body. Longer frame outer reinforcements and relocated torsion bar rear anchors improve durability of certain Series 50, 60, and 80 models.

Expanded power teams provide the conventional line with a more complete coverage of power requirements. Four new engines are offered, including two new V-8 gasoline units of 327 and 409 cubic inch displacement and two diesel engines of 4 and 6-cylinder design. Also featured are improvements to the 348 cubic inch gasoline engine, extended applicability of the 261 cubic inch engine, and a new identification system. The 283 cubic inch Taskmaster and 348 cubic inch Workmaster Special are discontinued. The exhaust systems of all engines for 1962 are equipped with extended life mufflers, and a new Delcotron generating system is available for all models. Three new transmissions are added to the line-up: a 4-speed auxiliary for tandems and two 5-speeds for diesel engine models.



CONTENTS

model line-up	9
styling	17
body	29
chassis	39
power teams	47
diesel models	61
mid-season 1961 changes	71
appendix	77
index	82

*A line-up of 203 models, the largest ever,
is designed to anticipate the requirements
of an ever-growing and ever more diversified
trucking industry.*

THE 1962 CHEVROLET TRUCK

model line-up



Truck design must keep pace with an increasingly complex market. The trend today, in certain applications, is to diesel power. The 1962 Chevrolet program provides a line-up of 203 models on 19 wheelbases. Of these, 10 are new diesel cab-chassis models in the medium-duty category and 10 are heavy-duty vehicles. Other additions include six new 3/4-ton Special units and one new school bus chassis. All Series 70 vehicles are discontinued, with the tandem axle models transferred to the 80 Series.



The new diesel models are identified with new series prefixes. D60 models are comparable to C60 units, with minor body and chassis revisions to accommodate the engine. E80 models utilize new sheet metal and a cab similar to L80 models but approximately five inches higher. U80 vehicles are similar to T80 models, but the cab is approximately six inches higher.

Several changes are made in maximum GVW ratings. Series 60H models are upgraded to 23,000 pounds, Model S6702 to 23,000 pounds, and Series K25 models to 7600 pounds.

GVW ratings of the new diesel engine units are identical to their gasoline engine counterparts. New Model S6902 is rated at 23,000 pounds and the new Series C36S models are rated at 7800 pounds.

The GCW rating for Series 60H models is raised to 42,000 pounds.



VEHICLE TYPE	LIGHT-DUTY				MEDIUM-DUTY			HEAVY-DUTY		TOTAL	
	1/2-TON	3/4-TON	3/4-TON SPECIAL	1-TON	1-1/2 TON	1-1/2 TON SPECIAL	2-TON	2-TON HEAVY-DUTY	2-1/2 TON		
CORVAIR 95 PANEL	R1205 (CORVAN)									1	
CORVAIR 95 PICKUPS	R1244 (LOADSIDE) R1254 (RAMPSIDE)									2	
STEPSIDE PICKUP	C1404 C1504 K1404 K1504	C2504 K2504	C3604S	C3604						8	
FLAT FACE COWL	C1402	C2502	C3602S	C3602	C4102 C4302	C5102S C5202S C5302S C5502S C6102S C6302S C6502S	C5102 C5202 C5302 C5502 C6102 C6302 C6502	C6102H C6302H C6502H		23	
WINDSHIELD COWL	C1412	C2512	C3612S	C3612	C4112 C4312	C5112S C5212S C5312S C5512S C6112S C6312S C6512S	C5112 C5212 C5312 C5512 C6112 C6312 C6512	C6112H C6312H C6512H		23	
LCF CAB CHASSIS						L5203S L5303S L5603S L6103S L6203S	L5203 L5303 L5603 L6103 L6203	L6103H L6203H L6303H L6603H L6903H	E8103 E8203 E8303 L8303 L8603	28	
TILT-CAB CHASSIS						T6203S T6303S T6603S T6803S	T6203 T6303 T6603 T6803	T6203H T6303H T6603H T6803H	U8203 U8303 T8203 T8303 T8803 T8603	18	
CONVENTIONAL CAB CHASSIS	C1403 C1503 K1403 K1503	C2503 K2503	C3603S	C3603	C4103 C4303	C5103S C5203S C5303S C5503S C6103S C6203S C6303S	C6503S C6803S D6103S D6203S D6303S D6503S D6803S	C5103 C5203 C5303 C5503 C6103 C6203 C6303	C6503 C6803 D6103H D6203H D6303H D6503H D6803H	C8103 C8203 C8303 C8503 C8803	53
FLEETSIDE PICKUP	C1434 C1534 K1434 K1534	C2534 K2534								6	
PANEL	C1405 K1405		C3605S	C3605						4	
SUBURBAN CARRYALL	C1406 K1406 K1416 K1416									4	
CONVENTIONAL STAKE		C2509	C3609S	C3609	C4109 C4309	C5109S C5309S	C5109 C5309			9	
LCF STAKE						L5309S	L5309			2	
TANDEM									M8303 M8503 M8803	3	
SCHOOL BUS							S5302 S6202 S6402 S6702 S6902			5	
FORWARD CONTROL	P1342	P2342 P2542 P2642		P3342 P3542 P3642						7	
STEP-VAN	P1345	P2345 P2545 P2645		P3345 P3545 P3645						7	
TOTAL	25	15	6	12	8	43	48	25	21	203	
	58				99			46			

NOMINAL RATING	SERIES	WHEELBASE	MAXIMUM GVW	GCW
1/2-TON	R12	95	4,600	
	C14	115	5,200	
	C15	127	5,400	
	P13	102	5,400	
	K14	115	5,600	
3/4-TON	K15	127	5,600	
	P23	104	7,000	
	P25	125	7,000	
	P26	137	7,500	
	C25	127	7,500	
3/4-TON SPECIAL	K25	127	7,600	
	C36S	133	7,800	
1-TON	P33	104	10,000	
	P35	125	10,000	
	C36	133	10,000	
1-1/2 TON	P36	137	10,000	
	C41	133	14,000	
1-1/2 TON SPECIAL	C43	157	14,000	
	C51S, L52S	133	15,000	25,000
	C52S, L53S	145	15,000	25,000
	C53S	157	15,000	25,000
	C55S, L56S	175	15,000	25,000
	T62S	97	15,000	25,000
	T63S	109	15,000	25,000
	L61S	121	15,000	25,000
	C61S, L62S	133	15,000	25,000
	D61S, T66S	133	15,000	25,000
	C62S, L63S	145	15,000	25,000
	D62S, T68S	145	15,000	25,000
	C63S, D63S	157	15,000	25,000
	C65S, L66S, D65S	175	15,000	25,000
	C68S, L69S, D68S	197	15,000	25,000
2-TON	S53	157	16,000	
	C51, L52	133	16,000	32,000
	C52, L53	145	16,000	32,000
	C53	157	16,000	32,000
	C55, L56	175	16,000	32,000
	T62	97	16,000	32,000
	T63	109	16,000	32,000
	L61	121	16,000	32,000
	C61, L62, D61, T66	133	16,000	32,000
	C62, L63, D62, T68	145	16,000	32,000
	C63, D63	157	16,000	32,000
	C65, L66, D65	175	16,000	32,000
	C68, L69, D68	197	16,000	32,000
	S62	197	21,000	
	S64	225-1/2	21,000	
S67	243	23,000		
S69	261-1/2	23,000		
2-TON HEAVY-DUTY	T62H	97	23,000	42,000
	T63H	109	23,000	42,000
	L61H	121	23,000	42,000
	D61H, C61H, L62H, T66H	133	23,000	42,000
	D62H, C62H, L63H, T68H	145	23,000	42,000
	D63H, C63H	157	23,000	42,000
	D65H, C65H, L66H	175	23,000	42,000
	D68H, C68H, L69H	197	23,000	42,000
2-1/2 TON	T82, U82	97	25,000	51,000
	T83, U83	109	25,000	51,000
	L81, E81	121	25,000	51,000
	C81, L82, E82, T86	133	25,000	51,000
	C82, L83, E83, T88	145	25,000	51,000
	C83	157	25,000	51,000
	C85, L86	175	25,000	51,000
	C88	197	25,000	51,000
	M83	157	36,000	51,000
	M85	175	36,000	51,000
M88	193	36,000	51,000	

Increased customer emphasis on truck styling demands exacting standards of appearance. These standards are exhibited in the marked styling changes which sharpen the appeal of the 1962 models — eye-catching trademarks; forward-slope hood panel that deepens road view; distinctive radiator grilles; six new exterior colors; harmonious seat trim patterns and interior colors.

THE 1962 CHEVROLET TRUCK

styling

NEW HOOD DESIGN ●

NEW SERIES PLATES ●

SIX NEW COLORS ●

REDESIGNED GRILLES ●

NEW SEAT TRIMS ●

styling

A distinctively-styled hood panel lends a totally new appearance to conventional line models, both from the front and side. Considerably lower at the front, the new panel affords increased forward visibility to the ground.

Two openings between the parking lights on the hood front face supplement the provisions for radiator core air supply. The parking light bezels are of silver-anodized aluminum.



Single lamps at the center of embossed headlamp doors and a grille insert in the air intake area are featured for the new Series 10-40 radiator grille. The assembly is painted Cameo White, while the lettering is Jet Black.

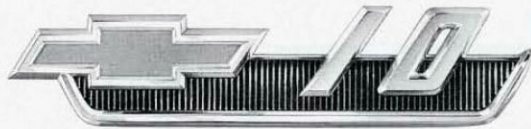

The new-design series nameplates for C-K-L-M models highlight the Chevrolet trademark, which immediately identifies the 1962 Chevrolet truck. The chrome plates are color-accented with red for the trademark field and black for the base.

Radiator grilles for Series 50-80 vehicles, except LCF and tilt-cab models, also display the single headlamps, while the tilt-cab grille with its dual headlamp treatment is carried forward from 1961 unchanged. Grille finish continues to be Cameo White with Jet Black lettering.



Corvair 95 model exterior appearance is generally unchanged for 1962. The chrome Chevrolet nameplate on the tailgate of pickup models, however, is released for use on the Corvan at the bottom of the right hand rear load door.

Accessory wheel trim disks of new design are another item contributing to the distinctive appearance of the 1962 Corvair 95 models.





CUSTOM MOLDINGS

A new silver anodized aluminum molding (above) is included in the Custom Appearance Equipment package for conventional line single-unit bodies. Black paint fills the word "Custom" embossed on the molding.

The Fleetside pickup models are enhanced with a new optional body side molding assembly (below) of silver anodized aluminum. The body area between the top and bottom moldings is painted Cameo White except on models painted Pure White.

A complete listing of exterior Custom Equipment is printed in the Appendix.

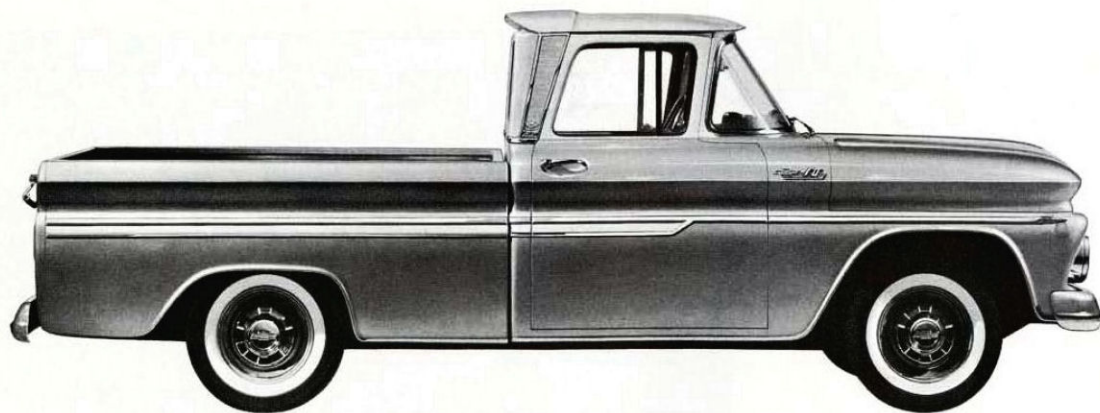

EXTERIOR COLORS



- desert beige
-
- yuma yellow
-
- crystal turquoise
-
- georgian gray
-
- seamist jade
-
- glenwood green

The six exterior colors listed at the left are new for 1962 Chevrolet trucks. Crystal Turquoise and Seamist Jade, two of the new colors, contain metallic pigment. With eight carryover colors, a total of 14 solid colors are offered for both the conventional and Corvair 95 lines.

A new method of 2-toning (illustrated above) is employed for C-K-L-M models of the conventional line, wherein the cab upper structure is painted Cameo White and the remainder of the body is painted the main color. The wheels continue to be painted the main color on Series 10-30 models. All colors except Pure White and Cameo White are used as the main 2-tone color, making 12 two-tone combinations.

The method of 2-toning Corvair 95 models is unchanged. Fourteen 2-tone combinations are offered, with Cameo White as the secondary color with all main colors except Pure White and Cameo White, which utilize Cardinal Red as their secondary color. Wheels are painted the main color except on Pure White and Cameo White models, which use Cardinal Red for the wheels.

THE INTERIORS



REGULAR PRODUCTION INTERIOR conventional line

The interior body panels of all C-K-L-M models are painted fawn beige. Color accent is provided with Cameo White for the steering wheel and hub, steering column (Series 10-40 only), instrument cluster bezel, and instrument panel face below the cluster.

All-vinyl trim with a distinctive embossment pattern is featured for regular production model seats. The seat coverings are medium fawn, with light fawn facings.

Medium fawn also is used for the left hand sunshade.

CUSTOM INTERIOR conventional line

Shown below are the new interior items included in the Custom Comfort and Convenience Equipment option for C-K-L-M 10 through 80 models and the Custom Appearance Equipment option for C-K 10 through 40 models.

In the Custom Comfort and Convenience Equipment option, new seat trim is featured for cabs and Suburban Carryalls. The trim is comprised of breathable, nylon-faced pattern cloth coverings and pin-seal vinyl facings and bolsters. Fawn and white are used respectively for the coverings and lower backrest bolster. The facing and top bolster color is keyed to the exterior color: red is used with Cameo White, Pure White, Georgian Gray, and Cardinal Red exteriors, and medium fawn is used with all other exteriors. The vinyl top of the left hand armrest is color-keyed in the same manner; white is the color of the plastic armrest base. Custom seats for cabs are constructed with full-foam urethane padding over special cushion springs, whereas Custom seats for Suburban Carryalls utilize a 1-1/2 inch thick foam rubber pad over conventional cushion springs.

Series C-K 10 through 40 models with the Custom Appearance Equipment option feature a special interior paint treatment which utilizes Cameo White for 2-toning the front door panels, dispatch box door (the central area is charcoal), instrument panel area below the dispatch box door, and Suburban Carryall rear compartment sidewalls.

A complete listing of interior items in the Custom Comfort and Convenience Equipment and Custom Appearance Equipment options is given in the Appendix.



REGULAR PRODUCTION INTERIOR corvair 95 line

The interior body panels of Corvair 95 models are painted fawn beige with Cameo White used as an accent color for the steering wheel and hub, instrument panel front face, and ash tray. The dispatch box door is painted silver, as is the instrument cluster bezel. Medium fawn is used for the left hand sunshade.

Multi-color stripes in the breathable fabric seat coverings help key the interior to any exterior color. The stripes in the fabric are red, yellow, green, blue, and black; fawn is used for the side and center panels. Fawn also is the color of the pin-seal vinyl facings.



CUSTOM INTERIOR corvair 95 line

New interior features for Corvair 95 models with the Custom Equipment option include the seat trim, fawn and white steering wheel, white front door panel insert, and red or fawn vinyl armrest top.

Breathable, nylon-faced pattern cloth coverings and pin-seal vinyl facings and bolsters in a distinctive, new design comprise the Custom seat trim. The facings and upper backrest bolster are keyed to the exterior color: red is used with Cardinal Red, Georgian Gray, Cameo White, or Pure White exteriors and medium fawn with all other exteriors. Medium fawn and white are used respectively for the coverings and lower backrest bolster.

The vinyl armrest top also is keyed to the exterior color in the same manner as the seat facings. White plastic is used for the armrest base.

All interior items in the Custom Equipment option are listed in the Appendix.

GREATER DRIVER VISIBILITY ●

REDESIGNED BODY MOUNTS ●

STANDARD TURN SIGNALS ●

NEW CORVAN SEAT ●

NEW CUSTOM CAB SEAT ●

IMPROVED CORVAN LOCKS ●

EASIER TILT-CAB TILTING ●

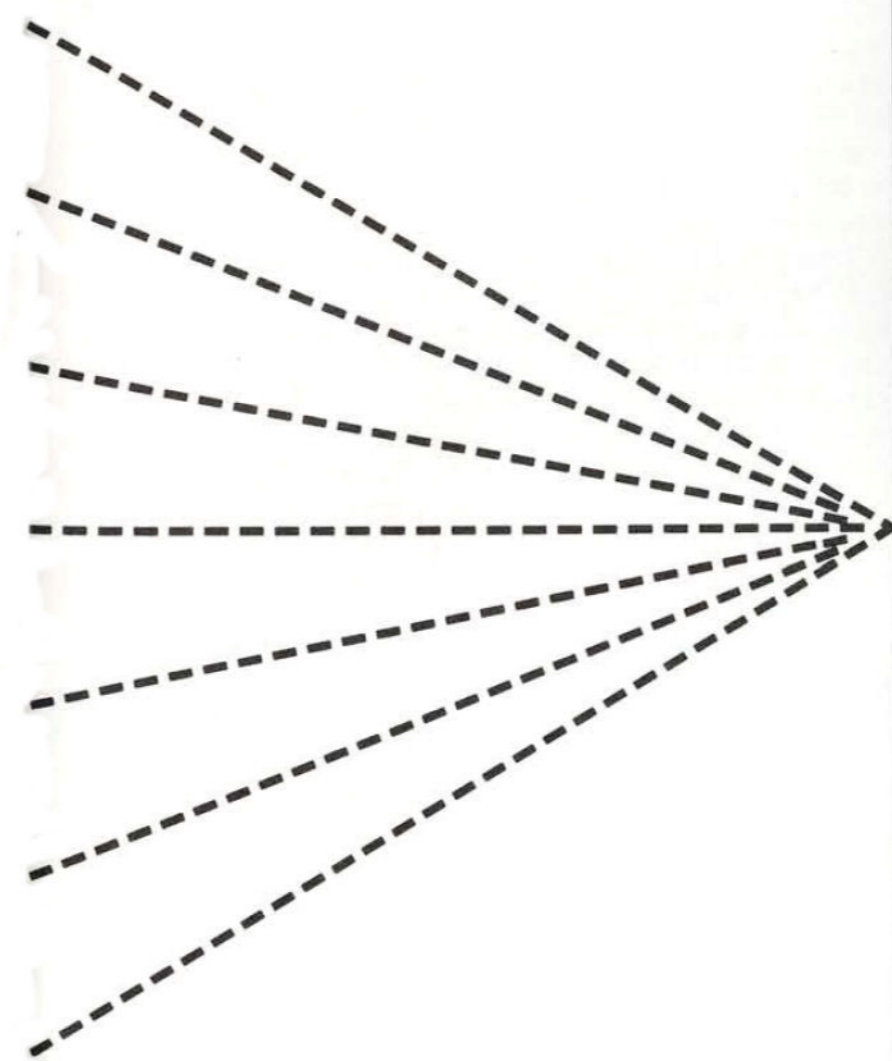

body

The 1962 Corvair 95 and conventional line body and sheet metal programs include a number of new features contributing to greater comfort, convenience, and safety. In addition, several changes to the basic bodies help consolidate the highly successful designs introduced earlier.

Prominent among the new features is the conventional line hood design, which, because it is lower at the front, improves forward visibility up to 25 percent. In addition, the highly configured surface of the hood panel not only imparts a fresh, new look to the conventional line vehicle, but also contributes to the structural rigidity of the front end sheet metal.

Seat comfort is enhanced with a new full foam and spring cab front seat cushion, a part of the Custom Comfort and Convenience Equipment option. Approximately six inches of urethane foam padding over special zig-zag springs effectively control seat cushion rebound, resulting in a more uniform ride rate.

Corvan models feature a new optional auxiliary passenger seat, which folds forward to permit convenient access to and from the load compartment. On Corvans, also, the double side doors are easier to operate with a new push-button lock for the forward door and a new release handle for the rearward door.

Improved tilting action is featured for tilt-cabs through an adjusting lever on the torsion bar hinge, permitting the operator to conveniently adjust the bar for optimum cab counterbalancing.

New-design body mounts are used in most conventional line applications for 1962. Basically similar to the previous design, the new mounts incorporate refinements which increase durability and improve assembly function and

retention. In the Series C10 and C20 applications, biscuit size also is changed to better isolate the body from the effects of frame beaming, thereby improving cab ride and durability.

Another important body feature for 1962 is the regular production release of direction signal equipment for C-K-L-M-S10 through 80 models, making this equipment standard for all except Step-Van models. The equipment consists of left and right hand front and rear lamps and a steering column-mounted switch. On Series 50 through 80 vehicles, the front lamps are of the double-face Class A type. No lamps are included for flat face cowl models.

The Suburban Carryall second seat and rear-most sliding rear windows, formerly regular production equipment, are available together as a regular production option. Without this option, the third seat is placed in the second seat position and the rearmost side windows are stationary.

Other important body and sheet metal features for 1962 include a tinted glass option for all body glass or the windshield only of conventional line single-unit bodies and cabs (except tilt-cabs); a 2-section, sliding rear window for conventional line cabs (except tilt-cabs), which is offered as a dealer-installed accessory; the relocating of the conventional line outside front door lock to the left hand side, making it more convenient for the driver to operate the lock as he enters or leaves the vehicle; the addition of run-off channels to the Corvair 95 front door hinge pillars to more efficiently drain water collecting in the roof panel drip molding; and the inclusion of seat belt attachment provisions in the front compartment floor panel of Suburban Carryall models.

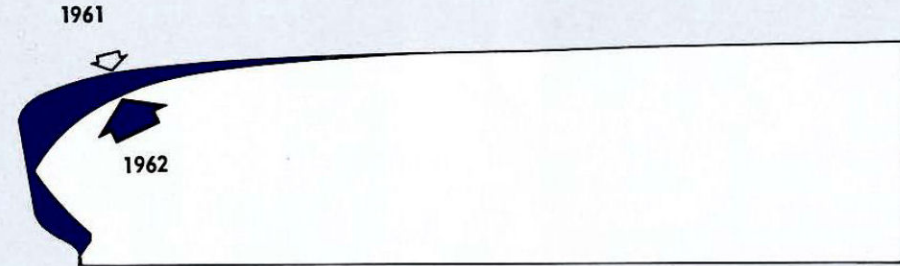

INCREASED VISIBILITY

Because it is lower at the front, the new hood design enables the driver to see closer to the front of the vehicle. Forward visibility to the ground from the driver's position is improved up to 25 percent, depending upon vehicle height.

On C10-40 Series models, the driver can see 8-1/2 feet closer to the front of the vehicle; on C50-80 Series models, he can see 10-1/2 feet closer.

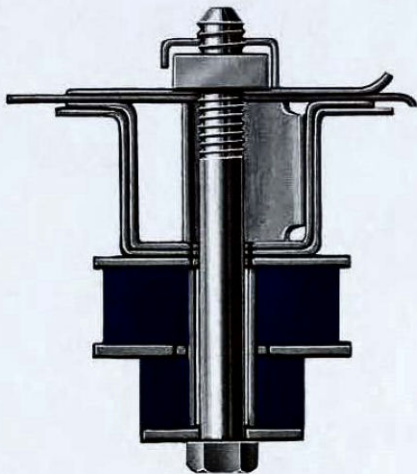
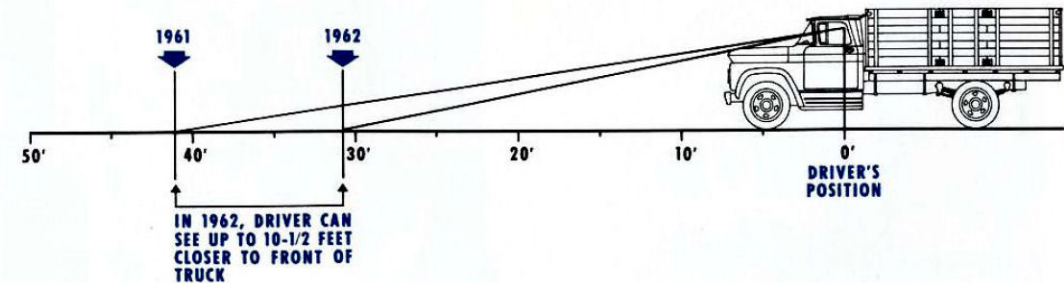

SERIES C10-20 REAR BODY MOUNT

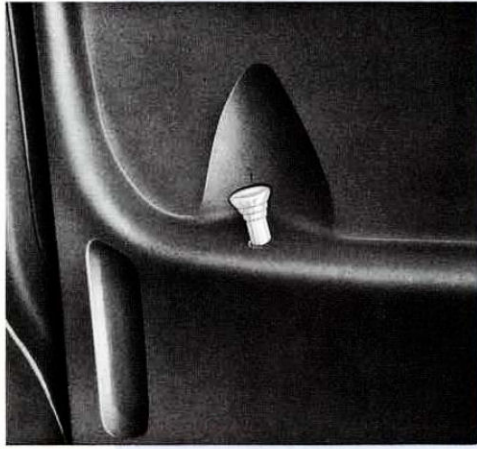

1962



1961

CORVAN SIDE DOOR LOCKING

Corvan double side doors for 1962 are easier to lock and unlock with refinements to the locking mechanisms. The locking knob on the inner panel of the front side door is eliminated and replaced with a pushbutton lock on the foremost part of the sill area, making it easier for the driver to lock or unlock the door. The outside key lock also is eliminated since an automatic locking feature is provided with the pushbutton when depressed.

Unlatching of the rear side door is also facilitated by relocating the release lever from the side face of the door to the inner panel.



1962

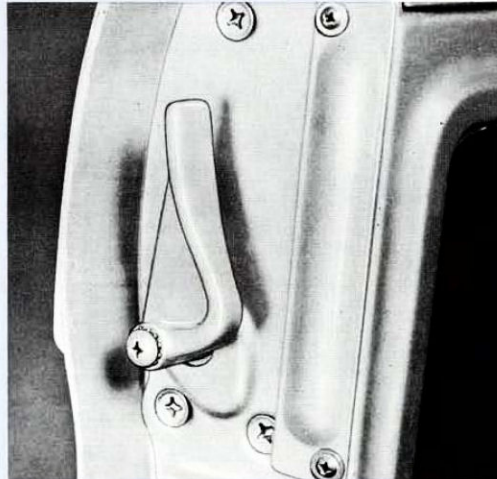

1961

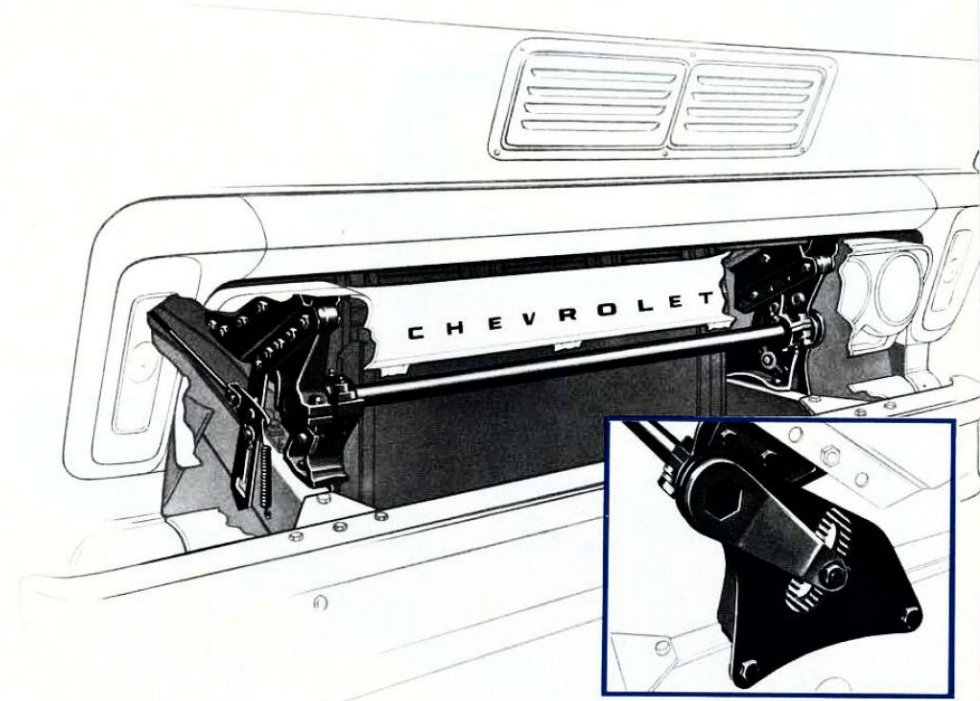

IMPROVED TILTING MECHANISM

The tilting mechanism for 1962 tilt-cabs incorporates a new torsion bar adjustment feature for optimum cab counterbalancing. Although the basic design of the mechanism is unchanged, the adjustment virtually eliminates tolerance stack-up, thereby improving tilting action.

The torsion bar now rides free in the left hand frame bracket rather than being anchored directly to the bracket as in the previous design. Anchoring of the torsion bar is achieved with an adjusting lever, which is fixed to the torsion bar at one end and bolted to the frame bracket at the other end. A slot in the frame bracket permits the lever to be adjusted either upwards or downwards from the normal position. Serrations on both the lever and the frame bracket assure positive positioning of the lever when the retaining bolt is tightened.



ACCESSORY REAR WINDOW

A sliding rear window unit is available as a dealer-installed accessory for all 1962 conventional line cabs except tilt-cabs. The unit, which is retained in the regular production rear window opening, consists essentially of a double-channel metal frame carrying left and right hand panes of glass. Pull handles on each section permit either or both panes to be opened. The unit is locked with a knob on the central dividing bar.

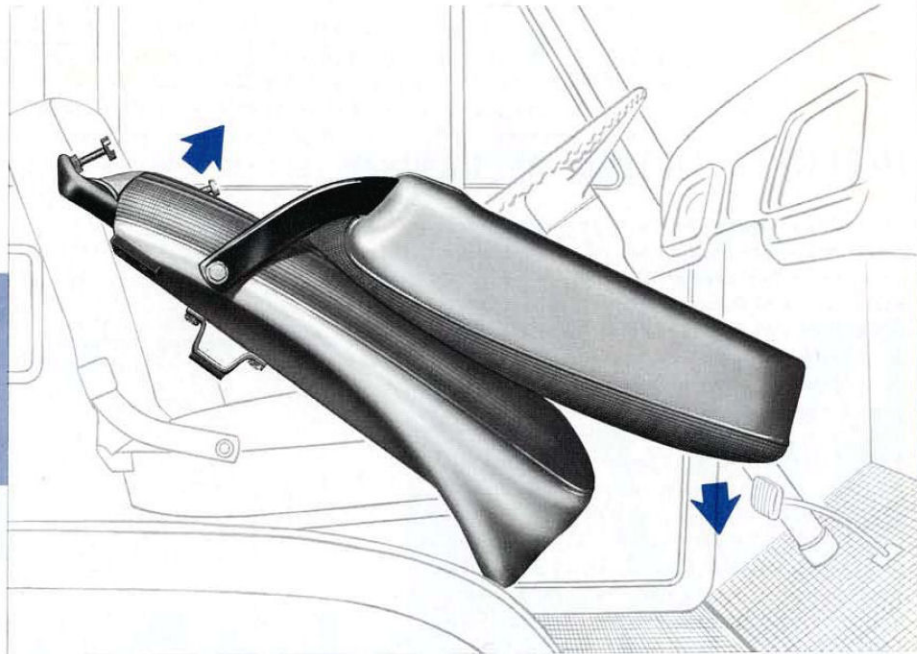

NEW CORVAN AUXILIARY SEAT

A right hand single passenger seat is released as a regular production option for the Corvan. This is in addition to the existing full-width front seat option. The auxiliary seat, which folds forward and out of the way, permits convenient access to and from the load compartment. Construction and upholstery materials are like those of the standard driver's seat. Custom upholstery materials also are available.

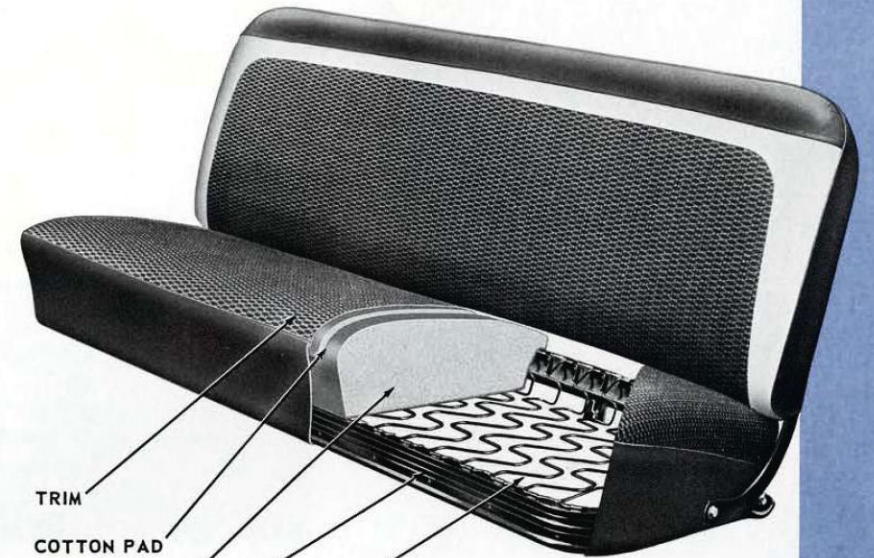

TRIM
COTTON PAD
FOAM CUSHION
SEAT FRAME
ZIG-ZAG SPRINGS

CUSTOM SEAT CONSTRUCTION

A new seat cushion for cab models with the Custom Comfort and Convenience Equipment option will be available shortly after the start of 1962 production. A molded polyether urethane cushion and zig-zag springs replace the molded foam rubber cushion and perforated wood platform used formerly.

One disadvantage of a pure foam rubber seat is the high amplitude characteristics of the material. The new foam-over-spring design achieves a uniform ride through the relatively high rate of the springs and the low rate of the cushion.

A cotton pad is used over the 5.62 inch thick foam cushion to insure breathability of the nylon-faced fabric trim. The pad is eliminated and the thickness of the foam cushion increased to 6.12 inches when the special seat cushion construction is ordered with regular production all-vinyl trim — a new option for 1962 conventional cabs. Also new for 1962 is the seat construction for Suburban Carryalls with the Custom Comfort and Convenience Equipment option. In this application, a 1-1/2 inch thick foam rubber cushion pad replaces the conventional urethane pad and a 3/4-inch urethane pad is added to the backrest; cotton padding under the nylon-faced fabric and vinyl trim also is used.

Chassis design is, of necessity, a dynamic activity – improving, expanding, and always anticipating the most rugged possible uses of the product. The 1962 chassis bears this out with new heavy-duty I-beam front suspensions; higher capacity rear axles; and more durable frames for certain heavy-duty models.

THE 1962 CHEVROLET TRUCK

chassis

NEW I-BEAM AXLE OPTIONS ●

CHASSIS IMPROVEMENTS,
SERIES 60 AND 80 ●

MORE POSITIVE WHEEL
PILOTING ●

NEW HEAVY-DUTY REAR AXLES ●

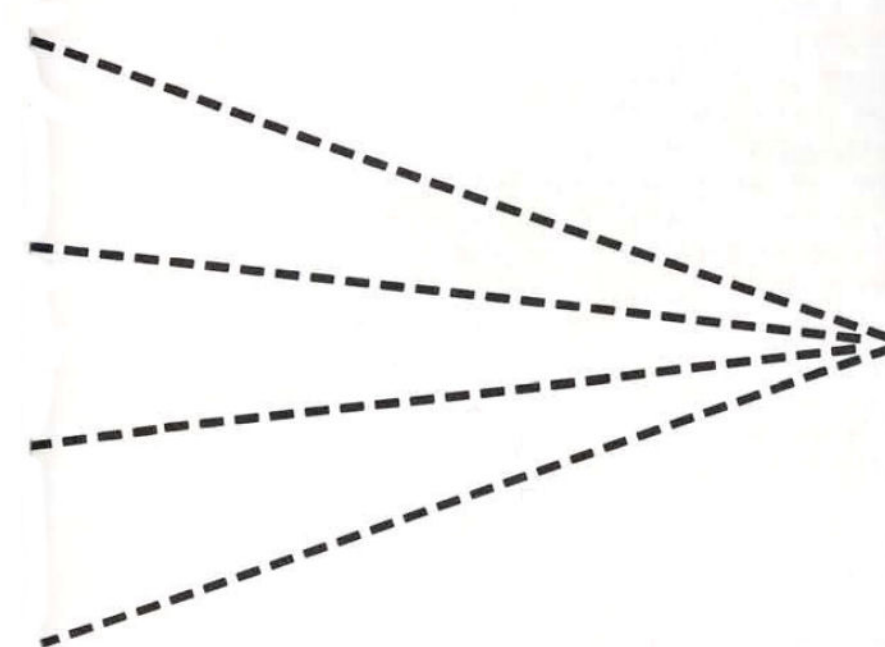

chassis

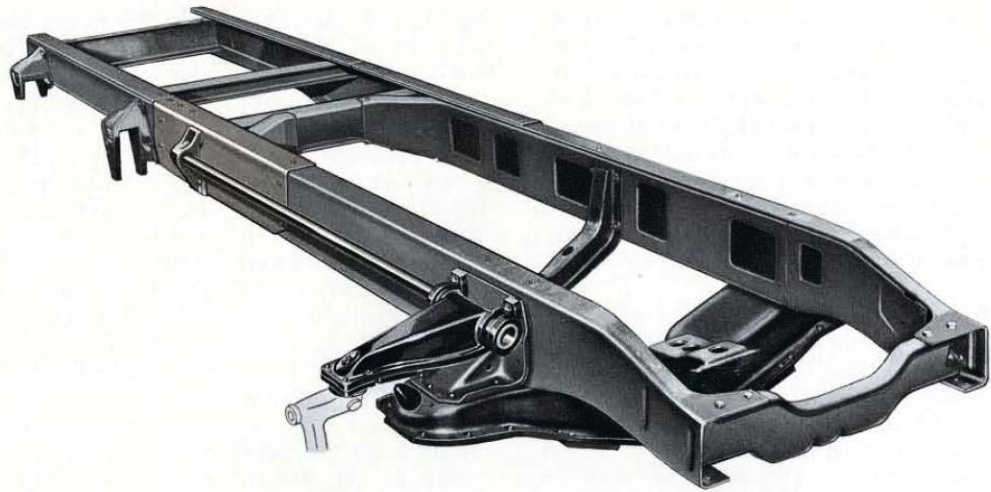

HEAVY-DUTY CHASSIS IMPROVEMENTS, SERIES 60 AND 80

Longer frame reinforcements increase chassis durability on C60H, D60 and C80 models with wheelbases up to 175 inches, and on C50, C60 models with heavy-duty torsion bar equipment. The reinforcements are increased in length from 30 to 48 inches to provide greater localized beaming stress resistance.

Further, D60, C-M80, and C50, C60 models with optional torsion bars, feature rear torsion bar anchors which are moved rearward to a position adjacent to the second crossmember for additional strength at this critical point of stress. Along with the repositioned anchors, torsion bars are lengthened from 57.96 to 70.45 inches, and increased in diameter by .07 inches. Rated capacities remain unchanged.

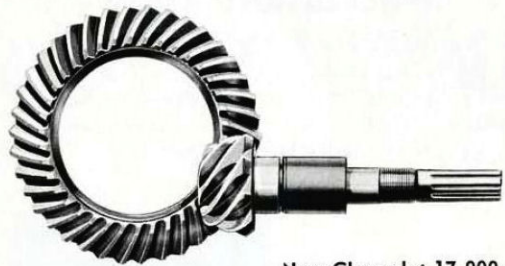

NEW HEAVY-DUTY REAR AXLES

New Chevrolet 17,000 pound capacity, single and 2-speed vacuum shift axles replace the Eaton 16,000 pound units. The single speed, 7.2-to-1 ratio unit is released for Series 60H, except D60H, and models S67 and S69. The 2-speed version, 6.40/8.72-to-1 ratio, is available for C, L, T60 models.

Hypoid gearing results in an improved, more durable gearset with greater tooth contact areas for increased capacity and quieter operation. The lower ratio ranges of the 2-speed unit provide greater economy of operation and higher sustained road speeds.

Also, for increased selectivity, a new 2-speed, 17,000 pound capacity Eaton axle is available for Series 60H models. Gear ratios of the new unit are 7.17 and 9.97-to-1.

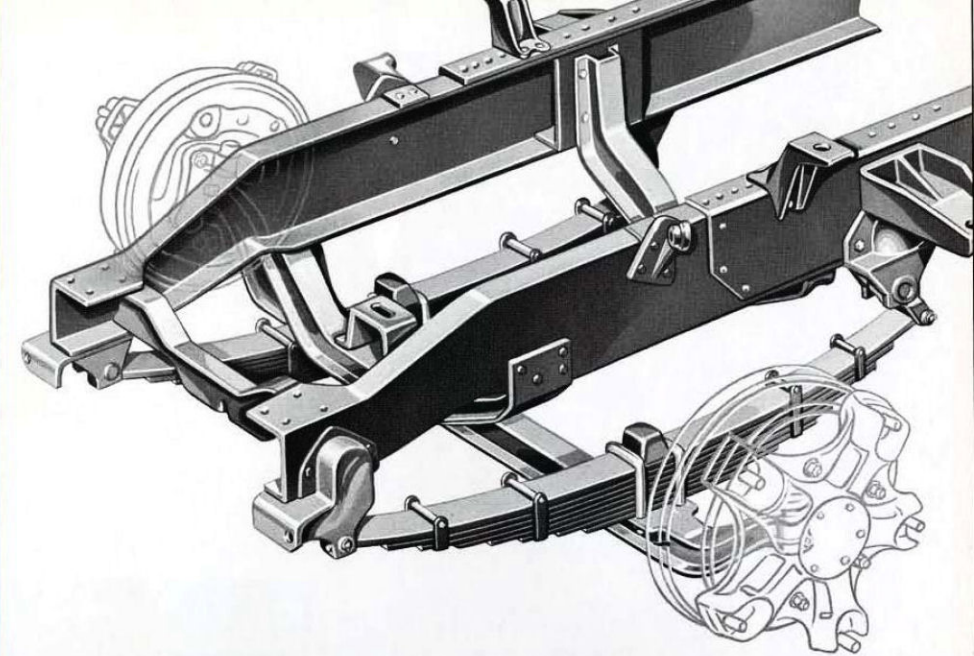

HEAVY-DUTY FRONT SUSPENSION OPTIONS

New I-beam front axles with leaf-type front springs expand Chevrolet's optional truck chassis combinations to encompass a greater majority of customer needs and preferences. Specifically designed for extremely abusive off-road operations, the new front suspensions are rated at 9000 and 11,000 pounds capacity. Availability of the new suspensions is confined to Series C-E-L-M80, except Model L8103 where the shorter front overhang prevents using this equipment.

The options utilize conventional reverse Elliott axles, semi-elliptic leaf springs and forward mounted steering gear, and a conventional steering linkage system with a fore and aft drag link in place of the standard parallelogram type. Adjustable steering knuckle stop screws contact embossments on the I-beam to prevent the wheels from contacting the chassis on turns. Frame assemblies used with this equipment are of the ladder-type, with conventional channel-section side rails.

Successful truck design matches carrying capacities and vehicle usage with the correct pulling power. The total of 117 different engine-transmission-axle combinations for 1962 includes two new engines, a 409 and a 327 cubic inch displacement unit, and expanded usage of existing power plants.

THE 1962 CHEVROLET TRUCK

power teams

NEW ENGINE IDENTIFICATION ●

IMPROVED 348 CU.IN. ENGINE ●

NEW 327 AND 409 CU.IN.
ENGINES ●

EXPANDED 261 CU.IN. ENGINE
AVAILABILITY ●

REVISED TRANSMISSION LINE-UP ●

DELCOTRON GENERATING SYSTEM ●

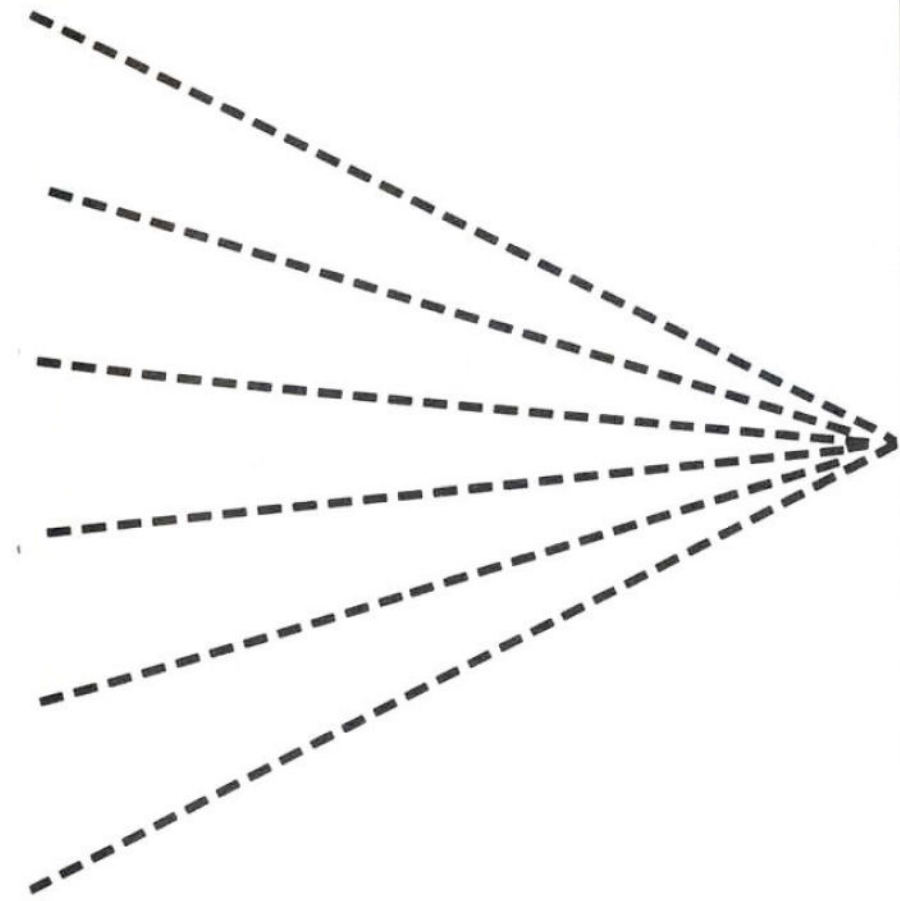

power teams

HIGH TORQUE

409

NEW ENGINE IDENTIFICATION

A new identification system is introduced for 1962 conventional line gasoline engines wherein the name "High Torque" and a number corresponding to the engine displacement replace the former individual engine names.

The new identification is plainly displayed with a decal on the valve rocker cover of 6-cylinder engines and on the right hand valve rocker cover of 8-cylinder engines.

Several important modifications to the power team line-up for 1962 increase the utility and versatility of Chevrolet trucks. Seven gasoline engines are offered. The total includes two new models. One is a 327 cubic inch displacement unit, available optionally on Series 60 models, and the other is the largest and most powerful engine ever offered by Chevrolet, a 409 cubic inch displacement version which is provided optionally on Series 80.

Since the 409 cubic inch engine is patterned after the existing 348 cubic inch power plant, with a larger bore and longer stroke, its development provides for many improvements to the 348 cubic inch version with which it utilizes many common components. Included are such items as a new combustion chamber and piston design, larger valves, improved cooling, and induction-hardened exhaust valve seats.

The 235, 283 and 261 cubic inch displacement engines are carried over for 1962 without change. There are, however, changes in availability. The 261 cubic inch unit, formerly provided only

as standard equipment on Series 60, is now obtainable optionally for Series 10-50, except forward control models.

The 1961 Taskmaster and Workmaster Special engines are discontinued.

Also new for 1962 is the engine identification system wherein the names, as such, are discontinued. All engines are known as "High-Torque" and are distinguished only by the number corresponding to their displacement. In the case of the 235 cubic inch engines both the downdraft and updraft carburetor versions are known as High-Torque 235. Each, however, is counted separately in the engine line-up. The downdraft carburetor version of the High-Torque 235 again may be equipped with an economy option but a special decalomania will not be furnished nor will the engine be counted separately.

With one exception, all transmissions are carried over, unchanged for 1962. This includes 8 synchromesh and 3 automatic units. Added to the line is a new optional 4-speed auxiliary transmission for tandem rear axle models,

POWER TEAM AVAILABILITY

MODEL	ENGINE	TRANSMISSION
C10 C20	Std: High Torque 235 Opt: High Torque 283 Opt: High Torque 261	Std: 3-Speed Synchromesh Opt: Heavy-Duty 3-Speed Synchromesh Opt: 4-Speed Synchromesh Opt: Powerglide <i>h</i>
K10 K20	Std: High Torque 235 Opt: High Torque 283 Opt: High Torque 261	Std: 3-Speed Synchromesh Std: 2-Speed Transfer Case (T221) Opt: 4-Speed Synchromesh
P10	Std: High Torque 235	Std: 3-Speed Synchromesh Opt: Heavy-Duty 3-Speed Synchromesh Opt: 4-Speed Synchromesh Opt: Powerglide
P20	Std: High Torque 235 (Updraft Carburetor)	Std: 3-Speed Synchromesh Opt: Heavy-Duty 3-Speed Synchromesh Opt: 4-Speed Synchromesh Opt: Hydramatic
C30	Std: High Torque 235 Opt: High Torque 283 Opt: High Torque 261	Std: 4-Speed Synchromesh Opt: Heavy-Duty 3-Speed Synchromesh
P30	Std: High Torque 235 (Updraft Carburetor)	Std: 4-Speed Synchromesh Opt: Heavy-Duty 3-Speed Synchromesh Opt: Hydramatic
C40 CL50	Std: High Torque 235 Opt: High Torque 283 Opt: High Torque 261	Std: 4-Speed Synchromesh
S50	Std: High Torque 235 Opt: High Torque 261	Std: 4-Speed Synchromesh
CLT60	Std: High Torque 261 Opt: High Torque 327	Std: 4-Speed Synchromesh Opt: 5-Speed New Process 540C * Opt: Powermatic <i>ff</i> Opt: 5-Speed Clark 265V § Opt: 5-Speed Clark Close-Ratio 267V §
S62 S64 S67	Std: High Torque 261 Opt: High Torque 327	Std: 4-Speed Synchromesh Opt: 5-Speed New Process 540C * Opt: Powermatic Opt: 5-Speed Clark 265V § Opt: 5-Speed Clark Close-Ratio 267V §
S69	Std: High Torque 327	Std: 4-Speed Synchromesh Opt: 5-Speed Clark 265V Opt: 5-Speed Clark Close-Ratio 267V Opt: Powermatic
M80	Std: High Torque 348 Opt: High Torque 409	Std: 5-Speed Spicer 3152 Opt: 3-Speed Spicer Auxiliary 5831-G ** Opt: 4-Speed Spicer Auxiliary 6041 Opt: Powermatic **
CLT80	Std: High Torque 348 Opt: High Torque 409	Std: 5-Speed Spicer 3152 Opt: 5-Speed Spicer Close-Ratio 3152A Opt: Powermatic **

* - With High Torque 261 only.
** - With High Torque 348 only.
§ - With High Torque 327 only.

ff - Not used with High Torque 261 for T60 models.
h - Not used with High Torque 261.

An important story for 1962 is the addition of optional Delcotron generating systems in 42, 52 and 62 ampere capacities. Major features of this system are a reduction in weight, substantial increases in reliability, and higher output at lower speed.

Greater dependability is realized through several factors. Speed is less critical since the current carrying windings are wound in a stationary stator instead of the revolving armature in a conventional generator. Thus the centrifugal forces acting on the windings are eliminated.

Vibration and bending forces are also minimized since the rotor shaft is solid, running

on needle bearings at the rear and ball bearings at the front end. Brush life is also extended since these only carry 2 to 3 amperes field current rather than the full generator output.

The alternating current develops power by revolving a magnetic field, the rotor, within a conductor, the stator. The current produced in the windings flows through the integral silicon diode rectifiers, producing DC at the output terminal. The diode rectifies function also as a one-way valve, allowing current to flow out, only. The regulator provided with the Delcotron requires no cutout relay.

● HIGH-TORQUE 327 ENGINE



HIGH TORQUE 327
CHEVROLET TRUCK ENGINE

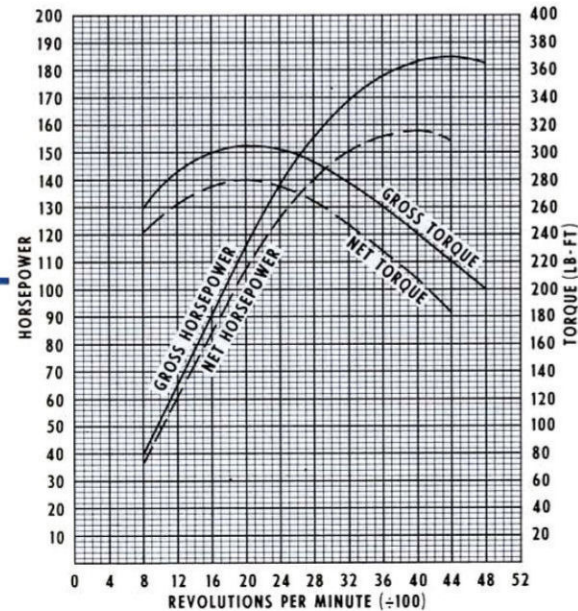

COMPRESSION RATIO	8.0-to-1
GROSS BRAKE HORSEPOWER	185 at 4400 rpm
NET BRAKE HORSEPOWER	158 at 4000 rpm
GROSS TORQUE (Lb.-Ft.)	305 at 2000 rpm
NET TORQUE (Lb.-Ft.)	280 at 2000 rpm

The new 327 engine is basically the same as the discontinued 283 cubic inch Taskmaster V-8, but with internal modifications to effect an increase in displacement. Exterior appearance is identical, except for the air cleaner.

Larger displacement is achieved by increasing the bore from 3.875 to 4.0 inches and the stroke from 3.0 to 3.250 inches. Cylinder block bulkheads are strengthened to prevent possible cracking from the increased power output. The stroke increase is accomplished by using a crankshaft with a greater throw. Bearing journals and crankpin width and diameter remain the same, but the counterweights are revised proportionally with the increase in crankarm length.

Blending radii of all critical connecting rod sections are revised for increased strength and rigidity. M500 aluminum connecting rod bearings replace the M400 bearings used on the 283 engine. The new bearings are identical with the M400 bearings except for a special heat treatment which improves their fatigue resistance.

Push rod durability is assured with hard tip inserts, which are identical to those used on the 348 cubic inch engine. The 327 engine employs new valve springs, which are stronger, more durable, and will not "bottom out" under the increased forces of the more powerful engine. Aside from the new valve springs, the cylinder heads are identical to the 283 engine cylinder heads. As a result, the only combustion chamber change is the circular sump recess in the piston head.

New cylinder head gaskets are used because of the increased bore size.

The front end of the oil pan is revised slightly to provide adequate crankshaft clearance and to prevent oil aeration from the increased piston stroke.

The 2-barrel carburetor and the distributor are of the same type and design as used previously, but are new because the larger engine displacement requires new calibrations for proper operation. The former Workmaster Special

air cleaner is used with the 327 engine to provide a larger unit for increased efficiency.

A 13-inch coil clutch is used with the 327 engine, replacing the 11-inch clutch used on the 283 engine. The greater clutch area provides more positive action, greater efficiency, and longer life.

A vacuum, spinner-type governor is provided as standard equipment. Maximum setting is 4000 rpm for both synchromesh and automatic transmissions.

The 35-ampere generator is released as part of the 327 cubic inch engine option. This unit, which utilizes a solid shaft, replaces the regular production 30-ampere, hollow-shaft generator.



PISTONS AND RINGS

Pistons are of cast aluminum alloy with a cast-in steel ring for controlled thermal expansion. The solid slipper skirt design of the 283 engine piston is retained. However, the head incorporates a circular sump and two clearance notches. This provides added combustion chamber volume to establish a compression ratio identical to that of the superseded engine, and assures adequate valve clearance. Rings are of the same type and design as previously used.

HIGH-TORQUE 348 ENGINE

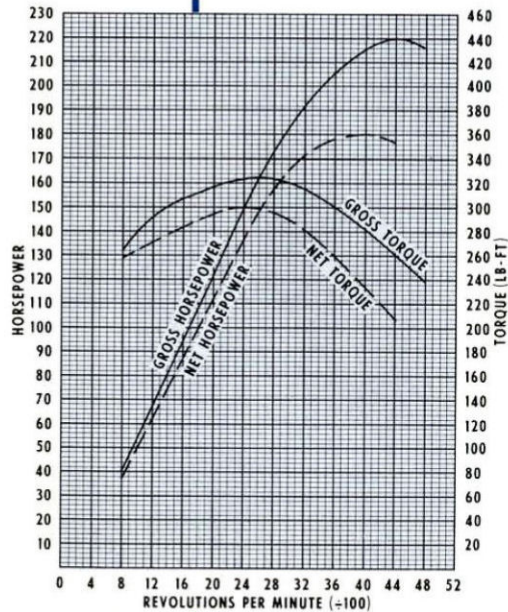

COMPRESSION RATIO	7.75-to-1
GROSS BRAKE HORSEPOWER	220 at 4400 rpm
NET BRAKE HORSEPOWER	180 at 4000 rpm
GROSS TORQUE (Lb.-Ft.)	325 at 2600 rpm
NET TORQUE (Lb.-Ft.)	300 at 2400 rpm

The 348 cubic inch engine is revised for 1962 to improve its operating efficiency. The major area of change is the new combustion chamber - an outgrowth of development work on the new 409 engine. Other changes are made to the 348 engine to improve its durability, and, in some cases, for the purpose of using parts common with the 409 engine.

The new configuration of the 348 engine combustion chamber is achieved with a piston having a new step-head design dome. Material specifications, ring type, and piston skirt type remain unchanged.

Two-thirds of the new piston dome is flat, while the remaining third is a 16 degree tapered portion which forms the quench area of the combustion chamber when the piston is uppermost in the cylinder. Because of the dome's shape, less area is exposed to combustion than with the former pent-top design; carbon deposits, therefore, are proportionately reduced, resulting in cooler engine operation.

Piston durability is increased by locating the piston pin at the exact centerline of the piston

rather than offset from the centerline as in previous design. The new location eliminates excessive pressure on diagonally opposite corners of the piston, reducing the possibility of the piston cracking.

Cylinder heads feature 0.125 inch larger intake and exhaust valves and larger ports for increased volumetric efficiency. The exhaust valve seats are induction-hardened for greater durability. Exhaust valve seat inserts are discontinued. One of the two combustion chamber cut-outs in each cylinder bore is eliminated on the 1962 348 engine cylinder block. This revision, along with the new piston dome, maintains the 7.75-to-1 compression ratio. Improved engine cooling results from the use of a larger water pump by-pass system.

Both the carburetor and distributor are basically the same as the 1961 design, but are recalibrated because of the new combustion chamber.

A vacuum, spinner-type governor is provided as standard equipment. Maximum setting is 4000 rpm for all transmissions.



NEW COMBUSTION CHAMBER DESIGN

A combustion chamber of optimum design is achieved on the 348 engine by eliminating one of the cylinder bore cut-outs and utilizing a piston with a new dome configuration. The resultant combustion chamber size and shape permits efficient fuel combustion with low octane fuel. Compression ratio is 7.75-to-1.

Cooler and, therefore, more efficient engine operation results from the smaller piston area exposed to combustion.

HIGH-TORQUE 409 ENGINE

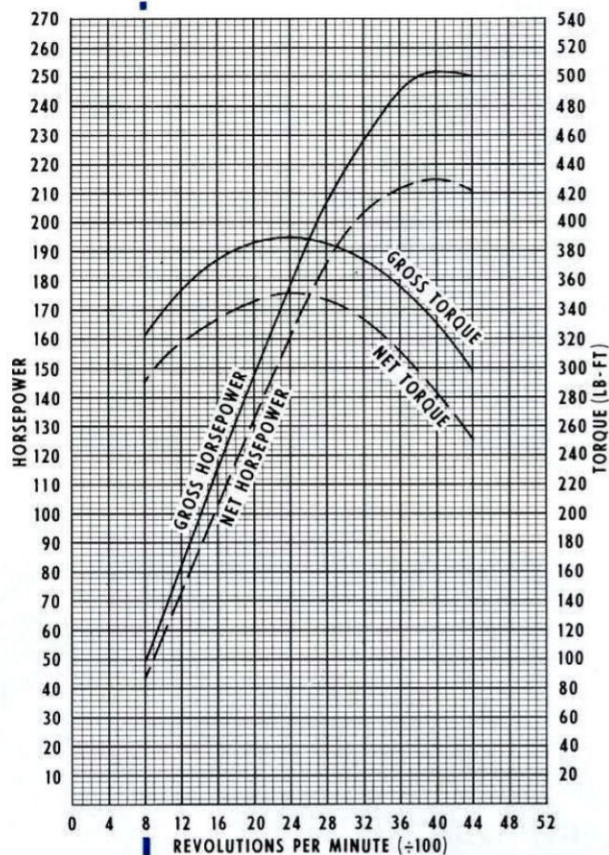

COMPRESSION RATIO	7.75-to-1
GROSS BRAKE HORSEPOWER	252 at 4000 rpm
NET BRAKE HORSEPOWER	215 at 4000 rpm
GROSS TORQUE (Lb.-Ft.)	390 at 2400 rpm
NET TORQUE (Lb.-Ft.)	352 at 2400 rpm

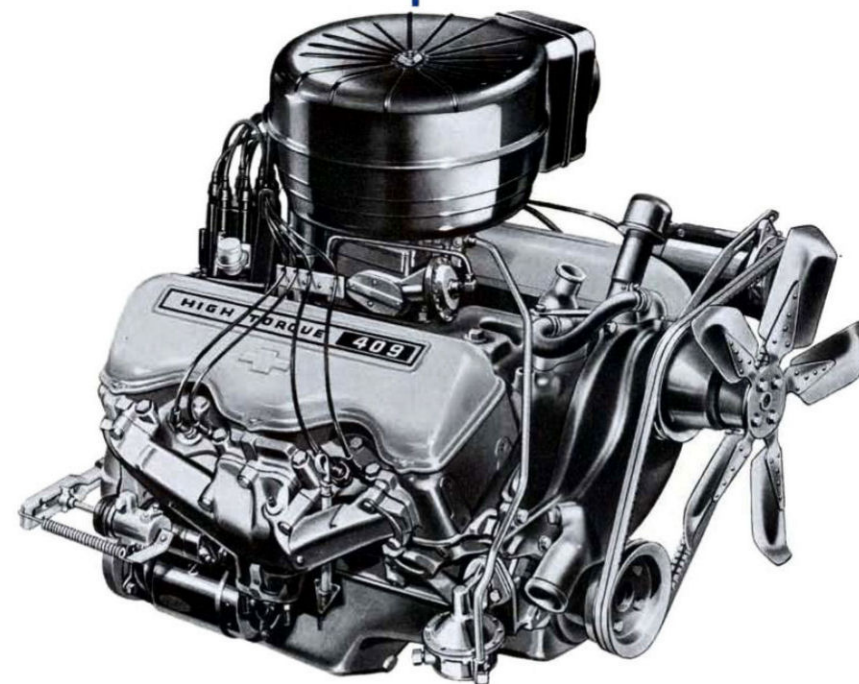

The new 409 cubic inch displacement engine is closely related to the improved 348 cubic inch unit. Basically, a bore size of 4.3125, 0.1875 inches larger, and a 3.5 inch stroke, 0.250 inches larger, account for the larger displacement and subsequent greater power output.

With the larger bore, the cylinder block bulkheads are strengthened with increased metal to prevent the possibility of cracks resulting from the greater internal pressures.

The crankshaft is new, with longer crankarms and proportionately larger counterweights. All bearing journals are of the same diameter and width as on the 348 cubic inch engine. However M500, rather than M400, aluminum main and connecting rod bearings are utilized.

Pistons and rings differ from those of the 348 cubic inch engine in size. In addition, the larger pistons incorporate balance pads in a new location, at each side of the piston pin opening. Also, connecting rods are .125 inches

shorter and all sections strengthened to provide an additional measure of durability with the more powerful engine.

Although the cylinder head is basically identical to that of the smaller counterpart, the 409 cubic inch engine uses new cylinder headgaskets, due to the larger bore.

The exhaust manifolds are completely new. These are provided with a 2.5 inch diameter outlet for decreased back pressure.

Longer crankarms and larger counterweights necessitate a lower level of oil in the pan to prevent aeration of the oil. The pan is therefore somewhat more shallow than that used previously with the 348 cubic inch engine.

Both the carburetor and distributor are new only in that different calibrations are required with the larger displacement engine.

A vacuum spinner-type governor is provided as standard equipment. Maximum setting is 4000 rpm.

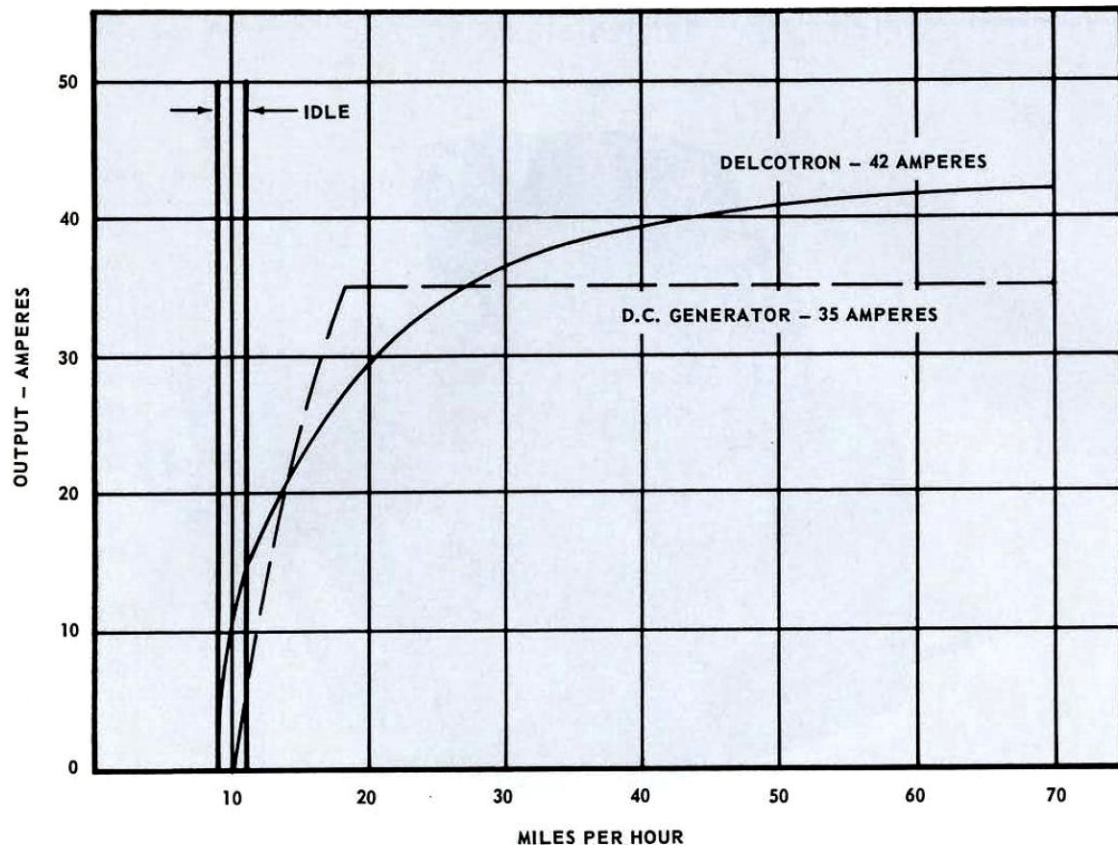

DELCOTRON GENERATING SYSTEM

Even at engine idle, unlike the DC generator which has virtually no charge rate, the Delcotron has an output of 12 amperes.

The Delcotron also outperforms the conventional generator at highway speeds, its output being higher at any given rpm.

These advantages are in addition to a weight reduction of 64 percent.

OTHER ENGINE IMPROVEMENTS

EXTENDED-LIFE MUFFLERS are featured for all gasoline engine exhaust systems. Series 10-40 models with either the base 235 or optional 261 or 283 cubic inch engines utilize a muffler with an aluminized shell, to inhibit corrosion and extend muffler life. Mufflers for Series 50-80 models are built with more durable baffles, whose thickness is increased from .035 to .047 inches.

OIL FILTERS. A one-quart capacity partial-flow oil filter is offered as regular production equipment for the downdraft carburetor version of the High Torque 235 engine. This filter was

previously offered as an RPO for this same engine. The 2-quart capacity partial-flow filter remains as optional equipment. Oil filters will not be available on the updraft version of the High-Torque 235.

An optional 2-quart capacity full-flow oil filter, similar to that available with the 409 cubic inch V-8 engine, is released for the 327 and 348 cubic inch engines.

HIGH-TORQUE 283 ENGINE CLUTCH. An 11-inch diaphragm spring clutch is released for the High-Torque 283 engine, replacing the 11-inch coil spring unit released for 1961.

TRANSMISSIONS

All previously available transmissions are continued for 1962, without change. One addition to the lineup provides for an optional 4-speed, heavy-duty auxiliary gearbox, Spicer model 6041, on the tandem rear axle models. The existing optional 3-speed unit is released with the 348 cubic inch only, while the higher capacity 4-speed auxiliary transmission is available with either the 348 or 409 cubic inch engines.

The new component has ratios of 2.14, 1.24, 1.00 and an overdrive of .86-to-1 in fourth gear. The high input torque capacity is more than adequate for the 352 lb-ft net torque output of the 409 cubic inch displacement engine. The new auxiliary gearbox also features three SAE 6-bolt power take-off provisions, at the left, right hand side and at the top. The top PTO can be utilized to transmit full engine power.

Ten medium and ten heavy-duty models, equipped with compact, lightweight diesel power plants of proven design, comprise Chevrolet's entry into this growing segment of the truck market.

THE 1962 CHEVROLET TRUCK

diesel models

BETTER FUEL ECONOMY •

LOWER FUEL COSTS •

LONG ENGINE LIFE •

REDUCED MAINTENANCE •

REDUCED DOWN-TIME •

diesel models

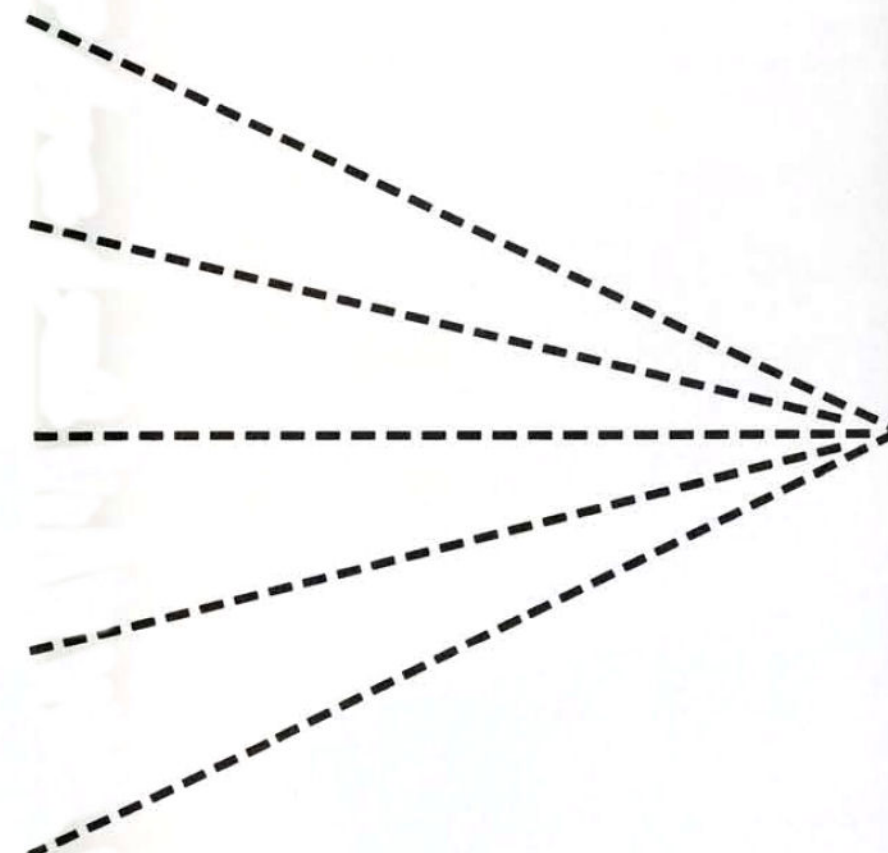

DIESEL

All diesel engine equipped models are distinguished by a special chrome nameplate which includes the word "Diesel" in raised block letters, on a black background.

The nameplate is positioned on the cowl, below the series plate on D60 and E80 models, and on the door of the U80 vehicles.



MODEL D6103

The 1962 diesel program includes 20 models on 8 wheelbases. Fifteen of the models are conventional cabs, three are low cab forwards, and two are tilt-cabs. New series prefixes identify diesel models with "D" used for conventional cabs, "E" for low cab forwards, and "U" for tilt-cabs.

The "D" or conventional cab models are all in the Series 60 category, and are obtainable in wheelbases of 133, 145, 157, 175 and 197 inches. Of the fifteen total, five each are in the 1-1/2 ton Special, regular 2-ton and 2-ton Heavy-Duty classification.

The low cab forward and tilt-cab models will be available sometime after start of production. Low cab forward or "E" models are in three wheelbase sizes, 121, 133 and 145 inches. These fall into the nominal 2-1/2 ton class, Series 80. The same is true for the "U" or tilt-cab models. These, however, are in two wheelbases, 97 and 109 inches.

Gross Vehicle Weight ratings are identical for the new models with the ratings of gasoline powered units in the respective series.

Exterior and interior appearance of the D60 models is identical to that of C60 models except a chrome nameplate, incorporating the word "Diesel" in raised block letters on a black ground, is added below the series nameplate on the cowl side face. The diesel nameplate is positioned just above the cowl crease line. In addition, an aluminum plate, imprinted with the words "Diesel Fuel" in black letters, is added just below the fuel filler cap.

E80 models are comparable in utility to conventional line LCF models but differ from them in exterior appearance due to the use of GM Truck DB7000 cab parts and B4000 sheet metal. Exterior ornamentation differs with a Chevrolet emblem added at the center of the hood front face, the series nameplate placed lower on the cowl, and a diesel nameplate added below the series nameplate.

Interior appearance is identical to L80 models, except that the full-width front seat is replaced with two tilt-cab driver's seats.

The exterior appearance of U80 models, which utilize GM Truck DL7000 cab parts, is very similar to conventional line tilt-cabs, but the U80 cab is approximately 6 inches higher and requires, therefore, an exposed running board. A diesel nameplate is added below the series numerals on the door.

Interior appearance is identical to T80 models.



MODEL U8203

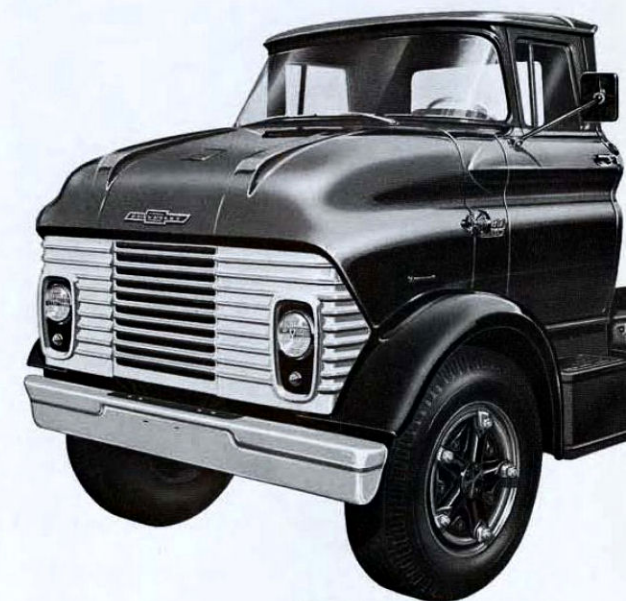

MODEL E8103

DIESEL POWER TRAINS

The Detroit Diesel 4-53 and 6V-53 engines offered by Chevrolet are of existing designs proven over many hundred thousand miles of actual customer operation. The engines are relatively small, lightweight diesels with a wide speed range, and both offer the advantages of better fuel economy, lower fuel costs, longer engine life, reduced maintenance, and reduced downtime.

A characteristic of both engines is the relatively flat torque curve wherein the maximum torque is attained at a low engine rpm, and it continues at that general level, with only a slight decrease, all the way to the governed speed of 2800 rpm. These qualities give the diesel engine equipped vehicles excellent pulling power over the entire operating range.

The design of both engines incorporates the 2-stroke cycle and uniflow-scavenging principles, which make them particularly adaptable to truck installations since they provide more horsepower per cubic inch of displacement, higher horsepower to weight, and higher horsepower to size.

A uniflow-scavenged, 2-stroke cycle engine has one unique advantage over all other reciprocating power plants of commercial design: by inducing pressurized air through inlet ports around the entire lower periphery of the cylinder and exhausting through the cylinder head, maximum air flow areas are achieved and pumping losses minimized.

The fuel system for the 4-53 and 6V-53 diesel engines is simple, durable, and practical in design. It consists of one unit injector for each cylinder, a low pressure fuel transfer pump, and two fuel filters.

An extremely high ratio of parts interchangeability exists between the two engines. As an example, the exhaust valve operating mechanism, valves, springs, pistons, rings, cylinder liners, injectors, and fuel pumps are common.

D60 models utilize a 20-gallon cab-mounted fuel tank with new lines. The E and U80 models have a low capacity, easily removable "throw-away" type tank since individual owners often prefer to install their own tanks. The 80 Series trucks also have new 3/8-inch diameter fuel lines with a fuel return line.

A single 3-1/2 inch diameter exhaust system is used on D60 models, while dual 3-inch exhausts are base equipment for E and U80 models. A single left hand vertical exhaust stack is available optionally for D60 models, while verti-



MODEL 4-53

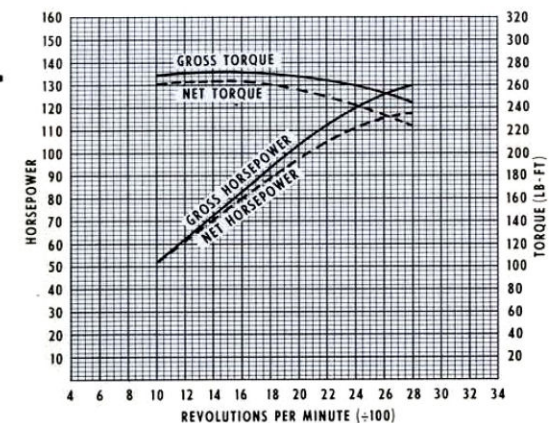

MODEL 6V-53

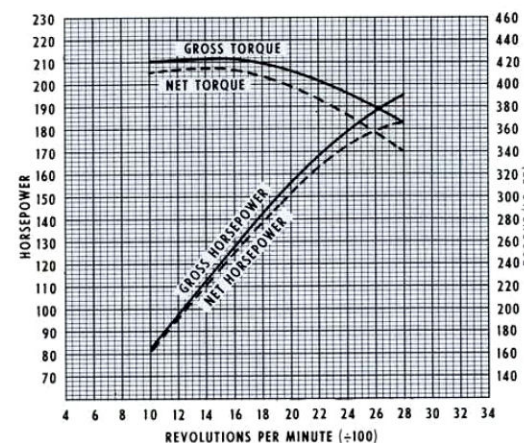

cal dual exhaust stacks may be obtained for E-U80 models. Included in the vertical exhaust stack options are assist handles mounted on the cab rear panel of D and E models. The assist handles eliminate a safety hazard by providing a means of entering the cab without touching the vertical stacks.

A 150 ampere-hour battery and 52-ampere, 12-volt Delcotron are standard equipment for D60 models. Provisions are made to accommodate a 205 ampere-hour battery as an extra-cost option.

E-U80 trucks utilize a 205 ampere-hour battery with the 52-ampere, 12-volt Delcotron as base equipment.

Delcotrons, diode-rectified AC generators, are used with the diesel-powered trucks because of their charging abilities at lower engine speeds where compression-ignition engines operate.

A 23.57 x 29.0 x 1.75 tube and center radiator, similar in design to the C80 production item, is base equipment for D60 models. A 7 psi pressure cap, 5-blade/18-inch diameter fan, a new fan shroud, and new hoses are used.

E and U80 models utilize a 24 x 29 x 2.88 radiator with a 5-blade/22-inch diameter fan, a 7 psi pressure cap, new fan shrouds, and new hoses. The E80 radiator is of the tube and

center design, while the tube and fin arrangement is used for U80 models.

The Clark 264VO, 5-speed overdrive is provided as regular production equipment on the D60 models, D60H models, however, equipped with the 17,000 pound, 2-speed rear axle, utilize the existing 267V model. Although the 264VO unit is new to the Chevrolet lineup, it is almost identical in design and construction to the existing transmission, differing only in that it provides direct drive in 4th gear and .80 overdrive in 5th gear while the 267V has direct drive in 5th gear and no overdrive. Both units feature synchronized gears in 2nd, 3rd, 4th, and 5th; carburized alloy steel gears and shafts; high-capacity bearings; and power take-off provisions on both sides.

E-U80 models also utilize as base equipment a transmission new to the Chevrolet lineup -- the Spicer 5756B close-ratio 5-speed synchromesh unit. It is similar to the Spicer 3152A close-ratio 5-speed presently available on Series 80 models with gasoline engines, but it is engineered for extra-heavy-duty service commensurate with the high-output diesel engine. The 5756B model also has synchronized gears in 2nd, 3rd, 4th, and 5th; carburized gears and shafts; high-capacity ball and roller bearings; and power take-off provisions on both sides.

DIESEL ENGINE SPECIFICATIONS

ITEM	MODEL 4-53	MODEL 6V-53
SERIES APPLICABILITY	D60, D60S, D60H	E-U80
NO. OF CYLINDERS	4	6
BORE (inches)	3.875	3.875
STROKE (inches)	4.500	4.500
DISPLACEMENT (cu in)	212.3	318.4
COMPRESSION RATIO	17-to-1	17-to-1
GROSS BRAKE HORSEPOWER	130 at 2800 rpm	195 at 2800 rpm
NET BRAKE HORSEPOWER	118 at 2800 rpm	183 at 2800 rpm
GROSS TORQUE (lb-ft)	271 at 1500 rpm	423 at 1500 rpm
NET TORQUE (lb-ft)	263 at 1500 rpm	415 at 1500 rpm

DIESEL CHASSIS

FRAME

Frames for diesel models are basically the same as those of the regular line, except for engine and body mounting provisions. While all diesels use an I-beam type, drop-center front engine support crossmember, only E80 Series low cab forward models employ the use of heavy cast malleable iron front body mounting brackets. These brackets are designed to accept the engine rear supports. The only other frame deviation occurs on U80 tilt models where the rear cab support crossmember is approximately six inches higher than that used on the regular line tilt models to provide sufficient chassis-to-cab clearances.

The I-beam front engine support crossmember is bolted to the frame lower flange on the right hand side and to the steering gear frame inner reinforcement on the left hand side. Its position within the frame is approximately six inches forward of the front suspension crossmember assembly.

Series E80 front body mounting brackets extend 5.32 inches higher than those of the regular low cab forward models to accommodate installation of the 6V53 diesel engine. The brackets are bolted to the outer faces of the frame, covering the entire height of the rails.

E-U80 models utilize full-length frame outer reinforcements as regular production equipment, while the reinforcements are optional equipment for D60 models.

FRONT SUSPENSION

Except for the absence of the front engine mounting bracket, diesel model front suspensions remain essentially identical to their gasoline engine powered counterparts. Because standard front springs for these models are one rating higher than those for comparable models of the regular line, the upper control arms on U80 tilt models are designed to incorporate splined torsion bar mounting sockets.

The I-beam front axle option is available only on the E80 vehicles.

REAR SUSPENSION

Rear springs of 9200 pound capacity each are base equipment for D60 models. Springs of

10,400 pound capacity each are available optionally, in addition to auxiliary rear springs and shock absorber equipment. D60H models utilize 11,500 pound capacity rear springs as base equipment.

The 10,400 pound capacity springs are base equipment on E-U80 models, with 11,500 pound capacity springs offered optionally, in addition to rear shock absorbers.

REAR AXLE

The Chevrolet 15,000 pound capacity, single-speed rear axle with a ratio of 6.17-to-1 is base equipment for D60 models. A new Chevrolet 15,000 pound capacity, 2-speed axle with ratios of 5.83/7.95 is available optionally. The axle is shifted electrically for more positive control, dependability, and simplicity of operation. An Eaton 17,000 pound capacity 2-speed rear axle with ratios of 4.87/6.77-to-1 is base equipment for D60H models; mandatory with this 2-speed axle is the optional Clark 267V 5-speed close-ratio transmission.

E and U80 models utilize the Eaton 18,000 pound capacity 2-speed rear axle with ratios of 5.57/7.60-to-1 as base equipment. No optional rear axle is available.

BRAKES

Vacuum-hydraulic, 14 x 2.50 front and 15 x 4.00 rear, brakes are base equipment on D60 models, including a Bendix vacuum pump, reserve tank, and low-vacuum warning light. The vacuum pump is necessitated by the lack of an intake manifold on the diesel engine. D60H models, equipped with a 17,000 pound rear axle are provided vacuum-hydraulic brakes in sizes of 15 x 3.00 front and 15 x 6.00 rear. Options include 15 x 3.00 front and 15 x 6.00 rear air-hydraulic brakes and a Bendix-Westinghouse 7.25 cfm air compressor.

E and U80 models utilize full air brakes as base equipment with 15 x 3.00 front and 15 x 7.00 rear sizes. When the optional 9000 pound capacity front suspension option is used, front brake size changes to 15 x 3.50.

WHEELS AND TIRES

Base wheels and tires for Series 60 and 80 diesel models are the same as those used for regular Series 60 and 80.

Effective truck design oftentimes produces important product improvements and refinements during a current model year. Those incorporated in mid-season 1961 include new Corvan lock strikers, improved body mount retention, greater frame durability, and refined front suspensions. Cast wheels feature sturdier spokes for increased life.

THE 1962 CHEVROLET TRUCK

mid-season
1961
changes

NEW CORVAN LOCK STRIKERS ●

IMPROVED REAR BODY MOUNTS,
SERIES 50-80 ●

INCREASED FRAME DURABILITY ●

SUSPENSION REFINEMENTS ●

GREATER WHEEL STRENGTH ●

mid-season
1961
changes

BODY

ROOF PANEL TRIM PADS for the load compartment of C-K1405 and C3605 panel models are eliminated. The roof panel in this area continues to be finished with silver gray paint.

MISCELLANEOUS BODY EQUIPMENT is available under RPO 348 for the Series 10 Step Vans and includes various special equipment, such as 54-inch wide rear doors, 66-inch wide rear doors, smooth load floor, plywood partition between the driver's and load compartment, roof insulation, side panel insulation, glass for standard and optional rear doors, spare tire carrier, foam rubber padded driver's seat cushion and backrest, dome lamp for load compartment, clearance lamps, right hand outside rear view mirror, fresh air type heater, directional signals and body in prime for fleet owners who prefer to custom paint their vehicles.

SUBURBAN CARRYALL side window center pillar reveal moldings, which define the exterior separation between the two windows on each side of the vehicle, are cancelled.

WEAR IRONS. The floor board wear irons immediately in front of and behind the wheelhouses in the load compartment of panel models are cancelled.

FRONT DOOR SEAL. The closed-cell sponge rubber seal cemented to the upper half of the front door frame of conventional line models is eliminated as a result of tests which indicate adequate door sealing is provided with the remaining door opening seal.

SOLID SAFETY SHEET GLASS replaces laminated safety sheet glass for front door drop-windows of Series C-K-L10 through 50 models. Laminated safety sheet glass for the front doors of these models is offered as a regular production option. No frames are used with the solid glass.

In addition, solid safety sheet glass replaces laminated safety sheet glass for ventpanes of Series C-K-L-M-T10 through 80 models.

PANEL BODY LASH RAILS. Metal replaces wood for the load compartment lash rails of panel body models. The new rails are identical in configuration to the horizontal strainers used for the upper body side outer panels.

FRONT DOOR BUMPERS. The rubber bumpers at the top and bottom of the front door openings of all C-K-L-M10 through 80 Series models, except 02-12 models, as well as the attaching holes in the body lock pillars and rocker panels, are cancelled.

Extensive tests reveal that the bumpers do not significantly contribute to cushioning the closing of the doors or eliminating rattles when the doors are closed.

IMPROVED REAR BODY MOUNTS. Series C-L-M50 through 80, except 02-12 models incorporate a new washer for the number two body mounts, which provides spring action for improved mount retention. The new washer, placed between the bolt head and existing washer, also provides more bearing surface for the bolt head.

MODEL R1254 RAMPGATE LOCKS. The primary locks and safety catch for the rampgate of Model R1254 are revised to assure more positive gate retention. Revisions consist of lengthening slightly the primary lock bolts, increasing slightly the size of the safety catch hook, and releasing a new-design safety catch striker. The new safety catch striker incorporates a window-type opening to receive the hook, eliminating the possibility of the hook disengaging from the striker as was possible with the former lip-type striker.

Along with the above revisions, the loop section of the safety catch release handle is enlarged to facilitate operation of the catch.

NEW 2-STAGE STRIKERS are featured for the double side door locks of Models R1205 and R1206. The new-design striker incorporates two grooves to receive the lock bolt, rather than the single groove previously used. This design affords a measure of safety in the event the doors are not fully closed since the lock bolts will engage with the first groove in the striker plates, preventing the doors from opening. Full door closure is achieved when the lock bolts engage with the second groove in the striker plates. All four striker plates incorporate the new 2-stage locking feature.

ROOF PANEL TRIM PADS for the load compartment area of the Corvan and Greenbrier are discontinued for the remainder of the model year. Paint treatment of the roof panel is unaffected.

CHASSIS

TANDEM AXLE FRAME durability is increased with a heavier-gauge, reinforced second cross-member and the addition of two special gussets to the rear suspension crossmember.

The new second crossmember, fabricated of SAE 1020 steel in place of the former SAE 1010 steel, is increased in gauge thickness to 0.1875 from 0.1562 inches. Additional strength is gained from the full-width reinforcement plate welded to the top inner side of the crossmember. Gauge thickness of the reinforcement is 0.1875 inch.

The new gussets for the rear suspension crossmember are triangular-shaped and have a channel section. Gauge thickness of the gussets is 0.250 inch. One gusset is welded to the left hand front face of the crossmember, while the other gusset is welded to the right hand rear face of the crossmember.

FOUR-WHEEL DRIVE FRAME. Front shock absorber frame mounting bracket durability is increased on all 4-wheel drive models by increasing the gauge thickness to .248 from .179 inches.

NEW SUPPORT CROSSMEMBER. The auxiliary transmission support crossmember, a part of the auxiliary transmission equipment, is increased six inches in length for greater durability. To accommodate installation of the longer crossmember, the attaching holes in the mounting brackets are relocated three inches outboard.

MORE DURABLE FRAMES. Frame assemblies for tandem axle and 2-ton models equipped with the Special Heavy-Duty Equipment Option are revised to incorporate additional rivets for increased durability.

STEERING LINKAGE COMPONENTS for K25 models are revised. The steering knuckle upper roller bearing is replaced with a solid bronze bushing for increased durability and reduced front end shimmy. Other component revisions include .125-inch larger diameter tie-rod sockets and steering knuckle arm boss.

FRONT SUSPENSION crossmembers and bottom plates for regular production 50 through 80 Series trucks are revised to relocate the lower control arm shaft attaching holes .18 inch outboard. Also relocated .18 inch outboard are the steering knuckle upper ball stud tapered holes

on 9000 pound front suspensions. These changes reduce front wheel camber, thus extending tire life.

Front suspension rebound bumper-to-cross-member attachment on 5000, 7000, and 9000 pound front suspensions also is improved. This was accomplished through the use of self-locking, prevailing-torque nuts instead of the former standard nuts and lock washers.

Other improvements to the 9000 pound front suspension include the use of an improved tie-rod ball stud spring, which is shot-peened for increased fatigue life, and a spring back-up plug incorporating a ball stud spring seat stop. The stop prevents the spring seat from restricting spring travel. Heavier-duty pitman and idler arms also contribute to greater suspension durability. Gauge thickness of these components is increased to 1.12 from .84 inches. Heavy cast front suspension-to-frame attaching brackets replace the steel stampings used formerly. The new brackets improve the suspension's ability to withstand high brake torques encountered under heavy loads.

Torsion bar rear anchors for all tandems and vehicles equipped with the Heavy-Duty Chassis Equipment package have been modified to accept a torsion bar anchor tie bar, which spans the underside of the frame side rails transversely. The bar is one-inch in diameter and has threaded ends onto which jam nuts are installed after the bar is fitted through the socket provisions in each anchor. This arrangement not only prevents the anchors from splaying-out, but also increases torsional rigidity of the frame and crossmember at the anchor.

NEW LOWER-CAPACITY REAR SPRINGS are released for C30 models. Rated at 6200 pounds, the new springs improve vehicle trim.

NEW REAR SPRING HANGERS are released for M70 models. Of larger size, the new hangers provide a more sturdy spring attachment.

IMPROVED REAR COIL SPRINGS. Base and RPO rear coil springs for C-P10 and C20 models are redesigned for improved durability. The new springs have a larger pitch diameter, which results in lower stress concentration at the pigtail end.

IMPROVED BRAKE DRUM ASSEMBLIES. Both

regular production and optional brake drum assemblies for Series C-P30 models are improved for greater strength. The improvement results from a new-design web contour and an increase in stock thickness from 0.125 to 0.150 inches.

SERIES 80 DISK WHEEL. The 20 x 7.0 disk wheel for Series 80 models is revised to provide five hand holes instead of six for increased wheel strength.

TEMPORARY USE OF 1960 DESIGN HUB CAP. Until the supply of 15 x 5K wheels having hub cap retention clips is exhausted, Series C-K10 models will utilize the 1960 hub cap design.

DISK WHEELS now are included as a part of the 7000 pound front suspension option for regular Series 60 models, replacing the former cast-spoke wheels. Cast-spoke wheels, however, may be ordered as a separate option.

CAST WHEELS with sturdier spokes for increased wheel life are released for all series applications.

IMPROVED 15 x 5K WHEELS. Fatigue life of 15 x 5K wheels used on C-P10 Series vehicles is increased by enlarging the bead seat radius from 0.17 inch maximum to 0.25 maximum and by eliminating the 0.80 inch bump at the lug locations. The above revisions result in lower stress concentration at the affected areas with subsequent longer wheel life.

C10 FILLER PLUG. The filler plug in the C10 rear axle housing is relocated one-half inch upwards. This change results in an increased static head of oil to the front pinion bearing, improving lubrication of this component.

L61 DRIVESHAFT. A 2-piece design driveshaft replaces the one-piece design formerly used for L61 models. As a result of this change, driveline

stability and component life are increased.

C-P-K10 AXLE HOUSING COVER is revised to increase the flat area near the inside radius. This change improves cover sealing and eliminates interference between the cover and the attaching nuts.

REAR AXLE front pinion bearing lubrication on Corvair 95 models is improved above 30 mph through changes to the 3-speed transmission case. Relocation of the rib below the reverse idler shaft access hole and the addition of a .125-inch diameter drilled hole through the rear face of the case account for this product improvement.

CORVAIR 95 REAR AXLE SHAFTS are redesigned for greater strength and durability. A straight shaft with a constant diameter of 1.296 inches replaces the former tapered shaft whose diameter ranged from 1.310 inches near the hub end to 1.000 inch near the splined end.

18 x 5.0 RIM AND DISK ASSEMBLIES, available optionally for C-P30, C40 models, are redesigned to eliminate the possibility of valve stem failures due to interference with the drum. A bridge washer is welded to the inside of the rim at the valve stem hole, thus raising the valve stem sufficiently to insure clearance between the valve stem and brake drum.

REAR SPRINGS of Corvair 95 models are revised to improve vehicle handling and flatness of ride. A greater spring rate, achieved through larger pitch and wire diameters, results in less rear end "wander" and subsequent more positive vehicle control.

REAR AXLE RATIO. The 3.27-to-1 rear axle ratio, formerly released as part of the 4-speed transmission option on Corvair 95 models is cancelled, making the 3.89-to-1 rear axle ratio available for all transmissions.

trucks are provided with a more durable fuel tank, with metal thickness increased from 20 to 18 gauge. The fuel tank outside dimensions and capacity remain unchanged.

IMPROVED 5-SPEED TRANSMISSION. The 5-speed New Process 540C transmission incorporates several changes which improve its durability. The changes consist of increased-capacity bearing assemblies on both the mainshaft and the countershaft and the addition of nylon inserts to the 4th and 5th speed shifter fork.

The capacities of the mainshaft rear bearing and the countershaft front bearing are increased with three additional bearings for each bearing assembly, from 8 to 11 for the mainshaft bearing and from 9 to 12 for the countershaft bearing. The capacity of the countershaft bearing assembly is further increased with the use of slightly larger diameter bearings.

Reduced wear, as well as quieter operation, results from the addition of nylon inserts to the 4th and 5th speed shifter fork. The inserts are installed in a recess on the inner face of each fork member, and make all the contact with the synchronizer rings.

In addition to the above improvements, ma-

terial specification of the synchronizer rings is changed from bronze to aluminum.

M70 3-SPEED AUXILIARY TRANSMISSION. The diametral pitch of the second speed mainshaft and counter gears of the optional Spicer 3-speed auxiliary transmission is decreased from six to five, resulting in fewer but heavier teeth. The new gear ratios are 2.00-to-1 for first; 1.31-to-1 for second; and 1.00-to-1 for third.

CORVAIR 95 4-SPEED TRANSMISSION. Improved performance results from changes in the 4-speed transmission gear ratios. The new ratios are 3.65, 2.35, 1.44, 1.0 and 3.66-to-1.

NEW AC-45 SPARK PLUGS are released for the 10 through 50 Series 6-cylinder and V-8 models, replacing the former AC-44 size. Because the AC-45 is a "hotter" plug, spark plug fouling during city operation is minimized.

HEAVY-DUTY BATTERY. The 42-ampere, 9-plate battery, formerly available optionally, is now released as regular production equipment for Corvair 59 models to improve cold weather starting.

POWER TRAINS

SHIFT CONTROLS of the 3-speed transmission are redesigned for smoother gearshift operation. A single rod direct from the mast jacket lever to the transmission second and third speed lever is utilized in the new design. This arrangement replaces the former linkage system which consisted of a rod leading from the mast jacket

lever to an idler lever attached to the frame with a bracket, and a short rod from the idler lever to the transmission second and third speed lever. The new, one-piece rod eliminates the two rods, the idler lever, and the frame bracket.

MORE DURABLE FUEL TANK. The M70 Series

THE 1962 CHEVROLET TRUCK

appendix

CUSTOM EQUIPMENT – CONVENTIONAL LINE

RPO 432 – CUSTOM APPEARANCE EQUIPMENT (C-K10 thru 40 Series)

- Silver-anodized aluminum radiator grille and headlamp doors
- Bright windshield reveal moldings
- Bright cab upper rear quarter trim plates
- Bright single-unit body side moldings
- Steering wheel with chrome horn ring
- Bright-trimmed instrument panel control knobs
- Two-tone paint treatment for front door panels, dispatch box door, and Suburban sidewalls

RPO 433 – CUSTOM COMFORT and CONVENIENCE EQUIPMENT (C-D-E-K-L-M10 thru 80 Series)

- Left hand armrest
- Right hand sunshade
- Right hand front door key lock
- Cigar lighter with bright trim
- Special body insulation
- Special seat trim ** (Cabs and Suburbans)
- Special seat padding (**): 3/4-inch foam for backrest; 5-5/8 inch foam for cab cushion; 1-1/2 inch foam rubber for Suburban cushions

RPO 393 – CHROME BUMPER EQUIPMENT (C-K10 thru 30 Series)

- Chrome front bumper – cabs
- Chrome front and rear bumpers – single-unit bodies
- Chrome rear bumper – pickups
- Chrome hub caps *

RPO 383 – SIDE TRIM MOLDING EQUIPMENT

- Bright body and pickup box moldings for Fleet-side pickups. (Includes white paint treatment between upper and lower moldings.)

* – Not available for K models or Models C3603-09 with dual rear wheels.
 ** – Not available for E models.

CUSTOM EQUIPMENT – CORVAIR 95 LINE

RPO 431

- Bright windshield reveal moldings
- Rear door or tailgate ornamental inserts
- Cigar lighter
- Left hand armrest
- Anodized-aluminum trim plate for dispatch box door

RPO 393

- Chrome bumper equipment – front and rear. Includes chrome hub caps except with FOA 132, Wheel Disk Equipment

- Special seat trim
- Special seat padding: 3/4-inch foam for backrest; 1-1/2 inch foam for cushion
- Right hand sunshade
- Two-tone paint treatment for front door panels and steering wheel

SOLID AND TWO-TONE EXTERIOR COLORS

SOLID COLOR OR MAIN TWO-TONE COLOR	SECONDARY TWO-TONE COLOR	OPTION NUMBER*	
		SOLID	TWO-TONE
BEIGE, Desert (New)	WHITE, Cameo	528	558
BLACK, Jet	WHITE, Cameo	500	530
BLUE, Balboa	WHITE, Cameo	508	538
BLUE, Brigade	WHITE, Cameo	507	537
GRAY, Georgian (New)	WHITE, Cameo	522	552
GREEN, Glenwood (New)	WHITE, Cameo	503	533
GREEN, Woodland	WHITE, Cameo	505	535
JADE, Seamist (New)	WHITE, Cameo	502	532
ORANGE, Omaha	WHITE, Cameo	516	546
RED, Cardinal	WHITE, Cameo	514	544
TURQUOISE, Crystal (New)	WHITE, Cameo	510	540
WHITE, Cameo	RED, Cardinal	526	541 fi
WHITE, Pure	RED, Cardinal	521	545 fi
YELLOW, Yuma (New)	WHITE, Cameo	519	549

* – For Step-Vans, all colors ordered under RPO 438 or RPO 439.
 fi – Available for Corvair 95 line only.

EXTERIOR TRIM COLORS

ITEM	COLOR	
Bumpers	Cameo White *fi	
Hub Caps	Cameo White *	
Radiator Grilles	Cameo White *fi	
Sheet Metal Around Grille	Cameo White *fi	
Wheels, Solid Color Models	Jet Black	
Wheels, Two-Toned Models	Main Body Color ** ▼	
Lettering	Radiator Grille, Standard	Jet Black
	Radiator Grille, RPO	Cameo White
	Tailgate	Cameo White X
	Suburban License Lamp Housing	Cameo White X
Outside Rear View Mirror Arms	Main Body Color §	
Outside Rear View Mirror Cases	Jet Black §	

* – Pure White substituted for models with RPO 521 or RPO 545.
 fi – Jet Black substituted for school bus models.
 fi – Yuma Yellow substituted for school bus models.
 ** – Jet Black substituted for Series 40-80 models.
 ▼ – Cardinal Red substituted for models with RPO 541 and RPO 545.
 X – Jet Black substituted for models painted Cameo White or Pure White.
 § – Cameo White substituted on accessory units.

**CORVAIR 95 LINE
INTERIOR COLORS AND MATERIALS**

AREA		MATERIAL	COLOR
Exposed body metal except floor, dash panel, and instrument panel front face		Painted metal	Medium fawn
Floor and dash panels			Charcoal
Instrument panel front face			White
Instrument cluster bezel			Silver
Dispatch box door			White
RPO 431 front door embossment			
Instrument cluster insert			Embossed aluminum
RPO 431 dispatch box insert			
Roof panel inserts		Painted vinyl-covered jute	Medium fawn
Sunshades			
Sunshades	Standard, L.H.		
	RPO 431, R.H.		
RPO 431	Upper	Leather-grain vinyl	Medium fawn or red rh
L.H. armrest	Lower	Plastic	White
Standard seat	Coverings	Pattern cloth	Multi-colored *
	Facings	Leather-grain vinyl	Medium fawn
	Rear of backrest		
RPO 431 seat	Coverings	Nylon-faced pattern cloth	Dark fawn
	Facings	Leather-grain vinyl	Medium fawn or red rh
	Top backrest bolster		
	Rear of backrest		
	Lower backrest bolster		
Steering wheel	Standard	Painted hard rubber	White
	RPO 431		White and medium fawn
Turn signal housing		Painted metal	White
Turn signal lever fl		Polished metal	Bright
Steering column		Painted metal	Charcoal
Parking brake and gearshift lever			
Dome lamp		Plastic	Clear lens with silver base
Air vent knobs			Charcoal
Instrument cluster knobs		Bright metal	Bright
RPO 431 cigar lighter knob			
Rear view mirror		Painted metal	Silver
Front compartment floor mat		Embossed rubber	Charcoal

rh - Red used with gray, red, or white exteriors.
 * - Red, yellow, green, blue, and black stripes with fawn side and center panels.
 fl - Knob is black plastic.

**CONVENTIONAL LINE
INTERIOR COLORS AND MATERIALS ****

AREA		MATERIAL	COLOR
All exposed body metal except instrument panel area below cluster		Painted metal	Medium fawn
Instrument panel area below cluster			White
Instrument cluster bezel			White with Charcoal central embossment *
RPO 432 dispatch box door			White
RPO 432 front door embossment			
RPO 432 Suburban side wall embossments			
Single-unit body roof panel trim pads			Painted vinyl-covered jute
Dash mat facing		Composition board	Charcoal
Sunshades	Standard, L.H.		Medium fawn
	RPO 433, R.H.		
RPO 433 L.H. Armrest	Upper	Leather-grain vinyl	Medium fawn or red rh
	Lower	Plastic	White
Front compartment floor mat		Embossed rubber	Charcoal
Suburban load compartment floor		Ribbed linoleum	
Panel load compartment floor		Painted wood	
Standard seat	Coverings	Embossed leather grain vinyl	Medium fawn
	Facings	Leather-grain vinyl	Light fawn
	Exposed metal portions, if any	Painted metal	Medium fawn
RPO 433 seat (Cabs and Suburbans)	Coverings	Nylon-faced pattern cloth	Dark fawn
	Facings	Leather-grain vinyl	Medium fawn or red fi
	Top backrest bolster		
	Lower backrest bolster		
	Exposed metal portions, if any	Painted metal	Medium fawn or red fi
Steering wheel		Painted hard rubber	White fl
Steering column and hub		Painted metal	
Turn signal housing		Polished metal	Bright
Turn signal lever X			
Column-mounted transmission levers X		Painted metal	Charcoal
Floor-mounted transmission levers X			
Parking brake levers			
Control knobs	Standard	Plastic with metal trim	Charcoal
	RPO 432		
RPO 433 cigar lighter knob			Charcoal with bright trim

* - Instrument panel area beneath door also is white.
 rh - Red used with gray, red, or white exteriors, except panels.
 fi - Red used with gray, red, or white exteriors.
 fl - Column painted charcoal on Series 50-80 models.
 X - Knob is black plastic.
 ** - Except for white steering wheel, tilt-cab interior is carried forward from 1961.

INDEX

A

Appearance equipment, Custom 78
 APPENDIX 77-81
 Assist handles 66
 Auxiliary seat, Corvan 34
 Axles, rear 40-42; 67,74

B

Battery, Corvair 95 75
 BODY 29-35
 Body mounts 30,67
 Brake and clutch pedals 40
 Brakes 41,67,73,74
 Bumper equipment 78

C

Carburetor 51,53,55
 CHASSIS 39-43
 Chassis components:
 Diesel models 67
 Gasoline models 39-43
 Chassis improvements 42
 CHEVROLET TRUCK, THE 1962 4
 Clutch 51,57
 Colors:
 Exterior 21,79
 Interior 22-25; 80,81
 Combustion chamber 53
 Connecting rods 51
 Cooling system:
 Diesel models 66
 Gasoline models 48
 Corvan auxiliary seat 34
 Crankshaft 51,55
 Custom equipment 78
 Custom moldings 20,78
 Custom seat 23,25,35
 Cylinder block 51,53,55
 Cylinder head 51,53,55

D

Delcotron generating system 49,56,66
 Diesel identification plate 62
 Diesel engine specifications 66
 DIESEL MODELS 61-67
 Differential, limited slip 41
 Direction signals 30
 Distributor 51,53,55
 Door locks 30,32
 Driveshaft, L61 74

E

Electrical system, diesel 66
 Engine identification 48,62
 Engines:
 Diesel 64-66
 High Torque 327 50,51
 High Torque 348 52,53
 High Torque 409 54,55
 Exhaust manifold 55
 Exhaust stacks, diesel 64,66
 Exhaust system, diesel 64,66
 Exterior appearance:
 Diesel models 62,63
 Gasoline models 18-20
 Exterior colors 21,79

F

Frame 40,42,43,67
 Frame reinforcements 40,42,67
 Front suspension 40,43,67
 Fuel tank 64,74

G

Gasoline engine identification 48
 Gearshift, 3-speed 74
 Generator 51
 Glass, tinted 30
 Governor 51,53,55
 Grilles, radiator 18,19,62,63
 Gross combination weights 10,13
 Gross vehicle weights 10,13,63

H-I

Headlamps 18,19
 Hood design 18,30,31
 I-beam axles 40,43
 Identification, diesel 11,62,63
 Inserts, exhaust valve seat 53
 Interior appearance 22-25; 63
 Interior colors 22-25; 80,81
 Interior materials 80,81

L-M

Locks, door 30,32
 MID-SEASON 1961 CHANGES 71-75
 Model count 12
 MODEL LINE-UP 9-13
 Molding equipment, exterior 20,78
 Mufflers 4,57

INDEX

O

Oil filters 57
 Oil pan 51,55

P

Paint treatment:
 Exterior 21,79
 Interior 22-25; 80,81
 Piston pin 53
 Pistons and rings 51,53,55
 Power team availability (gasoline) 49
 POWER TEAMS 47-57
 Power teams:
 Diesel models 64-66
 Gasoline models 48-57
 Push rods 51

R

Rear axle 40,41,42,67,74
 Rear nameplate, Corvair 95 19
 Rear suspension 40,67
 Reinforcements, frame 40,42,67

S

Seat belt provisions 30
 Seat construction 34,35
 Seat padding, Custom 35,78

S

Series and models 12,13
 Series designation plate 18
 Signals, direction 30
 Sliding rear window 34
 Steering linkage 40,43
 STYLING 17-25
 Styling, diesel models 62,63
 Suburban second seat 30

T

Tilt-cab pedals 40
 Tilting mechanism 33
 Tires 41,67
 Transmission line-up 49,57,66
 Transmissions:
 Diesel models 66
 Gasoline models 49,57,75
 Two-toning 21,79

V-W

Valves, exhaust and intake 53
 Visibility, improved 30,31
 Water pump by-pass 53
 Weights 13
 Wheelbases 13
 Wheels and tires 41,67,74
 Windows 30,34

Chevrolet Motor Division of General Motors Corporation reserves the right to make changes at any time, without notice, in prices, colors, materials, equipment, specifications, and models, and also to discontinue models.

LITHO-U.S.A.

