

2000 CHRYSLER CIRRUS



OVER THE FIRST 75 YEARS, CHRYSLER ENGINEERING

EXCELLENCE BECAME CHRYSLER HERITAGE. Within the last

10 years, Chrysler cab-forward styling has changed the architecture of the modern automobile. Simultaneously came a fine-tuning so precise that drivers, lured by the sophisticated styling, are captured by the spirited road manners. It is that perfected bonding of engineering heritage, expressive design and exacting agility that comprises the Chrysler lineup for the year 2000. The Chrysler heritage continues: with 300M, purebred descendant of the fabled 300 letter series; with Sebring, the land's best-selling convertible; with Town & Country, the luxury culmination of 16 years of Chrysler minivan leadership; with the 2001 PT Cruiser,* breaking the barriers of conventional design *and* function. With an entire family of elegant and able-bodied offerings that propel Chrysler innovation into the millennium.







Cirrus handling is engineered for a prompt response to driver control input (Cirrus LX shown).

THE CHRYSLER NAME IS SYNONYMOUS WITH

ELEGANCE AND ENGINEERING

— attributes that are especially apparent with a very first look at Cirrus. Here is cab-forward architecture in an affordable sedan with a sporty appearance, spirited power, many no-charge extras and every premium inch a Chrysler. There are two models, specifically defined on pages 19-20. **The luxurious Cirrus LXi**, for example, is equipped with a swift and sturdy 2.5-liter 24-valve V6, plus amenities of a stylized nature, such as a leather-trimmed interior, that are included in an impressive package at no extra charge. The even **more affordable Cirrus LX** has an extensive list of standard features, proffers its own feature package, and is powered by a surprisingly responsive 2.4-liter, DOHC in-line four. From the first time you put the pedal to either Cirrus model and settle into **equally spacious and supportive** interiors, you'll experience road manners refined by over 75 years of engineering heritage, as evidenced by the proud placement of Chrysler's recently reinstated winged seal of excellence. **You're going to like Cirrus.**

The spacious, elegantly outfitted Cirrus interior affords the driver control and comfort within easy reach.









Cirrus LXi in Bright Silver Metal





Cirrus LXi instrument panel and leather-trimmed interior in Cambridge





Cirrus LXI leather-trimmed interior in Camo

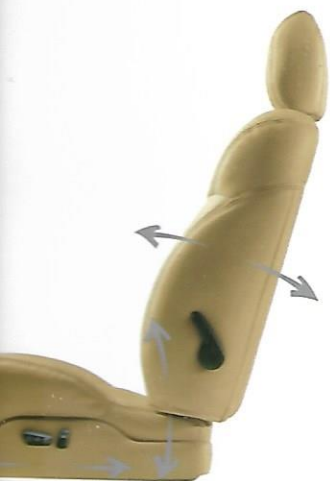

The eight-way power-seat controls consist of two convenient, easy-to-use buttons positioned to move as the seat would move.

The LX standard cloth interior beautifully combines ergonomic technology with the simplicity of sophisticated design.

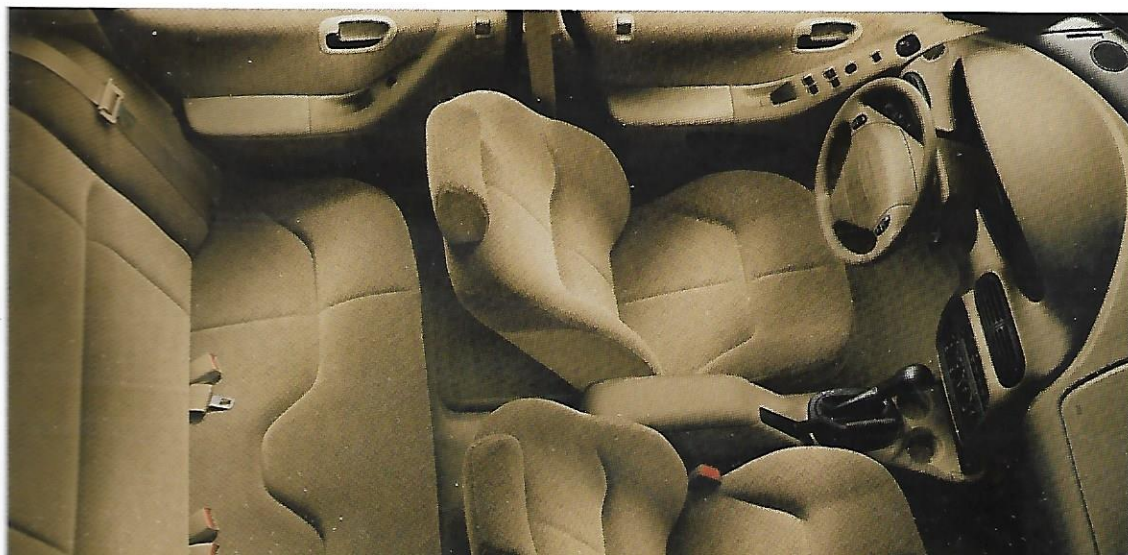

CIRRUS SETS THE STANDARD FOR STANDARD

FEATURES. High-quality crafted, ergonomically engineered and easy to use, the interior amenities in Cirrus abound. Equipped with so many standard features, even the less expensive Cirrus LX is nothing less than loaded. Included in a **no-extra-charge package** on LX are items such as: power windows and door locks, rear floor mats and dual power exterior mirrors. These complement major items like air conditioning and a height-adjustable steering wheel to name but two. Because of cab-forward design, Cirrus allows **plenty of space** for five —and with room to spare. Cirrus' sweeping side curvature provides elbow room a-plenty. The interior cabin area measures a spacious 95.9 cubic feet, while rear-seat passengers comfortably enjoy more than 38 inches of leg room. On LXi, the **no-extra-charge leather-trimmed seating** displays matching leather-wrapped steering wheel and shift knob and a premium sound system provides dramatic musical reproduction with eight speakers in six locations. Even outside, the package is evident, as 15-inch **cast aluminum wheels** accent the sleek styling.

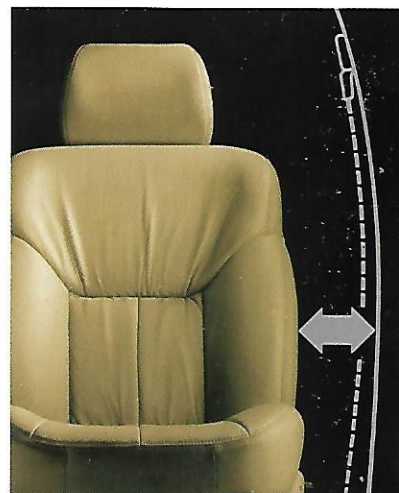

Cirrus' standard folding rear seatback is handy for stowing large items (right).

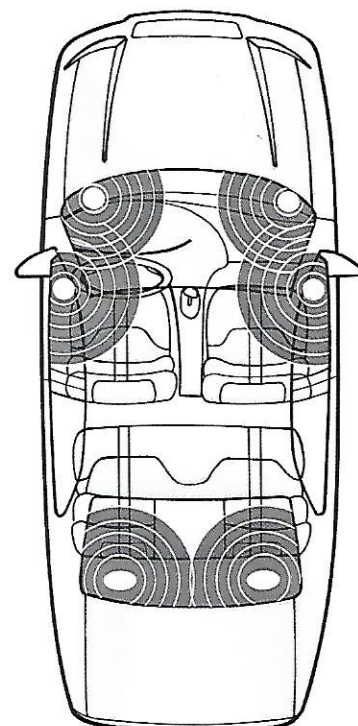

Dramatic sound is achieved at no extra charge through Cirrus LXi's premium sound system with eight speakers in six locations.



Cirrus LXi leather-trimmed interior in Cam

Properly secure all cargo.

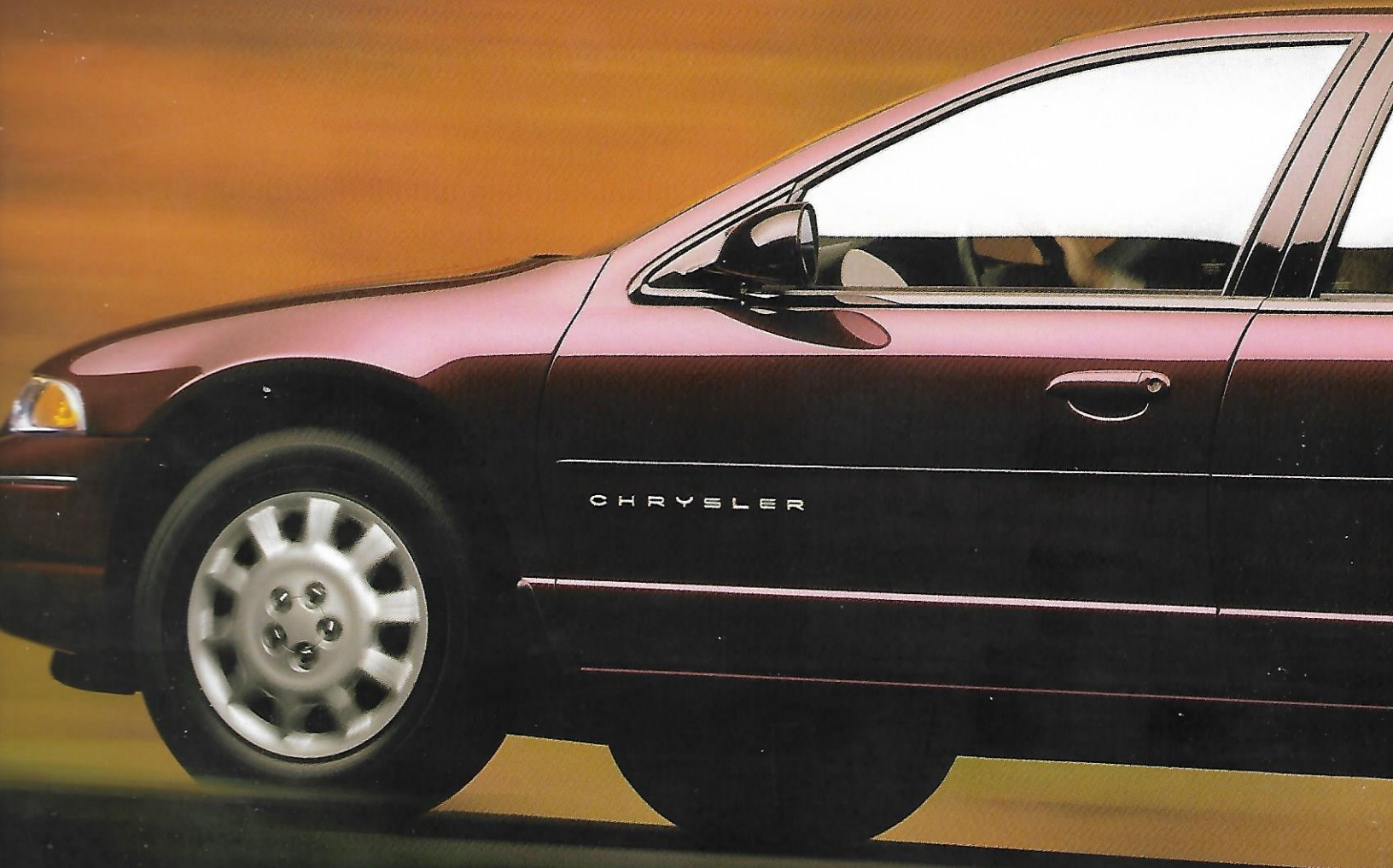

CHRYSLER



Cirrus LX in Deep Cranberry Pearl Coat



Performance and handling are fine-tuned with Cirrus' fully independent double-wishbone suspension system.

CIRRUS' POWER COMES NEATLY PACKAGED in the LXi

model with a 2.5-liter 24-valve V6* under its gracefully sloping hood. The impressive 170 pound-feet of torque produced at 4,350 rpm gives Cirrus

power to go from a stoplight and power to pass on the freeway. The high-

combustion efficiency of four valves per cylinder, in a single overhead cam

design, creates 168 horsepower at 5,800 rpm. Best of all, this **robust**

torque and horsepower hums along smoothly and nearly noiselessly.

The engine block, a lightweight open-deck design, is secured by a unique

four-point engine-mount system to restrain shake and reduce noise. The

engine's sequential multipoint injection system provides balanced fuel

delivery for effective engine response and a steady idle. The **four-speed**

automatic transaxle has been finely engineered to enable its mechanisms

to "learn" an individual driver's habits and then to automatically adjust its

patterns to consistently respond with smooth, precise shifts. **Cirrus**

LX model has a zippy, 2.4-liter 16-valve DOHC inline four-

cylinder engine generating 150 horsepower at 5,200 rpm, and

167 pound-feet of torque at 4,000 rpm.

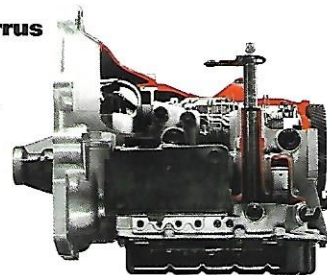
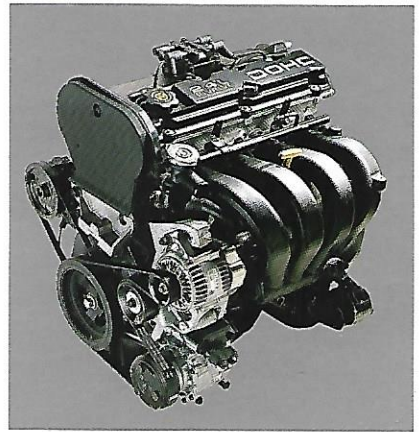
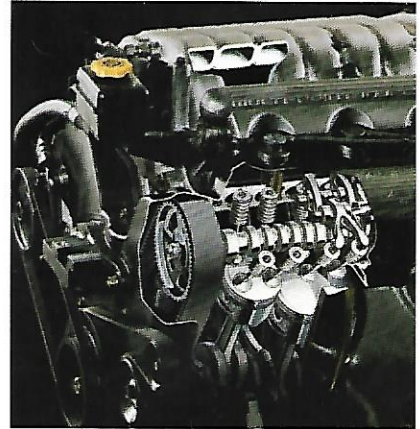

*Built by Mitsubishi Motors Corporation.

† Bright on Bright Silver Metallic, Light Cypress Green and Stone White vehicles.

Available on LXi:

Cirrus Gold Package

- Gold "Chrysler" and "LXi" badging
- Gold front and rear fascia accents†
- Finale chrome aluminum wheels with gold accents



Continuous steel rails lay a sound structural base for Cirrus.

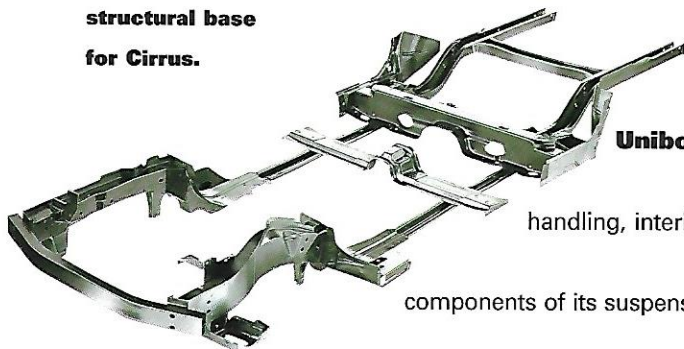

CIRRUS IS AS SOUND AS IT IS SAFE. Vehicle structure and

safety components work in perfect harmony to cradle driver and passengers in comfort and security. It all starts with Cirrus'

Unibody design, which contributes to its roadworthy

handling, interior quiet and occupant safety characteristics. The

components of its suspension system—upper and lower control arms, coil

springs and stabilizer bars—work together to maintain control and reduce

body roll. The wide stance of cab-forward design gives Cirrus its stability

and maneuverability. The expressive design also gives Cirrus an

aerodynamic silhouette that curves into the gracefully raked windshield,

effectively cutting wind resistance and **reducing interior noise**. Safety

is, as with most everything else, standard on Cirrus. Every Cirrus is

equipped with Next Generation driver and front-passenger air bags* child-

protection rear door locks, user-ready child seat top tether anchors for all

rear-seat positions, height-adjustable front shoulder belts and Brake-Park

Interlock on automatic transaxle-equipped vehicles. Unibody construction

and crumple zones absorb front and rear impact, **safety**

cage construction surrounds the passenger compartment

and steel side-guard door beams offer reinforcement left and right.

The rigid strength of Unibody construction improves handling and reduces noise.

*Certified to the Federal Regulations that allow less forceful air bags. Always use seat belts. Remember a backseat is the safest place for children.

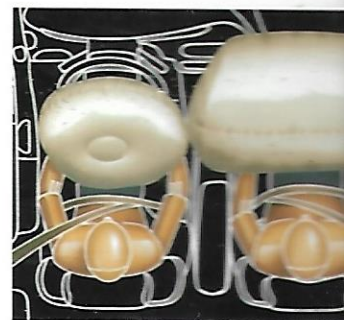

Next Generation driver and front-passenger air bags support a commitment to safety.

Four-wheel disc antilock brakes on LXi improve steering control and stopping power on slippery surfaces.

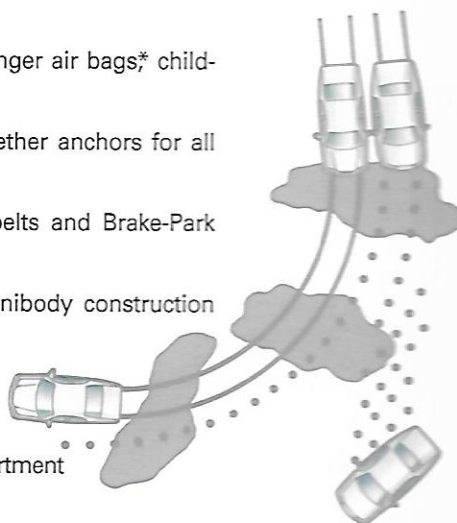



Enjoy Cirrus' optional moonroof — closed with a comfortable tint, full open or tilted up for fresh air.



An AM/FM stereo radio with premium cassette player and in-dash six-disc CD changer with six speakers is optional on both models.



A



An AM/FM stereo radio with CD player, three-band graphic equalizer and six speakers is optional on LX.



ADDED FEATURES—ADDED VALUE. Available features and

accessories can make your Cirrus—an exceptional vehicle loaded with standard features and no-extra-charge items—even more special than it already is. A **premium AM/FM stereo** radio featuring a cassette player, automatic tape head cleaner, changer controls, 100 watts of amplification, 24 station presets and **eight speakers in six locations** (A) is available at

no extra charge on LXi, optional on LX. Standard on LXi is the **HomeLink®**

Universal Transceiver (below left) which can activate three in-home electronic devices — garage door, driveway gate and security lights, for example

— at a touch. **Dart cast aluminum** wheels (B) are included as part of the no-extra-charge package on LXi, optional on LX. Chrome Finale Wheels (C), part of the LXi Gold Package, are available. LX has standard wheel covers (D).

CHRYSLER ACCESSORIES FROM MOPAR include a

protective Front-End Cover with Bug Screen (below) that enhances your Cirrus' appearance. See your Chrysler dealer for a Mopar Accessories catalog.



B



C



D



Mopar's EVS II® Security Plus includes starter disable, two-stage shock sensor, warning siren and more.



CIRRUS STANDARD FEATURES

All Chrysler Cirrus' models include:

- Air Bags* — Next-Generation, driver and front-passenger
- Air Conditioning — Manual temperature controls
- Brake-Park Interlock — Cannot shift out of Park until brake pedal is depressed (automatic transaxle)
- Climate Control Outlets — Rear, located under front seats
- Clock — Digital, integral to all radios
- Coat Hooks — Rear (2)
- Console — Center with storage armrest and cubby bin
- Cup Holders — Front (2); rear stowable (2)
- Defroster — Electric rear window
- Door Locks — Child-protection rear
- Exhaust System — Long-life stainless steel
- Floor Mats — Front, carpeted
- Footrest — Driver's left side
- Glass — Tinted, all windows including solar windshield
- Grille — Dark Charcoal with winged Chrysler medallion
- Instrument Cluster — Analog, with tachometer

Map Pockets — Front doors

Power Accessory Outlet — 12-volt, located in instrument panel

Seats — Front buckets with two-way head restraints, reclining seatbacks and rear bench with folding seatback

Shoulder Belts — Height-adjustable front outboard with traveling buckles

Steering — Power, rack-and-pinion

Steering Column — Height-adjustable

Stone Guards — Front wheel wells, black

Suspension — Double-wishbone, front high-arm with sway bar; rear, low-arm multilink with sway bar

Tires

- P195/65R15 BSW, all-season
- Spare, compact

Trunk Lid Release — Remote

User-Ready Child Seat Top Tether Anchors — At each backseat position to minimize after-market child seat movement

Wiper System — Two-speed with speed-sensitive intermittent mode

*Certified to the Federal Regulations that allow less forceful air bags. Always use seat belts. Remember a backseat is the safest place for children.

LXi NO-EXTRA-CHARGE PACKAGE:

- Automatic power door locks
- Power windows
- Power exterior mirrors
- Eight-way power driver's seat
- Rear floor mats

LXi NO-EXTRA-CHARGE PACKAGE:

- Leather-trimmed seating
- Eight-way power driver's seat
- 15-inch cast aluminum wheels
- Premium sound system

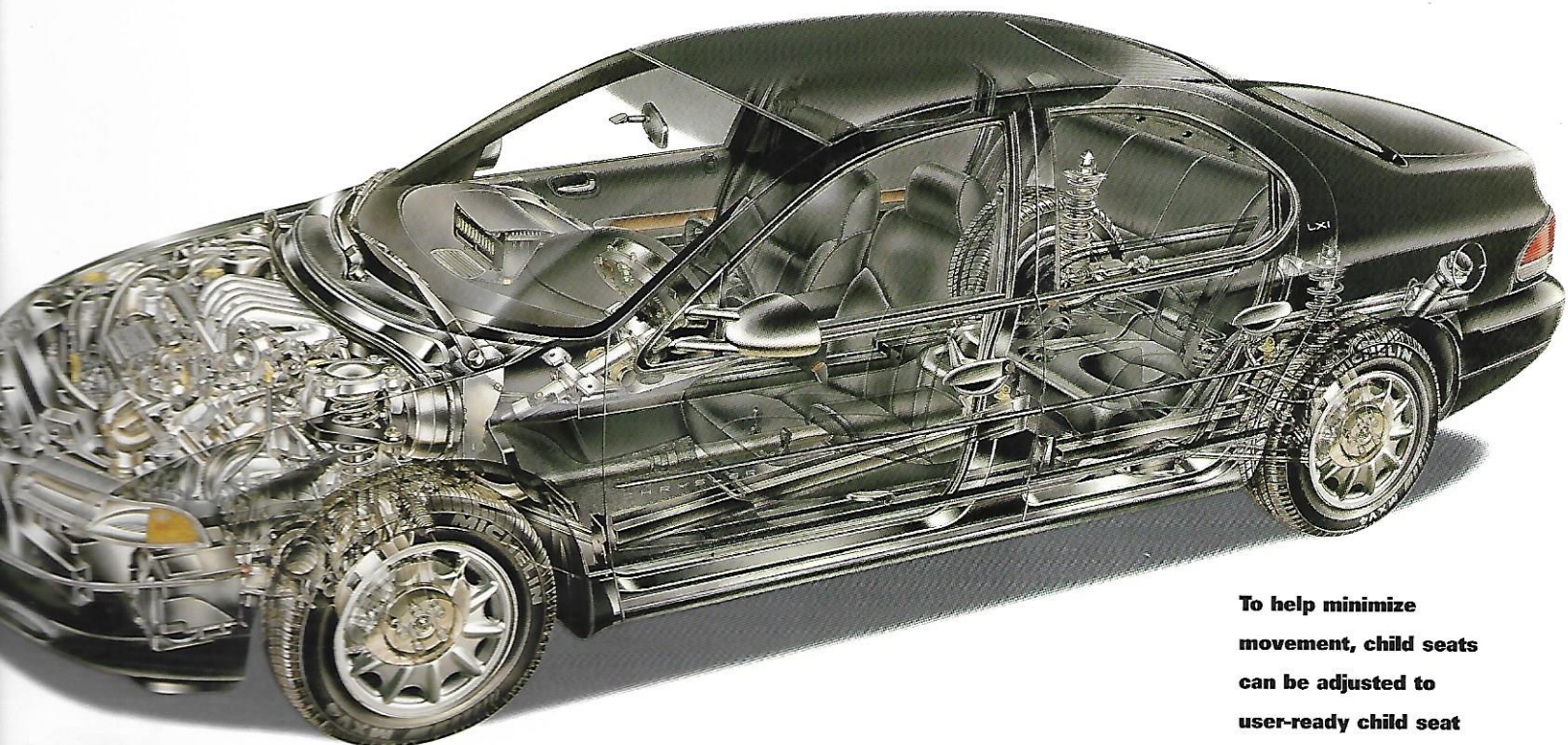

To help minimize movement, child seats can be adjusted to user-ready child seat top tether anchors on the rear window

FEATURES, OPTIONS AND PACKAGE GROUPS

Engines	Transaxles	Cirrus LX	Cirrus LXi
2.4-liter DOHC 16 valve 4-cylinder	4-speed automatic	24B	
2.5-liter SOHC 24V V6 ⁽¹⁾	4-speed automatic		26K
Assist Handles — Overhead for front and rear passengers (included with optional moonroof)		P	●
Brakes			
— Front disc/rear drum		●	
— Front disc/rear drum with antilock		O	
— 4-wheel disc with antilock			●
Cargo Net — Trunk			●
Cold Weather Group		O	O
Door Locks — Power, includes speed-sensitive feature		● ⁽²⁾	●
Fog Lamps			●
Gold Package — Gold "Chrysler" and "LXi" door badging, chrome-aluminum wheels with gold accents and gold front and rear fascia accents (Bright on Bright Silver, Light Cypress Green and Stone White vehicles)			O
HomeLink® Universal Transceiver — Programmable			●
Lighting — Dual front map lamps with courtesy function (included with optional moonroof)		P	●
Mirrors			
Exterior			
— Dual power, twin-post		● ⁽²⁾	●
Interior			
— Dual covered illuminated visor vanity (included with optional moonroof)		P	●
Moonroof — Power		O ⁽²⁾	O
Seats			
— Raven cloth		●	
— Wanderer leather trim			● ⁽³⁾
— Front — 8-way power driver		● ⁽²⁾	● ⁽³⁾
Security Group — Includes remote keyless/illuminated entry, panic alarm and headlamp time delay		O	●
Smoker's Group — Ashtray and lighter		O	O
Sound System			
— AM/FM stereo radio with cassette and six speakers		●	
— Premium AM/FM stereo radio with cassette, changer controls, 100-watt amplifier and 8 speakers in 6 locations		O	● ⁽³⁾
— AM/FM stereo radio with CD player, 3-band graphic equalizer and 6 speakers		O	
— AM/FM stereo radio with cassette, changer controls in-dash six-disc CD changer and 6 speakers		O	O
Speed Control — Electronic with steering wheel-mounted controls		●	●
Steering Wheel			
— Deluxe		●	
— Leather-wrapped			●
Tires — Full-size spare		O	O
Vehicle Security System — Monitors door, ignition and trunk key cylinders, includes Sentry Key™ Engine Immobilizer			O
Wheels			
— 15" wheel covers		●	
— 15" cast-aluminum		O	● ⁽³⁾
Windows — Power with driver's one-touch-down feature		● ⁽²⁾	●

● = Included at no extra charge. P = Included in package noted in parentheses. O = Optional. ⁽¹⁾Built by Mitsubishi Motors Corporation. ⁽²⁾Available for no extra charge. ⁽³⁾Not available with Silver Fern interior.

INTERIOR DIMENSIONS ⁽¹⁾		LX/LXi	EXTERIOR DIMENSIONS ⁽¹⁾		LX/LXi	POWER PLANTS		LX	LXi
Head Room	— Front	38.1	Wheelbase	108.0	Engine Configuration	2.4L DOHC 16V	2.5L SOHC 24V		
	— Rear	36.8	Overall Length	186.0		4-Cylinder	SMPi V6 ⁽²⁾		
Leg Room	— Front	42.3	Overall Width	71.0	Displacement	148.2 CID	152 CID		
	— Rear	38.1	Overall Height	54.1	Compression Ratio	9.4:1	9.4:1		
Shoulder Room	— Front	55.2	Track — Front	60.2	Bore and Stroke	3.44" x 3.98"	3.29" x 3.00"		
	— Rear	54.7	— Rear	60.2	Fuel System	Sequential Multipoint Electronic Fuel Injection	Sequential Multipoint Electronic Fuel Injection		
Hip Room	— Front	52.8	Coefficient of Drag (Cd)	0.31	Horsepower (SAE net @ rpm)	150 @ 5,200	168 @ 5,800		
	— Rear	52.7	Curb Weight (lb)	3,080/3,198	Torque (lb ft @ rpm)	167 @ 4,000	170 @ 4,350		
Seating Capacity — Standard		5	Turning Diameter — Curb-to-curb (ft)	37.0	Maximum Towing Capacity (lb)		1,000		
Passenger Interior Volume (cu ft)		95.9	Fuel Tank (gal)	16.0					
Cargo Volume (cu ft)		15.7							

⁽¹⁾Dimensions shown in inches unless otherwise specified.
⁽²⁾Built by Mitsubishi Motors Corporation.

If you would like to discuss vehicle details or pricing with a knowledgeable advisor before visiting your dealer, call 1-800-CHRYSLER or visit our Web site at www.chrysler.com.

CUSTOMER ONE CARE™

At DaimlerChrysler Corporation, our commitment to complete customer satisfaction is evident in every car and minivan we sell. Long after a vehicle is driven away from the showroom, we will be there to ensure that our customers remain pleased with every new-vehicle purchase. To prove this commitment, all Chrysler vehicles are covered by the 3/36 Customer One Care Plan* which includes a 3-year/36,000-mile (whichever comes first) Bumper-to-Bumper Limited Warranty† and Roadside Assistance‡ for 3 years or 36,000 miles. Roadside Assistance provides 24-hour, 7-day-a-week Emergency Road Service, contacted by a nationwide toll-free number. A 5-year or 100,000-mile Outer-Panel Rust-Through Limited Warranty covers the cost of all parts and labor needed to repair exterior sheet metal panels if perforated by corrosion. The 3/36 Customer One Care Plan stays with the vehicle, transferring automatically to subsequent owners at no cost during the warranty period.

*See your dealer for additional details and a copy of this limited warranty.

†Covers the complete vehicle against defects in materials and workmanship. Excludes wiper blades, clutch disc and brake linings, brake rotors and drums, normal maintenance items (these items are covered against defects for 12 months or 12,000 miles, whichever comes first) and tires (covered by their own manufacturer's warranty).

‡Roadside Assistance services are provided by Cross Country Motor Club, Inc. (In California, Cross Country Motor Club of California, Inc.)

LEASING

Leasing is a popular way to finance a new vehicle, and the **Gold Key Lease** offered by Chrysler Financial Company L.L.C. has the flexibility to fit your vehicle choice and your lifestyle. Lease payments are typically lower and for a shorter term than conventional financing. At lease end, you can: 1) turn the vehicle in and lease a new one; 2) buy the vehicle and keep it; 3) buy the vehicle and sell it for a possible profit. If the idea of driving the vehicle you want and paying less for it sounds great, ask your dealer about Gold Key Lease. **Gold Key Plus** is a great alternative to leasing for customers who want low payments and pride of vehicle ownership — Gold Key Plus offers both. Decide how long the vehicle will be driven and the trade-in value is guaranteed (less excess mileage and wear and tear). Ask your dealer for complete details. **Commercial Finance Options (CFO)** offers several finance and lease options to small and midsize businesses, municipalities and small-fleet operators. A full range of automotive financing is available through Chrysler Financial, providing flexible payment plans and finance products for qualified buyers. Many of these plans can be customized to fit your particular budget and make your new vehicle even more affordable. The **College Graduate Program** is especially attractive to those just beginning their careers. Ask your salesperson for details about any of the above plans.

Chrysler Financial Company L.L.C. programs are offered subject to availability and state and local laws.

DAIMLERCHRYSLER SERVICE CONTRACTS

Additional protection for owners is available through optional DaimlerChrysler Service Contracts. These service plans are available in a variety of time and mileage combinations to meet your driving needs. Ask your dealer for more information or call 1-800-442-2666.

All product illustrations, specifications and competitive comparisons are based upon current information at the time of publication approval. Although descriptions are believed correct, complete accuracy cannot be guaranteed. DaimlerChrysler Corporation reserves the right to make changes at any time, without notice or obligation, in prices, specifications, equipment, colors and materials, and to change or discontinue models. Some of the equipment shown or described throughout this catalog is available at extra cost. See your dealer for the latest information.

Agate, EVIS II, Sentry Key and Customer One Care are trademarks of DaimlerChrysler. HomeLink is a registered trademark of Johnson Controls, Inc.

Always use seat belts. Remember a backseat is the safest place for children.

**FOR MORE INFORMATION ON PRODUCTS OR LEASING:
1-800-CHRYSLER**

EXTERIOR COLORS*/INTERIOR COLORS

Inferno Red Tinted Pearl Coat
Interior: Agate, Camel



Deep Cranberry Pearl Coat
Interior: Agate, Camel



Deep Amethyst Pearl Coat
Interior: Agate, Camel



Light Cypress Green Pearl Coat
Interior: Agate, Silver Fern



Bright Silver Metallic
Interior: Agate



Shale Green Metallic
Interior: Agate, Camel, Silver Fern



Champagne Pearl Metallic
Interior: Agate, Camel



Black
Interior: Agate, Camel



Stone White
Interior: Agate, Camel, Silver Fern



Taupe Frost Metallic
Interior: Agate, Camel



FABRICS*



Agate Wanderer Leather Trim



Camel Raven Cloth



Silver Fern Wanderer Leather Trim

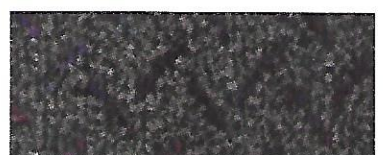

Agate Raven Cloth



*All Chrysler products feature a Clear Coat finish.
†Leather-trimmed seating is a no-extra-charge option on LXI. Cloth seating available in Camel and Agate.

CHRYSLER



ENGINEERED TO BE GREAT CARS