

2000 CHRYSLER LHS



OVER THE FIRST 75 YEARS, CHRYSLER ENGINEERING

EXCELLENCE BECAME CHRYSLER HERITAGE. Within the last

10 years, Chrysler cab-forward styling has changed the architecture of the modern

automobile. Simultaneously came a fine-tuning so precise that drivers, lured by the

sophisticated styling, are captured by the spirited road manners. It is that perfected

bonding of engineering heritage, expressive design and exacting agility that

comprises the Chrysler lineup for the year 2000. The Chrysler heritage continues: with

300M, purebred descendant of the fabled 300 letter series; with Sebring, the land's

best-selling convertible; with Town & Country, the luxury culmination of 16 years of

Chrysler minivan leadership; with the 2001 PT Cruiser,* breaking the barriers of

conventional design *and* function. With an entire family of elegant and able-bodied

offerings that propel Chrysler innovation into the millennium.





THE MOST DISTINCTIVE AND BEST-BRED LUXURY

CHRYSLER EVER, the 2000 Chrysler LHS is the embodiment of

everything we've learned about the art and science of engineering great cars.

The requirements of designing and building a **world-class luxury sedan**

and the skills needed to meet the discriminating requirements of a sophisticated

luxury-car driver are, indeed, formidable. A **no-compromise** approach

that required working from the inside out was instituted. This platform would

grant designers and engineers the ability to obsessively deal with the

details. To achieve optimum strength and rigidity, a "paperless design" body

structure was created with the help of advanced CATIA® computer systems.

A **no-limits-to-creativity** posture helped transform LHS into an

automobile that confidently displays its own distinct, irrepressible personality.

Expressive and elegant styling cues lend a flowing silhouette to LHS' engaging

look. Still, a resolute **no-trade-offs** attitude imparts a lean, athletic pedigree.

One that delivers outstanding road manners and a powerful presence with an

exceptionally smooth engine, a nimble and agile suspension system, and a

silky four-speed automatic. The result is an American luxury sedan of the

highest caliber, shaped by the eyes of artists, but crafted under the expert

scrutiny of engineers. This premium Chrysler speaks in an unpretentious

voice of sheer luxury, comfort and spacious room.

Innovative and stylish. Distinguished jewel-like, world-class, quad projector headlamps provide a broad and long beam pattern.

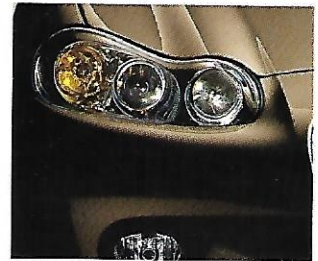

Elegant expression. Classically designed grille is adorned with a distinctive winged medallion reminiscent of the original Chryslers of 1924.



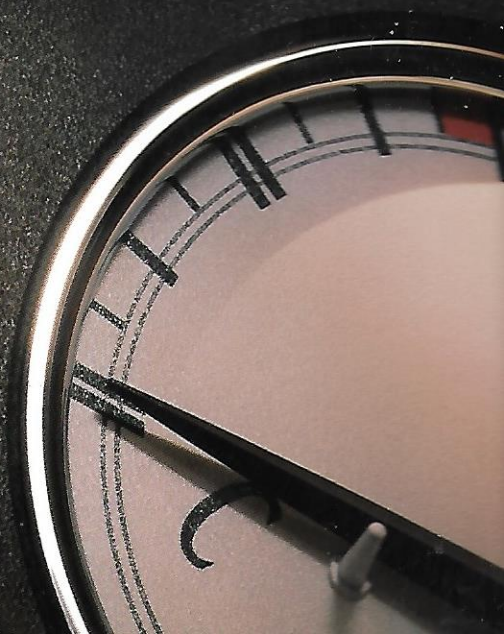
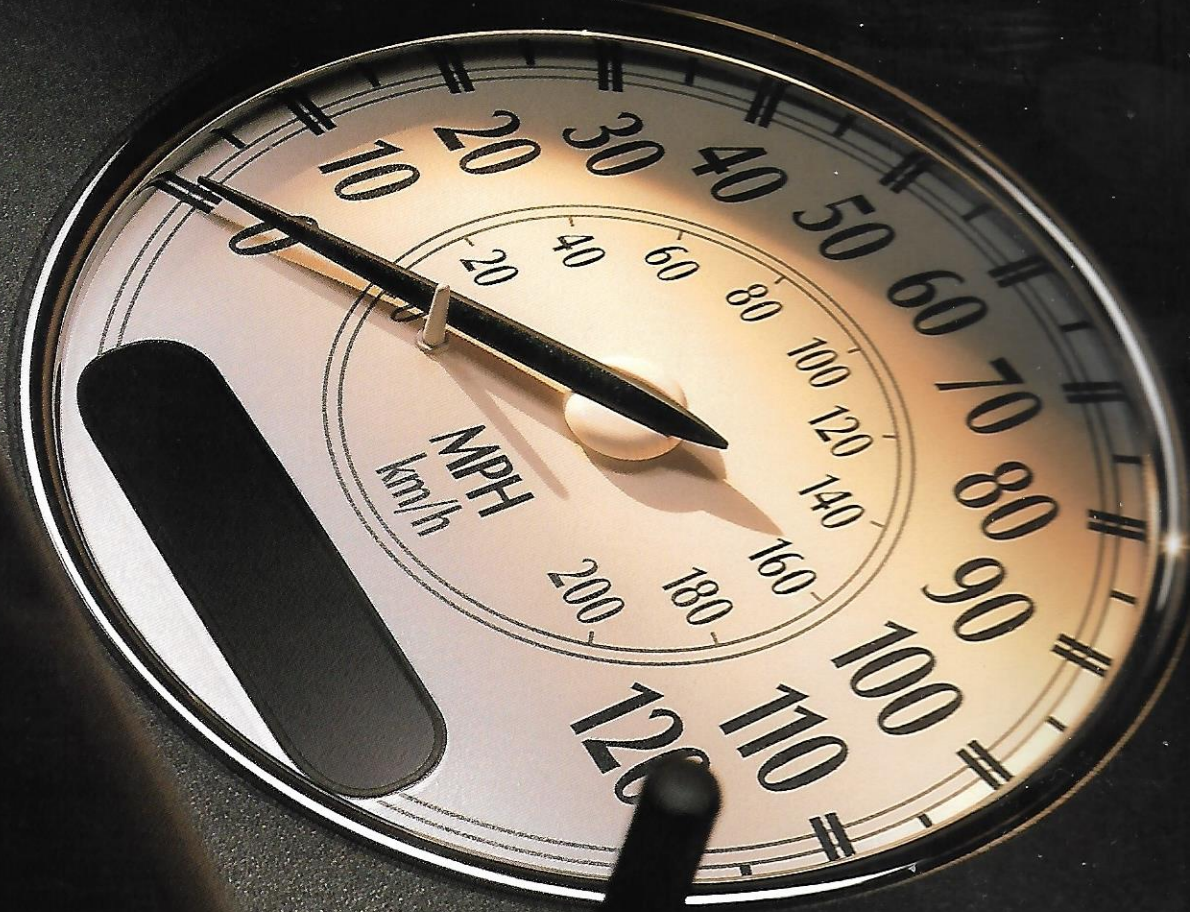





LHS

LUXURY APPOINTMENTS

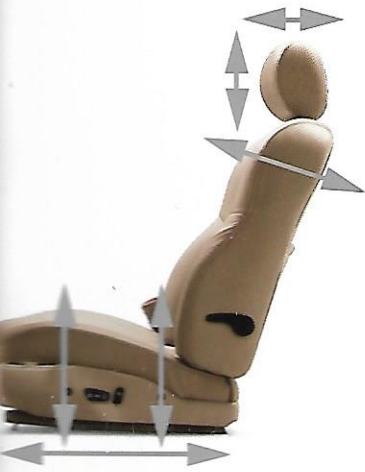

Premium comfort. Eight-way, power-adjustable, heated driver's seat recalls your exact seating position, welcoming you every time you enter.

ONE LOOK WILL TELL YOU that we've devoted quite a bit of attention to the concept of luxury. The 2000 Chrysler LHS elevates the science of automotive ergonomics to an art form. With customer input, we carefully scrutinized the techniques and technicalities of creating the most comfortable and most elegant driving environment possible. Within the **spacious and quiet cabin**, all controls and instrumentation are designed to minimize



distraction while promoting an easy interactive relationship between car and driver. The instrument cluster is reminiscent of handcrafted, Swiss-made

watches. And a **center analog clock** lends the distinguished look of a fine timepiece with ebony hands and an alabaster face. The detailed stitching of the rich, supple **leather-trimmed seating** makes them look handmade. Rich appointments such as woodgrain accents, chrome, and soft-touch surfaces grace the interior with a luxurious, refined look. A 240-watt Infinity Spatial Imaging™ sound system, specifically designed for the acoustics of the interior, fills the silence with breathtaking presence. And a personalized memory system recalls the exact seat position, outside mirror settings, even the radio presets for two drivers. Chrysler LHS is an oasis of sophistication and advanced technology.

For additional information on LHS' luxury appointments, please see page 26.



Information at a glance. Overhead console contains: compass, outside temperature, trip computer, and HomeLink® Universal Transceiver to control three devices.



Exceptionally luxurious. Chrysler LHS' well-appointed interior calls to mind the days of fine custom



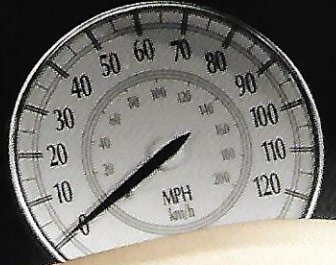







STRUCTURAL INTEGRITY/QUIETNESS

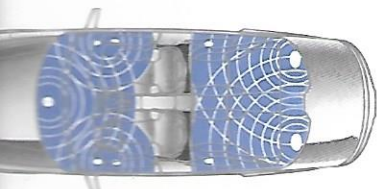

State-of-the-art sound. A remarkably quiet atmosphere lets you enjoy wave after wonderful wave of music from LHS' available 360-watt sound system.

A QUIET INTERIOR IS A COMFORTABLE INTERIOR.

And Chrysler knows that a quiet interior is essential to a customer's satisfaction and motoring pleasure. The remarkable quietness of Chrysler LHS is the result of many continuous improvements and refinements. An **innovative power train/front**

suspension cradle helps reduce transmission of noise

and vibration to the passenger compartment. To help reduce high-frequency noise, all body panels are held to rigid tolerances

of the original design specifications and then robotically sealed with an expandable body sealer. The interior noise level is a substantial **3 decibels**

lower than the previous generation. This was achieved by paying careful attention to power train sound quality, suspension components,

and wind/exterior noise intrusion factors. A **cross-car**

beam bolted to the cowl sides beneath the instrument panel increases body rigidity and helps eliminate annoying buzzes,

squeaks and rattles. From the exhaust system to the air conditioner compressor, every aspect of Chrysler LHS was examined and, if necessary, refined and

improved. And as an enhancement to LHS' quiet interior, a **new rear**

wheelhouse silencer* helps to stop road noise from entering the cabin.



Quieter braking. Fully independent, touring suspension utilizes MacPherson struts up front with quieter-operating disc brake linings.

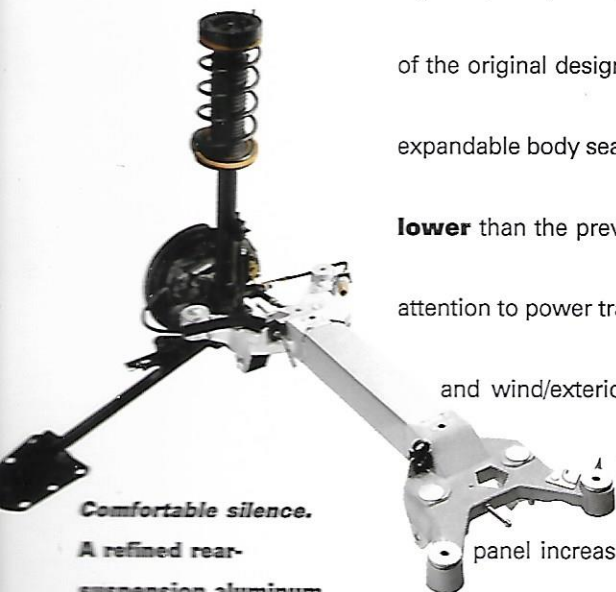

Comfortable silence. A refined rear-suspension aluminum crossmember produces a low-noise path transmission for a very quiet passenger compartment.



A solid and silent ride. Designed with advanced computers, LHS' Unibody shell provides 37% greater torsional

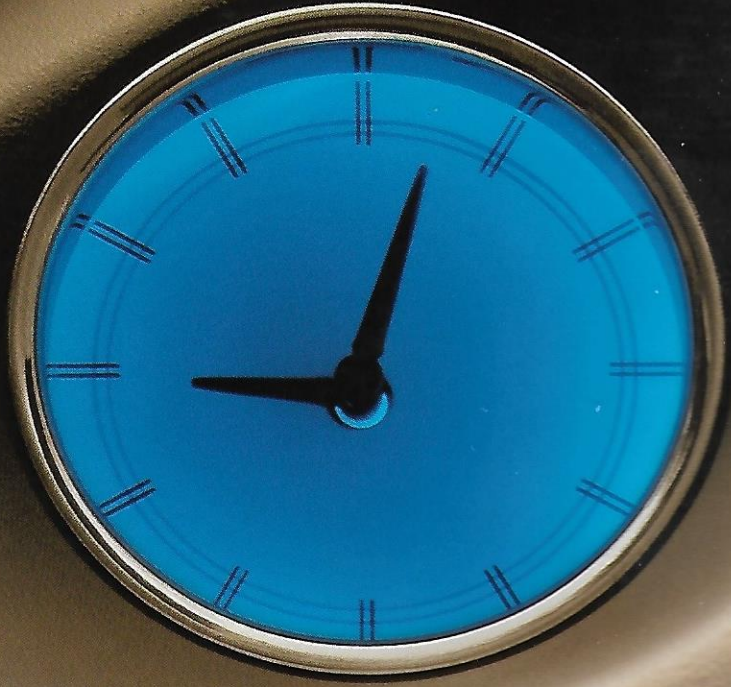



CHRYSLER



Chrysler LHS in Champagne Pearl Metallic



A remarkable advantage. LHS' V6 engine offers the convenience of 100,000-mile tune-up intervals by employing platinum-tip spark plugs.*

Technologically advanced. 3.5-liter High-Output SOHC 24-valve V6 engine combines the driveability and performance attributes of most premium-fuel V8 engines with the efficiency of a V6 that requires only midgrade fuel.†



IN ADDITION TO ANALYZING THE SUBTLETIES of form, comfort and elegance that combine to establish a blueprint for the sum and substance of LHS' premium driving experience, we've also investigated the fine points of performance, handling characteristics and agility. Luxury car owners know there's more to a luxury car than just the interior—luxury should extend **throughout** the vehicle. In Chrysler LHS, it does. Singular among these aspects is the all-aluminum **3.5-liter High-Output V6** (see below). This vigorous 253-horsepower† engine is an engineering tour de force that renders increased performance with an economical operating cost. The power plant was designed to be a **"dry engine"** and is so well-made that it's unlikely you'll ever see a drop or even a film of oil on the outside areas. Equally important but more subtle technologies are also used throughout every LHS: **Variable-assist speed-sensitive power steering**

for crisp, outstanding steering response and precision—low assistance at highway speeds and high assistance at low speeds.

100,000
M I L E T U N E - U P

Fully independent suspension not only reduces harshness and noise (see page 14), but also helps diminish front-end acceleration rise and brake dip to keep the car body level. Chrysler LHS is engineered to meet your highest expectations... and then exceed them.

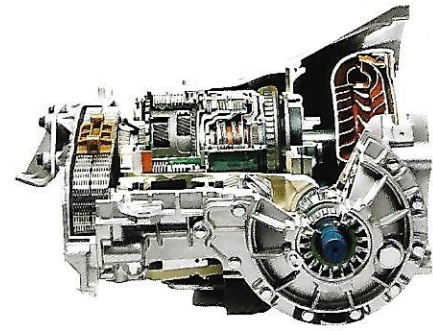

Exceptionally smooth. Four-speed electronically controlled automatic transaxle utilizes engine torque management with the V6 to deliver the power smoothly.



SAVVA

2014

SAVVA

2014







Chrysler LHS in Cinnamon Glaze Metallic

NEXT-GENERATION CAB-FORWARD

CHRYSLER LHS SET A UNIQUE DESIGN COURSE

by taking Chrysler's celebrated cab-forward architecture to the next level.

This **next-generation design** utilizes a single form that cleanly

integrates the roof and the lower body. To the eye, these

lines display a sense of motion by flowing smoothly

and evenly from hood to trunk lid. From the

front, the roof pillars curve precisely into

the body sides, and the side window

shapes form a continuous line. In profile,

LHS has an expressive, driver-oriented

flavor that's accentuated by a gently rising

beltline. In addition to complementing exterior

styling and aesthetics, LHS' next-generation, cab-forward

design enhances functionality. There's more shoulder room and a larger

trunk than in the previous generation. Window openings nestle down into

the sides of the body, lowering the beltline to increase the solar control glass

area and visibility. LHS' design architecture not only allows a beautiful

and eye-pleasing styling effect, but it also widens the wheel track for superb

agility and stability. By pushing the envelope on exterior and interior design,

Chrysler is engineering tomorrow's technology into the 2000 LHS today.

Wide-open and roomy. 18.7-cubic-foot trunk features a convenient cargo net to help hold items in place.

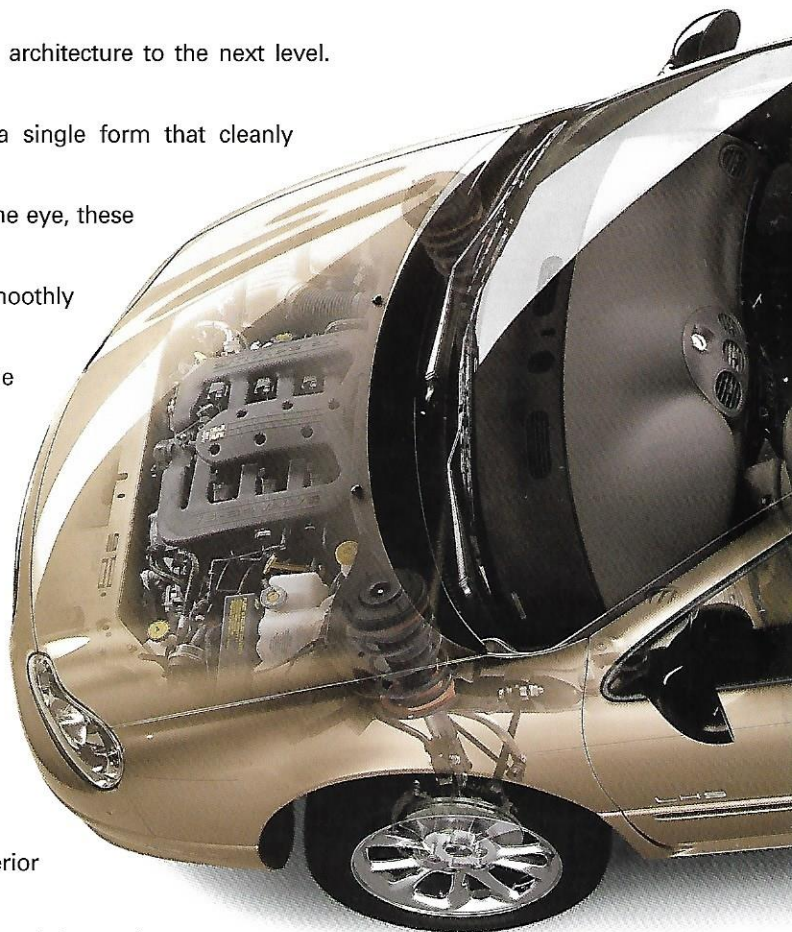

Cab-forward advantage. LHS' design allows a continuous exterior silhouette with an aerodynamic .312





Nowhere are cab-forward benefits more abundant—and appreciated—than in Chrysler LHS' comfortable and roomy interior. There's ample rear-seat leg room and front-seat hip room, abundant shoulder room, plenty of cargo room, and most importantly—more than enough luxurious room to stretch out in, with **107.3 cubic feet of interior passenger volume**. Equally important to the comfort in LHS is the comfort of getting into LHS. And that's easily accomplished through the wide door openings. Chrysler's innovative cab-forward design moves the rear wheels and housings back to create larger door openings for passengers entering or exiting.

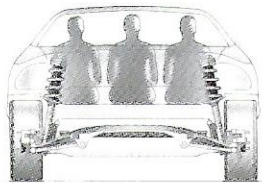

Comfortable and spacious. Pushing the front and rear wheels toward the corners increases the overall width and provides more hip and shoulder room.

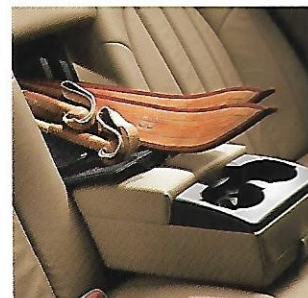

Added convenience. Trunk pass-through easily allows long objects to extend from the trunk into the passenger compartment.

Properly secure all cargo.

THE FIRST REQUIREMENT OF A WELL-ENGINEERED

AUTOMOBILE is to give its driver and passengers a confident feeling

of safety and security. That's why Chrysler LHS features **Next Generation**

driver and front-passenger air bags* that utilize smokeless inflator

technology and seamless air bag covers. Patented tubular, ultra-high tensile-

strength steel side-guard door beams and other body reinforcements help

LHS meet federal dynamic side-impact protection standards. **Low-Speed**

Traction Control functions at speeds up to 35 mph, and works in tandem

with the antilock brakes' speed sensors to detect wheel-slip, applying

brake pressure to the spinning wheel(s) as needed. A **Vehicle Security**

System deters break-ins. In addition, **new user-ready child seat**

top tether anchors provide added safety to minimize add-on child

seat movement in any backseat position. A **new automatic transaxle**

Brake-Park interlock system prevents shifting from Park unless the

brake pedal is depressed. Also, the **seat belt cluster warning lamp**

stays lit until the driver's seat belt is fastened. And LHS meets the revised

upper interior head impact protection standards required for 2003.

Sure stopping ability. High-performance four-wheel disc antilock brake system provides positive, consistent pedal feel, plus increased fade resistance.

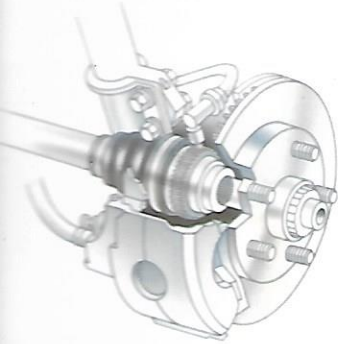

Extra security. Sentry Key™ Engine Immobilizer system offers additional protection against theft.



*Supplemental protection. In addition to height-adjustable, three-point Unibelt front seat belts, every LHS is equipped with Next Generation driver and front-passenger air bags.**



Chrysler LHS in Champagne Pearl Metallic

CHRYSLER LHS FEATURES/OPTIONS



Attention to detail. Refined and elegant chrome accents grace LHS' luxurious interior environment.

YOU WON'T FIND A LONG CAFETERIA-STYLE LIST

of available options for the 2000 Chrysler LHS (see page 29). So completely equipped is LHS, that just about the only thing you have to decide is the color.

In addition to some of the available items shown here, there's also an optional **power moonroof with express-open feature.** LHS' full complement

of features includes many improved or luxury items: • **Seat glide** feature — a first for a Chrysler vehicle — makes driver entry and exit effortless by sliding the seat rearward when the key is removed or the remote keyless entry is used. The seat returns to the preselected position when the seat belt is used or the ignition is turned on. • Leather-trimmed, heated eight-way power driver and front-passenger seats. • Improved defroster and improved rear window defogger system clears glass quicker with a 45-percent increase in power density. • **Battery saver** feature turns your exterior lights out in 10 minutes if you forget. • "Smart Start" feature prevents grinding of the ignition

starter. • **Radio antenna** is integrated into rear window to prevent vandalism or breakage.

• Dual power-heated folding exterior mirrors. • Air conditioning with automatic temperature control.

• Rear armrest storage with dual cup holders.

• Power door locks, windows and trunk release. • Front and rear floor mats with driver-side tie-down. • **Aluminum hood** construction for less weight

and better fuel economy. • **Trunk cargo net** helps keep items secure.



Good-looking complements.

(A) LHS' available 17-inch chrome aluminum wheels.

(B) Standard 17-inch cast aluminum wheels.



Pure enjoyment. Available 360-watt AM/FM stereo radio with cassette player. For 2000, this upgrade includes a four-disc, in-dash CD changer. See pages 28-29 for full sound system information.



Within reach. Front armrest storage with convenient dual cup holders.

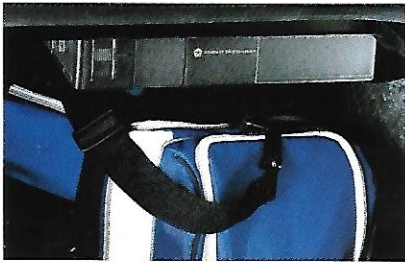

Trunk-mounted six-disc CD Changer is activated by a handheld controller and features an easy-change magazine. Dealer-installed.

GENUINE MOPAR ACCESSORIES. Every Mopar product is designed for exceptional quality and fit, and is intended to integrate perfectly with the new 2000 Chrysler LHS. To express your personal taste and style, there's no better way than with Mopar Accessories. How about taking your fun with you by adding a **Removable Roof Rack** fitted with either a Mopar **Bike or Ski and Snowboard Carrier**? What about a **Vehicle Cover** for maximum overall protection? Or maybe a **Molded Cargo Tray** to help keep order in LHS' cavernous trunk? And don't forget Mopar's Premium Appearance Products to keep it all looking shiny and new. Whether it's a state-of-the-art sound system or a protective **Front-End Cover** with LHS Logo, you'll find a wide variety of ways to enhance your Chrysler LHS. With Genuine Mopar Accessories, there are all kinds of options. For a complete listing of available Mopar Accessories, see your Chrysler dealer for a brochure.



Ski Pass-Through Bag will keep your skis and LHS' interior protected while helping to keep cold air out.

Properly secure all cargo.



Mopar's EVS II[®] Security Plus system includes starter disable, two-stage shock sensor, warning siren and more.



CHRYSLER LHS SPECIFICATIONS

All Chrysler LHS models include:

Air Bags — Next Generation environmentally friendly driver and front-passenger*

Air Conditioning — Automatic temperature control

Antenna — Integral to rear window

Assist Handles — Overhead for front and rear outboard passengers

Battery Saver Feature

Brake-Park Interlock — Cannot shift out of park until brake pedal is depressed

Brakes — Four-wheel disc with antilock

Cargo Net — Trunk

Chrysler Memory System — Includes two personalized settings for driver's power seat adjustments, power exterior mirrors and radio station presets

Climate Control Outlets — Rear, located in the rear of standard center console

Clock

— Analog, integral to instrument panel

— Digital, integral to all radios

Coat Hooks — Front (2) and rear (2)

Console

— Overhead, includes twin map lamps, compass, display for outside temperature, trip computer and HomeLink® Universal Transmitter

— Floor, includes cup holders, coin holder, cassette and CD storage and rear-seat heat and A/C outlets

Cup Holders — Front, two

Defroster — Electric rear window

Door Locks

— Child-protection rear

— Power, includes auto speed-sensitive feature

Dynamic Side-Impact Intrusion Protection — Patented design includes steel side-guard door beams and structural body reinforcements

Floor Mats — Front and rear, carpeted with driver's floor mat tie-down

Glass — Solar-control

HomeLink Universal Transceiver — Programmable, three-function remote controls for garage door opener and interior/exterior home lighting and security devices

Lighting

Exterior

— Quad-halogen headlamps with automatic on/off feature

— Fog lamps, integral to front fascia

Interior

— Dual front map lamps, rear reading lamps above each door, glove box and trunk lamps

Map Pockets

— Front doors

— Driver and front-passenger seatback

Mirrors

Exterior

— Dual power heated with memory feature

Interior

— Automatic dimming day/night rearview

— Dual illuminated covered visor vanity

Power Accessory Outlet — 12-volt, located in instrument panel

Remote Keyless Entry System — Controls for power door locks, illuminated entry system, trunk lid release, panic alarm, Vehicle Security System and Chrysler Memory System; includes two transmitters

Seat Belt Cluster Telltale (LED) — Stays on until driver buckles up

Seat Belts — Height-adjustable driver and front-passenger

Seats

Trim Material

— Royale leather-trim

Front

— Heated buckets with eight-way power driver and front-passenger seats, driver's manual lumbar support and four-way adjustable head restraints

Rear

— Contoured bench with trunk pass-through and armrest with storage and cup holders

Sentry Key™ Engine Immobilizer — Theft deterrent system with encoded key; includes two Sentry Keys

Shift Knob — Leather-wrapped

Sound System — AM/FM stereo radio with cassette and CD player, Infinity Spatial Imaging sound system with 240-watt amplifier and nine speakers in seven locations

Speed Control — Electronic with steering wheel-mounted controls

Steering — Speed-sensitive, power-assisted, rack-and-pinion

Steering Column — Tilt

Steering Wheel — Leather-wrapped

Suspension

Front

— Independent with gas-charged MacPherson struts and stabilizer bar

Rear

— Independent multilink with Chapman struts and stabilizer bar

Tires

— P225/55R17 all-season touring

— Spare, compact

Traction Control — Low-Speed

Trunk Lid Release — Remote, power

User-Ready Child Seat Top Tether Anchors — In all backseat positions

Vehicle Security System — Monitors doors, ignition and trunk key cylinders

Wheels — 17-inch Razorstar aluminum

Windows — Power with driver's one-touch-down feature

Wiper System — Windshield, two-speed with speed-sensitive intermittent mode

*Certified to the Federal Regulations that allow less forceful air bags. Always use seat belts. Remember a backseat is the safest place for children.

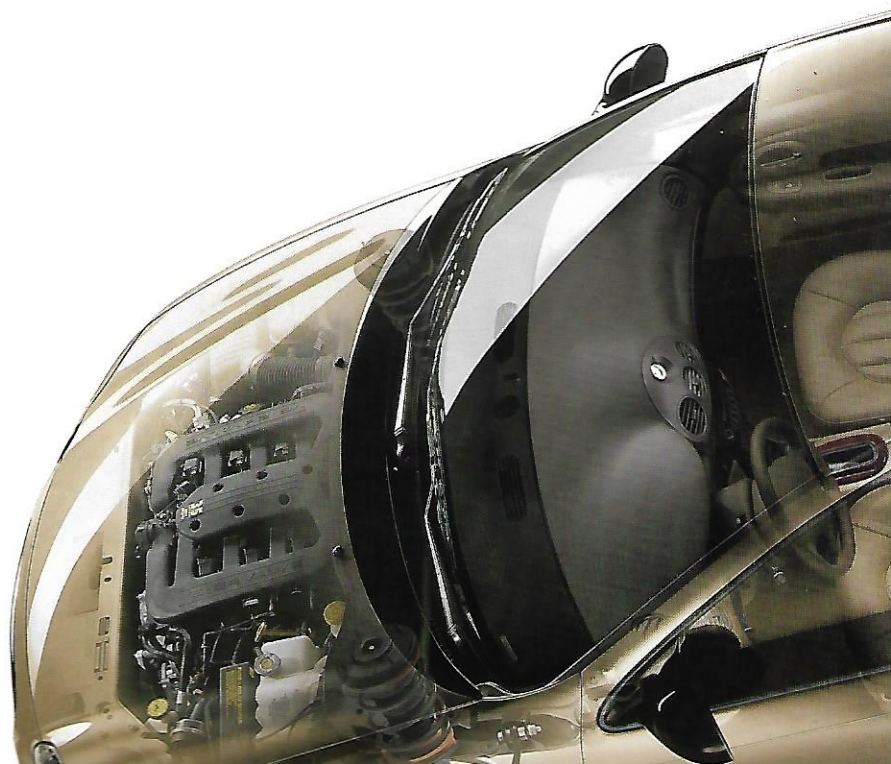

ADDITIONAL FEATURES AND OPTIONS

Engine	Transaxle	LHS
3.5L High-Output SOHC 24V SMPI V6	4-speed automatic	26J
Cold Weather Group — Includes engine block heater and battery heater		0
Smoker's Group — Rear ashtrays and front lighter		0
Sound System — AM/FM stereo radio with cassette, 4-disc in-dash CD changer, Infinity II Spatial Imaging™ Sound System with 360-watt amplifier and 11 speakers in 9 locations		0
Sunroof — Power, with express-open feature		0
Tires — Spare, full-size with matching wheel		0
Wheels — 17" chrome aluminum		0

INTERIOR DIMENSIONS⁽¹⁾

Head Room	— Front	38.3
	— Rear	37.2
Leg Room	— Front	42.2
	— Rear	41.6
Shoulder Room	— Front	58.8
	— Rear	58.4
Hip Room	— Front	57.4
	— Rear	59.3
Seating Capacity — Standard		5
Passenger Interior Volume (cu ft)		107.3
Cargo Volume (cu ft)		18.7

EXTERIOR DIMENSIONS⁽¹⁾

Wheelbase	113.0
Overall Length	207.7
Overall Width	74.4
Overall Height	56.0
Track — Front	61.9
— Rear	61.6
Base Curb Weight (lb)	3,564
Fuel Tank (gal)	17
Turning Diameter — Curb-to-curb (ft)	37.6
Maximum Towing Capacity (lb)	2,000
Coefficient of Drag (Cd)	.312

⁽¹⁾Dimensions shown in inches unless otherwise specified.

SPECIFICATIONS

Engine Configuration	3.5L SOHC High-Output 24V SMPI V6
Displacement	215.00
Compression Ratio	10.1:1
Bore and Stroke	3.78" x 3.15"
Fuel System	Sequential Multipoint Electronic Fuel Injection
Horsepower (SAE net @ rpm)	253 @ 6,400*
Torque (lb ft @ rpm)	255 @ 3,950*

*When using midgrade unleaded fuel. This engine will operate safely and satisfactorily on regular unleaded fuel.

If you would like to discuss vehicle details or pricing with a knowledgeable advisor before visiting your dealer, call 1-800-CHRYSLER or visit our Web site at www.chrysler.com

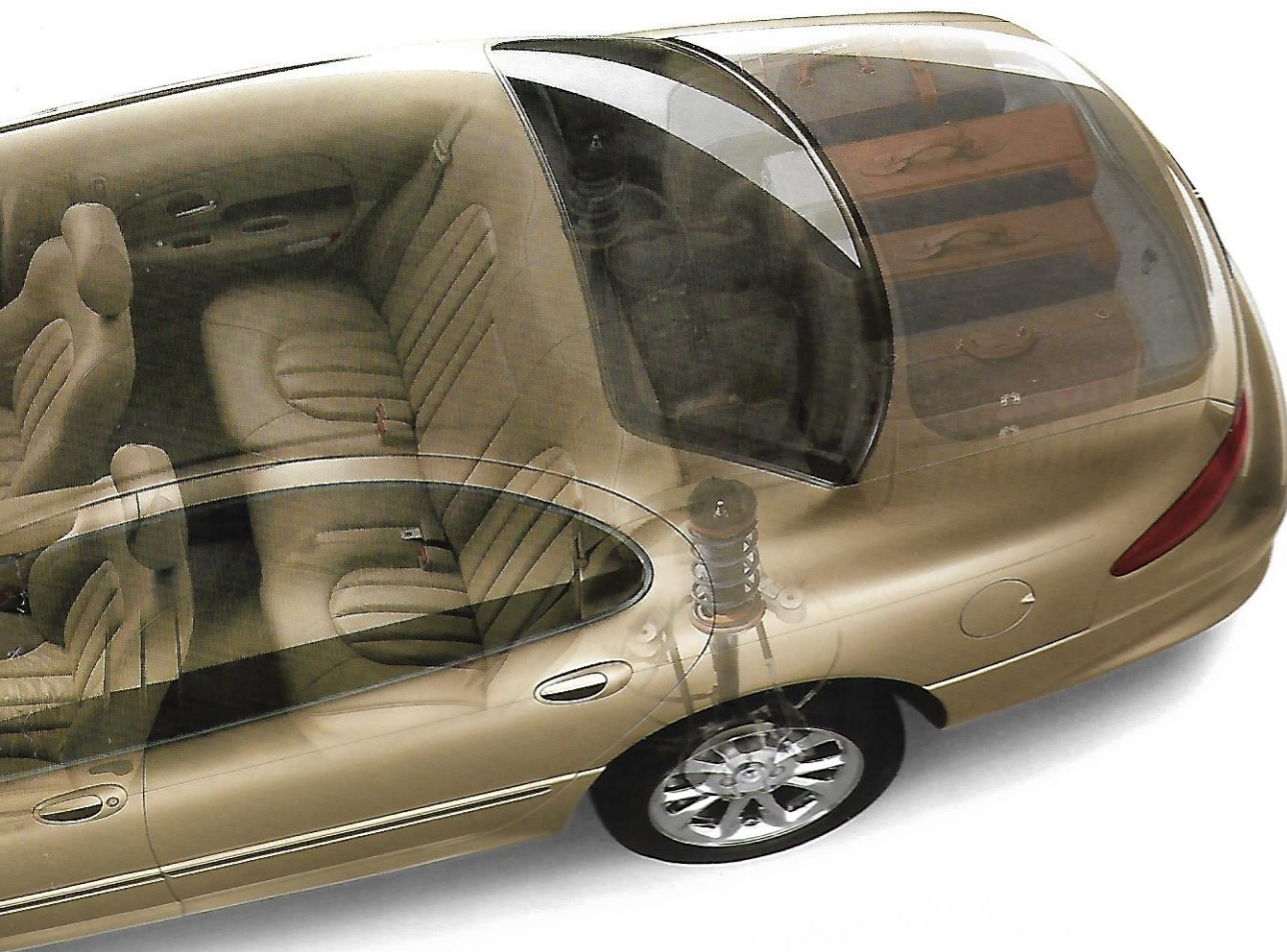

To help minimize movement, child seats can be adjusted to user-ready child seat top tether anchors on the rear window filler panel at each backseat position.

Exterior Colors/Interior Colors



Dark Garnet Red Pearl Coat
Interior: Camel, Light Pearl Beige, Agate



Cinnamon Glaze Metallic
Interior: Camel, Light Pearl Beige, Agate



Champagne Pearl Metallic
Interior: Camel, Light Pearl Beige, Agate



Shale Green Metallic
Interior: Camel, Light Pearl Beige, Agate



Steel Blue Pearl Coat
Interior: Light Pearl Beige, Agate



Deep Slate Pearl Coat
Interior: Camel, Light Pearl Beige, Agate



Bright Silver Metallic
Interior: Agate

Stone White
Interior: Camel, Light Pearl Beige, Agate

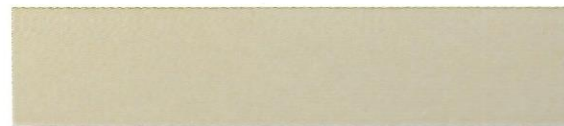

Light Cypress Green Pearl Coat
Interior: Light Pearl Beige, Agate

Interior Colors

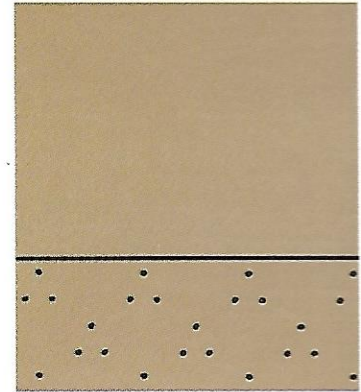

Camel Leather trim

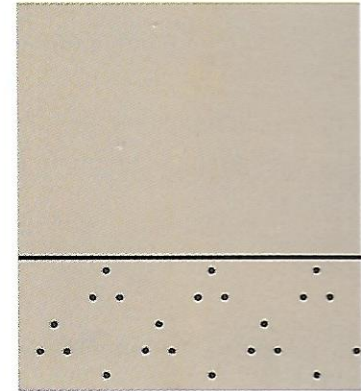

Light Pearl Beige Leather trim



Agate Leather trim

At DaimlerChrysler Corporation, our commitment to complete customer satisfaction is evident in every car and minivan we sell. Long after a vehicle is driven away from the showroom, we will be there to ensure that our customers remain pleased with every new-vehicle purchase. To prove this commitment, all Chrysler vehicles are covered by the 3/36 Customer One Care Plan,* which includes a 3-year/36,000-mile (whichever comes first) Bumper-to-Bumper Limited Warranty† and Roadside Assistance‡ for 3 years or 36,000 miles. Roadside Assistance provides 24-hour, 7-day-a-week Emergency Road Service, contacted by a nationwide toll-free number. A 5-year or 100,000-mile Outer-Panel Rust-Through Limited Warranty covers the cost of all parts and labor needed to repair exterior sheet metal panels if perforated by corrosion. The 3/36 Customer One Care Plan stays with the vehicle, transferring automatically to subsequent owners at no cost during the warranty period.

*See your dealer for additional details and a copy of this limited warranty.

†Covers the complete vehicle against defects in materials and workmanship. Excludes wiper blades, clutch disc and brake linings, brake rotors and drums, normal maintenance items (these items are covered against defects for 12 months or 12,000 miles, whichever comes first) and tires (covered by their own manufacturer's warranty).

‡Roadside Assistance services are provided by Cross Country Motor Club, Inc. (In California, Cross Country Motor Club of California, Inc.)

LEASING

Leasing is a popular way to finance a new vehicle, and the **Gold Key Lease** offered by Chrysler Financial Company L.L.C. has the flexibility to fit your vehicle choice and your lifestyle. Lease payments are typically lower and for a shorter term than conventional financing. At lease end, you can: 1) turn the vehicle in and lease a new one; 2) buy the vehicle and keep it; 3) buy the vehicle and sell it for a possible profit. If the idea of driving the vehicle you want and paying less for it sounds great, ask your dealer about Gold Key Lease. **Gold Key Plus** is a great alternative to leasing for customers who want low payments and pride of vehicle ownership — Gold Key Plus offers both. Decide how long the vehicle will be driven and the trade-in value is guaranteed (less excess mileage and wear and tear). Ask your dealer for complete details. **Commercial Finance Options (CFO)** offers several finance and lease options to small and midsize businesses, municipalities and small fleet operators. A full range of automotive financing is available through Chrysler Financial, providing flexible payment plans and finance products for qualified buyers. Many of these plans can be customized to fit your particular budget and make your new vehicle even more affordable. The **College Graduate Program** is especially attractive to those just beginning their careers. Ask your salesperson for details about any of the above plans.

Chrysler Financial Company L.L.C. programs are offered subject to availability and state and local laws.

DAIMLERCHRYSLER SERVICE CONTRACTS

Additional protection for owners is available through optional DaimlerChrysler Service Contracts. These service plans are available in a variety of time and mileage combinations to meet your driving needs. Ask your dealer for more information or call 1-800-442-2666.

All product illustrations, specifications and competitive comparisons are based upon current information at the time of publication approval. Although descriptions are believed correct, complete accuracy cannot be guaranteed. DaimlerChrysler Corporation reserves the right to make changes at any time, without notice or obligation, in prices, specifications, equipment, colors and materials, and to change or discontinue models. Some of the equipment shown or described throughout this catalog is available at extra cost. See your dealer for the latest information.

Mopar, Sentry Key, EVS II and Customer One Care are trademarks of DaimlerChrysler. HomeLink is a registered trademark of Johnson Controls, Inc. Infinity Spatial Imaging is a trademark of Infinity Systems, Inc. CATIA is a registered trademark of Dassault Systems.

Always use seat belts. Remember a backseat is the safest place for children.

FOR MORE INFORMATION ON PRODUCTS OR LEASING:
1-800-CHRYSLER



CHRYSLER



ENGINEERED TO BE GREAT CARS