

CHRYSLER-PLYMOUTH



MINIVANS

VOYAGER • TOWN & COUNTRY

PATTERSON - CHRYSLER - PLYMOUTH
JEEP - EAGLE
1965 N. Ellsworth Ave.
Salem, Ohio 44460
216-337-3475

THE CHRYSLER-PLYMOUTH ADVANTAGE: COMFORT AND SAFETY WRAPPED IN FRESH, ROUNDED, CONTEMPORARY STYLING. WE INVENTED THE MINIVAN CONCEPT, AND FOR 1992, WE'RE OUT FRONT AGAIN. CHRYSLER MINIVANS LEAD THE NATION IN SALES,* AND OFFER THE INDUSTRY'S FIRST STANDARD DRIVER-SIDE MINIVAN AIR BAGS† AVAILABLE V6 POWER, ALL-WHEEL DRIVE AND ANTILOCK BRAKES LET YOU GO WHERE YOU WANT AND STOP WHEN YOU SHOULD, CONFIDENTLY. MODELS INCLUDE PLYMOUTH VOYAGER, VOYAGER SE, LE AND LX, THE EXTENDED WHEELBASE GRAND VOYAGER, GRAND VOYAGER SE AND LE, PLUS ALL-WHEEL-DRIVE SE AND LE. THE ULTIMATE LUXURY MINIVAN IS CHRYSLER TOWN & COUNTRY WITH AVAILABLE ALL-WHEEL DRIVE. (SEE PAGE 18 FOR DETAILS.) NO OTHER MINIVAN MAKER OFFERS YOU MORE CHOICES AND MORE ADVANTAGES.



Voyager LX



Voyager SE



Grand Voyager LE



Chrysler Town & Country

*Based on Wards Automotive Reports sales figures, January 7, 1991.

†This driver-side minivan air bag provides added safety only when seat belts are worn.

ADVANTAGE: SAFETY

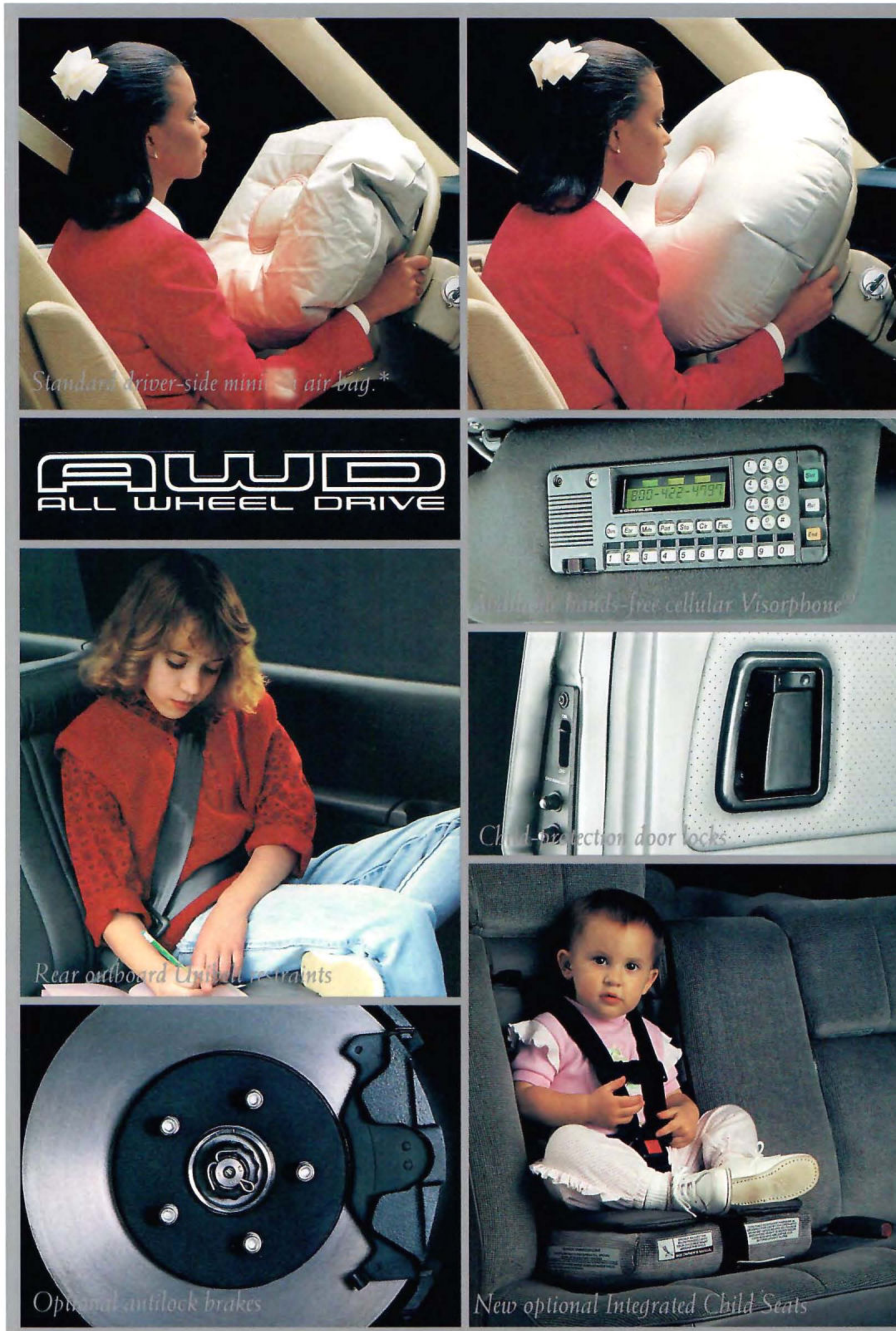

®Visorphone is a registered trademark of Cartell, Inc. See page 31 for additional information. (Dealer-installed option).

*This driver-side minivan air bag provides added safety only when seatbelts are worn. (Simulated air bag deployment shown).



Voyager has earned "Motor Week's" Driver's Choice Award and five consecutive Automobile Magazine All-Star Awards.*



Available all-wheel drive with full-time traction sensing automatically transmits power to the wheels with the most grip, without using buttons or switches, enabling AWD Voyager SE, LE or LX to climb grades up to 32-degrees.

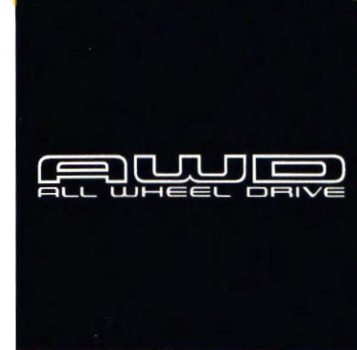

Voyager's full-time AWD automatically sends more engine torque to the rear wheels when extra traction is needed.

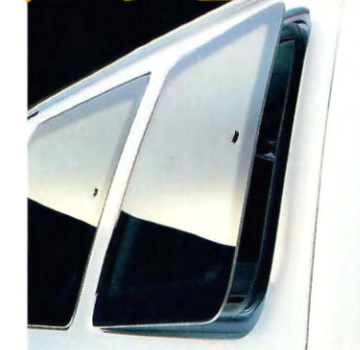

Flip-open center and rear quarter windows are standard. (Power rear quarter windows standard on LE.)



Dual power sideview mirrors on SE and LE models. (Heated mirrors standard on LE.)

SUPERLATIVE STYLING



Some of the equipment shown or described throughout this catalog is available at extra cost.

About this catalog. Since the time of printing, some of the information you'll find in this catalog may have been updated. Ask your dealer for details.

AWD Plymouth Voyager LX, shown in Dark Quartz Gray Metallic Clear Coat.

*Automobile Magazine, January 1991.



Available four-wheel antilock brakes provide positive steering control during hard braking.

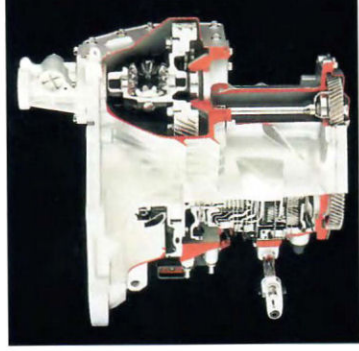

An electronically controlled four-speed overdrive transaxle offers quick acceleration, improved fuel efficiency and quiet cruising.

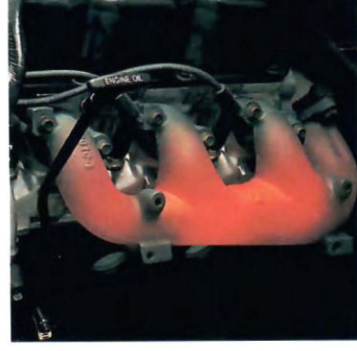

To ensure long life, our minivan engines undergo punishing 800-hour, 4,000-rpm durability tests during design and development.



The new 1992 Voyager's rounded, contemporary styling and lower front end offer a sleek aerodynamic profile, while windshield pillar placement and generous glass area deliver excellent visibility.



Crash tests evaluate bumpers, air bags, crumple zones and structural strength to create the safest minivans possible.

SUBSTANTIAL ENGINEERING

ADVANTAGE: PLYMOUTH

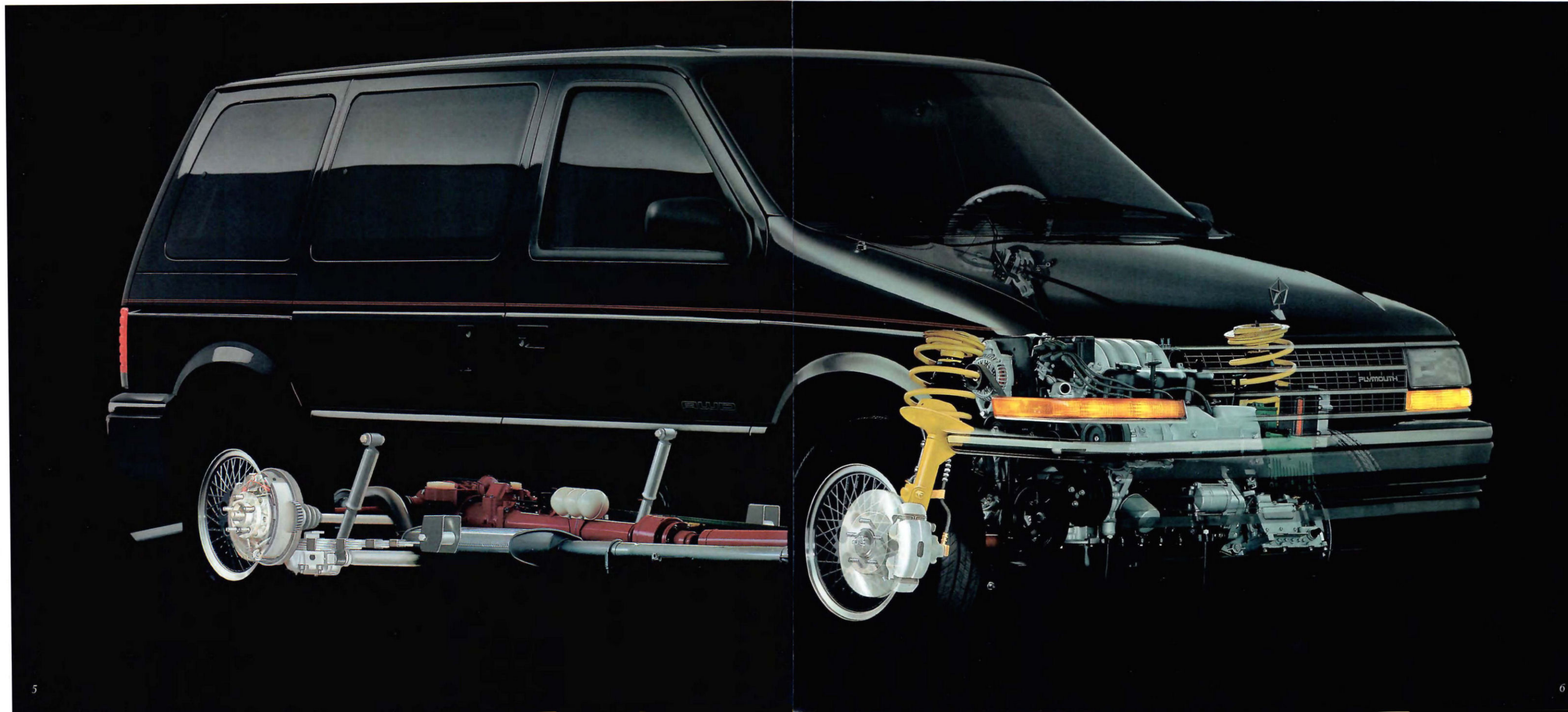



The powerful 150-horsepower 3.3-liter V6 is standard on Grand Voyager and AWD models.



Overhead console (standard on LE) has mini trip computer, compass, map/reading lights, sunglasses and garage door opener storage.



Voyager's low, car-like step-up height makes entry and exit convenient and effortless.

BIG ON COMFORT AND CARGO, THE EXTRA 14.6-INCH LENGTH OF GRAND VOYAGER LE AND SE (RIGHT) OFFERS 12 CUBIC FEET MORE CARGO SPACE THAN STANDARD VOYAGER, AND 26.3 CUBIC FEET MORE ROOM WITH REAR SEATS REMOVED. STANDARD FEATURES INCLUDE SEVEN-PASSENGER SEATING, DUAL POWER REMOTE CONTROL SIDEVIEW MIRRORS (HEATED POWER MIRRORS ON LES), REMOTE POWER LIFTGATE RELEASE, YOUR CHOICE OF TRANSAXLES, AND MORE. ADVANTAGE: PLYMOUTH.



SIZEABLE ASSET



Grand Voyager LE, shown in Twilight Blue Pearl Coat with optional woodgrain appliques.



Rear outboard Unibelt restraints help protect passengers with new cinch-lock belt tips.



Center console features convenient storage bin, cubby box, cassette rack, ashtray, and more.



Center console cup holders keep beverages upright and slide out of sight when not in use.

THE RELATIONSHIP BETWEEN DRIVER AND INSTRUMENT PANEL IS ONE OF THE MOST IMPORTANT ASPECTS OF VOYAGER'S DESIGN. SAFETY ENGINEERING INCLUDES THE INDUSTRY'S FIRST DRIVER-SIDE MINIVAN AIR BAG* RESTRAINT SYSTEM (SHOWN RIGHT) TO HELP SAVE LIVES.

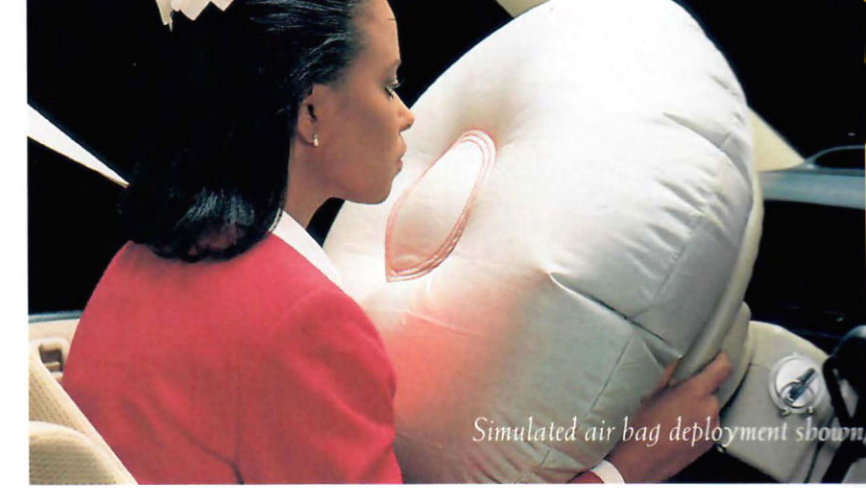

Simulated air bag deployment shown.

CONTROLS AND GAUGES ARE LOCATED FOR MAXIMUM CONTROL, MINIMUM DISTRACTION. THERE'S A HANDY GLOVE BOX, PLUS SIX CUP HOLDERS LOCATED THROUGHOUT THE VEHICLE. ADVANTAGE: PLYMOUTH.

**This driver-side minivan air bag provides added safety only when seat belts are worn.*

MISSION CONTROL





Movable/removable seating lets you arrange space to accommodate all your needs. (Short wheel base model shown above.)



The Integrated Child Seats are available on all Voyagers with cloth interiors and meet or exceed FMVSS 213 Federal Safety Standard. Accommodates two adults when folded.



Both Integrated Child Seats offer five-point belt systems for use with toddlers, or the driver-side position converts to a booster seat for use with a standard Unibelt.



The optional Converta-Bed rear seat unfolds into a comfortable bed with the flip of a lever.

LIVING ROOM



Choose from Voyager five- or seven-passenger seating (shown here). Available Quad Command Seating Package includes front and center bucket seats and rear three-passenger bench.



Standard sliding side door child-protection lock safely disables inside door handle.



Cup holders and a bin with armrest/lid offer convenient storage and comfort for rear-seat passengers.



Cup holders, ashtray and a large bin next to the center seat offer additional storage and convenience.



VOYAGER IS A MINIVAN SALES LEADER FOR MANY GOOD REASONS. ADVANTAGES SUCH AS STANDARD FRONT-WHEEL DRIVE; GREAT ALL-AROUND VISIBILITY, EASE OF PARKING; AND THREE ENGINE CHOICES. TOP-OF-THE-LINE VOYAGER LE OFFERS A STANDARD ELECTRONICALLY CONTROLLED FOUR-SPEED OVERDRIVE AUTOMATIC TRANSAXLE (THREE-SPEED ALSO AVAILABLE), AIR CONDITIONING, AM/FM STEREO RADIO, AND MORE. (VOYAGER SE, SHOWN ABOVE.) ADVANTAGE PLYMOUTH.

PROVEN LEADERSHIP



Voyager LE, shown in Diamond Blue Metallic Clear Coat.



Remote control sideview mirrors are standard on Voyager.



Standard liftgate fixed intermittent wiper/washer with dual nozzle wet arm washer clears Voyager's rear glass. The liftgate electric window defroster is standard on LE models, available on all other Voyagers.



VOYAGER VALUE MEANS STANDARD POWER STEERING AND BRAKES, TINTED GLASS, 20-GALLON FUEL TANK, AM/FM STEREO, DELUXE INTERMITTENT WIPER/WASHERS AND MORE (SHOWN RIGHT). THE MONEY-SAVING OPTIONAL FAMILY VALUE PACKAGE OFFERS NO-COST AIR CONDITIONING PLUS MANY CONVENIENCE OPTIONS AT BIG SAVINGS.* AND NEW, OPTIONAL GRAND VOYAGER (BELOW) HAS A STANDARD 3.0-LITER V6 AND SEVEN-PASSENGER SEATING.

**Savings on option packages and no-charge air conditioning based on cost of package items if purchased separately.*

VALUE DEFINED



Plymouth Grand Voyager, shown in Platinum Silver Metallic Clear Coat.

CHRYSLER TOWN & COUNTRY: IT IS QUITE SIMPLY THE MOST LUXURIOUS MINIVAN AVAILABLE. THE HIGHLY RESPECTED J.D. POWER SURVEY* RANKED TOWN & COUNTRY AS HIGHEST IN CUSTOMER SATISFACTION OF ANY MINIVAN, IMPORT OR DOMESTIC. CHRYSLER TOWN & COUNTRY'S NEW LOOK FOR 1992 EMBRACES A SUBTLE GOLD PINSTRIPE PAINT TREATMENT, WITH GOLD-TONE CAST ALUMINUM WHEELS (STANDARD WOODGRAIN APPLIQUE, OPTIONAL AT NO COST). THERE IS A WEALTH OF STANDARD LUXURY CONVENIENCES, INCLUDING QUAD COMMAND SEATING, FOUR-WHEEL ANTILOCK BRAKES, A POWERFUL 3.3-LITER SEQUENTIAL MULTIPPOINT FUEL-INJECTED V6 ENGINE, AND MUCH MORE. TOWN & COUNTRY. NOW YOU CAN HAVE ALL OF THE COMFORT AND VERSATILITY OF A MINIVAN WITH A SUPERB LEVEL OF LUXURY. ADVANTAGE: CHRYSLER.

*Based on J.D. Power and Associates 1990 Light Duty Truck Customer Satisfaction with Product Quality and Dealer Service.SM

CHRYSLER TOWN & COUNTRY



Town & Country, shown in Black Cherry Pearl Coat.



Beautifully appointed, the Town & Country instrument panel offers the rich look of walnut burl. Perfectly placed controls and advanced vacuum fluorescent gauges ease driving and keep you fully informed at the wheel.

ULTIMATE LUXURY

EASE INTO CHRYSLER TOWN & COUNTRY'S STANDARD QUAD COMMAND CONTOURED PREMIUM CLOTH WITH LEATHER RECLINING BUCKET SEATS. LEATHER-WITH-VINYL-TRIM SEATING IS ALSO AVAILABLE. THE INDUSTRY'S FIRST STANDARD DRIVER-SIDE MINIVAN AIR



Simulated air bag deployment shown.

BAG* SYSTEM (SHOWN RIGHT) IS READY TO HELP PROTECT YOU. THE STANDARD OVERHEAD CONSOLE INCLUDES MINI TRIP COMPUTER, COMPASS AND OUTSIDE TEMPERATURE DISPLAYS, MAP/READING LIGHTS, AND MORE.

**This driver-side minivan air bag provides added safety only when seat belts are worn.*



Supple, optional leather-with-vinyl-trim Quad Command seating, shown in Champagne.

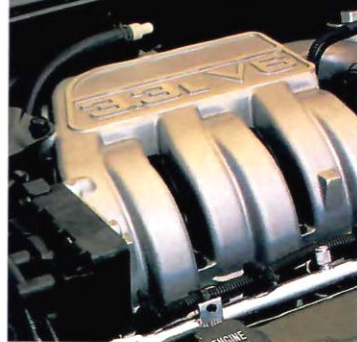

3.3-liter V6 offers sequential multipoint fuel injection for quick acceleration, smooth idling, and substantial towing capacity.

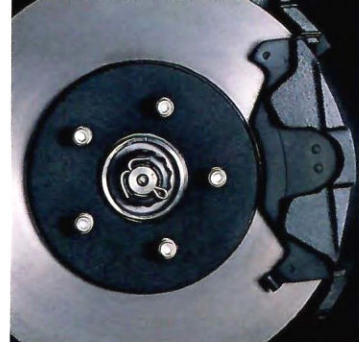

Antilock feature electronically "pumps" brakes to eliminate lockup and improve steering control for added safety.

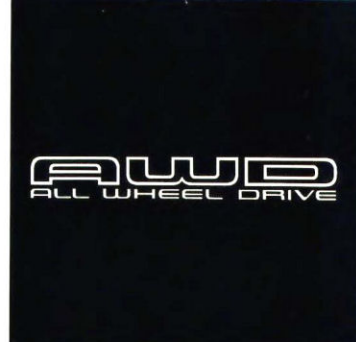

Optional All-Wheel Drive automatically sends torque to the wheels best gripping the road for safety and control. No levers or switches.



THE CLASSIC GRILLE AND SCULPTED BODYSIDES TELL YOU THIS IS CHRYSLER TOWN & COUNTRY. CHOOSE TRADITIONAL WOODGRAIN OR NEW MONOTONE WITH GOLD PINSTRIPES AND WHEELS AT NO EXTRA CHARGE (SEE PAGE 19). STANDARD AUTOMATIC DOOR LOCKS ALSO KEEP DOORS FROM LOCKING WHEN YOUR KEY IS IN THE IGNITION AND THE ENGINE IS TURNED OFF. TOWN & COUNTRY'S INSIDE LIFTGATE, HOOD AND FUEL FILLER DOOR RELEASES OFFER CONVENIENCE AND SECURITY. ADVANTAGE: CHRYSLER.

DEFINITIVE STATEMENT



Town & Country, shown in Light Champagne Metallic Clear Coat.



Compact Disc Player (Available on Town & Country or Voyager models with Infinity sound system.) This compact disc player's digital sound delivers high-performance audio. Features include automatic power loading, repeat, 99-track programmed memory, play/scan, forward and reverse skip, fast forward and reverse. (Dealer-installed.)



Infinity II (Available on Voyager LE, standard on Town & Country.) AM stereo*/FM stereo, with seek-and-scan, Dynamic Noise Reduction,[†] cassette player with automatic reverse, music search, Dolby B[‡] Noise Reduction, five-band electronic graphic equalizer, integral digital clock, and Chrysler Infinity vehicle-equalized 10-speaker system.



Infinity I (Available on SE and LE models) AM stereo*/FM stereo radio, with seek-and-scan, Dynamic Noise Reduction,[†] cassette player with automatic reverse, music search, Dolby B[‡] Noise Reduction, electronic bass and treble control, integral digital clock, and Chrysler Infinity vehicle-equalized 10-speaker system.



AM/FM Stereo/Cassette (Available on all Voyager models) Includes electronic tuning, Dynamic Noise Reduction,[†] bass/treble slide controls, cassette tape player with automatic reverse, integral digital clock, and four speakers. An AM/FM stereo radio with integral digital clock and four speakers is standard.



The **Visorphone® Cellular Telephone** is small enough to hide in your sun visor, thanks to microprocessor technology. Flip it down to call, then flip it up to talk using the hands-free speakerphone. Chrysler phones have been developed and tested to be fully compatible with your vehicle's electrical system. Installation systems have been designed to help prevent loose mounting and electrical problems from crushed wires or electromagnetic interference. Visorphone® includes a full array of high-tech features:

- One-touch dialing
- 100-number memory
- Electronic scratch pad
- Automatic radio mute
- Automatic redial
- Call timers
- User programmable lock code
- 911 emergency dialing, even when locked
- Call continuation with ignition off
- Full five-year warranty
- And more (dealer-installed option.)

The **Hand-Held Portable Cellular Telephone** offers call from anywhere convenience and the latest high-tech features. This compact, lightweight portable can go wherever you go and with its 50-number memory eliminates bulky phone books.

Other features include:

- Rechargeable ni-cad batteries
- 138 minutes of talk time or 18 hours of standby time
- Scrolling phone number memory display
- Two-phone number capability to help manage roaming charges
- Call timers
- User programmable lock code
- 911 emergency dialing, even when locked
- And more (dealer-activated)



* Some AM stereo broadcasting may not be compatible with this radio.
[†] Dynamic Noise Reduction is a trademark of National Semiconductor Corporation.
[‡] Dolby B is a trademark of Dolby Laboratories.
 ® Visorphone is a registered trademark of Cartell, Inc. See page 31 for additional information.

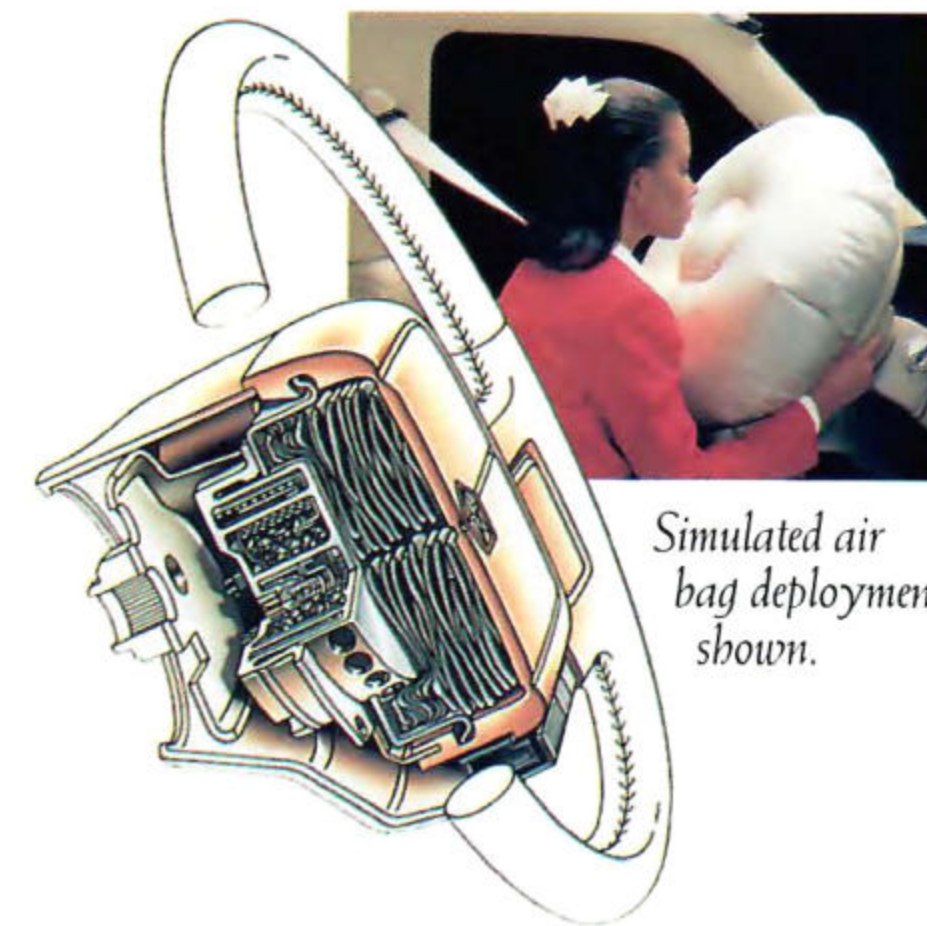

Simulated air bag deployment shown.

Advanced air bag technology helps protect you in a front-end collision with superb reliability. Gold-plated, corrosion-resistant impact sensors in the vehicle's front end trigger a propellant canister in the steering wheel hub to inflate the air bag. The bag expands fully, cushions you, and deflates in less than a second.

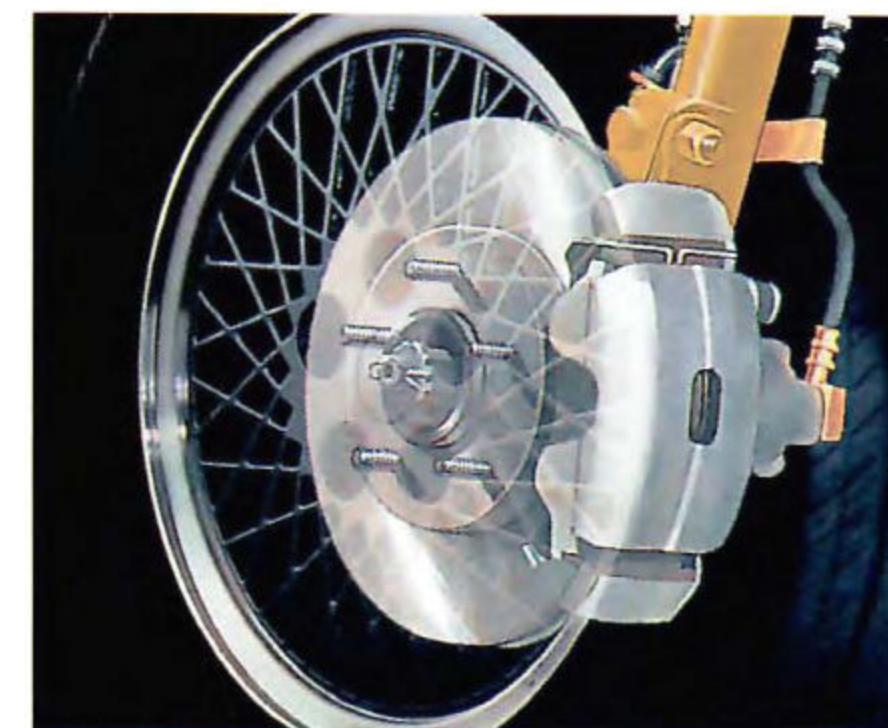

Antilock Braking Systems in Chrysler and Plymouth vehicles use microprocessor-managed electro-hydraulic technology to sense wheel lockup and electronically "pump" brake pressure for added safety and improved steering control during hard braking.

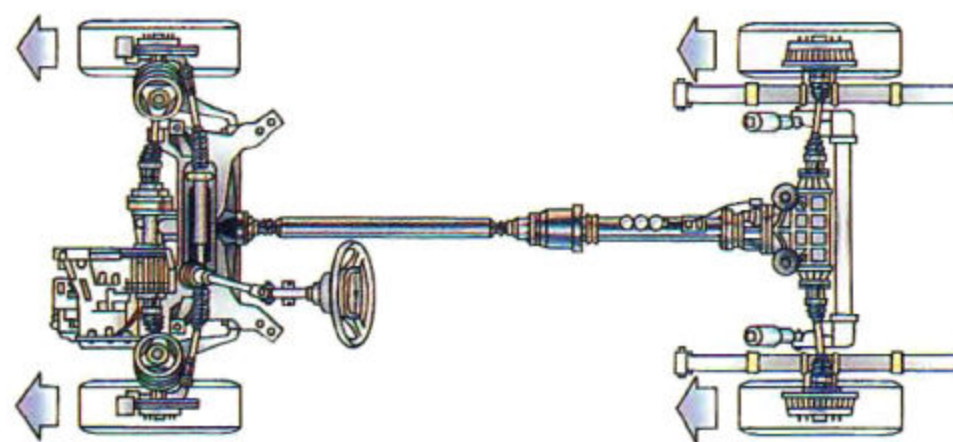

All-Wheel Drive with full-time traction sensing uses a viscous coupling to automatically transmit torque to the rear wheels when the front wheels slip, for optimal traction and safety. It's a system that's not available on GM's APVs. Advantage: Chrysler-Plymouth.

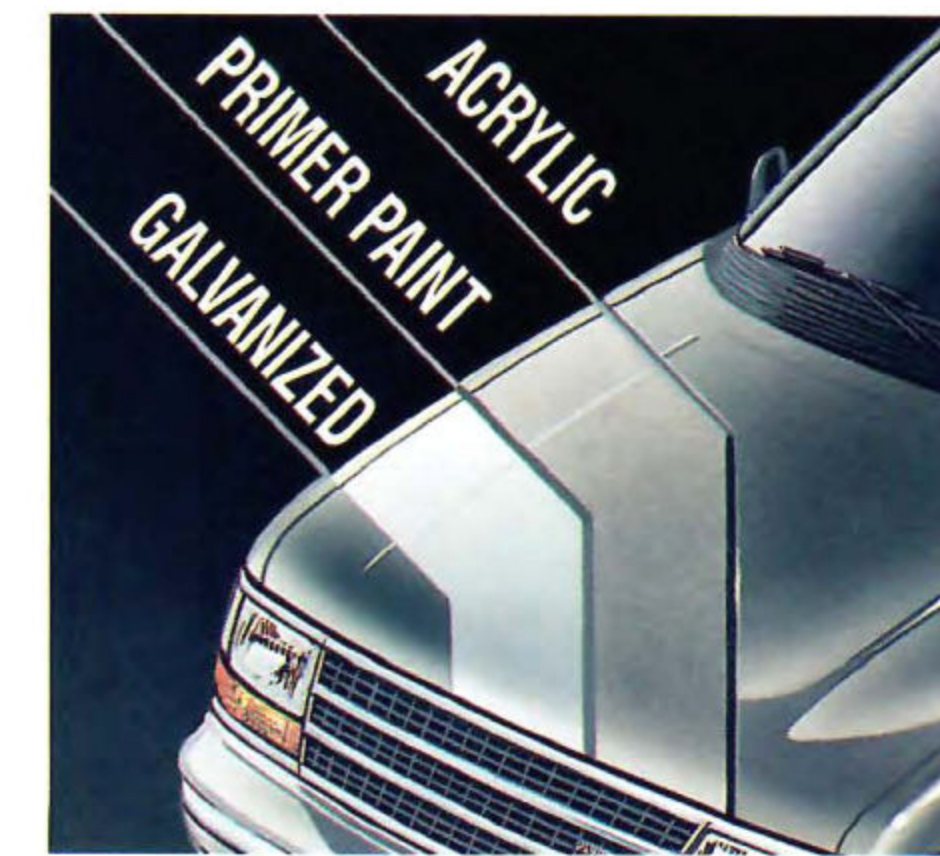

All body panels, except roof, are two-side galvanized/galvannealed, then five layers of primer, paint and clear acrylic coatings create a beautiful corrosion-resistant mirror finish.

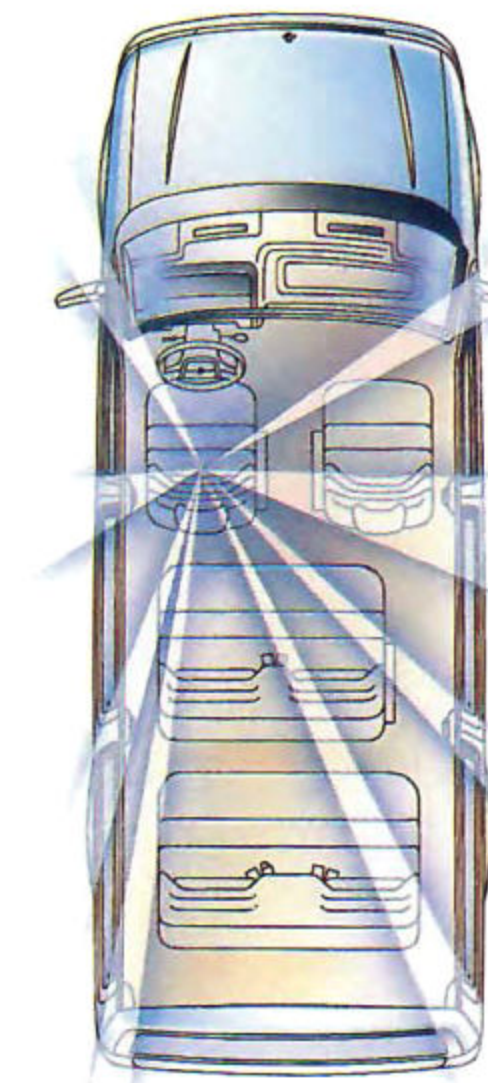

A clear, commanding driver's-eye view is offered by Plymouth Voyager's and Chrysler Town & Country's greenhouse design. Windshield pillars have been placed for maximum visibility, unlike GM's APVs.

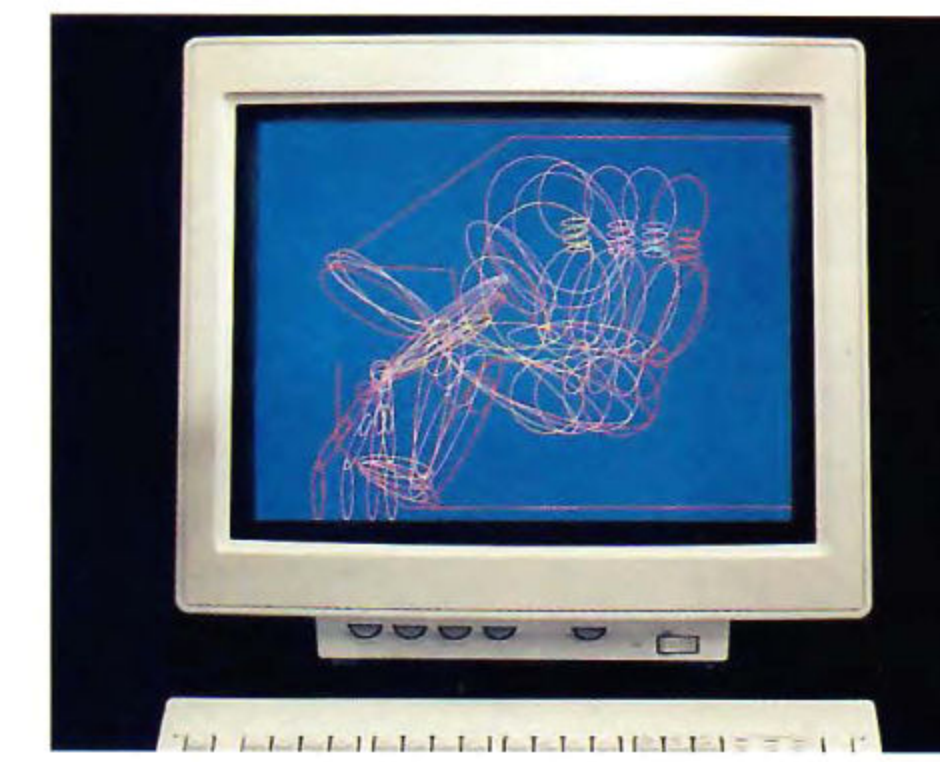

Kinematic Modeling is a sophisticated computer analysis of the human body's

interaction with the inside of a vehicle during accident impact. These studies result in safer interiors and fewer injuries.

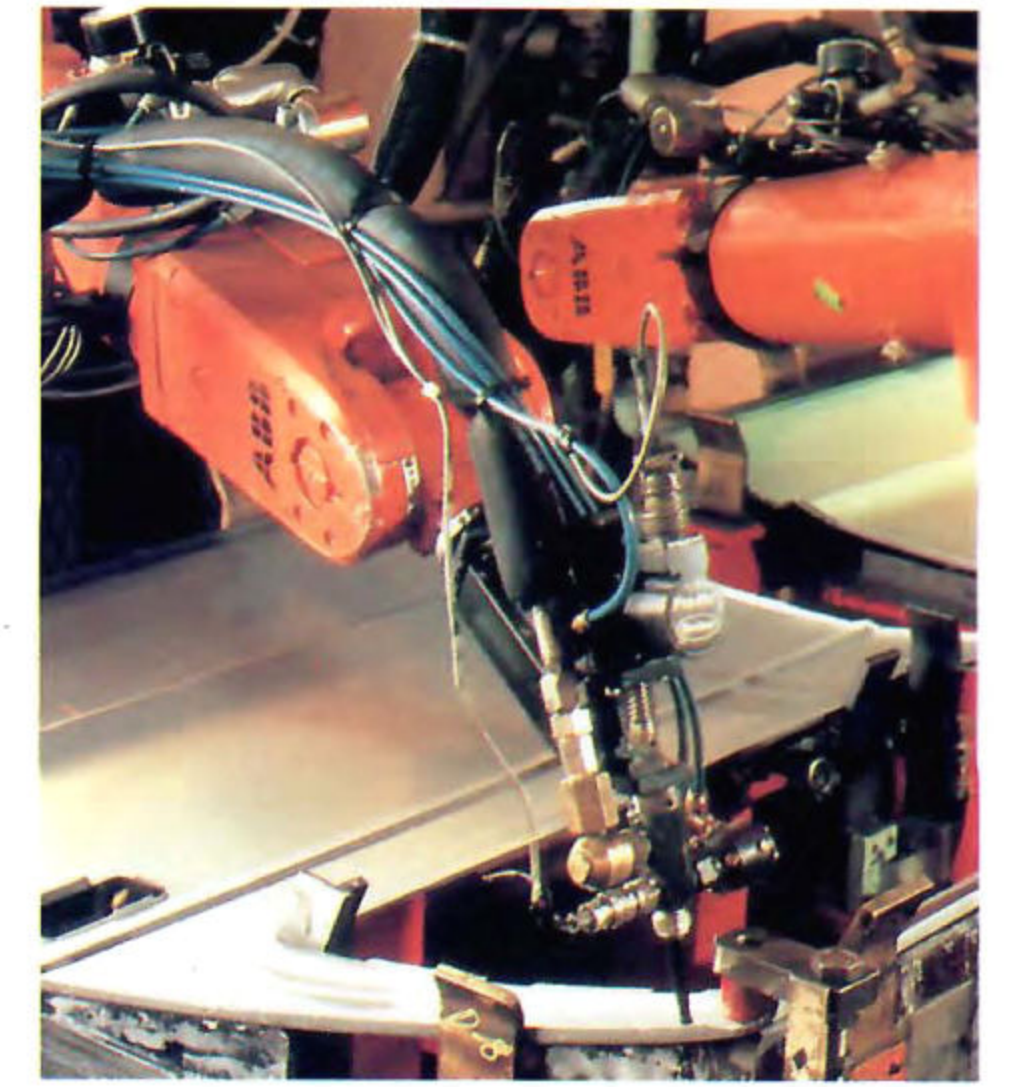

Powerful epoxy adhesive is applied by a robotic arm. A continuous bead bonds vehicle door frames to their outer skins. The door is heat cured, then fully hardened in the ovens during the paint-drying process. Benefits include structural strength, superior corrosion resistance, and noise reduction.



New Mopar Diagnostic Service System, designed in cooperation with IBM, offers Chrysler-Plymouth dealership customers the most advanced vehicle service ever. The hand-held unit pictured above records actual on-road performance. A removable data cartridge is then read by the host system to quickly diagnose any problem and maintain peak performance. (Late availability.)

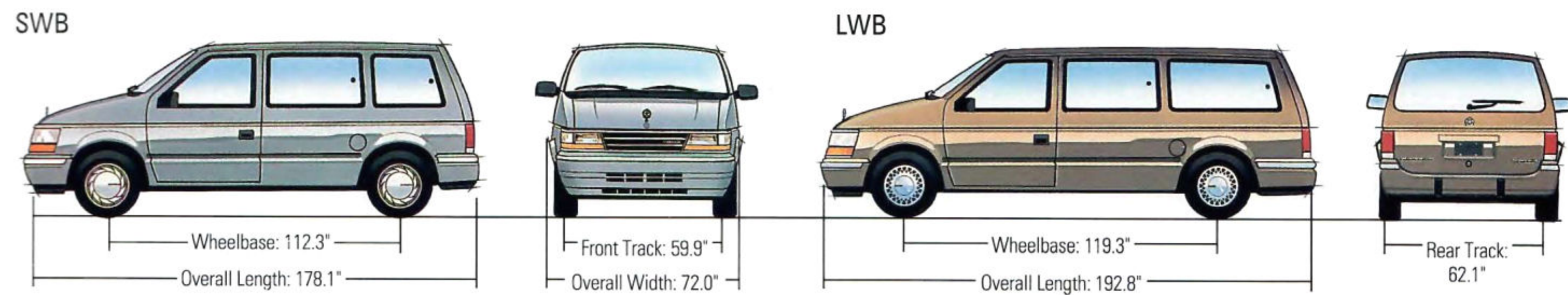

DIMENSIONS				
EXTERIOR	SWB	SWB/AWD	LWB	LWB/AWD
Overall Height	66.0"	67.6"	66.7"	67.8"
Overall Width	72.0"	72.0"	72.0"	72.0"
Overall Length	178.1"	178.1"	192.8"	192.8"
Wheelbase	112.3"	112.3"	119.3"	119.3"
Rear Track	62.1"	62.1"	62.1"	62.1"
Front Track	59.9"	59.9"	59.9"	59.9"

POWER TRAINS*

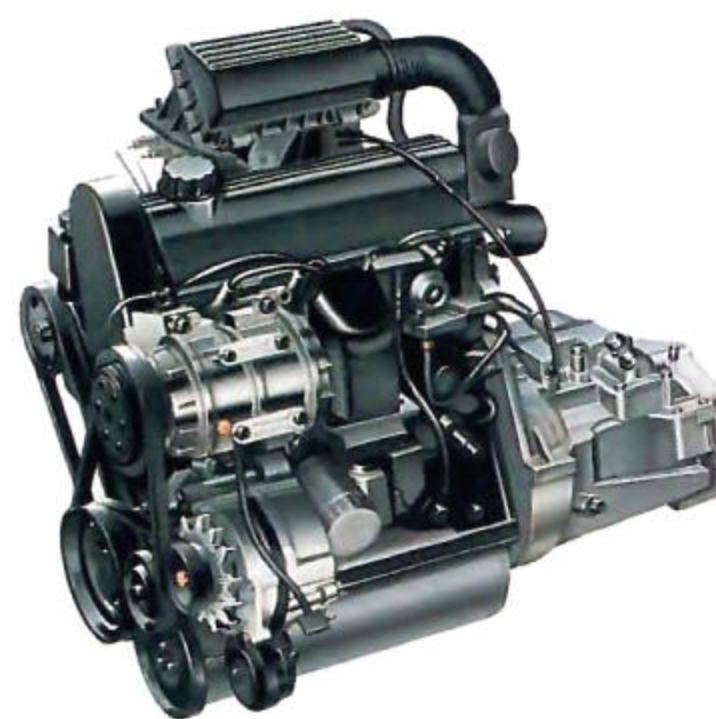

2.5-LITER EFI BALANCE-SHAFT ENGINE
 The 2.5-liter EFI balance-shaft four-cylinder engine produces excellent power and torque as well as substantial acceleration, with 100 horsepower at 4,800 rpm and 135 pound-feet of torque at 2,800 rpm. Twin counterrotating balance-shaft engineering and quiet idle features mean smooth, low-vibration operation.



3.0-LITER OHC SMPI V6 ENGINE
 The 3.0-liter V6 Mitsubishi-built engine delivers smooth, effortless power and acceleration with 142 horsepower at 5,000 rpm and 173 pound-feet of torque at 2,800 rpm. Thanks to precise electronic fuel injection, dual tuned intake manifolds and a sophisticated overhead camshaft valve train design, this engine produces uniform throttle response throughout the power curve and whisper-quiet idling.



3.3-LITER V6 SMPI ENGINE
 This powerful, sophisticated engine generates 150 horsepower at 4,800 rpm and a hefty 185 pound-feet of torque at a low 3,600 rpm, thanks to a high-efficiency microprocessor-controlled ignition system, sequential multipoint electronic fuel injection and a specially tuned intake manifold. Quick acceleration and a smooth, quiet idle make driving a pleasure.

ENGINE/ TRANSAXLE	VOYAGER					GRAND VOYAGER					T & C
	Base	SE	SE AWD	LE/LX	LE/LX AWD	Base	SE	SE AWD	LE	LE AWD	TOWN & COUNTRY
2.5-liter with five-speed manual	S	NA	NA	NA	NA	NA	NA	NA	NA	NA	NA
2.5-liter with three-speed automatic	O	S	NA	NA	NA	NA	NA	NA	NA	NA	NA
3.0-liter with three-speed automatic	O	O	NA	C	NA	S	C	NA	NA	NA	NA
3.0-liter with four-speed automatic	NA	O	NA	S	NA	NA	NA	NA	NA	NA	NA
3.3-liter with four-speed automatic	NA	O	S	O	S	NA	S	S	S	S	S

S—Standard. O—Optionally available. NA—Not available. C—Credit option.
 *California emissions controls and testing required at extra cost on all vehicles registered in California; not available otherwise.

POWER TRAIN AVAILABILITY	VOYAGER				GRAND VOYAGER				TOWN & COUNTRY												
	CUSTOMER-PREFERRED SM PACKAGE GROUP CODES				CUSTOMER-PREFERRED SM PACKAGE GROUP CODES				CUSTOMER-PREFERRED SM PACKAGE GROUP CODES												
ENGINES	TRANSAXLES	BASE	SE/SE AWD	LE/LE AWD	LX	BASE	SE/SE AWD	LE/LE AWD		FWD	AWD	FWD	AWD								
2.5L EFI	5-Speed Manual	S	T																		
2.5L EFI	3-Speed Automatic	S	T	A	B	D															
3.0L SMPI V6	3-Speed Automatic	S	T	A	B	D	J	K	L	M	E										
3.0L SMPI V6	4-Speed Automatic			A	B	D	J	K	L	M											
3.3L SMPI V6	4-Speed Automatic			A	B	D	J	K	L	M		A	B	D	J	K	L	X	X	Y	Y

All the above letter designations represent package group codes.

SEAT PACKAGES

5-Passenger Seating	S	S																		
7-Passenger Seating	O	O	S	S	S	S	S	S	S	S	S	S	S	S	S	S	S	S	S	S
7-Passenger Quad Command			O	O	O	O	O	O	O	O	O	O	O	O	O	O	O	O	O	O
7-Passenger with Converta-Bed			O	O	O															
7-Passenger with Integrated Child Seats	O	O	O	O	O	O	O	O	O	O	O	O	O	O	O	O	O	O	O	O

PACKAGE CONTENTS

Air Conditioning ¹		•		•	•	S	S	S	S	S	•		•	•	S	S	S	S	S	S	S	S	S	S
Console—Forward															•	S	S	S	S	S	S	S	S	S
Delete "SE" Nameplate															•									
Delete Paint Stripe															•									
Delete Woodgrain—Town & Country																								S
Defroster ² —Rear window															•	•	S	S	S	S	S	S	S	S
Horn—Dual-note			•	S	S	S	S	S	S	S	S	S	S	S	S	S	S	S	S	S	S	S	S	S
Instrumentation—Full gauges																								S
Insulation—Deluxe																								S
Light Package																								S
Lights—Map and cargo																								S
Luggage Rack																								S
Mats—Floor																								S
Mirrors—Illuminated vanity																								S
Molding—Bodyside																								S
Power Door Locks																								S
Power Liftgate Release																								S
Power Seat—Driver-side																								S
Power Windows																								S
Radio—AM/FM Cassette-Infinity I ³																								S
Speed Control/Tilt Steering Column																								S
Storage Drawer—Under seat																								S
Sunscreen Glass																								S
Tires—White sidewall (set of four)																								S
Wheel Covers—Wire (set of four)																								S
Wheels—Cast aluminum road (set of four)																								S
Woodgrain Overlay—With color-keyed fascias																								S

AVAILABLE OPTIONS

Air Conditioning ¹	O	P	O	P	P	S	S	S	S	S	P	O	P	P	S	S	S	S	S	S	S	S	S		
Air Conditioner/Heater—Rear																								O	
Brakes—Antilock				O	O	O	O	O	O	O	O	O	O	O	O	O	O	O	O	O	O	O	O	O	S
Defroster ² —Rear window	O	O	O	P	P	S	S	S	S	S	O	O	P	P	S	S	S	S	S	S	S	S	S	S	
Heavy-Duty Trailer Towing Package ⁴				O	O	O	O	O	O	O															
Luggage Rack	O	O	O	O	O	O	O	O	O	P	O	O	O	O	O	O	O	P	S	S	S	S	S	S	
Power Door Locks	O	O	O	O	P	S	S	S	S	S	O	O	O	P	S	S	S							S	
Power Convenience Package				O	O	O																		S	
Radio—AM/FM cassette-Infinity I ³																								S	
Radio—AM/FM cassette-Infinity II ³																								S	
Radio—AM/FM cassette ³	O	O	O	O	O	O	O	O	O	O	O	O	O	O	O	O	O	O	O	O	O	O	O	S	
Speed Control/Tilt Steering Column	O	O	O	O	P	S	S	S	S	S	O	O	O	P	S	S	S	S	S	S	S	S	S	S	
Sport Handling Package ⁴				O	O	O	O	O	O	O															
Sunscreen Glass	O	O	O	O	O	O	O	O	O	O	O	O	O	O	O	O	O	P	P	S	S	S	S	S	
Suspension—Heavy-duty	O	O	O	O	O	O	O	O	O	O	O	O	O	O	O	O	O	O	O	O	O	O	O	O	
Tire—Conventional spare	O	O	O	O	O	O	O	O	O	O	O	O	O	O	O	O	O	O	O	O	O	O	O	S	
Tires—White sidewall (set of four)	O	O	O	O	O	O	O	O	O	O	P	O	O	O	O	O	O	O	P	O	O	O	O	S	
Wheels—Cast alum. road (set of four)				O	O	O	O	O	O	O	P	O	O	O	O	O	O	O	O	O	O	O	O	S	
Wheels—Gold painted alum. (set of four)																								S	

S = Standard. • = Included in package. O = Optional. Available only when corresponding Customer-PreferredSM Package is ordered. P = Included in Customer-PreferredSM Package listed above.
 Notes: AWD only available with 3.3L/4-spd. auto. power train. Antilock brakes require 3.3L/4-spd. auto. power train. Sport Handling Package NA with all-wheel drive. Conventional spare NA with all-wheel drive. Rear A/C option includes forward storage console and is not available with AWD. There are special engine cooling requirements for field-installed air conditioning. Failure to follow these requirements may invalidate warranty. See your dealer for details. ¹Required on all passenger vehicles registered in New York State. ²Some AM stereo broadcasting may not be compatible with this radio. ³See dealer for package contents.

SAFETY FEATURES

- Air bag, driver-side minivan*
- Backup lights
- Brake fluid pressure loss warning light (also serves as indicator when parking brake is applied)
- Center high-mounted rear stoplight
- Child-protection locks on sliding side door
- Combination lap/shoulder belts for outboard seating positions; lap belts for rear center position
- Dual braking system with separate brake fluid reservoirs in the master cylinder
- Electronic ignition
- Electric windshield and rear window washers and wipers
- Energy-absorbing front seatbacks
- Energy-absorbing steering column
- Energy-absorbing sun visors
- Fade-resistant front vented disc brakes
- Glare reduction measures for instrument panel, steering wheel and windshield wipers
- Hazard warning flasher system
- Headlight and wiper circuit breakers with automatic reset
- Ignition and steering column lock
- Inside rearview mirror
- Interlocking door latches
- Key-left-in-ignition warning
- Non-override door locks (except driver's door)
- Power outside rearview mirrors
- Recessed inside door release handles
- Reinforced windshield header and roof
- Resilient window crank knobs
- Safety-Rim wheels
- Seat belt reminder system
- Side marker lights and reflectors
- Turn signals with lane-change feature

*This driver-side minivan air bag provides added safety only when seat belts are worn.

SCHEDULED MAINTENANCE

Here is a partial list of Plymouth Voyager's and Chrysler Town & Country's standard scheduled maintenance items.

- Engine oil and filter change7,500 miles or 6 months
- Spark plug changeeach 30,000 miles
- Air filter replacementeach 30,000 miles
- Engine coolant replacement.....each 30,000 miles or 2 years
- For severe service maintenance schedule, refer to Owner's Manual.

MILEAGE

20 EPA est. city mpg, 27 EPA est. hwy. mpg*

*Mileage figures based on 1992 Voyager base model standard engine with 5-speed manual transmission.

STANDARD AND OPTIONAL EQUIPMENT

FUNCTIONAL

	VOYAGER	VOYAGER SE & AWD	VOYAGER LE & AWD	VOYAGER LX & AWD	GRAND VOYAGER SE & AWD	GRAND VOYAGER LE & AWD	GRAND VOYAGER LX & AWD	TOWN & COUNTRY & AWD	TOWN & COUNTRY LE & AWD	TOWN & COUNTRY SE & AWD
Air Bag ¹ —Driver-side minivan	S	S	S	S	S	S	S	S	S	S
Alternator—90-ampere	S	S	S	S	S	S	S	S	S	S
Battery—Maintenance-free	S	S	S	S	S	S	S	S	S	S
Brake—Park, foot-operated	S	S	S	S	S	S	S	S	S	S
Brakes—Power-assisted: vented front disc, self-adjusting rear drum	S	S	S	S	S	S	S	S	S	S
Brakes—Four-wheel antilock braking system (3.3L V6 required)	NA	O	O	O	NA	O	O	S		
Brakes—Heavy-duty (Std on AWD models)	NA	P ²	P ²	P ²	S	S	S	S		
Electronic Ignition and Voltage Regulator	S	S	S	S	S	S	S	S	S	S
Engine—2.5-liter EFI (NA on AWD models)	S	S	NA	NA	NA	NA	NA	NA	NA	NA
Engine—3.0-liter SMPI V6 (NA on AWD models)	O	O	S	S	S	C	NA	NA		
Engine—3.3-liter SMPI V6 (Std on AWD models)	NA	O	O	O	NA	S	S	S		
Exhaust System—Aluminized steel	S	S	S	S	S	S	S	S	S	S
Fog Lamps—Front	NA	NA	NA	S	NA	NA	NA	S		
Fuel Filler Door—Remote cable release and tethered cap	NA	NA	S	S	NA	NA	S	S		
Fuel Tank—20-gallon (18-gallon on AWD)	S	S	S	S	S	S	S	S	S	S
Headlights—Single halogen: aero-type	S	S	S	S	S	S	S	S	S	S
Heavy Duty Trailer Tow Package ³	NA	O	O	O	NA	O	O	NA		
Hood—Remote cable release	S	S	S	S	S	S	S	S	S	S
Horn—Dual-note (Base has single-note horn)	P	S	S	S	S	S	S	S	S	S
Jack—Scissors-type	S	S	S	S	S	S	S	S	S	S
Speed Control—Electronic	O	P	S	S	O	P	S	S		
Sport Handling Package (NA with AWD) ³	NA	O	O	O	NA	O	O	NA		
Steering—Rack-and-pinion: power-assisted	S	S	S	S	S	S	S	S	S	S
Steering Column—Tilt	O	P	S	S	O	P	S	S		
Suspension—Front: gas-charged position-sensitive struts and coil springs	S	S	S	S	S	S	S	S	S	S
Suspension—Rear: gas-charged shocks and leaf springs	S	S	S	S	S	S	S	S	S	S
Suspension System—Heavy-duty	O	O	O	O	O	O	O	NA		
Transaxle—Manual: five-speed	S	NA	NA	NA	NA	NA	NA	NA	NA	NA
Transaxle—Auto: three-speed (NA on AWD models)	O	S	C	C	S	NA	NA	NA		
Transaxle—Auto: four-speed overdrive (Std on AWD)	NA	O	S	S	NA	S	S	S		

EXTERIOR

	VOYAGER	VOYAGER SE & AWD	VOYAGER LE & AWD	VOYAGER LX & AWD	GRAND VOYAGER SE & AWD	GRAND VOYAGER LE & AWD	GRAND VOYAGER LX & AWD	TOWN & COUNTRY & AWD	TOWN & COUNTRY LE & AWD	TOWN & COUNTRY SE & AWD
Appliques—Accent color: lower bodyside	NA	NA	S	NA	NA	NA	S	NA		
Appliques—Body color: lower bodyside	NA	NA	NA	S	NA	NA	NA	S		
Appliques—Woodgrain: bodyside and liftgate	NA	NA	P	NA	NA	NA	P	S		
Appliques—Woodgrain delete	NA	NA	NA	NA	NA	NA	NA	NC		
Corrosion Protection—Acrylic lower body protective coating; extensive use of galvanized steel	S	S	S	S	S	S	S	S		
Door—Right side: sliding, with child-protection lock	S	S	S	S	S	S	S	S		
Fascias—Front and rear: accent color with bright rub strips	NA	NA	S	NA	NA	NA	S	NA		
Fascias—Front and rear: color-keyed, with bright rub strips	S	S	P	S	S	S	P	S		

EXTERIOR (cont.)

	VOYAGER	VOYAGER SE & AWD	VOYAGER LE & AWD	VOYAGER LX & AWD	GRAND VOYAGER SE & AWD	GRAND VOYAGER LE & AWD	GRAND VOYAGER LX & AWD	TOWN & COUNTRY & AWD	TOWN & COUNTRY LE & AWD	TOWN & COUNTRY SE & AWD
Glass—Sunscreen	O	O	P	P	O	O	P	S		
Glass—Tinted: all windows	S	S	S	S	S	S	S	S		
Glass—Vented: bodyside and rear quarter	S	S	S	S	S	S	S	S		
Liftgate—Fixed glass: with outside key lock	S	S	S	S	S	S	S	S		
Luggage Rack—Roof-mounted, black	O	O	O	O	O	O	O	S		
Mirrors ⁴ —Exterior, dual power remote	NA	S	NA	NA	S	S	NA	NA		
Mirrors—Exterior, dual power remote, heated	NA	NA	S	S	NA	NA	S	S		
Moldings—Bodyside	NA	S	NA	NA	S	S	NA	NA		
Nameplate—Delete "SE"	NA	NA	NA	NA	P	NA	NA	NA		
Paint Stripes—Bodyside	NA	S	NA	NA	NA	S	NA	NC		
Paint Stripes—Delete	NA	NA	NA	NA	P	NA	NA	NA		
Tires—See page 30 for availability	S	S	S	S	S	S	S	S		
Wheels—Cast aluminum (set of four)	NA	O	O	P	NA	O	O	S		
Wheels—Gold painted (set of four)	NA	NA	NA	NA	NA	NA	NA	O		
Wheel Covers—Luxury (set of four)	NA	S	S	NA	S	S	S	NA		
Wheel Covers—Deluxe (set of four)	S	NA	NA	NA	NA	NA	NA	NA		
Wheel Covers—Wire with locks (set of four) (NA on AWD models)	NA	NA	P	NA	NA	NA	P	NA		

INTERIOR

	VOYAGER	VOYAGER SE & AWD	VOYAGER LE & AWD	VOYAGER LX & AWD	GRAND VOYAGER SE & AWD	GRAND VOYAGER LE & AWD	GRAND VOYAGER LX & AWD	TOWN & COUNTRY & AWD	TOWN & COUNTRY LE & AWD	TOWN & COUNTRY SE & AWD
Air Conditioning ⁵ —Front	O	O	S	S	P	O	S	S		
Air Conditioning ⁵ /Heater—Rear (FWD models only)	NA	NA	NA	NA	O	O	O	O		
Assist Handle—Liftgate closing	S	S	S	S	S	S	S	S		
Assist Strap—Rear passenger	O	S	S	S	S	S	S	S		
Carpeting—Full interior, color-keyed	S	S	S	S	S	S	S	S		
Cellular Phones ⁶ —Visor, portable	O	O	O	O	O	O	O	O		
Chimes—Warning: fasten seat belts, headlights on, key-in-ignition	S	S	S	S	S	S	S	S		
Console—Forward storage includes cubby bin, large lower storage bin with cassette holders	NA	P	S	S	NA	P	S	S		
Console—Overhead, includes mini trip computer, map/reading lights, storage compartments, and outside temperature/compass readout	NA	NA	S	S	NA	NA	S	S		
Cup Holders—IP center pull-out type	S	S	S	S	S	S	S	S		
Defroster ⁷ —Liftgate, electric	O	O	S	S	O	O	S	S		
Demisters—Front door windows	S	S	S	S	S	S	S	S		
Door Locks—Power	O	O	S	S	O	O	S	S		
Glove Box	S	S	S	S	S	S	S	S		
Heater—With bi-level ventilation	S	S	S	S	S	S	S	S		
Instrumentation—Electronic digital: speedometer, odometer and trip odometer; graphic displays for tachometer, fuel, voltage, oil pressure and engine coolant temperature. Also includes graphic message center and warning lights module	NA	NA	NA	NA	NA	NA	NA	S		
Instrumentation—Fuel gauge, trip odometer, speedometer, engine coolant temperature gauge and warning lights module	S	S	NA	NA	S	S	NA	NA		
Instrumentation—Full gauge cluster; tachometer, voltage and oil pressure gauges and warning lights module	NA	P	S	S	NA	P	S	NA		

INTERIOR (cont.)

	VOYAGER	VOYAGER SE & AWD	VOYAGER LE & AWD	VOYAGER LX & AWD	GRAND VOYAGER SE & AWD	GRAND VOYAGER LE & AWD	GRAND VOYAGER LX & AWD	TOWN & COUNTRY & AWD	TOWN & COUNTRY LE & AWD	TOWN & COUNTRY SE & AWD
Instrument Panel—Color-keyed, padded with black trim bezel	S	S	S	S	S	S	S	S	NA	
Instrument Panel—Color-keyed, padded; includes woodtone bezels	NA	NA	NA	NA	NA	NA	NA	S		
Insulation—Deluxe body sound	NA	P	S	S	NA	P	S	S		
Liftgate Release—Power with instrument panel switch	P	S	S	S	S	S	S	S		
Light Package—Ash receiver, door ajar, glove box, underhood, illuminated entry system, ignition switch time-delay, liftgate dual flood, washer fluid warning, map/reading (front)	NA	P	S	S	NA	P	S	S		
Lights—Front and rear: dome	S	S	S	S	S	S	S	S		
Lights—Map and cargo	P	P	S	S	P	P	S	S		
Map Pockets—Front door trim panel	NA	NA	S	S	NA	NA	S	S		
Mats—Floor, carpeted	NA	P	S	S	NA	P	S	S		
Mirror—Illuminated visor vanity	NA	P	S	S	NA	P	S	S		
Mirror—Rearview: day/night	S	S	S	S	S	S	S	S		
Mirror—Visor vanity: left and right sides	S	S	S	S	S	S	S	S		
Multifunction Control Lever—Includes turn signal, headlamp dimmer and front wiper/washer controls	S	S	S	S	S	S	S	S		
Radio—AM/FM stereo	S	S	S	S	S	S	S	NA		
Radio—AM stereo ⁸ /FM stereo with cassette tape player	O	O	O	O	O	O	O	NA		
Radio—Chrysler Infinity I Sound System	NA	O	P	P	NA	O	P	NA		
Radio—Chrysler Infinity II Sound System	NA	NA	O	O	NA	NA	O	S		
Restraint System—Unibelt on outboard seats; lap belts at rear center seating position	S	S	S	S	S	S	S	S		
Seating—Integrated Child, two	O	O	O	O	O	O	O	NA		
Seating—Power, driver's side only	NA	NA	P	P	NA	NA	P	S		
Seating—Converta-Bed (NA on SWB AWD)	NA	O	NA	NA	O	O	NA	NA		
Seating—Quad Command	NA	O	O	O	NA	O	O	S		
Seating—Seven-Passenger	O	S	S	S	S	S	S	O		
Seat Trim—Leather-with-vinyl	NA	NA	O	O	NA	NA	O	O		
Seat Trim—Cloth-with-vinyl	S	S	S	S	S	S	S	NA		
Seat Trim—Premium cloth-with-leather	NA	NA	NA	NA	NA	NA	NA	S		
Steering Wheel—Luxury, includes minivan air bag ¹	S	S	S	S	S	S	S	S		
Stoplight—Center high mounted	S	S	S	S	S	S	S	S		
Storage Drawer—Under seat: lockable	P	S	S	S	S	S	S	S		
Sun Visor—Cloth covered, right and left	S	S	S	S	S	S	S	S		
Windows—Power, front doors	NA	O	P	P	NA	O	P	S		
Windows—Power, rear quarter vent	NA	NA	S	S	NA	NA	S	S		
Windshield Wipers—Deluxe: variable intermittent wipe and wet arm washers	S	S	S	S	S	S	S	S		
Wiper/Washer—Liftgate: fixed intermittent wipe and wet arm washers	S	S	S	S	S	S	S	S		

S=Standard. O=Optional. Some items may also be available in Customer-PreferredSM Packages. See Customer-PreferredSM Packages and "Available Options" for availability. P=Package only. See Customer PreferredSM Packages for availability. See page 27 for complete package content. NA=Not available. NC=No cost option. C=Credit option.

¹This minivan air bag provides added safety only when seat belts are worn.

²Available in Heavy-Duty Trailer Tow or Sport Handling Packages.

³See dealer for package contents.

⁴Manual mirrors standard on base Voyager.

⁵There are special engine cooling requirements for field-installed air conditioning. Failure to follow these requirements may invalidate warranty. See your dealer for details.

⁶Dealer-installed/supplied item. See page 31 for additional information.

⁷Required on all passenger vehicles registered in New York State.

⁸Some AM stereo broadcasting may not be compatible with this radio. See page 24 for details.

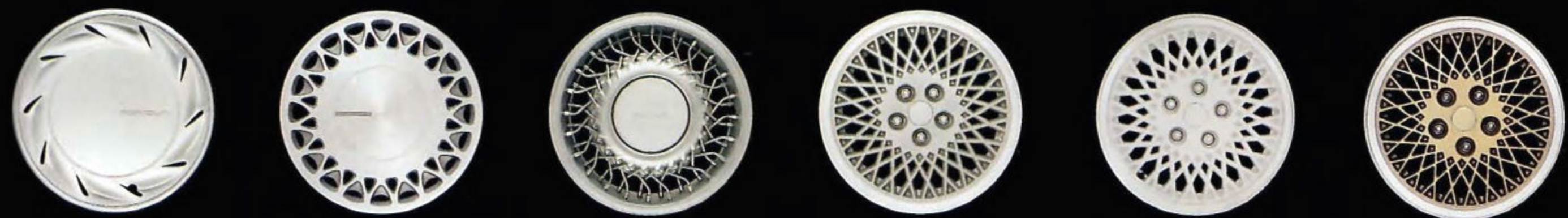

Sport wheel cover Luxury wheel cover 14-inch or 15-inch wire wheel with security lock 15-inch cast aluminum wheel 15-inch white cast aluminum road wheel 15-inch gold cast aluminum road wheel

Tire Size and Type (Set of four)	COLORS													
	BASE VOYAGER	VOYAGER SE	VOYAGER SE (AWD)	VOYAGER LE	VOYAGER LX	VOYAGER LE (AWD)	BASE GRAND VOYAGER	GRAND VOYAGER	GRAND VOYAGER SE	GRAND VOYAGER SE (AWD)	GRAND VOYAGER LE	TOWN & COUNTRY (FWD)	TOWN & COUNTRY (AWD)	
P195/75R14 Steel-Belted Radial Black Sidewall	S	S	NA	S	NA	NA	NA	NA	NA	NA	NA	NA	NA	NA
P205/70R14 Steel-Belted Radial White Sidewall	O	O	NA	O	NA	NA	NA	NA	NA	NA	NA	NA	NA	NA
P205/70R15 Steel-Belted Radial Black Sidewall	P	P	S	P	S	S	S	S	S	S	S	S	S	S
P205/70R15 Steel-Belted Radial White Sidewall	P	P	P	P	NA	P	P	P	P	P	P	P	P	P
Conventional Spare Tire (14" or 15" depending on model)	O	O	NA	O	O	NA	O	O	NA	O	NA	S	NA	
Compact Spare Tire	S	S	S	S	S	S	S	S	S	S	S	NA	S	

S= Standard P= Package O= Optional NA= Not Available

TRAILER TOWING CAPACITY

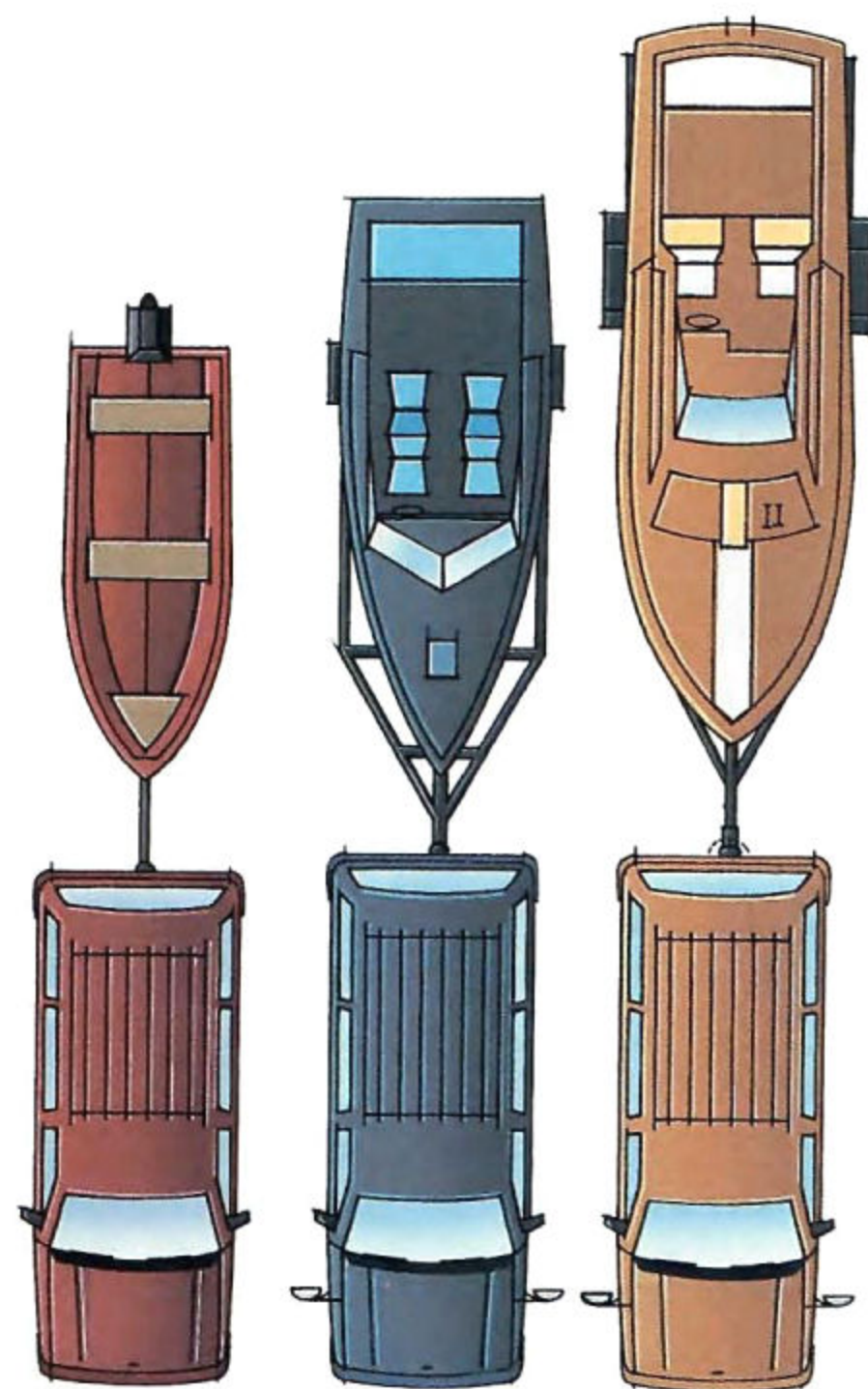

TOWING CAPACITY UP TO 3,100 POUNDS

ALL VOYAGER MODELS WITH 2.5-LITER ENGINES. Voyager's standard 2.5-liter EFI balance-shaft engine with the standard five-speed manual transaxle provides 1,000* pounds of towing capacity. Teamed with the optional three-speed automatic transaxle, up to 1,750* pounds of towing capacity is provided to meet your light trailer needs.

VOYAGER/GRAND VOYAGER/TOWN & COUNTRY MODELS WITH V6 ENGINES.† Voyager's optional 3.0-liter or 3.3-liter SMPI V6 engine with optional three-speed TorqueLite or four-speed automatic transaxles as well as Grand Voyager/Town & Country with their standard 3.3-liter SMPI V6 engine and four-speed automatic transaxle provide you with an additional 500 pounds of towing capacity for a total of 2,250 pounds. AWD models have a maximum towing capacity of 2,000* pounds.

VOYAGER/GRAND VOYAGER SE AND LE MODELS WITH V6 ENGINE, FOUR-SPEED

AUTOMATIC TRANSAXLE AND HEAVY-DUTY TRAILER TOWING PREPARATION PACKAGE. Voyager SE and LE with available 3.0- or 3.3-liter SMPI V6 engine* and four-speed automatic transaxle, as well as Grand Voyager models with standard 3.3-liter SMPI V6 engine† and four-speed automatic transaxle provide you with 3,100* pounds of trailer towing ability for heavy towing/trailer needs, when equipped with the optional Heavy-Duty Trailer Towing Preparation Package. AWD models have a maximum trailer towing ability of 2,900* pounds.

MOPAR MINIVAN TRAILER HITCHES. Chrysler-Plymouth Engineering-approved, custom-designed Class I receiver hitches don't interfere with bumper or fascia and tow up to 2,000 pounds. (All hitches include removable draw bar with fill plug.) Hitches available for long- and short-wheelbase as well as AWD and FWD minivans. Dealer-installed.

*Based on a load of two passengers and luggage.
† See page 26 for further engine information.

COLORS

EXTERIOR	INTERIOR
Black Clear Coat	Bordeaux Champagne Medium Quartz
Twilight Blue Pearl Coat	Twilight Blue Medium Quartz (Base only)
Black Cherry Pearl Coat	Bordeaux Champagne
Platinum Silver Metallic Clear Coat	Bordeaux Medium Quartz
Light Champagne Metallic Clear Coat	Champagne
Diamond Blue Metallic Clear Coat	Twilight Blue Medium Quartz (Base only)
Dark Quartz Gray Metallic Clear Coat	Medium Quartz Champagne (T & C only)
Claret Red Pearl Coat	Bordeaux Champagne Medium Quartz
Bright White Clear Coat	Bordeaux Champagne Twilight Blue Medium Quartz
Teal Pearl Coat	Champagne Medium Quartz
Radiant Red Clear Coat	Champagne Medium Quartz

*Available at extra cost on Voyager.

† Available with optional woodgrain overlay.

‡ Not available with Woodgrain Delete option for Town & Country.

NOTE: Due to printing limitations, the colors shown will vary slightly from actual hues. See your Chrysler-Plymouth dealer for accurate color chips. Clear Coat finish is standard on every 1992 passenger car built by Chrysler Corporation.

EXTERIOR COLORS



MOPAR ACCESSORIES

Here is a partial list of the more popular Mopar accessories available for Chrysler-Plymouth minivans. See your dealer for a complete list and availability by model.

- Cargo tray
- Compact disc changer
- Door edge guards
- Front air deflector
- Luggage rack and accessories
- Molded splash guards
- Moldings, bodyside (stainless steel)
- Running boards

Chrysler Corporation Limited Warranty Protection Every Chrysler Corporation vehicle comes with the protection of a Chrysler Corporation Limited Warranty. See your dealer for details.



MOPAR parts are engineered by Chrysler Corporation for use in your new minivan. When replacement is necessary, be sure to specify MOPAR parts.

Used by professional automotive technicians worldwide.

Chrysler Cellular Systems OKI® Telecom manufactures, services, and is the warrantor of the Visorphone and Portable phone products that are available on selected Chrysler Corporation vehicles. See your dealer for a copy of the limited warranties. Restrictions apply.

®Visorphone is a registered trademark of Cartell, Inc.

Consider Leasing More consumers are considering leasing as an alternative to buying. Leasing a new minivan usually involves a small security deposit and a first month's lease payment. Monthly payments frequently are less than financing a new car purchase. Ask your dealer for details.

Chrysler Credit Financing. Chrysler Credit offers a variety of finance programs that will help make your new minivan even more affordable. These flexible finance and lease programs can be tailored to suit your budget and lifestyle. They include Advantage: Gold Key Lease, Gold Key Plus, College Graduate Plans, Retail Financing, and other special payment plans. Ask your salesperson for details.

Chrysler Purchase Assistance Program for the Physically Challenged Cash reimbursements of up to \$500 are available for qualified adaptive driving devices on 1992 Chrysler Corporation cars and trucks. For further information, contact your dealer or the PHYSICALLY CHALLENGED RESOURCE CENTER AT 1-800-255-9877.

All product illustrations and specifications are based upon current information at the time of publication approval. Although descriptions are believed correct, complete accuracy cannot be guaranteed. Chrysler Corporation reserves the right to make changes from time to time, without notice or obligation, in prices, specifications, colors and materials, and to change or discontinue models. See your dealer for the latest information.

Chrysler, Plymouth, Chrysler-Plymouth and MOPAR are registered trademarks, and Voyager and Town & Country are trademarks of Chrysler Corporation.

Buckle up for safety.



ADVANTAGE:
CHRYSLER-PLYMOUTH



The New Site For Car Brochures

DEZO'S GARAGE

