

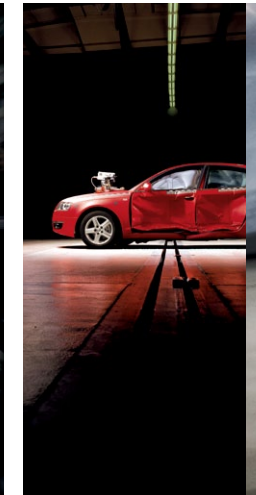

A6 S6

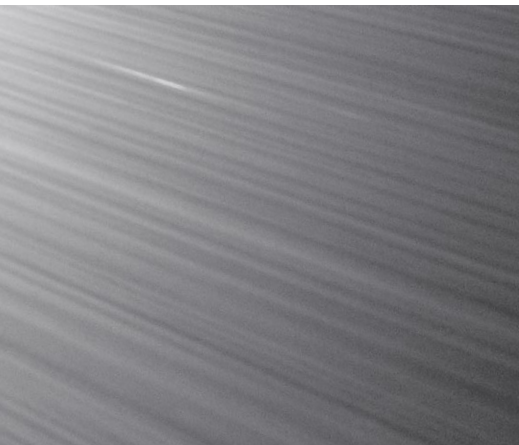

substance always wins the day

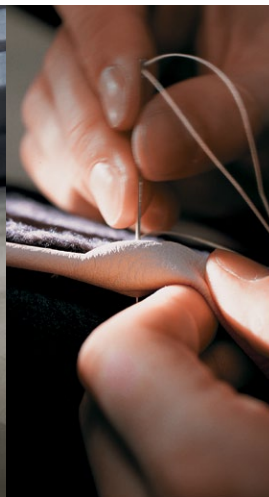

It takes more than hard work, dedication and vision to create the truly exceptional. It takes something intangible. Something you can't quite put your hands on. It's courage, guts, perseverance, passion and fierceness of focus all wrapped into one.

And it's this intangible characteristic that defines all of us at Audi. It's the driving force behind

every pencil line we draw, every calculation we make and every idea we deem not good enough.

It's why every inch and curve and angle has purpose. It's why we test our cars at the highest of speeds for hours on end so they can be driven on any surface and in any condition - rain, shine or white-out blizzard.

It's why substance always wins the day. It's why cutting a corner, even a weld seam in the trunk, would be sacrilegious. And it's why for us scrutiny is so deeply ingrained it's like the very act of breathing.

This is Truth in Engineering. And this is Audi.



a badge doesn't define you
it represents you



A6 Prestige



Contents

- ▶ 6-13 The A6 Experience

 - ▶ 14-17 The S6 Experience

 - ▶ 18 Performance
 - ▶ 20 quattro®
 - ▶ 22 MMI®
 - ▶ 24 Handling
 - ▶ 26 Safety

 - ▶ 28 A6 Premium | Premium Plus
 - ▶ 32 A6 Prestige | 4.2
 - ▶ 36 A6 Packages | Options
 - ▶ 40 S6
 - ▶ 44 S6 Options | Accessories
 - ▶ 48 A6 Wheels | S6 Wheels
 - ▶ 52 Interior Colors
 - ▶ 54 Exterior Colors
 - ▶ 57 Specifications | Configurations
-

A6

luxury at speed

There is no comparison. The Audi A6 is alone at the top with a best-in-class combination of power, handling and luxury. That status is reinforced through the dynamic 300hp 3.0T supercharged engine that allows the A6 to accelerate to 60 MPH in a mere 5.9 seconds. No wonder *Car and Driver* named the A6 "Best in Test."

Sophisticated European styling blended with modern touches makes the A6 a standout among the competition. From the available LED daytime running lights to the signature Singleframe® grille and gently sloping roofline, the A6 exemplifies luxury, style and power.

*Car and Driver, September 2009.

A6 Prestige







engaged

Behind the wheel of the A6, you are fully engaged with performance and comfort, which translates into a dynamic driving experience that only an Audi can provide. The nimble and responsive steering inspires confidence while the aluminum suspension reduces weight, keeping the A6 planted during even the most spirited driving.

Regardless of the weather conditions or tight corners ahead, the outstanding grip of quattro® all-wheel drive in the A6 allows you to maneuver with total confidence.

A6 Prestige

compelling





A6 Prestige

Inside, the A6 offers an abundance of luxury features. The twelve-way, power-adjustable, heated leather seats ensure your driving and riding comfort is optimized. Additionally, a hallmark of Audi craftsmanship is a meticulous attention to detail. For example, carefully honed genuine wood inlays are installed with gap tolerances of less than 0.2 mm.

Luxury also means enjoying the latest technology. The MMI® system is your portal to making the most of your drive. From the full-color 3D navigation with voice control to the convenience of hands-free Bluetooth®, the interior of your A6 is designed to keep you comfortable.

- 1 The ergonomic driver-oriented cockpit puts essential controls easily within reach, allowing you to stay focused and comfortable.
- 2 The available BOSE® 5.1 Surround Sound offers rich, deep bass and clear, crisp treble, transforming the A6 interior into a perfectly tuned concert hall.
- 3 Optional Audi adaptive lights allow you to see ahead in the dark by illuminating turns more effectively. When the turn signal indicator is activated or the steering wheel is rotated beyond a certain point, the dynamic cornering lights move correspondingly.
- 4 The available leather-wrapped, three-spoke, multifunction, sport steering wheel provides convenient controls for Bluetooth, radio channel selection and volume.
- 5 The available Audi advanced key offers the enhanced convenience of unlocking and starting your A6 without removing the key from your pocket or purse.
- 6 Audi parking system, also optional, integrates a rearview camera with real-time viewing of the rear parking area via the MMI screen. Ultrasonic parking sensors measure the distance to the nearest object and audibly warn you when the distance becomes unsafe.



utility of luxury

There's only one other car in the same league as the A6 sedan, and that's the 300hp supercharged A6 Avant. Designed to turn heads as well as turn any drive into an exhilarating one, its graceful and progressive looks belie its capabilities.

It has a unique blend of style, luxury and performance while offering 64 cu. ft. of cargo capacity. Race-bred handling and performance, total luxury, and convenient utility - the stylish A6 Avant offers the best of all worlds.

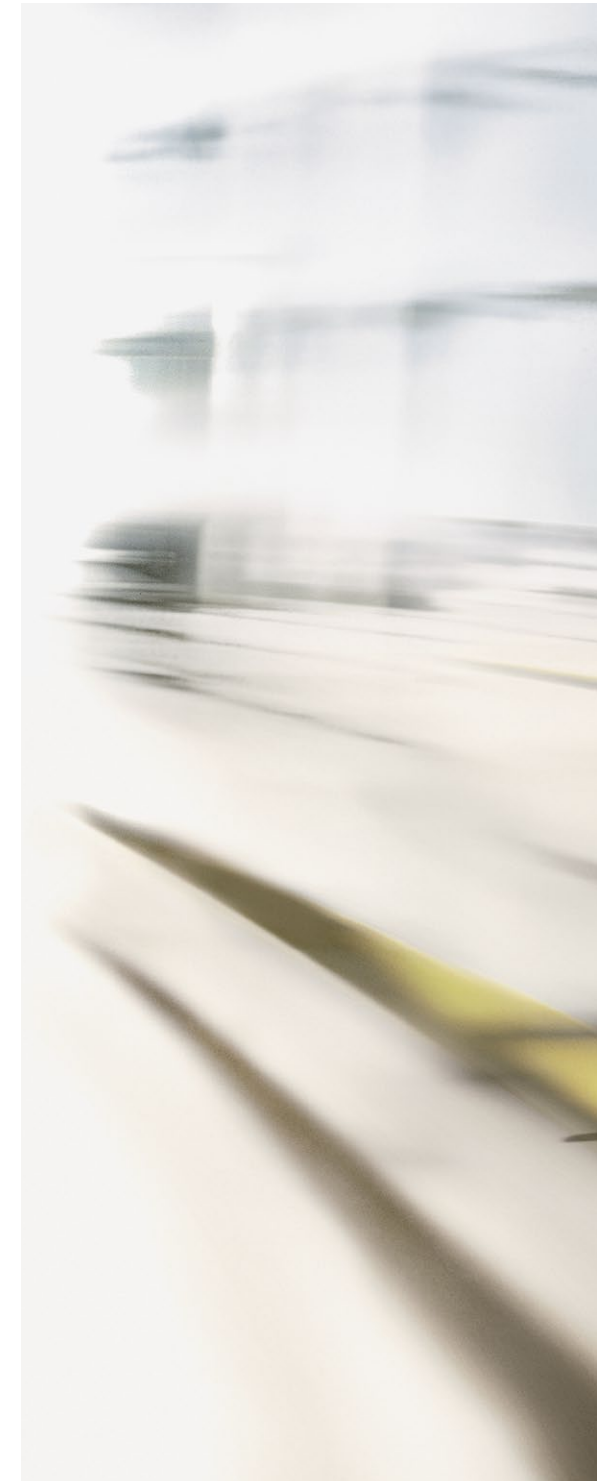



A6 Avant Prestige



S6

hold on



S6

The Audi S6 doesn't grab your attention, it seizes it. Power comes on rapidly via the 435hp V10 engine that delivers 398 lb-ft. of torque and propels the S6 to 60 MPH in just 5.1 seconds.

Of course, 435hp needs more than two driven wheels to reach its full potential. The only car in its class to offer the grip of quattro® all-wheel drive, the S6 feels glued to the road.

Not only does quattro mitigate the elements, but it truly comes alive around corners of all shapes and sizes.

Naturally, all of this advanced technology relies on the precision-engineered lightweight aluminum sport suspension. Thick sway bars stabilize the body through corners and an overall low stance enhances the look of the S6.

All of this performance requires stopping power to match. Braking is controlled and impressive thanks to the 15.2" vented brake rotors and the specially painted, six-piston calipers.

In other words, the S6 delivers an experience that is precise, nimble and extremely responsive.



focused

For those who have an eye for detail, you'll notice the S6 visually sets itself apart with a number of unique accents. First, the LED daytime running lights create a powerful entrance. Then let your eye travel along the side of the S6, and you'll notice Aluminum Optic side view mirrors and black painted brake calipers showcasing the S6 badge. The visual treatment is topped off with the front and side sills adding a purposeful, performance-oriented profile.

The integrated rear spoiler and diffuser plus the unmistakable roar from the quad exhaust reinforces the fact that the S6 is all about pure performance. The 19" alloy wheels complete the overall athletic appearance of the S6.

Inside, the S6 echoes the tonality of the exterior. Special S6 sport seats with integrated head restraints offer comfortable yet enhanced support. The available Carbon Fiber inlays add a motorsport-inspired look to the sleek, driver-oriented cockpit.

Additionally, the three-spoke, multifunction S6 sport steering wheel, with Aluminum Optic shift paddles, is wrapped in leather with contrast stitching. Perfectly sized, the steering wheel feels substantial and is ergonomically designed for performance driving. In all, the S6 is designed to create confidence at speed.





performance fueled by unconventional thinking

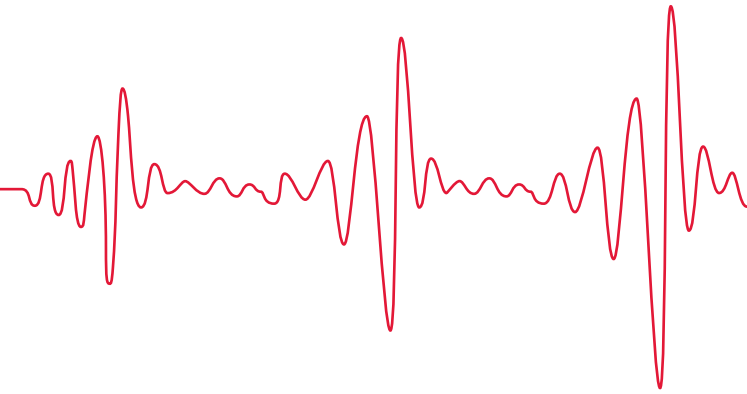

FSI®

Audi Fuel Stratified Injection, or FSI®, offers the benefits of increased performance and fuel efficiency. FSI direct injection delivers a precise amount of fuel directly into the engine cylinders, as opposed to the engine intake runners. This advanced process helps ensure a more complete combustion, thereby diminishing waste and increasing power.

Additionally, the specially designed piston heads compress the fuel-air mixture in a spiraling motion, creating the most efficient combustion possible. Making the most of

these technologies allows for greater efficiency in the combustion process.

By combining FSI and forced induction, such as a supercharger, the 3.0T engine employs a variation of FSI called TFSI®. The principle and benefits are identical. TFSI equipped engines take advantage of significantly higher compression ratios and cylinder pressure, thus fully atomizing fuel and optimizing boost response. The compressor condenses the air flowing into the engine, allowing more air into the cylinder and therefore creating more power

from each ignition. A forced induction engine produces greater power than a similar engine without it, significantly improving the engine's power-to-weight ratio. Consequently, Audi is able to use smaller, more efficient engines and achieve similar power and performance results typically found in larger, less-fuel-efficient engines.

The beauty of FSI and TFSI is that they work at any RPM, maximizing efficiency and generating responsive and optimal power during all driving conditions.

Audi Valvelift System

Audi valvelift system helps elevate the performance characteristics of variable valve timing. The result is smooth power buildup, instantaneous throttle response and up to a 7 percent reduction in fuel consumption.

Audi valvelift system intelligently varies the lift and duration of engine intake valves in response to engine load and power needs. Optimizing air management, Audi valvelift system helps create maximum torque across a broad range of RPM without sacrificing efficiency.

pulse

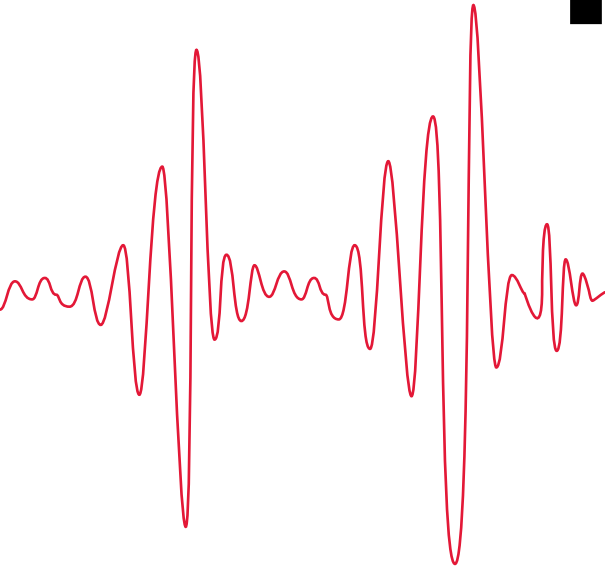

3.0 liter TFSI® engine with 2995 cc of displacement

Maximum 300hp @ 5100 RPM

Maximum 310 lb-ft. of torque @ 2500-5100 RPM

Specific power output of 100hp per liter of displacement

TFSI direct injection with up to 120 bar of pressure

A high compression ratio of 10.5:1

0-60 MPH in 5.9 seconds



3.2 FSI®

The Audi 3.2 liter V6 maintains the Audi commitment to performance. Developing 265hp and 243 lb-ft. of torque, the four-valve-per-cylinder, 3.2 liter engine offers silky-smooth and responsive performance thanks to the combination of FSI® and Audi valvelift system. The use of aluminum for the block and cylinder head makes the 3.2 liter V6 lightweight, resulting in improved handling and even greater efficiency.

3.0 TFSI®

The all-aluminum Audi 3.0 liter TFSI® V6 engine benefits from the combination of FSI direct injection and supercharging to create 300hp and 310 lb-ft. of torque. The impressive torque is generated over a wide range, from 2500 to 5100 RPM, making full power usable at any speed. The four-vane Roots-style supercharger makes the 3.0 liter V6 exceptional. The potent combination of FSI with supercharging allows Audi to achieve V8 power and torque with the efficiency of a V6.

4.2 FSI®

The high-revving Audi 4.2 liter FSI V8 produces a remarkable 350hp and 325 lb-ft. of torque. Constructed of lightweight aluminum, the 4.2 FSI incorporates many of the same fuel-saving technologies found in the 3.2 FSI and 3.0 TFSI, including direct injection and a two-stage intake manifold. The combination of lightweight aluminum and advanced FSI technology creates a balance that contributes to increased efficiency of up to 23 MPG highway; improved vehicle dynamics and impressive power delivery.

*EPA estimate: 23 highway MPG. Your mileage will vary.

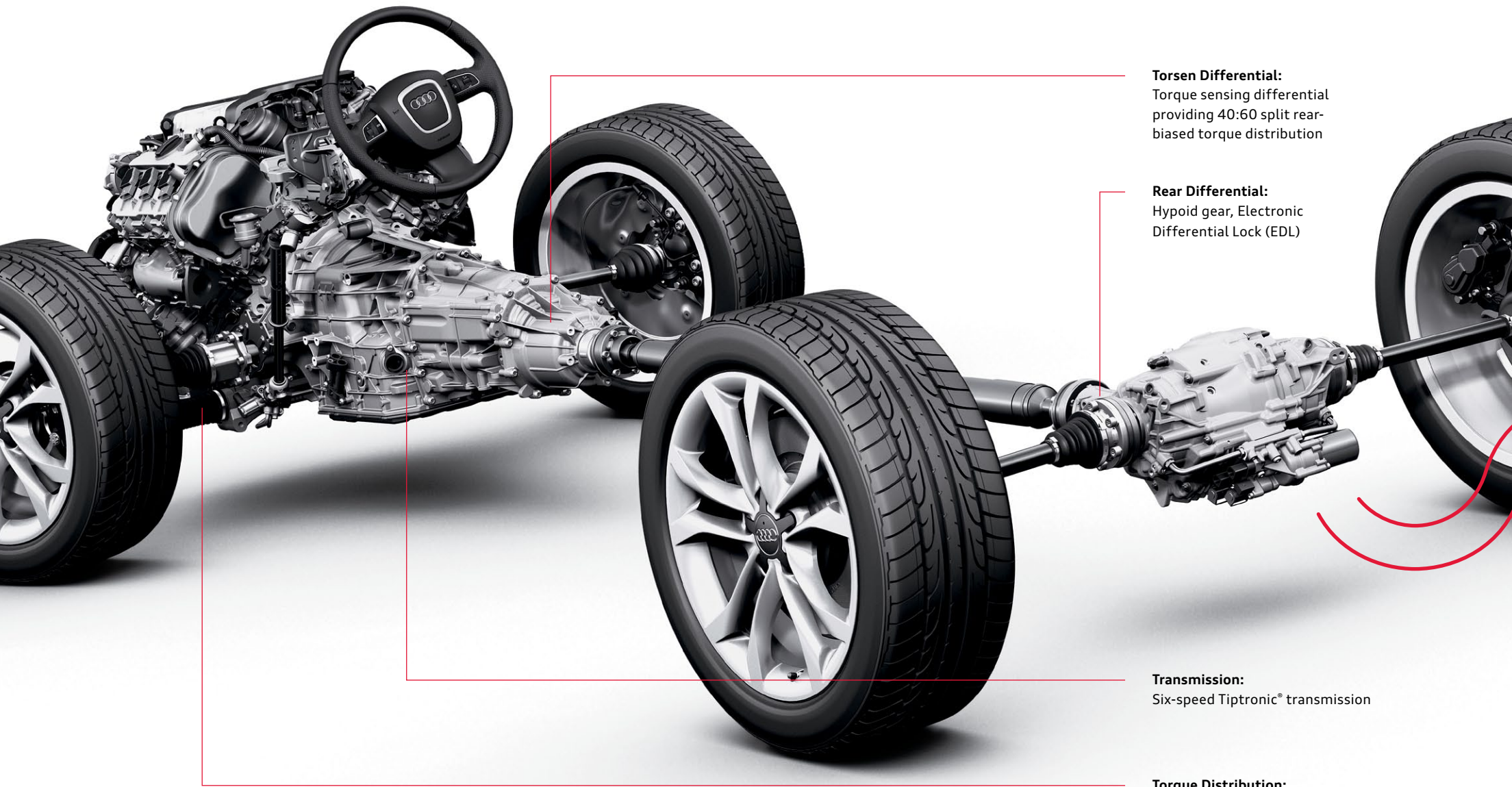

Torsen Differential:
Torque sensing differential providing 40:60 split rear-biased torque distribution

Rear Differential:
Hypoid gear, Electronic Differential Lock (EDL)

Transmission:
Six-speed Tiptronic® transmission

Torque Distribution:
The rear-biased torque distribution results in more neutral handling, more agile steering, minimal load change reactions and increased driving stability

get ready, this is where
it becomes visceral



awe

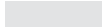
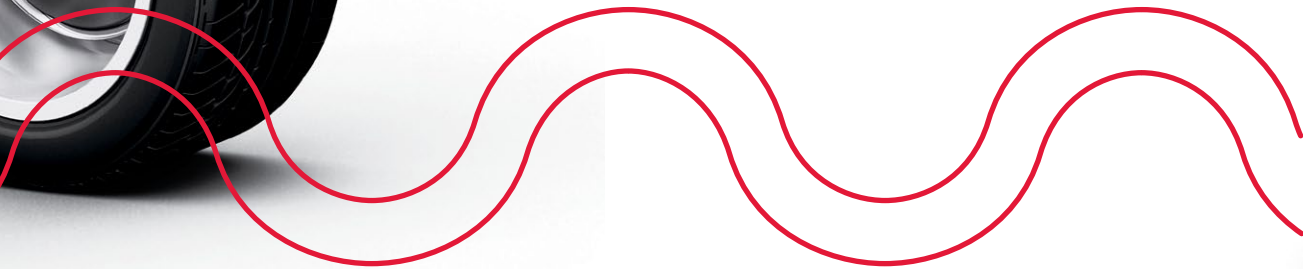

The concept is ingenious, the solution brilliant. Often imitated, nothing drives like quattro®, the world's most innovative all-wheel drive system. It's a technology that we've been developing for 30 years. And the competition? They're just now beginning to realize what we've known for three decades.

For you, quattro means unmatched traction and confidence in less-than-ideal driving conditions and unequalled performance all other times.

Permanent all-wheel drive systems are not created equal. And they certainly don't perform that way

either. quattro is essentially a mechanical system devised around a torque-sensing, self-locking, center differential that shifts torque instantaneously to where it's needed. This means quattro is adjusting power between front and rear axles more than 100 times a second, helping ensure torque is delivered to the wheels where traction exists.

In normal driving situations, quattro distributes the power between each axle by sending 40 percent to the front wheels and 60 percent to the rear wheels, enhancing the driving dynamics while helping maintain optimum control. Constantly assessing grip, quattro helps ensure the best

possible combination of traction and handling, regardless of the road conditions.

What you experience behind the wheel is confidence-inspiring handling. Curves are relished. Rain and snow are greeted with relative indifference. And every drive is an experience in performance bliss.



connected

customizing nearly every aspect
of your driving experience

■ Car Setup

The personalization of your vehicle settings can be managed through the MMI® system, enabling you to set your preference for daytime running lights settings, central locking features, the audio system, date and time format, and windshield wiper settings, as well as monitor your service intervals. Individual preferences are all accessed, modified and stored via MMI.

■ Media

Managing your entertainment options with the MMI system is effortless. With a simple push of a button, MMI allows you to select among the radio tuner, CD/DVD player, AMI or the integrated hard drive. The hard drive allows you to preload 10-GB of personal audio files. Using the control knob, the media source menu and music options are easily viewed on the high-definition MMI screen. Once a selection is made, the track name is displayed.

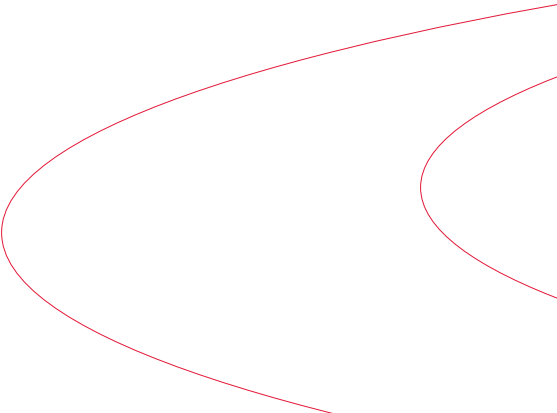
A red abstract graphic consisting of several overlapping, curved lines that resemble a stylized car wheel or a motion blur effect, located in the bottom right corner of the page.

The easy-to-use MMI® (Multi Media Interface) operating system allows you to access various vehicle systems, such as navigation, radio, telephone, voice activation and car setup, to optimize your driving experience. Two major components make the system intuitive.

First, the MMI control knob with integrated joystick, located near the shift lever, allows you to navigate various system functions easily

without diverting your eyes from the road. Secondly, voice control offers an additional method to interface with the MMI system. By simply speaking the desired command, the system recognizes the driver's instructions. In both cases, system inputs, selections and options are displayed on the high-definition MMI screen.

Audi was the first manufacturer to use an automotive-grade NVIDIA® chip in the navigation

system that offers high-quality on-screen graphics. The result is smooth, zoom-in and zoom-out functionality and crisp, 3D graphics of buildings and topography for easier navigation.

At its core, the MMI system has a central media and communications computer that controls the navigation functions, the Bluetooth® universal mobile phone preparation, voice control, and media with integral DVD drive and a 40-GB

hard drive. With the Audi music interface (AMI), an iPod® and other mobile media players can be accessed via the MMI system for easy music selection.

From music to navigation and more, the MMI system is your pathway to truly personalizing your driving experience.

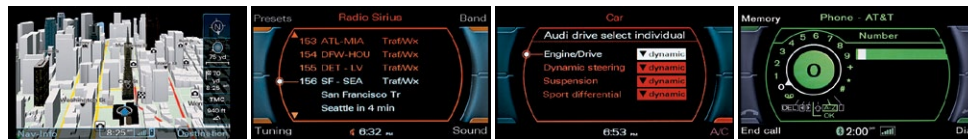

Radio

In addition to offering analog, HD Radio™ Technology and SIRIUS® Satellite Radio tuning, MMI allows you to tune the receiver by scrolling through your preset radio stations; adjust the audio settings, and customize the listening experience by tailoring the speaker output. You can also preview what's playing on SIRIUS Satellite Radio stations without changing the station you're currently listening to.

Voice Control

Building on the convenience of the MMI system, voice control allows you to operate the main functions, such as telephone and directory, with voice commands. The navigation system is also voice-enabled, allowing for town and street names to be spoken as a navigation destination without having to spell them out letter by letter. The same capability exists for the telephone feature.

Telephone

The MMI system offers integrated Bluetooth technology to support more than one Bluetooth-compatible mobile phone. The system allows the driver or passengers to seamlessly switch among the supported phones and their listings as well as the contacts stored in the MMI system.

3D Navigation

The map displayed on the MMI screen is shown in a three-dimensional topographical format. For added convenience, a large number of cities are displayed in a detailed, three-dimensional format, visually articulating building and road specifics for easier readability.

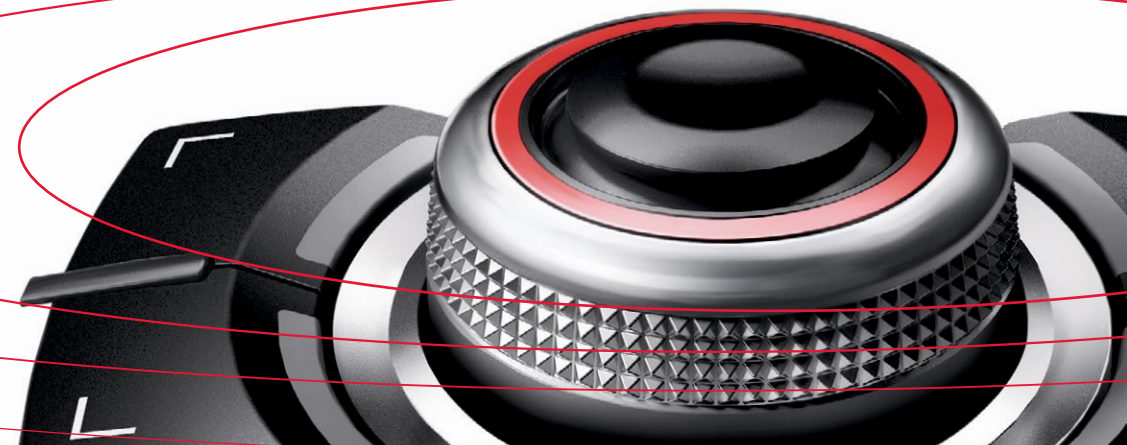



power applied through sophisticated engineering for legendary handling

planted

Audi has spent decades developing, testing and refining its suspension systems. It's an ongoing process that continuously identifies new technology and applies it to improving the driving experience. Integrating leading technologies such as Servotronic® speed-sensitive steering and quattro® all-wheel drive with finely tuned brakes and a rigid chassis results in the refined handling dynamics for which Audi is famous. The suspension system in an Audi consistently delivers precise steering feel, exceptional ride comfort and sharp handling.

■ Four-link Front Suspension

With the finely tuned front suspension components secured to the subframe, the four-link front suspension increases ride quality by isolating road harshness and vibration from the cabin. The use of weight-saving aluminum for critical components helps reduce unsprung mass at each wheel, allowing the suspension to respond more rapidly. The net effect is a driving experience that is extremely responsive, smooth and predictable. It is handling that has become an Audi hallmark.

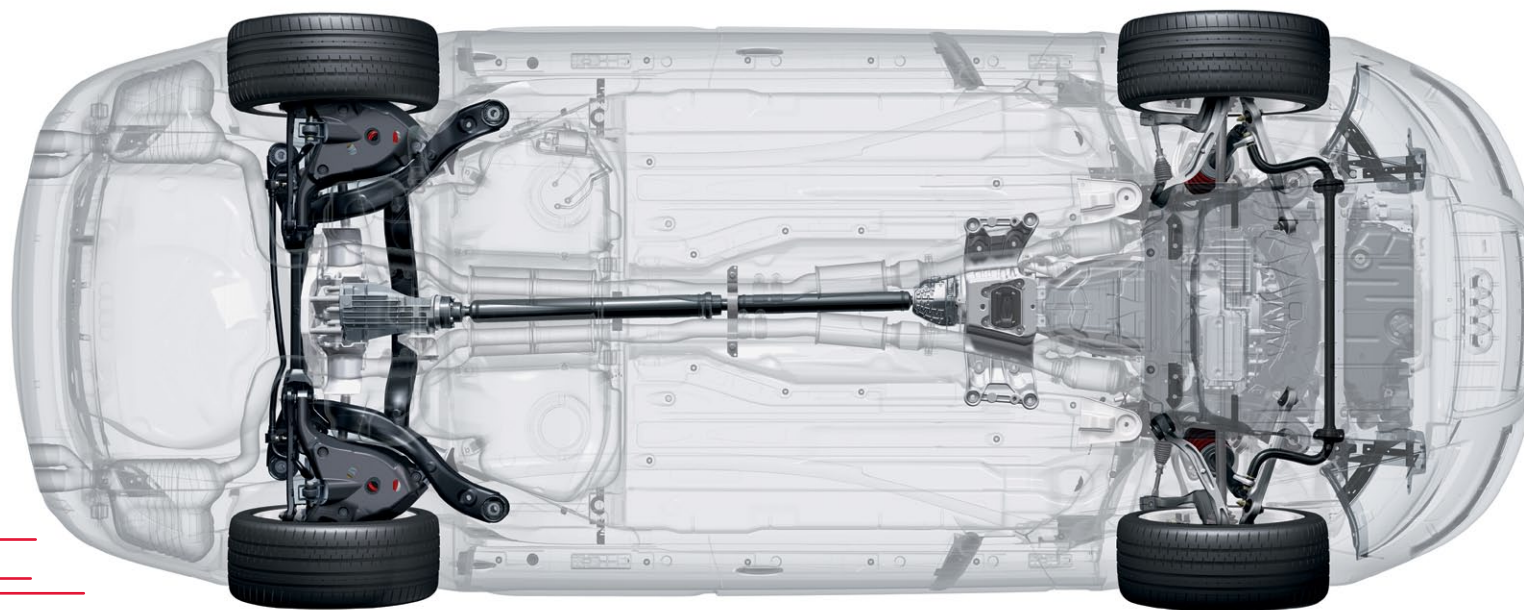

Rear Suspension

The self-tracking, trapezoidal-link rear suspension provides an incomparable level of driving dynamics. This structure offers a high degree of stiffness that helps ensure precise handling, while the control arm components absorb a great deal of the force encountered by the wheels. The combination helps improve handling response while dampening the abrupt impacts commonly encountered while driving. Additionally, the wheel guidance components are fixed to the subframe with both rubber and metal bushings to further isolate vibrations from the occupant cell, ensuring a quieter, smoother driving experience.

Dampers and Springs

The linear, high-strength steel springs rest on both the structure of the body and the trapezoidal arms. The two-sleeve gas pressure dampers at all four wheels are tuned for maximum comfort and dynamic handling. This translates to confidence-inspiring handling and control.

Audi Servotronic® Steering

Servotronic® is speed-dependent power steering in which the amount of power assist provided is dictated by road speed, providing even more comfort and convenience for the driver. The amount of power assist is greatest at low speeds, making it easier to maneuver the car. At higher speeds, an electronic-sensing system gradually reduces the level of power assist, creating a tighter, more dynamic steering feel.

To further enhance handling and ride comfort, significant attention to detail has been paid to suppressing vibrations at the attachment points along the steering column. The result is a nearly 100 percent reduction in steering wheel vibration, offering the driver smoothness at virtually any speed.

S6 Sport Suspension

Enhancing the overall performance of the S6, the S sport suspension is specially tuned for dynamic handling. Firm springs and dampers provide direct and precise contact with the road while thicker sway bars offer additional support, reducing overall body roll during hard cornering.

Thanks to the integration of lightweight aluminum materials throughout the front and rear suspension, unsprung weight is reduced, allowing for rapid suspension response. The result is a performance-oriented yet comfortable ride in any driving scenario.

confidence

we've got your back, front, sides and top

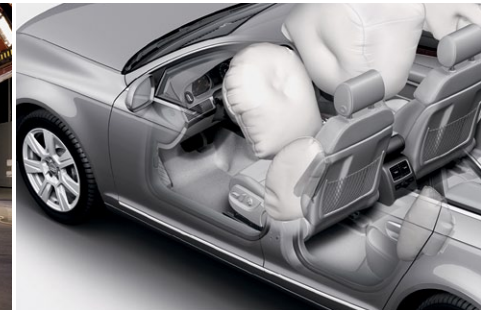

Audi has always held firm the belief that prevention is the best safety feature of all. And the Audi A6 and S6 offer an abundance of features designed to help keep you out of harm's way. For instance, the Electronic Stabilization Program (ESP®) helps keep the vehicle traveling in its intended direction by utilizing ABS, the traction control of ASR and the electronic brake force distribution of EBD.

Specifically, when ESP detects loss of traction, it automatically cuts the throttle and applies the brakes to help "steer" the vehicle where you intend to go. Braking is automatically applied

to each wheel: at the outer front wheel to mitigate oversteer, or the inner rear wheel to mitigate understeer.

Audi has implemented a number of ingenious features to help maximize braking effectiveness. In wet conditions, the brake disc wiping system gently pulses the brakes to help dissipate water buildup. Keeping the discs as dry as possible helps promote the most effective braking. Additionally, the brake assist system is able to detect an attempt at full braking and apply full stopping power when required. The advantage is that braking distance is significantly reduced.

Inside, the Audi safety systems prepare for the worst once the brake assist system is engaged. The safety belt pre-tensioners are activated, for all occupants, and lock the safety belts in place. This is intended to help keep passengers in the safest position in the event of a collision.

When prevention isn't enough, the combination of crumple zones and high-strength steel helps deliver a tremendous level of protection for the driver and passengers. Crumple zones, at the front and rear of the vehicle, are designed to dissipate the energy and force of a collision by deforming upon impact. The high-strength steel used in and around the occupant cell is designed to protect the integrity of the passenger compartment and those within it.

The six standard, second-generation airbags* provide an additional measure of safety. They include front-impact airbags for the driver and passenger and are designed to help protect the head. Seat-mounted, side-impact airbags for the front seat occupants are designed to help protect the thorax in a collision. And the side-curtain airbags offer front and rear occupants head protection in the event of a side collision or rollover.

Reacting to rear collision forces, the head restraints help cradle the occupant's head in an effort to reduce the likelihood of a whiplash injury.

Everything comes together to reinforce our commitment to all-encompassing safety.



We have 30 years of experience in developing the world's most sophisticated all-wheel drive system. The result is quattro®. It helps maximize traction by automatically adjusting power to each wheel, making the car feel planted – regardless of conditions. Combine ESP and race-bred braking technology, and you'll feel a level of confidence you've never experienced before.

- ▶ quattro helps increase your margin of safety by helping you maintain maximum traction in a variety of weather conditions.
- ▶ ESP helps ensure your vehicle maintains the intended direction of travel by continuously adjusting a number of drivetrain variables.
- ▶ Four-wheel disc brakes with brake disc wiping offer optimal braking in all kinds of weather.

*Airbags are supplemental restraints only and will not deploy in all crash circumstances. Always use safety belts and seat children in the rear, using restraint systems appropriate for their size and age. This is a dramatization and does not depict what will happen in an accident. All bags will not inflate in real world accidents and if multiple bags deploy they will be in various stages of inflating/deflating and will never all be inflated at the same time.

A6 3.2 | 3.0T Premium

1



2



3

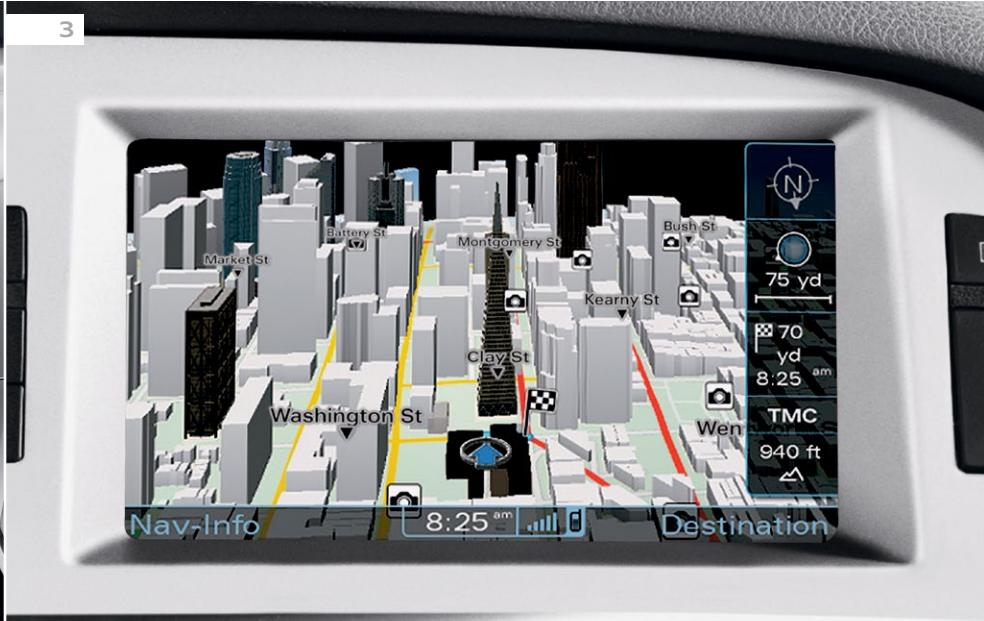

4



1 S line® front and rear bumpers | The unique S line® bumpers accentuate the already powerful and bold exterior of the A6.

2 LED taillights | LED lights are superior to conventional bulbs, thanks to faster activation speeds and bright light emissions. In addition, they can last an entire vehicle lifetime and consume up to 50 percent less energy while adding a signature look to your Audi.

3 Audi MMI® Navigation plus | Audi MMI® Navigation plus features a 7" full-color LCD screen and MMI control logic. The A6 comes equipped with the latest generation of MMI, powered by a 40-GB hard drive and an NVIDIA® processor to enhance graphics. This generation MMI offers HD Radio™ Technology and a color driver information system, real-time traffic, and 3D topography graphics that include the buildings in many cities and the crystal clear digital AM and FM sound of HD Radio Technology with over 1,000 new stations. Also included is voice control for navigation and telephone functions.

4 Heated front seats | With a convenient touch of a button, the six-level seat heating system warms the entire surface of the seat. [Standard on 3.0T only]

5 Audi music interface | This connective technology offers intelligent integration with the iPod® and iPhone®. Any iPod Generation 4 and higher may be connected through the glove box, providing full iPod controls on the MMI screen. This feature allows connection of a USB flash drive or a conventional auxiliary audio input as well.

6 Bluetooth® mobile phone preparation | The advanced technology of the Audi A6 allows you to conveniently access your Bluetooth®-enabled phone's features via the MMI operating system, allowing for easy, intuitive hands-free communication. For specific compatibility and operation instructions, refer to audiusa.com/bluetooth or contact your local Audi dealer for the latest listing of compatible phones.

7 HomeLink® | HomeLink® is integrated into the overhead controls and uses a simple three-button system to control garage doors, gates and even lights in your home.

8 Power front seats with lumbar support | The twelve-way power front seats allow the driver and passenger to electronically adjust the seats' forward/backward position, height, angle of cushion and back, and lumbar support.

9 Power-adjustable, heated exterior mirrors with integrated LED turn signals | Powerful and efficient LED turn indicator lamps are artfully incorporated into the sculpted mirror housing, complementing the modern and fluid design of the vehicle. The exterior mirrors are electronically adjustable and heated to help prevent fogging.

10 SIRIUS® Satellite Radio | Enjoy commercial-free music, talk and more, available with a free three-month trial subscription to the SIRIUS® Satellite Radio network.

Features listed are standard on the Premium model unless otherwise noted.

+ FEATURE NOT SHOWN

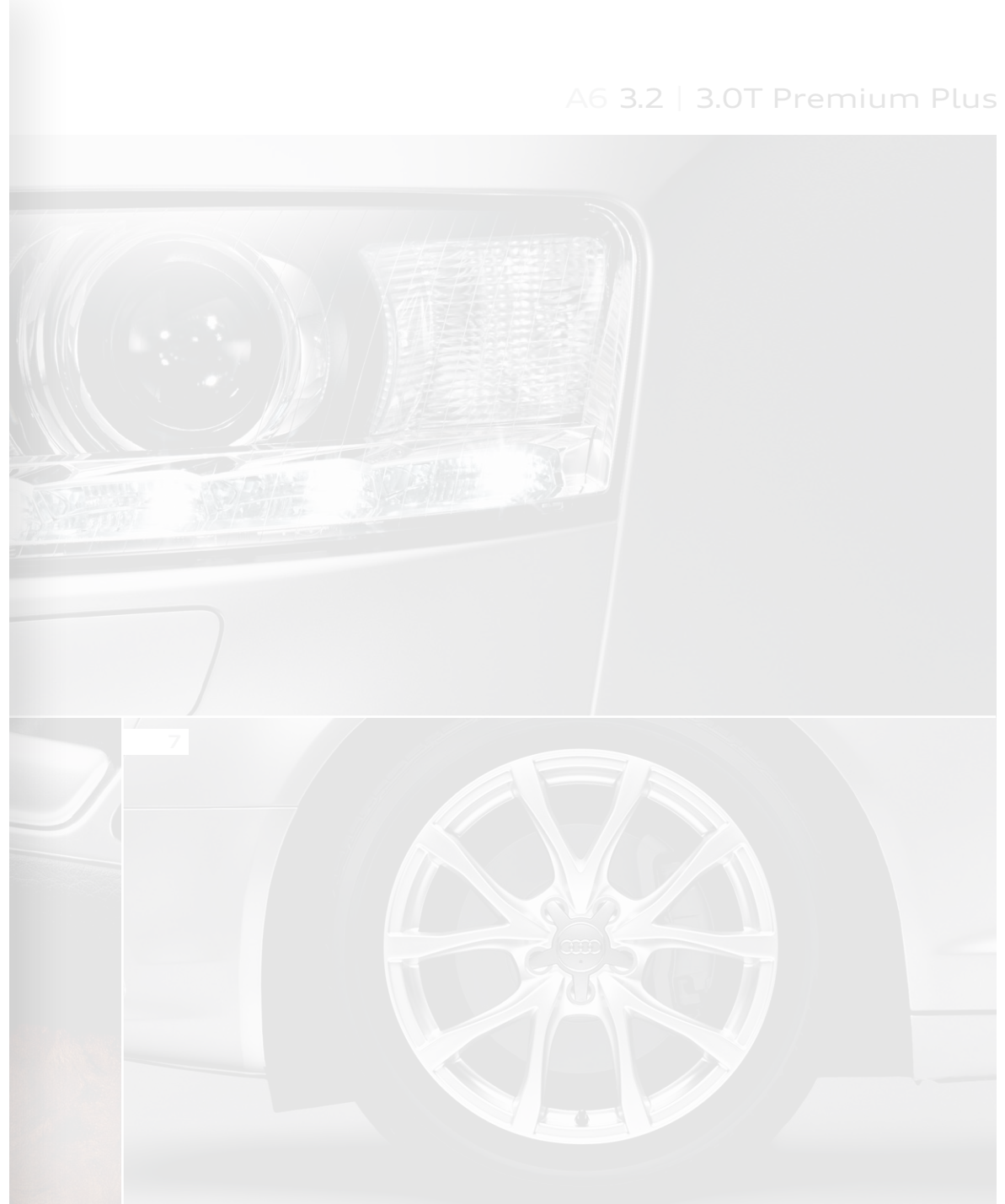

A6 3.2 | 3.0T Premium

1



3

A6 3.2 | 3.0T Premium Plus

5. Audi xenon plus headlights with LED daytime running lights | The signature LED daytime running lights and high-intensity headlights not only add a distinct look to the vehicle, they also improve visibility while using half of the energy of conventional bulbs.

6. Driver memory | At the touch of a button, your driver seat position and side view mirrors are set to your desired levels. This feature stores two driver settings.

7. 18" five-Y-spoke wheels with 245/40 all-season tires | The luxurious appearance of these 18" wheels with all-season tires are a refined complement to your A6.

+ Auto-dimming interior mirror with compass | The rearview mirror with automatic dimming recognizes glaringly bright beams behind the car and darkens the mirror automatically. An electronic control unit varies the darkening effect quickly and continuously according to actual ambient light conditions. Vehicle direction is digitally displayed in the corner of the mirror.

+ Rear parking sensors | Ultrasonic rear parking sensors measure the distance to the nearest object and audibly warn you when the distance becomes unsafe.

4

2



Features listed are standard on the Premium Plus model unless otherwise noted.

+ FEATURE NOT SHOWN



A6 3.0T Prestige



¹ **Audi advanced key** | With this advanced keyless entry system, your vehicle can be locked or unlocked and started without removing the key from a pocket or purse. When the key is present, doors can be unlocked, the steering wheel can be released and the vehicle can be turned on without inserting the key into the ignition.

² **BOSE® 5.1 Surround Sound** | A total of 13 high-performance speakers are placed throughout the cabin to create a rich and dynamic stereo experience. Speakers include a 3.25" center fill speaker in the instrument panel, two 3.25" high-range speakers in each front door and two 5.25" Richbass® woofers housed in a custom-engineered enclosure in each front door. In addition, the BOSE® exclusive AudioPilot® noise compensation technology adjusts volume in response to unwanted road noise, enhancing the listening experience.

³ **Power-adjustable steering column** | The power-adjustable steering column is an added touch of luxury and convenience, helping to ensure your driving position is optimized and comfortable.

⁴ **Audi adaptive headlights** | Utilizing input from the steering wheel and speed of the vehicle, Audi adaptive headlights pivot up to 15 degrees to allow you to see ahead in the dark by lighting up corners more effectively.

⁵ **Audi parking system** | This safety-enhancing system integrates a rearview camera for real-time viewing of the rear parking area, while rear ultrasonic parking sensors measure the distance to the nearest object and audibly warn you when the distance becomes unsafe.

⁶ **18" ten-spoke wheels with 245/40 all-season tires** | The 18" wheels offer refined luxury and year-round performance when paired with all-season tires.

Features listed are standard on the Prestige model unless otherwise noted.

+ FEATURE NOT SHOWN



A6 3.0T Prestige



A6 4.2

4. **Audi MMI® Navigation plus** | Audi MMI® Navigation plus features a 7" full-color LCD screen and MMI control logic. The A6 comes equipped with the latest generation of MMI, powered by a 40-GB hard drive and an NVIDIA® processor to enhance graphics. This generation MMI offers HD Radio™ Technology and a color driver information system, real-time traffic and 3D topography graphics that include the buildings in many cities. Also included is voice control for navigation and telephone functions.

5. **Audi parking system** | This safety-enhancing system integrates a rearview camera for real-time viewing of the rear parking area, while rear ultrasonic parking sensors measure the distance to the nearest object and audibly warn you when the distance becomes unsafe.

6. **18" ten-spoke wheels with 245/40 all-season tires** | The 18" wheels offer refined luxury and year-round performance when paired with all-season tires.

+ **Audi xenon plus adaptive headlights with LED daytime running lights** | The signature LED daytime running lights and high-intensity headlights not only add a distinct look to the vehicle, they also improve visibility while using half of the energy of conventional bulbs. In addition, Audi adaptive headlights utilize input from the vehicle's steering and speed to pivot up to 15 degrees, allowing you to see ahead in the dark by lighting up corners more effectively.

+ **Driver memory** | At the touch of a button, your driver seat position and side view mirror settings are set to your desired levels. This feature stores two driver settings.

+ **BOSE® 5.1 Surround Sound** | A total of 13 high-performance speakers are placed throughout the cabin to create a rich and dynamic stereo experience. Speakers include a 3.25" center fill speaker in the instrument panel, two 3.25" high-range speakers in each front door and two 5.25" Richbass® woofers housed in a custom-engineered enclosure in each front door. In addition, the BOSE® exclusive AudioPilot® noise compensation technology adjusts volume in response to unwanted road noise, enhancing the listening experience.

+ **Auto-dimming interior mirror with compass and heated, power-folding, auto-dimming exterior mirrors with memory** | The rearview mirror with compass and exterior mirrors recognize bright lights behind the car and darken the mirror glass automatically. In addition to being electronically adjustable, the power-folding exterior mirrors feature helps protect the mirrors by collapsing them inward to fit in tight spaces. Exterior mirrors are heated to help prevent fogging.

+ **Power-adjustable steering column** | The power-adjustable steering column is an added touch of luxury and convenience, helping to ensure your driving position is optimized and comfortable.

+ **S line® front and rear bumpers** | The unique S line® bumpers accentuate the already powerful and bold exterior of the A6.

Features listed are standard on the 4.2 model unless otherwise noted.

+ FEATURE NOT SHOWN



A6 Packages



A6 Packages

A6 Options

¹ **Cold Weather Package** | This package provides the driver, front passenger and rear occupants their ideal level of comfort via the multilevel seat heating system, which is designed to heat the entire surface of the seat; warming is initiated with a convenient knob. The package also includes a heated, four-spoke, multifunction steering wheel, which provides easy access to volume control, radio station and CD track selection, navigation voice prompts, and telephone dialing. [Includes shift paddles when equipped with a Sport Package or Prestige models]

² **18" Sport Package** | For more performance-oriented handling characteristics, the 18" Sport Package includes a specially tuned, firmer sport suspension. The 18" five-spoke wheels have a bold, aggressive design and come equipped with all-season tires. The Sport Package includes a three-spoke, multifunction steering wheel with shift paddles, allowing effortless, race-inspired gear shifting while enabling you to keep your hands on the wheel.

³ **19" Sport Package** | The 19" Sport Package offers the same sport suspension, seats, and three-spoke, multifunction steering wheel with shift paddles as the 18" Sport Package but comes equipped with dynamically designed 19" five-tri-spoke wheels equipped with summer performance tires. [Premium Plus and Prestige only]



A6 Packages

1



2



A6 Options

⁴ **Rear side airbags*** | The A6 offers rear side airbags, which can help reduce the risk of severe injuries in certain collisions.

⁵ **Audi side assist** | Audi side assist helps monitor blind spots, as well as fast-approaching vehicles, at a range of about 150 ft. to the rear of the car. If Audi side assist identifies another vehicle when the driver signals to change lanes, it informs the driver using an LED light in the exterior mirror. [Prestige only]

* Airbags are supplemental restraints only and will not deploy in all crash circumstances. Always use safety belts and seat children in the rear, using restraint systems appropriate for their size and age.



S6

1



2



3



1. S6 sport seats | The S6 sport seats offer greater lateral support, thanks to more prominent side bolsters and extendable thigh support. The seat functions include electric lumbar support and integrated head restraints. With standard Silk Nappa leather, the S6 sport seats add a distinctive performance-oriented look and feel.

2. S6 aluminum doorsills | This stylish and distinctive S6 aluminum trim accents the overall interior excellence.

3. S6 sport steering wheel with shift paddles | The leather-wrapped, three-spoke design has a performance look and feel that's further accented with Aluminum Optic shift paddles and an S6 badge. The multifunction steering wheel provides easy access to audio volume control, radio station and CD track selection, navigation voice prompts and telephone dialing.

4. Audi advanced key | With this advanced keyless entry system, your vehicle can be locked or unlocked and started without removing the key from a pocket or purse. When the key is present, doors can be unlocked, the steering wheel can be released and the vehicle can be turned on without inserting the key into the ignition.

5. Heated front and rear seats | For soothing warmth, the six-level front and rear seat heating system warms the entire surface of the seat.

6. Audi xenon plus adaptive headlights with LED daytime running lights | The signature LED daytime running lights and high-intensity headlights not only add a distinct look to the vehicle, they also improve visibility while using half of the energy of conventional bulbs. In addition, Audi adaptive headlights utilize input from the vehicle's steering and speed to pivot up to 15 degrees, allowing you to see ahead in the dark by lighting up corners more effectively.

7. Audi parking system | This safety-enhancing system integrates a rearview camera for real-time viewing of the rear parking area, while rear ultrasonic parking sensors measure the distance to the nearest object and audibly warn you when the distance becomes unsafe.



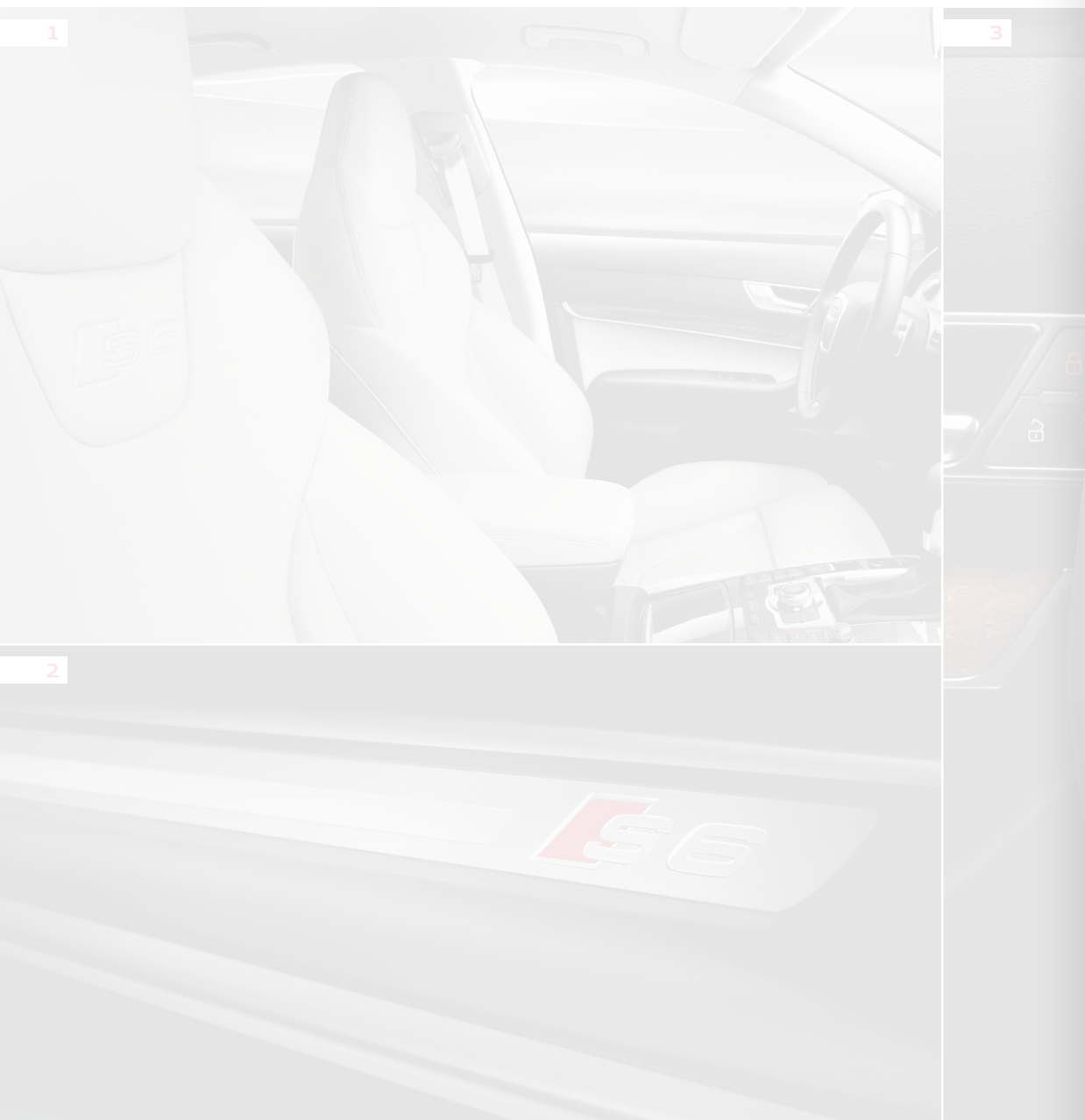

- 4. S6 exterior** | The S6 includes a number of distinguishing exterior features. Among them are the unique S design front bumper with LED daytime running lights, rear bumper with diffuser to complement the quad exhaust tailpipes, unique lower door blades and Aluminum Optic mirrors with integrated LED turn signals.
- 5. 19" five-parallel-spoke S design wheels with 265/35 summer performance tires*** | The 19" five-parallel-spoke S design wheel option is impressive in its stance and design. The wheels come equipped with summer performance tires, which provide improved driving dynamics and superior handling and performance.
- 6. Gray Birch wood inlay** | Appointed on the dash, center console and door panels, the genuine Gray Birch wood inlay enhances the interior with a sophisticated look and feel.
- + BOSE® 5.1 Surround Sound** | A total of 13 high-performance speakers are placed throughout the cabin to create a rich and dynamic stereo experience. Speakers include a 3.25" center fill speaker in the instrument panel, two 3.25" high-range speakers in each front door and two 5.25" Richbass® woofers housed in a custom-engineered enclosure in each front door. In addition, the BOSE® exclusive AudioPilot® noise compensation technology adjusts volume in response to unwanted road noise, enhancing the listening experience.
- + SIRIUS® Satellite Radio** | Enjoy commercial-free music, talk and more, available with a free three-month trial subscription to the SIRIUS® Satellite Radio network.
- + Bluetooth® mobile phone preparation** | The advanced technology of the Audi S6 allows you to conveniently access your Bluetooth®-enabled phone's features via the MMI® operating system, allowing for easy, intuitive, hands-free communication. For specific compatibility and operation instructions, refer to audiusa.com/bluetooth or contact your local Audi dealer for the latest listing of compatible phones.
- + HomeLink®** | HomeLink® is integrated into the overhead controls and uses a simple three-button system to control garage doors, gates and even lights in your home.
- + Audi MMI® Navigation plus** | Audi MMI Navigation plus features a 7" full-color LCD screen and MMI control logic. The S6 comes equipped with the latest generation of MMI, powered by a 40-GB hard drive and an NVIDIA® processor to enhance graphics. This generation MMI offers HD Radio™ Technology and a color driver information system, real-time traffic and 3D topography graphics that include the buildings in many cities and the crystal clear digital AM and FM sound of HD Radio Technology with over 1,000 new stations. Also included is voice control for navigation and telephone functions.

* See page 49 for important safety information regarding summer performance tires.



S6 Options

1



2



3



S6 Options

- 1 Milano leather seats*** | These standard seats are outfitted with special, soft Milano leather that is luxurious and offers added comfort for both the driver and passengers.

- 2 Carbon Fiber inlay** | Exclusive to Audi S vehicles, the sophisticated Carbon Fiber inlay adds a powerful feel to the interior.

- 3 18" seven-double-spoke alloy wheels with 255/40 summer performance tires†** | The dramatic 18" wheels equipped with summer performance tires create an eye-catching complement to the sophisticated exterior.

- 4 Rear side airbags*** | The S6 offers rear side airbags, which can help reduce the risk of severe injuries in certain collisions.

- 5 Audi side assist** | Active at speeds over 19 MPH, Audi side assist monitors blind spots and fast-approaching vehicles at a range of 150 ft. When a vehicle is present within the monitored area, the system warns you via LED lights in the exterior mirrors.

* Not available on sport seats.

† See page 49 for important safety information regarding summer performance tires.

* Airbags are supplemental restraints only and will not deploy in all crash circumstances. Always use safety belts and seat children in the rear, using restraint systems appropriate for their size and age.

• FEATURE NOT SHOWN

A6 S6 Accessories

5



7

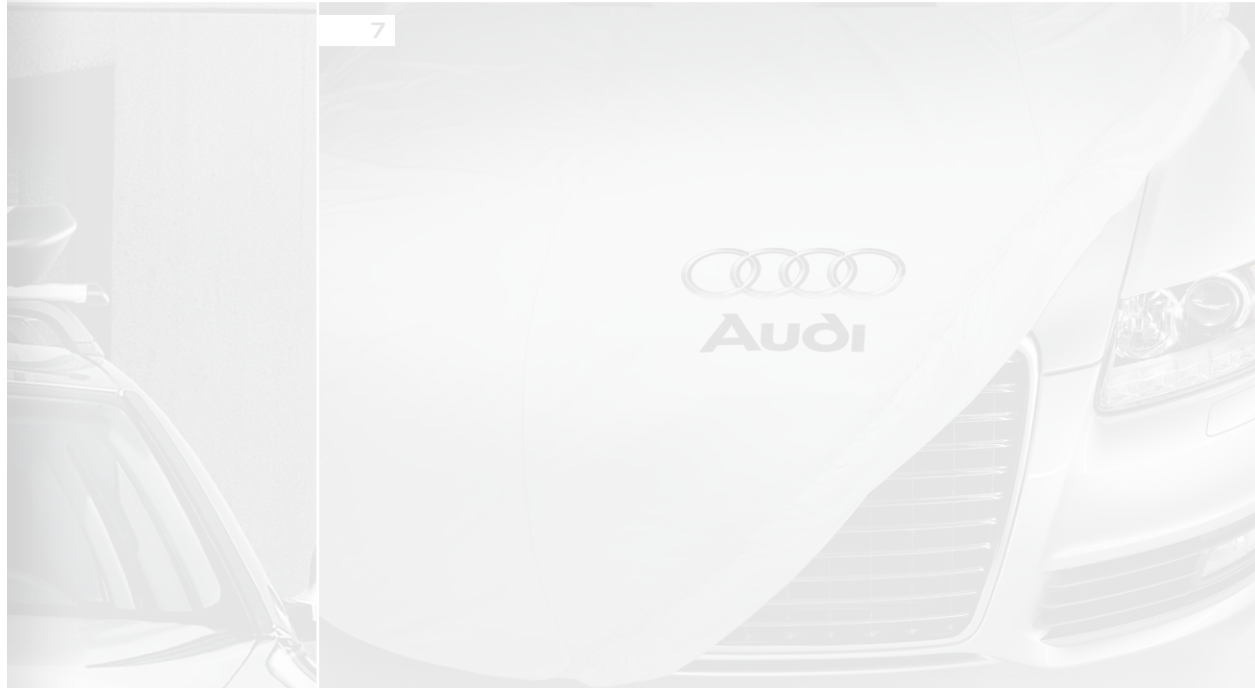

S6 Options



A6 S6 Accessories

4. 19" Calera wheels | These alloy wheels grab attention with their distinctive split-spoke design. All of our wheels are specially engineered to meet the strict tolerances of our Audi original equipment wheels.

5. Compact roof box | The compact roof box offers a large, 16.95 cu. ft. capacity. Size: 81" long, 30" wide. [Must be used in combination with the base carrier bars, which are sold separately]

6. Aluminum luggage rack | High-quality anodized-aluminum construction and a generous load area make this an excellent carrier. Side rails help prevent load shifting.

7. Storage cover | Help protect your Audi from the elements with this lightweight, easy-to-use cover. Made of Stormshield® material custom-tailored for your Audi. Includes a storage bag.

+ Upright Barracuda® bicycle holder | This bike holder fits 20-80 mm bike frames and is easy to use. It features a molded front wheel well that allows the bike to stand on its own as you easily secure the bike. Lock included. [Must be used in combination with the base carrier bars, which are sold separately]

+ Premium all-weather floor mats | These all-weather floor mats feature a deep-ribbed, channeled design to help protect the floor and carpeting from water, mud, sand and snow. Available in black with contrasting logo. Set of four mats.

+ All-weather cargo mat | Custom fit for your Audi. Textured plastic material controls load shifting. The raised lip contains spills and helps protect cargo area carpeting from stains. [Sedan only]



A6 Wheels



A6 Wheels

¹ **17" five-spoke wheels with 245/45 all-season tires** | These wheels give the A6 a sporty look and feel. The all-season tires help provide a safe and comfortable ride in a variety of weather conditions. [A6 Premium]

² **18" five-Y-spoke wheels with 245/40 all-season tires** | The 18" five-Y-spoke wheels offer a stylish and refined look to the A6 exterior. [A6 Premium Plus]

³ **18" ten-spoke wheels with 245/40 all-season tires** | This impeccably designed wheel provides a touch of sporty elegance to the A6. [A6 Prestige and 4.2]

⁴ **18" five-spoke design wheels with 245/40 all-season tires** | The refined simplicity of this sporty five-spoke wheel complements the fluid lines of the A6. [Sport Package only]

⁵ **19" five-tri-spoke wheels with 255/35 summer performance tires*** | The 19" five-tri-spoke wheel option is impressive in its stance and design. The wheels come equipped with summer performance tires, which provide improved driving dynamics and superior handling and performance. [Optional on Sport Package with Premium Plus and Prestige only]



S6 Wheels



* Summer performance tires are designed for optimum performance and handling in warm climates. They are not suitable for cold, snowy or icy weather conditions. If you drive under those circumstances, you should equip your vehicle with all-season or winter tires, which offer better traction under those conditions. We suggest you use the recommended winter or all-season tires specified for your car or their equivalent. These summer performance tires also have a lower aspect ratio that aids performance and handling. However, in order to avoid tire, rim or vehicle damage, it is important that the inflation pressure is regularly checked and maintained at recommended levels. Serious wheel and tire damage may occur if the vehicle is operated on rough or damaged road surfaces, or upon encountering road debris or obstacles. Please also remember in making your selection that, while these tires deliver responsive handling, they may ride less comfortably and make more noise than other choices. Finally, these tires may wear more quickly than other choices. For more information on all of these topics, please consult the owner's manual, your local dealer or call 1-800-FOR-AUDI.

A6 Wheels

1



4



5



2



3



S6 Wheels

6. 19" five-parallel-spoke S design wheels with 265/35 summer performance tires* | These impressive wheels are standard on the S6 and are complemented by summer performance tires, which provide the driver with excellent traction.

7. 18" seven-double-spoke wheels with 255/40 summer performance tires* | The eye-catching seven-double-spoke wheels are optional and come equipped with summer performance tires. [Optional on S6]

* Summer performance tires are designed for optimum performance and handling in warm climates. They are not suitable for cold, snowy or icy weather conditions. If you drive under those circumstances, you should equip your vehicle with all-season or winter tires, which offer better traction under those conditions. We suggest you use the recommended winter or all-season tires specified for your car or their equivalent. These summer performance tires also have a lower aspect ratio that aids performance and handling. However, in order to avoid tire, rim or vehicle damage, it is important that the inflation pressure is regularly checked and maintained at recommended levels. Serious wheel and tire damage may occur if the vehicle is operated on rough or damaged road surfaces, or upon encountering road debris or obstacles. Please also remember in making your selection that, while these tires deliver responsive handling, they may ride less comfortably and make more noise than other choices. Finally, these tires may wear more quickly than other choices. For more information on all of these topics, please consult the owner's manual, your local dealer or call 1-800-FOR-AUDI.

6



7



A6 S6 Interior Seating | Decorative Inlay

AMARETTO LEATHER | DARK BROWN WALNUT WOOD INLAY



AMARETTO/BLACK LEATHER | DARK BROWN WALNUT WOOD INLAY



DECORATIVE INLAY OPTIONS

DARK BROWN WALNUT WOOD INLAY <small>[Standard]</small>
BEIGE BIRCH WOOD INLAY <small>[Standard]</small>
GRAY BIRCH WOOD INLAY <small>[S6 only]</small>
CARBON FIBER INLAY <small>[S6 option]</small>

* Optional inlay shown

LIGHT GRAY LEATHER | DARK BROWN WALNUT WOOD INLAY



BLACK LEATHER | DARK BROWN WALNUT WOOD INLAY



BLACK SILK NAPPA LEATHER | GRAY BIRCH WOOD INLAY [S6 only]



CARDAMOM BEIGE LEATHER | BEIGE BIRCH WOOD INLAY



SILVER SILK NAPPA LEATHER | CARBON FIBER INLAY* [S6 option]



A6 S6 Make yours.



A6 Condor Gray METALLIC



A6 Oyster Gray METALLIC

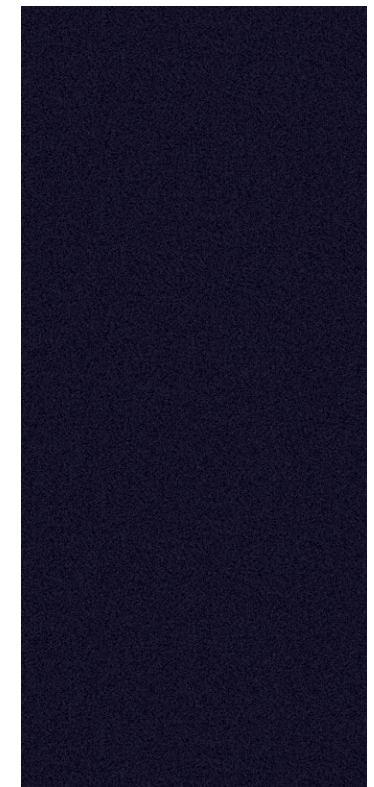

-
- 1 | Amaretto
 - 2 | Amaretto/Black
 - 3 | Light Gray
 - 4 | Black
 - 5 | Cardamom Beige
 - 6 | Black Silk Nappa leather [S6 only]
 - 7 | Silver Silk Nappa leather [S6 only]
-



A6 S6 Night Blue PEARL EFFECT



A6 S6 Ice Silver METALLIC



A6 S6 Aventurine Blue PEARL EFFECT



A6 S6 Ibis White



A6 S6 Phantom Black PEARL EFFECT

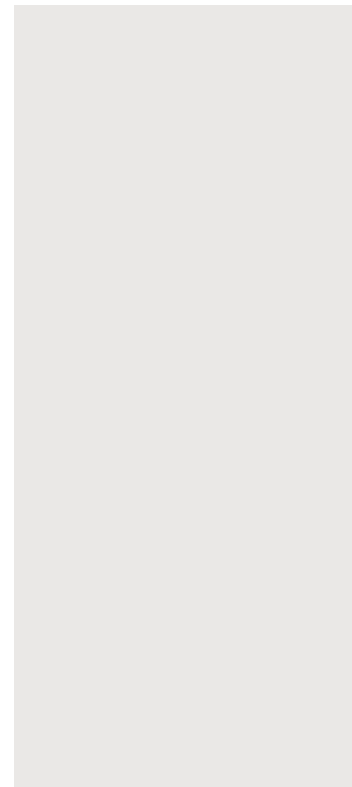
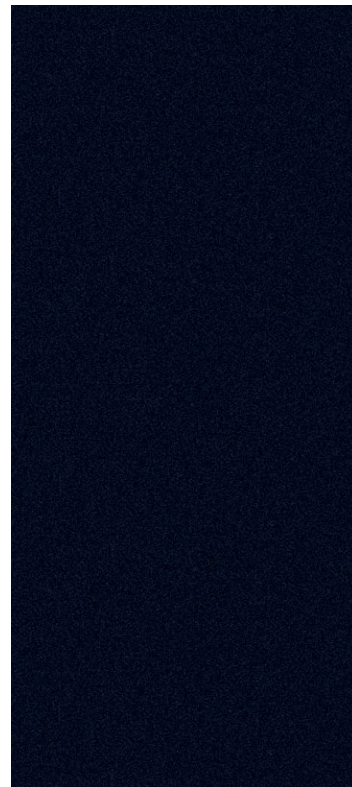



A6 S6 Quartz Gray METALLIC



A6 S6 Brilliant Black

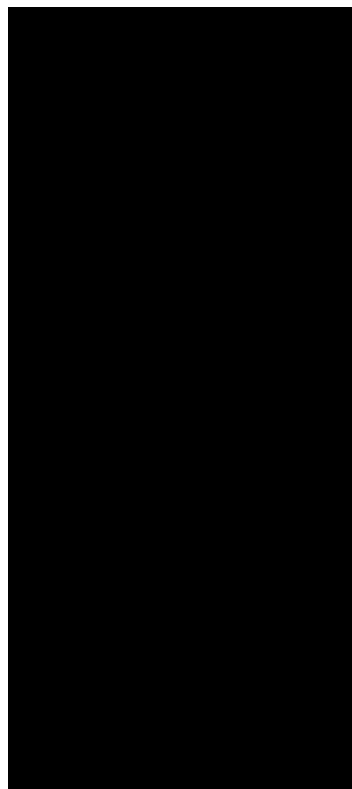
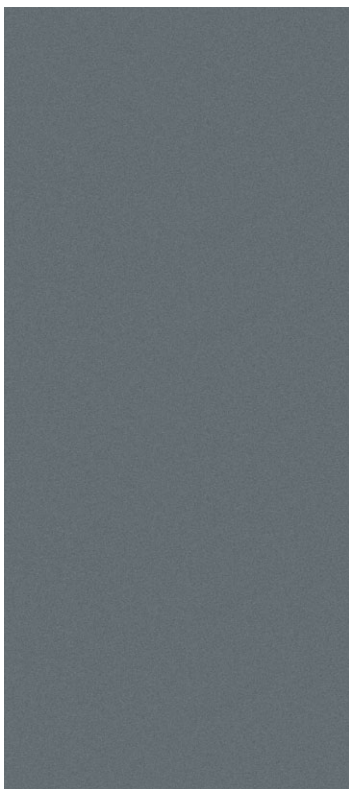

A6 S6 Specifications | Configurations

Chassis Technical	A6	S6
Four-link front suspension with upper and lower control arms, stabilizer bar and individual, gas-charged coil springs/shock absorbers	S	S
Independent trapezoidal-link rear suspension with rigid subframe, stabilizer bar and individual, gas-charged coil springs/shock absorbers	S	S
Servotronic® speed-sensitive power steering – varies assistance based on vehicle speed	S	S
quattro® permanent all-wheel drive system utilizing torque-sensing center differential – 40:60 rear-biased torque split [not available on A6 3.2]	S	S
Sport suspension calibration	0	-
S6 sport suspension calibration	-	S
Multitronic® Continuously Variable Transmission (CVT) [A6 3.2 only]	S	-
Tiptronic® automatic transmission [not available on A6 3.2]	S	S
Fully galvanized steel unibody with multistep anti-corrosion protection	S	S

Safety Security	A6	S6
Driver and front passenger advanced dual-stage airbag* supplemental restraints	S	S
Driver and front passenger seat-mounted side thorax airbag* supplemental restraints	S	S
Seat-mounted rear side airbags* for outboard seating positions	0	0
Sideguard® head curtain airbags* for both rows of seats	S	S
Front passenger occupant detection for airbag* supplemental restraints	S	S
Front three-point safety belts with automatic pretension and force limiters; height adjustable for front seating positions	S	S
Three rear three-point safety belts with belt force limiters for outboard passenger seating positions	S	S
Three rear head restraints	S	S
Safety belt reminder for driver and front passenger	S	S
Lower Anchors and Tethers for CHildren (LATCH) in rear seats	S	S
Pinch protection for passenger compartment windows	S	S
Central locking system with selective unlock feature	S	S
Impact protection – including reinforced high-strength steel/aluminum crossmembers, reinforced bumpers and rigid occupant cell	S	S
Tire pressure monitoring system	S	S
Electronic Stabilization Program (ESP®)	S	S
Anti-lock Brake System (ABS) with Electronic Brake-pressure Distribution (EBD)	S	S
Brake assist – a system that automatically senses emergency braking and applies maximum power boost to reduce overall stopping distance	S	S
Front ventilated disc brakes	S	S
Electromechanical parking brake	S	S
Audi hill hold assist	S	S
Reflectors in rear of all doors	S	S
Anti-theft vehicle alarm system with blinking theft-deterrent light	S	S

-	Not Available	0	Option	S	Standard
---	---------------	---	--------	---	----------

The table above represents the standard equipment on the Premium model. Many popular options are combined and available on the Premium Plus and Prestige models. Please see the package contents in this brochure for complete details.

Exterior	A6	S6
Singleframe® grille with choice of front license plate holder or filler panel with two chrome strips	S	S
Power adjustable and heated side mirrors with integrated LED turn signals	S	-
Auto-dimming, power-adjustable and power-folding heated exterior mirrors with integrated LED turn signals	0	-
S Aluminum Optic auto-dimming, power-adjustable and power-folding heated exterior mirrors with integrated LED turn signals	-	S
Halogen headlights with automatic self-leveling	S	-
Audi xenon plus headlights with automatic self-leveling	0	S
Programmable LED daytime running lights	0	S
Audi adaptive lights, including cornering lights [not available on A6 3.2]	0	S
LED rear taillights	S	S
Rear fog light	S	S
Roof rails [Avant only]	S	-
S line® exterior	S	-
Headlight washers – high pressure, retractable and heated	S	S

Interior	A6	S6
Leather-wrapped, four-spoke, multifunction steering wheel with controls for audio volume, Bluetooth® phone* and audio seek functions	S	-
Leather-wrapped, four-spoke, multifunction steering wheel with shift paddles and controls for audio volume, Bluetooth phone* and audio seek functions	0	-
S6 multifunction sport steering wheel with Aluminum Optic shift paddles and controls for audio volume, Bluetooth phone* and audio seek functions	-	S
Manual tilt and telescoping steering column	S	-
Power tilt and telescoping steering column	0	S
Sunroof with power tilt and open/close	S	S
Auto-dimming interior mirror with compass	0	S
HomeLink® universal remote	S	S
Lighting Package	S	S
Leather-wrapped shift knob	S	-
Leather-wrapped/aluminum shift knob	-	S
Heated front seats [optional on A6 3.2]	S	S
Heated rear seats	0	S

Interior <small>(CONTINUED)</small>	A6	S6
Split folding 60/40 rear seatbacks	S	S
Pass-through with ski bag	-	S
S6 sport seats in Silk Nappa leather	-	S
Valcona leather seating surfaces	S	-
Twelve-way power front seats	S	S
Two-position memory function for driver's seat and outside mirrors	0	S
Power lumbar adjustment	S	S
Sun visors with vanity mirrors	S	S
Front center armrest	S	S
Dark Brown Walnut wood decorative inlays	S	-
Beige Birch wood decorative inlays	0	-
Gray Birch decorative inlays	-	S
Carbon Fiber decorative inlays	-	0

Infotainment Technology	A6	S6
Audi MMI® Navigation plus¹– HDD navigation with voice control, color driver information display, six-CD/DVD changer	S	S
Audi music interface with iPod® and iPhone® integration; includes one cable for connection	S	S
Digital Signal Processing (DSP) extended sound system with ten speakers, six-CD changer in glove box, AM/FM radio, aerial diversity operated by MMI; includes dynamic station list that continuously updates radio stations based on signal strength	S	-
BOSE® Surround Sound with 13 speakers and noise compensation AudioPilot®	0	S
SIRIUS® Satellite Radio with three-month trial subscription	S	S
Audi advanced key – keyless start, stop and entry	0	S
Rearview parking camera [not available on A6 3.2]	0	S
Electronic cruise control	S	S
Power tailgate lift [Avant only]	S	-
Rain sensor for automatic windshield wipers	S	S
Audi side assist	0	0
Audi parking system with camera	0	S
Rear parking sensors	0	S
Bluetooth mobile phone preparation*	S	S
HomeLink® universal remote	S	S

* Airbags are supplemental restraints only and will not deploy under all crash circumstances. Always use safety belts and seat children in the rear, using restraint systems appropriate for their size and age.

¹ Your Audi vehicle is equipped with a phone preparation utilizing Bluetooth interface to enable hands-free functionality [compatible mobile phones sold separately]. You will need a Bluetooth-enabled mobile phone in order to utilize this function. Not all Bluetooth-enabled mobile phone models are compatible with Audi phone preparation. Visit audiusa.com/bluetooth, or contact your local Audi dealer for the latest listing of compatible phones. Audi recommends use of the Audi phone cradle [sold separately] with your mobile phone while operating this vehicle.

² Audi Navigation plus depends on signals from the worldwide Global Positioning Satellite network. The vehicle's electrical system, and existing wireless and satellite technologies, must be available and operating properly for the system to function. The system is designed to provide you with suggested routes in locating addresses, destination and other points of interest. Changes in street names, construction zones, traffic flow, points of interest and other road system changes are beyond the control of Audi of America, Inc. Complete detailed mapping of lanes, roads, streets, toll roads, highways, etc., is not possible, therefore you may encounter discrepancies between the mapping and your actual location. Please rely on your individual judgement in determining whether or not to follow a suggested Audi Navigation plus route. Periodically, the mapping is updated, and a new DVD will be required in order to maintain the latest navigation information available to us. These will be available for purchase from time to time at an additional cost. Consult your dealer or call 1-800-FOR-AUDI for details.

A6 Model Configurations

A6 Sedan 3.2 liter FSI® with Multitronic® CVT and FrontTrak® front-wheel drive

Power and Performance

3.2 liter DOHC V6 gasoline engine with FSI direct injection and Audi valvelift system

+ Horsepower: 265hp @ 6500 RPM

Torque: 243 lb-ft. @ 3250 RPM

+ 0-60 MPH in seconds – 6.9

Top track speed*: 130 MPH

+ Fuel economy estimate, city/highway†: 18/28 MPG

A6 Sedan/Avant 3.0 liter TFSI® with six-speed Tiptronic® automatic transmission and quattro® all-wheel drive

Power and Performance

3.0 liter supercharged, DOHC V6 gasoline engine with dual intercoolers, FSI direct injection and variable valve timing

+ Horsepower: 300hp @ 5100 RPM

Torque: 310 lb-ft. @ 2500 – 5100 RPM

+ 0-60 MPH in seconds – 5.9 Sedan/6.1 Avant

Top track speed*: 130 MPH

+ Fuel economy estimate, city/highway†: 18/26 MPG

A6 Sedan 4.2 liter FSI with six-speed Tiptronic automatic transmission and quattro all-wheel drive

Power and Performance

4.2 liter DOHC V8 gasoline engine with FSI direct injection and variable valve timing

+ Horsepower: 350hp @ 6800 RPM

Torque: 325 lb-ft. @ 3500 RPM

+ 0-60 MPH in seconds – 5.8

Top track speed*: 130 MPH

+ Fuel economy estimate, city/highway†: 16/23 MPG

S6 Model Configurations

S6 Sedan 5.2 liter FSI with six-speed Tiptronic automatic transmission and quattro all-wheel drive

Power and Performance

5.2 liter DOHC V10 gasoline engine with FSI direct injection and variable valve timing

+ Horsepower: 435hp @ 6800 RPM

Torque: 398 lb-ft. @ 3000-4000 RPM

+ 0-60 MPH in seconds – 5.1

Top track speed*: 155 MPH

+ Fuel economy estimate, city/highway†: 14/19 MPG

A6 S6 Dimensions

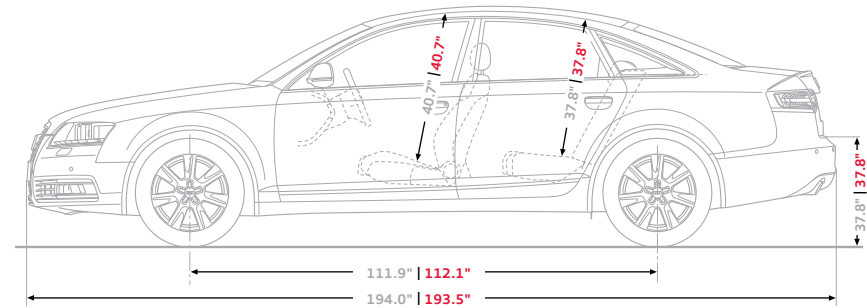
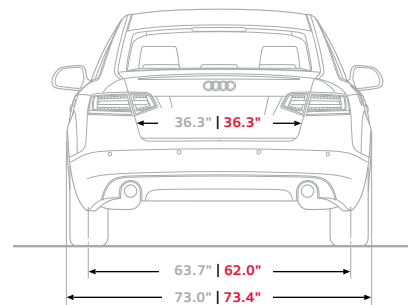
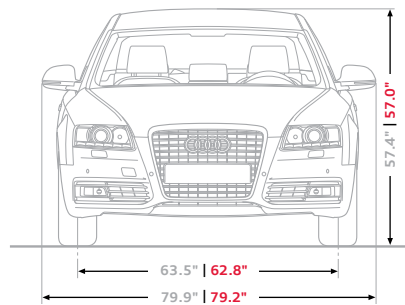

* Top track speed for A6 electronically limited to 130 MPH in the U.S. Obey all local speed and traffic laws.

† EPA estimates; your mileage will vary. † Top track speed for S6 electronically limited to 155 MPH in the U.S. Obey all local speed and traffic laws.

2011 | A6 S6

Audi of America

Audiusa.com

Facebook.com/Audi

BR-A6-10-1600US

Note: A word about this brochure. Audi of America, Inc. believes the specifications in this brochure to be correct at the time of printing. However, specifications, standard equipment, options, and colors are subject to change without notice. Some equipment may be unavailable when your vehicle is built. Please ask your dealer for advice concerning current availability of standard and optional equipment, and your dealer will verify that your vehicle will include the equipment you ordered. Vehicles in this brochure are shown with optional equipment. See your dealer for complete details on the new-vehicle limited warranty, twelve-year limited warranty against corrosion perforation, and Audi 24/7 Roadside Assistance. [Roadside assistance coverage provided by Road America in the U.S. Certain conditions apply; see your dealer for details.] Tires supplied by various manufacturers. "Truth in Engineering" is a registered trademark of Audi of America, Inc. "Audi," "quattro," all model names, "Avant," "MMI," "Multitronic," "FrontTrak," "FSI," "TFSI," "Sideguard," "Audi Financial Services," "Singleframe," the Singleframe grille design, and the four rings logo are registered trademarks of AUDI AG. "Servotronic" is a registered trademark of the AM General Corporation. "Bose" and "AudioPilot" are registered trademarks of the Bose Corporation. "Tiptronic" is a registered trademark of Dr. Ing h.c. F. Porsche AG. "ESP" is a registered trademark of Daimler AG. "HomeLink" is a registered trademark of Prince Corporation, Holland, Michigan. "SIRIUS" is a registered trademark of SIRIUS Satellite Radio, Inc. "Bluetooth" is a registered trademark of Bluetooth SIG. "iPod" and "iPhone" are registered trademarks of Apple Computer, Inc. HD Radio" and the HD Radio logo are proprietary trademarks of iBiquity Digital Corporation.

©2010 Audi of America, Inc.