

**A3**





### Looks the part.

The Audi A3 embodies the spirit of passionate driving. Nothing says that better than the agile proportions of the Sportback design with the S line exterior. With its distinct rear diffuser, front bumper treatment, available signature LED daytime running lights and optional S line doorsills, the Audi A3 is more than legendary power, it is also progressive design. The A3 Sportback delivers a unique combination of utility, luxury and the performance that only Audi can offer.

**Luxury comfortably meshed with performance.**

From its available side-bolstered sport seats to the driver-oriented cockpit, the Audi A3 boasts an interior that has all of the performance features you would expect in an Audi. Plus, the Audi A3 features a luxurious leather-wrapped steering wheel, leather seats and striking Aluminum Medial or optional genuine wood inlays.



**Open the map and  
look for the curviest roads.**

A simple turn of the wheel confirms what the Audi A3 is all about. Outfitted with dynamic, sport-inspired suspension and available quattro® all-wheel drive, the A3 adds a new level of handling performance. Combined with a critically acclaimed powerplant, the 2.0 liter TFSI® direct injection engine, the A3 delivers 200 hp and 207 lb-ft. of torque – just the kind of power to pass nearly anything, anywhere.

**Introducing the outside, with all of the  
conveniences and luxuries of the inside.**

Slide behind the wheel, and your attention is diverted to what's overhead: The ability to open your Audi A3 to the world. The available Open Sky sunroof offers a spacious and airy feel to the interior unlike any other car.

### It's all right here.

The Audi A3 is perfectly suited for the city and equally capable everywhere else. The 200 hp 2.0 TFSI\* engine offers standout power alongside noteworthy efficiency, as the A3 gets a spirited 30 MPG\* on the highway. Plus, with 60/40 split folding rear seats offering 39 cubic feet of cargo space and an available trunk liner, versatility is always a part of the equation.

## The fun part of progressive performance.

Developing the cleanest diesel technology in the world\* is far from being good enough. A TDI® engine has to be quick, responsive and economical. The all-new A3 TDI® is more than proof, as it combines efficiency, luxury, versatility and style into one progressive package.





**The next test? You.**

Honed from the Le Mans winning diesel engine, TDI® clean diesel technology is powerful to say the least. Take the Audi A3 TDI®, for example. With its 140 hp and an astonishing 236 lb-ft. of low-end torque, the rotational force that puts a vehicle into motion, immediate power is always on tap. But it does not stop there. The Audi A3 TDI® achieved an extraordinary 50 MPG\* during the Audi Mileage Marathon, which tested TDI® clean diesel technology in a cross-country trip from New York to Los Angeles.

TDI® produces **25%** fewer CO<sub>2</sub> emissions than gasoline!  
*500*

TDI® gives **20%** more range than gasoline!  
*500*

TDI® consumes **30%** less fuel than gasoline!  
*500*

\*Audi A3 TDI; 50.6 combined city/highway MPG. Mileage achieved during a drive from Washington, D.C. to Cleveland, OH. IMSA certified. Your mileage will vary. \* See page 33 for information regarding fuel economy and EPA estimate.  
Audi A3 TDI® Premium Plus





## Driven by a passion for innovation.

Innovation is central to everything Audi stands for. TDI® clean diesel technology is no exception, as it incorporates technologies like turbo direct injection, allowing the engine to do more by maximizing air intake for enhanced performance. Plus, TDI® emissions are reduced to ultra-low levels thanks to a revolutionary emissions system. The result is a car that is clean, quiet, powerful and proven.



**1. Integrated LED turn signals in exterior mirror housings** | The turn indicator lamps are artfully incorporated into the sculpted mirror housing, complementing the modern and fluid design of the A3. LED lighting technology uses roughly 50 percent less energy than standard lights and activates more quickly.

**2. Audi concert radio with ten speakers and SIRIUS® Satellite Radio** | Audi concert radio features the Audi Sound System with 140 watts of power and ten total speakers, including two in each door, a subwoofer and a center fill speaker. It also offers a CD player with MP3 playback capability and auxiliary input. The Graduated Audio Level Adjustment [GALA] ensures optimal volume levels as cabin noise increases with speed.

**3. Dual-zone automatic climate control** | The climate is easily controlled through the center console, while a light sensor on the dashboard adjusts the system based on the sun's intensity.

**4. 17" five-Y-spoke wheels with 225/45 all-season tires** | The five-Y-spoke alloy wheels give the A3 a bold, aggressive stance with a distinctive Y-spoke design, while the all-season tires ensure a safe and comfortable ride on virtually all surfaces.

**+ SIRIUS® Satellite Radio** | SIRIUS® Satellite Radio gives drivers access to more than 120 channels of digital satellite radio. Dozens of varieties of commercial-free music, as well as talk radio, sports, news and information, are just a button away with this seamlessly integrated system.

**+ ESP®** | The Electronic Stabilization Program [ESP®] helps make the vehicle easier to control in adverse conditions or when the car is at its handling limit. Helping to reduce the danger of swerving and improving directional stability, the program identifies the car's intended direction and responds.

**+ Halogen headlights with daytime running lights** | Halogen headlights help enhance safety by illuminating a wider section of the road.

Features listed are standard on the Premium model unless otherwise noted.

+ FEATURE NOT SHOWN

5. **Four-spoke, leather-wrapped steering wheel** | The four-spoke, leather-wrapped steering wheel provides a sporty look and feel, enhancing the A3 driving experience.

6. **Leather seating surfaces** | The superior quality of leather and its impeccable craftsmanship add to the elegant, dynamic and versatile driving experience of the A3.

7. **S line bumpers and spoiler** | The visually compelling features of the S line equipment include more aggressive front and rear bumpers with dynamic air inlets, rear diffuser and rear roof spoiler. S line badges are applied to the front fender panels.

8. **Front fog lights** | The front fog lights help illuminate the road, as well as help improve your visibility to oncoming drivers in inclement weather.

+ **Cruise control** | This electronic aid stores and maintains the speed selected by the driver. Also included are coast, resume and accelerate features, which all help to reduce stress on the driver.

+ **Tire pressure monitoring system** | The tire pressure monitoring system notifies the driver when tire pressure is above or below acceptable levels. It oversees the pressure in all four tires while the car is being driven and warns the driver in the event of pressure loss with symbols in the driver information system.

+ **Space-saver spare wheel** | The space-saver spare wheel complements the compact design of the A3 and optimizes the use of space in this sporty and versatile vehicle.

+ **Folding armrest** | The full-length, front center armrest features a storage area under the padded armrest cover and two twelve-volt power outlets within the console.

Features listed are standard on the Premium model unless otherwise noted.

+ FEATURE NOT SHOWN



8



- 
- 1. **Audi xenon plus headlights with LED daytime running lights** | Audi xenon plus headlights produce a bright arc that serves as an excellent light source to illuminate the road. LED daytime running lights provide clear visibility and can be switched off manually if necessary.

---

  - 2. **Power front driver seat** | The power front seat allows the driver to adjust the seat's forward/backward position, height, lumbar support, and angle of seat cushion and seatback.

---

  - 3. **Aluminum Optic air vent surrounds** | The stylish Aluminum Optic air vent surrounds enhance the versatile interior.

---

  - 4. **Aluminum Medial inlay** | The stylish Aluminum Medial belt line trim accents the overall interior excellence of the Audi A3.

---

  - + **Bluetooth®** | The Bluetooth® hands-free phone interface allows the pairing of a Bluetooth®-enabled mobile phone with the vehicle, and includes access to the phonebook within the driver information display of the instrument panel. For specific compatibility and operation instructions, refer to [audiusa.com/bluetooth](http://audiusa.com/bluetooth) or contact your local Audi dealer for the latest listing of compatible phones.
- 

Features listed are standard on the Premium Plus model unless otherwise noted.

+ FEATURE NOT SHOWN

5. **Three-spoke, multifunction, leather-wrapped steering wheel** | The three-spoke, leather-wrapped, multifunction steering wheel provides easy access to audio volume control, Bluetooth® operation, and radio and CD track selection. Shift paddles come standard on S tronic® vehicles and allow for quick and sporty gear changes.

6. **17" ten-spoke wheels with 225/45 all-season tires** | The ten-spoke wheels complement the sculpted shape of the A3 with classic style while the all-season tires help ensure a safe and comfortable ride on virtually all surfaces.

7. **Illumination Package** | The interior Illumination Package features permanent vertical ambient illumination of controls and the center console for readability and orientation in these areas.

+ **Storage Package** | The comprehensive storage system provides ample and convenient spaces for a wide variety of storage needs, including side pockets, seatback storage nets and bag hangers.



Features listed are standard on the Premium Plus model unless otherwise noted.

+ FEATURE NOT SHOWN

## A3 Packages



## A3 Sport Package

A3 Premium Plus only

- 1. **Sport seats** | The sport seats offer greater lateral support thanks to more prominent side bolsters.
- 2. **18" five-tri-spoke wheels with 225/40 summer performance tires\*** | The 18" five-tri-spoke wheel option is aggressive in its stance and bold in its design. The wheels come equipped with summer performance tires, which help to improve handling and driving dynamics.
- 3. **Sport suspension** | For those who plan to drive in a more assertive fashion, the Sport Package includes a specially configured firmer suspension with more responsive spring and damper tuning.

## A3 Titanium Sport Package

A3 Premium Plus only

- 3. **18" seven-twin-spoke wheels with 225/40 summer performance tires\*** | With its Dark Titanium finish, this aggressive, sport-inspired wheel option complements the exterior of the A3 from top to bottom. The wheels are equipped with summer performance tires, which help to improve handling and driving dynamics.
- 4. **Sport suspension** | For those who plan to drive in a more assertive fashion, the Sport Package includes a specially configured firmer suspension with more responsive spring and damper tuning.
- 5. **Piano Black interior inlay** | The sleek elegance of the Piano Black interior inlay extending across the center console and doors underlines the quality and craftsmanship of the A3 interior.
- 6. **Black grille and exterior trim** | The Black front grille adds a unique touch to the exterior of the A3 and is a beautiful complement to the dynamic lines of this sporty vehicle.
- 7. **Black headliner** | The unique Black headliner enhances the interior of the A3, adding to the comfortable and sporty driving experience.
- 8. **Leather/Alcantara® sport seats** | The superior quality of leather and impeccable craftsmanship of the seat design are complemented by Silver contrast stitching and race-bred Alcantara® inserts, which are developed to provide a high level of grip for drivers and passengers.

\* See page 25 for important safety information regarding summer performance tires.

+ FEATURE NOT SHOWN

### A3 Audi Navigation plus with Audi Music Interface Package

A3 Premium Plus only

4. **Audi Navigation plus** | The DVD-based Audi Navigation plus features a full-color, 6.25" LCD screen, MMI<sup>®</sup>-inspired control logic for AM/FM radio functions, as well as an auxiliary input jack and two SD<sup>®</sup> card slots for MP3 playback.

+ **Audi music interface with iPod<sup>®</sup> integration** | The Audi music interface offers intelligent integration with the iPod<sup>®</sup>. Any iPod<sup>®</sup> Generation 4 and higher [iPod<sup>®</sup>, iPod<sup>®</sup> nano, iPod<sup>®</sup> photo] may be connected through the glove box.

### A3 Audi Navigation plus with Six-CD Package

A3 Premium Plus only

4. **Audi Navigation plus and glove box six-CD changer** | The DVD-based Audi Navigation plus features a full-color, 6.25" LCD screen, MMI<sup>®</sup>-inspired control logic for AM/FM radio functions, a six-CD changer in the glove box, two SD<sup>®</sup> card slots for MP3 playback and an auxiliary input jack.

### A3 Convenience Package

A3 Premium Plus only

5. **Auto-dimming interior mirror with compass** | The rearview mirror with compass recognizes distracting bright light behind the car and darkens the mirror glass automatically.

6. **BOSE<sup>®</sup> premium sound system** | The ten-speaker, 195 watt sound system is individually tailored to the A3 interior. It is further enhanced by the AudioPilot<sup>®</sup> noise compensation feature.

+ **Rain/light sensor** | An embedded sensor detects the level of light and automatically turns on the headlights if needed. The rain sensor offers the same convenience in wet conditions by automatically adjusting the rate of the wiper sweep to the amount of rain.

### A3 Cold Weather Package

7. **Heated exterior mirrors** | The heated exterior side view mirrors give the driver extra convenience by reducing fog and ice.

+ **Heated front seats** | The multilevel seat heating system is designed to heat the entire surface of the seat and can be initiated with a convenient six-step dial.

+ **Heated windshield washer nozzles** | The heated windshield washer nozzles provide the A3 with enhanced convenience.

+ FEATURE NOT SHOWN

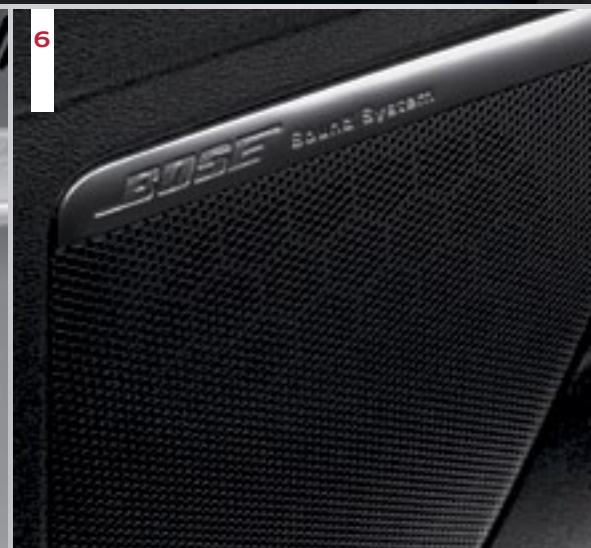

4

5

6

7

## A3 Options



## A3 Options

- 1. Open Sky sunroof** | The easy-to-operate glass sunroof provides the driver and passengers of the A3 with natural light and a continuous flow of fresh air within the cabin. The Open Sky system includes a large two-piece sunroof for a refreshingly airy driving experience.
  - 2. Dark Brown Walnut wood inlay** | The genuine Dark Brown Walnut wood inlay adds a refined touch of luxury to the A3.
  - 3. Aluminum roof rails** | The elegant and sporty aluminum roof rails on the A3 complement the progressive design of the vehicle. Because the aluminum roof rails are aerodynamically shaped, they generate minimal wind noise, and expand upon the variety of ways the A3 can be used.
- + **Rear side airbags\*** | The A3 offers rear side airbags, which can help reduce the risk of severe injuries in certain collisions.

\* Airbags are supplemental restraints only and will not deploy under all crash circumstances. Always use safety belts and seat children in the rear, using restraint systems appropriate for their size and age.

+ FEATURE NOT SHOWN



4. **Audi 18" Calera wheels** | These alloy wheels grab attention with their distinctive dual-spoke design. All of our alloy wheels are specially engineered to meet the strict tolerances of our Audi original equipment wheels.

5. **Audi 18" 15-spoke wheels** | These wheels make a strong statement with an eye-catching two-piece design. All of our alloy wheels are specially engineered to meet the strict tolerances of our Audi original equipment wheels.

6. **Compact roof box** | Our new compact roof box offers a larger, 16.95 cubic foot capacity. The perfect size and design for your A3. Size: 81" long, 30" wide. [Must be used in combination with the base carrier bars, which are sold separately]

7. **Upright Barracuda® bicycle holder** | This bike holder fits 20-80 mm bike frames and is easy to use. It features a molded front wheel well that allows the bike to stand on its own as you easily secure the bike. Lock included. [Must be used in combination with the base carrier bars, which are sold separately; two bike holders shown]

8. **Premium rubber floor mats** | These all-weather floor mats feature a deep ribbed channel design to help protect the floor and carpeting from water, mud, sand and snow. Rubber mats come with contrasting logo. Set of four floor mats.

+ **Splash guards** | Help protect your exterior finish with custom-fit front and rear splash guards. Made of long-life, crack-resistant rubber. Available in sets of two for front or rear.

+ **Storage cover** | Protect your Audi from the elements with a lightweight, easy-to-use cover. Stormshield® material is custom designed for your Audi A3. Covers have a plastic window so the rear license plate is visible. Includes a storage bag.

+ **Carpeted cargo mat** | This heavy-duty, moisture-resistant rubber mat is covered by a nylon carpet to help provide excellent trunk protection. Movable plastic blocks attach with hook and loop to the carpet to help organize and manage the movement of items in the trunk.

+ **Polished stainless steel exhaust tips** | Enhance the look of your A3 with these tailpipe embellishments. Tips feature rolled and angled cuts.

See your local Audi dealer for the complete selection of Genuine Audi Accessories.

+ FEATURE NOT SHOWN



1



1. **17" five-Y-spoke wheels with 225/45 all-season tires** | The five-Y-spoke wheels give the A3 a bold, aggressive stance with a distinctive Y-spoke design while the all-season tires help ensure a safe and comfortable ride on virtually all surfaces. [A3 Premium]

2



2. **17" ten-spoke wheels with 225/45 all-season tires** | The ten-spoke wheels complement the sculpted shape of the A3 with classic style while the all-season tires help ensure a safe and comfortable ride on virtually all surfaces. [A3 Premium Plus]

**3. 18" five-tri-spoke wheels with 225/40 summer performance tires\*** | The 18" five-tri-spoke wheel option is aggressive in its stance and bold in design. The wheels come equipped with summer performance tires, which help to improve handling and driving dynamics. [Sport Package only]

**4. 18" seven-twin-spoke wheels with 225/40 summer performance tires\*** | With its Dark Titanium finish, this aggressive, sport-inspired wheel option complements the exterior of the A3 from top to bottom. The wheels are equipped with summer performance tires, which help to improve handling and driving dynamics. [Titanium Sport Package, Premium Plus only]

3



4



\* Summer performance tires are designed for optimum performance and handling in warm climates. They are not suitable for cold, snowy or icy weather conditions. If you drive under those circumstances, you should equip your vehicle with all-season or winter tires, which offer better traction under those conditions. We suggest you use the recommended winter or all-season tires specified for your car or their equivalent. These summer performance tires also have a lower aspect ratio that aids performance and handling; however, in order to avoid tire, rim or vehicle damage, it is important that the inflation pressure is regularly checked and maintained at recommended levels. Serious wheel and tire damage may occur if the vehicle is operated on rough or damaged road surfaces, or upon encountering road debris or obstacles. Please also remember in making your selection that, while these tires deliver responsive handling, they may ride less comfortably and make more noise than other choices. Finally, these tires may wear more quickly than other choices. For more information on all of these topics, please consult the owner's manual, your local dealer or call 1-800-FOR-AUDI.

BLACK LEATHER | FLEX METALLIC INLAY

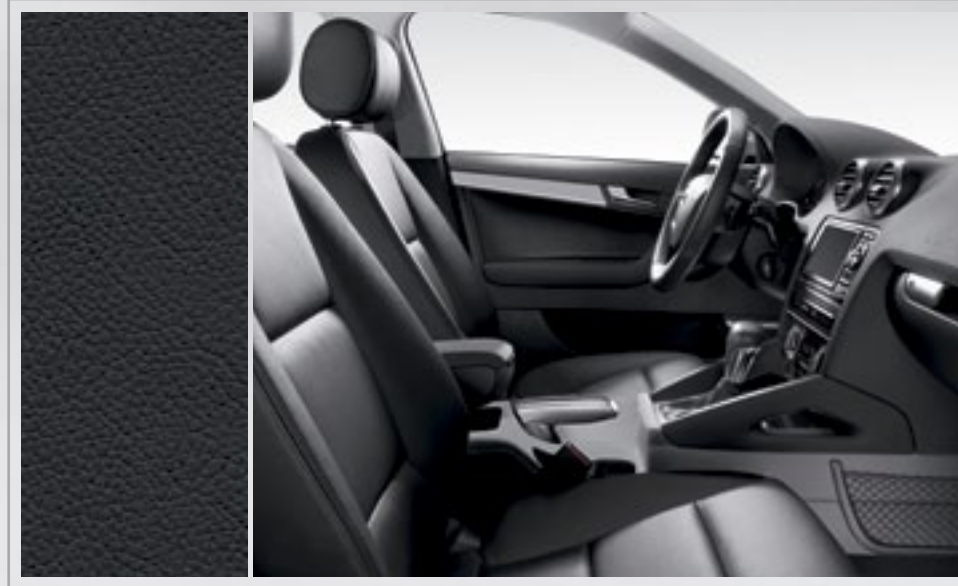

LIGHT GRAY LEATHER | DARK BROWN WALNUT WOOD INLAY\*



DECORATIVE INLAY OPTIONS

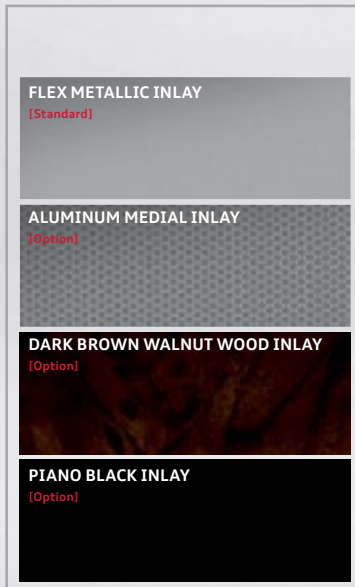

LUXOR BEIGE LEATHER | ALUMINUM MEDIAL INLAY\*



BLACK LEATHER/PERFORATED ALCANTARA\* | PIANO BLACK INLAY\* [Titanium Sport Package]



\* Optional inlay shown



Audi A3 Make Yours.



- 1 | Black\*
- 2 | Luxor Beige
- 3 | Light Gray

\* Available in standard leather or leather/perforated Alcantara\* with Titanium Sport Package  
\* Additional charge



A3 Brilliant Black

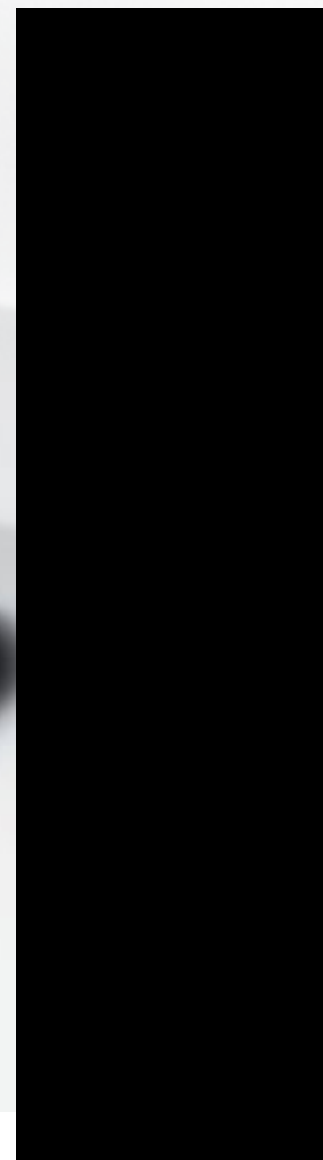
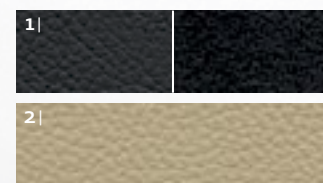

A3 Aruba Blue PEARLEFFECT\*

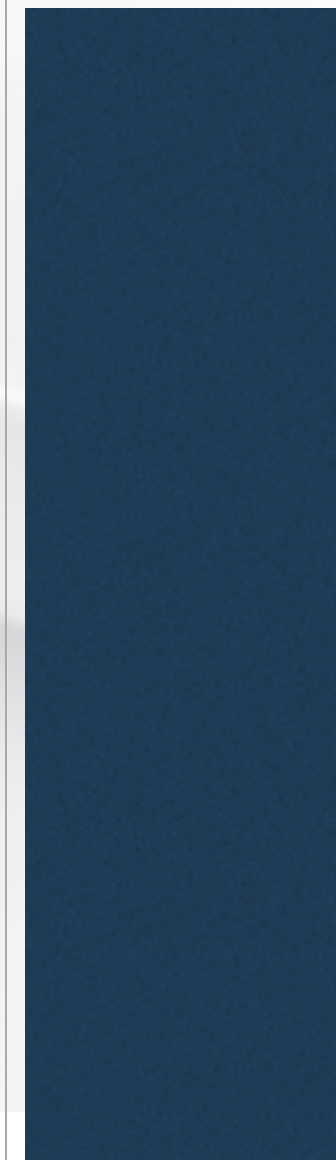

A3 Meteor Gray PEARLEFFECT\*

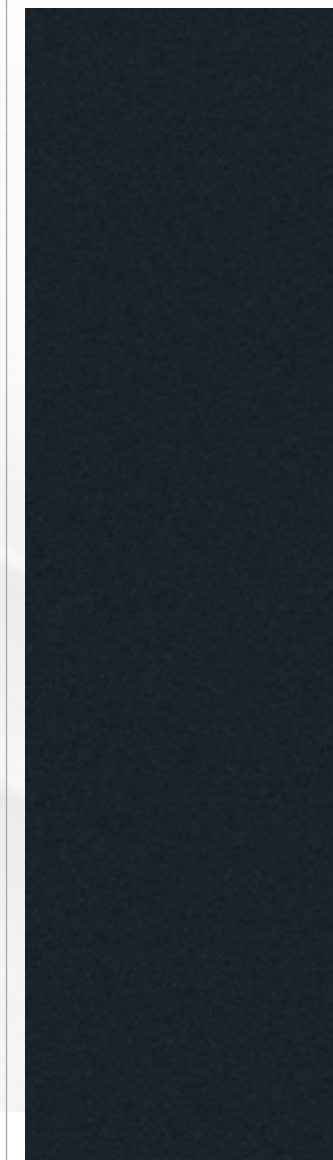

A3 Ice Silver METALLIC\*

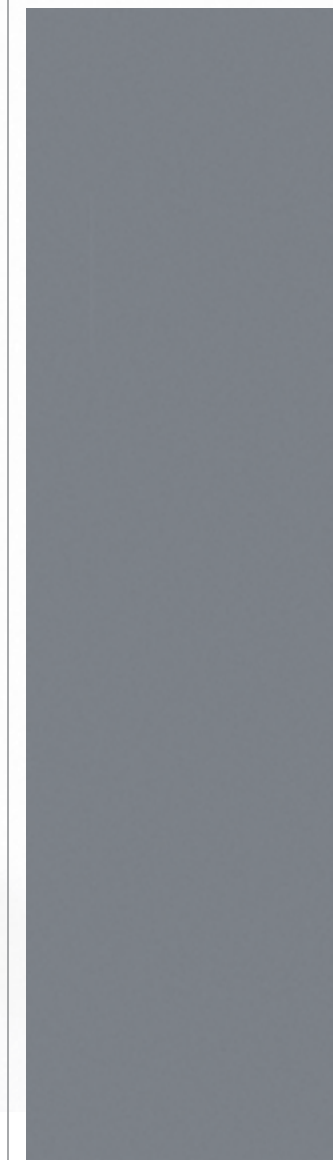

A3 Lava Gray PEARLEFFECT\*

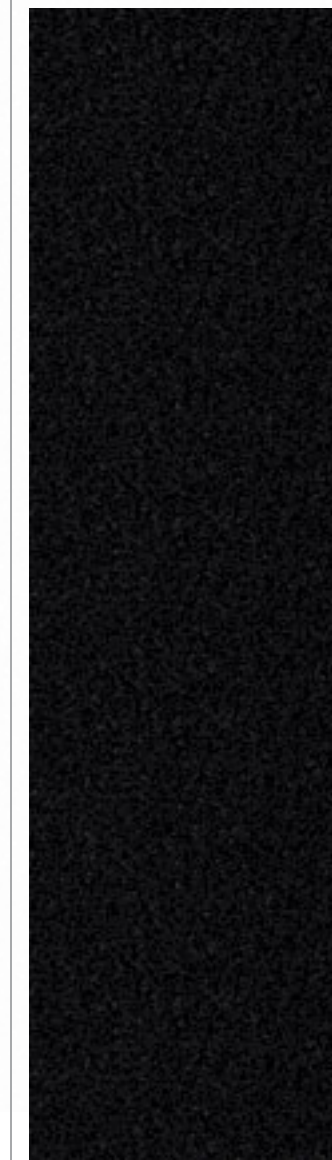

A3 Brilliant Red

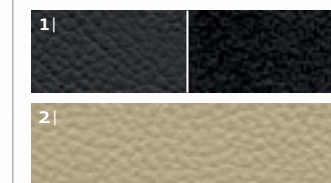

A3 Ibis White

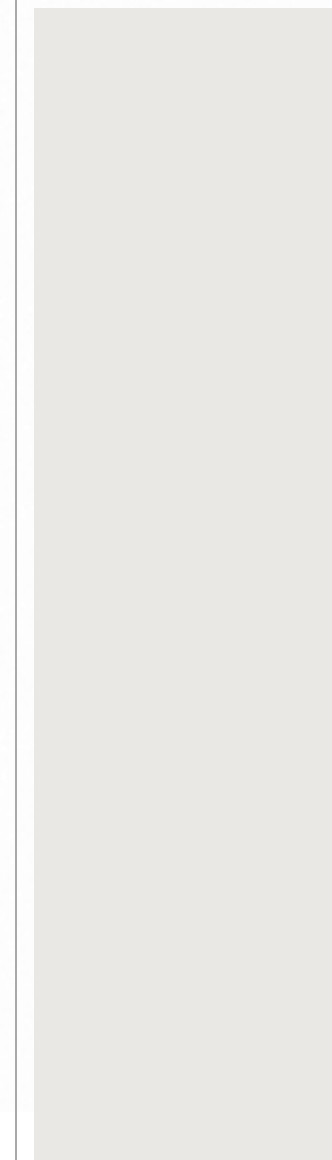
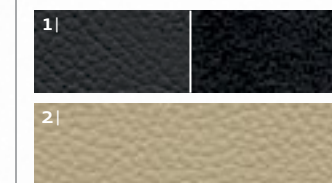

A3 Monza Silver METALLIC\*

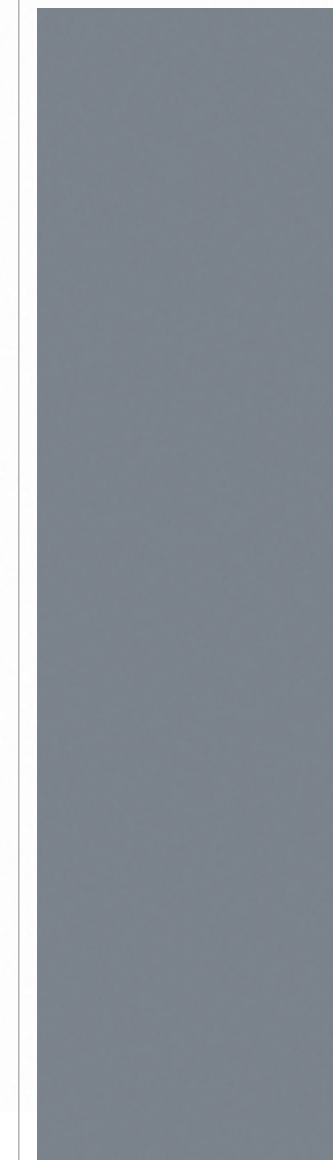
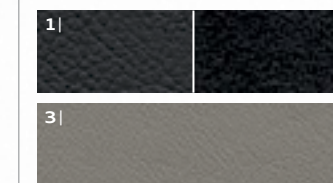

## A3 2010 Specifications

Chassis/Technical	A3
MacPherson front suspension with direct anti-roll bar mountings, individually installed springs and shock absorber pivots, and five-piece aluminum subframe	s
Four-link rear suspension with individual springs/shock absorbers and a tubular anti-roll bar	s
Servotronic* speed-sensitive power steering – varies assistance based on vehicle speed	s
quattro® permanent all-wheel drive system utilizing Haldex center differential [Not available on A3 TDI*]	o
Six-speed manual transmission	s
S tronic® dual-clutch automatic transmission	o
Fully galvanized steel unibody with multistep anti-corrosion protection	s

Safety & Security	A3
Driver and front passenger advanced dual-stage airbag <sup>†</sup> supplemental restraints	s
Driver and front passenger seat-mounted side thorax airbag <sup>†</sup> supplemental restraints	s
Second row side airbag <sup>†</sup> supplemental restraint system	o
Sideguard <sup>†</sup> head curtain airbags <sup>†</sup> for both rows of seats	s
Front passenger occupant detection for airbag <sup>†</sup> supplemental restraints	s
Front three-point safety belts with automatic pretensioning and force limiters; height adjustable for front seating positions	s
Rear three-point safety belts with belt force limiters for outboard passenger seating positions	s
Safety belt reminder for driver and front passenger	s
Lower Anchors and Tethers for Children [LATCH] in rear seats	s
Pinch protection for passenger compartment windows	s
Central locking system with selective unlock feature	s
Impact protection – including reinforced high-strength steel/aluminum crossmembers, reinforced bumpers and rigid occupant cell	s
Tire pressure monitoring system	s
Electronic Stabilization Program [ESP] <sup>†</sup>	s
Anti-lock Brake System [ABS] with Electronic Brake-pressure Distribution [EBD]	s
Brake assist – a system that automatically senses emergency braking and applies maximum power boost to reduce overall stopping distance	s
Audi hill hold assist	s
Anti-theft vehicle alarm system with blinking theft-deterrent light	s

o	Option	s	Standard

The table above represents the standard equipment on the Premium model. Many popular options are combined and available on the Premium Plus model. Please see the package contents in this brochure for complete details.

\* Airbags are supplemental restraints only and will not deploy under all crash circumstances. Always use safety belts and seat children in the rear, using restraint systems appropriate for their size and age.

<sup>†</sup> Summer performance tires are designed for optimum performance and handling in warm climates. They are not suitable for cold, snowy or icy weather conditions. If you drive under those circumstances, you should equip your vehicle with all-season or winter tires, which offer better traction under those conditions. We suggest you use the recommended winter or all-season tires specified for your car or their equivalent. These summer performance tires also have a lower aspect ratio that aids performance and handling; however, in order to avoid tire, rim or vehicle damage, it is important that the inflation pressure is regularly checked and maintained at recommended levels. Serious wheel and tire damage may occur if the vehicle is operated on rough or damaged road surfaces, or upon encountering road debris or obstacles. Please also remember in making your selection that, while these tires deliver responsive handling, they may ride less comfortably and make more noise than other choices. Finally, these tires may wear more quickly than other choices. For more information on all of these topics, please consult the owner's manual, your local dealer or call 1-800-FOR-AUDI.

<sup>†</sup> Your Audi vehicle is equipped with a phone preparation utilizing Bluetooth<sup>™</sup> interface to enable hands-free functionality [compatible mobile phones sold separately]. You will need a Bluetooth<sup>™</sup>-enabled mobile phone in order to utilize this function. Not all Bluetooth<sup>™</sup>-enabled mobile phone models are compatible with Audi phone preparation. Visit [audiusa.com/bluetooth](http://audiusa.com/bluetooth), or contact your local Audi dealer for the latest listing of compatible phones. Audi recommends use of the Audi phone cradle [sold separately] with your mobile phone while operating this vehicle.

<sup>†</sup> Audi Navigation plus system depends on signals from the worldwide Global Positioning Satellite network. The vehicle's electrical system, and existing wireless and satellite technologies, must be available and operating properly for the system to function. The system is designed to provide you with suggested routes in locating addresses, destination and other points of interest. Changes in street names, construction zones, traffic flow, points of interest and other road system changes are beyond the control of Audi of America, Inc. Complete detailed mapping of lanes, roads, streets, toll roads, highways, etc., is not possible, therefore you may encounter discrepancies between the mapping and your actual location. Please rely on your individual judgment in determining whether or not to follow a suggested Audi Navigation plus route. Periodically, the mapping is updated, and a new DVD will be required in order to maintain the latest navigation information available to us. These will be available for purchase from time to time at an additional cost. Consult your dealer or call 1-800-FOR-AUDI for details.

Features	A3
Singleframe® grille with choice of license plate holder or filler panel with two chrome strips	s
17" five-Y-spoke wheels with 225/45 all-season tires	s
17" ten-spoke wheels with 225/45 all-season tires	o
18" five-tri-spoke wheels with 225/40 summer performance tires <sup>†</sup>	o
18" seven-twin-spoke wheels with 225/40 summer performance tires <sup>†</sup>	o
Aluminum roof rails	o
LED turn signals in mirror housings	s
Power adjustable side mirrors	s
Open Sky panorama sunroof with retractable sunshade and pinch protection	o
Halogen headlights with integrated high and low beams	s
Audi xenon plus headlights with automatic self-leveling and integrated LED daytime running lights	o
Two front fog lights located in lower front bumper	s
Three blink, touch-to-pass lane change feature in turn signal	s
Four-spoke, leather-wrapped steering wheel	s
Three-spoke, sport, multifunction, leather-wrapped steering wheel with shift paddles and controls for audio volume, Bluetooth <sup>™</sup> phone and audio seek function	o
Tilt and telescopic manually adjustable steering column	s
Interior lights in overhead console with front map lights	s
Red ambient LED lighting in headliner for front center console illumination	o
Illumination for interior door handles, air vent controls and front footwells	o
Front and rear floor mats	s
Flexmetallic decorative inlays	s
Aluminum Medial decorative inlays	o
Genuine wood decorative inlays [Dark Brown Walnut]	o
Aluminum doorsill inlays	s
Folding front center armrest	s
Storage nets in back of front seats	o
Power central locking system with radio-operated key fob, remote control for doors, deck lid and fuel door	s
Automatic climate control	s
Power windows with one-touch up/down operation and pinch-protection	s
Electronic cruise control	s
Electric rear window defogger with automatic timed shutoff feature	s
Interior tailgate release on driver's door	s
Dual front sun visors with vanity mirror for driver and front passenger	s
Lighted vanity mirrors for driver and front passenger	o
Four assist handles in headliner above each door with slow retraction feature	s
Two folding ignition keys with remote control, valet key, and emergency key	s
Removable cargo floor for access to spare tire	s
Leather seating surfaces	s

Features	A3
Six-way manual driver seat	s
Eight-way power driver seat with four-way power lumbar adjustment	o
Six-way manual front passenger seat	s
Split folding 60/40 rear seatback	s
Rear seat armrest with dual cup holders	s
Two front cup holders	s
Space-saver spare wheel/tire	s
Tool kit in storage compartment in trunk	s
Glove box in front passenger's side of dash panel	s
Twelve-volt accessory power outlet in front center console	s
Audi concert system with single CD player with MP3 playback capability, AM/FM radio, auxiliary input jack and speed-dependent volume control	s
SIRIUS <sup>™</sup> Satellite Radio with three-month trial subscription	s
Audi Sound System, 140 watts with ten speakers, subwoofer and center fill speaker	s
Bluetooth <sup>™</sup> preparation for mobile phone	o
Backlit instrument cluster with brightness control	s
Digital trip odometer with service interval indicator	s
Driver information system – trip computer, outside temperature, radio/telephone/navigation display, auto check, open door/hatch indicator	s
Windshield wipers with four-position lever	s
Rear window wiper and defroster with washer system	s
Metallic or pearl effect exterior paint	o

Packages	A3
Cold Weather Package: Six-step heated front seats, electronically adjustable, heated outside mirrors, heated windshield washer nozzles	o
Convenience Package: Auto-dimming interior mirror with digital compass, automatic headlights, rain-sensing windshield wipers, BOSE <sup>™</sup> premium sound system with ten speakers, six-channel amplifier and AudioPilot <sup>™</sup> noise compensation	o
Audi Navigation plus <sup>†</sup> with Audi music interface in glove box: DVD-based navigation, AM/FM radio, auxiliary input jack, two SD <sup>™</sup> card slots for MP3 files, SIRIUS <sup>™</sup> Satellite Radio, color LCD display screen [6.5" diagonal], iPod <sup>™</sup> integration, including one cable for iPod <sup>™</sup> connection; includes RDS traffic data	o
Audi Navigation plus <sup>†</sup> with six-CD changer in glove box: DVD-based navigation, AM/FM radio, two SD <sup>™</sup> card slots for MP3 files, auxiliary input jack, SIRIUS <sup>™</sup> Satellite Radio, color LCD display screen [6.5" diagonal]; includes RDS traffic data	o
Sport Package: 18" five-tri-spoke wheels with 225/40 summer performance tires <sup>†</sup> , sport front seats, sport suspension calibration	o
Titanium Sport Package: 18" seven-double-spoke wheels with 225/40 summer performance tires <sup>†</sup> , sport front seats with leather/Alcantara <sup>™</sup> upholstery, sport suspension calibration, Black front grille surround, Piano Black decorative inlays, Black headliner	o



### A3 Model Configurations

- 2.0 TFSI® six-speed manual transmission and front-wheel drive
- 2.0 TFSI® six-speed S tronic® automatic transmission and front-wheel drive
- 2.0 TFSI® six-speed S tronic® automatic transmission and quattro® all-wheel drive

### Power and Performance

- + 2.0 liter turbocharged, DOHC in-line four-cylinder engine with FSI® direct injection, intercooler and four valves per cylinder
- + Displacement: 2 liters [121.1 cu. in.]
- + Bore: 3.25 in. Stroke: 3.65 in. Compression ratio: 9.6:1
- + Horsepower: 200 hp @ 5100-6000 rpm Torque: 207 lb-ft. @ 1800-5000 rpm
- + 0-60 MPH in seconds – Manual: 7.1, S tronic®: 6.9, S tronic® quattro®: 6.7
- + Top track speed\*: 130 MPH
- + Fuel economy estimates, city/highway†: Manual: 21/30 MPG, S tronic®: 22/28 MPG, S tronic® quattro®: 21/28 MPG
- + Cargo capacity: 19.5 cu. ft. with rear seats upright; 39 cu. ft. with rear seats folded

### A3 TDI® Model Configurations

- 2.0 TDI® clean diesel six-speed S tronic® automatic transmission and front-wheel drive

### Power and Performance

- + 2.0 liter turbocharged, DOHC in-line four-cylinder engine with TDI® clean diesel common rail direct injection, intercooler and four valves per cylinder
- + Displacement: 2 liters [120.1 cu. in.]
- + Bore: 3.19 in. Stroke: 3.76 in. Compression ratio: 16.5:1
- + Horsepower: 140 hp @ 4200 rpm Torque: 236 lb-ft. @ 1750-2500 rpm
- + 0-60 MPH in seconds: 8.9
- + Top track speed\*: 130 MPH
- + Fuel economy estimates†: N/A
- + Cargo capacity: 19.5 cu. ft. with rear seats upright; 39 cu. ft. with rear seats folded

### A3

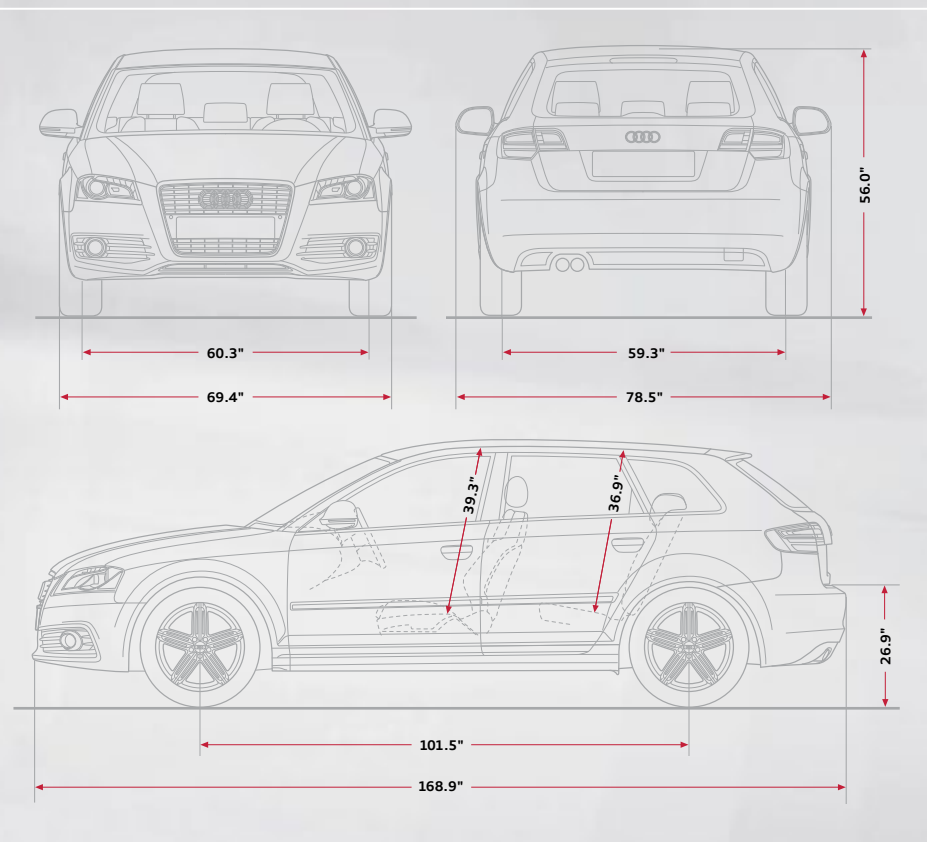

### A3 TDI®

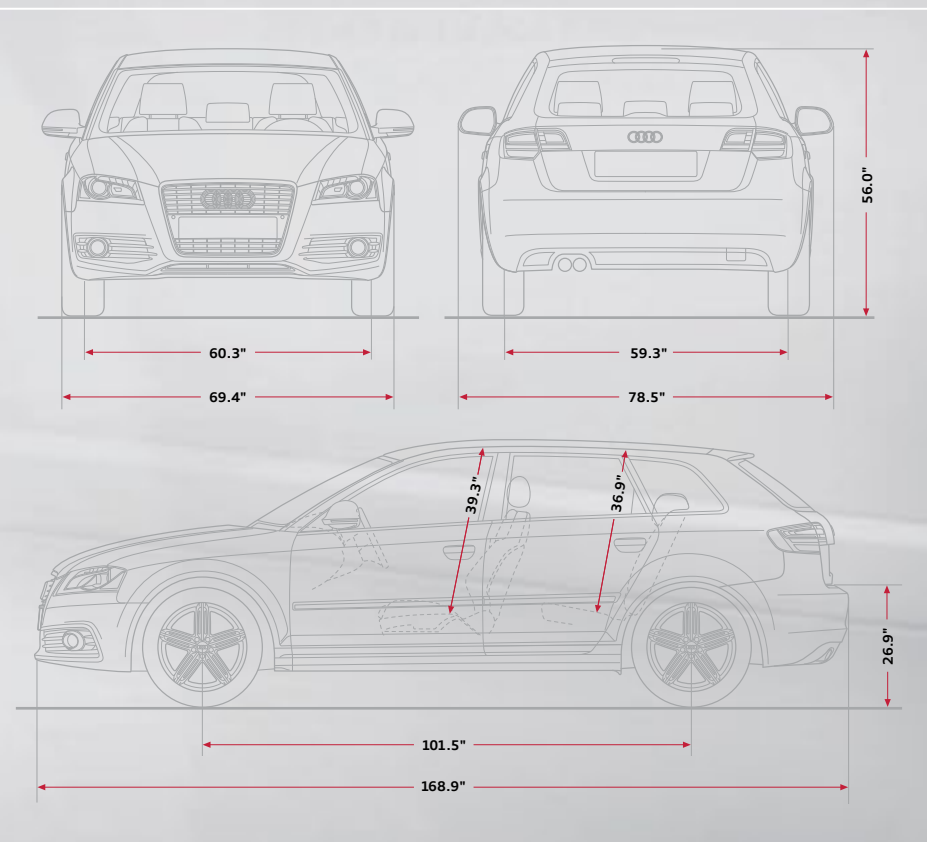

\* Top track speed electronically limited to 130 MPH in the U.S. Obey all local speed and traffic laws. † EPA estimate; your mileage will vary. ‡ EPA estimate not available at the time of printing.

**With so much to offer, there is only one place  
where you can experience it all.**

To fully interact with Audi, visit us online at any number of our special sites. From configuring your next Audi, to learning about the latest technology, to experiencing our passion for performance and racing, we invite you to explore the rich, stimulating world that is uniquely Audi.



[audiusa.com/a3](http://audiusa.com/a3)



**Model Specific Info Summary**

Dive into detailed information on the model you are considering. Each model in the Audi lineup has dedicated pages providing information on technical specifications, design, performance, safety and technology features, as well as extensive multimedia galleries.

[audiusa.com/models](http://audiusa.com/models)



**See All Models**

Select from a remarkable array of engines, exterior colors, interior materials and progressive options to assemble your own unique Audi. You can print, request a quote or take your document to the nearest Audi dealer.

[audiusa.com/technology](http://audiusa.com/technology)



**Technology Microsite**

From the very beginning, advanced technology has been at the very heart of the Audi DNA. Contained in one convenient location, you will find great detail and demonstrations of many of our technologies.

[audidrivingsite.com](http://audidrivingsite.com)



**Audi Driving Experience**

The Audi driving experience and the Audi sportscar experience are designed to not only offer you a very special track experience in an Audi, but one that will leave you with a genuine appreciation for the technology that goes into every Audi vehicle.

[audiusa.com/experience](http://audiusa.com/experience)



**Audi Experience**

The experience section is your starting place for everything Audi. From an in-depth brand experience to a journey of our rich motorsports heritage or exclusive downloads, the online Audi Experience accommodates it all.

[audi-collection.com](http://audi-collection.com)



**Audi Collection**

Beautifully made. Beautifully designed. Faultlessly functional. All the qualities that distinguish our cars can also be found in our Audi collection. From performance wheels to products designed specifically with you and your particular Audi in mind to enhance the pleasure of driving and owning an Audi.



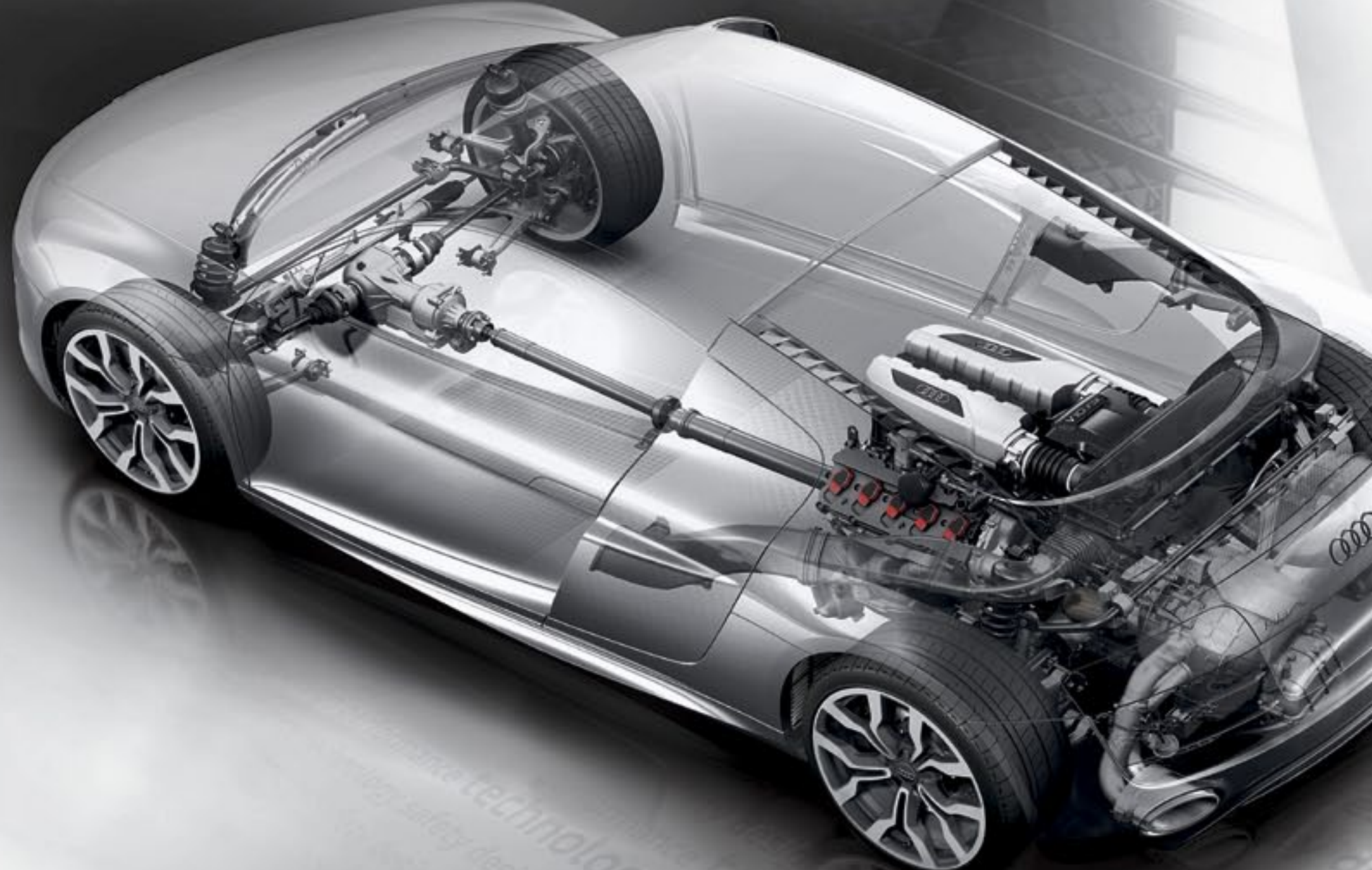

**Four driven wheels are a part  
of what drives our progress.**

Nearly 30 years ago, the notion of a car with permanent four-wheel drive was revolutionary. Audi called it quattro® and its benefits, we discovered, would set a new benchmark for driver confidence and performance. The simple, yet profound result of sending power to all wheels means that snow-covered mountain passes, rain-slicked highways and gravel-strewn rural roads are no longer encountered with apprehension. While on smooth dry roads, quattro® offers a level of performance unachievable by two-wheel drive cars.

The advantage of all-wheel drive was most apparent when Audi introduced quattro® to the World Rally Championship. quattro® seemed to defy physics with startling acceleration and remarkable traction. The result was an astounding 24 wins and a number of World Championships. If that wasn't enough of an endorsement for quattro®, it was later deemed an "unfair advantage" and banned from road racing altogether after repeatedly dominating the field.

Today, in that same competitive spirit, quattro® all-wheel drive continues to be refined. In Audi vehicles with a transverse engine configuration quattro® is a hydraulic system with an electronically controlled multi-plate clutch. Utilizing an advanced control module that monitors road speed, cornering and traction, quattro® can anticipate wheel slip and quickly respond to any driving situation. quattro® can dynamically send power to the wheels with the most grip, providing sportscar-like performance and handling with uncompromised all-wheel drive traction.

The power of quattro® is its ability to inspire driver confidence,  
giving you traction when you need it, where you need it, regardless of road conditions.



## Together the future is ours.

August Horch founded this company on one word: **Progress**. Back in 1909.

To us, it is taking what seems undoable and then doing it. It is discovering what no one else has bothered to discover. It is turning skeptics into believers, and it is taking the thinking that wins on the racetrack and putting it on the road. Relentlessly designing, innovating, engineering and racing for the past 100 years have yielded amazing progress in our quest for the Truth. And although the Truth is absolute, it's in a constant state of motion always revealing new limits and opportunities. For instance, what seemed improbable has become the standard as we have created a diesel engine so quiet, so clean, so efficient and so powerful we put it to the ultimate test competing in the 24 Hours of Le Mans... winning three years in a row. But aside from walking away with trophies, we walked away with a deeper understanding of what to engineer into our cars for the street. The remarkable capabilities of TDI® clean diesel power, the all-wheel drive confidence of quattro®, and the increased power and efficiency of FSI® are but a few of those strands of DNA that have brought us that much closer to the Truth.

And it is that quest for the Truth that is behind every pencil line we draw, every calculation we make and every idea we deem not good enough. And although they may prove to be remarkable achievements in their own right, they represent a greater commitment to what is most important: **Truth in Engineering**.

**Note:** A word about this brochure. Audi of America, Inc. believes the specifications in this brochure to be correct at the time of printing. However, specifications, standard equipment, options and colors are subject to change without notice. Some equipment may be unavailable when your vehicle is built. Please ask your dealer for advice concerning current availability of standard and optional equipment and your dealer will verify that your vehicle will include the equipment you ordered. Vehicles in this brochure are shown with optional equipment. See your dealer for complete details on the new-vehicle limited warranty, twelve-year limited warranty against corrosion perforation and Audi 24/7 Roadside Assistance. [Roadside assistance coverage provided by Road America in the U.S. Certain conditions apply, see your dealer for details.] Tires supplied by various manufacturers. "Truth in Engineering" is a trademark of Audi of America, Inc. "Audi," "quattro," "A3," "MMI," "FSI," "S tronic" and the four rings logo are registered trademarks of AUDI AG. "ESP" is a registered trademark of Daimler AG. "Servotronic" is a registered trademark of the AM General Corporation. "SIRIUS" is a registered trademark of SIRIUS Satellite Radio, Inc. "Bluetooth" is a registered trademark of Bluetooth SIG, Inc. "BOSE" and "AudioPilot" are registered trademarks of the BOSE Corporation. "iPod" is a registered trademark of Apple, Inc. "SD" is a registered trademark of SD-3C, LLC. "Alcantara" is a registered trademark of Alcantara S.P.A. "Barracuda" is a registered trademark of Mont Blanc. "Stormshield" is a registered trademark of Guilford Mills Inc. MPG based on Audi Mileage Marathon results; 44 MPG combined for Audi A3 TDI\*. IMSA certified. Your mileage will vary. Fuel tank capacity of the Audi A3 TDI\* is 14.5 gallons. Range is calculated by taking the achieved fuel economy and multiplying by tank capacity.

©2009 Audi of America, Inc.