



# A4 S4

Audi A4 | A4 Avant  
Audi S4

Audi  
Truth in Engineering







## Where one journey ends, a shared one begins.

We built it, now tell us where we should go. Where you take us is really up to you, but we wanted to talk about the inspiration we had engineering the Audi A4 and S4. Our journey started by raising the bar on progressive German engineering, meticulous craftsmanship and an even more intimate interior, so that both car and driver enjoy the next stage of their shared journey. Our inspiration becomes a shared experience as you go on your way, in total control and comfort, on any road you might choose.

**Design that just might break  
the first law of thermodynamics.**



The law says energy can't be created or destroyed, it can only change forms. Well, what if we provided a singular, comprehensive form that created a new kind of energy, one from inside you? Featuring stylish lines and arresting exterior design, along with genuine, invigorating materials and brilliantly conceived interior layout, the A4 blends a German look with a kinetic feel. At rest, it is an object of art. In motion, it enhances the robust performance, making the Audi A4 the ideal companion for practically any road trip. And proof that, in fact, energy can be created.

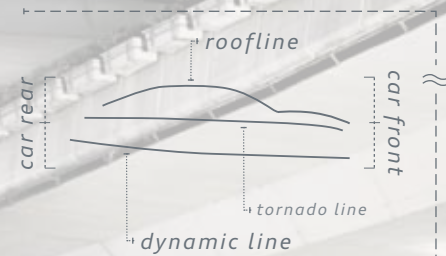

~ fig. 01

#### .01 - Character Lines

Design that delivers both charm and energy is a design of character. From its driver-centric cabin to the signature flow of its roofline, the A4 is unmistakably characterized by pure, passionate style.





## The thrust of the matter when it comes to performance.

It's not just about power, it's about how power feels—that's really the crux of performance. The Audi A4 presents drivers with the classic combination of speed<sup>1</sup> and efficiency.<sup>2</sup> And it flexes finely tuned muscles at your command, while weight-saving features turn its 2.0T four-cylinder engine into a six-cylinder power profile. When you feel the impressive torque, the 258 lb-ft force that comes when you hit the throttle, that's when you know the simple difference between numbers and what actually moves you.



~ fig. 02

.02 - LED Daytime Running Light Technology

Ultra-stylish, they are supposed to catch the eye for aesthetic as well as visibility reasons. They are available LED daytime running lights that are designed to be noticed.





A close-up, black and white photograph of the Audi A4 interior dashboard. The focus is on the center console area, showing the MMI Navigation Plus system. A vertical red line is positioned to the left of the text. The dashboard features a silver trim piece with the 'Audi' logo and 'Audi MMI Navigation Plus' text. Below this, there's a silver trim piece with 'Audi' and 'Audi MMI Navigation Plus' text. The background shows the steering wheel, instrument cluster, and passenger side door panel.

.03 - Audi MMI® Navigation Plus

Fully understand your journey with available Audi MMI Navigation plus, featuring voice control and SiriusXM Traffic.

## Sanctuary never felt so mobile.

The interior of the A4 feels like home because we designed it that way. Comforts like simple, intuitive controls that help you stay on top of your needs, while the wraparound curve of the instrument panel seems to put you in the middle of it all, integrating seamlessly into the overall layout. We've even placed the instruments and gauges closer to windshield level, to help keep your eyes on the road, connecting you to your drive, even if it feels like you're being pampered.

# This is what we mean when we say luxury has progressed.

It's not enough to simply give luxurious appointments to a cabin. They have to be thought through, designed for a comprehensive luxury experience. Something you see as much as feel. Fortunately, the Audi A4 is filled with such thoughtful appointments that they create the perfect environment for the driver and passengers. Genuine wood and aluminum inlays provide the materials for a precise fit and finish, available keyless start, stop, and entry offers premium convenience, and leather seating surfaces cater to comfort as much as the eyes. Luxury has progressed because we design it for you, not for you to adapt to it.

## .04 - *Three-zone Automatic Climate Control*

Available in the Audi A4, it gives the driver, front passenger and rear passengers the option to set their individual cabin temperature to suit their particular comfort level.



*.05 - Standard Leather Seating Surfaces*





## Bridging the cultural divide between form and function.

It's a little-known fact that in Germany and throughout Europe, the A4 Avant is thought of as a slightly more sporty, sexier version of the A4. It's not hard to imagine how Germans see the A4 Avant as a true turn-on. Sophistication blended with just the right amount of functionality. And with a spectacular design, a sleek, sloped roofline, short overhangs at the wheels and an available sculpted power rear tailgate adding a note of intrigue to function, it's easy to see style too. Add to that 50.5 cu ft<sup>1</sup> of cargo capacity and a panoramic sunroof, and you just might see the light as well.



1 With second-row seats folded.

### .06 – Cargo Capacity

With 60/40 split folding rear seats and impressive cargo capacities, the A4 Avant is uniquely matched for the driver that needs more space from a sports car.



----- 50.5 cu ft<sup>1</sup> -----





# quattro

## The cure for linear thinking.



Thirty years ago, the debate was “front or rear?” Audi thought differently—both. That’s why the A4 delivers power through an available Audi quattro® all-wheel drive system that helps grip the road even before you hit the throttle. In optimal conditions, power is 40:60 rear-wheel biased to help maximize acceleration and corner turn-in. When the conditions become more challenging, power is transferred to help maximize grip and control. More than a bad weather security blanket, it defines dynamic handling while enhancing performance, so you might even throw the road a curve.

# Taunt inertia.

The slightly more risqué sibling to the A4, the Audi S4 might act like it treats the laws of physics as mere suggestions. But that's what happens when Audi engineers dedicate themselves to producing a vehicle that handles practically any road confidently. With its available sports differential, the S4 adjusts to conditions—overdriving the outer rear wheel when warranted. What it means for the driver is dedicated sports car handling, making winding roads your goal, not a route to avoid.

## .07 - *Sports Differential*

Combining Audi quattro® with the available sports differential, the Audi S4 dynamically varies torque between the rear wheels for enhanced cornering agility.

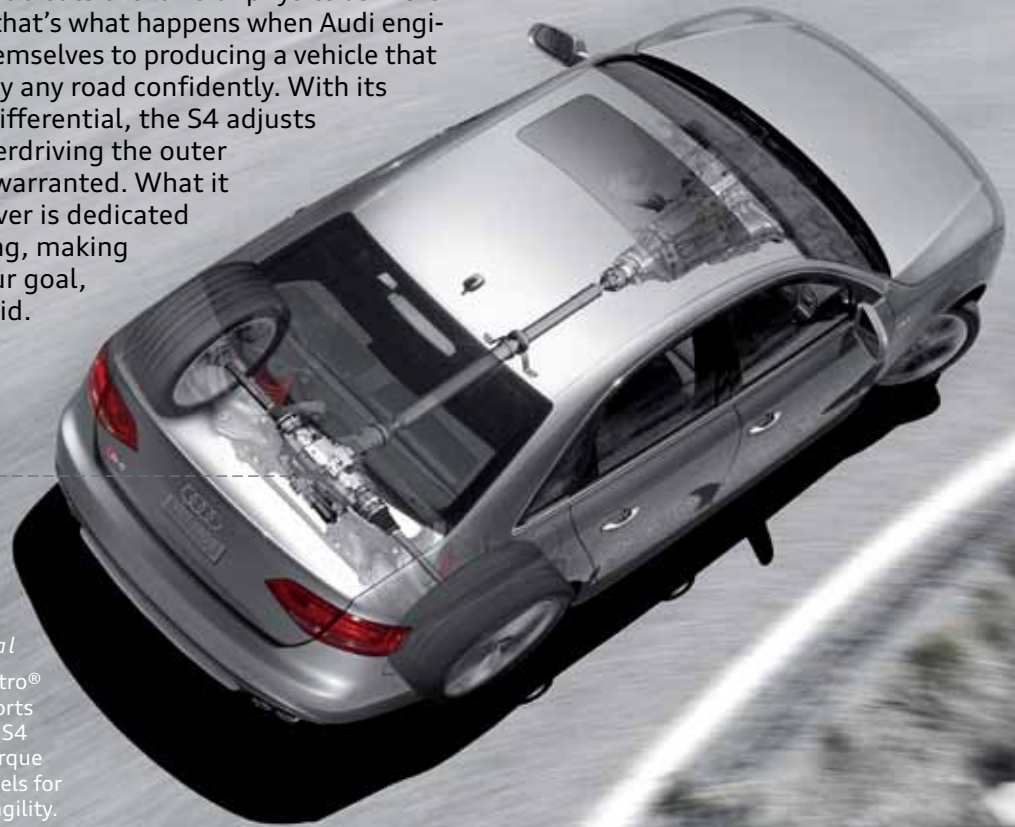



# It might feel like we've read your mind.

While the engineering on the A4 and S4 helps to elevate the driving profile and performance characteristics, it's not a totally refined sensibility we're after. We do, however, leave some of it up to you and your mood.



- peaceful
- balanced
- fun
- customized

## .08 - Audi Drive Select

— machine —

Our drive is responsive, but we also demand that you respond to the drive. With Audi drive select, you choose Comfort, Auto or Dynamic settings that configure the engine, transmission, available sports differential (S4), suspension and steering to help respond to your mood or the conditions, or just to experiment with drive settings that range from outstandingly comfortable to intensely sporty.

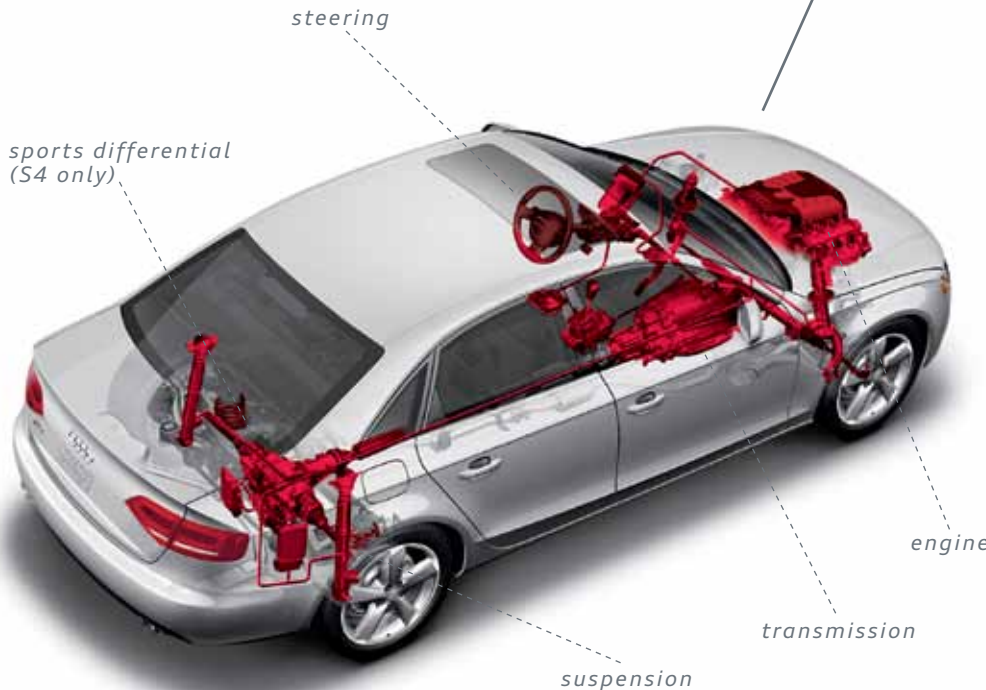

- *comfort mode (peaceful)*  
Perfect for city streets, this setting adds optimized steering and suspension to help provide a smoother drive.
- *auto mode (balanced)*  
The best of both worlds dialed to automatically adjust settings for a seamless combination of comfort and responsiveness.
- *dynamic mode (fun)*  
More precise steering and a more sensitive throttle and firmer suspension give this setting an aggressive tilt.
- *individual mode (customized)*  
Take the turn your way—this mode allows you to adjust the steering, throttle and transmission upshifts to your style.

# Stay tuned for a dynamic transmission.

Many drivers misplace their acceleration frustration on their engines, when it's actually the transmission that isn't rising to the occasion. The Audi A4 eliminates that concern with revolutionary transmissions, capable of delivering engine power in the most responsive and efficient way possible. This in turn allows you to command upshifts or downshifts on models equipped with automatic transmissions through the available steering-wheel-mounted shift paddles.<sup>1</sup>

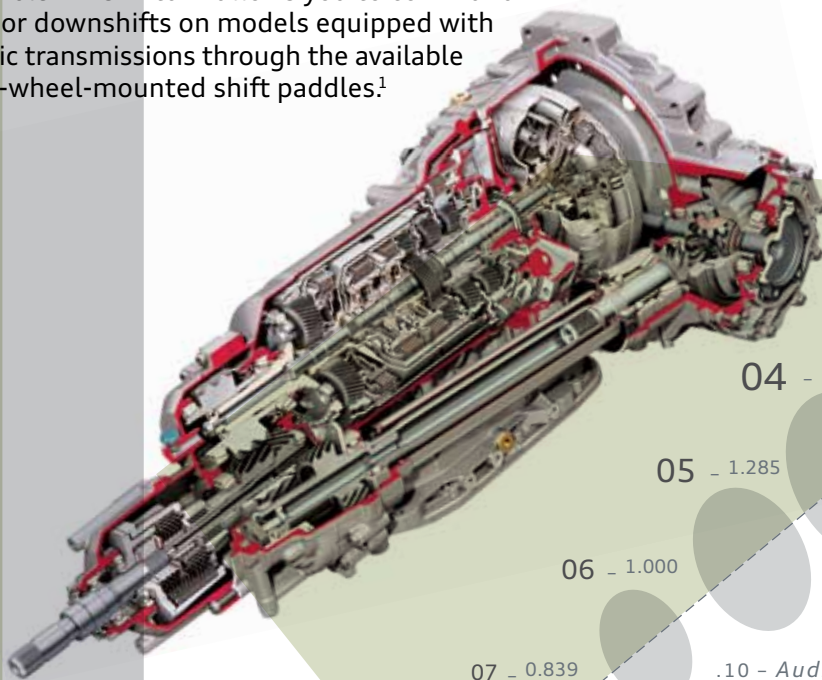

gears —  
01 — 4.714 — gear ratios

02 — 3.143

03 — 2.106

04 — 1.667

05 — 1.285

06 — 1.000

07 — 0.839

08 — 0.667

.09 — *Eight-speed Tiptronic®*

Replacing our six-speed Tiptronic® transmission from previous generations, this will retain the smooth shifting you've come to expect, while increasing the fuel efficiency<sup>1</sup> and responsiveness of your A4.

.10 — *Audi Multitronic® Continuously Variable Transmission with FrontTrak® Front-wheel Drive*

In addition to the dynamics and economy of a traditional manual and the easy shifting of an automatic, the Audi multitronic continuously variable transmission always finds the engine's optimum rev range for better response.<sup>1</sup>

# The engine that confirms “Truth in Engineering.”

Feel the acceleration, and you know the A4 has undeniable power. But where others tack things on to make power, Audi engineers thought up a better way. Using less. By reducing the overall weight of the car, including using innovative aluminum parts in the engine itself, they were able to install an engine that sacrifices nothing in the way of performance. Anyone can add, but Audi engineers are consumed with getting something more out of the engines they build.

.11 - 2.0-liter Turbocharged  
Four-cylinder

TFSI® direct injection fuses potency with efficiency. By producing 211 hp and 258 lb-ft of torque, you feel the punch of acceleration with the smooth power of a finely tuned turbocharged performance vehicle.<sup>1,2</sup>

0 - 60 mph

6.3 seconds

compression ratio

9.6:1

1 22 city/30 highway/25 combined mpg (2012 A4 2.0T with Audi multitronic® continuously variable transmission with FrontTrak® front-wheel drive); 21 city/31 highway/25 combined mpg (2012 A4 2.0T with six-speed manual transmission and Audi quattro® all-wheel drive); 21 city/29 highway/24 combined mpg (2012 A4 2.0T with eight-speed Tiptronic® automatic transmission and Audi quattro® all-wheel drive). EPA estimates. Your mileage will vary. 2 0-60-mph varies from model to model. Always obey local speed and traffic laws.

**Ready for  
its performance  
review.**

**S**

Featuring a classic sport sedan stance and feel, a lowered suspension and stylish sports wheels, the Audi S4 adds an extra helping of performance to its already energetic character. Leaving nothing to chance, its striking aluminum-optic mirrors, quad exhaust tailpipes and exclusive S4 front and rear bumpers are just a few indicators of the power the S4 exudes. The proof is in the moment you punch the throttle.





V8 T

# Geared for true performance.

You might not care how efficient you've become, but the fact remains that this Audi S4 with its available seven-speed Audi S tronic® dual-clutch transmission shares a commitment to performance and economy! That's because this transmission actually shifts gears nearly instantly, with the next gear engaged from a separate clutch, providing quick shifting in low gears, then rpm-sinking long ratios at top gears. Better yet, it was all designed to work in concert with the high-torque output of its 3.0T engine. Using paddle shifters or automatic mode, you are able to engage the road with an innovative, optimized transmission that respects efficiency as much as it delivers impressive power.

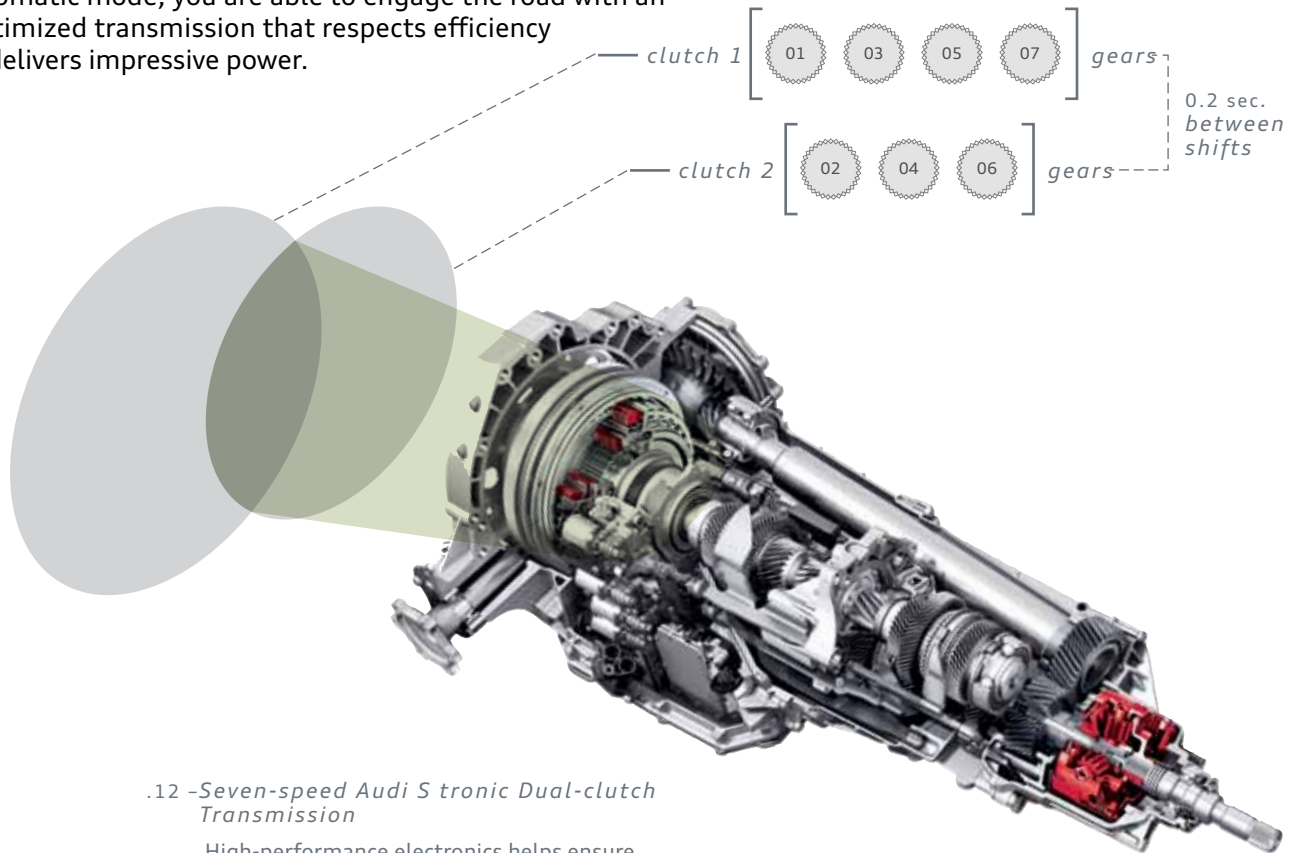

.12 -Seven-speed Audi S tronic Dual-clutch Transmission

High-performance electronics helps ensure lightning-fast gear shifts, adapted to the driving situation—letting you see its powerful, or powerfully efficient, side.

# Definitive proof that six is greater than eight.

First things first: zero to 60 in 4.9 seconds.<sup>2</sup> But that's not the only number worth mentioning here, as the 3.0T supercharged V6 in the S4 utilizes forced induction to streamline fuel efficiency up to a healthy 28 mpg highway<sup>1</sup> to surpass traditional eight-cylinder capabilities. So you are able to understand the paradox—when it comes to Audi engineering, six cylinders is truly greater than eight.

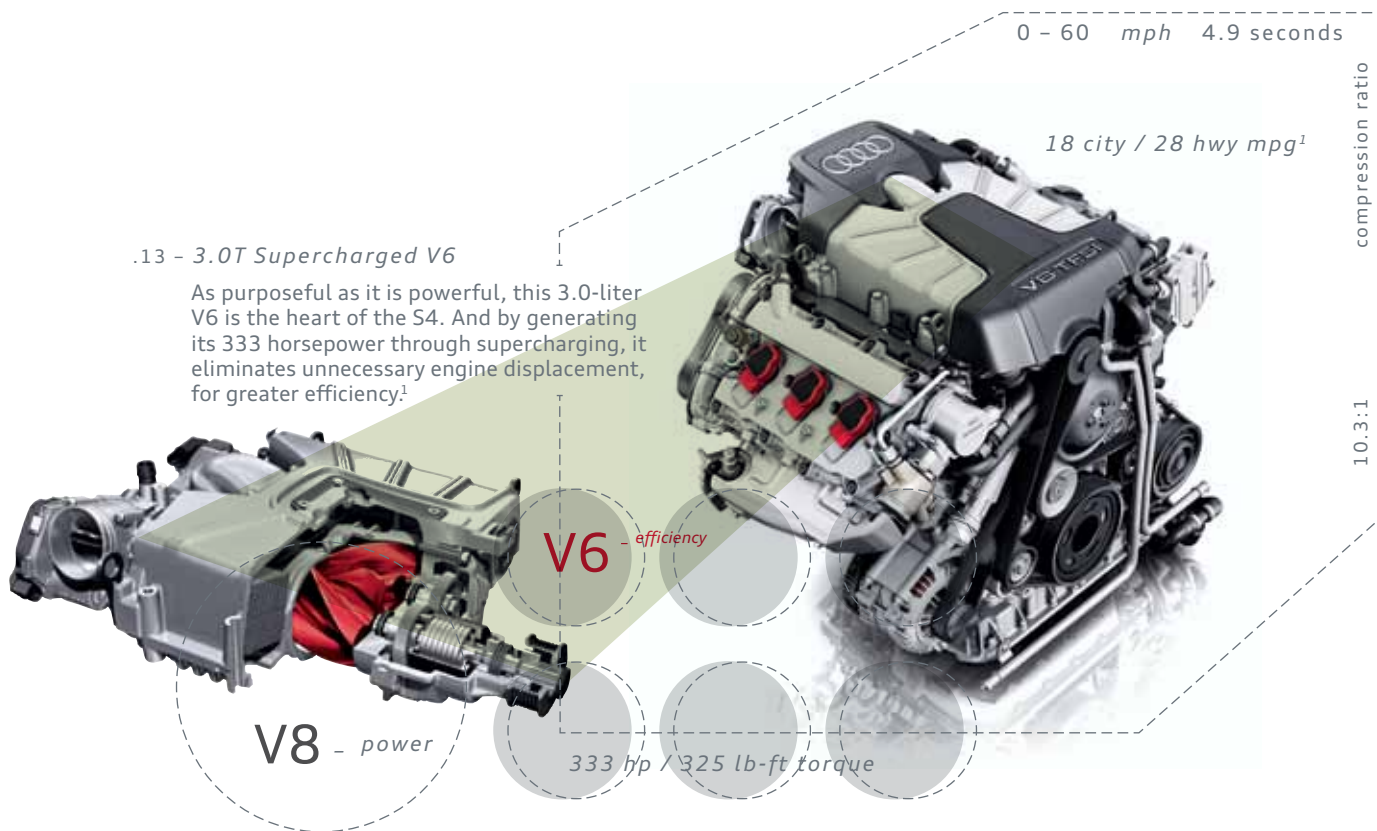

<sup>1</sup> 18 city/27 highway/21 combined mpg (2012 S4 3.0T with manual transmission); 18 city/28 highway/21 combined mpg (2012 S4 3.0T with Audi S tronic® dual-clutch transmission). EPA estimates. Your mileage will vary. <sup>2</sup> Always obey local speed and traffic laws.

# Control that rewards life's arbitrary impulses.

Pick a song. Pick a person to talk to. Pick a destination. It's your whim, as the available intuitive settings and controls on the Audi MMI® give the driver a world of commands within arm's reach. Its available BLUETOOTH® phone capabilities, using voice commands and ability to "read" your phonebook using speech-to-text technology, speed the A4 into our new technological age.<sup>1</sup>

calling

## .14 - BLUETOOTH®

Pairing your Audi and mobile phone is a convenient way to access vital information at the touch of a button.

## .15 - Voice Control

Whether you're placing a call, finding a radio station or playing an MP3, or dictating a destination, the available Audi voice control system can access what you are looking for with a simple command.





38° 57' 8.1" N  
77° 23' 41.1" W



.16 - Audi MMI  
*Navigation Plus*

See your environment, see buildings and anticipate your next turn with the available navigation system that helps put a little more depth in any journey.<sup>1</sup>

33° 46' 3.1" N  
118° 11' 26.5" W

<sup>1</sup> See Infotainment/Technology section of Specifications for important details and safety information regarding the Audi MMI® Navigation plus system.

# Finding the right personal note.

Rock or classical, news or jazz, you are more than what you listen to, but what you listen to helps you relax or engage when you are driving. It's something that Audi sound engineers know and feel themselves, so they've crafted a cabin with acoustics in mind to help you find the right note for your drive.

## .18 - Audi Music Interface

Simple to use, the available Audi music interface allows the driver to enjoy different playlists, when used with a compatible device, while maintaining focus on the road.



## .20 - Bang & Olufsen® Sound System

The available sound system is composed of 14 tailor-made speakers, and with a total output of 505 watts delivered through 10 active channels, it blends a unique combination of audiophile sound quality and high-output power that breaks down previous performance barriers in car audio.



## .17 - Sirius XM Satellite Radio

Match your driving mood with a variety of stations throughout the SiriusXM lineup, and see what song is playing on different channels without changing the station, to help you find what you are looking for.



## .19 - Multi-channel Amplification

It may have taken hundreds of hours of sound tuning, but Bang & Olufsen® developed an available soundstage specific to the A4 that is supported by proprietary True Image™ technology. The multi-channel amplification turns two-channel stereo signals into perfect 7.1-channel surround sound, distributing both channels to all loudspeakers in the car—each with its own particular delay and level—to surround you with pure sound.



*.21 - The Human Ear*

Think of your ear as the sound collector. While the brain processes the auditory data in the way you think of as “hearing,” the ear is where the sound waves and pressure enter before being passed on by nerve impulses to the brain. Audi and Bang & Olufsen® design their soundstage with this vital gateway in mind—and work tirelessly to discover the best ways to engage it.

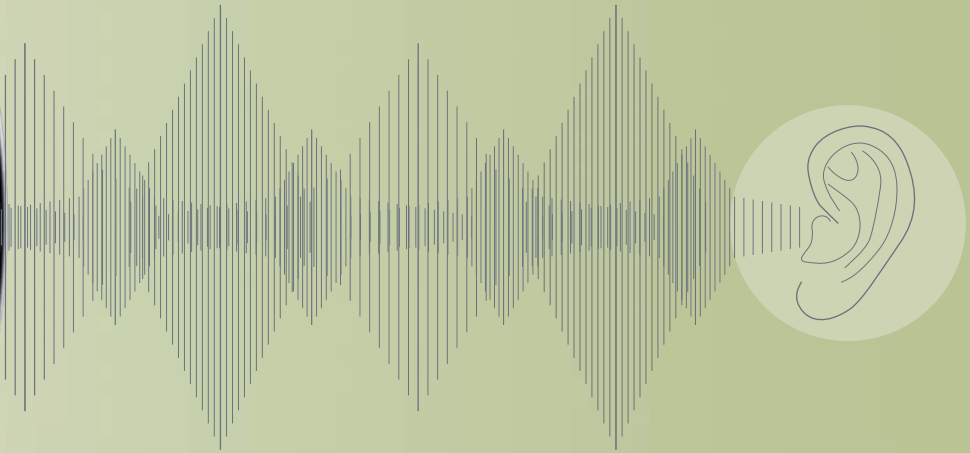
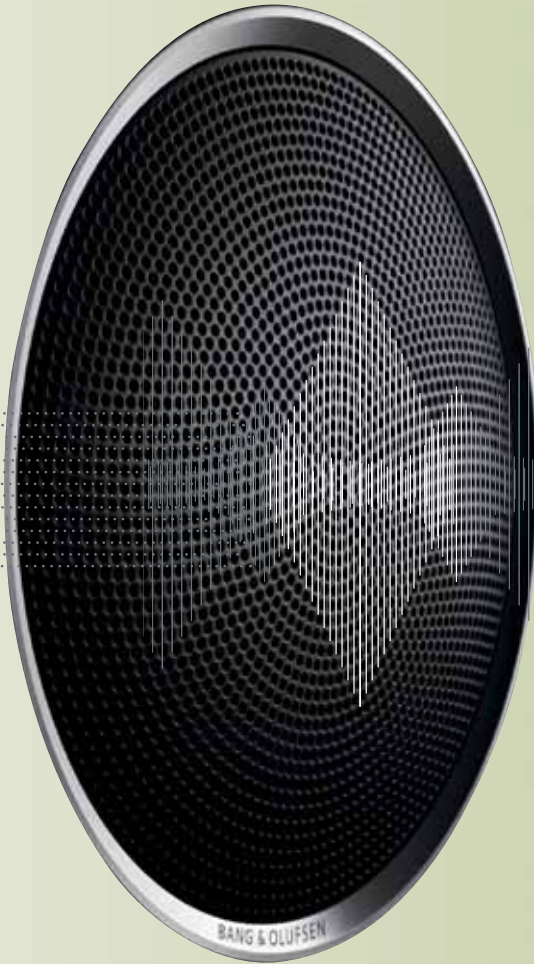

## **It's time you hear the truth.**

Dedicated to the idea of “honest music reproduction,” Bang & Olufsen® is a sound engineer’s dream. Through an available 505-watt 14-speaker system perfectly integrated within your A4, Bang & Olufsen® is set on music reaching your ears by transcending the limits of audio technology. Audi offers an available system that remaps how you experience sound itself by automatically adjusting volume and timbre balance to changing ambient noise levels. Deep, layered and perfectly tuned by engineers who want you to hear the truth about how good life can sound in your A4.

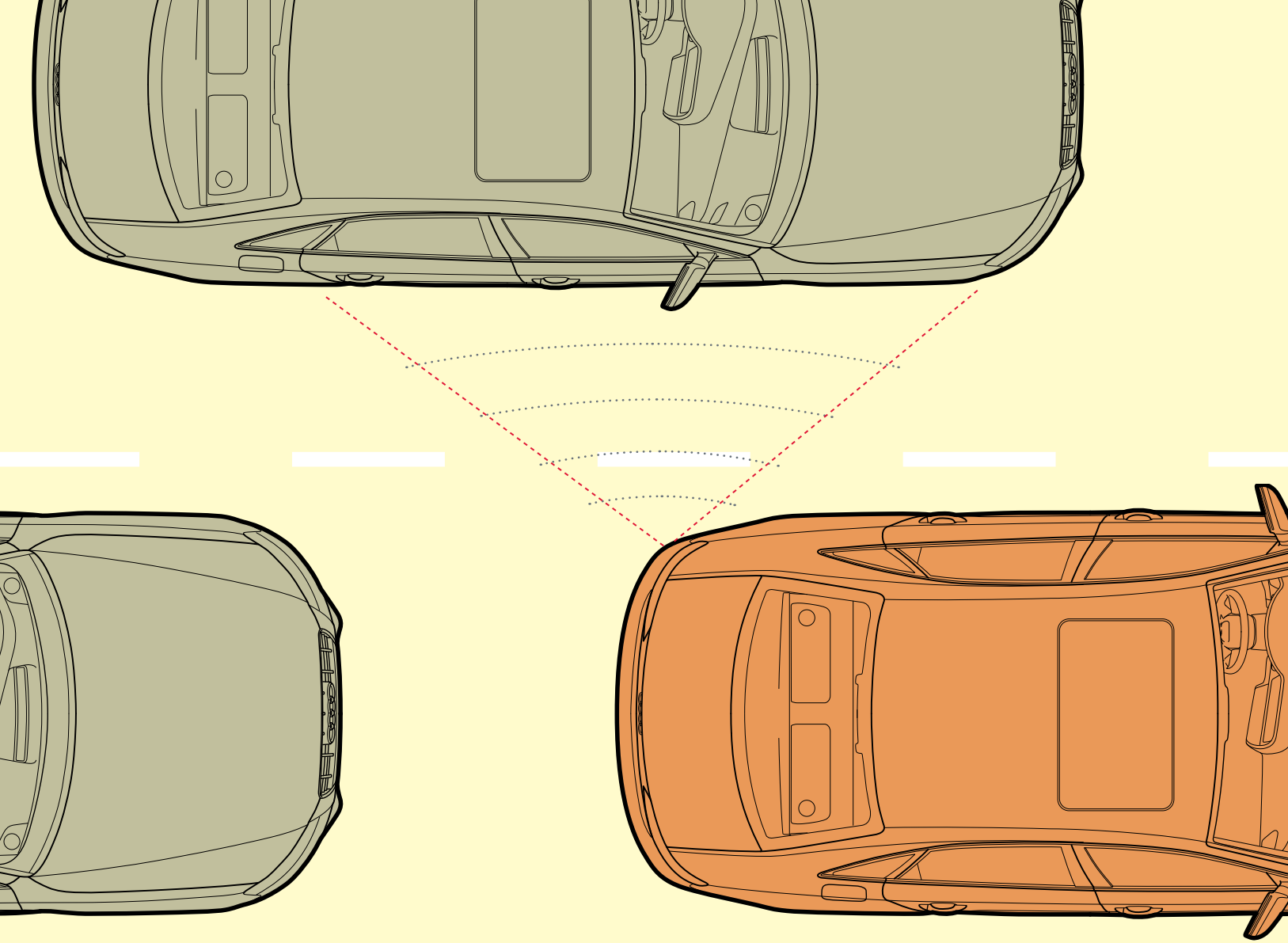

#### .22 - Audi Side Assist

Active at speeds over 19 mph, available Audi side assist helps monitor blind spots and fast-approaching vehicles at a range of 150 ft from the rear. When a vehicle is present within the monitored area, the system warns you via LED lights in the exterior mirrors.

# Anticipating needs you didn't know you had.

The suite of available driver-assistance technologies takes into account the actions of other drivers—while making your drive a little easier. From seemingly sentient Audi adaptive cruise control to Audi side assist, the A4 has incorporated innovative, anticipatory technologies that don't see your future so much as help change it.

## .23 - Audi Adaptive Cruise Control

Available Audi adaptive cruise control on the A4 helps the driver to take command over even more of the driving experience, as its long-range radar measures the distance to the vehicle ahead, sends its data to a computer that weighs the information against velocity and other road variables, and applies the brakes as necessary. Once the road is safe to cruise, the A4 effortlessly accelerates back to its desired speed.

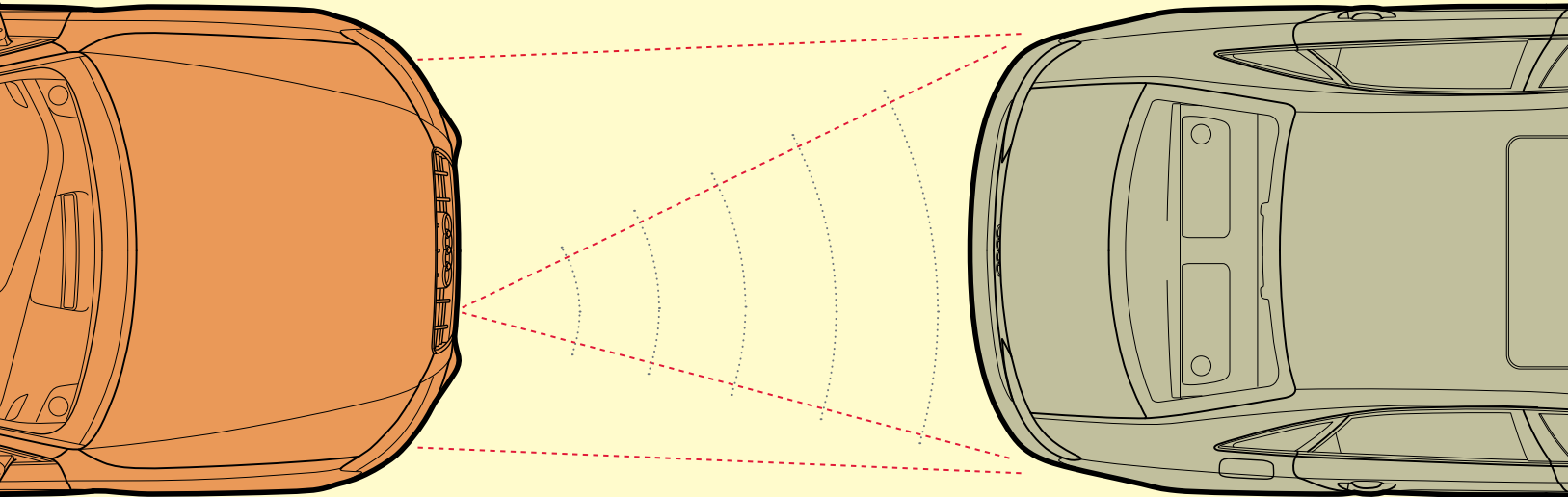

# Helping to see the unforeseen.

Whether it's diminishing the impact of human error or keeping passengers secure during turbulent situations, the Audi A4 consistently rises to the occasion in inconsistent environments. This is evident through its six standard airbags and the use of high-strength steel that adds a measure of safety while enhancing overall handling performance.<sup>1</sup>

## .24 - Six Standard Airbags

With six standard airbags, including front-impact and thorax side airbags for both driver and front passenger, and available rear passenger thorax side airbags, you'll feel practically surrounded.<sup>1</sup> And that's a good thing.



This is a dramatization and does not depict what will happen in a collision. All bags will not inflate in real-world collisions, and if multiple bags do deploy they will be in various stages of inflating/deflating and will never all be inflated at the same time. <sup>1</sup> Airbags are supplemental restraints only and will not deploy under all crash circumstances. Always use safety belts and seat children only in the rear, using restraint systems appropriate for their size and age.

.25 - *Strength and Flexibility*

When it comes to safety, it's important to be strong, but it's also important to be flexible. That's why Audi engineers use high-strength steel in the B-pillar and the floorboards while designing crumple zones in the front and back of the vehicle that help dissipate the energy and force from a collision.



.26 - *Brakes*

Whether you're on the open road or off the beaten path, Audi A4 ESC with ABS helps to keep the vehicle traveling in its intended direction by applying the right brakes at the right time to maintain better traction, minimize skids and optimize control.









## Give the stragglers something to think about.

Whether it's the dual exhaust, defined design lines, or available modern LED technology in the taillights, the Audi A4 and S4 strive to impart the same impression they give when you first meet one of them—a split-second of intrigue coupled with a persistent need to drive them.

.27 - LED Taillight Technology

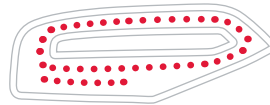

~ fig. 03

Sleek and stylish, these rear light-emitting diodes are brighter and longer-lasting than halogen lights, while also illuminating faster than traditional brake lights, giving the driver behind you more time to respond.



## Accessories

Imagine a cherry on top of your sundae. Sweet, right? Now imagine a cherry that helps protect your A4 in the garage. Or carries your bikes for a serious weekend on the trails. Or makes heads swivel as you drive by. Audi Genuine Accessories are the little extras that make your Audi even sweeter. Designed by the same visionaries



### *Front Spoiler with Blade Insert*

This styling component creates a lowered appearance through its understated front spoiler and blade that's primed for painting. (Not available with S line® exterior appearance or on S4 models.)

### *19" Cortada Alloy Wheels*

This 19" Cortada alloy wheel offers a 5-spoke design consisting of machined triangular panels on each spoke. Its unique Cortada styling benefits from hollow spokes that help keep the A4 light and versatile.



### *Rear Valance with Blade Insert*

A clean, sleek enhancement for the rear of the A4, whose blade can be painted a contrasting color for a striking look on the road. (Not available with S line® exterior appearance or on S4 models.)

### *18" Candelas White Alloy Wheels*

Providing an extra element of confidence to your Audi A4, this impressive drop-center, deep-dish design makes this 15-spoke wheel stand out in any environment.



### *A4 Rear Deck Spoiler*

Body modifications aren't usually this refined. The lines of this spoiler integrate perfectly into the stock body panels of the A4 so that this enhancement meets the eye organically. The result is an inherently different look and feel to your Audi A4. (Not available with S line® exterior appearance or on S4 models.)

### *18" Cascara Alloy Wheels*

Add a personal touch to your Audi with this unique wheel/tire set. Designed exclusively for the Audi A4, these Cascara wheels are engineered to meet strict tolerances for performance and durability.

*Other accessories not shown* -----

### *Various Transport Solutions*

The open road is calling—so bring all the right gear to enjoy the ride. The Audi line of storage accessories helps protect your possessions with a variety of intelligent and innovative solutions. Choose from bike racks, ski racks and a variety of cargo carriers.

### *Comfort and Protection Solutions*

Audi Genuine Accessories offer a wealth of practical aids for more space, tidiness and safety on board with functional items to help keep your Audi in pristine condition. Use them all to help reduce wear and tear on your Audi and help keep it looking like new—inside and out.

who designed your vehicle, all accessories feature a tailored fit and the expert craftsmanship you'd expect from Audi. They are also backed by the 4-year/50,000-mile Audi New Vehicle Limited Warranty, or the accessory's 12-month/12,000-mile limited warranty, whichever extends longer from the accessory purchase date.<sup>1</sup>



#### *A4 Avant Roof Edge Spoiler*

This subtle enhancement fits over the top of the rear hatch, and merges form, fit and function to achieve authentic independence on the road.

#### *Small Cargo Carrier*

Secure your gear with confidence, as this trim, aerodynamic design offers extra carrying capacity (13 cu ft) in a smart size: 55" long, 35" wide, 14" high.

#### *Car Care*

Use the only car care line specifically designed with your Audi vehicle in mind. Audi Guard car care products provide gentle cleansing formulas and special tools to help give interior and exterior surfaces the finest in cleaning and protection.



#### *A4 and S4 Sedan Base Carrier Bars*

Attached to strong side brackets, these are the durable foundation of the Audi roof-rack system. (All roof-rack system attachments require the base carrier bars. All attachments sold separately.)

#### *A4 Avant Base Carrier Bars*

Attached to the durable side brackets of the Audi A4 Avant, these bars help provide the stable foundation for the Audi roof-rack system.

#### *License Plate Frames*

Choose from "Audi Sport" in carbon fiber, black powder-coat, polished and brushed finishes or "Truth in Engineering®" in polished and carbon fiber finishes. (Check local laws and regulations regarding use.)



#### *All-weather Floor Mats*

This set of custom-fit floor mats help keep your Audi looking showroom-fresh, no matter what the weather brings. Helping to protect your vehicle's carpet from stains, these mats withstand practically everything from caked mud to toppled coffees and fumbled gazzpacho.

#### *S4 Alu-optic Trim Package Kit*

This set of eye-catching badges and stone guards communicate to the world the pride and passion you have for your Audi S4.

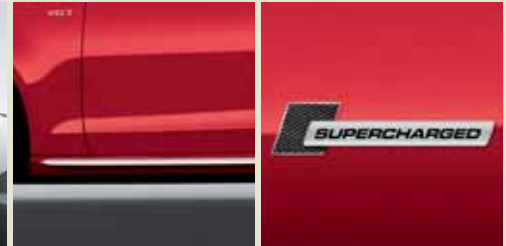

#### *Electronic Accessories*

The many electronic accessories in your Audi are renowned for design that emphasizes user experience. All products are tested to help ensure compatibility with your vehicle's electrical systems so that you can easily enjoy what Audi technology has to offer.

# Colors

*exterior* | *interior*

Ibis White

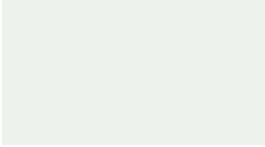

Glacier White metallic

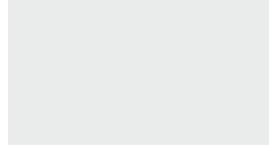

Ice Silver metallic



Monsoon Gray metallic



Estoril Blue crystal



Moonlight Blue metallic



Brilliant Black



Phantom Black pearl



Brilliant Red



Misano Red pearl



S4 exclusive

Black



Light Gray



A4

Cardamom Beige

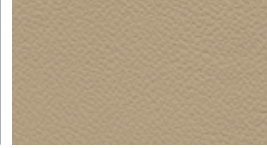

Black/Perforated Alcantara®

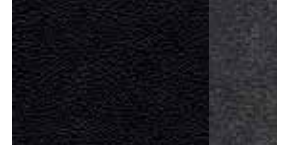

S-line®

Black Silk Nappa



Black/Magma Red Silk Nappa

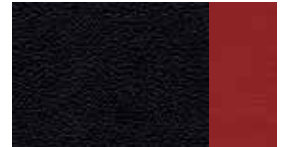

S4

Black/Spectral Silver Silk Nappa



Black/Alcantara®

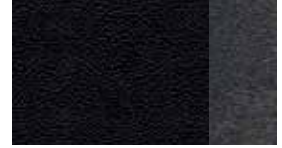

Black/Spectral Silver Alcantara®

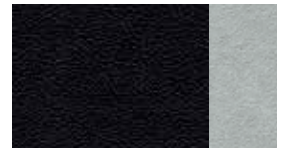

# Color Combinations

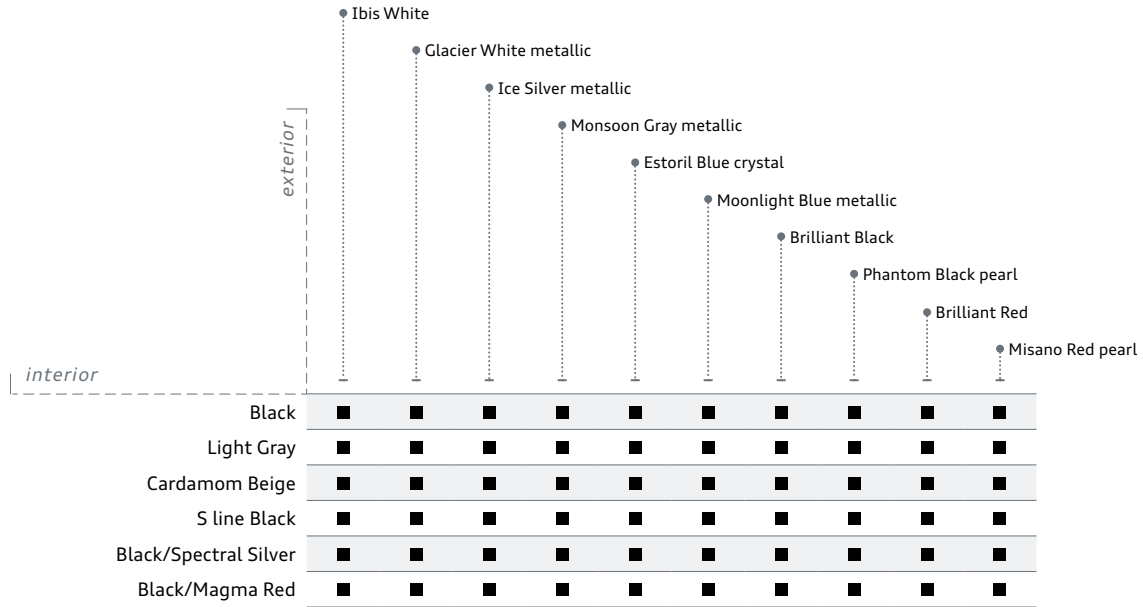

■ Available combinations



## A4 Decorative Inlays

Black  
Aluminum Hologram inlay standard



Cardamom Beige  
Dark Brown Walnut Wood inlay optional



Light Gray  
Dark Brown Walnut Wood inlay optional



Black/Perforated Alcantara®  
Brushed Aluminum inlay S line®



# S4 Decorative Inlays

Black Silk Nappa  
Brushed Aluminum inlay standard



Black/Magma Red Silk Nappa  
Stainless Steel Mesh inlay optional

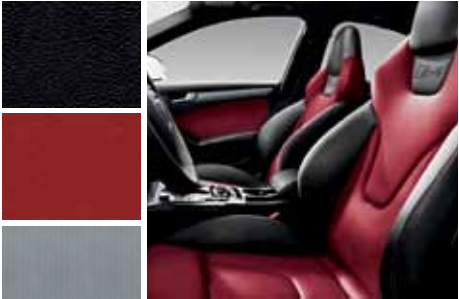

Black/Spectral Silver Silk Nappa  
Carbon Atlas inlay optional



Black/Alcantara®  
Carbon Atlas inlay optional



Black/Spectral Silver Alcantara®  
Brushed Aluminum inlay standard



# Wheels

A4 | S4

17" 10-spoke-star design  
245/45 all-season tires



A4 Premium

18" 10-spoke design  
245/40 all-season tires



A4 Premium Plus and Prestige

18" 5-parallel-spoke design  
245/40 summer performance  
tires<sup>1</sup>



S4 Premium Plus

18" 5-arm design  
245/40 all-season tires



A4 Premium (optional)

18" quattro® GmbH  
5-spoke design  
245/40 all-season tires



A4 Premium Plus and Prestige  
(optional)

19" titanium  
5-arm-rotor design  
255/35 summer performance  
tires<sup>1</sup>



S line® plus Package

19" 5-segment-spoke design  
255/35 summer performance  
tires<sup>1</sup>



S4 Prestige  
S4 Premium Plus (optional)

19" titanium  
5-arm-rotor design  
255/35 summer performance  
tires<sup>1</sup>



Titanium Package

<sup>1</sup> Tires are supplied and warranted by their manufacturer. High-performance tires are designed for optimum performance and handling in warm climates. They are not suitable for cold, snowy, or icy weather conditions. If you drive under those circumstances, you should equip your vehicle with all-season or winter tires, which offer better traction under those conditions. We suggest you use the recommended winter or all-season tire specified for your car or its equivalent. These high-performance tires also have a lower aspect ratio that aids performance and handling; however, in order to avoid tire, rim or vehicle damage, it is important that the inflation pressure is regularly checked and maintained at optimum levels. Please also remember in making your selection that, while these tires deliver responsive handling, they may ride less comfortably and make more noise than other choices. <sup>2</sup> Always obey local speed and traffic laws.



# Configurations | Dimensions

## A4 | S4 Models

	A4 Premium	A4 Premium Plus	A4 Prestige	S4 Premium Plus	S4 Prestige	A4 Premium	A4 Premium Plus	A4 Prestige
	Sedan					Avant		
2.0T with Audi multitronic® continuously variable transmission and FrontTrak® front-wheel drive	■	■	■	—	—	—	—	—
2.0T with six-speed manual transmission and Audi quattro® all-wheel drive	□	□	□	—	—	—	—	—
2.0T with eight-speed Tiptronic® automatic transmission and Audi quattro® all-wheel drive	□	□	□	—	—	■	■	■
3.0T with six-speed manual transmission and Audi quattro® all-wheel drive	—	—	—	■	■	—	—	—
3.0T with seven-speed Audi S tronic® dual-clutch transmission and Audi quattro® all-wheel drive	—	—	—	□	□	—	—	—

## A4 | S4 Engine Specifications

2.0-liter turbocharged: Intercooled, DOHC four-cylinder gasoline engine with Audi TFSI® direct injection, variable valve timing and valvelift system. Horsepower: 211 hp @ 4,300 rpm / Torque: 258 lb-ft @ 1,500 rpm	■	■	■	—	—	■	■	■
3.0-liter supercharged: Dual intercoolers, DOHC V6 gasoline engine with Audi TFSI® direct injection and variable valve timing. Horsepower: 333 hp @ 5,500 rpm / Torque: 325 lb-ft @ 2,900 rpm	—	—	—	■	■	—	—	—

## A4 | S4 Performance Specifications

	0 – 60 mph <sup>2</sup>	Top Speed <sup>2</sup> (electronically limited)
2.0T with Audi multitronic® continuously variable transmission and FrontTrak® front-wheel drive	7.2 seconds	130 mph
2.0T with six-speed manual transmission and Audi quattro® all-wheel drive	6.5 seconds	130 mph
2.0T (Sedan) with eight-speed Tiptronic® automatic transmission and Audi quattro® all-wheel drive	6.3 seconds	130 mph
2.0T (Avant) with eight-speed Tiptronic® automatic transmission and Audi quattro® all-wheel drive	6.5 seconds	130 mph
3.0T with six-speed manual transmission and Audi quattro® all-wheel drive	4.9 seconds	155 mph
3.0T with seven-speed Audi S tronic® dual-clutch transmission and Audi quattro® all-wheel drive	4.9 seconds	155 mph

■ Standard   □ Optional   — N/A

## Exterior Dimensions

Length: 185.2" (A4) 185.7" (S4)	Track, front: 61.6" (A4) 61.1" (S4)
Width: 80.3" (all models)	Track, rear: 61.1" (A4) 60.6" (S4)
Height: 56.2" (A4 Sedan) 56.5" (A4 Avant) 55.4" (S4)	Wheelbase: 110.6" (A4) 110.7" (S4)

## Interior Dimensions

Head room, front: 40.0" (Sedan) 40.4" (Avant)	Shoulder room, front: 55.5" (all models)
Head room, rear: 37.5" (Sedan) 38.2" (Avant)	Shoulder room, rear: 54.3" (all models)
Leg room, front: 41.3" (all models)	EPA cargo volume: 12.4 cu ft / 34.0 cu ft with rear seatback folded (Sedan)
Leg room, rear: 35.2" (all models)	27.6 cu ft / 50.5 cu ft with rear seatback folded (Avant)

## Fuel Economy Estimates, City / Highway / Combined

A4 2.0T with manual transmission: 21/31/25	S4 3.0T with manual transmission: 18/27/21
A4 2.0T with Audi multitronic transmission: 22/30/25	S4 3.0T with Audi S tronic dual-clutch transmission: 18/28/21
A4 2.0T with Tiptronic® transmission: 21/29/24	

EPA estimates. Your mileage will vary. See [www.fueleconomy.gov](http://www.fueleconomy.gov) for details.

## Weights and Capacities

Curb weight: N/A
Engine oil capacity (2.0T/3.0T): 4.8 qt/ 8.6 qt
Fuel tank capacity: 16.9 gal

# Specifications

	A4 Premium	A4 Premium Plus	A4 Prestige	S4 Premium Plus	S4 Prestige	A4 Premium	A4 Premium Plus	A4 Prestige
	Sedan					Avant		
<b>Chassis</b>								
Fully galvanized steel unibody with multistep anti-corrosion protection	■	■	■	■	■	■	■	■
Five-link front suspension with upper and lower control arms with stabilizer bar	■	■	■	■	■	■	■	■
Trapezoidal-link rear suspension with stabilizer bar	■	■	■	■	■	■	■	■
Sport suspension calibration	–	□	□	–	–	–	□	□
S4 sport suspension calibration	–	–	–	■	■	–	–	–
Audi servotronic® speed-sensitive power steering—varies assistance based on vehicle speed	■	■	■	■	■	■	■	■
Dynamic steering and chassis	–	–	□	–	□	–	–	□
Audi quattro® all-wheel drive system utilizing self-locking center differential—40:60 rear-biased torque split	□	□	□	■	■	■	■	■
Audi quattro® with sports differential	–	–	–	□	□	–	–	–
FrontTrak® front-wheel drive	■	■	■	–	–	–	–	–
Six-speed manual transmission	□	□	□	■	■	–	–	–
Eight-speed Tiptronic® automatic transmission	□	□	□	–	–	■	■	■
Seven-speed Audi S tronic® dual-clutch transmission	–	–	–	□	□	–	–	–
Audi multitronic® continuously variable transmission	■	■	■	–	–	–	–	–
<b>Safety   Security</b>								
Driver and front passenger dual-stage airbags, thorax side airbags and Sideguard® head curtain airbags <sup>1</sup>	■	■	■	■	■	■	■	■
Rear-passenger thorax side airbags <sup>1</sup>	–	□	□	□	□	□	□	□
Front passenger occupant detection—for airbags	■	■	■	■	■	■	■	■
Safety belt reminder for driver and front passenger	■	■	■	■	■	■	■	■
Lower Anchors and Tethers for CHildren (LATCH) in rear seats	■	■	■	■	■	■	■	■
Power central locking system with safety unlock feature if airbags deploy	■	■	■	■	■	■	■	■
Electronic Stability Control (ESC) with traction control (ASR)	■	■	■	■	■	■	■	■

■ Standard    □ Optional    – N/A

<sup>1</sup> Airbags are supplemental restraints only and will not deploy under all crash circumstances. Always use safety belts and seat children only in the rear, using restraint systems appropriate for their size and age. <sup>2</sup> Audi Navigation plus depends on signals from the worldwide Global Positioning Satellite network. The vehicle's electrical system, and existing wireless and satellite technologies, must be available and operating properly for the system to function. The system is designed to provide you with suggested routes in locating addresses, destinations and other points of interest. Changes in street names, construction zones, traffic flow, points of interest and other road system changes are beyond the control of Audi of America, Inc. Complete detailed mapping of

	A4 Premium	A4 Premium Plus	A4 Prestige	S4 Premium Plus	S4 Prestige	A4 Premium	A4 Premium Plus	A4 Prestige
	Sedan			Avant				
<b>Safety   Security (continued)</b>								
Anti-lock Brake System (ABS) with Electronic Brake-pressure Distribution (EBD) and brake assist	■	■	■	■	■	■	■	■
Front ventilated disc brakes	■	■	■	■	■	■	■	■
Rear disc brakes	■	■	■	-	-	■	■	■
Rear ventilated disc brakes	-	-	-	■	■	-	-	-
Electromechanical parking brake	■	■	■	■	■	■	■	■
<b>Infotainment   Technology</b>								
Audi MMI® Navigation plus with voice control system <sup>2</sup>	-	□	■	□	■	-	□	■
Color driver information system	-	□	■	□	■	-	□	■
Audi premium sound system with ten speakers and single CD player with MP3 playback capability	■	■	-	■	-	■	■	-
Bang & Olufsen® Sound System with 14 speakers and 505 watts	-	□	■	□	■	-	□	■
HD Radio™ technology	-	□	■	□	■	-	□	■
SiriusXM Traffic with 90-day trial subscription <sup>3</sup>	-	□	■	□	■	-	□	■
SiriusXM Satellite Radio with 90-day trial subscription <sup>3</sup>	■	■	■	■	■	■	■	■
Audi music interface with iPod® integration	□	■	■	■	■	□	■	■
BLUETOOTH® wireless technology preparation for mobile phone	□	■	■	■	■	□	■	■
Homelink® remote transmitter	□	■	■	■	■	□	■	■
Audi advanced key—keyless start, stop and entry	-	□	■	□	■	-	□	■
Cruise control with coast, resume and accelerate features	■	■	■	■	■	■	■	■
Audi adaptive cruise control	-	-	□	-	□	-	-	□
Audi side assist	-	-	■	-	■	-	-	■
Audi drive select	-	-	□	-	□	-	-	□
Parking system with rear sensors	-	□	■	□	■	-	□	■
Rain/light sensors for automatic windshield wipers and headlights	■	■	■	■	■	■	■	■

lanes, roads, streets, toll roads, highways, etc., is not possible, therefore you may encounter discrepancies between the mapping and your actual location. Please rely on your individual judgment in determining whether or not to follow a suggested Audi Navigation plus route. Periodically, the mapping is updated, and a new DVD will be required in order to maintain the latest navigation information available to us. These will be available for purchase from time to time at an additional cost. Consult your dealer or call 1-800-FOR-AUDI for details. <sup>3</sup> See back cover for important information regarding required SiriusXM subscriptions.

# Specifications

Exterior	Sedan					Avant		
	A4 Premium	A4 Premium Plus	A4 Prestige	S4 Premium Plus	S4 Prestige	A4 Premium	A4 Premium Plus	A4 Prestige
Audi Singleframe® grille	■	■	■	■	■	■	■	■
Halogen headlights with daytime running lights	■	-	-	-	-	■	-	-
Xenon plus headlights with LED daytime running light technology	□	■	-	■	-	□	■	-
Adaptive xenon plus headlights with LED daytime running light technology	-	-	■	-	■	-	-	■
Automatic headlights	■	■	■	■	■	■	■	■
Front and rear fog lights	■	■	■	■	■	■	■	■
LED taillight technology	□	■	■	■	■	-	-	-
Power-adjustable heated side mirrors	■	-	-	-	-	■	-	-
Power-adjustable, auto-dimming, heated side mirrors with memory (body-color on A4; aluminum-optic on S4)	-	■	■	■	■	-	■	■
Aluminum trim around exterior windows	□	■	■	■	■	□	■	■
Chrome exhaust tips	□	■	■	■	■	□	■	■
S quad exhaust pipes with chrome tips	-	-	-	■	■	-	-	-
Power rear tailgate	-	-	-	-	-	-	■	■
Audi S line® exterior appearance	-	■	■	-	-	-	■	■
S exterior appearance	-	-	-	■	■	-	-	-

Interior	Sedan					Avant		
	A4 Premium	A4 Premium Plus	A4 Prestige	S4 Premium Plus	S4 Prestige	A4 Premium	A4 Premium Plus	A4 Prestige
Automatic climate control	■	-	-	-	-	■	-	-
Three-zone automatic climate control	-	■	■	■	■	-	■	■
Four-spoke multifunction steering wheel	■	■	■	-	-	■	■	■
Three-spoke multifunction steering wheel with shift paddles (automatic transmissions only)	-	□	□	■	■	-	□	□
Tilt and telescopic manually adjustable steering column	■	■	■	■	■	■	■	■
Black cloth headliner	-	-	□	■	■	-	-	□
Leather seating surfaces	■	■	■	-	-	■	■	■
Silk Nappa leather seating surfaces and trim	-	-	-	□	□	-	-	-
Leather/Alcantara® seating surfaces	-	-	□	■	■	-	-	□
Eight-way power front seats and four-way power lumbar adjustment for driver	■	■	■	-	-	■	■	■
Twelve-way power front sport seats (includes four-way power lumbar adjustment)	-	□	□	-	-	-	□	□
Twelve-way power front S4 sport seats (includes four-way power lumbar adjustment)	-	-	-	■	■	-	-	-
Heated front seats	□	■	■	■	■	□	■	■
Driver seat memory	-	■	■	■	■	-	■	■
60/40 split folding rear seatback	-	■	■	■	■	■	■	■
Dual front sun visors with lighted vanity mirror	■	■	■	■	■	■	■	■
Power windows with one-touch up/down operation and pinch protection	■	■	■	■	■	■	■	■
Sunroof	■	■	■	■	■	-	-	-
Panoramic sunroof	-	-	-	-	-	■	■	■

■ Standard   □ Optional   - N/A

# Packages | Options

Packages	A4 Premium	A4 Premium Plus	A4 Prestige	S4 Premium Plus	S4 Prestige	A4 Premium	A4 Premium Plus	A4 Prestige
	Sedan				Avant			
<b>Convenience Package:</b> Audi music interface with iPod® integration, BLUETOOTH® wireless technology preparation for mobile phone, and Homelink® remote transmitter	□	■	■	■	■	□	■	■
<b>Style Package:</b> Xenon plus headlights with LED daytime running light technology, LED taillight technology (Sedan only), and aluminum trim around exterior windows and chrome exhaust tips (Sedan only)	□	■	■	■	■	□	■	■
<b>Audi MMI® Navigation Plus:</b> Audi MMI® Navigation plus with voice control system, color driver information system, and HD Radio™ technology	—	□	■	□	■	—	□	■
<b>Sport Package:</b> Sport suspension calibration, three-spoke multifunction steering wheel with shift paddles (automatic transmissions only), and twelve-way power front sport seats (includes four-way power lumbar adjustment)	—	□	□	—	—	—	□	□
<b>S line® plus Package:</b> 19" titanium 5-arm-rotor design alloy wheels, summer performance tires, <sup>1</sup> black-optic exterior appearance, leather/Alcantara® seating surfaces, brushed aluminum inlays, and black cloth headliner	—	—	□	—	—	—	—	□
<b>Titanium Package:</b> 19" titanium 5-arm-rotor design alloy wheels, summer performance tires, <sup>1</sup> body-color side mirrors, black-optic exterior appearance, and platinum gray rear diffuser blade	—	—	—	—	□	—	—	—
<b>Audi Drive Select Package:</b> Dynamic steering and chassis, and Audi drive select (S models include sports differential)	—	—	□	—	□	—	—	□
<b>Individual Options</b>								
18" 5-arm design alloy wheels	□	—	—	—	—	□	—	—
18" Audi quattro® GmbH 5-spoke design alloy wheels	—	□	□	—	—	—	□	□
19" 5-segment-spoke design alloy wheels with summer performance tires <sup>1</sup>	—	—	—	□	■	—	—	—
Bang & Olufsen® Sound System with 14 speakers and 505 watts	—	□	■	□	■	—	□	■
Audi advanced key—keyless start, stop and entry	—	□	■	□	■	—	□	■
Audi adaptive cruise control	—	—	□	—	□	—	—	□
Silk Nappa leather seating surfaces and trim	—	—	—	□	□	—	—	—
Heated front seats	□	■	■	■	■	□	■	■
Dark Brown Walnut Wood inlays	□	□	□	—	—	□	□	□
Stainless Steel Mesh inlays	—	—	—	□	□	—	—	—
Carbon Atlas inlays	—	—	—	□	□	—	—	—
Rear-passenger thorax side airbags	—	□	□	□	□	□	□	□
Power rear sunshade	—	—	□	—	□	—	—	—
Rear side sunshades	—	—	□	—	□	—	—	□
Sports differential	—	—	—	□	□	—	—	—



2012 | A4 S4

Audi of America  
Audiusa.com  
Facebook.com/Audi

Note: A word about this brochure. Audi of America, Inc., believes the specifications in this brochure to be correct at the time of printing. However, specifications, standard equipment, options, fabrics, and colors are subject to change without notice. Some equipment may be unavailable when your vehicle is built. Please ask your dealer for advice concerning current availability of standard and optional equipment, and your dealer will verify that your vehicle will include the equipment you ordered. Vehicles in this brochure are shown with optional equipment. See your dealer for complete details on the New Vehicle Limited Warranty, twelve-year limited warranty against corrosion perforation, and Audi 24/7 Roadside Assistance. (Roadside assistance coverage provided by Road America in the U.S. Certain conditions apply; see your dealer for details.) Tires supplied by various manufacturers. "Audi," all model names, "FrontTrak," "MMI," "multitronic," "quattro," "Sideguard," "Singleframe" and the Singleframe grille design, "S tronic," "TFSI," "Truth in Engineering," and the four rings logo are registered trademarks of AUDI AG. "Alcantara" is a registered trademark of Alcantara S.p.A. Bang & Olufsen is a registered trademark of Bang & Olufsen. The BLUETOOTH word mark and logos are owned by the Bluetooth SIG, Inc., and use of any such marks by AUDI AG is under license. "HD Radio" and the HD Radio logo are proprietary trademarks of iBiquity Digital Corporation. "HomeLink" is a registered trademark of Johnson Controls Technology Company. "iPod" is a registered trademark of Apple, Inc. "Sirius" and all related marks and logos are trademarks of SiriusXM Radio Inc. and its subsidiaries. SiriusXM Satellite Radio and Traffic subscriptions sold separately or as a package after trial expires. SiriusXM Traffic service available in select markets. Subscriptions are governed by SiriusXM Customer Agreement (see [www.siriusxm.com](http://www.siriusxm.com)) and are continuous until you call SiriusXM to cancel. Sirius U.S. Satellite Service available only to those 18 and older in the 48 contiguous U.S.A., D.C. and Puerto Rico (with coverage limitations). All other trademarks are the property of their respective owners. Some European models shown.