



# A6

Audi A6

Audi  
Truth in Engineering





## The road is now an intelligent place.

Think of it this way, an Audi A6 luxury sport sedan is proof you like to take the intelligent approach. In fact, with a suite of available technologies, you can make an intense connection with your A6, and the road. Connect faster with the industry-first handwriting-recognition technology of Audi MMI® touch. Or access the world with Audi Connect, featuring the class-first Google Earth™ navigational assistance, and an embedded Wi-Fi hotspot right in your car! Add in BLUETOOTH® wireless technology, voice recognition, real-time traffic updates, and more, and you have the uncompromised performance of a technologically advanced luxury sport sedan. So advanced, it not only gives you the world, it seems to anticipate the world's response.

1 Not recommended for use while driving. 2 Based on brightness comparison to the sun and 5,500 K color temperature. Full LED headlights are an optional upgrade.





*.01 - Full LED Headlight Technology*

The Audi A6 offers full LED headlights. With an approximate lifespan of 10,000 hours, these lights are the closest re-creation of daylight yet.<sup>2</sup> Bright and stylish, they offer signature brilliance from Audi.



*- fig. 01*

**Building a more  
dramatic story,  
line by line.**



Some writers try and conceive one brilliant character and let the plot organically build and flow from there. We took a page from their book, so to speak, when designing the all-new A6. To create and define that brilliant character, we started with one great line. The Tornado line, actually. Bisecting the body profile, it runs strongly through the middle of the vehicle to give it a bold, progressive stance that tells the world that there's pedigree here, but not a predictable one. After that, the narrative becomes yours.





.02 - Design Lines

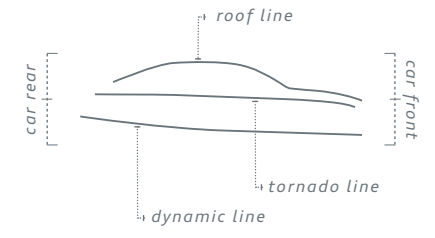

See how the A6 model's Dynamic line defines the lighting surfaces while also bringing the vehicle closer to the road. Its Roof line creates a sporty coupe-like silhouette, while the Tornado line extends along the entire body to provide its visual muscle.



1 25 city/33 highway/28 combined mpg (2012 A6 2.0T); 19 city/28 highway/22 combined mpg (2012 A6 3.0T). EPA estimates. Your mileage will vary.





03 - Audi Connect

In addition to Wi-Fi connectivity and Google Earth™, assisted navigation, Audi Connect provides weather information, fuel prices, news, and Google Earth™ points of interest, such as landmarks or other attractions.

## Progress starts with a point of view.

The trick is to be bold while acting cool. That's our approach with the A6. Crafted with precision, appointed luxuriously and built with performance in mind, it is engineered lighter than the previous generation A6 for better efficiency; and connected like no car before. We built the A6 not for those concerned with looking up or down, but for those who look out to see all the possibilities.





## Our interior has no mirror image.



Passion doesn't benefit from balance. Maybe that's why nothing, from the gleaming aluminum-trim surrounds to the burnished decorative wood or brushed aluminum inlays, is symmetrical. We considered every component of the interior and found that the people interacting with it would have different needs. So the dash isn't in balance—it's in a proper perspective for the driver and the passengers, respectively. A uniquely Audi perspective. By incorporating luxury materials and top-flight craftsmanship, we stand apart. By designing with inspired abandon, the A6 interior provides a welcome contrast to the same old symmetry.



### .04 - *Inlay Materials*



The results of painstaking craftsmanship, the Audi approach to our wood and metal inlays is the same as it is to our engineering. Imperfection is not an option. Nothing is an imitation, so natural wood shines. Nothing is faked, so polished and brushed aluminum glisten. We capture the right accent of your interior choice, and add a singular finish to its fit.







From here, it's all in front of you.





It's time to put yourself in the driver's seat. Feel how the wraparound curve of the A6 instrument panel invites your exploration. See how it integrates intuitively with the overall driver-centric layout. Discover how the design centers around the available Audi MMI® Navigation plus with its 8" display deploying from and retracting into the instrument panel. Adjust the eight-way power-adjustable seats, grab the leather-wrapped, multifunction steering wheel and spark the ignition. It's your time to drive.



# Input as unique as your fingerprint.

What does your handwriting say about you? We aren't really sure. We just know it speaks to us. A revolution in intelligent simplicity, the optional Audi MMI® touch with handwriting-recognition is a class-first technology that gives you the ability to give commands and retrieve media simply by recognizing a few strokes of your finger. Access information such as songs, phone numbers, and destinations through the Audi MMI® touch—or give input to the optional Audi Connect, the world's first media system with Google Earth™-enabled maps. The world isn't simply at your fingertips—your fingertips open up a new way to interact with the world.



.05 - Audi MMI® touch

Developed by the Audi HMI (Human Machine Interface) team, Audi MMI® touch defines why simple can be so complex. Not to use, but to design. The HMI team built a system so advanced, it can read almost anyone's handwriting—even if you choose to write it with your off hand.

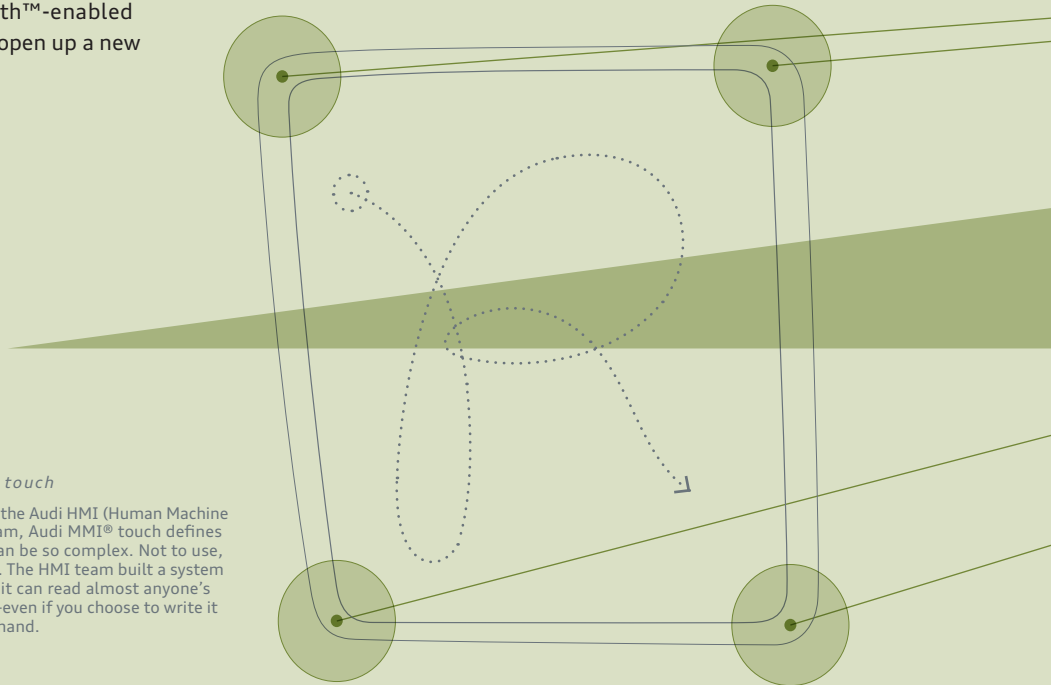

- fig. 03





- letter and number entries for destinations and contacts
- radio preset selection
- album-cover scrolling
- map scrolling
- sound distribution adjustment



.06 - Leather

Designed specifically for Audi, leather envelops the vehicle's seating surfaces, to add the right touch to your luxury interior.



## Rewriting the elements of style.

Challenging conventions is easier when you make new ones. With that in mind, our innovative design team changed the way you interact with interior appointments. It's style put to the touch. With luxurious materials, eight-way power front seats and available four-zone automatic climate control in the A6, you literally create a unique cabin environment to fit your own unique style. This is true for the smallest details too, like an optional heated steering wheel, stunning inlays, or available heated and/or ventilated front seats that help keep you comfortable so you can focus on driving.





European model shown with optional equipment.

.07 - Ventilated Seats

Optional front-seat ventilation offers multiple speeds of cooling while available heated rear seats keep everyone warm.







# quattro

Calm even when the elements aren't.



Despite what others might have you believe, it's not about power *or* control, it's about power *and* control. That's why the A6 3.0T delivers its impressive 310 hp and smooth 325 ft-lb of torque through our legendary Audi quattro® all-wheel drive system that helps grip the road. More than a bad weather security blanket, its dynamic handling and performance shine through in all seasons.

~ fig. 04

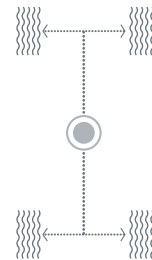

# It's time to throw the road a curve.

Audi quattro® all-wheel drive<sup>1</sup> is more than visionary engineering—it's actually a response to the conditions around our Ingolstadt headquarters. With the weather and the terrain the way they are, all-wheel drive seemed like a smart solution for the problems presented. Since they design mountain roads with hairpin turns, it's only natural that we wanted to turn the tables on the road. Here's how it works:

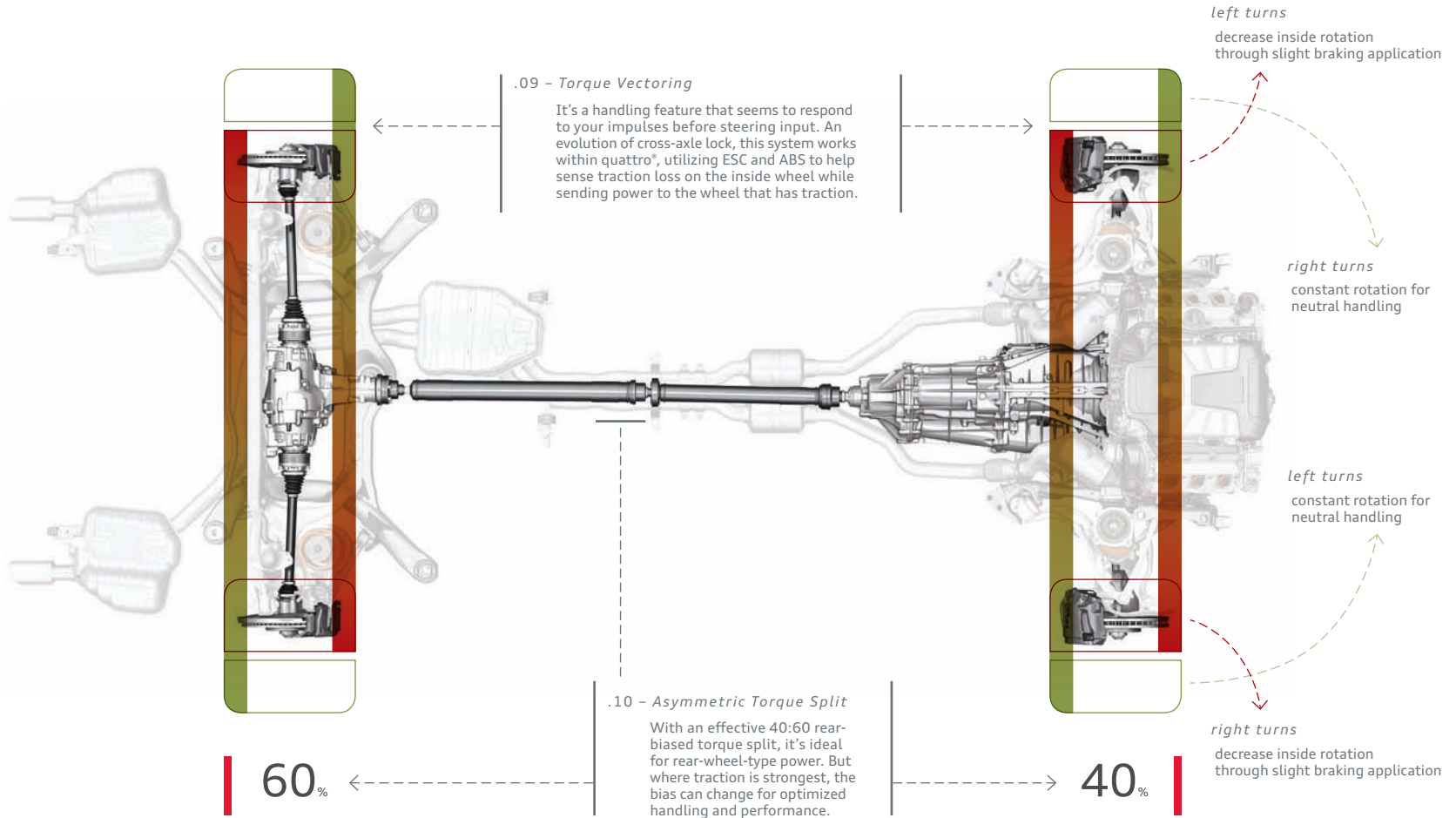



While the engineering on the A6 helps to elevate the driving profile and performance characteristics, it's not a totally refined sensibility we're after. We are a performance company as much as an engineering or luxury one. The result is intensity that uses technology to its benefit, without taking away from the visceral thrill of driving.



- peaceful
- balanced
- fun
- individualized

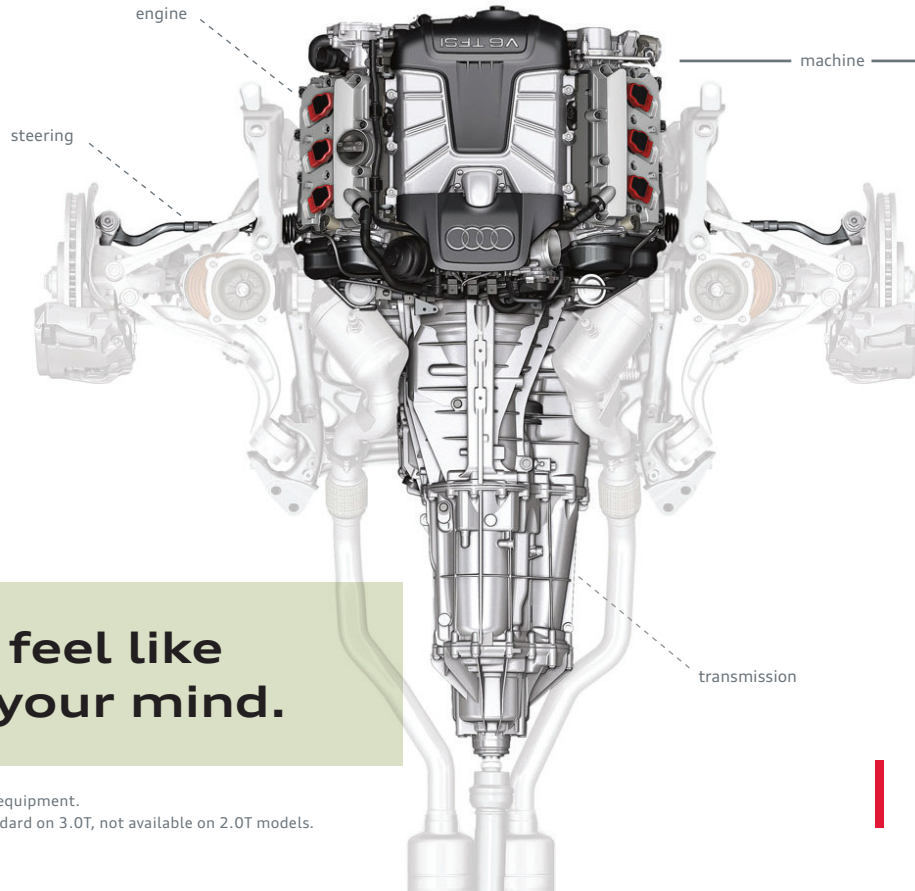

machine .11 - Audi drive select

Our drive is responsive, but we also demand that you respond to the drive. With Audi drive select, you choose Comfort, Auto or Dynamic settings that configure the engine, transmission and steering to respond to your mood or the conditions, or just to experiment with drive settings that range from outstandingly comfortable to intensely sporty.

- *comfort mode (peaceful)*  
Perfect for city streets, this setting adds optimized steering to provide a smoother drive.
- *auto mode (balanced)*  
The best of both worlds dialed to the optimal settings for a seamless combination of comfort and responsiveness.
- *dynamic mode (fun)*  
More direct steering and a more sensitive throttle give this setting an aggressive tilt.
- *individual mode (individualized)*  
Take the turn your way—this mode allows you to adjust the steering, throttle and transmission upshifts to your style.

**It might feel like  
we read your mind.**

European model shown with optional equipment.

1 Audi quattro® all-wheel drive is standard on 3.0T, not available on 2.0T models.

# With this kind of response, you might not care how efficient you've become.

This is where German engineering finds a new gear. Not content with a heritage of performance, we've developed an even more responsive and efficient way of applying power. Our revolutionary eight-speed Tiptronic® automatic transmission<sup>1</sup> with Dynamic Shift Program (DSP) helps to enhance performance while also allowing you to command upshifts or downshifts through the available steering-wheel-mounted shift paddles.

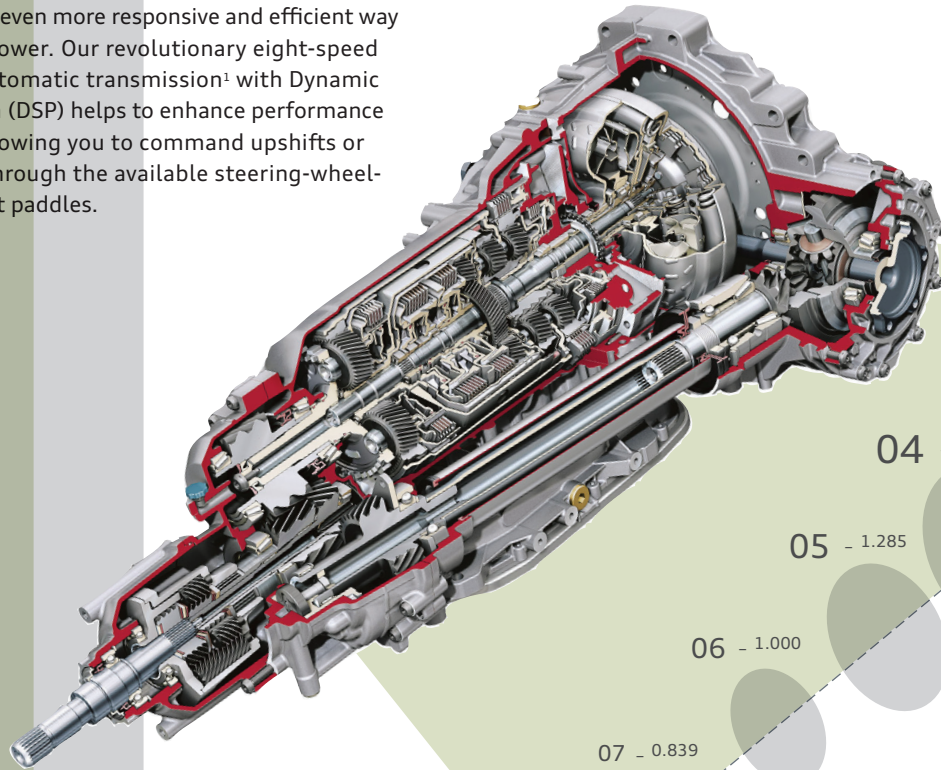

gears ——— gear ratio

01 - 4.714

02 - 3.143

03 - 2.106

04 - 1.667

05 - 1.285

06 - 1.000

07 - 0.839

08 - 0.667

.12 - Eight-speed Tiptronic®

Replacing our six-speed Tiptronic® transmission from previous generations, this will retain the smooth shifting you've come to expect, while increasing the fuel efficiency<sup>2</sup> and responsiveness of your A6 3.0T.

<sup>1</sup> Eight-speed Tiptronic® automatic transmission is standard on 3.0T, not available on 2.0T models.  
<sup>2</sup> 25 city/33 highway/28 combined mpg (2012 A6 2.0T); 19 city/28 highway/22 combined mpg (2012 A6 3.0T). EPA estimates. Your mileage will vary.

# Realize your kinetic potential faster.

We're not losing weight for looks, but because it makes us stronger and more agile. By lightening our static weight throughout our frame and our engine, we are able to harness more power more quickly—and, not incidentally, more efficiently. That means the A6 3.0T has a supercharged 3.0-liter engine that delivers the potent acceleration of a traditional V8 with the efficiency of a V6. Better mpg<sup>2</sup> and an increased heart rate. Great reasons for slimming down.

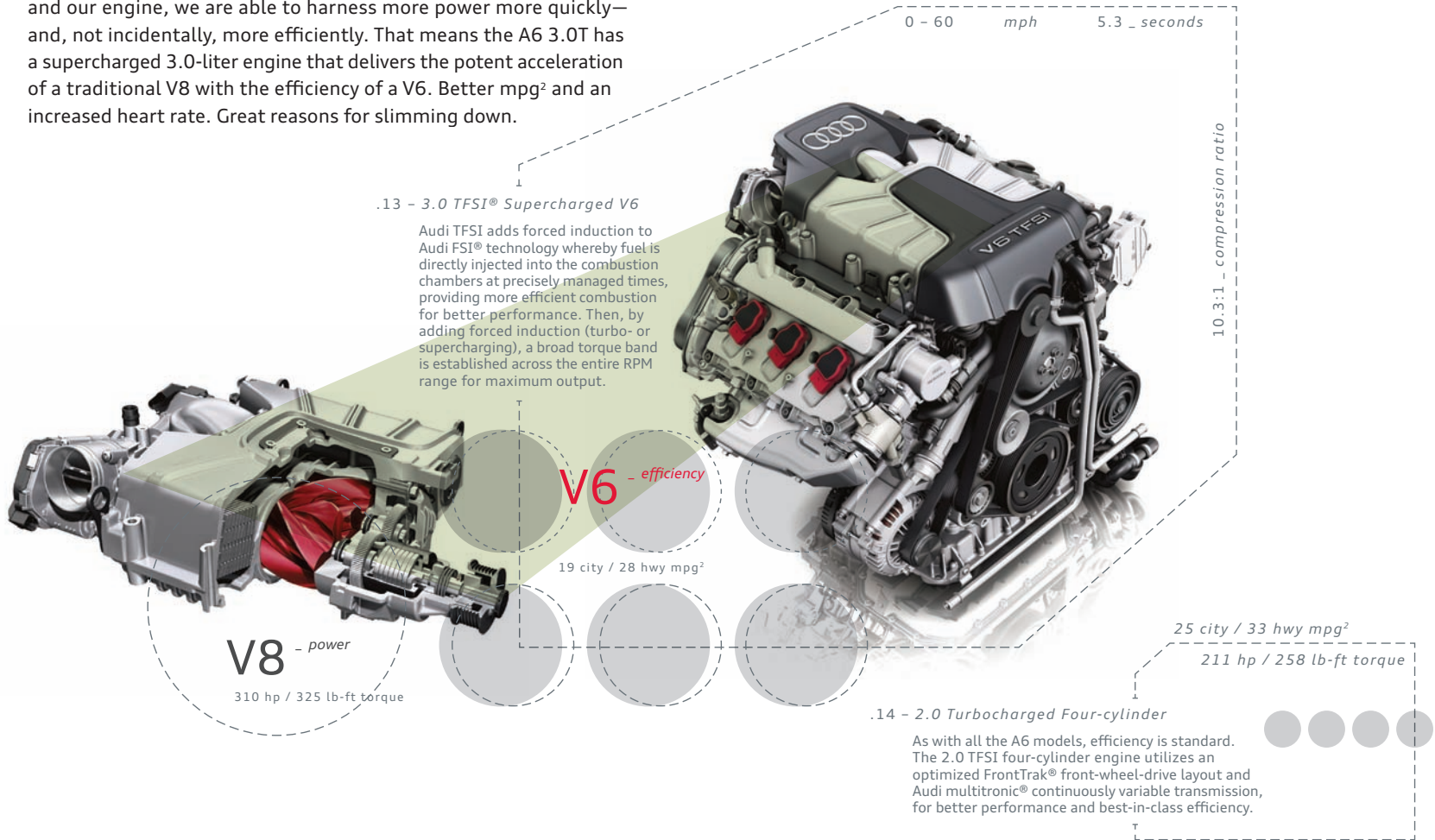



# Destined not to become a museum piece.

Yes, we talk about beauty, taste and style, but Audi doesn't build static art—we build automobiles. As much as the A6 is designed to enthrall, it is made to drive, and drive with abandon. So it doesn't make sense to us to put it on a pedestal—we encourage people to get in it and get out there and drive. Let others worry about heritage—we have the road to enjoy.

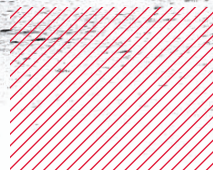





+ + 38° 57' 8.1" N  
-77° 23' 41.1" W

# No one connects you the way we do.



We set out to change how people interact in and out of their automobiles. A suite of available class-leading technologies has made the A6 a true champion for progress. Audi MMI® touch with handwriting-recognition technology, Audi Connect with Google Earth™, and Wi-Fi connectivity<sup>1</sup> for up to eight devices ensure that no other luxury automotive company offers this level of connectivity in the U.S. And with them, Audi amplifies your interactive life while simultaneously enhancing your driving experience.

38° 57' 8.1" N  
-77° 23' 41.1" W

+ +  
<sup>1</sup> Requires a data subscription plan. Distracted driving can cause a loss of vehicle control. The features and technologies discussed above are offered for convenience, and should be used only when it is safe and appropriate. The Wi-Fi hotspot feature is intended for passenger use only. Always pay careful attention to the road, and do not drive while distracted.





● **Google Earth™ with 3D satellite maps<sup>1</sup>**

With industry-first Google Earth™, you'll enjoy 3D topography and the most current maps available on your Audi MMI display.

● **Sirius Traffic™<sup>1</sup>**

Working with your Google Earth™ overlay, you can get traffic conditions and plan alternate routes to get around traffic backups.

● **Reported local gas prices<sup>1</sup>**

Find the lowest reported local price for gas—and the directions to the station—right through your MMI.

● **Google Earth™ points of interest<sup>1</sup>**

A perfect traveling companion, you can access Google® for information on points of interest near where you are—or where you are going.

● **myAudi features<sup>1</sup>**

Plan your destination from your home computer and send your route to your A6, for a preprogrammed trip plan.

● **Weather information<sup>1</sup>**

Current local conditions and forecasts for your destination can help you prepare for your trip.

● **News feeds<sup>1</sup>**

Stay on top of the news by having headlines and stories delivered right to your MMI display.

● **Mobile Wi-Fi hotspot<sup>1</sup>**

Class-first technology that provides high-speed connectivity for up to eight devices through an onboard wireless hub.

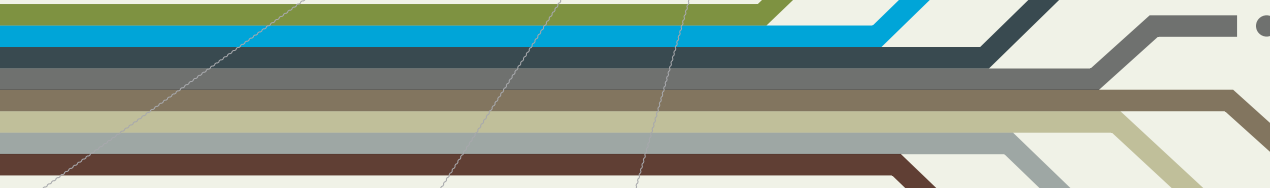

## Striking a deep note for a shared passion.

For years, while other sound-system engineers were obsessed with what they thought you should be hearing, Audi sound engineers thought about how we impact what people are feeling when they are enjoying music. We found a partner who shared our passion—Bang & Olufsen®—who has helped us conceive a new way of experiencing sounds in your A6 3.0T. We use speaker positioning and precise sound calibration to work in concert with the ambient noise in your car. The results are crisper, more resonant—you might even say, more emotional. Because, if you are only listening, you're not really feeling it.<sup>1</sup>



( Bang & Olufsen® acoustic lenses )

5.1 surround sound



.15 - Bang & Olufsen® Advanced Sound System

The passion of Bang & Olufsen® is a perfect match with Audi. By focusing on design and performance, we bring out the best in outstanding acoustics. Bang & Olufsen® engineers help to sculpt perfectly rendered sound through two innovative retractable aluminum acoustic lenses and an impressive 1,300 watts of pure power. Brilliant sound that brings out the passion in the music as much as the passion in the engineers.<sup>1</sup>

1,300 watts

( 2 of 15 speakers )



1 Bang & Olufsen® Advanced Sound System available on A6 3.0T models.

.16 - ICEpower® Amplifiers

About the size of a matchbox, this revolutionary acoustic technology from Bang & Olufsen® ensures a powerful sound base without taking up the amount of space or emitting the level of heat that conventional amplifiers do. ICEpower® amplifiers are found in the Bang & Olufsen® system available for the A6, producing supreme sound quality with a more efficient use of available power. No wonder Bang & Olufsen® and Audi complement each other so well.



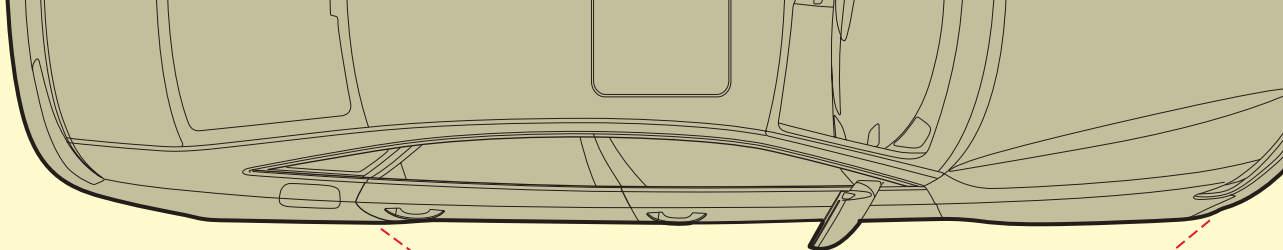

.17 - Audi side assist\*

Active at speeds over 19 mph, available Audi side assist monitors blind spots and fast-approaching vehicles at a range of 150 ft from the rear. When a vehicle is present within the monitored area, the system warns you via LED lights in the exterior mirrors.

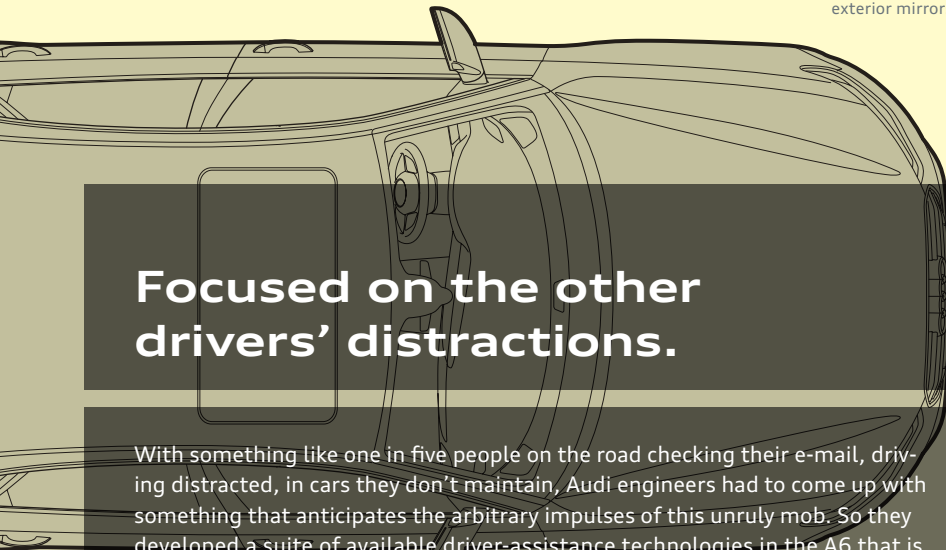

## Focused on the other drivers' distractions.

With something like one in five people on the road checking their e-mail, driving distracted, in cars they don't maintain, Audi engineers had to come up with something that anticipates the arbitrary impulses of this unruly mob. So they developed a suite of available driver-assistance technologies in the A6 that is thoughtfully comprehensive, side to side and back to front. From seemingly sentient Audi adaptive cruise control to Audi pre sense plus active collision warning and preparation, to the literally visionary night vision assistant with pedestrian detection, Audi has incorporated innovative, anticipatory technologies that don't see your future so much as help others avoid changing it.

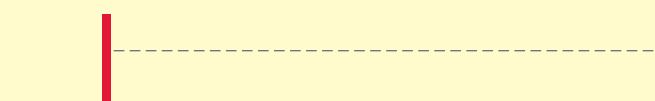
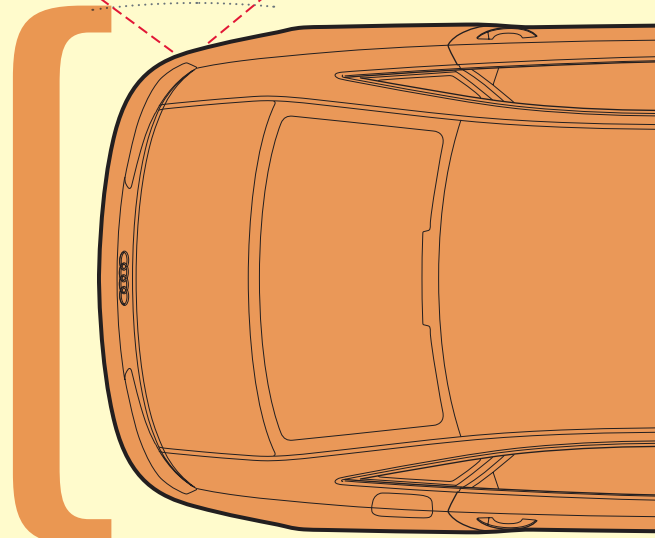

.18 - Head-up display<sup>1</sup>



Easy-to-view, accurate visual information right at eye level, displaying important driving information and even pedestrian-detection warnings.

.19 - Night vision assistant<sup>1</sup>



With an infrared camera detecting what lies ahead, the A6 uses thermal-imaging technology to help you avoid trouble. Pedestrians can be detected 300 feet in front of the vehicle, while objects can be detected up to 1,000 feet ahead—all shown on the 7" color driver information system.

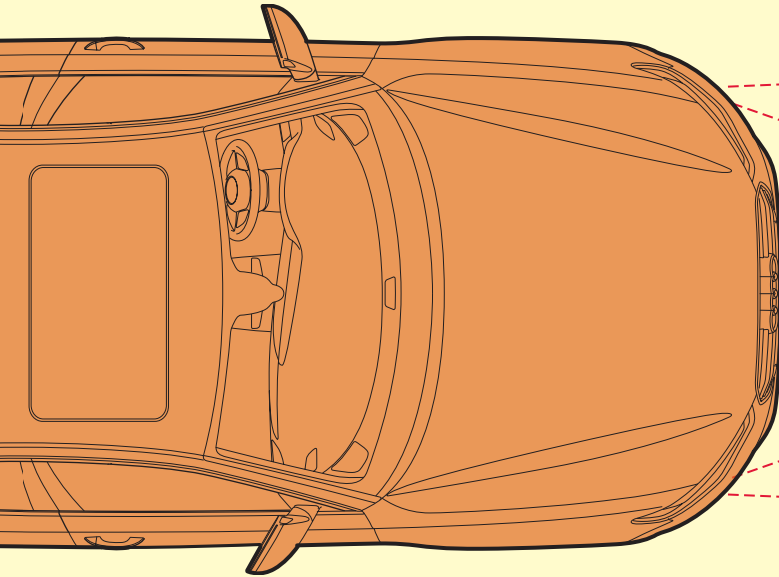

.20 - Audi adaptive cruise control with Stop and Go<sup>1</sup>

Not only retains a preset distance from vehicles ahead, but resumes acceleration when you're ready. Using long-range radar and a camera, adaptive cruise control helps read the traffic conditions and adjusts, even bringing the vehicle to a full stop before accelerating when traffic flow resumes.

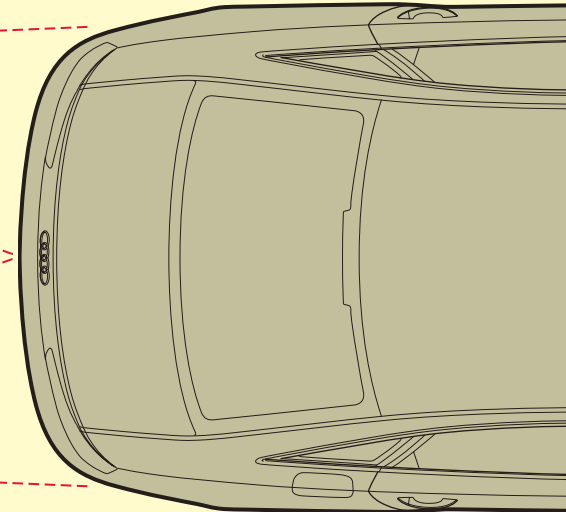

.21 - Audi pre sense plus<sup>1</sup>

Offers comprehensive driving assistance with sensors in the front, side, and rear. After visual, physical and aural collision warnings, there are four distinct phases for automatic preparation for the unavoidable: an upsurge of brake pressure, seatbelt pre-tensioning, partial braking and sunroof and window preparation. In severe cases, Audi pre sense plus will engage full braking and deceleration.

<sup>1</sup> Optional feature.

## Face it—you're surrounded.

The A6 might not be the car for you if you don't want peace of mind. Innovative safety features lead the way in Audi progressive thinking, so you can concentrate on better things, like the great performance of your A6. With up to ten airbags<sup>1</sup> helping to protect nearly every inch of the cabin, an adaptive restraint system protecting its occupants, and aluminum hybrid construction that lightens the static weight of your car to enable enhanced stopping power, Audi thinks of safety in a comprehensive way. Surrounding you with it. So you know you're not alone out there.



### .22 - ESC and ABS

Computerized technology that works in perfect sync with the Anti-lock Brake System (ABS), Electronic Stability Control (ESC) helps minimize any loss of stability, applying brake pressure to individual wheels and reducing throttle input to counter oversteer or understeer when the vehicle needs it.

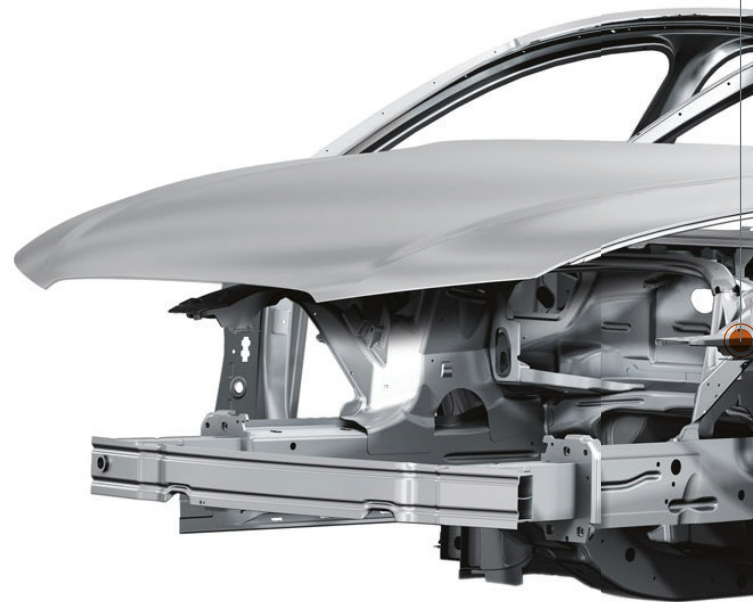

front-passenger  
knee airbag

02



- 01 knee airbag
- 02 front-passenger head airbag
- 03 front-passenger seat-mounted thorax side airbag
- 04 driver's head airbag
- 05 passenger-side Sideguard® head curtain airbag for both rows of seats
- 06 driver's knee airbag
- 07 driver-side seat-mounted thorax side airbag
- 08 passenger-side rear seat-mounted thorax side airbag<sup>1</sup>
- 09 driver-side Sideguard® head curtain airbag for both rows of seats
- 10 driver-side rear seat-mounted thorax side airbag<sup>2</sup>

### .23 - Ten Airbags

Strategically placed around the occupants, the ten available airbags in the Audi A6 offer passive safety in the event of a collision, helping to protect the driver and passengers on all sides.<sup>1</sup>



### .24 - Tailor-made Blanks

Developed to make the best possible use of the body's potential, tailor-made blanks use the special manufacturing process that helps strengthen the upper zone of a B-pillar while the lower zone is designed to mitigate the impact in the event of a side collision.

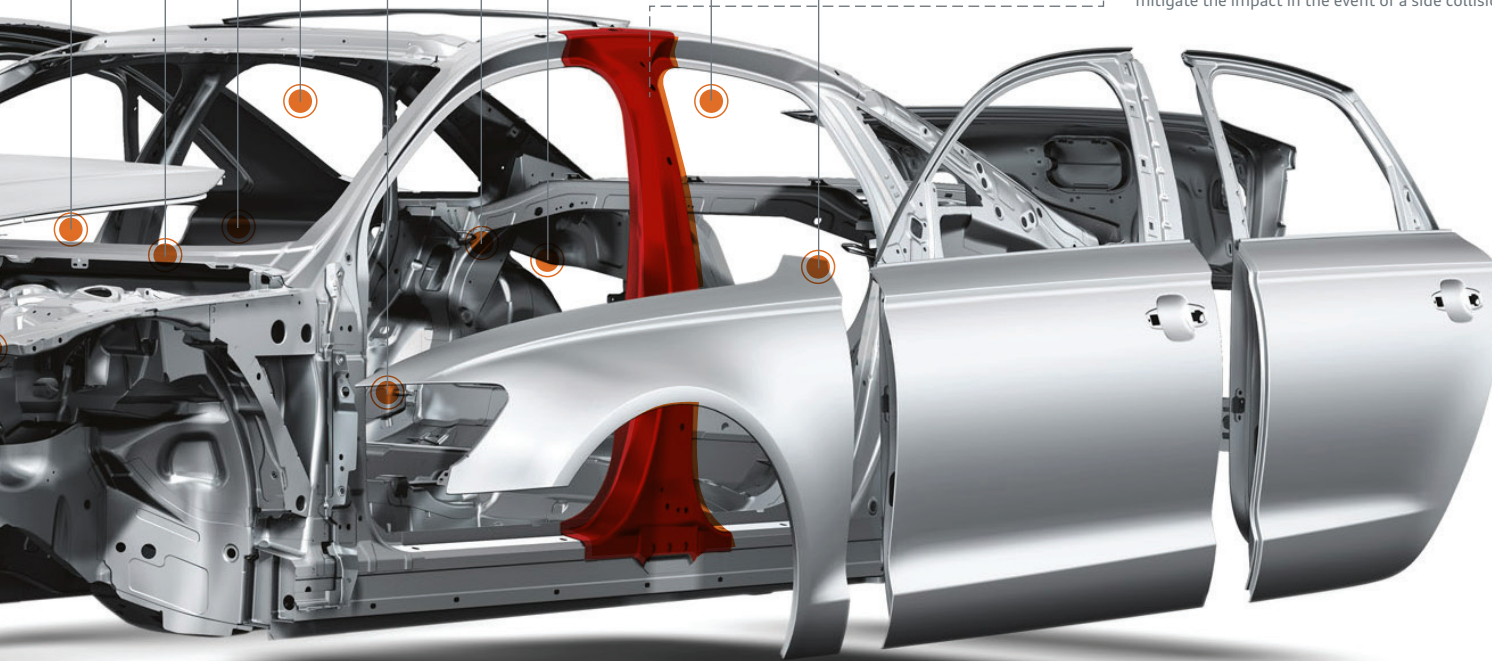

<sup>1</sup> Airbags are supplemental restraints only and will not deploy under all crash circumstances. Always use safety belts and seat children in the rear, using restraint systems appropriate for their size and age. <sup>2</sup> Optional feature.



A8

VDT 1909

S10T



## The only time you'd want this to pass you by.

Poets may someday capture the sorrow of watching an A6 pass you by when you aren't sitting in the driver's seat. But, every once in a while, it's good to emphasize the positive—at least you got to enjoy seeing its stunning LED taillights. Known for our stylish, signature headlights, Audi also takes pride in how we say goodbye to others.

.25 - LED Taillight Technology

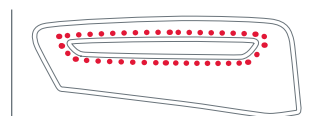

- fig. 05

Light-emitting diodes (LEDs) are more efficient than halogen lights. Better still, they last much longer. As advanced technology, they react faster than traditional bulbs, going on brighter and quicker—helping give the driver behind you more reaction time.



## Accessories

Imagine a cherry on top of your sundae. Sweet, right? Now imagine a cherry that helps protect your A6 in the garage. Or carries your bikes for a serious weekend on the trails. Or makes heads turn as you drive by. Audi Genuine Accessories are the little extras that make your Audi even sweeter. Designed by the same



### *Compact Cargo Carrier*

A trim, aerodynamic design that offers a generous 16.95-cu-ft capacity. Size: 81" long, 30" wide, 15" high.



### *Storage Cover*

A lightweight, easy-to-use Stormshield® cover helps protect your Audi from the elements. Includes a storage bag.



### *Textile Floor Mats*

These precision-fit mats are made of long-life fabric to help protect the interior of your Audi from the elements. Skid-resistant. Available in Black. Set of four mats.

*Other accessories not shown* -----

### *Various Transport Solutions*

The open road is calling—so bring all the right gear to enjoy the ride. The Audi line of storage accessories helps protect your possessions with a variety of intelligent and innovative solutions. Choose from bike racks, ski racks and a variety of cargo carriers.

1 See dealer for details.

visionaries who designed your vehicle, all accessories feature a tailored fit and the expert craftsmanship you'd expect from Audi. They are also backed by the 4-year/50,000-mile Audi New Vehicle limited warranty, or a 12-month/12,000-mile limited warranty, whichever is greater.<sup>1</sup>



#### *20" Diversas Alloy Wheels*

Add to the already striking look of your A6 with the addition of the boldly designed 20" Diversas alloy wheels.



#### *A6 Base Carrier Bars*

Attached to strong side brackets, these are the durable foundation of the Audi roof-rack system. (All roof-rack system attachments require the base carrier bars. All attachments sold separately.)



#### *Splash Protectors*

Help protect your exterior finish with custom-fit front and rear splash protectors. Made of long-life, crack-resistant rubber. Available in sets of two for front or rear (not available on A6 3.0T Prestige models).

#### *Various Comfort and Protection Solutions*

Audi Genuine Accessories offer a wealth of practical aids for more space, tidiness and safety on board with functional items to help keep your Audi in pristine condition. Use them all to help reduce wear and tear on your Audi and help keep it looking like new—inside and out.

#### *Car Care*

Use the only car care line specifically designed with your Audi vehicle in mind. Audi Guard car care products provide gentle cleansing formulas and special tools to help give interior and exterior surfaces the finest in cleaning and protection.

#### *Various Electronic Accessories*

The many electronic accessories in your Audi are renowned for design that emphasizes user experience. All products are tested to help ensure compatibility with your vehicle's electrical systems so that you can easily enjoy what Audi technology has to offer.

# Colors

Ibis White

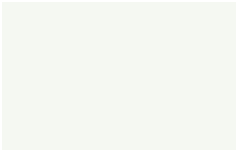

Ice Silver metallic

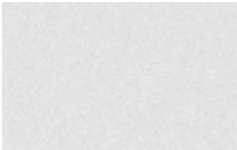

Quartz Gray metallic

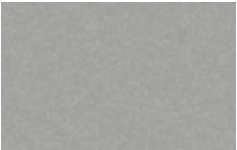

Dakota Gray metallic



Oolong Gray metallic



Moonlight Blue metallic



Brilliant Black



Phantom Black pearl



Garnet Red pearl



exterior  
interior

Black



Nougat Brown

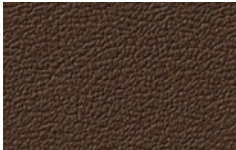

Titanium Gray

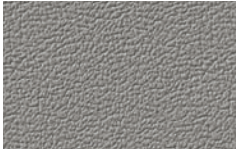

Velvet Beige





# Color Combinations

	exterior								
interior	Ibis White	Ice Silver metallic	Quartz Gray metallic	Dakota Gray metallic	Oolong Gray metallic	Moonlight Blue metallic	Brilliant Black	Phantom Black pearl	Garnet Red pearl
Black	■	■	■	■	■	■	■	■	■
Nougat Brown	■	■	■	■	■	■	■	■	—
Titanium Gray	■	■	■	—	■	■	■	■	■
Velvet Beige	■	—	■	■	■	■	■	■	■

■ Available combination

— N/A



## Decorative Inlays



Brushed Aluminum  
inlay optional



Dark Brown Walnut Wood  
inlay optional



Natural Brown Fine Grain  
Ash Wood inlay optional

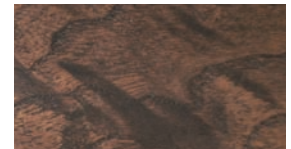



Shown with Natural Brown Fine Grain Ash Wood inlay.



# Wheels

17" 10-spoke design  
225/55 all-season tires



A6 Premium

18" 5-arm design  
245/45 all-season tires



A6 Premium Plus

18" 5-V-spoke design  
245/45 all-season tires



A6 Prestige (3.0T only)

18" 5-twin-spoke design  
245/45 all-season tires



18" Sport Package

19" 15-spoke star design  
255/40 summer performance tires<sup>1</sup>



19" Sport Package  
Premium Plus  
Prestige (3.0T only)

20" 10-spoke V design  
255/35 summer performance tires<sup>1</sup>



20" Sport Package  
Prestige (3.0T only)

<sup>1</sup> Tires are supplied and warranted by their manufacturer. High-performance tires are designed for optimum performance and handling in warm climates. They are not suitable for cold, snowy, or icy weather conditions. If you drive under those circumstances, you should equip your vehicle with all-season or winter tires, which offer better traction under those conditions. We suggest you use the recommended winter or all-season tire specified for your car or its equivalent. These high-performance tires also have a lower aspect ratio that aids performance and handling; however, in order to avoid tire, rim or vehicle damage, it is important that the inflation pressure is regularly checked and maintained at optimum levels. Please also remember in making your selection that, while these tires deliver responsive handling, they may ride less comfortably and make more noise than other choices. Finally, these tires may wear more quickly than other choices.

# Configurations | Dimensions

A6 2.0T Premium  
 A6 2.0T Premium Plus  
 A6 3.0T Premium  
 A6 3.0T Premium Plus  
 A6 3.0T Prestige

## A6 Models

	A6 2.0T Premium	A6 2.0T Premium Plus	A6 3.0T Premium	A6 3.0T Premium Plus	A6 3.0T Prestige
2.0T with Audi multitronic® continuously variable transmission and FrontTrak® front-wheel drive	■	■	—	—	—
3.0T with eight-speed Tiptronic® automatic transmission and Audi quattro® all-wheel drive	—	—	■	■	■

## Power and Performance

2.0-liter turbocharged: Intercooled, DOHC four-cylinder gasoline engine with Audi TFSI® direct injection, variable valve timing and valvelift system. Horsepower: 211 hp @ 6,500 rpm / Torque: 258 lb-ft @ 3,250 rpm	■	■	—	—	—
3.0-liter supercharged: Dual intercoolers, DOHC V6 gasoline engine with Audi TFSI® direct injection and variable valve timing. Horsepower: 310 hp @ 5,500–6,500 rpm / Torque: 325 lb-ft @ 2,900–4,500 rpm	—	—	■	■	■

■ Standard    — N/A

## Exterior Dimensions

Length: 193.9"	Track, front: 64.1"
Width: 73.8"	Track, rear: 63.7"
Height: 57.8"	Wheelbase: 114.7"

## Interior Dimensions

Head room: 37.2" (front) 37.8" (rear)	Shoulder room: 57.5" (front) 56.3" (rear)
Leg room: 41.3" (front) 37.4" (rear)	EPA cargo volume: 14.1 cu ft

## Fuel Economy Estimates, City / Highway / Combined

A6 2.0T: 25 / 33 / 28	A6 3.0T: 19 / 28 / 22
-----------------------	-----------------------

See [www.fueleconomy.gov](http://www.fueleconomy.gov) for EPA estimates. Your mileage will vary.

## Weights and Capacities

Curb weight (2.0T / 3.0T): 3,682 lb / 4,045 lb
Engine oil capacity (2.0T / 3.0T): 5.9 qt / 7.2 qt
Fuel tank capacity: 19.8 gal

# Specifications

A6 2.0T Premium  
A6 2.0T Premium Plus  
A6 3.0T Premium  
A6 3.0T Premium Plus  
A6 3.0T Prestige

## Chassis | Technical

Aluminum hybrid construction—aluminum exterior body panels and a steel frame	■	■	■	■	■
Five-link front suspension with upper and lower control arms with stabilizer bar	■	■	■	■	■
Trapezoidal-link rear suspension with stabilizer bar	■	■	■	■	■
Sport suspension calibration	□	□	□	□	□
Audi servotronic® speed-sensitive power steering—varies assistance based on vehicle speed	■	■	■	■	■
Audi quattro® all-wheel drive system utilizing self-locking center differential—40:60 rear-biased torque split	—	—	■	■	■
FrontTrak® front-wheel drive	■	■	—	—	—
Eight-speed Tiptronic® automatic transmission	—	—	■	■	■
Audi multitronic® continuously variable transmission	■	■	—	—	—

## Safety | Security

Driver and front passenger dual-stage airbags, thorax side airbags and Sideguard® head curtain airbags <sup>1</sup>	■	■	■	■	■
Driver and front passenger knee airbags <sup>1</sup>	■	■	■	■	■
Rear-passenger thorax side airbags <sup>1</sup>	□	□	□	□	□
Front passenger occupant detection—for airbags	■	■	■	■	■
Safety belt reminder for driver and front passenger	■	■	■	■	■
Lower Anchors and Tethers for CHildren (LATCH) in rear seats	■	■	■	■	■
Power central locking system with safety unlock feature if airbags deploy	■	■	■	■	■
Electronic Stability Control (ESC) with traction control (ASR)	■	■	■	■	■
Anti-lock Brake System (ABS) with Electronic Brake-pressure Distribution (EBD) and brake assist	■	■	■	■	■
Front ventilated disc brakes	■	■	■	■	■
Rear disc brakes	■	■	—	—	—
Rear ventilated disc brakes	—	—	■	■	■
Electromechanical parking brake	■	■	■	■	■

■ Standard    □ Optional    — N/A



## Infotainment | Technology

	A6 2.0T Premium	A6 2.0T Premium Plus	A6 3.0T Premium	A6 3.0T Premium Plus	A6 3.0T Prestige
Audi MMI® Navigation plus with voice control system	—	■	—	■	■
Audi MMI® touch with handwriting-recognition technology	—	■	—	■	■
Audi Connect with six-month trial subscription	—	■	—	■	■
7" color driver information system	—	■	—	■	■
Audi MMI® Radio plus with ten speakers and single CD player with MP3 playback capability	■	■	■	■	—
BOSE® sound system with 14 speakers, AudioPilot® noise-compensation and 630 watts	—	—	—	—	■
Bang & Olufsen® Advanced Sound System with 15 speakers and 1,300 watts	—	—	—	—	□
HD Radio™ technology	—	■	—	■	■
Sirius Traffic™ with 90-day trial subscription	—	■	—	■	■
SiriusXM™ Satellite Radio with 90-day trial subscription	■	■	■	■	■
Audi music interface with iPod® integration	■	■	■	■	■
Six-disc CD changer	—	■	—	■	■
BLUETOOTH® wireless technology preparation for mobile phone	■	■	■	■	■
HomeLink® remote transmitter	■	■	■	■	■
Keyless Start	■	■	■	■	—
Audi advanced key—keyless start, stop and entry	—	—	—	—	■
Cruise control with coast, resume and accelerate features	■	■	■	■	■
Audi adaptive cruise control with Stop and Go function	—	—	—	□	□
Audi side assist and Audi pre sense rear	□	□	□	□	□
Audi pre sense plus—includes Audi pre sense rear	—	—	—	□	□
Night vision assistant with pedestrian detection and head-up display	—	—	—	—	□
Audi drive select	■	■	■	■	■
Parking system with front and rear sensors	—	■	—	■	■
Rain/light sensors for automatic windshield wipers and headlights	■	■	■	■	■

1 Airbags are supplemental restraints only and will not deploy under all crash circumstances. Always use safety belts and seat children only in the rear, using restraint systems appropriate for their size and age.

# Specifications

A6 2.0T Premium  
A6 2.0T Premium Plus  
A6 3.0T Premium  
A6 3.0T Premium Plus  
A6 3.0T Prestige

## Exterior

Audi Singleframe® grille	■	■	■	■	■
Halogen headlights with daytime running lights	■	–	■	–	–
Xenon plus headlights with LED daytime running light technology	–	■	–	■	–
Adaptive xenon plus headlights with LED daytime running light technology and cornering lights	–	–	–	–	■
Full LED headlight technology	–	–	–	–	□
Automatic headlights	■	■	■	■	■
LED taillight technology	■	■	■	■	■
Power-adjustable, heated side mirrors with memory	■	–	■	–	–
Power-adjustable, auto-dimming, heated side mirrors with memory	–	■	–	■	■
Power-adjustable, power-folding, auto-dimming, heated side mirrors with memory	□	□	□	□	□
LED turn indicator light technology integrated in the side mirrors	■	■	■	■	■
Chrome trim around exterior windows	■	■	■	■	■
Dual exhaust pipes with chrome tip	■	■	■	■	■
Audi S line® exterior appearance	–	–	–	–	■

## Interior

Three-zone automatic climate control	■	■	■	■	–
Four-zone automatic climate control	–	–	–	–	■
Four-spoke multifunction steering wheel	■	■	■	■	■
Three-spoke multifunction steering wheel with shift paddles	□	□	□	□	□
Heated steering wheel	□	□	□	□	□
Tilt and telescopic manually adjustable steering column	■	■	■	■	–
Power tilt and telescopic steering column with memory	–	–	–	–	■
Black cloth headliner	□	□	□	□	□
Leather seating surfaces (perforated on models with ventilated seats)	■	■	■	■	■
Eight-way power front seats and four-way power lumbar adjustment for driver	■	■	■	■	■
Heated front seats	□	□	■	■	■
Ventilated front seats	–	–	–	–	■
Heated rear seats	□	□	□	□	□
Driver seat memory	■	■	■	■	■
Folding rear seat with pass-through	■	■	■	■	■
Dual front sun visors with lighted vanity mirrors	■	■	■	■	■
Power windows with one-touch up/down operation and pinch protection	■	■	■	■	■
Sunroof	■	■	■	■	■

A6 2.0T Premium  
A6 2.0T Premium Plus  
A6 3.0T Premium  
A6 3.0T Premium Plus  
A6 3.0T Prestige

# Packages | Options

A6 2.0T Premium  
 A6 2.0T Premium Plus  
 A6 3.0T Premium  
 A6 3.0T Premium Plus  
 A6 3.0T Prestige

## Packages

<b>Innovation Package:</b> Audi adaptive cruise control with Stop and Go function, Audi side assist, Audi pre sense plus, night vision assistant with pedestrian detection and head-up display, full LED headlight technology, and power-adjustable, power-folding, auto-dimming, heated side mirrors with memory	–	–	–	–	□
<b>Driver Assistance Package:</b> Audi adaptive cruise control with Stop and Go function, Audi side assist, Audi pre sense plus, and power-adjustable, power-folding, auto-dimming, heated side mirrors with memory	–	–	–	□	□
<b>Cold Weather Package:</b> Heated steering wheel, heated front seats (2.0T) and heated rear seats	□	□	□	□	□
<b>18" Sport Package:</b> 18" 5-twin-spoke design alloy wheels, sport suspension calibration, and three-spoke multifunction steering wheel with shift paddles	□	□	□	□	□
<b>19" Sport Package:</b> 19" 15-spoke star design alloy wheels, summer performance tires <sup>1</sup> ; sport suspension calibration, and three-spoke multifunction steering wheel with shift paddles	–	□	–	□	□
<b>20" Sport Package:</b> 20" 10-spoke V design alloy wheels with anthracite/part-polished finish, summer performance tires <sup>1</sup> ; sport suspension calibration, and three-spoke multifunction steering wheel with shift paddles	–	–	–	–	□

## Individual Options

Full LED headlight technology	–	–	–	–	□
Bang & Olufsen® Advanced Sound System with 15 speakers and 1,300 watts	–	–	–	–	□
Audi side assist, Audi pre sense rear, and power-adjustable, power-folding, auto-dimming, heated side mirrors with memory	□	□	□	□	□
Black cloth headliner	□	□	□	□	□
Natural Brown Fine Grain Ash Wood inlays	□	□	□	□	□
Dark Brown Walnut Wood inlays	□	□	□	□	□
Brushed Aluminum inlays	□	□	□	□	□
Rear-passenger thorax side airbags <sup>2</sup>	□	□	□	□	□

## Innovation Package Highlights



## Cold Weather Package Highlights



## Individual Option Highlights



<sup>1</sup> See wheels page of this brochure for important safety information regarding summer performance tires. <sup>2</sup> Airbags are supplemental restraints only and will not deploy under all crash circumstances. Always use safety belts and seat children only in the rear, using restraint systems appropriate for their size and age.



# A6

2012 | A6

Audi of America  
Audiusa.com  
Facebook.com/Audi

AoA1211867

Note: A word about this brochure. Audi of America, Inc., believes the specifications in this brochure to be correct at the time of printing. However, specifications, standard equipment, options, and colors are subject to change without notice. Some equipment may be unavailable when your vehicle is built. Please ask your dealer for advice concerning current availability of standard and optional equipment, and your dealer will verify that your vehicle will include the equipment you ordered. Vehicles in this brochure are shown with optional equipment. See your dealer for complete details on the new-vehicle limited warranty, twelve-year limited warranty against corrosion perforation, and Audi 24/7 Roadside Assistance [Roadside assistance coverage provided by Road America in the U.S. Certain conditions apply; see your dealer for details.] Tires supplied by various manufacturers. "Audi," all model names, "FrontTrak," "FSI," "MMI," "multitronic," "quattro," "Sideguard," "S line," "Singleframe" and the Singleframe grille design, "TFSI," "Truth in Engineering," and the four rings logo are registered trademarks of AUDI AG. "Bang & Olufsen" is a registered trademark of Bang & Olufsen. The BLUETOOTH word mark and logos are owned by the Bluetooth Sig, Inc., and any such marks by AUDI AG is under license. "BOSE" and "AudioPilot" are registered trademarks of the Bose Corporation. "Google" and "Google Earth mapping service" are trademarks of Google Inc. "HD Radio" and the HD Radio logo are proprietary trademarks of iBiquity Digital Corporation. "HomeLink" is a registered trademark of Johnson Controls Technology Company. "iPod" is a registered trademark of Apple Computer. "Servotronic" is a registered trademark of AM General Corporation. "Sirius" and all related marks and logos are trademarks of SiriusXM Radio Inc. and its subsidiaries. "Stormshield" is a registered trademark of Guilford Mills, Inc. "Tiptronic" is a registered trademark of Dr. Ing. hc F. Porsche AG. All other trademarks are the property of their respective owners. Some European models shown. Some features may not be available at time of order.

© 2011 Audi of America, Inc.