



A8

Audi A8 | A8 L | A8 L W12

Audi
Truth in Engineering





.01 - Full LED Headlight Technology

Intense, reliable, and unmistakable, the optional full LED headlights use the illuminating precision and stylish flexibility of LED lighting technology.



There's a new class of flagship.

As the finest sedan to wear the four rings, the Audi A8 represents a step up in class. At the pinnacle of prestige, it exudes progress. Perhaps it's best to think of the A8 as luxury unshackled from traditional expectations. Which is why, along with Audi engineering and design expertise, the A8 offers new technological possibilities, to better connect the driver to the drive while others seem to stand still. There are notable Audi touches, like Audi quattro® all-wheel drive, brilliantly iconic LED lighting technology and a quality of finish unequalled in the industry. But it goes further. All told, it represents what's possible when a company steps past tradition to create something of stature that still appeals to those with a sense of adventure.



.02 – ASF® Aluminum Space Frame

The exclusive lightweight design of ASF technology offers a number of significant advantages over traditional steel construction, as its proven weight savings help improve structural rigidity and performance on the road.

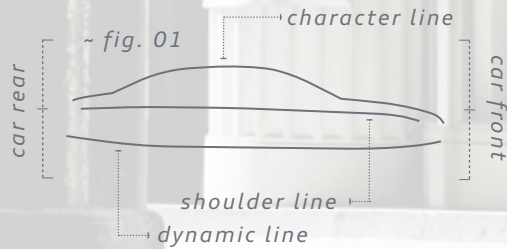

.03 – Design Lines

The design of the A8 delivers status with dynamism, sportiness with elegance. From its Dynamic line that brings the vehicle closer to the road to the signature flow of its Character line, the A8 is an uncompromised expression of singular stature and luxurious style.

~ fig. 02



.04 – Solar Sunroof

The optional solar sunroof supplies power to the climate control system to vent air and reduce interior temperatures by circulating fresh air while the ignition is off.



An executive decision has been made.

The Audi A8 L executive-class sedan doesn't just make an assured statement of confidence—it expands on it in considerable detail. With a longer wheelbase that adds more rear space, the A8 L was conceived with the comfort of rear passengers in mind, providing them with the space to tailor their environment to their own requirements. Available rear-seat comforts include a relaxation seat that features massage functionality, power sunshades for the rear and side windows, as well as a full complement of technology and entertainment choices through dual 10" monitors for each rear seat. But the A8 L offers far more. With a 372-hp V8, it delivers a smooth ride and sporty driving characteristics. With Audi connect™ information delivery and Wi-Fi hotspot capabilities, it can turn the cabin into a mobile workstation for passengers.¹ With traditional Audi craftsmanship, it recasts executive prestige for those certain about what they want out of luxury.

A8 L W12

A tradition, refined.

The twelve cylinders that deliver refined power make the Audi A8 L W12 the elite among the elite. Building on the achievements of previous generations, the W12 represents a new pinnacle in engineering. It's not just power, although with Audi FSI® empowering a 6.3-liter W12 engine, producing 500 hp and 463 lb-ft of torque, it is that too, but it's how that power is felt by the driver. As delivered through Audi quattro®—the only permanent all-wheel drive offered in the twelve-cylinder luxury segment—and rear-biased torque distribution, the ride is smooth, the handling true and acceleration never less than memorable. With an aluminum-silicon alloy reducing the engine weight, a larger displacement ramping up the response and improved efficiency¹; the new W12 has built on the Audi heritage of engineering and further refined it, setting the W12 apart from just about anything on the road.



¹ See www.fueleconomy.gov for EPA estimates. Your mileage will vary.



A silver Audi A8 is shown from the rear passenger side, driving on a paved road. The background features a blurred landscape with green trees and a body of water under a bright sky, suggesting motion and a scenic drive.

A8

You already know power. This should make you feel at home.

The Audi A8 is, in every stitch, the epitome of luxury. In our materials, in our finishes, in our technology, we take great care to craft a vehicle worthy of the name flagship. But don't mistake refinement for staid. Featuring our lightweight ASF® aluminum space frame, a 372-hp V8, Audi adaptive air suspension and Audi quattro® all-wheel drive, power is expressed with an effortless flourish. Driving dynamics are further enhanced with Audi drive select. Put the A8 in Dynamic mode and discover the precise steering, taut suspension and quick throttle response of a sports sedan. Or choose the Comfort setting, perfect for smooth driving on less than perfect streets. A8 performance is crafted for those comfortable with power—and how to wield it.



It's easy to provoke a response. The trick is to evoke an emotion.

Designed to satisfy the driver that demands every detail be thoroughly examined, the Audi A8 is built to be the new benchmark for progressive design. Matching luxury with sportiness, commanding presence with sophistication, the A8 announces its arrival with Audi signatures like the Singleframe® grille with chrome struts and the iconic shape and illumination of adaptive xenon plus headlights. It says farewell with a sculpted coupe-like rear and stunning LED taillights, to give onlookers something to remember as it passes. It may be the emotion we evoke is envy.



.05 - Sport Package

For those looking to take the gloves off. The available Sport Package infuses athleticism by providing enhancements such as sport-tuned Audi adaptive air suspension, 20" 5-segment-spoke design alloy wheels with summer performance tires,¹ and a sports differential, allowing you to test the limits of this specimen—if there are any.

¹ See Wheels page of this brochure for important safety information regarding summer performance tires.

.06 - LED Taillight Technology

Light-emitting diodes (LEDs) are more efficient than traditional bulbs. Better still, they last much longer. As advanced technology, they react faster than traditional bulbs, going on brighter and quicker—helping give the driver behind you more reaction time.



~ fig. 03

.07 - Power Trunk Open/Close

For added convenience, an available power trunk with open/close feature ensures that the trunk lid closes securely with ease.

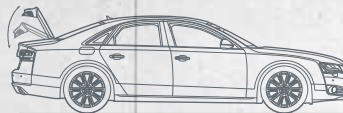

~ fig. 04



.08 - Power Soft-closing Doors

Simply pull the door toward you and let it fall lightly into the latch. The Audi A8 does the rest, as available power soft-closing doors utilize an electric actuator that closes the door flush automatically.



.09 - *Valcona Leather*

Soft and obsessively processed for comfort, this special grain of available leather, unique to Audi interiors, gives the Audi A8 a sumptuously modern, irresistible feel that demands to be felt.

Rewriting the elements of style.



Spacious design and dedicated craftsmanship are hallmarks of the Audi A8 interior. You feel the space with the wraparound curve of the door through the dash, which helps frame your driving environment. You feel the craftsmanship in the highest standards of materials and finishes. Once seated, you'll notice that first-class comfort envelops you—everything from an available four-zone automatic climate control system to the unique design of the gearshift lever which helps your hand rest while you control the Audi MMI®. It's the comprehensive attention to your needs—and the anticipation of them—which changes the definition of style, from form to something deeper.

.10 - *Ventilated Seats*

Breathe easier with available front and rear-seat ventilation that offers multiple speeds of cooling, helping provide total comfort throughout your drive.



A painstaking dedication to your comfort.

The quality of workmanship in the Audi A8 is evident from the craftsmanship in our technologies: difficult to implement but easy to enjoy. With standard, 18-way adjustable seats and available 22-way comfort front seats, we show our inordinate dedication to your comfort. This, for Audi engineers, is truly a labor of love. We spend as long as it takes to provide you with a more comfortable and enjoyable ride. To us, that's time well spent.

22



.11 - Full Leather Package

This available package adds an Alcantara® headliner and leather onto the center console, knee rests, door armrests, and airbag cap to enhance the feel of the interior aesthetic of the A8.

.13 - Ventilated Front Seats with Massage Function

Available front seat ventilation offers multiple speeds of cooling, while its massage function helps soothe the body during extended drives.

.12 - 22-way Comfort Seats

Adding to the plush interior of the Audi A8 is the available 22-way driver and front passenger comfort seats that offer lumbar support, ventilation and massage functions.

.14 - Panoramic Sunroof

The optional two-panel panoramic sunroof offers both the front and rear passengers an unobstructed view overhead while flooding the cabin with natural light. And when you decide you need to say goodbye to the sun, a power sunshade is there to make it an easy task.



Luxury, whatever your perspective.

No matter where you sit, the Audi A8 L with a choice of available rear seat packages looks like the poster child for luxury. Side to side, front to rear, the expansive interior of the A8 L includes the kind of thoughtful details, matchless materials and overall sophistication that define your experience when driving in it. Genuine wood inlays, evocative ambient lighting, handcrafted finish throughout—all to create an exclusive atmosphere for a singular sanctuary.

.16 - Power Rear Side Sunshades

Enjoy your right to privacy in the A8 L with power rear side sunshades that help keep out natural and social elements.



.15 - Executive Rear Seating

The available A8 L Executive Rear Seat Package adds a level of personalized comfort to the new benchmark in executive luxury. Power rear single seats with massage functions help provide sumptuous relaxation. While a fixed leather-covered rear center console and Rear Seat Entertainment with dual 10" screens provide comfort while creating a mobile business or pleasure center. This package also features a small refrigerator between rear seats as well as rear-seat ventilation.

.18- *Dual 10" Screens*

This available feature is mounted on the back of the front seats. It affords each rear passenger access to their own media controls, located on the center armrest.



.17 - *Rear Seat Table*

Featured within the A8 L Executive Rear Seat Package, this elegant workstation is stationed next to rear-seat climate and entertainment controls, making it an excellent productivity hub.



Because we know you're the type who likes to stay in control.

To fully appreciate power, there has to be some measure of control. Control helps articulate the feel of it, helps to define its potential and helps you know how far you can take it. Power, as delivered in the A8, is expressed with a host of dynamic technologies, centering around Audi quattro® all-wheel drive. Audi quattro® helps deliver power and maximize performance in almost any conditions while helping you maintain control. When combined with other performance technologies, it's clear that the A8 doesn't want to hold you back, but rather stay on top of the power you possess.



.19 - Sports Differential

The available sports differential dynamically varies torque between its rear wheels to help enhance agility when cornering.



.20 - Audi quattro®

The legendary intelligent all-wheel drive system utilizes a self-locking center differential to transfer power where it is needed most. Under normal driving conditions, 40 percent of driving force is directed to the front wheels, and the remaining 60 percent is directed to the rear wheels. The result is a near-perfect driving balance. If conditions warrant a change, the self-locking center differential is capable of sending a majority of engine power to the axle with the most traction.

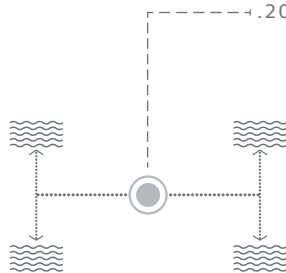

~ fig. 05

quattro



Harmony begins with balance.

There are moments when you drive where everything feels in perfect sync. You make the green lights. The traffic opens up and the highway is yours. The local road with the sharp turns seems to bend to your will. The next time that happens, notice the driving dynamics of your A8—you'll find all the systems are in equilibrium, engineered for you to fully take advantage of conditions to produce a drive that is powerful, exhilarating and balanced. Audi engineers designed the driving dynamics in the A8 to react to a dizzying array of driving forces as they come. All of it focused on one result, producing the kind of superior, personally tuned ride for the driver that makes them want to get back behind the wheel again immediately.

.21 - Audi Adaptive Air Suspension

Through air suspension and a continuously variable, electronically controlled damper system, Audi adaptive air suspension automatically optimizes load distribution and senses driving conditions, to produce a balanced, comfortable and dynamic drive.

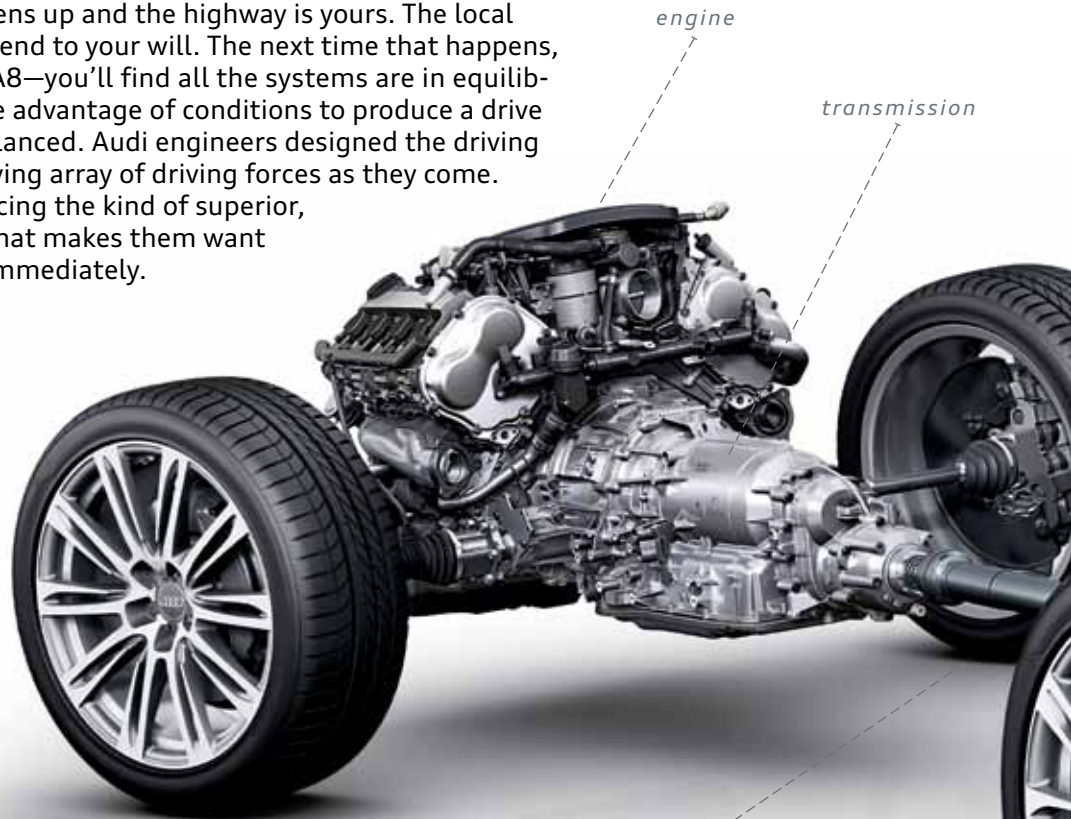
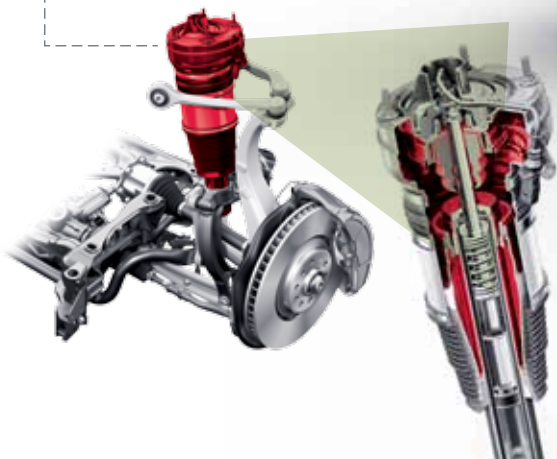

engine

transmission

40%

.22 - Asymmetric Torque Split

With an effective 40:60 rear-biased torque split, it's ideal for rear-wheel-type power delivery. But where traction is strongest, the bias can change for optimized handling and performance.

60%

.23 - Audi Drive Select

Exclusive to Audi, this system provides advanced control of the vehicle's adaptive suspension, optional dynamic steering, sports differential, transmission shift characteristics and engine response. It offers distinct driving configurations, allowing drivers to configure vehicle drive characteristics to their liking with their choice of Comfort, Auto, Dynamic or Individual settings.



- you —
- peaceful
 - balanced
 - fun
 - customized

- *comfort mode (peaceful)*

Perfect for bumpy city streets, this setting adds optimized steering and comfortable adaptive air suspension, to help provide a smoother drive.

- *auto mode (balanced)*

The best of both worlds dialed to the optimal settings for a seamless combination of comfort and handling.

- *dynamic mode (fun)*

More direct steering, more sensitive throttle and sporty suspension helps give this setting an assertive tilt.

- *individual mode (customized)*

This mode will adjust the steering, suspension throttle and transmission to fit your style, automatically.



sports differential

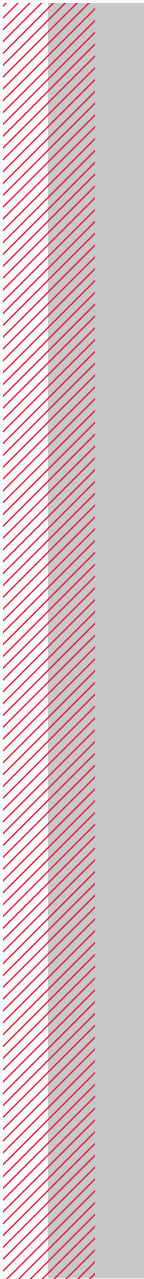

With this kind of response, you may not care how efficient you've become.

The Audi A8 features a shift-by-wire eight-speed Tiptronic® automatic transmission, a technical tour de force combining a range of ratios to match whatever the road throws at you. This wide spread of ratios between first and eighth gear not only helps reduce fuel consumption, but is flexible enough to deliver everything from sporty acceleration to smooth cruising.¹

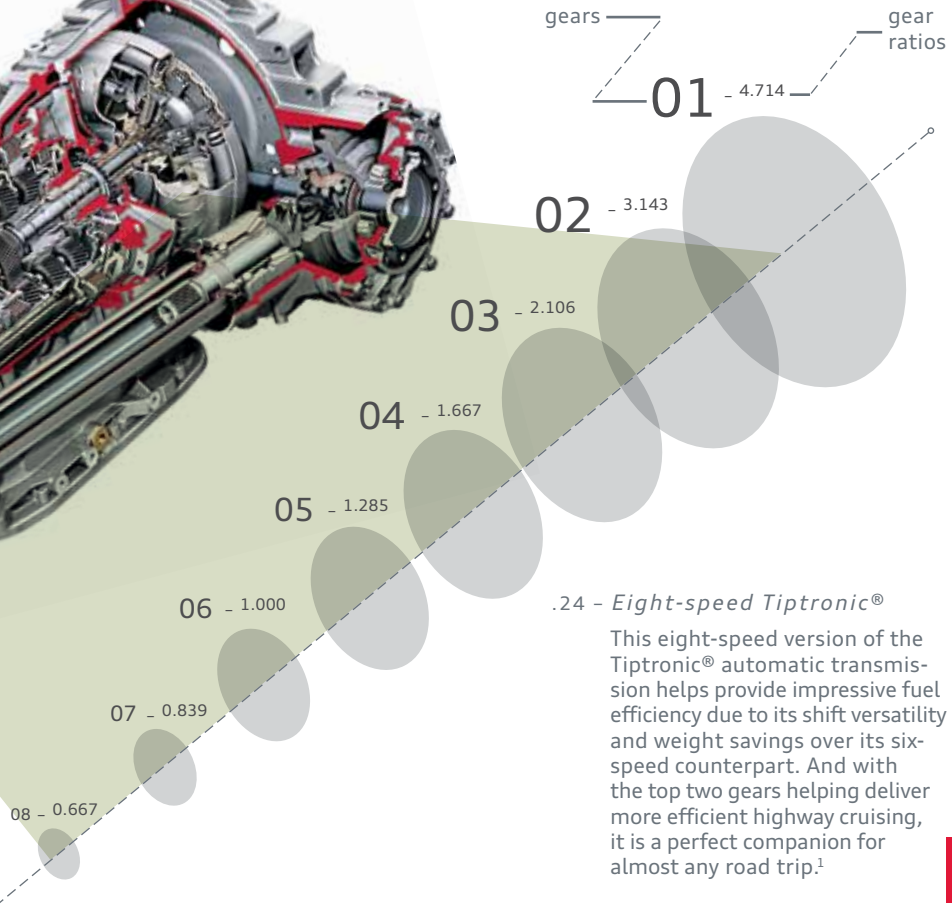
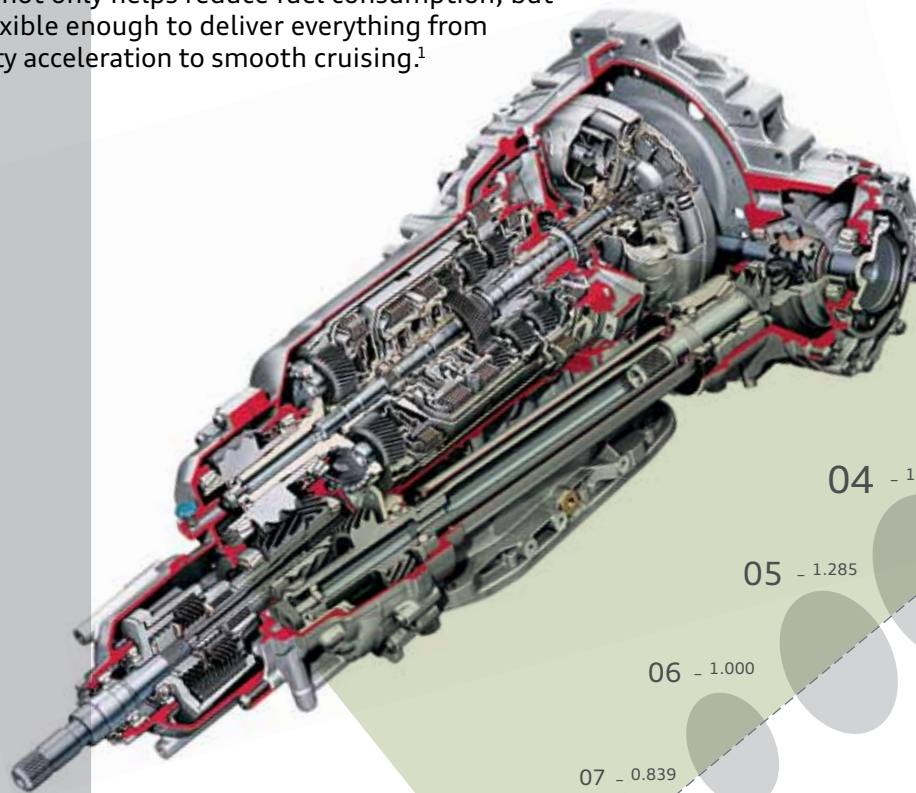

¹ See www.fueleconomy.gov for EPA estimates. Your mileage will vary.
² 0-60-mph times will vary from model to model. Always obey local speed and traffic laws.

The beating heart of luxury.

It's an enviable choice—the refined luxury of the Audi A8 4.2L FSI® or the extraordinary power of the W12. Featured on the A8, the Audi 4.2L FSI V8 delivers 372 hp and does 0 to 60 mph at an impressive 5.7 seconds, while the legendary W12 brings 500 hp, 463 lb-ft of torque and a 0-to-60-mph time of 4.4 seconds to round out an impressive power profile.²

.26 - 6.3L Audi FSI W12



The pinnacle of engine design, this direct-injected gasoline engine gets its name from the W-shaped layout of its cylinders—four rows of three cylinders each, merged into two banks. Starting from its displacement of 6.3 liters, the surprisingly compact, lightweight W12 pumps out an immense 500 hp and a thrilling 463 lb-ft of torque. In addition to the impressive output, the W12 is also the only twelve-cylinder engine in a luxury vehicle that has a standard all-wheel drive system—others don't offer it at all.



.25 - 4.2L Audi FSI V8 Engine

Owing much of its power response to Audi FSI direct injection, the system injects a precise amount of fuel into each cylinder. Combined with the Audi valvelift-system-complementing FSI, the result helps deliver maximum efficiency and responsive power at practically any rpm.²

4.4 _ seconds

W12

+++ ++
+++ ++



Input as unique as your fingerprint.

What does your handwriting say about you? We aren't really sure. We just know it speaks to us. A revolution in intelligent simplicity, the Audi MMI® touch with handwriting recognition is a class-first technology that gives you the ability to give commands and retrieve media simply by recognizing a few strokes of your finger. Access information such as songs, phone numbers, and destinations through the Audi MMI® touch—or give input through the traditional Audi MMI® rotary dial or voice commands to Audi connect™, the world's first media system with Google Earth™ imagery. The world isn't simply at your fingertips—your fingertips open up a new way to interact with the world.



.27 - Audi MMI® Touch

Developed by the Audi Human Machine Interface (HMI) team, Audi MMI® touch defines why simple can be so complex. Not to use, but to design. The HMI team built a system so advanced, it can read almost anyone's handwriting—even if you choose to write it with your off hand.

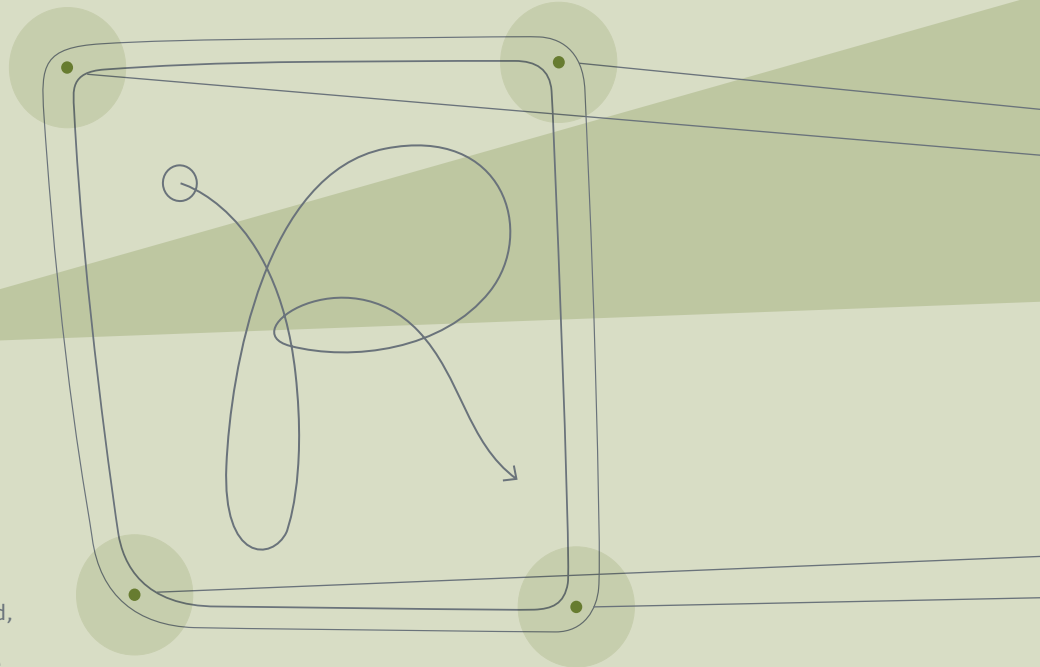

~ fig. 06

- letter and number entries for destinations and contacts
- radio preset selection
- album-cover scrolling
- map scrolling
- sound distribution adjustment



+ +

+ + 38° 57' 8.1" N
77° 23' 41.1" W

No one connects you the way we do.



We set out to change how people interact in and out of their automobiles. A suite of class-leading technologies has made the A8 a true champion for progress. Audi MMI® touch with handwriting-recognition technology, Audi connect™ with Google Earth™, and Wi-Fi connectivity¹ for up to eight passenger devices help ensure that no other luxury automotive company offers this level of connectivity in the U.S. You can also access the information and navigation entirely with your voice in just a few commands. And with that kind of access, Audi helps build on your interactive life while helping enhance your ownership experience.

33° 46' 3.1" N
118° 11' 26.5" W

+ +

+ +

1 Requires a data subscription plan. Distracted driving can cause a loss of vehicle control. The features and technologies discussed above are offered for convenience, and should be used only when it is safe and appropriate. The Wi-Fi hotspot feature is intended for passenger use only. Always pay careful attention to the road, and do not drive while distracted.
2 See back cover for important information regarding required SiriusXM subscriptions.

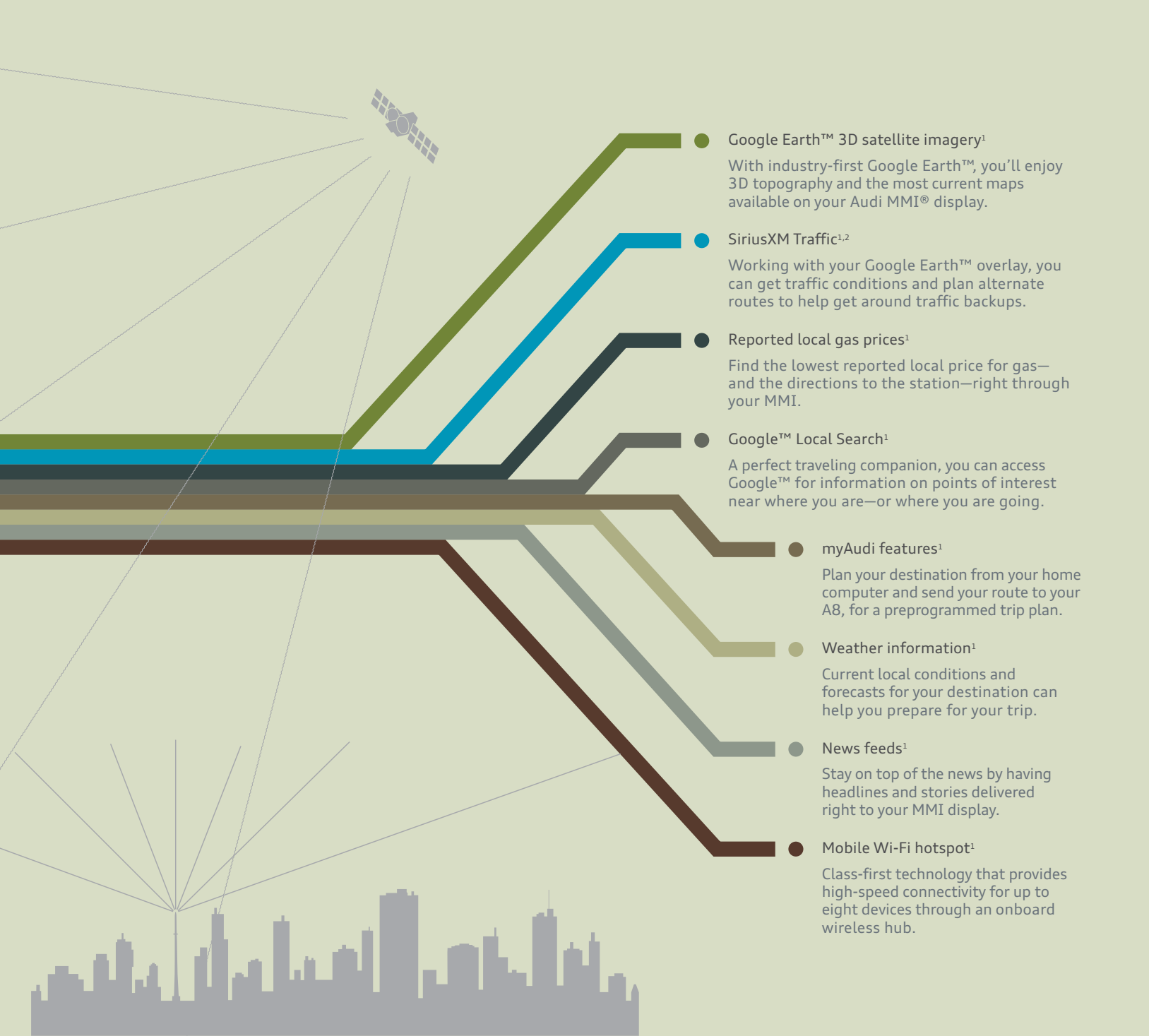

● **Google Earth™ 3D satellite imagery¹**
With industry-first Google Earth™, you'll enjoy 3D topography and the most current maps available on your Audi MMI® display.

● **SiriusXM Traffic^{1,2}**
Working with your Google Earth™ overlay, you can get traffic conditions and plan alternate routes to help get around traffic backups.

● **Reported local gas prices¹**
Find the lowest reported local price for gas—and the directions to the station—right through your MMI.

● **Google™ Local Search¹**
A perfect traveling companion, you can access Google™ for information on points of interest near where you are—or where you are going.

● **myAudi features¹**
Plan your destination from your home computer and send your route to your A8, for a preprogrammed trip plan.

● **Weather information¹**
Current local conditions and forecasts for your destination can help you prepare for your trip.

● **News feeds¹**
Stay on top of the news by having headlines and stories delivered right to your MMI display.

● **Mobile Wi-Fi hotspot¹**
Class-first technology that provides high-speed connectivity for up to eight devices through an onboard wireless hub.

Striking a deep note for a shared passion.

For years, while other sound-system engineers were obsessed with what they thought you should be hearing, Audi sound engineers thought about how we impact what people are feeling when they are enjoying music. We found a partner who shared our passion—Bang & Olufsen®—who has helped us conceive a new way of experiencing sounds in your A8. We use speaker positioning, speaker design and precise sound calibration to work in concert with the ambient noise in your car. The results are crisper, more resonant—you might even say, more emotional. Because, if you are only listening, you're not really feeling it.¹



(Bang & Olufsen® acoustic lenses)

.29 - ICEpower® Amplifiers

About the size of a matchbox, this revolutionary acoustic technology from Bang & Olufsen® helps ensure a powerful sound base without taking up the amount of space or emitting the level of heat that conventional amplifiers do. No wonder Bang & Olufsen® and Audi complement each other so well.¹

19 speakers



.28 - Bang & Olufsen® Advanced Sound System

The passion of Bang & Olufsen® matches well with Audi. By focusing on design and performance together, we bring out the best in outstanding acoustics. Bang & Olufsen® engineers help to sculpt meticulously rendered sound through two innovative retractable aluminum acoustic lenses and an impressive 1,400 watts of pure power!¹

1,400 watts

(2 of 19 speakers)



¹ Bang & Olufsen® Advanced Sound System available on all A8 models.

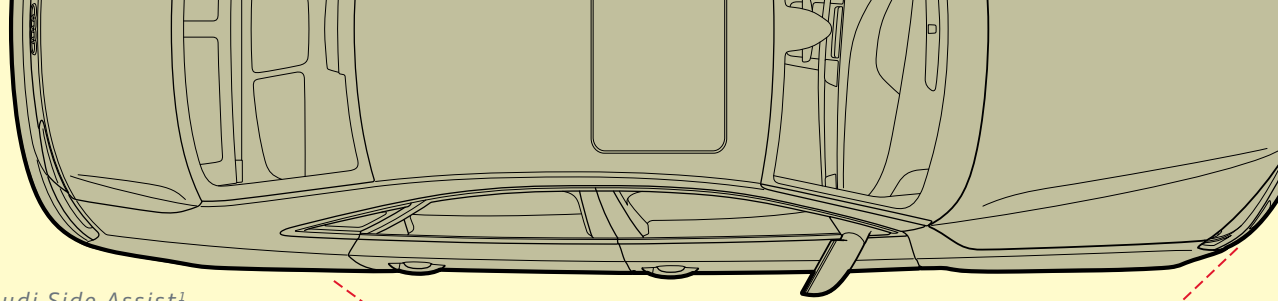

.30 - Audi Side Assist¹

Radar sensors and optical warnings help keep the driver informed of what is approaching from hard-to-see angles behind and to the side of the vehicle in two different warning stages.



Anticipating needs you didn't know you had.

With something like one in five people on the road checking their e-mail, driving distracted, in cars they don't maintain, Audi engineers had to come up with something that anticipates the arbitrary impulses of this mass of unpredictability. So they developed a suite of available driver-assistance technologies in the A8 that is thoughtfully comprehensive, side to side and back to front. From seemingly sentient Audi adaptive cruise control to Audi pre sense plus active collision warning and preparation, to the literally visionary night vision assistant with pedestrian detection, Audi has incorporated innovative, anticipatory technologies that don't see your future so much as help others avoid changing it.

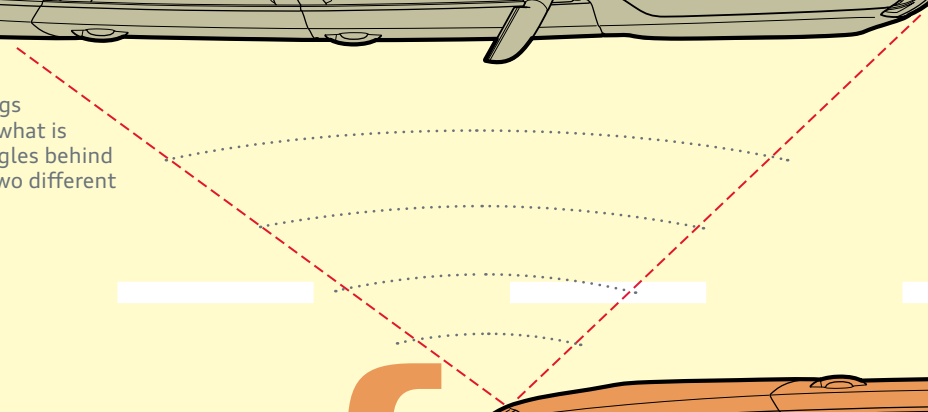
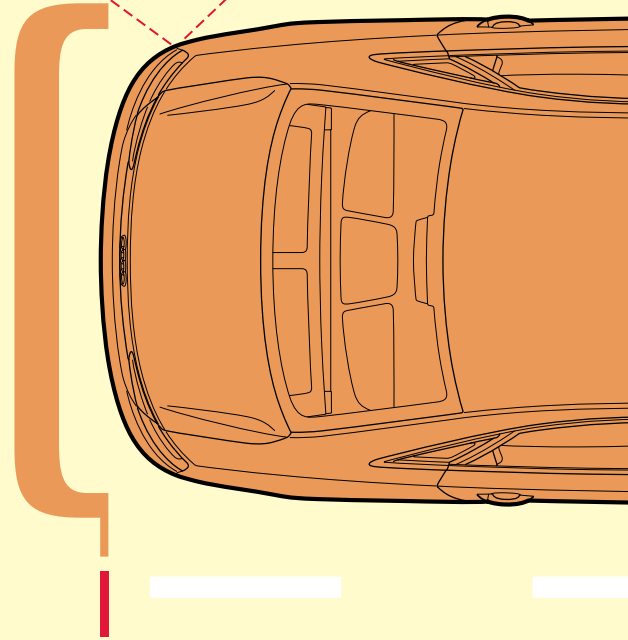

.31 - Night Vision Assistant¹



With an infrared camera detecting what lies ahead, the A8 uses thermal-imaging technology to help you avoid trouble. Pedestrians can be detected 300 feet in front of the vehicle, while objects can be detected up to 1,000 feet ahead—all shown on the 7" color driver information system.

.32 - Audi Pre Sense Plus¹

Offers comprehensive driving assistance with sensors in the front, side, and rear. After visual, physical and aural collision warnings, there are four distinct phases for automatic preparation for the unavoidable: an upsurge of brake pressure, seatbelt pre-tensioning, partial braking, and sunroof and window preparation. In severe cases, Audi pre sense plus will engage full braking and deceleration.

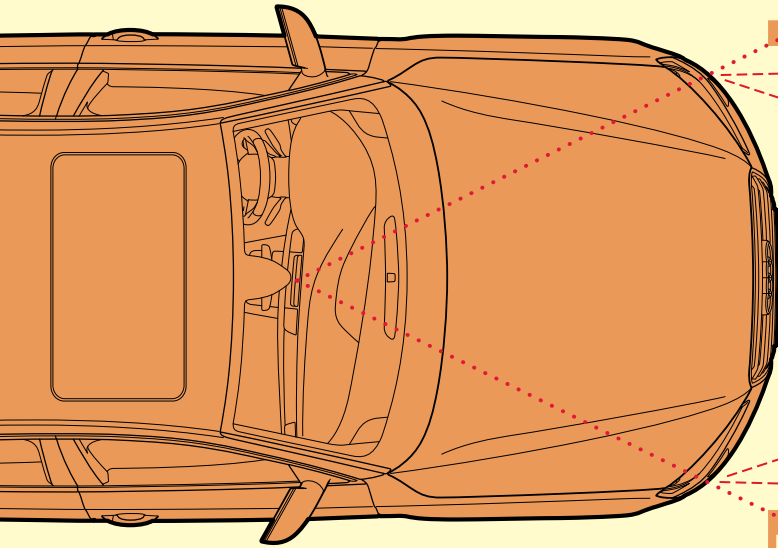

.33 - Audi Adaptive Cruise Control with Stop and Go¹

Not only retains a preset distance from vehicles ahead, but resumes acceleration when you're ready. Using long-range radar and a camera, Audi adaptive cruise control with Stop and Go helps read the traffic conditions and adjusts the speed, helping to bring the vehicle to a full stop before accelerating when traffic flow resumes.

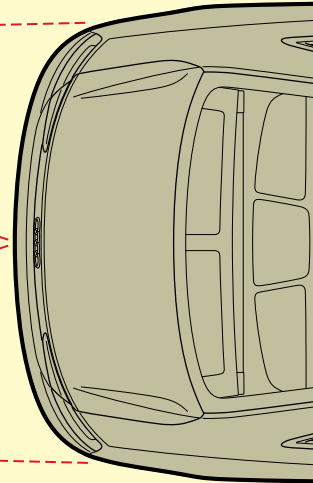

.34 - Audi Lane Assist¹

Unlike road-detection systems that override a driver's decision-making process, Audi lane assist helps warn of errant steering with a simple vibration on the steering wheel. By trusting the human element to make the correct on-road decision, the Audi A8 further solidifies its bond between driver and machine.

Shedding the excess of old luxury.

When you think of luxury, you probably don't think about weight savings. But by placing the right material where it is most needed, our team of engineers gets to the literal core of a better performing, more efficient, and patently unique luxury vehicle.

.36 - ASF® Aluminum Space Frame

Flexible yet unyielding, revolutionary ASF® technology offers an innovative approach to weight savings—a benefit you will notice in the overall efficiency, enhanced performance and remarkable handling of the Audi A8. These unique characteristics also help to absorb the normal bumps of the road, delivering a smoother ride.

.35 - Passive Safety

Referring to all dedicated measures that help protect the car's occupants against injury, the passive safety measures in the A8 include its safety belt system, ten airbags,¹ the rigid occupant cell and crumple zones at the front and rear of the vehicle.

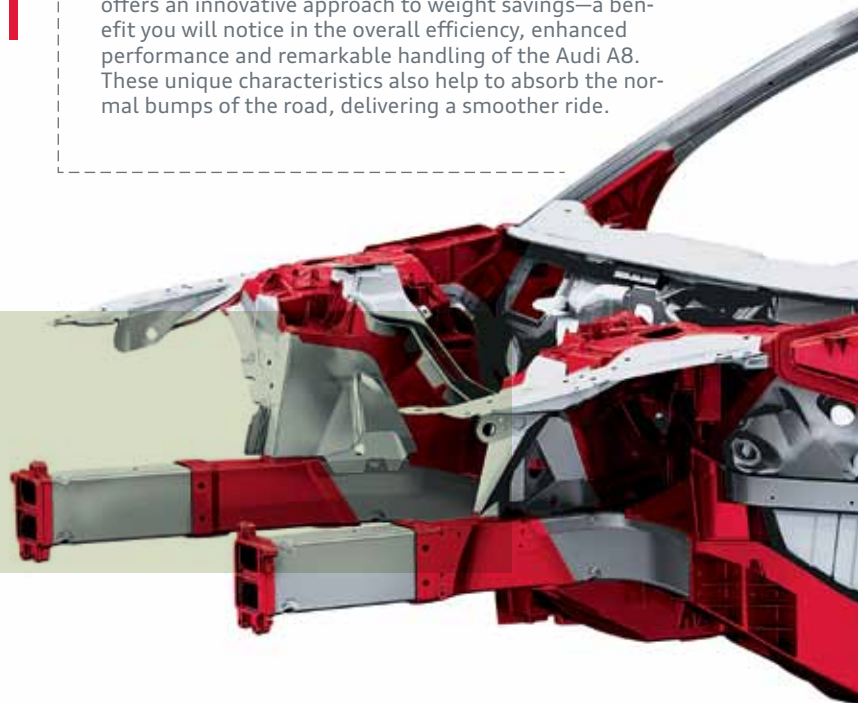

- | | |
|--|---|
| 01 driver's head airbag | 02 front-passenger head airbag |
| 03 driver's knee airbag | 04 front-passenger knee airbag |
| 05 driver-side seat-mounted thorax side airbag | 06 front-passenger seat-mounted thorax side airbag |
| 07 driver-side Sideguard® head curtain airbag for both rows of seats | 08 passenger-side Sideguard® head curtain airbag for both rows of seats |
| 09 driver-side rear seat-mounted thorax side airbag | 10 passenger-side rear seat-mounted thorax side airbag |

37 - Ten Airbags

The A8 is equipped with a full complement of ten airbags to offer additional protection in the event of a collision.

Front-impact airbags for both driver and front passenger are designed to specifically target and protect the head during collisions, for added protection.¹



¹ Airbags are supplemental restraints only and will not deploy under all crash circumstances. Always use safety belts and seat children only in the rear, using restraint systems appropriate for their size and age.

Accessories

With the A8, there's always more. Like an Audi Genuine Accessory. Choose one that helps protect your A8 in the garage. Or carries your bikes for a serious weekend on the trails. Or makes heads swivel as you drive by. These accessories are the little extras that make your Audi even more distinguished. Designed by the same visionaries



20" Cartesia Alloy Wheels

This classic wheel style combines a retro look with today's technology and quality.



Textile Floor Mats

This set of custom-fit, black floor mats keeps your A8 looking showroom-new.



Cup Holder Ashtray

Removable and easy to clean, this ashtray is perfect for holding ashes or spare change. Lid is emblazoned with the Audi rings.

Other accessories not shown -----

Various Transport Solutions

The open road is calling—so bring all the right gear to enjoy the ride. The Audi line of storage accessories ideally protects your possessions with a variety of intelligent and innovative solutions. Choose from bike racks, ski racks and a variety of cargo carriers.

who designed your vehicle, all accessories feature a tailored fit and the expert craftsmanship you'd expect from Audi. They are also backed by the 4-year/50,000-mile Audi New Vehicle Limited Warranty or the accessory's 12-month/12,000-mile limited warranty, whichever extends longer from the accessory purchase date.¹



Indoor Storage Cover

Made from three-layer polypropylene fabric, this cover repels moisture and heat to provide added protection for the finish of your A8.

Base Carrier Bars

Attached to strong side brackets, these are the durable foundation of the Audi roof-rack system. (All roof-rack system attachments require the base carrier bars. All attachments sold separately.)

Aluminum Luggage Carrier

A quality roof-rack platform made from lightweight aluminum. Requires vehicle base carrier bars (sold separately).

Splash Protectors

Help protect your exterior finish with custom-fit front and rear splash protectors. Made of long-life, crack-resistant rubber. Available in sets of two for front or rear.

Comfort and Protection Solutions

Audi Genuine Accessories offer a wealth of practical aids for more space, tidiness and safety on board with functional items to help keep your Audi in pristine condition. Use them all to help reduce wear and tear on your Audi and help keep it looking like new—inside and out.

Car Care

Use the only car care line designed with your Audi vehicle in mind. Audi Guard car care products provide gentle cleansing formulas and special tools to help give interior and exterior surfaces the finest in cleaning and protection.

Colors

exterior

interior

Ibis White



Glacier White metallic

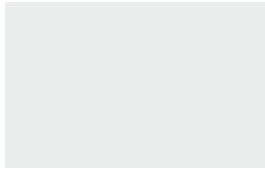

Ice Silver metallic



Quartz Gray metallic



Oolong Gray metallic

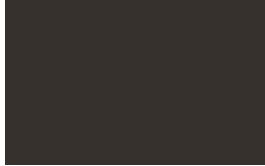

Night Blue pearl



Phantom Black pearl



Emerald Black metallic



Havanna Black metallic

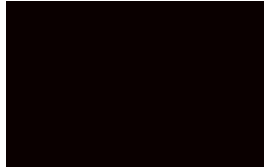

Savana Beige pearl



Black leather



Nougat Brown leather



Titanium Gray leather



Velvet Beige leather



Balao Brown leather

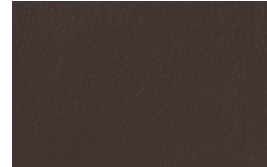

Silk Beige leather

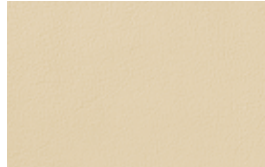

Audi Design Selection

Interior leathers are available in Valetta, Valcona, or Fine Nappa grains. Each offers the comfort, quality, and craftsmanship you would expect from Audi. Not all leather colors are available in all grains. See your dealer for details.

Color Combinations

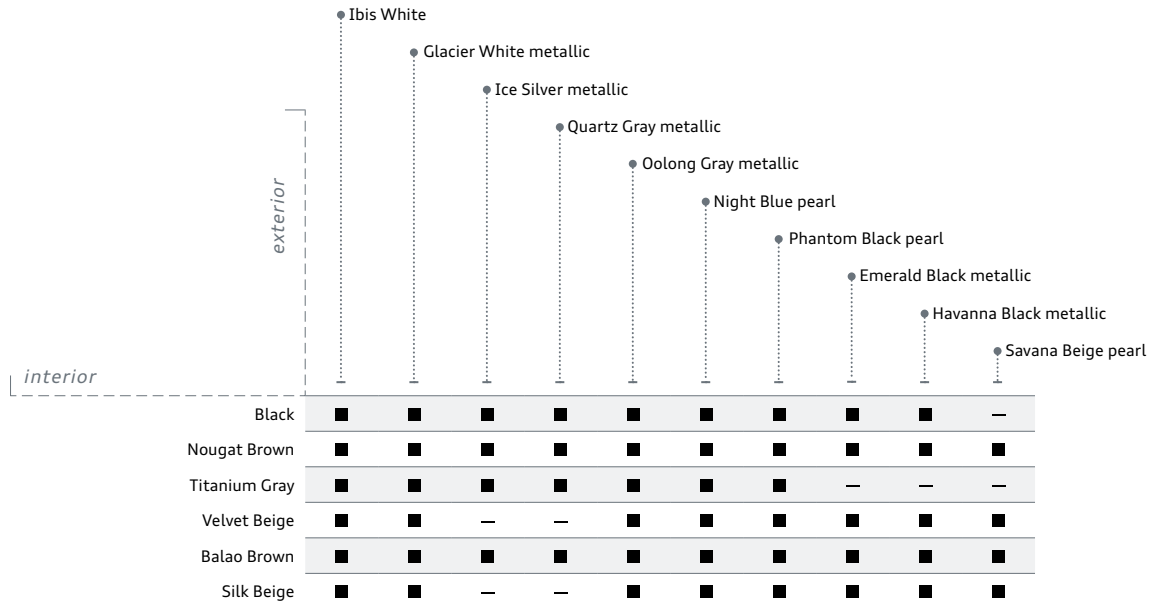

■ Available combination

— N/A

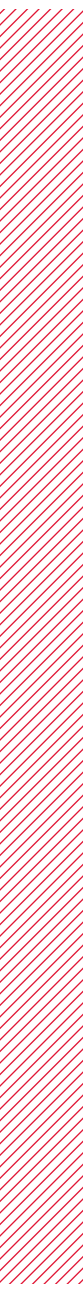

Decorative Inlays



Upper Decorative Inlay Options¹

Brown Walnut Wood inlay



Pearl Beige Fine Grain Birch Wood inlay



Assam Gray Vavona Wood inlay



Balsamic Brown Natural Fine Grain Ash Wood inlay



Piano Black Wood inlay

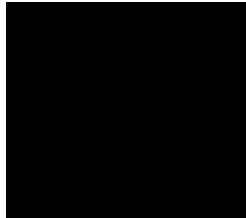

Velvet Brown Fine Grain Ash Wood inlay



Lower Decorative Inlay Options¹

Brushed Aluminum inlay



High-polished Black inlay

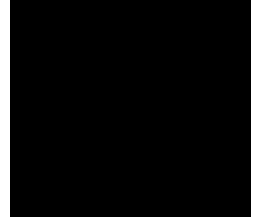

¹ Decorative inlay options will vary based on model and interior color combination. See your dealer for details.



Balao Brown leather with Balsamic Brown Natural Fine Grain Ash Wood and Brushed Aluminum inlays. Audi Design Selection

Wheels

19" 10-Y-spoke design
255/45 all-season tires



A8 and A8 L—standard

20" 10-parallel-spoke design
265/40 summer performance tires¹



A8 L W12—standard
A8 and A8 L—optional

19" 15-spoke design
255/45 all-season tires



A8 L W12—optional

20" 5-segment-spoke design
265/40 summer performance tires¹



A8 Sport Package

¹ Tires are supplied and warranted by their manufacturer. High-performance tires are designed for optimum performance and handling in warm climates. They are not suitable for cold, snowy, or icy weather conditions. If you drive under those circumstances, you should equip your vehicle with all-season or winter tires, which offer better traction under those conditions. We suggest you use the recommended winter or all-season tire specified for your car or its equivalent. These high-performance tires also have a lower aspect ratio that aids performance and handling; however, in order to avoid tire, rim or vehicle damage, it is important that the inflation pressure is regularly checked and maintained at optimum levels. Please also remember in making your selection that, while these tires deliver responsive handling, they may ride less comfortably and make more noise than other choices. ² Always obey local speed and traffic laws.

Configurations | Dimensions

A8 Models	A8	A8 L	A8 L W12
A8 4.2 with eight-speed Tiptronic® automatic transmission and Audi quattro® all-wheel drive	■	—	—
A8 L 4.2 with eight-speed Tiptronic® automatic transmission and Audi quattro® all-wheel drive	—	■	—
A8 L W12 with eight-speed Tiptronic® automatic transmission and Audi quattro® all-wheel drive	—	—	■

A8 Engine Specifications

4.2-liter: DOHC V8 gasoline engine with Audi FSI® direct injection and variable valve timing. Horsepower: 372 hp @ 6,800 rpm / Torque: 328 lb-ft @ 3,500 rpm	■	■	—
6.3-liter: W12 gasoline engine with Audi FSI® direct injection. Horsepower: 500 hp @ 6,200 rpm / Torque: 463 lb-ft @ 4,750 rpm	—	—	■

A8 Performance Specifications	0 – 60 mph ²	Top Speed ² (electronically limited)
A8 4.2 with eight-speed Tiptronic® automatic transmission and Audi quattro® all-wheel drive	5.7 seconds	130 mph
A8 L 4.2 with eight-speed Tiptronic® automatic transmission and Audi quattro® all-wheel drive	5.8 seconds	130 mph
A8 L W12 with eight-speed Tiptronic® automatic transmission and Audi quattro® all-wheel drive	4.4 seconds	130 mph

Exterior Dimensions

Length:	Track, front:
A8 202.2"	A8 64.7"
A8 L 207.4"	A8 L 64.7"
Width:	Track, rear:
A8 83.1"	A8 64.4"
A8 L 83.1"	A8 L 64.4"
Height:	Wheelbase:
A8 57.5"	A8 117.8"
A8 L 57.9"	A8 L 122.9"

Interior Dimensions

Head room, front:	Shoulder room, front:
A8 37.2"	A8 59.1"
A8 L 37.2"	A8 L 59.1"
Head room, rear:	Shoulder room, rear:
A8 38.1"	A8 57.8"
A8 L 39.1"	A8 L 57.8"
Leg room, front:	EPA cargo volume:
A8 41.4"	A8 13.2 cu ft
A8 L 41.4"	A8 L 13.2 cu ft
Leg room, rear:	EPA interior volume:
A8 38.7"	A8 115.1 cu ft
A8 L 42.9"	A8 L 121.9 cu ft

Fuel Economy Estimates, City/Highway/Combined

A8/A8 L: 18/28/21	A8 L W12: 14/21/16
EPA estimates. Your mileage will vary. See www.fueleconomy.gov for details.	

Weights and Capacities

	A8	A8 L	A8 L W12
Curb weight:	4,409 lb	4,453 lb	4,773 lb
Engine oil capacity:	8.1 qt	8.1 qt	12.2 qt
Fuel tank capacity:	23.8 gal	23.8 gal	23.8 gal

Specifications

	A8	A8 L	A8 L W12
Chassis Technical			
ASF® aluminum space frame	■	■	■
Five-link front suspension with upper and lower control arms with stabilizer bar	■	■	■
Trapezoidal-link rear suspension with stabilizer bar	■	■	■
Audi adaptive air suspension	■	■	■
Audi adaptive air suspension—sport	□	—	—
Audi servotronic® speed-sensitive power steering—varies assistance based on vehicle speed	■	■	—
Dynamic steering	□	□	■
Audi quattro® all-wheel drive system utilizing self-locking center differential—40:60 rear-biased torque split	■	■	■
Audi quattro® with sports differential	□	□	□
Eight-speed Tiptronic® automatic transmission	■	■	■
Safety Security			
Driver and front passenger dual-stage airbags, thorax side airbags and Sideguard® head curtain airbags ¹	■	■	■
Driver and front passenger knee airbags ¹	■	■	■
Rear-passenger thorax side airbags ¹	■	■	■
Front passenger occupant detection—for airbags	■	■	■
Safety belt reminder for driver and front passenger	■	■	■
Lower Anchors and Tethers for CHildren (LATCH) in rear seats	■	■	■
Power central locking system with safety unlock feature if airbags deploy ¹	■	■	■
Electronic Stability Control (ESC) with traction control (ASR)	■	■	■
Anti-lock Brake System (ABS) with Electronic Brake-pressure Distribution (EBD) and brake assist	■	■	■
Front ventilated disc brakes	■	■	■
Rear ventilated disc brakes	■	■	■
Electromechanical parking brake	■	■	■

■ Standard □ Optional — N/A

	A8	A8 L	A8 L W12
Infotainment Technology			
Audi MMI® Navigation plus with voice control system ²	■	■	■
Audi MMI® touch with handwriting-recognition technology	■	■	■
Audi connect™ with six-month trial subscription	■	■	■
7" color driver information system	■	■	■
BOSE® Surround Sound system with 14 speakers, AudioPilot® noise compensation and 630 watts	■	■	■
Bang & Olufsen® Advanced Sound System with 19 speakers and 1,400 watts	□	□	□
HD Radio™ technology	■	■	■
SiriusXM Traffic with 90-day trial subscription ³	■	■	■
SiriusXM Satellite Radio with 90-day trial subscription ³	■	■	■
Audi music interface with iPod® integration	■	■	■
In-dash DVD player	■	■	■
Rear Seat Entertainment with dual 10" screens and DVD single slot	□	□	■
BLUETOOTH® wireless technology preparation for mobile phone	■	■	■
HomeLink® remote transmitter	■	■	■
Keyless Start	■	—	—
Audi advanced key—keyless start, stop and entry	□	■	■
Cruise control with coast, resume and accelerate features	■	■	■
Audi adaptive cruise control with Stop and Go function	□	□	□
Audi lane assist	□	□	□
Audi side assist	□	□	□
Audi pre sense plus—includes Audi pre sense rear	□	□	□
Night vision assistant with pedestrian detection	□	□	□
Audi drive select	■	■	■
Parking system with front and rear sensors	□	■	■
Rain/light sensors for automatic windshield wipers and headlights	■	■	■

1 Airbags are supplemental restraints only and will not deploy under all crash circumstances. Always use safety belts and seat children only in the rear, using restraint systems appropriate for their size and age. 2 Audi Navigation plus depends on signals from the worldwide Global Positioning Satellite network. The vehicle's electrical system and existing wireless and satellite technologies must be available and operating properly for the system to function. The system is designed to provide you with suggested routes in locating addresses, destinations and other points of interest. Changes in street names, construction zones, traffic flow, points of interest and other road system changes are beyond the control of Audi of America, Inc. Complete detailed mapping of lanes, roads, streets, toll roads, highways, etc., is not possible, therefore you may encounter discrepancies between the mapping and your actual location. Please rely on your individual judgment in determining whether or not to follow a suggested Audi Navigation plus route. Periodically mapping updates will be available for purchase at an additional cost. Consult your dealer or call 1-800-FOR-AUDI for details. 3 See back cover for important information regarding required SiriusXM subscriptions.

Specifications

	A8	A8 L	A8 L W12
Exterior			
Audi Singleframe® grille	■	■	■
Adaptive xenon plus headlights with cornering lights and LED daytime running light technology	■	■	—
Full LED headlight technology	□	□	■
Automatic headlights	■	■	■
Headlight washers	■	■	■
LED taillight technology	■	■	■
Power-adjustable, power-folding, auto-dimming, heated side mirrors with memory	■	■	■
LED turn indicator light technology integrated in the side mirrors	■	■	■
LED puddle lighting technology	■	■	■
Aluminum trim around exterior windows	■	■	■
Power soft-closing doors	□	■	■
Power trunk open/close	□	■	■
Dual exhaust pipes with chrome tips	■	■	—
Integrated twin-trapezoidal exhaust pipes with chrome tips	—	—	■
Interior			
Dual-zone automatic climate control	■	■	—
Four-zone automatic climate control	□	□	■
Four-spoke multifunction steering wheel with shift paddles	□	■	■
Three-spoke multifunction steering wheel with shift paddles	■	—	—
Heated steering wheel	□	□	■
Power tilt and telescopic steering column with memory	■	■	■
Alcantara® headliner	□	□	■
Black Alcantara® headliner	□	□	□
Valetta leather seating surfaces	■	■	—
Valcona leather seating surfaces	—	□	■

■ Standard □ Optional — N/A

	A8	A8 L	A8 L W12
Interior (continued)			
Valcona leather seating surfaces with sport stitched-diamond look	□	—	—
Fine Nappa leather upholstery	□	□	□
Leather Package: Center console, knee rests, door armrests, and airbag cap	□	■	■
18-way power front seats, including power lumbar adjustment	■	■	—
22-way power comfort front seats, including power lumbar adjustment	□	□	■
22-way power sport comfort front seats, including power lumbar adjustment	□	—	—
Heated front seats	■	■	■
Ventilated front seats with massage function	□	□	■
Power rear seats with power lumbar adjustment	—	□	■
Power rear single seats with lumbar adjustment and fixed center console	—	□	□
Heated rear seats	□	□	■
Ventilated rear seats with massage function	—	□	■
Passenger-side rear relaxation seat with power footrest (eliminates front passenger seat massage function and limits front passenger seat to 10-way power adjustment)	—	□	□
Front and rear comfort headrests	■	■	■
Driver and front-passenger seat memory	■	■	■
Rear seat memory	—	□	□
Rear seat pass-through with ski bag	□	□	■
Refrigerator in rear center pass-through (10.4-liter capacity, eliminates rear seat pass-through with ski bag)	—	□	□
Power windows with one-touch up/down operation and pinch protection	■	■	■
Dual-pane acoustic glass	□	□	■
Power rear side sunshades	□	■	■
Power rear sunshade	■	■	■
Sunroof	■	■	—
Panoramic sunroof	—	□	■
Solar sunroof	□	□	□

Packages | Options

	A8	A8 L	A8 L W12
Packages			
Driver Assistance Package: Audi adaptive cruise control with Stop and Go function, Audi lane assist, Audi side assist, Audi pre sense plus and four-spoke multifunction steering wheel with shift paddles (four-spoke multifunction steering wheel with shift paddles standard on A8 L and A8 L W12)	<input type="checkbox"/>	<input type="checkbox"/>	<input type="checkbox"/>
Convenience Package: Audi advanced key—keyless start, stop and entry; parking system with front and rear sensors; power soft-closing doors; and power trunk open/close	<input type="checkbox"/>	<input checked="" type="checkbox"/>	<input checked="" type="checkbox"/>
Premium Package: 22-way power comfort front seats (includes power lumbar adjustment) and ventilated front seats with massage function	<input type="checkbox"/>	<input type="checkbox"/>	<input checked="" type="checkbox"/>
Sport Package: 20" 5-segment-spoke design alloy wheels, summer performance tires, ¹ dynamic steering, Audi adaptive air suspension—sport, Audi quattro® with sports differential, Valcona leather seating surfaces with sport stitched-diamond look, 22-way power sport comfort front seats (includes power lumbar adjustment), and ventilated front seats with massage function	<input type="checkbox"/>	<input type="checkbox"/>	<input type="checkbox"/>
Cold Weather Package: Heated steering wheel, heated rear seats, and rear seat pass-through with ski bag	<input type="checkbox"/>	<input type="checkbox"/>	<input checked="" type="checkbox"/>
Audi Design Selection Package: Balao Brown Valcona leather seating surfaces, Snow White seat stitching and piping, Balsamic Brown Natural Fine Grain Ash Wood upper inlays with Brushed Aluminum lower inlays, and Snow White Alcantara® headliner	<input type="checkbox"/>	<input type="checkbox"/>	<input type="checkbox"/>
Drive Select Plus Package: Dynamic steering and Audi quattro® with sports differential	<input type="checkbox"/>	<input type="checkbox"/>	<input type="checkbox"/>
Rear Seat Comfort Package: Four-zone automatic climate control, power rear seats (includes power lumbar adjustment), heated rear seats, rear seat memory, and rear vanity mirrors	<input type="checkbox"/>	<input type="checkbox"/>	<input type="checkbox"/>
Executive Rear Seat Package: Four-zone automatic climate control, Valcona leather seating surfaces, power rear single seats (includes lumbar adjustment and fixed center console), ventilated rear seats with massage function, rear seat memory, passenger-side rear relaxation seat with power footrest (eliminates front passenger seat massage function and limits front seat to 10-way power adjustment), refrigerator in rear center pass-through (10.4-liter capacity, eliminates rear seat pass-through with ski bag), rear vanity mirrors, and Rear Seat Entertainment with dual 10" screens	<input type="checkbox"/>	<input type="checkbox"/>	<input type="checkbox"/>
W12 Executive Rear Seat Package: Power rear single seats (includes lumbar adjustment and fixed center console), rear seat memory, passenger-side rear relaxation seat with power footrest (eliminates front passenger seat massage function and limits front seat to 10-way power adjustment), and refrigerator in rear center pass-through (10.4-liter capacity, eliminates rear seat pass-through with ski bag)	<input type="checkbox"/>	<input type="checkbox"/>	<input type="checkbox"/>
Full Leather Package: Fine Nappa leather upholstery—includes leather upper and lower instrument panel, center console, knee rests, door trim (including armrests), and airbag cap	<input type="checkbox"/>	<input type="checkbox"/>	<input type="checkbox"/>

	A8	A8 L	A8 L W12
Individual Options			
20" 10-parallel-spoke design alloy wheels with summer performance tires ¹	<input type="checkbox"/>	<input type="checkbox"/>	<input checked="" type="checkbox"/>
19" 15-spoke design alloy wheels with all-season tires	<input type="checkbox"/>	<input type="checkbox"/>	<input type="checkbox"/>
Audi quattro® with sports differential	<input type="checkbox"/>	<input type="checkbox"/>	<input type="checkbox"/>
Full LED headlight technology	<input type="checkbox"/>	<input type="checkbox"/>	<input checked="" type="checkbox"/>
Bang & Olufsen® Advanced Sound System with 19 speakers and 1,400 watts	<input type="checkbox"/>	<input type="checkbox"/>	<input type="checkbox"/>
Night vision assistant with pedestrian detection	<input type="checkbox"/>	<input type="checkbox"/>	<input type="checkbox"/>
Rear Seat Entertainment with dual 10" screens	<input type="checkbox"/>	<input type="checkbox"/>	<input checked="" type="checkbox"/>
Four-zone automatic climate control	<input type="checkbox"/>	<input type="checkbox"/>	<input checked="" type="checkbox"/>
Five-seat configuration (power rear seat, 2+1 seating configuration)	<input type="checkbox"/>	<input type="checkbox"/>	<input type="checkbox"/>
Alcantara® headliner	<input type="checkbox"/>	<input type="checkbox"/>	<input checked="" type="checkbox"/>
Black Alcantara® headliner	<input type="checkbox"/>	<input type="checkbox"/>	<input type="checkbox"/>
Leather Package: Center console, knee rests, door armrests, and airbag cap	<input type="checkbox"/>	<input checked="" type="checkbox"/>	<input checked="" type="checkbox"/>
Brown Walnut Wood inlays	<input type="checkbox"/>	<input type="checkbox"/>	<input type="checkbox"/>
Assam Gray Vavona Wood inlays	<input type="checkbox"/>	<input type="checkbox"/>	<input type="checkbox"/>
Velvet Brown Fine Grain Ash Wood inlays	<input type="checkbox"/>	<input type="checkbox"/>	<input type="checkbox"/>
Pearl Beige Fine Grain Birch Wood inlays	<input type="checkbox"/>	<input type="checkbox"/>	<input type="checkbox"/>
Power rear side sunshades	<input type="checkbox"/>	<input checked="" type="checkbox"/>	<input checked="" type="checkbox"/>
Dual-pane acoustic glass	<input type="checkbox"/>	<input type="checkbox"/>	<input checked="" type="checkbox"/>
Panoramic sunroof	<input type="checkbox"/>	<input type="checkbox"/>	<input checked="" type="checkbox"/>
Solar sunroof	<input type="checkbox"/>	<input type="checkbox"/>	<input type="checkbox"/>

¹ See Wheels page of this brochure for important safety information regarding summer performance tires.

Audi Truth in Engineering

Note: A word about this brochure. Audi of America, Inc., believes the specifications in this brochure to be correct at the time of printing. However, specifications, standard equipment, options, fabrics, and colors are subject to change without notice. Some equipment may be unavailable when your vehicle is built. Please ask your dealer for advice concerning current availability of standard and optional equipment, and your dealer will verify that your vehicle will include the equipment you ordered. Vehicles in this brochure are shown with optional equipment. See your dealer for complete details on the New Vehicle Limited Warranty, twelve-year limited warranty against corrosion perforation, and Audi 24/7 Roadside Assistance. (Roadside assistance coverage provided by Road America in the U.S. Certain conditions apply; see your dealer for details.) Tires supplied by various manufacturers. "Audi," all model names, "ASF," "FSI," "MMI," "quattro," "Sideguard," "Singleframe" and the Singleframe grille design, "Truth in Engineering," and the four rings logo are registered trademarks of AUDI AG. "Audi connect" is a trademark of AUDI AG. "Alcantara" is a registered trademark of Alcantara S.p.A. "Bang & Olufsen" is a registered trademark of Bang & Olufsen. The BLUETOOTH word mark and logos are owned by the Bluetooth SIG, Inc., and use of any such marks by AUDI AG is under license. "BOSE" and "AudioPilot" are registered trademarks of the Bose Corporation. "GOOGLE" is a trademark of Google Inc. "HD Radio" and the HD Radio logo are proprietary trademarks of iBiquity Digital Corporation. "Homelink" is a registered trademark of Johnson Controls Technology Company. "ICEpower" is a registered trademark of Bang & Olufsen. "iPod" is a registered trademark of Apple, Inc. "Servotronic" is a registered trademark of the AM General Corporation. "Sirius" and all related marks and logos are trademarks of Sirius XM Radio Inc. and its subsidiaries. SiriusXM Satellite Radio and Traffic subscriptions sold separately or as a package after trial expires. SiriusXM Traffic service available in select markets. Subscriptions are governed by SiriusXM Customer Agreement (see www.siriusxm.com) and are continuous until you call SiriusXM to cancel. Sirius U.S. Satellite Service available only to those 18 and older in the 48 contiguous U.S.A., D.C. and Puerto Rico (with coverage limitations). "Tiptronic" is a registered trademark of Dr. Ing h.c. F. Porsche AG. All other trademarks are the property of their respective owners. Some European models shown.

2012 | A8
A8 L A8 L W12

Audi of America
Audiusa.com
[Facebook.com/Audi](https://www.facebook.com/Audi)

2011 Audi of America, Inc. Printed in the U.S.A.