



# Q7

Audi Q7

Audi  
Truth in Engineering



# Sometimes too much of a good thing isn't enough.

When you get right down to it, a detail, a small design element revealed in a quick glance, might be the thing you remember most about the Q7. That's why, when designing it, the Audi engineers thought of it more as a cohesive collection of impressive, finely realized details than as just a luxury SUV. Yes, there is a lot to take in with a vehicle that can seat up to seven. But maybe you'll recall something more intimate when you look back on it. Maybe you fell in love with the grain of the burled wood inlays, or the touch of the standard leather seating surfaces. It could have been the ability to stay engaged with the world through an available mobile Wi-Fi hotspot, or the available TDI® clean diesel model that gets an estimated combined 20 mpg.<sup>1</sup> Maybe you never even noticed the signature space, handling and comfort of the Q7. Too much of a good thing? We didn't think so.

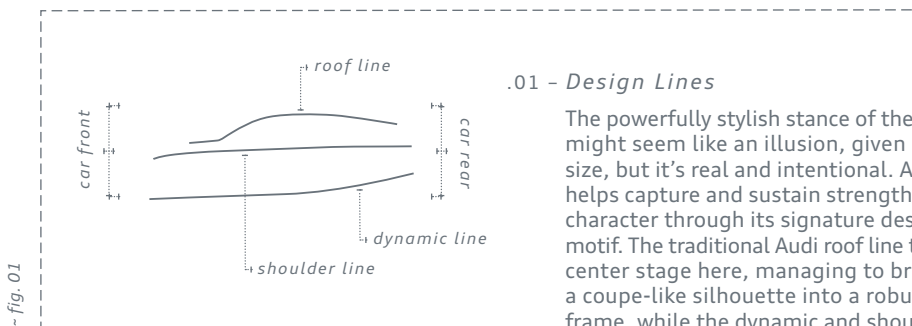

## .01 - Design Lines

The powerfully stylish stance of the Q7 might seem like an illusion, given its size, but it's real and intentional. Audi helps capture and sustain strength and character through its signature design motif. The traditional Audi roof line takes center stage here, managing to bring a coupe-like silhouette into a robust frame, while the dynamic and shoulder lines help divide the body into a sporty, elegant upper section and a dynamic, rugged lower section, something to notice if you see it glide by.

<sup>1</sup> 17 city/25 highway/20 combined mpg (2012 Q7 3.0 TDI® with eight-speed Tiptronic® automatic transmission); 16 city/22 highway/18 combined mpg (2012 Q7 3.0T with eight-speed Tiptronic® automatic transmission). EPA estimates. Your mileage will vary.

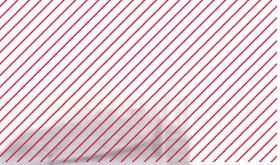

## .02 - *Lightweight Design*

To help enhance efficiency<sup>1</sup> while maintaining exceptional performance, Audi strives to lower the curb weight of all its vehicles, and the Q7 is no exception. By using a 3.0-liter V6 with forced induction that delivers power on par with a traditional V8, and by using aluminum where practical, the Audi Q7 loses nothing but pounds—by design.



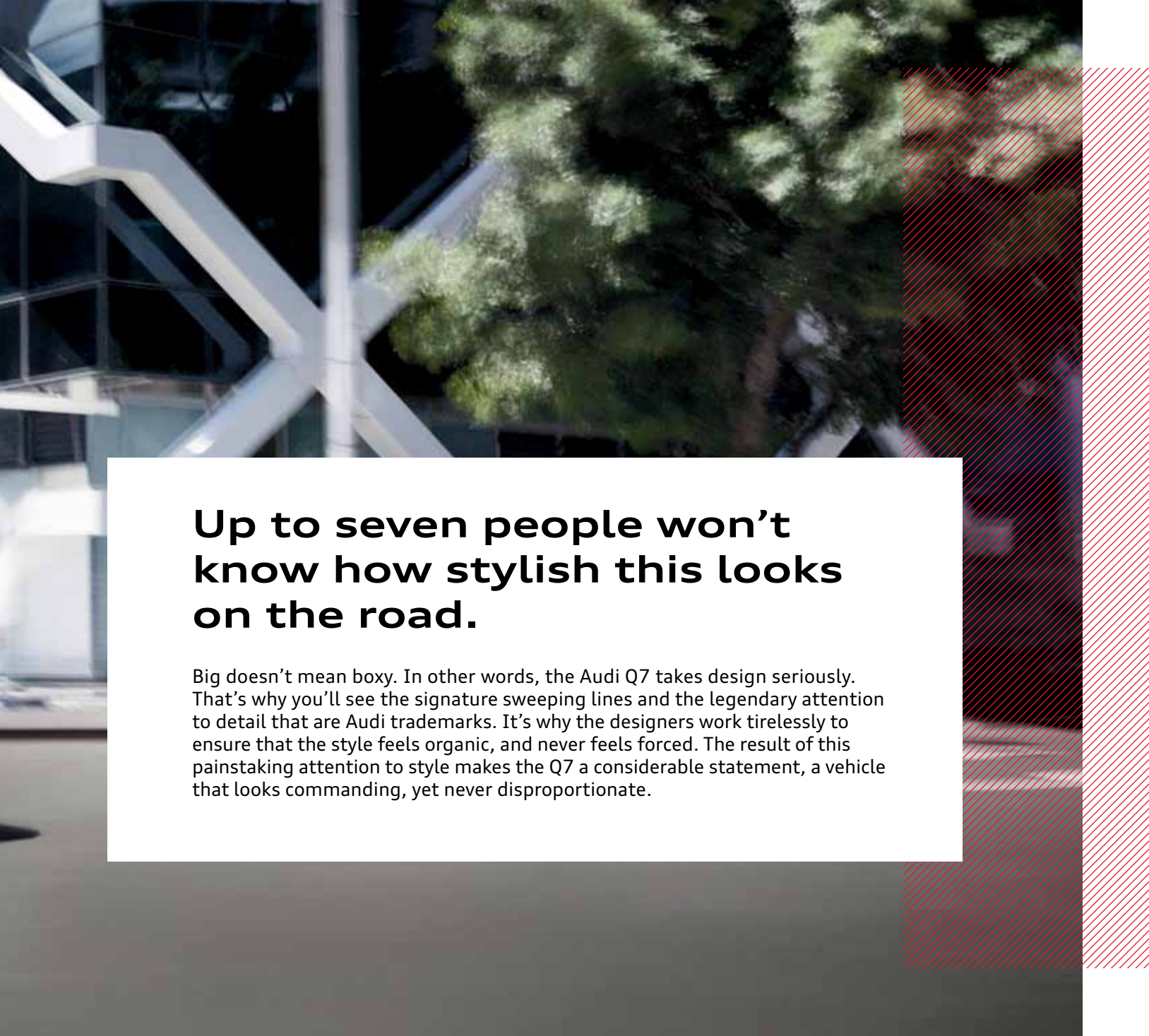

## **Up to seven people won't know how stylish this looks on the road.**

Big doesn't mean boxy. In other words, the Audi Q7 takes design seriously. That's why you'll see the signature sweeping lines and the legendary attention to detail that are Audi trademarks. It's why the designers work tirelessly to ensure that the style feels organic, and never feels forced. The result of this painstaking attention to style makes the Q7 a considerable statement, a vehicle that looks commanding, yet never disproportionate.

# Sees to be seen.

When it comes to functionality and style in the Q7, the two seem to be twins. It's almost impossible to find one without the other. They are a particularly beautiful and memorable pair in the available LED daytime running lights and standard LED taillights, each complementing the other's strengths. But you see this combination everywhere. In how the available adaptive xenon plus headlights help illuminate the bends and corners in the road more effectively.

## .03 - LED Daytime Running Light Technology

Stylish and iconic, available LED daytime running lights enhance the unmistakable look and design of the Audi Q7, as well as its visibility to other drivers.

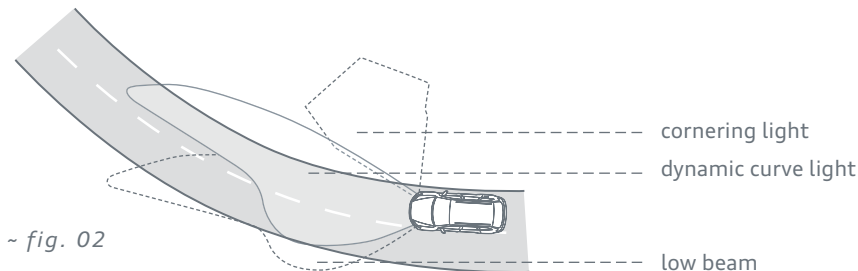

## .04 - Adaptive Xenon Plus Headlights

Available on the Q7, Audi adaptive xenon plus headlights redefine "bright idea." Twice as bright as traditional halogen bulbs, they better illuminate the path ahead. And by shifting in response to steering input, they can help alert you by seeing more of the road in front of you while you are turning.

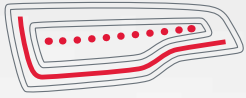

~ fig. 03

#### .05 - LED Taillight Technology

Bright and sleek, these light-emitting diode taillights help convey crucial information—such as the fact that you're braking. LEDs illuminate faster than a traditional bulb, helping give the drivers behind you more time to react.



# With potentially 14 hands touching it, we knew we'd need a lot of leather.

This is what an Audi looks like. We like to say there is Truth in Engineering®, but we also know there's more. There's Truth in everything we do, including the Truth in the interior of the Q7. You see it in the burnished, authentic wood inlays. You see it in the aluminum accents that add a gleaming character to the large, useful space, and in a choice of uniquely colored leather on interior surfaces. As you feel it, see it, experience it, you discover a material truth of Audi: We go to seemingly any lengths—even 144.1 cu ft—to design a space and fill it with luxurious materials that provide unsurpassed comfort and versatility, as well as the fit and finish you would expect from Audi.

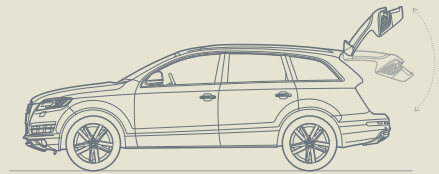

~ fig. 04

## .06 - Power Rear Tailgate

Carefully integrated into the rear design, the power rear tailgate on the Q7 gives you programmable endpoints so you can adjust the opening to the height you choose, better to accommodate personal preferences and tighter spaces.

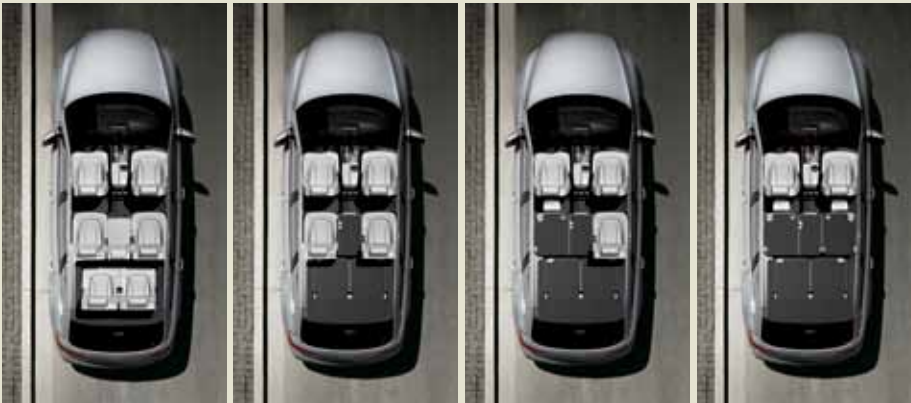

## .07 - Seven Seats

We take comfort seriously for all seven potential occupants in the Q7, with sumptuous, supple leather seating surfaces, 12-way power adjustable front seats, as well as reclining and sliding second-row seats. We take functionality seriously too, with second- and third-row seats that can be easily folded without removing the headrests to provide extra cargo capacity, while an overall design flexibility allows for 28 possible seating and cargo configurations.



## .08 - Cargo Capacity

Perfect for the family road trip or the golf weekend, the Q7 brings the goods when it comes to bringing the luggage. With 10.9 cu ft of cargo capacity with all the rows up, and up to 72.5 cu ft with the second and third row folded down, there's room for just about anything you'd want to pack, and most likely room to spare. Leaving you with only one worry—where you want to go.



.09 - *Lower Anchors and Tethers for Children (LATCH)*

Standard in the second- and third-row outboard seats, the LATCH system, combined with the possibilities offered by the Q7 seating configurations, gives you flexibility when your children are your passengers.





#### .10 - *Ventilated Front Seats*

Available front seat ventilation offers multiple speeds of cooling, which, along with front seatback nets and useful storage compartments in the doors, center console and cargo area, provide comfort and convenience throughout.



# Give your senses some free time.

Maybe it's on a fine spring day, or when you are anticipating a great weekend, that you open the available panoramic sunroof and the cabin floods with light—at that moment, everything seems right. You put on a song that moves you. Hear it through a superior sound system. Then bask in the refreshing comfort that available ventilated front seats provide. Realize that you have just created the perfect environment to liberate your senses. Welcome to your Q7.

## .11 - BOSE® Surround Sound

BOSE® designed its surround sound to meet the unique size requirements of the Q7, using the dimensions of the space itself to optimize the effect. Making the most of speaker positioning and the cabin acoustics, the available BOSE® system helps deliver a crisp, engaging sound, and a deep and immersive sonic experience. And with the unique noise compensation technology of AudioPilot®, you can spend less time adjusting the volume and more time enjoying the music.



Dedicated to the idea of “honest music reproduction,” Bang & Olufsen® has created a sound engineer’s dream. An available 1,000-watt advanced sound system brilliantly re-creates music using 14 enclosed speakers, including two acoustic lens tweeters, placed throughout the cabin. The system features revolutionary matchbook-sized ICEpower® amplifiers to supply power to all 14 speakers. Bang & Olufsen® is set on music reaching your ears by transcending the limits of audio technology. In other words, they design systems for the human heart as much as for the human ear.



The available panoramic sunroof brings seemingly endless light to your ample interior cabin. The front and rear glass elements can be tilted, and the front panel can be opened, and if you should need a break from the sun, the sunroof features a power sunshade in the front and a manual sunshade in the rear.



38° 57' 8.1" N  
77° 23' 41.1" W

# No one connects you the way we do.



Challenging conventions is easier when you make new ones. We took that to heart and set out to change how people interact in and out of their automobiles. A suite of available class-leading technologies has made the Q7 a true champion for progress. Just consider Audi connect™ with Google Earth™, and Wi-Fi connectivity<sup>1</sup> for up to eight devices, which gives every passenger a seemingly endless stream of entertainment options. No other luxury automotive company in the U.S. offers this level of connectivity. Audi amplifies your interactive life while simultaneously enhancing your ownership experience.

33° 46' 3.1" N  
118° 11' 26.5" W



<sup>1</sup> Requires a data subscription plan. Distracted driving can cause a loss of vehicle control. The features and technologies discussed above are offered for convenience, and should be used only when it is safe and appropriate. The Wi-Fi hotspot feature is intended for passenger use only. Always pay careful attention to the road, and do not drive while distracted. <sup>2</sup> See back cover for important information regarding required SiriusXM subscriptions.

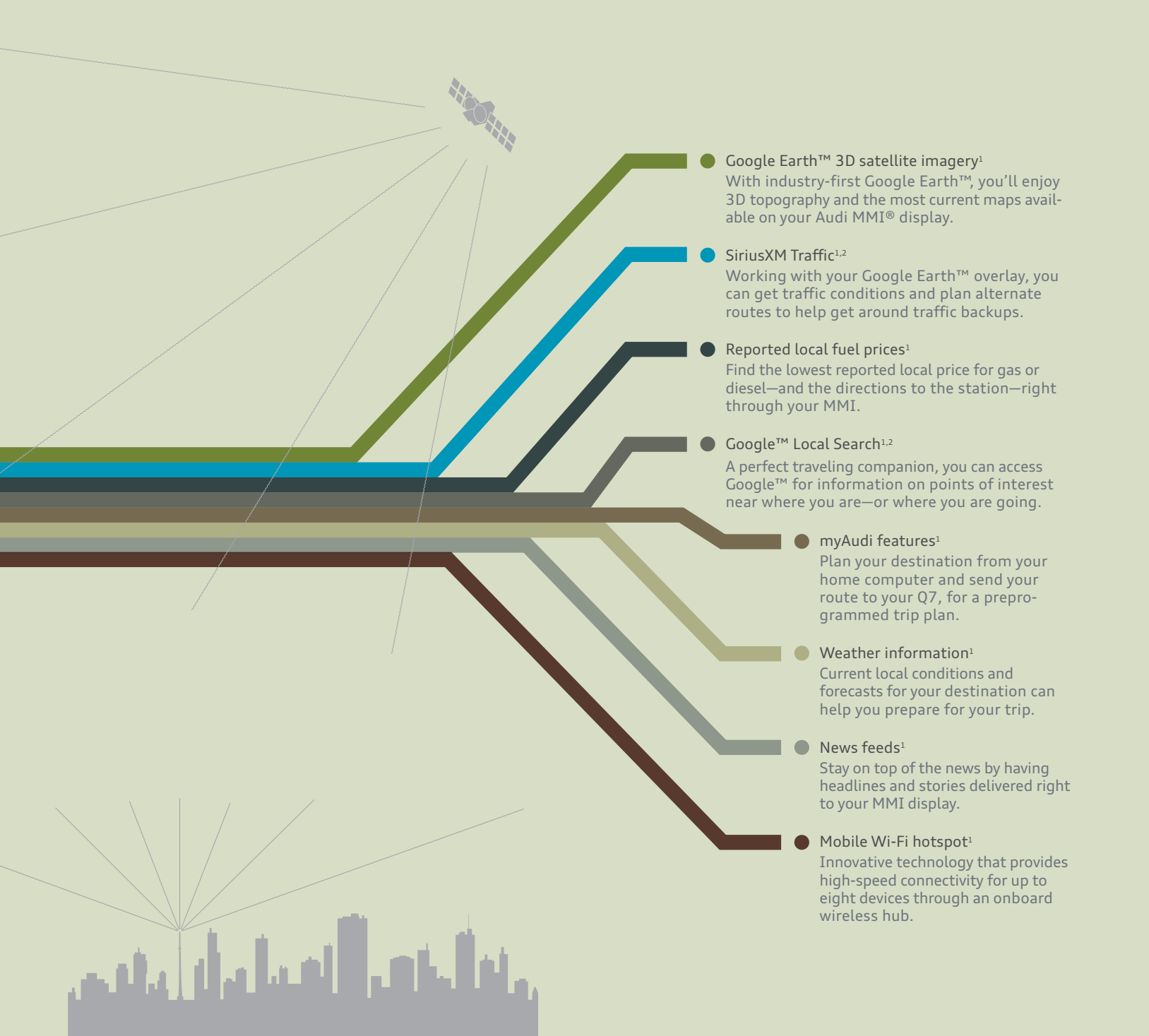

● **Google Earth™ 3D satellite imagery<sup>1</sup>**  
With industry-first Google Earth™, you'll enjoy 3D topography and the most current maps available on your Audi MMI® display.

● **SiriusXM Traffic<sup>1,2</sup>**  
Working with your Google Earth™ overlay, you can get traffic conditions and plan alternate routes to help get around traffic backups.

● **Reported local fuel prices<sup>1</sup>**  
Find the lowest reported local price for gas or diesel—and the directions to the station—right through your MMI.

● **Google™ Local Search<sup>1,2</sup>**  
A perfect traveling companion, you can access Google™ for information on points of interest near where you are—or where you are going.

● **myAudi features<sup>1</sup>**  
Plan your destination from your home computer and send your route to your Q7, for a pre-programmed trip plan.

● **Weather information<sup>1</sup>**  
Current local conditions and forecasts for your destination can help you prepare for your trip.

● **News feeds<sup>1</sup>**  
Stay on top of the news by having headlines and stories delivered right to your MMI display.

● **Mobile Wi-Fi hotspot<sup>1</sup>**  
Innovative technology that provides high-speed connectivity for up to eight devices through an onboard wireless hub.

# quattro



~ fig. 05

## .12 - Audi quattro®

The engineering behind legendary Audi quattro® all-wheel drive is based around a torque-sensing, self-locking center differential that shifts torque almost instantaneously to where it's needed. For the driver, that means Audi quattro® is adjusting power between front and rear axles more than 100 times a second, from a 40:60 rear bias in good conditions to other balanced variables as conditions change, helping to ensure that torque is delivered to the wheels where traction exists, for better control.



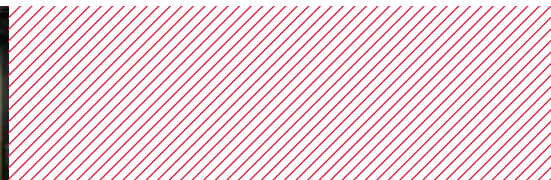

## Throw the road for a curve.

We've found that teamwork is the best remedy for loss of traction. That's why the Q7 delivers its impressive performance through the Audi quattro® all-wheel drive system that helps grip the road. More than a bad weather security blanket, Audi quattro® is the key to more dynamic handling and performance that shines through in all seasons and in practically all kinds of weather—rain or shine.

Still, for those familiar with the more traditional use of all-wheel drive, it's nice to feel the balance of Audi quattro® as Mother Nature turns challenging. Knowing that the weather won't keep an Audi driver inside, we made sure that the enhanced traction helps Q7 owners take advantage of their impressive towing capacity (up to 6,600 lb) even when conditions aren't quite perfect.<sup>1</sup>

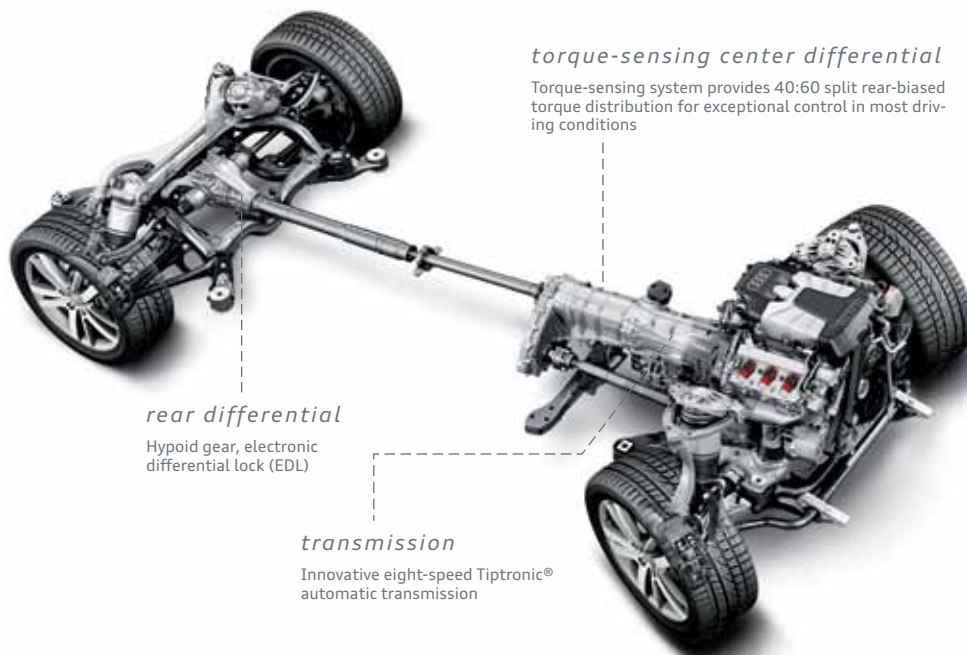

<sup>1</sup> When properly equipped with available Towing Package. For more information on towing, see your owner's manual.

# We've built a powerful case for efficiency.

One way we express Truth in Engineering® is by building on the Audi legacy of efficiency without power loss.<sup>1</sup> And the Q7 doesn't take performance lightly. Featuring two available supercharged V6 engines and one TDI® clean diesel choice, we carry on the tradition of getting the most out of your Audi.

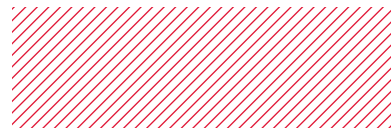

Bolstered by the lively 3.0 TFSI® V6 that produces 280 hp and a strong 295 lb-ft of torque, the Q7 starts with strength that comes standard. More performance-driven types can choose the S line® Prestige model with the 333-hp supercharged 3.0 TFSI V6 that generates an immense 325 lb-ft of torque. Those with greater fuel efficiency in mind can turn to the 3.0 TDI® clean diesel. Using a combination of direct injection and turbocharging, the Q7 3.0 TDI clean diesel delivers 17 city/25 highway mpg.<sup>1</sup>

No matter which Q7 model is right for you, each engine is perfectly complemented by the strong and precise eight-speed Tiptronic® automatic transmission. Optimized for precise power delivery and, in the upper range, fuel economy,<sup>1</sup> this innovative transmission keeps you in charge. Choose manual or automatic modes for nimble shifting and smoother acceleration. In either mode, it's a thrill.



# 325 lb-ft



### 3.0 TFSI

Fuel economy: 16 city/22 hwy/18 combined mpg<sup>1</sup>  
Horsepower: 280 hp @ 4,920 rpm  
Torque: 295 lb-ft @ 2,250 rpm

### 3.0 TFSI S line Prestige

Fuel economy: 16 city/22 hwy/18 combined mpg<sup>1</sup>  
Horsepower: 333 hp @ 5,500 rpm  
Torque: 325 lb-ft @ 2,900 rpm



# TDI Clean Diesel

## Progress by the gallon.

In the realm of high efficiency, all fuels are not created equal—or engines for that matter. Consider the Audi TDI® clean diesel engine, which has achieved ultra-low emissions vehicle (Bin5/ULEV) status in all 50 states while producing 20 percent less CO<sub>2</sub> emissions than comparably sized gasoline engines. At 17 city/25 hwy mpg,<sup>1</sup> it's more fuel-efficient than its gas-fed competitors. And when you add in the off-the-line acceleration that its 225 hp and astonishing 406 lb-ft of torque provide, you'll understand the true power of progress.<sup>2</sup>

### 13 - The Difference in Diesel

When it comes to diesel, density is destiny. By having greater density than gasoline, diesel packs more energy content in the same amount of fuel, which helps maximize the miles per gallon when that energy is released during a more powerful combustion.

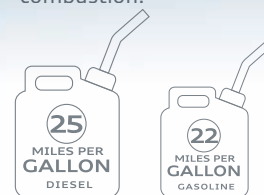

## .14 - Superior Range

With a range that, under normal highway conditions, easily surpasses 600 miles between fill-ups and handily beats the range of a comparable gasoline engine, the Q7 TDI clean diesel is the ideal companion on a long weekend getaway.<sup>3</sup> For example, one could travel from Boston, Massachusetts, to Williamsburg, Virginia, on a single tank of fuel.



Gasoline—up to 580 miles

Diesel—up to 660 miles

## .15 - Why It's Good to Combust

Combustion, is, of course, how fuel is transformed into power. What makes diesel combustion most impressive is how it is more efficiently consumed by your TDI clean diesel engine. Innovative, advanced direct injection technology makes the Q7 TDI clean diesel very responsive to the throttle, yet more fuel-efficient and emissions-low in output.

~ fig. 06 - Combustion Efficiency

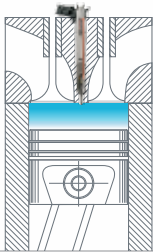

Compression

A significantly higher compression ratio and cylinder pressure in the combustion chamber means fuel is fully atomized. The advantage is optimized turbocharger boost and fuel efficiency.

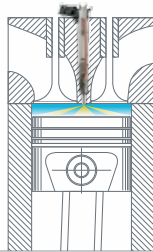

Direct Injection

The high-pressure direct injection is an important part of the TDI engine's remarkable horsepower and torque. By mixing the precise amount of fuel and air in the chamber, maximum combustion and maximum power is achieved.

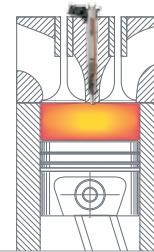

Combustion

Combining the high-compression ratio with direct injection allows for a more thorough combustion, helping ensure a highly efficient and lower emissions process.

Illustrations do not reflect actual operation and are for explanatory purposes only.

## .16 - Engineered for More Torque

Audi uses a classic technological principle—leverage—to help deliver more torque. With TDI clean diesel engines, the piston travels farther through a deeper crankshaft throw, while a longer connecting rod acts as the fulcrum, helping produce more lb-ft of torque via the long stroke. And you feel the end result in the way your Q7 accelerates, with a powerful burst of torque-driven response.

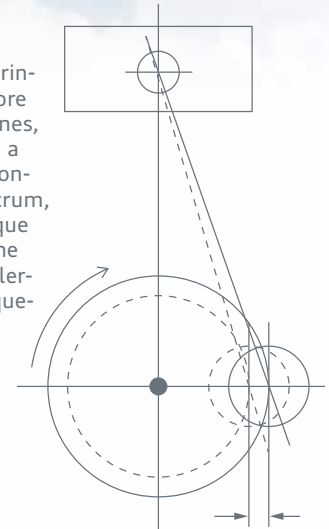

~ fig. 07

1 17 city/25 highway/20 combined mpg (2012 Q7 3.0 TDI® with eight-speed Tiptronic® automatic transmission); 16 city/22 highway/18 combined mpg (2012 Q7 3.0T with eight-speed Tiptronic® automatic transmission). EPA estimates. Your mileage will vary. 2 Always obey local speed and traffic laws. 3 17 city/25 highway/20 combined (2012 Q7 3.0 TDI® with eight-speed Tiptronic® automatic transmission). EPA estimates. Range based on 25-mpg highway EPA estimates and a 26.4-gallon fuel tank. Your mileage will vary.

# Anticipating needs you didn't know you had.

Five senses are established. A sixth sense, some innate vision of future events, is now practically accepted. So Audi engineers had to come up with something even more dramatic. The Seventh Sense. The suite of driver-assistance technologies we offer on the Q7 is comprehensive, side to side, back to front, even taking into account distractions of other drivers under certain circumstances. From seemingly sentient available Audi adaptive cruise control to intuitive parking system warnings in the front and rear, Audi has incorporated innovative, reactive technologies that don't see your future so much as change it.

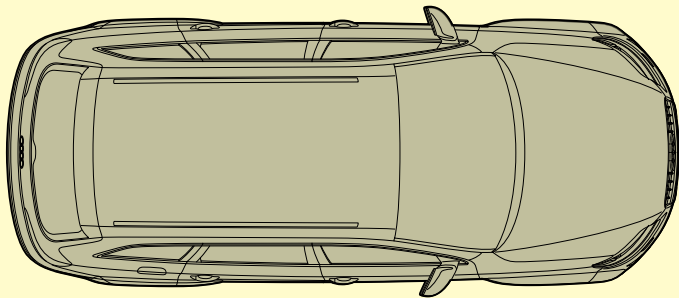

*.17 - Audi Side Assist*

Active at speeds over 19 mph, available Audi side assist helps monitor blind spots and fast-approaching vehicles at a range of 150 ft from the rear. When a vehicle is present within the monitored area, the system warns you via LED lights in the exterior mirrors.

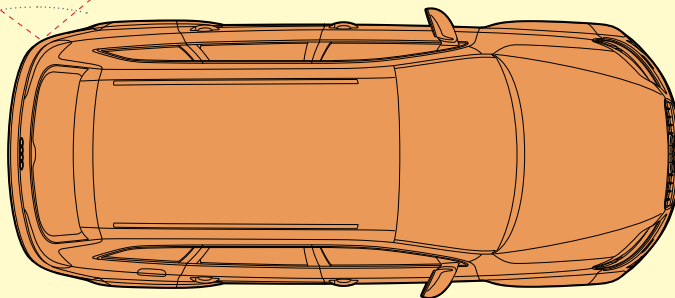

*.18- Audi Adaptive Cruise Control*

Available adaptive cruise control on the Audi Q7 raises the bar on driving convenience, as its long-range radar measures the distance to the vehicle ahead, sends its data to a computer that weighs the information against velocity and other road variables, and applies the brakes as necessary.

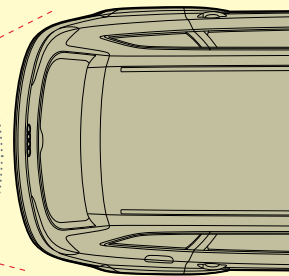

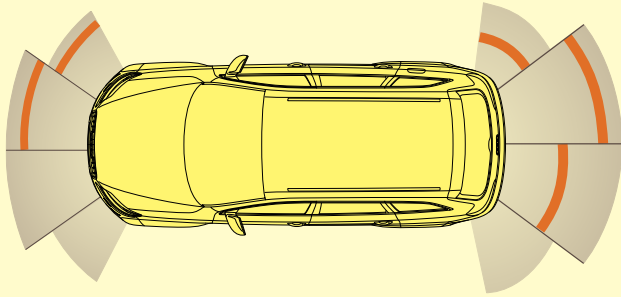

### .19 - Parking System with Front and Rear Sensors

Available front and rear parking sensors use ultrasound waves to sense your position and warn when approaching nearby stationary objects.

### .20 - Six Standard Airbags

With six standard airbags that include front-impact, front side and side curtain airbags for both driver and passengers and available rear side airbags for an available airbag total of up to eight, you'll feel practically surrounded!<sup>1</sup> And that's a good thing.

Dramatization<sup>2</sup>



<sup>1</sup> Airbags are supplemental restraints only and will not deploy under all crash circumstances. Always use safety belts and seat children only in the rear, using restraint systems appropriate for their size and age. <sup>2</sup> This is a dramatization and does not depict what will happen in a collision. All bags will not inflate in real-world collisions, and if multiple bags do deploy they will be in various stages of inflating/deflating and will never all be inflated at the same time.

## Accessories

Imagine a cherry on top of your sundae. Sweet, right? Now imagine a cherry that helps protect your Q7 in the garage. Or carries your bikes for a serious weekend on the trails. Or makes heads turn as you drive by. Audi Genuine Accessories are the little extras that make your Audi even sweeter. Designed by the same visionaries who designed your



### *20" Annapurna Alloy Wheel and Tire Package*

The striking 20" wheels are paired with all-season tires for excellent year-round performance.

### *20" Pikes Peak Alloy Wheels*

A bold and powerful design that lives up to its famous namesake.



### *Off-road Styling Kit*

Give your Q7 a more rugged appearance. Includes door guards, wheel arch protectors, front and rear valances.



### *Towing Hitch*

This towing hitch is approved for the maximum load-carrying capacity of 5,500 lb for a properly equipped Audi Q7. For more information on towing, see your Owner's Manual.

### *All-weather Floor Mats*

Deep-ribbed, channeled design helps protect the floor and carpeting from water, mud, sand and snow. Rubber mats feature vehicle logo. Set of four mats.



*Other accessories not shown* -----

### *Various Transport Solutions*

The open road is calling—so bring all the right gear to enjoy the ride. The Audi line of storage accessories helps protect your possessions with a variety of intelligent and innovative solutions. Choose from bike racks, ski racks and a variety of cargo carriers.

### *Comfort and Protection Solutions*

Audi Genuine Accessories offer a wealth of practical aids for more space, tidiness and safety on board with functional items to help keep your Audi in pristine condition. Use them all to help reduce wear and tear on your Audi and help keep it looking like new—inside and out.

vehicle, all accessories feature a tailored fit and the expert craftsmanship you'd expect from Audi. They are also backed by the 4-year/50,000-mile Audi New Vehicle Limited Warranty or the accessory's 12-month/12,000-mile limited warranty, whichever extends longer from the accessory purchase date.<sup>1</sup>



#### *Interior-mounted Bike Rack*

Conveniently and securely transports your bikes inside the Q7. Bikes are secured with tension straps that attach to the tie-down hooks. Transports two bikes.



#### *Rear Seat Cover*

Fits the second-row seat to help protect it from dirt and pet hair. A tough nylon surface stands up to abuse while contoured construction and headrest straps help hold it firmly in place. (Not shown in Q7.)

#### *Reversible Mat*

This reversible mat helps offer extra protection for your cargo area. Velour on one side, rubber on the other. Also features a fold-out protective liner to help protect the loading sill and bumper.



#### *Base Carrier Bars*

Attached to strong side brackets, these are the durable foundation of the Audi roof-rack system. (All roof-rack system attachments require the base carrier bars. All attachments sold separately.)

#### *Compact Cargo Carrier*

A trim, aerodynamic design that offers a generous 16.95-cu-ft capacity. Size: 81" long, 30" wide, 15" high.

#### *Car Care*

Use the only car care line specifically designed with your Audi vehicle in mind. Audi Guard car care products provide gentle cleansing formulas and special tools to help give interior and exterior surfaces the finest in cleaning and protection.

#### *License Plate Frames*

Choose from "Audi Sport" in carbon fiber, black powder-coat, polished and brushed finishes or "Truth in Engineering®" in polished and carbon fiber finishes. (Check local laws and regulations regarding use.)

#### *Electronic Accessories*

The many electronic accessories in your Audi are renowned for design that emphasizes user experience. All products are tested to ensure compatibility with your vehicle's electrical systems so that you can easily enjoy what Audi technology has to offer.

# Colors

*exterior*

*interior*

Ibis White

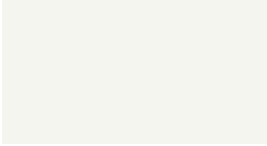

Ice Silver metallic



Graphite Gray metallic



Daytona Gray pearl



Lava Gray pearl



Mugello Blue pearl



Cobalt Blue metallic



Orca Black metallic



Teak Brown metallic

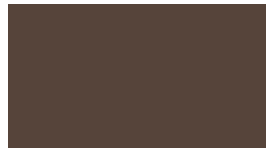

Black leather



Limestone Gray leather



Cardamom Beige leather



Espresso Brown leather





# Color Combinations

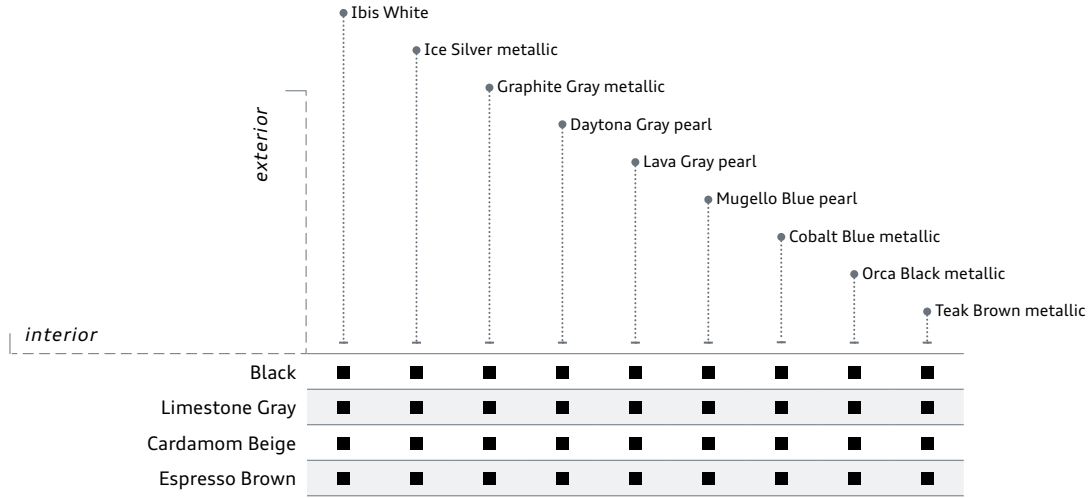

■ Available combinations



## Decorative Inlays

Black  
Natural Walnut Wood inlay



Limestone Gray  
Natural Walnut Wood inlay



Cardamom Beige  
Natural Walnut Wood inlay



Espresso Brown  
Natural Walnut Wood inlay



Black  
Brushed Aluminum inlay S line® only

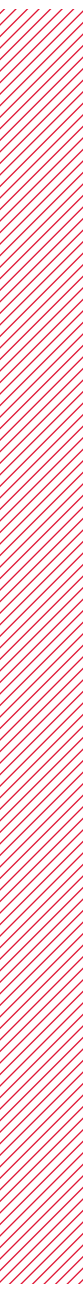

# Wheels

18" 6-arm design  
255/55 all-season tires



Q7 3.0T Premium, Premium Plus—standard

19" 5-arm-structure design  
265/50 all-season tires



Q7 3.0T Premium, Premium Plus—optional  
Q7 TDI® Premium, Premium Plus—standard

20" 10-spoke V design  
275/45 all-season tires



Q7 3.0T Premium Plus—optional  
Q7 TDI® Premium Plus—optional  
Q7 TDI® Prestige—standard

20" 5-spoke S line®  
275/45 all-season tires



Q7 3.0T S line® Prestige—standard

21" 5-segment-spoke design  
295/35 summer performance tires<sup>1</sup>



Q7 3.0T S line® Prestige—optional  
Q7 TDI® Prestige—optional

21" titanium 5-segment-spoke design  
295/35 summer performance tires<sup>1</sup>



Q7 3.0T S line® Prestige—S line® plus Package  
Q7 TDI® Prestige—S line® plus Package

<sup>1</sup> Tires are supplied and warranted by their manufacturer. High-performance tires are designed for optimum performance and handling in warm climates. They are not suitable for cold, snowy, or icy weather conditions. If you drive under those circumstances, you should equip your vehicle with all-season or winter tires, which offer better traction under those conditions. We suggest you use the recommended winter or all-season tire specified for your car or its equivalent. These high-performance tires also have a lower aspect ratio that aids performance and handling; however, in order to avoid tire, rim or vehicle damage, it is important that the inflation pressure is regularly checked and maintained at optimum levels. Please also remember in making your selection that, while these tires deliver responsive handling, they may ride less comfortably and make more noise than other choices. <sup>2</sup> Always obey local speed and traffic laws.

# Configurations | Dimensions

	Q7 Premium	Q7 Premium Plus	Q7 S line® Prestige	Q7 TDI® Premium	Q7 TDI® Premium Plus	Q7 TDI® Prestige
--	------------	-----------------	---------------------	-----------------	----------------------	------------------

## Q7 Models

3.0T with eight-speed Tiptronic® automatic transmission and Audi quattro® all-wheel drive	■	■	—	—	—	—
3.0T with eight-speed Tiptronic® automatic transmission and Audi quattro® all-wheel drive	—	—	■	—	—	—
3.0 TDI® with eight-speed Tiptronic® automatic transmission and Audi quattro® all-wheel drive	—	—	—	■	■	■

## Q7 Engine Specifications

3.0-liter supercharged: Dual intercoolers, DOHC V6 gasoline engine with Audi TFSI® direct injection and variable valve timing. Horsepower: 280 hp @ 4,920 rpm / Torque: 295 lb-ft @ 2,250 rpm	■	■	—	—	—	—
3.0-liter supercharged: Dual intercoolers, DOHC V6 gasoline engine with Audi TFSI® direct injection and variable valve timing. Horsepower: 333 hp @ 5,500 rpm / Torque: 325 lb-ft @ 2,900 rpm	—	—	■	—	—	—
3.0-liter turbocharged: Intercooled, DOHC V6 clean diesel engine with Audi TDI® direct injection. Horsepower: 225 hp @ 3,750 rpm / Torque: 406 lb-ft @ 1,750 rpm	—	—	—	■	■	■

## Q7 Performance Specifications

	0 – 60 mph <sup>2</sup>	Top Speed <sup>2</sup> (electronically limited)
3.0T with eight-speed Tiptronic® automatic transmission and Audi quattro® all-wheel drive	7.7 seconds	130 mph
3.0T with eight-speed Tiptronic® automatic transmission and Audi quattro® all-wheel drive (S line® Prestige)	6.9 seconds	130 mph
3.0 TDI® with eight-speed Tiptronic® automatic transmission and Audi quattro® all-wheel drive	8.0 seconds	130 mph

## Exterior Dimensions

Length: 200.3"	Track, front: 65.0"
Width: 85.7"	Track, rear: 66.0"
Height: 68.4"	Wheelbase: 118.2"
Ground clearance: 8.1" (loaded), 9.4" (loaded—with Audi adaptive air suspension)	

## Interior Dimensions

Head room (with panoramic sunroof): 40.0" (front), 37.2" (middle), 35.4" (rear)
Head room (without panoramic sunroof): 39.5" (front), 39.0" (middle), 35.6" (rear)
Leg room: 41.3" (front), 37.1" (middle), 29.2" (rear)
Shoulder room: 58.7" (front), 58.1" (middle), 48.6" (rear)
EPA cargo capacity behind third row: 10.9 cu ft
EPA cargo capacity behind second row: 42.0 cu ft
EPA cargo capacity behind first row: 72.5 cu ft
EPA interior volume: 55.4 cu ft (front), 48.6 cu ft (middle), 29.2 cu ft (rear)

## Fuel Economy Estimates, City / Highway / Combined

Q7 3.0T: 16/22/18
Q7 3.0T S line® Prestige: 16/22/18
Q7 TDI®: 17/25/20
EPA estimates. Your mileage will vary. See <a href="http://www.fueleconomy.gov">www.fueleconomy.gov</a> for details.

## Weights and Capacities

Curb weight (3.0T/3.0T S line® Prestige/TDI®): 5,291 lb/5,412 lb/5,567 lb
Engine oil capacity (3.0T/TDI®): 8.5 qt/8.6 qt
AdBlue® (TDI®): 6 gal
Fuel tank capacity: 26.4 gal

# Specifications

	Q7 Premium	Q7 Premium Plus	Q7 S line® Prestige	Q7 TDI® Premium	Q7 TDI® Premium Plus	Q7 TDI® Prestige
<b>Chassis   Technical</b>						
Fully galvanized steel unibody with multistep anti-corrosion protection—aluminum hood, fenders, and tailgate	■	■	■	■	■	■
Front double wishbone suspension with stabilizer bar	■	■	■	■	■	■
Independent four-link rear suspension	■	■	■	■	■	■
Audi adaptive air suspension	—	—	□	—	—	□
Audi servotronic® speed-sensitive power steering—varies assistance based on vehicle speed	■	■	■	■	■	■
Audi quattro® all-wheel drive system utilizing self-locking center differential—40:60 rear-biased torque split	■	■	■	■	■	■
Eight-speed Tiptronic® automatic transmission	■	■	■	■	■	■
Trailer hitch provision with 5,500-lb maximum towing capacity and 550-lb tongue weight	■	■	■	■	■	■
Towing Package with 6,600-lb maximum towing capacity and 660-lb tongue weight—includes tow bar and increased cooling capacity	□	□	□	□	□	□
<b>Safety   Security</b>						
Driver and front passenger dual stage airbags, thorax side airbags and Sideguard® head curtain airbags <sup>1</sup>	■	■	■	■	■	■
Rear-passenger thorax side airbags (second row only) <sup>1</sup>	□	□	□	□	□	□
Front passenger occupant detection—for airbags	■	■	■	■	■	■
Safety belt reminder for driver and front passenger	■	■	■	■	■	■
Lower Anchors and Tethers for Children (LATCH) in second- and third-row seating positions	■	■	■	■	■	■
Power central locking system with safety unlock feature if airbags deploy	■	■	■	■	■	■
Electronic Stability Control (ESC) with off-road mode, rollover mitigation, and traction control (ASR)	■	■	■	■	■	■
Anti-lock Brake System (ABS) with Electronic Brake-pressure Distribution (EBD) and brake assist	■	■	■	■	■	■
Hill descent control	■	■	■	■	■	■
Front ventilated disc brakes	■	■	■	■	■	■
Rear ventilated disc brakes	■	■	■	■	■	■

■ Standard   □ Optional   — N/A

Q7 Premium  
 Q7 Premium Plus  
 Q7 S line® Prestige  
 Q7 TDI® Premium  
 Q7 TDI® Premium Plus  
 Q7 TDI® Prestige

## Infotainment | Technology

Audi MMI® Navigation plus with voice control system <sup>2</sup>	□	■	■	□	■	■
Audi connect™ with six-month trial subscription	□	■	■	□	■	■
Color driver information system	□	■	■	□	■	■
Audi sound system with 11 speakers and single CD player with MP3 playback capability	■	-	-	■	-	-
BOSE® Surround Sound with 14 speakers and AudioPilot® noise compensation	-	■	■	-	■	■
Bang & Olufsen® Advanced Sound System with 14 speakers and 1,000 watts	-	-	□	-	-	□
HD Radio™ technology	□	■	■	□	■	■
SiriusXM Traffic with 90-day trial subscription <sup>3</sup>	□	■	■	□	■	■
SiriusXM Satellite Radio with 90-day trial subscription <sup>3</sup>	■	■	■	■	■	■
Audi music interface with iPod® integration	■	■	■	■	■	■
BLUETOOTH® wireless technology preparation for mobile phone	■	■	■	■	■	■
Homelink® remote transmitter	■	■	■	■	■	■
Audi advanced key—keyless start, stop and entry	-	-	■	-	-	■
Cruise control with coast, resume and accelerate features	■	■	■	■	■	■
Audi adaptive cruise control	-	-	□	-	-	□
Audi side assist	-	-	■	-	-	■
Parking system with rear sensors	■	-	-	■	-	-
Parking system with front and rear sensors	-	■	■	-	■	■
Rain/light sensors for automatic windshield wipers and headlights	■	■	■	■	■	■

1 Airbags are supplemental restraints only and will not deploy under all crash circumstances. Always use safety belts and seat children only in the rear, using restraint systems appropriate for their size and age. 2 Audi Navigation plus depends on signals from the worldwide Global Positioning Satellite network. The vehicle's electrical system and existing wireless and satellite technologies must be available and operating properly for the system to function. The system is designed to provide you with suggested routes in locating addresses, destinations and other points of interest. Changes in street names, construction zones, traffic flow, points of interest and other road system changes are beyond the control of Audi of America, Inc. Complete detailed mapping of lanes, roads, streets, toll roads, highways, etc., is not possible, therefore you may encounter discrepancies between the mapping and your actual location. Please rely on your individual judgment in determining whether or not to follow a suggested Audi Navigation plus route. Periodically mapping updates will be available for purchase at an additional cost. Consult your dealer or call 1-800-FOR-AUDI for details. 3 See back cover for important information regarding required SiriusXM subscriptions.

# Specifications

	Q7 Premium	Q7 Premium Plus	Q7 S line® Prestige	Q7 TDI® Premium	Q7 TDI® Premium Plus	Q7 TDI® Prestige
<b>Exterior</b>						
Audi Singleframe® grille	■	■	■	■	■	■
Halogen headlights with daytime running lights	■	–	–	■	–	–
Xenon plus headlights with LED daytime running light technology	–	■	–	–	■	–
Adaptive xenon plus headlights with LED daytime running light technology	–	–	■	–	–	■
Headlight washers	–	–	■	–	–	□
LED taillight technology	■	■	■	■	■	■
Power-adjustable heated side mirrors	■	–	–	■	–	–
Power-adjustable, power-folding, auto-dimming, heated side mirrors with memory	–	■	■	–	■	■
LED turn indicator light technology integrated in the side mirrors	■	■	■	■	■	■
Aluminum roof rails	■	■	■	■	■	■
Aluminum trim around exterior windows	■	■	■	■	■	■
Contrasting lower body paint finish	■	■	–	–	–	–
Full Paint Finish with Chrome Accent Package—body-color lower body panels, contrast-painted front and rear center valances, and chrome trim applied to bumpers, side sills, and door handles	–	□	–	■	■	■
Running boards	–	□	□	–	□	□
Power rear tailgate	■	■	■	■	■	■
Dual exhaust pipes	■	■	■	■	■	■
Audi S line® exterior appearance	–	–	■	–	–	□

	Q7 Premium	Q7 Premium Plus	Q7 S line® Prestige	Q7 TDI® Premium	Q7 TDI® Premium Plus	Q7 TDI® Prestige
<b>Interior</b>						
Dual-zone automatic climate control	■	■	–	■	■	–
Four-zone automatic climate control	–	□	■	–	□	■
Four-spoke multifunction steering wheel	■	■	■	■	■	■
Three-spoke multifunction steering wheel with shift paddles	–	–	□	–	–	□
Heated steering wheel	□	□	□	□	□	□
Tilt and telescopic manually adjustable steering column	■	■	–	■	■	–
Power tilt and telescopic steering column	–	–	■	–	–	■
Black cloth headliner	–	–	□	–	–	□
Leather seating surfaces	■	■	■	■	■	■
Twelve-way power front seats (includes four-way power lumbar adjustment)	■	■	■	■	■	■
Heated front seats	■	■	■	■	■	■
Ventilated front seats	–	–	■	–	–	■
Driver seat memory	–	■	■	–	■	■
Sliding 40/20/40 split folding second-row seats with adjustable recline	■	■	■	■	■	■
Heated rear seats (second row)	□	□	□	□	□	□
50/50 split folding third-row seats	■	■	■	■	■	■
Power windows with one-touch up/down operation and pinch protection	■	■	■	■	■	■
Manual rear side sunshades (second row)	–	□	■	–	□	■
Rear cargo sunshade	–	□	■	–	□	■
Panoramic sunroof	□	■	–	□	■	–
Panoramic sunroof with deep tint	–	□	■	–	□	■

■ Standard   □ Optional   – N/A



# Packages | Options

	Q7 Premium	Q7 Premium Plus	Q7 S line® Prestige	Q7 TDI® Premium	Q7 TDI® Premium Plus	Q7 TDI® Prestige
--	------------	-----------------	---------------------	-----------------	----------------------	------------------

## Packages

<b>Audi MMI® Navigation plus Package<sup>1</sup>:</b> Audi MMI® Navigation plus with voice control system, Audi connect™ with six-month trial subscription, color driver information system, and HD Radio™ technology	□	■	■	□	■	■
<b>Audi S line® Interior Package:</b> Three-spoke multifunction steering wheel shift paddles, Audi S line® shift knob, brushed aluminum decorative inlays, and black cloth headliner	—	—	□	—	—	—
<b>Audi S line® Package:</b> Headlight washers, Audi S line® exterior appearance, three-spoke multifunction steering wheel with shift paddles, Brushed Aluminum decorative inlays, and black cloth headliner	—	—	—	—	—	□
<b>Audi S line® plus Package:</b> 21" titanium 5-segment-spoke design alloy wheels, summer performance tires <sup>2</sup> , gloss black Audi Singleframe® grille surround, black roof rails, and matte black trim around exterior windows	—	—	□	—	—	□
<b>Towing Package:</b> Trailer hitch package with 6,600-lb maximum towing capacity and 660-lb tongue weight—includes tow bar and increased cooling capacity	□	□	□	□	□	□
<b>Cold Weather Package:</b> Heated steering wheel and heated rear seats (second row)	□	□	□	□	□	□
<b>Warm Weather Package:</b> Four-zone automatic climate control, manual rear side sunshades (second row), rear cargo sunshade, and panoramic sunroof with deep tint	—	□	■	—	□	■
<b>Full Paint Finish with Chrome Accent Package:</b> Body-color lower body panels, contrast-painted front and rear center valances, and chrome trim applied to bumpers, side sills, and door handles	—	□	—	■	■	■

## Individual Options

19" 5-arm-structure design alloy wheels with 265/50 all-season tires	□	□	—	■	■	—
20" 10-spoke V design alloy wheels with 275/45 all-season tires	—	□	—	—	□	■
21" 5-segment-spoke design alloy wheels with 295/35 summer performance tires <sup>2</sup>	—	—	□	—	—	□
Audi adaptive air suspension	—	—	□	—	—	□
Bang & Olufsen® Advanced Sound System with 14 speakers and 1,000 watts	—	—	□	—	—	□
Audi adaptive cruise control	—	—	□	—	—	□
Heated rear seats (second row)	—	—	□	—	—	□
Rear-passenger thorax side airbags (second row only) <sup>3</sup>	□	□	□	□	□	□
Panoramic sunroof	□	■	■	□	■	■
Panoramic sunroof deletion	—	□	□	—	□	□
Running boards	—	□	□	—	□	□

## Audi MMI® Navigation plus Package Highlight



## Warm Weather Package Highlight



## Individual Option Highlights



<sup>1</sup> See Infotainment/Technology section of Specifications for important details and safety information regarding the Audi MMI® Navigation plus system. <sup>2</sup> See Wheels page of this brochure for important safety information regarding summer performance tires. <sup>3</sup> See Safety/Security section of Specifications for important safety information regarding airbags.

Note: A word about this brochure. Audi of America, Inc., believes the specifications in this brochure to be correct at the time of printing. However, specifications, standard equipment, options, fabrics, and colors are subject to change without notice. Some equipment may be unavailable when your vehicle is built. Please ask your dealer for advice concerning current availability of standard and optional equipment, and your dealer will verify that your vehicle will include the equipment you ordered. Vehicles in this brochure are shown with optional equipment. See your dealer for complete details on the New Vehicle Limited Warranty, twelve-year limited warranty against corrosion perforation, and Audi 24/7 Roadside Assistance. (Roadside assistance coverage provided by Road America in the U.S. Certain conditions apply; see your dealer for details.) Tires supplied by various manufacturers. "Audi," all model names, "MMI," "quattro," "Sideguard," "Singleframe" and the Singleframe grille design, "S line," "TFSI," "Truth in Engineering," and the four rings logo are registered trademarks of AUDI AG. "Audi connect" is a trademark of AUDI AG. "AdBlue" is a registered trademark of the Verband der Automobilindustrie. Bang & Olufsen is a registered trademark of Bang & Olufsen. The BLUETOOTH word mark and logos are owned by the Bluetooth SIG, Inc., and use of any such marks by AUDI AG is under license. "BOSE" and "AudioPilot" are registered trademarks of the Bose Corporation. "GOOGLE" is a trademark of Google Inc. "HD Radio" and the HD Radio logo are proprietary trademarks of iBiquity Digital Corporation. "HomeLink" is a registered trademark of Johnson Controls Technology Company. "ICEpower" is a registered trademark of Bang & Olufsen. "iPod" is a registered trademark of Apple, Inc. "Servotronic" is a registered trademark of the AM General Corporation. "Sirius" and all related marks and logos are trademarks of SiriusXM Radio Inc. and its subsidiaries. SiriusXM Satellite Radio and Traffic subscriptions sold separately or as a package after trial expires. SiriusXM Traffic service available in select markets. Subscriptions are governed by SiriusXM Customer Agreement (see [www.siriusxm.com](http://www.siriusxm.com)) and are continuous until you call SiriusXM to cancel. Sirius U.S. Satellite Service available only to those 18 and older in the 48 contiguous U.S.A., D.C. and Puerto Rico (with coverage limitations). "TDI" is a registered trademark of Volkswagen AG. "Tiptronic" is a registered trademark of Dr. Ing. h.c. F. Porsche AG. All other trademarks are the property of their respective owners. Some European models shown.

2012 | Q7

Audi of America  
Audiusa.com  
Facebook.com/Audi

© 2011 Audi of America, Inc. Printed in the U.S.A.