

# A4



# A4

Audi A4

Note: A word about this brochure. Audi of America, Inc., believes the specifications in this brochure to be correct at the time of printing. However, specifications, standard equipment, options, fabrics, and colors are subject to change without notice. Some equipment may be unavailable when your vehicle is built. Please ask your dealer for advice concerning current availability of standard and optional equipment, and your dealer will verify that your vehicle will include the equipment you ordered. Vehicles in this brochure are shown with optional equipment. See your dealer for complete details on the New Vehicle Limited Warranty, twelve-year limited warranty against corrosion perforation, and Audi 24/7 Roadside Assistance. (Roadside assistance coverage provided by Road America in the U.S. Certain conditions apply; see your dealer for details.) Tires supplied by various manufacturers. "Audi," all model names, "Audi connect," "Audi Sport," "MMI," "multitronic," "quattro," "Sideguard," "Singleframe" and the Singleframe grille design, "S line," "S tronic," "TFSI," "Truth in Engineering," and the four rings logo are trademarks or registered trademarks of AUDI AG. "Alcantara" is a registered trademark of Alcantara S.p.A. "Bang & Olufsen" is a registered trademark of Bang & Olufsen. The BLUETOOTH word mark and logos are owned by the Bluetooth SIG, Inc., and use of any such marks by AUDI AG is under license. "GOOGLE," "Google Earth" and "Google Maps Street View" are trademarks of Google Inc. "HD Radio" and the HD Radio logo are proprietary trademarks of iBiquity Digital Corporation. "HomeLink" is a registered trademark of Johnson Controls Technology Company. "iPod" is a registered trademark of Apple, Inc. "SiriusXM" and all related marks and logos are trademarks of SiriusXM Radio Inc. and its subsidiaries. "Tiptronic" is a registered trademark of Dr. Ing h.c. F. Porsche AG. All other trademarks are the property of their respective owners. Some European models shown. Some features may not be available at time of order.

2013 | A4

Audi of America  
Audiusa.com  
Facebook.com/Audi



## Blurring the lines between necessity and desire.

It's surprising how easily want turns into need. Or maybe it's not, especially when you consider the redesigned Audi A4. The A4 delivers not only a driving experience designed to inspire, it provides an unshakable rationale for the need to own it—you deserve a brilliant automobile. Step inside one, and you'll discover the luxury craftsmanship that fully complements the precision engineering. Drive one, and you'll only wonder why you didn't try this sooner. By taking performance cues from the Audi Sport® heritage and a confident style that generates envy in those who don't have one, the A4 makes the case that the difference between "want" and "need" ends at "have."





## Set apart by design.

Audi designers are out to make a point: Style isn't shallow, it's a distinctive mark of depth. In the Audi A4, the thoughtfulness of our design is recognizable instantly. The A4 is a study of perfect proportions and sinuous lines, expressed in the exterior design. But while the world sees the unmistakable profile of an Audi, we also designed it with the understanding that our most important audience sits in the driver's seat. Which is why everything, inside and out, was shaped with a sense of movement in mind—fluid and athletic, something designed to inspire the driver on an emotional level. It's the subtle style that whispers sophistication in a unique and distinctive way.



### .01 - Design Lines

Design that delivers both charm and energy is a design of character. From its driver-centric cabin to the signature flow of its roofline, the A4 is designed with movement built right into it.

~ fig. 01

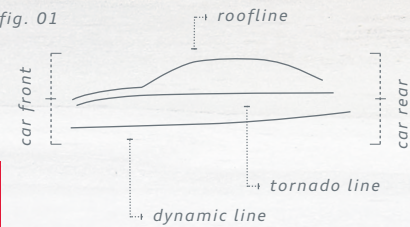





.02 - LED Daytime Running Light Technology

Stylish and iconic, available LED daytime running lights help enhance the unmistakable look and design of the Audi A4, as well as its visibility to other drivers, especially during the dawn and dusk hours.



- fig. 02

## A coupe d'état of traditional power.

It may sound counterintuitive, but power without control is just exposed weakness at high velocity. Our philosophy is simple: power shouldn't go unchecked. We realize it's more important to look beyond horsepower and focus on what true performance should actually feel like. That's why Audi gave the A4 finely tuned driving dynamics and a lighter, more efficient engine, making the A4 nimble enough to turn confidently through even the tightest corners while supplying a potent measure of acceleration when you engage the throttle.<sup>1,2</sup> Our performance delivers the thrust of a broad torque curve and relies less on brute force. Ours is the kind of power that comes from precision tuning, and responsive and innovative engine design—engaging performance as a whole, rather than as just a series of numbers.

2013 Audi A4 2.0T Premium plus shown in Ice Silver metallic.

1 Obey all speed and traffic laws. 2 EPA estimates not available at time of printing. Your mileage will vary.





## Your drive inspires us.

Just by your considering the Audi A4, we know you are the driven type. Someone who prefers the distinctive to the ordinary. The progressive to the past. So it's up to us to deliver an experience that matches your drive. That's why we put an inordinate amount of time into thinking about how your drive will feel from the front seat. To us, the interior is a place to showcase beautifully appointed designs and intuitive, dynamic controls. Everything is designed to work in concert to enhance your drive. Fine materials and crafted finishes make the cabin a sophisticated statement of luxury. An available three-spoke multifunction steering wheel with shift paddles and MMI® controls adds to the feel of performance. Smartly designed dynamic visual displays give you vital information simply and easily. And crisp audio, perfectly calibrated, creates a sonic haven for you and your passengers. Get inside the A4. You'll see how our engineers were inspired to make your drive a revelation.

### 03 - Decorative Inlays

With your choice of available inlays in beautiful wood or aluminum, you will find unparalleled craftsmanship and attention to design throughout the interior. We use only the finest materials inside the cabin to accentuate luxury and sport.



## It's how you feel on the inside.

We think a lot about materials at Audi. How they look, the pattern of their grain, their tactile qualities, and, especially, how they all work together to create the design aesthetic. When we install the stylish appointments in the cabin of the Audi A4, we not only use the finest leather on the seating surfaces, we craft a meticulous environment of harmonious luxury—it's all part of our commitment to delivering the best possible experience to Audi A4 owners. But in addition to your material comfort, we're also concerned with your inner peace. From the moment the available Audi advanced key lets you enter your vehicle without fumbling through your pockets, or the available three-zone climate control lets you and your passengers choose individual temperature settings, you'll know that we care how you feel as much as what you feel. Our thoughtful interior technologies, like available MMI® and Audi advanced key, work perfectly with our interior design to help make everything feel better on the inside.

### .04 - Fit and Finish

Everything in the A4 fits perfectly. Not only is extra attention paid to the design of the shifter and the switch-gear found throughout the cabin, the solid clicks of each interlocking component even give you the sound of quality—quality you've come to expect from Audi.



European model shown with optional equipment.



# quattro

## It's a bond between your car and the road.

It's true that while the available Audi quattro® all-wheel drive may have been engineered to help drive through inclement weather and in low-traction situations, the real magic of this advanced system is how it performs in the dry. Power is distributed to all four wheels working in concert to help grip every corner while giving you the optimal amount of power delivery where and when it's needed. In other words, quattro® helps enhance performance by appropriately transferring power to the necessary wheels when accelerating and turning, so you have confidence-inspiring performance when the road isn't at its best. Inclement weather aside, the really gripping story about quattro® is how it performs overall, forging a sure bond between you, your Audi A4 and the road.<sup>1</sup>

### *Confidence-inspiring*

Under ideal conditions, power is 40:60 rear-wheel-biased to help maximize acceleration and cornering, but the instant conditions become more challenging, the ratio is optimized for superior grip and control.

### *Torque split*

When accelerating out of a turn, up to 80% of the power is mechanically shifted to the rear wheels, where it's best allocated to propel the vehicle to your desired speed and onto the straightaway. Once traveling in a straight line again, the 40:60 power distribution that quattro® delivers to the front and rear wheels, respectively, gives you maximum torque to push onward.

### *Torque vectoring*

It's a handling feature that seems to respond to your impulses before your steering input. An evolution of cross-axle lock, this system works within quattro®, while utilizing ESC and ABS to help sense traction loss from the inside cornering tire.

<sup>1</sup> When driving during cold, rainy, snowy or icy weather conditions, ensure that your vehicle is equipped with appropriate all-season or winter-weather tires. Even with appropriate tires, you must always drive in a manner appropriate for the weather, visibility and road conditions.





## Express yourself out there.

With four different modes expressing your individual driving preferences, the exclusive Audi drive select system available in the Audi A4 helps give you the ability to adjust the vehicle's steering, throttle response, and transmission shift characteristics. It helps you articulate how you want your A4 to respond to the drive. The four modes of Audi drive select cover the full spectrum of driving and road conditions. So whether driving on a winding country road or a busy interstate, there is a mode that helps your vehicle respond the way you want it to. Since the roads you drive are not always optional, we think how you choose to drive them should be.



### .05 - Electric Power Steering

The electromechanical power steering combines precision and comfort with impressive energy-saving technology. It's not only an ideal complement to the available sport-tuned suspension, but requires considerably less energy than a hydraulic system, due to its less complex design. Removing the power steering pump helps reduce parasitic drag, resulting in enhanced efficiency.<sup>1</sup>

#### - Comfort mode

Perfect for less-than-perfect roads, this setting adds optimized steering and a closer shift pattern to help provide a more relaxed drive.

#### - Dynamic mode

More precise steering and a more responsive throttle give this setting an aggressive feel and focused performance.

#### - Auto mode

The best of both worlds, dialed to automatically adjust settings for a seamless combination of comfort and responsiveness based on your driving style and road conditions.

#### - Individual mode

Take the turn your way—this mode allows you to adjust the steering, throttle and transmission upshifts to your style.

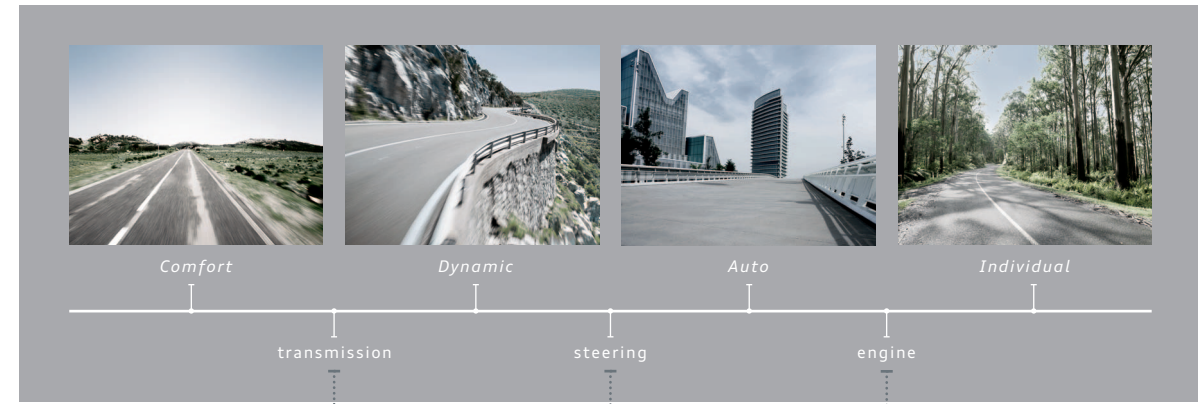



## We've resolved to lose the extra weight.

It's fairly simple to explain. Since we've exploited lightweight technology, excessive horsepower is a thing of the past. We're building lighter engines that not only allow for better performance, but also an increase in fuel economy. The four-cylinder 2.0-liter Audi TFSI® engine that produces 211 hp and an impressive 258 lb-ft of torque with its direct injection and efficient turbocharging technology is leading the way.<sup>1</sup> The combination of a lightweight engine and the wide spread of the gear ratios within each of the available transmissions makes for an exhilarating driving experience at every turn.

### .06 - 2.0 Turbocharged Four-cylinder

Years ahead of the competition, this 2.0-liter turbocharged DOHC engine combines the Audi valve-lift system, variable valve timing, TFSI direct injection and turbocharging for more power and greater efficiency.

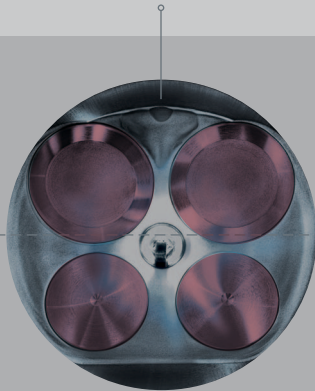

Four valves per cylinder

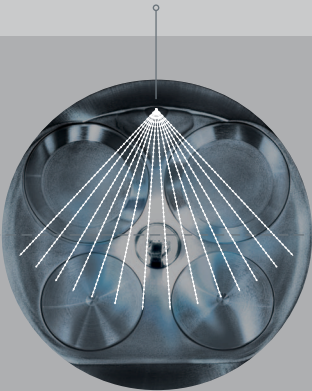

211 hp / 258 lb-ft of torque

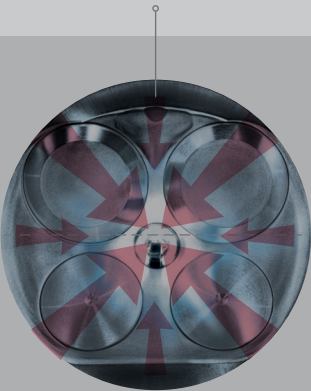

Compression ratio of 9.6:1



0 - 60 mph in 6.3 seconds

Compressing the air flow to the engine allows more air into the cylinder and, ultimately, more power from each ignition, significantly improving the engine's power-to-displacement ratio.

Audi TFSI direct injection helps cut down on waste and increase power by delivering a precise amount of fuel directly into the engine cylinder, helping to ensure a more complete combustion.

With higher compression ratios and cylinder pressure, the Audi TFSI engine fully atomizes fuel and helps optimize boost response.

The combination of these advanced technologies allows Audi to use a smaller, more efficient engine that still achieves excellent power and performance results.

## Stay tuned for a dynamic transmission.

Many drivers mistakenly blame their engines for poor acceleration, when it's actually the transmission that isn't rising to the occasion. The Audi A4 eliminates the problem with revolutionary transmissions. By utilizing optimized gear ratios, each one of the three available transmissions is capable of delivering engine power in the most responsive and efficient way possible. On models equipped with automatic transmissions, drivers are able to command upshifts or downshifts through the available steering wheel-mounted shift paddles. A shift has been made and the choice is yours: choose what propels your A4.

### .07 - Eight-speed Tiptronic® Automatic Transmission

As the perfect compromise between a dedicated manual and an automatic gearbox, the eight-speed Tiptronic® automatic transmission available in the Audi A4 offers eight optimized, carefully chosen gear ratios. Selected via its console-mounted shifter or steering wheel with available shift paddles, precise shifts are delivered without sacrificing the smooth action of the Tiptronic® automatic. A wide final drive ratio allows optimization of lower gears, yet its upper range emphasizes fuel economy—particularly at highway speeds.

### .08 - Six-speed Manual Transmission

For drivers who crave engaging and dynamic response, the Audi A4 presents an available six-speed manual gearbox that delivers power with vintage Audi finesse. Its short throw and precise ratios add a contemporary element for confident performance on the road.

### .09 - Audi Multitronic® Transmission

As a continuously variable transmission, the available Audi multitronic combines the efficiency of a manual gearbox with the convenience of an automatic transmission. And thanks to its variable ratios and adaptive map control, the Audi multitronic always utilizes the optimal rev range of its engine.

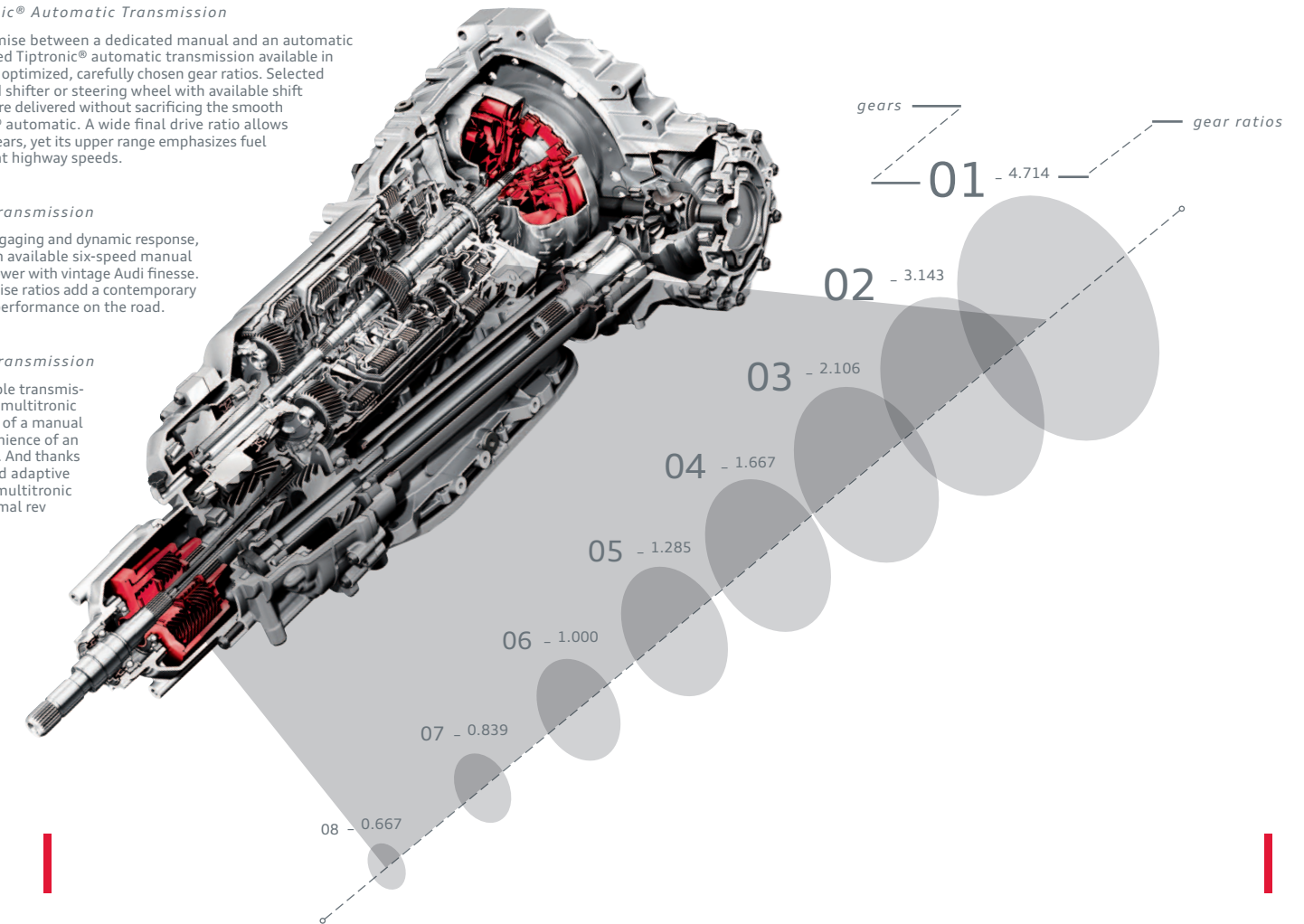

<sup>1</sup> EPA estimates not available at time of printing. Your mileage will vary.



## Anticipating needs you didn't know you had.

Available driver-assistance technologies take into account the actions of other drivers—while making your drive a little easier. From seemingly sentient Audi adaptive cruise control to Audi side assist, the Audi A4 has incorporated innovative, anticipatory technologies that don't see your future so much as help change it.

### .10 - Audi Side Assist

The available Audi side assist uses radar sensors and two different optical warnings to help keep the driver informed of what is approaching from hard-to-see angles behind and to the side of the vehicle.

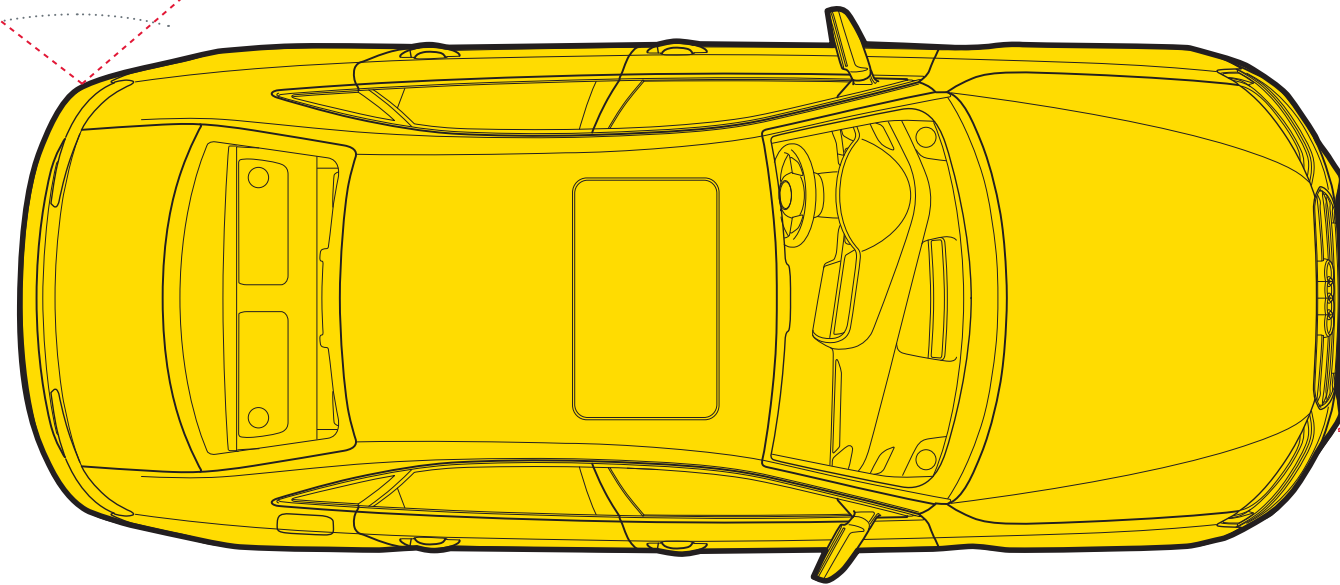
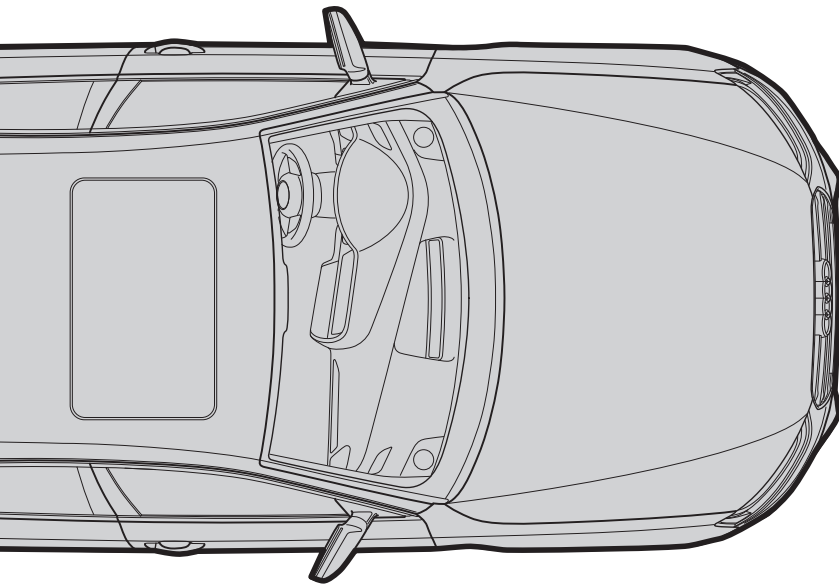

### .11 - Audi Adaptive Cruise Control

Everyone has their own comfort zone. The available Audi adaptive cruise control helps maintain a driver-selected distance from the vehicle in front using a special long-range radar sensor. The system constantly measures the space between your vehicle and the vehicle ahead and helps maintain it by automatically adjusting your speed. Once the road ahead is clear, the vehicle effortlessly resumes the previously preset speed, helping to make your drive that much more relaxing.

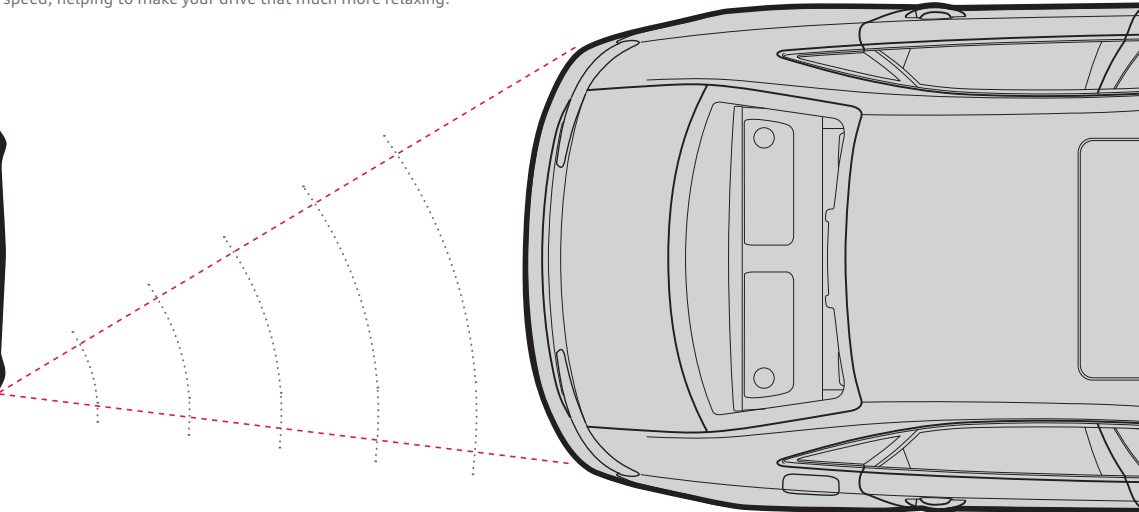



## Helping to see the unforeseen.

Whether it's diminishing the impact of human error or keeping passengers secure during turbulent situations, the Audi A4 consistently rises to the occasion in inconsistent environments. This is evident through its six standard airbags and the use of high-strength steel that helps to add a measure of security while enhancing overall handling performance.<sup>1</sup>



### .12 - Strength and Flexibility

When it comes to safety, it's important to be strong, but it's also important to be flexible. That's why Audi engineers use high-strength steel in the B-pillar and the floorboards while designing crumple zones in the front and rear of the vehicle that help dissipate the energy and force from a collision.

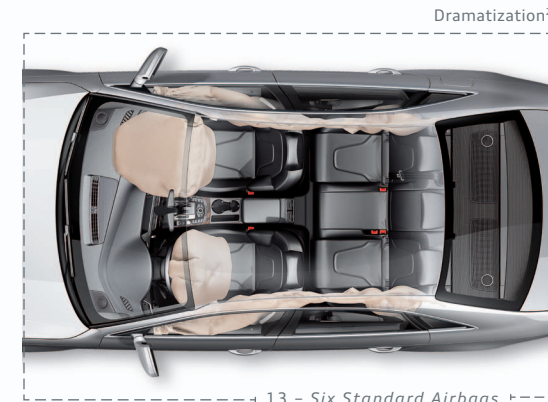

### .13 - Six Standard Airbags

With six standard airbags, including front-impact and thorax side airbags for both driver and front passenger, and available rear passenger thorax side airbags, you'll feel practically surrounded.<sup>1</sup> And that's a good thing.

### .14 - Brakes

Whether you're on the open road or off the beaten path, ESC with ABS helps to keep the vehicle traveling in its intended direction by applying the right brakes at the right time to help maintain better traction, minimize skids, and optimize control.

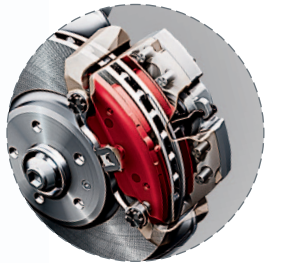

<sup>1</sup> Airbags are supplemental restraints only and will not deploy under all crash circumstances. Always use safety belts and seat children only in the rear, using restraint systems appropriate for their size and age. <sup>2</sup> This is a dramatization and does not depict what will happen in a collision. All bags will not inflate in real-world collisions, and, if multiple bags do deploy, they will be in various stages of inflating/deflating and will never all be inflated at the same time.



## The functional equivalent of installing a brain in your car.

Nothing in your Audi A4 was built in isolation. What we mean is that design, engineering and technology were conceived as a seamless whole, that they are all integrated and functional. You can see that philosophy fully represented in the available Audi MMI® system. Simply put, it's an intuitive system that intimately connects you to almost every facet of the vehicle. It's the nerve center of your vehicle, allowing you to control virtually every interior function of your A4 with a simplified source control button system. From the Audi MMI Navigation plus, to the radio, to media, the MMI helps you access information with a few easy clicks. You can even pair your compatible BLUETOOTH® enabled phone with the system for added convenience. We think of these things so you can think about how good your drive feels.

### .16 - Function Buttons

Helping you navigate through the MMI system with ease are four well-placed function buttons. Each button correlates to a command at the corner of the screen, and, when pressed, takes you to your desired selection.

### .15 - Audi MMI Navigation plus

Count on the available advanced navigation system to home in on your destination with stunning precision while putting a little more depth in your journey with help from Google Earth™.<sup>1</sup>

### .17 - SiriusXM Satellite Radio

Go ahead. Crisscross the country. We assure you, you'll never run out of entertainment options, with over 130 channels of music, talk and news.<sup>1</sup>

### .18 - BLUETOOTH® Technology

Unlock your mobile phone's potential through the MMI system. Simply pair them up and start enjoying near complete control at the touch of a button.<sup>2</sup>

### .19 - Audi Audio

The media button opens up a world of options, allowing you to control the available Audi music interface, Secure Digital (SD) card slots, hard disk drive (HDD) audio jukebox or DVD player.

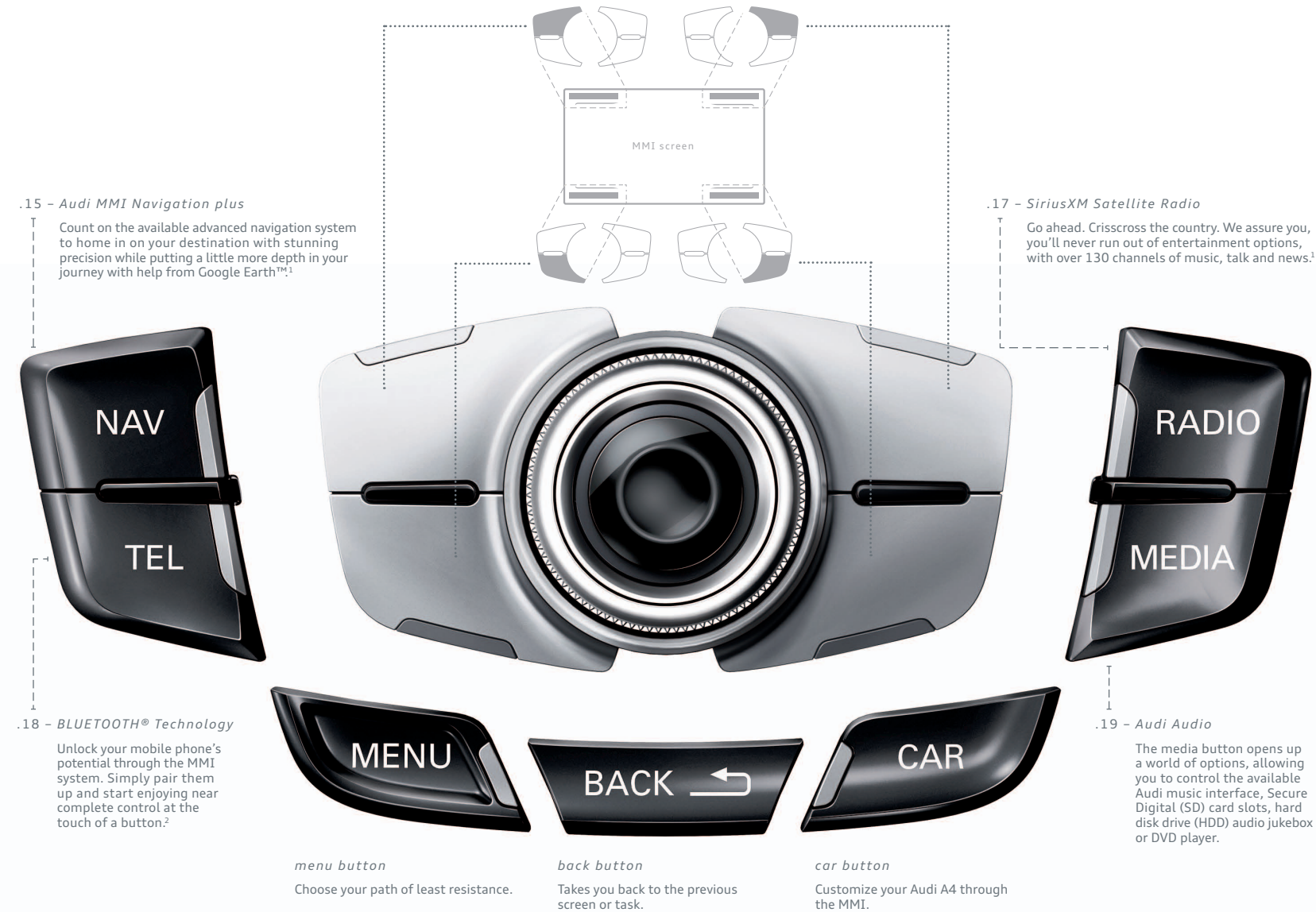



# No one connects you the way we do.



38° 57' 8.1" N

77° 23' 41.1" W



**Google Earth™ 3D satellite imagery**

With Google Earth™ integration, you'll enjoy 3D topography, including Google Maps Street View, displayed right on the Audi MMI® screen.<sup>2</sup>

**SiriusXM Traffic**

Working with your Google Earth™ overlay, you can get traffic conditions and plan alternate routes to help get around traffic backups.<sup>3</sup>

**Reported local fuel prices**

Find the lowest reported local price for fuel—and the directions to the station—right through the MMI system.

**Google™ Local Search**

Search for destinations via text or voice, using the cloud processing power of Google™ speech recognition and their point-of-interest database.

**myAudi features**

Plan your destination from your personal computer and send your route to your A4, for a preprogrammed trip plan.

**Weather information**

Current local conditions and forecasts for your destination can help you prepare for your trip.

**News feeds**

Stay on top of the news by having headlines and stories delivered right to your MMI display.

**Mobile Wi-Fi hotspot**

Provides high-speed connectivity for up to eight passenger devices through an onboard wireless hub.

We set out to change how people interact in and out of their automobiles. A suite of available technologies has made the Audi A4 a true champion of progress. And with Audi connect™ with Google Earth™ imagery and Wi-Fi connectivity for up to eight passenger devices, you have multiple ways to stay connected.<sup>1</sup> You can also access information and navigate entirely with your voice in just a few commands. With that kind of access, Audi helps build on your interactive life while helping enhance your ownership experience.

33° 46' 3.1" N

118° 11' 26.5" W

<sup>1</sup> Distracted driving can cause a loss of vehicle control. The features and technologies discussed above are offered for convenience, and should be used only when it is safe and appropriate. The Wi-Fi hotspot feature is intended for passenger use only. Always pay careful attention to the road, and do not drive while distracted. Features may require additional subscription plan. See dealer for details. <sup>2</sup> Introduction of feature has been delayed. <sup>3</sup> See Infotainment/Technology section of the Featured Content page for important information regarding required SiriusXM subscriptions.





# Orchestrating a new way of listening.

In some respects, you haven't heard anything yet. But with the available 14-speaker Bang and Olufsen® Sound System, you'll hear things in a way you've never heard anything before. It's at the heart of what Audi sound engineers had in mind for the A4. We actually remapped the listening process to help ensure that the sounds are hitting your ears at the precise time and acoustic levels that your music was intended to have. Which means the volume and timbre balance is automatically adjusted to changing ambient noise levels, to deliver the optimized clarity of the notes and sounds you want to hear. So that's why when we say "Truth in Engineering" you might just hear what we're talking about.



### .20 – Concert Hall Effect

The human ear can detect the direction that sound is coming from only when it is high-frequency, so the cabin speakers are evenly balanced with high- and mid-range speakers. Since the ear cannot detect the direction of low-frequency or bass notes, a single subwoofer complements the sound throughout the cabin, giving you the concert hall experience anywhere your drive might take you.

- |                           |                            |
|---------------------------|----------------------------|
| 1. Center mid-range       | 8. Rear 260-mm bass woofer |
| 2. Right mid-range        | 9. Left surround speaker   |
| 3. Right tweeter          | 10. Left 168-mm woofer     |
| 4. Right 200-mm woofer    | 11. Left tweeter           |
| 5. Right tweeter          | 12. Left 200-mm woofer     |
| 6. Right 168-mm woofer    | 13. Left tweeter           |
| 7. Right surround speaker | 14. Left mid-range         |

14  
speakers

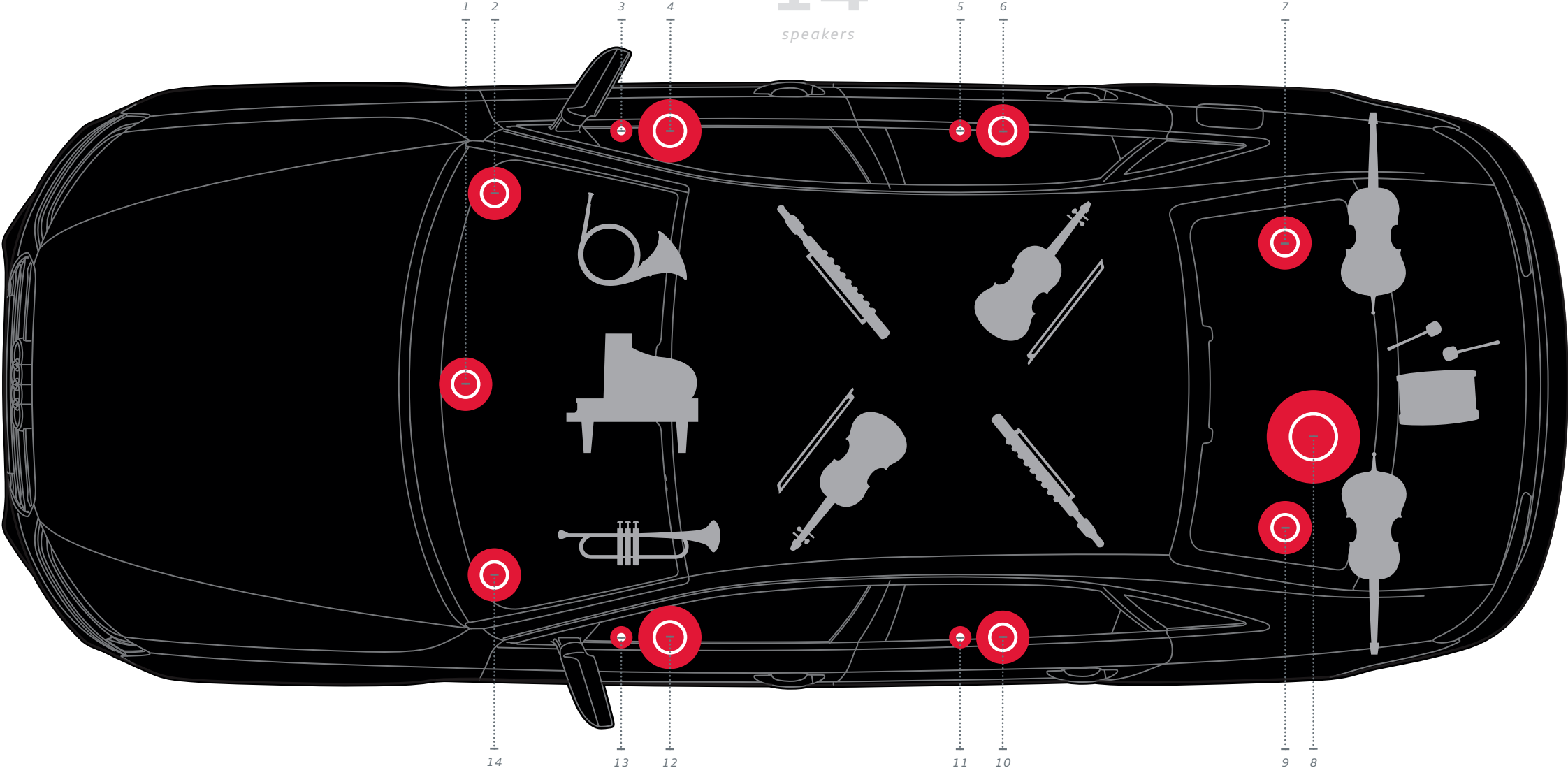





2013 Audi S4 Prestige shown in Misano Red pearl.



- ENGINE // 3.0-liter supercharged TFSI® V6 developing 333 hp and 325 lb-ft of torque

---

- DRIVETRAIN // Audi quattro® all-wheel drive, available sports differential, standard six-speed manual transmission or an available seven-speed Audi S tronic® dual-clutch transmission

---

- CHASSIS // S4 tuned sport suspension, available Audi drive select and dynamic steering

---

- BRAKES // 13.6" ventilated front disc brakes with S4 logo, 13.0" ventilated rear disc brakes

---

- PERFORMANCE // Top track speed of 155 mph;<sup>1</sup> acceleration from 0 to 60 in 4.9 seconds

<sup>1</sup> Top track speed is electronically limited in the U.S. Obey all speed and traffic laws.

.21 - LED Taillight Technology

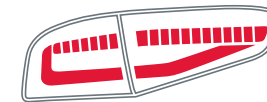

- fig. 03

Sleek and stylish, these rear light-emitting diodes are brighter and longer-lasting than conventional bulbs and illuminate faster than traditional brake lights, which can help give the driver behind you more time to respond.

## Fast lane-approved.

With classic sports sedan written all over the Audi S4, we're confident traffic is going to move out of your way. Performance is at the forefront with the S4, thanks to the combination of more power and dynamic suspension. The supercharged 3.0 TFSI engine results in 333 hp and pumps an alarming 325 lb-ft of torque. Since you have the option of a standard six-speed manual or a seven-speed Audi S tronic dual-clutch transmission, you can serve up the performance any way you like. From aggressively styled front and rear fascias, aluminum-optic mirrors and thundering quad exhaust tailpipes, the S4 lets you say goodbye with style.



There's more information on the Audi Sport model line in the all-new 2013 Audi Sport brochure. See your dealer or go to [audiusa.com](http://audiusa.com) for details.



## Exterior Colors

Brilliant Black



Brilliant Red



Ibis White

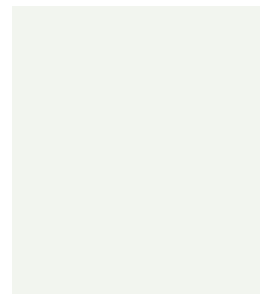

Ice Silver metallic

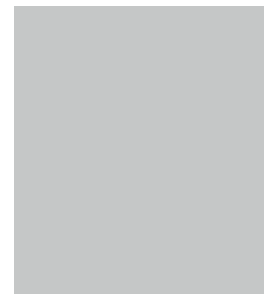

Monsoon Gray metallic



Glacier White metallic

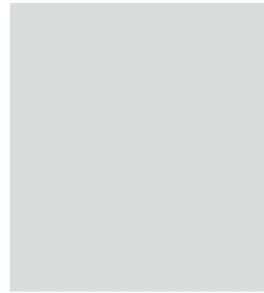

Moonlight Blue metallic



Scuba Blue metallic



Volcano Red metallic



Phantom Black pearl



## Interior Colors | Seat Selections



Standard Seat

Black leather



Chestnut Brown leather



Titanium Gray leather

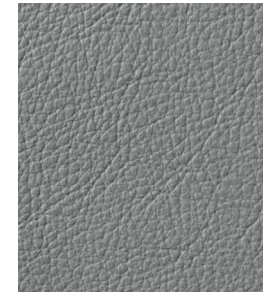

Velvet Beige leather



Sport Seat

Black leather



Chestnut Brown leather



Titanium Gray leather



Black leather/  
Perforated Alcantara®

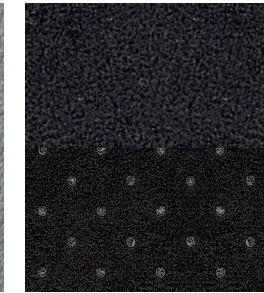

Audi S line® package





## Decorative Inlays

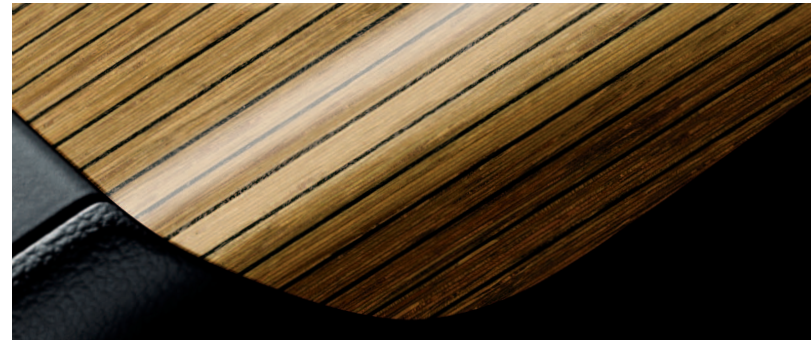
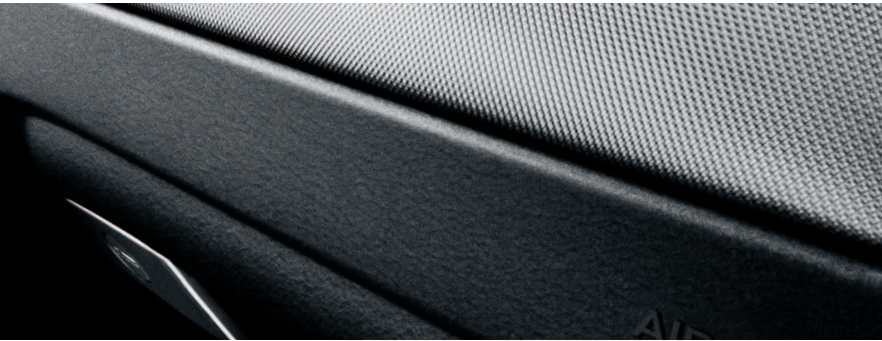

Aluminum Trigon inlay<sup>1</sup>

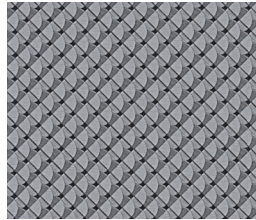

Dark Brown Walnut Wood inlay<sup>1</sup>



Fine Grain Ash Natural Brown Wood inlay<sup>1</sup>

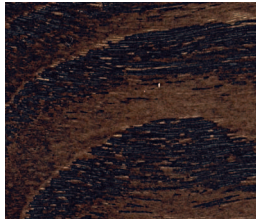

Layered Oak Wood inlay<sup>1</sup>



Brushed Aluminum inlay<sup>1</sup>



Audi S line® package

<sup>1</sup> Decorative inlay options will vary based on model and interior color combination. See your dealer for details.

## Wheels

17" 10-spoke star design  
245/45 all-season tires



A4 Premium

17" 5-arm dynamic design  
225/50 all-season tires



A4 Premium (optional)

18" 10-spoke dynamic design  
245/40 all-season tires



A4 Premium (optional), Premium plus and Prestige

19" 5-segment-spoke design  
255/35 summer performance tires<sup>2</sup>



Audi S line® package

<sup>2</sup> Tires are supplied and warranted by their manufacturer. High-performance tires are designed for optimum performance and handling in warm climates. They are not suitable for cold, snowy, or icy weather conditions. If you drive under those circumstances, you should equip your vehicle with all-season or winter tires, which offer better traction under those conditions. We suggest you use the recommended winter or all-season tire specified for your car or its equivalent. These high-performance tires also have a lower aspect ratio that aids performance and handling; however, in order to avoid tire, rim or vehicle damage, it is important that the inflation pressure is regularly checked and maintained at optimum levels. Please also remember in making your selection that, while these tires deliver responsive handling, they may ride less comfortably and make more noise than other choices. Finally, these tires may wear more quickly than other choices.



## Technical Specifications

Engineering   Performance	A4 2.0T
Engine type	Four-cylinder
Engine block/Cylinder head	Cast iron/Aluminum-alloy
Displacement (cc)/Bore and stroke (mm)	1,984/82.5 x 92.8
Horsepower (@ rpm)	211 @ 4,300
Torque (lb-ft @ rpm)	258 @ 1,500
Compression ratio	9.6:1
Valvetrain	16-valve DOHC with valvelift system
Induction/Fuel injection	Turbocharged/TFSI®
Acceleration with Audi multitronic®/manual/Tiptronic® transmission (0–60 mph)	6.7/ <b>NA</b> /6.3 seconds
Top track speed <sup>1</sup>	130 mph

Transmission   Drivetrain	
Audi multitronic® continuously variable transmission with front-wheel drive (Gear ratios: 1st: 2.436, 2nd: 1.626, 3rd: 1.231, 4th: 0.976, 5th: 0.783, 6th: 0.628, 7th: 0.499, 8th: 0.382, Reverse: 2.919, Final Drive: 4.612)	■
Six-speed manual transmission with Audi quattro® all-wheel drive (Gear ratios: 1st: 3.778, 2nd: 2.050, 3rd: 1.321, 4th: 0.970, 5th: 0.811, 6th: 0.692, Reverse: 3.333, Final Drive: 3.693)	Available
Eight-speed Tiptronic® automatic transmission with Audi quattro® all-wheel drive (Gear ratios: 1st: 4.714, 2nd: 3.143, 3rd: 2.106, 4th: 1.667, 5th: 1.285, 6th: 1.000, 7th: 0.839, 8th: 0.667, Reverse: 3.317, Final Drive: 2.848)	Available

Body   Suspension   Chassis	
Fully galvanized steel unibody with multistep anti-corrosion protection	■
Five-link front suspension	■
Trapezoidal-link rear suspension	■
Sport suspension calibration	<b>SP/SL</b>
Electromechanical power steering system	■
Dynamic steering	<b>DA</b>

■ Standard    **NA** Information not available at time of printing    **CP** Convenience package    **DA** Driver Assist package    **LP** Lighting package  
 — Not applicable    **NV** Audi MMI® Navigation package    **SL** Audi S line® package    **SP** Sport package

Exterior measurements	A4 2.0T
Wheelbase (in)	110.6
Length (in)	185.1
Height (in)	56.2
Overall width with mirrors (in)	80.3
Overall width without mirrors (in)	71.9
Track front/rear (in)	61.6/61.1
Curb weight with Audi multitronic® transmission (lb)	3,516
Curb weight with manual transmission (lb)	<b>NA</b>
Curb weight with Tiptronic® transmission (lb)	3,704
Drag coefficient (Cw)	.31

Interior measurements	
Head room with sunroof (in, front/rear)	40.0/37.5
Head room with sunshade (in, front/rear)	38.6/37.5
Leg room (in, front/rear)	41.3/35.2
Shoulder room (in, front/rear)	55.5/54.3
Cargo volume (cu ft, rear seat up/folded)	12.4/34
Seating capacity	5

EPA mileage estimates   Capacities	
Audi multitronic® transmission (city/highway/combined) <sup>2</sup>	<b>NA</b>
Manual transmission (city/highway/combined) <sup>2</sup>	<b>NA</b>
Tiptronic® automatic transmission (city/highway/combined) <sup>2</sup>	<b>NA</b>
Engine oil (qt)	4.9
Fuel (gal)	16.1
Recommended fuel	Premium

<sup>1</sup> Top track speed is electronically limited in the U.S. Obey all speed and traffic laws.    <sup>2</sup> EPA estimates not available at time of printing. Your mileage will vary.



## Featured Content

Safety   Security	Premium	Premium plus	Prestige
Driver and front passenger dual-stage airbags, thorax side airbags and Sideguard® head curtain airbags <sup>1</sup>	■	■	■
Rear-passenger thorax side airbags <sup>1</sup>	—	Optional	Optional
Front passenger occupant detection—for airbags <sup>1</sup>	■	■	■
Safety belt reminder for driver and front passenger	■	■	■
Lower Anchors and Tethers for CHildren (LATCH) in rear seats	■	■	■
Power central locking system with safety unlock feature if airbags deploy	■	■	■
Electronic Stability Control (ESC) with traction control (ASR)	■	■	■
Anti-lock Brake System (ABS) with Electronic Brake-pressure Distribution (EBD) and brake assist	■	■	■
Tire-pressure monitoring system	■	■	■
Electromechanical parking brake	■	■	■
Anti-theft alarm system with panic function	■	■	■

Exterior	Premium	Premium plus	Prestige
Audi Singleframe® grille	■	■	■
Halogen headlights with daytime running lights	■	—	—
Xenon plus headlights with LED daytime running light technology	LP	■	—
Adaptive xenon plus headlights with LED daytime running light technology	—	—	■
Headlight washing system	—	—	SL
Automatic headlights	■	■	■
Front and rear fog lights	■	■	■
LED taillight technology	LP	■	■
Power-adjustable heated exterior side mirrors	■	—	—
Power-adjustable, auto-dimming, heated exterior side mirrors with memory	—	■	■
LED turn indicator light technology integrated into the exterior side mirrors	■	■	■
Heated windshield washer nozzles	■	■	■
Matte black trim around exterior windows	■	—	—
Aluminum trim around exterior windows	LP	■	■
Dual exhaust outlet (driver's side)	■	■	■
Audi S line® exterior appearance	—	—	SL

■ Standard    NA Information not available at time of printing    CP Convenience package    DA Driver Assist package    LP Lighting package  
 — Not applicable    NV Audi MMI® Navigation package    SL Audi S line® package    SP Sport package

Interior	Premium	Premium plus	Prestige
Automatic climate control	■	—	—
Three-zone automatic climate control	—	■	■
Four-spoke multifunction steering wheel	■	■	■
Three-spoke multifunction sport steering wheel (with shift paddles on automatic)	—	SP	SP
Three-spoke multifunction, flat-bottom, sport steering wheel (with shift paddles on automatic)	—	—	SL
Tilt and telescopic manually adjustable steering column	■	■	■
Decorative interior inlays (see Decorative Inlays page for more detail)	■	■	■
Black cloth headliner	With Chestnut Brown leather	With Chestnut Brown leather	With Chestnut Brown leather or SL
Dual front sun visors with lighted vanity mirrors	■	■	■
Power windows with one-touch up/down operation and pinch protection	■	■	■
Manual rear-side window and power rear window sunshades	—	—	Optional
Sunroof	■	■	■

Seating	Premium	Premium plus	Prestige
Leather seating surfaces (see Interior Colors page for more detail)	■	■	■
Leather/Alcantara® seating surfaces (see Interior Colors page for more detail)	—	—	SL
Eight-way power front seats and four-way power lumbar adjustment for driver	■	■	■
Twelve-way power front sport seats, including four-way power lumbar adjustment	—	SP	SP/SL
Driver seat memory	—	■	■
Heated front seats	Optional	■	■
Split folding 60/40 rear seatback	—	■	■

Infotainment   Technology	Premium	Premium plus	Prestige
Audi MMI® Navigation plus with voice control system <sup>2</sup>	—	NV	■
Audi connect™ with six-month trial subscription <sup>3</sup>	—	NV	■
Color driver information system	—	NV	■
Audi concert radio with ten speakers and single CD player with MP3 playback capability	■	■	—

<sup>1</sup> Airbags are supplemental restraints only and will not deploy under all crash circumstances. Always use safety belts and seat children only in the rear, using restraint systems appropriate for their size and age. <sup>2</sup> Audi Navigation plus depends on signals from the worldwide Global Positioning Satellite network. The vehicle's electrical system and existing wireless and satellite technologies must be available and operating properly for the system to function. The system is designed to provide you with suggested routes in locating addresses, destinations and other points of interest. Changes in street names, construction zones, traffic flow, points of interest and other road system changes are beyond the control of Audi of America, Inc. Complete detailed mapping of lanes, roads, streets, toll roads, highways, etc., is not possible, therefore you may encounter discrepancies between the mapping and your actual location. Please rely on your individual judgment in determining whether or not to follow a suggested Audi Navigation plus route. Periodically mapping updates will be available for purchase at an additional cost. Consult your dealer or call 1-800-FOR-AUDI for details. <sup>3</sup> See Audi connect page for important information regarding Audi connect.



## Featured Content

Infotainment   Technology (continued)	Premium	Premium plus	Prestige
Bang & Olufsen® Sound System with 14 speakers and 505 watts	—	Optional	■
HD Radio™ Technology	—	<b>NV</b>	■
SiriusXM Satellite Radio with 90-day trial subscription <sup>1</sup>	■	■	■
SiriusXM Traffic with four-year subscription <sup>1</sup>	—	<b>NV</b>	■
Audi music interface with iPod® integration	<b>CP</b>	■	■
BLUETOOTH® wireless technology preparation for mobile phone	<b>CP</b>	■	■
Garage door opener (HomeLink®)	<b>CP</b>	■	■
Audi advanced key—keyless start, stop and entry	—	Optional	■
Cruise control with coast, resume and accelerate features	■	■	■
Audi adaptive cruise control	—	—	<b>DA</b>
Audi side assist	—	—	■
Audi drive select	—	—	<b>DA</b>
Parking system plus with rearview camera	—	<b>NV</b>	■
Rain/light sensor for automatic windshield wipers and headlights	■	■	■

■ Standard    NA Information not available at time of printing    CP Convenience package    DA Driver Assist package    LP Lighting package  
 — Not applicable    NV Audi MMI® Navigation package    SL Audi S line® package    SP Sport package

## We've given style more style.

Think of it like this—we've put the S in style. The Audi S line® package available on the Audi A4 Prestige is more than just taking an already impressive vehicle and transforming it visually to look like no other car on the road, but that's mostly because it's just more of everything. With 19" 5-segment-spoke design alloy wheels, S line front and rear fascias, and rocker panels that were designed to give the A4 S line a more vigorous look, we've added a bit of an edge to an already stylish statement. Inside, Brushed Aluminum decorative inlays pepper the center console, doors and instrument panel, and they just might match the gleam in your eye when you see them. A flat-bottomed three-spoke multifunction steering wheel and S line upgraded sport seats with leather/Alcantara® seating surfaces enhance the prestige of this premium aesthetic, and athletic, package.



2013 Audi A4 2.0T Prestige shown in Brilliant Red with available Audi S line package.

<sup>1</sup> SiriusXM Satellite Radio and Traffic subscriptions sold separately or as a package after trial expires. SiriusXM Traffic service available in select markets. Subscriptions are governed by SiriusXM Customer Agreement (see [www.siriusxm.com](http://www.siriusxm.com)) and are continuous until you call SiriusXM to cancel. SiriusXM U.S. Satellite Service available only to those 18 and older in the 48 contiguous U.S.A., D.C. and Puerto Rico (with coverage limitations).



## Accessories

Imagine a cherry on top of your sundae. Sweet, right? Now imagine a cherry that helps protect your A4 in the garage. Or carries your bikes for a serious weekend on the trails. Or makes heads turn as you drive by. Audi Genuine Accessories are the little extras that make your Audi even sweeter. Designed by the same visionaries

who designed your vehicle, all accessories feature a tailored fit and the expert craftsmanship you'd expect from Audi. They are also backed by the 4-year/50,000-mile Audi New Vehicle Limited Warranty or the accessory's 12-month/12,000-mile limited warranty, whichever extends longer from the accessory purchase date.<sup>1</sup>



### Canoe/Kayak Rack

Carries one canoe or kayak weighing up to 55 lb. Conforms to most hulls and includes one pair of heavy-duty straps.<sup>2,3</sup>

### 19" Cortada Wheels—Gloss Black

Experience the high-performance beauty of this eye-catching design. The hollow-spoke feature results in a lightweight wheel that allows for more precise handling. Five-spoke design features a high-gloss finish in black.

### Ski and Snowboard Rack

Push-button, keyed locks open and close easily. Rubber-cushioned aluminum bars hold securely. Standard attachment holds up to four skis or two snowboards. Deluxe attachment holds up to six skis or four snowboards.<sup>2,3</sup>

### 18" Candela Wheels—White Spokes/Polished Lip

An impressive, clean, drop-center, deep-dish design makes this 15-spoke wheel the perfect complement to the A4.

### Small Cargo Carrier

Extra carrying capacity (13 cu ft) comes in a smart size: 55" long, 35" wide, 14" high.<sup>2</sup>

### 18" Cascara Wheels

Add the finishing touch with this dramatic design. Also available as a wheel and tire package.

### S4 Alu-Optic Trim Package

Includes two red "Supercharged" fender badges, plus Alu-Optic stone guards that match the side mirrors and mount between the wheel wells.

### Exhaust Tips

Dual side tips are angle-cut with rolled edges, and constructed of high-luster stainless steel.

### Valve Stem Covers

These handsome covers are made of polished stainless steel with a composite center cap. Emblazoned with the iconic Audi rings.

### A4/S4 All-weather Floor Mats

Deep-ribbed, channeled design helps protect the floor and carpeting from water, mud, sand and snow. Rubber mats come in black and feature vehicle logo. Available in sets of two for front or rear.

Other accessories not shown

### Audi Genuine Sport and Design Accessories

Your Audi vehicle features a bold, aggressive stance and strong, stunning lines. Enhance it by adding Audi Genuine Sport and Design Accessories. All are carefully scrutinized in the design and development process. So while they're striking in appearance, they've also passed rigorous quality assessments, including corrosion testing. If you're looking for a bolder appearance or a finishing touch, there is a solution designed by Audi that makes every mile more enjoyable—and more yours.

### Audi Genuine Alloy Wheels

Strike the perfect balance between breathtaking design and awe-inspiring performance with Audi Genuine Alloy Wheels. Audi experts have meticulously designed these wheels especially for each Audi model. They're engineered to the highest standards and endure rigorous testing to help ensure long-term quality. Experience eye-catching style that is yours and yours alone. Nothing enhances the bold, dynamic look of your Audi vehicle faster.

### Audi TravelSpace Transport Accessories

You go almost everywhere. Give your Audi the proper invitation to be part of your adventures. Never leave the necessary gear behind. Bring it with Audi TravelSpace Transport Accessories. The list includes bike racks, ski racks, a variety of watersports equipment carriers and various sizes of cargo carriers. Wherever you go, make sure almost everything fits with a variety of intelligent and innovative solutions. Accessories designed for your life—the passionate, active part.

### Audi Genuine Electronics Accessories

The illuminating technology that graces each Audi vehicle provides the inspiration for Audi Genuine Electronics Accessories. Similarly, all of these accessories are impressively advanced and inspiring. Our audio options let you enhance your listening pleasure. Other accessory options help promote safer, more convenient travel. All are designed and tested to help ensure compatibility with the vehicle's electrical systems, allowing you to enjoy every aspect of Audi technology with almost all your senses. Demand the best and drive with added confidence.

### Audi Guard Comfort and Protection Accessories

Protect what you love. Audi Guard Comfort and Protection Accessories offer functional, practical items that help keep your Audi in pristine condition. Choose from such useful items as trunk liners that help make clean-up quick and easy, or an easy-to-use storage cover that helps shield the vehicle. Use them all to help reduce wear and tear and keep the vehicle looking like new—inside and out. All are engineered to stringent Audi standards, so you can be assured of their quality and durability.

<sup>1</sup> See dealer for details. <sup>2</sup> All roof-rack system attachments require the base carrier bars. All attachments sold separately. <sup>3</sup> Recreational equipment, sporting equipment and luggage not included.