

# A6



# A6

Audi A6

Note: A word about this brochure. Audi of America, Inc., believes the specifications in this brochure to be correct at the time of printing. However, specifications, standard equipment, options, fabrics, and colors are subject to change without notice. Some equipment may be unavailable when your vehicle is built. Please ask your dealer for advice concerning current availability of standard and optional equipment, and your dealer will verify that your vehicle will include the equipment you ordered. Vehicles in this brochure are shown with optional equipment. See your dealer for complete details on the New Vehicle Limited Warranty, twelve-year limited warranty against corrosion perforation, and Audi 24/7 Roadside Assistance. (Roadside assistance coverage provided by Road America in the U.S. Certain conditions apply; see your dealer for details.) Tires supplied by various manufacturers. "Audi," all model names, "Audi connect," "Cylinder on Demand," "FSI," "MMI," "multitronic," "quattro," "Sideguard," "Singleframe" and the Singleframe grille design, "S line," "S tronic," "TFSI," "Truth in Engineering," "ultra" and the four rings logo are trademarks or registered trademarks of AUDI AG. "Bang & Olufsen" and "ICEpower" are registered trademarks of Bang & Olufsen. The BLUETOOTH word mark and logos are owned by the Bluetooth SIG, Inc., and use of any such marks by AUDI AG is under license. "BOSE" and "AudioPilot" are registered trademarks of the Bose Corporation. "GOOGLE," "Google Earth" and "Google Maps Street View" are trademarks of Google Inc. "HD Radio" and the HD Radio logo are proprietary trademarks of iBiquity Digital Corporation. "HomeLink" is a registered trademark of Johnson Controls Technology Company. "iPod" is a registered trademark of Apple, Inc. "SiriusXM" and all related marks and logos are trademarks of SiriusXM Radio Inc. and its subsidiaries. "Tiptronic" is a registered trademark of Dr. Ing h.c. F. Porsche AG. All other trademarks are the property of their respective owners. Some European models shown.

2013 | A6

Audi of America  
Audiusa.com  
Facebook.com/Audi



## Class is now in session.

Wisdom isn't given, it's earned. Good thing the 2013 Audi A6 is a generous teacher. The lesson plan starts with access to the digital world through an available embedded Wi-Fi hotspot.<sup>1</sup> From there it moves on to connecting faster using the handwriting-recognition technology of available Audi MMI® touch. Then the course is rounded off with the seemingly relentless grip of available Audi quattro® all-wheel drive, and an available supercharged 3.0-liter TFSI® V6 engine, which gives you the muscle of a V8 with the thirst of a V6. Now you have the uncompromising performance of a technologically advanced luxury sport sedan. In every stitch, it exudes class. On every road, it teaches.

<sup>1</sup> Distracted driving can cause a loss of vehicle control. The features and technologies discussed above are offered for convenience, and should be used only when it is safe and appropriate. The Wi-Fi hotspot feature is intended for passenger use only. Always pay careful attention to the road, and do not drive while distracted. See dealer for details. <sup>2</sup> Based on brightness comparison to the sun and 5,500 K color temperature. Full LED headlights are an optional upgrade.



### .01 - Full LED Headlight Technology

The Audi A6 offers full LED headlights. With an approximate lifespan of 10,000 hours, these lights are the closest re-creation of daylight yet.<sup>2</sup> Bright and stylish, they offer signature brilliance from Audi.



Standard text and data usage rates apply.



Building a more dramatic story, line by line.



Some writers try to conceive one brilliant character and let the plot organically build and flow from there. We took a page from their book, so to speak, when designing the Audi A6. To create and define that brilliant character, we started with one great line. The Tornado line. Bisecting the body profile, it runs strongly through the middle of the vehicle to give it a bold, progressive stance that tells the world that there's pedigree here, but not a predictable one. After that, the narrative becomes yours.

.02 - Design Lines

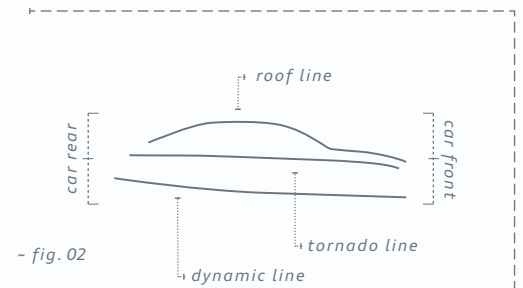

See how the A6 model's Dynamic line defines the lighting surfaces while also bringing the vehicle closer to the road. Its Roof line creates a sporty coupe-like silhouette, while the Tornado line extends along the entire body to provide its visual muscle.





.03 - Audi connect™

In addition to Wi-Fi connectivity and Google Earth™ imagery, available Audi connect provides weather information, fuel prices, news, and Google™ Local Search, which identifies points of interest such as landmarks or other attractions!

## Progress starts with a point of view.

The trick is to be bold while acting cool. That's our approach with the Audi A6. Crafted with precision, appointed luxuriously and built with performance in mind, it is engineered lighter than the previous-generation A6 for improved efficiency;<sup>2</sup> and connected like no car before. We built the A6 not for those concerned with looking up or down, but for those who look out to see all the possibilities.

1. Distracted driving can cause a loss of vehicle control. The features and technologies discussed above are offered for convenience, and should be used only when it is safe and appropriate. The Wi-Fi hotspot feature is intended for passenger use only. Always pay careful attention to the road, and do not drive while distracted. Features may require an additional subscription plan. See dealer for details. <sup>2</sup> 25 city/33 highway mpg (2013 A6 2.0T, with Audi multitronic® continuously variable transmission with front-wheel drive). EPA estimates. Your mileage will vary.

2013 Audi A6 3.0T Prestige shown in Dakota Gray metallic with available 20" Sport package.





## This is luxury in its most athletic form.

The Audi S6 isn't afraid to flash a little muscle. But you could have guessed that with just a glimpse of its commanding profile. Or by the roar of its 4.0-liter TFSI® V8 that produces an unrelenting 420 hp, while helping save fuel using Audi Cylinder on Demand™ engine efficiency technology. But what's power without control? That's where the legendary Audi quattro® all-wheel drive system comes into play, not to mention the sports differential and Audi adaptive air suspension. And, as a final show of its ability to mesh luxury and power, it offers signature sport seats with integrated head restraints.



# S6

ENGINE // 4.0-liter turbocharged TFSI® V8 developing 420 hp and 406 lb-ft of torque

DRIVETRAIN // Audi quattro® all-wheel drive with sports differential  
Seven-speed Audi S tronic® dual-clutch transmission

CHASSIS // S6 tuned Audi adaptive air suspension, Audi drive select

BRAKES // 15.7" ventilated front disc brakes with S6 logo, 14" ventilated rear disc brakes

PERFORMANCE // Top track speed of 155 mph<sup>1</sup>; acceleration from 0 to 60 mph in 4.5 seconds

 Audi Sport

There's more information on the Audi Sport model line in the all-new 2013 Audi Sport brochure. See your dealer or go to [audiusa.com](http://audiusa.com) for details.

<sup>1</sup> Top track speed is electronically limited in the U.S. Obey all speed and traffic laws.

2013 Audi S6 shown in Ice Silver metallic with optional 20" 5-parallel-spoke-star design wheels.





## Our interior has no mirror image.

Passion doesn't benefit from balance. Maybe that's why nothing, from the gleaming aluminum-trim surrounds to the burnished decorative wood or brushed aluminum inlays, is symmetrical. We considered every component of the interior and found that the people interacting with it would have different needs. So the dashboard isn't in balance—it's in a proper perspective for the driver and the passengers, respectively. A uniquely Audi perspective. By incorporating luxury materials and top-flight craftsmanship, we stand apart. Designed with inspired abandon, the Audi A6 interior provides a welcome contrast to the same old symmetry.



### .04 - Decorative Inlays

Incorporating painstaking craftsmanship, the Audi approach to our wood and metal inlays is the same as it is to our engineering. Imperfection is not an option. So natural wood shines, and brushed aluminum glistens. We capture the right accent of your interior choice, and add a singular finish to its fit.







## We're not the type to keep you at arm's length.

It's time to put yourself in the driver's seat. Feel how the wraparound curve of the Audi A6 dashboard invites your exploration. See how it integrates intuitively with the overall driver-centric layout. Discover how the design centers around the available Audi MMI® Navigation plus with its 8" display deploying from and retracting into the instrument panel. Then admire the finely crafted decorative inlays displayed before you. Now spark the ignition. It's your time to drive.

2013 Audi A6 3.0T Prestige shown in Velvet Beige leather with Dark Brown Walnut Wood inlays.



## Rewriting the elements of style.

Why challenge conventions when you can make new ones? Our innovative design team changed the way you interact with interior appointments, and built style with purpose in mind. With luxurious materials, available twelve-way power front seats and four-zone automatic climate control in the Audi A6, you literally create a unique cabin environment to fit your own unique style. This is true for the smallest details too, like an available heated steering wheel, or heated and ventilated front seats that help keep you comfortable so you can focus on driving.

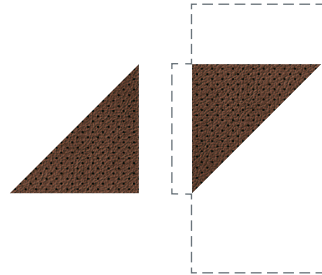

.05 - Leather

Designed specifically for Audi, leather envelops the vehicle's seating surfaces, to add the right touch to your luxury interior.



.06 - Ventilated Seats

Available front-seat ventilation offers multiple speeds of cooling while available heated rear seats help keep rear passengers warm.



2013 Audi A6 3.0T Prestige shown in Nougat Brown leather with optional Fine Grain Ash Natural Brown Wood inlays.



# quattro

*Confidence-inspiring*  
Under ideal conditions, power is 40:60 rear-wheel-biased to help maximize acceleration and cornering, but the instant conditions become more challenging, the ratio is optimized for superior grip and control.

## It's a bond between your car and the road.

It's true that while the available Audi quattro® all-wheel drive may have been engineered to help drive through inclement weather and in low-traction situations, the real magic of this advanced system is how it performs in the dry. Power is distributed to all four wheels working in concert to help grip every corner while giving you the optimal amount of power delivery where and when it's needed. In other words, quattro® helps enhance performance by appropriately transferring power to the necessary wheels when accelerating and turning, so you have confidence-inspiring performance when the road isn't at its best. Inclement weather aside, the really gripping story about quattro® is how it performs overall, forging a sure bond between you, your Audi A6 and the road.<sup>1</sup>

*Torque split*  
When accelerating out of a turn, up to 80% of the power is mechanically shifted to the rear wheels, where it's best allocated to propel the vehicle to your desired speed and onto the straightaway. Once traveling in a straight line again, the 40:60 power distribution that quattro® delivers to the front and rear wheels, respectively, gives you maximum torque to push onward.

*Torque vectoring*  
It's a handling feature that seems to respond to your impulses before your steering input. An evolution of cross-axle lock, this system works within quattro®, while utilizing ESC and ABS to help sense traction loss from the inside cornering tire.

<sup>1</sup> When driving during cold, rainy, snowy or icy weather conditions, ensure that your vehicle is equipped with appropriate all-season or winter-weather tires. Even with appropriate tires, you must always drive in a manner appropriate for the weather, visibility and road conditions.



# It's time to throw the road a curve.

Audi quattro® all-wheel drive<sup>1</sup> is more than visionary engineering—it's actually a response to the conditions around our Ingolstadt headquarters. With the weather and the terrain the way they are, all-wheel drive seemed like a smart solution for the problems presented. Since they design mountain roads with hairpin turns, it's only natural that we wanted to turn the tables on the road. Here's how it works:

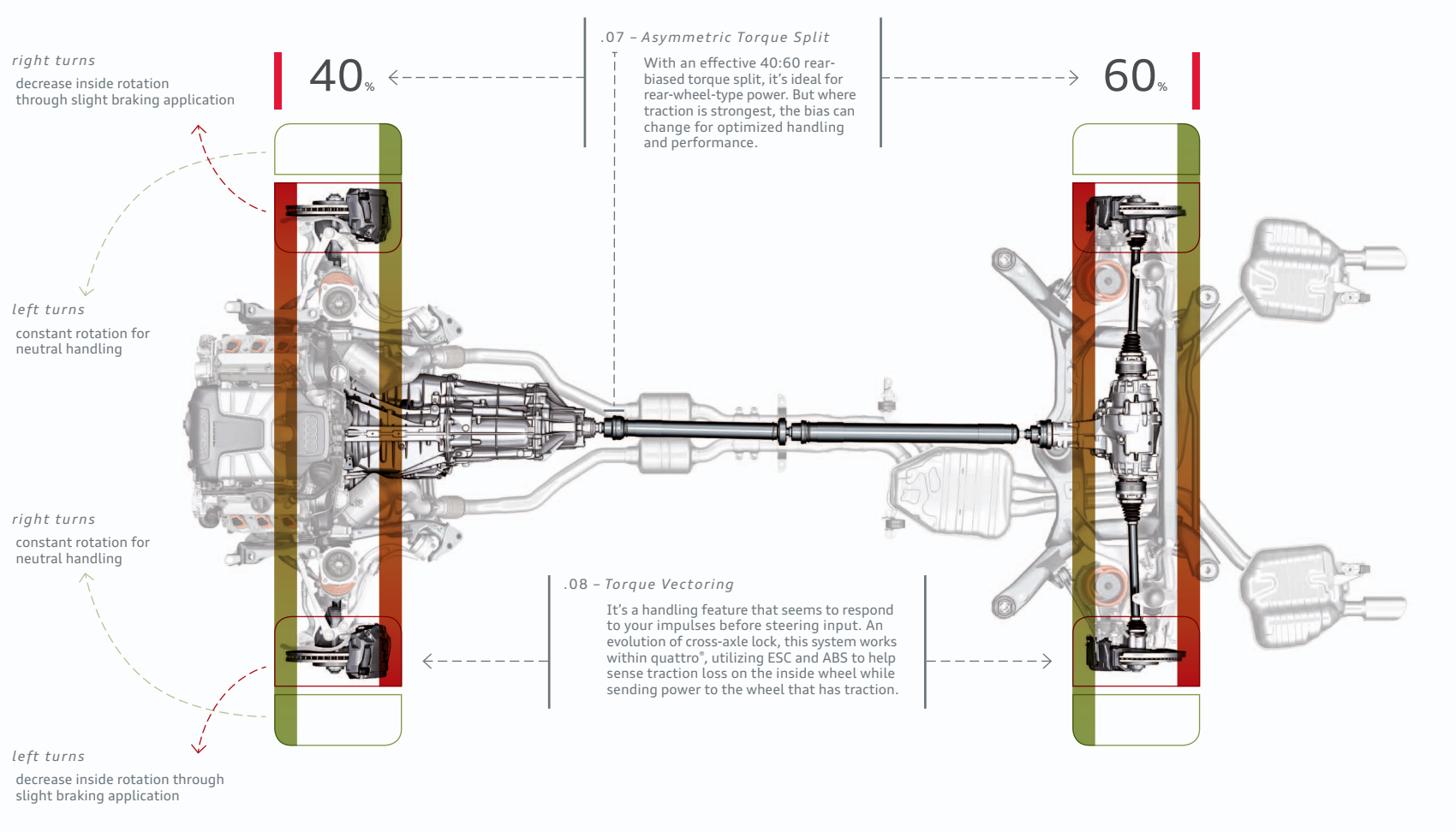

# It might feel like we read your mind.

While the engineering on the Audi A6 helps to elevate the driving profile and performance characteristics, it's not a totally refined sensibility we're after. We are a performance company as much as an engineering or luxury one. The result is intensity that uses technology to its benefit, without taking away from the visceral thrill of driving.



- peaceful
- balanced
- fun
- individualized

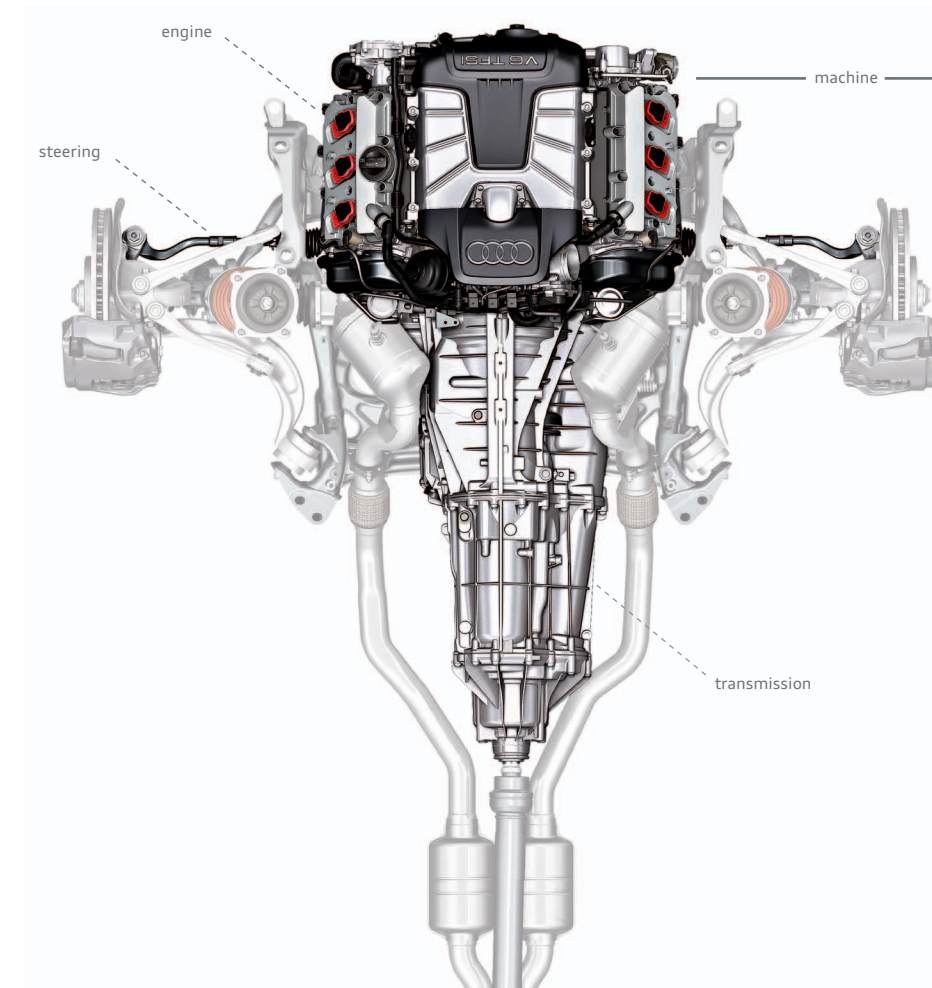

## .09 - Audi Drive Select

Our drive is responsive, but we also demand that you respond to the drive. With Audi drive select, you choose Comfort, Dynamic, Auto or Individual settings that configure the engine, transmission and steering to respond to your mood or the conditions, or just to experiment with drive settings that range from outstandingly comfortable to intensely sporty.

- **Comfort mode**  
Perfect for less-than-perfect roads, this setting adds optimized steering and a closer shift pattern to help provide a more relaxed drive.
- **Dynamic mode**  
More precise steering and a more responsive throttle give this setting an aggressive feel and focused performance.
- **Auto mode**  
The best of both worlds, dialed to automatically adjust settings for a seamless combination of comfort and responsiveness based on your driving style and road conditions.
- **Individual mode**  
Take the turn your way—this mode allows you to adjust the steering, throttle and transmission upshifts to your style.

<sup>1</sup> Audi quattro® all-wheel drive is standard on 3.0T, and available on 2.0T models.



# Realize your kinetic potential faster.

We're not losing weight for looks, but because it makes us stronger and more agile. By lightening our static weight throughout our frame and our engine, we are able to harness more power more quickly—and, not incidentally, more efficiently. That means the Audi A6, when equipped with the available supercharged 3.0-liter engine, delivers the potent acceleration of a traditional V8 with the efficiency of a V6. Improved mpg<sup>1</sup> and an increased heart rate. Great reasons for slimming down.

0 - 60 mph 5.3 seconds

10.3:1 - compression ratio

.10 - 3.0 TFSI® V6

Audi TFSI adds forced induction to Audi FSI® technology whereby fuel is directly injected into the combustion chambers at precisely managed times, providing more efficient combustion for better performance.<sup>1</sup> Then, by adding forced induction, a broad torque curve is established across the entire RPM range for maximum output.

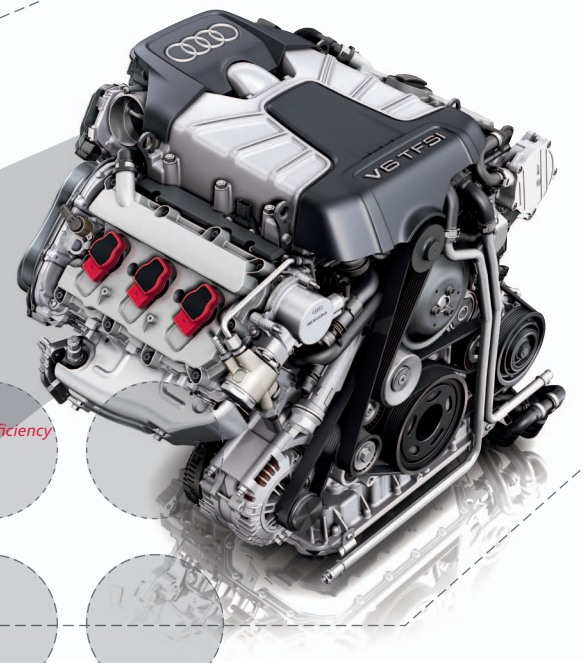

V6 - efficiency

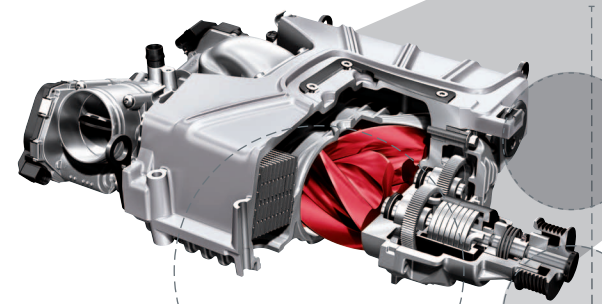

V8 - power  
310 hp / 325 lb-ft torque

211 hp / 258 lb-ft torque

.11 - 2.0 TFSI Four-cylinder

As with all A6 models, efficiency is standard.<sup>1</sup> The 2.0-liter TFSI four-cylinder engine utilizes either an optimized front-wheel-drive layout and Audi multitronic® continuously variable transmission, or available quattro® all-wheel drive system and eight-speed Tiptronic® transmission.

.12 - Start-Stop Engine Efficiency System

As an intelligent vehicle system, this available highly effective engine management program can lower fuel consumption as well as CO<sub>2</sub> emissions by automatically shutting off your engine while you wait at a red light or perhaps during certain stop and go driving. Once you are ready to resume, or if other critical vehicle systems require it, the engine will restart nearly instantaneously.



# With this kind of response, you might not care how efficient you've become.

This is where German engineering finds a new gear. Not content with a heritage of performance, we've developed an even more responsive and efficient way of applying power. Our available revolutionary eight-speed Tiptronic® automatic transmission with Dynamic Shift Program (DSP) helps to enhance performance while also allowing you to command upshifts or downshifts through the available steering wheel-mounted shift paddles. A shift has been made and the choice is yours: choose what propels your A6.

.13 - Eight-speed Tiptronic® Automatic Transmission

As the perfect companion for almost any road trip, the eight-speed Tiptronic® automatic transmission available in the Audi A6 offers eight optimized, carefully chosen gear ratios. Selected via its console-mounted shifter or steering wheel with available shift paddles, precise shifts are delivered without sacrificing the smooth action of the Tiptronic® automatic. A wide final drive ratio allows optimization of lower gears, yet its upper range emphasizes fuel economy—particularly at highway speeds.

.14 - Audi Multitronic® Transmission

As a continuously variable transmission, the available Audi multitronic combines the efficiency of a manual gearbox with the convenience of an automatic transmission! And thanks to its variable ratios and adaptive map control, the Audi multitronic always utilizes the optimal rev range of its engine.

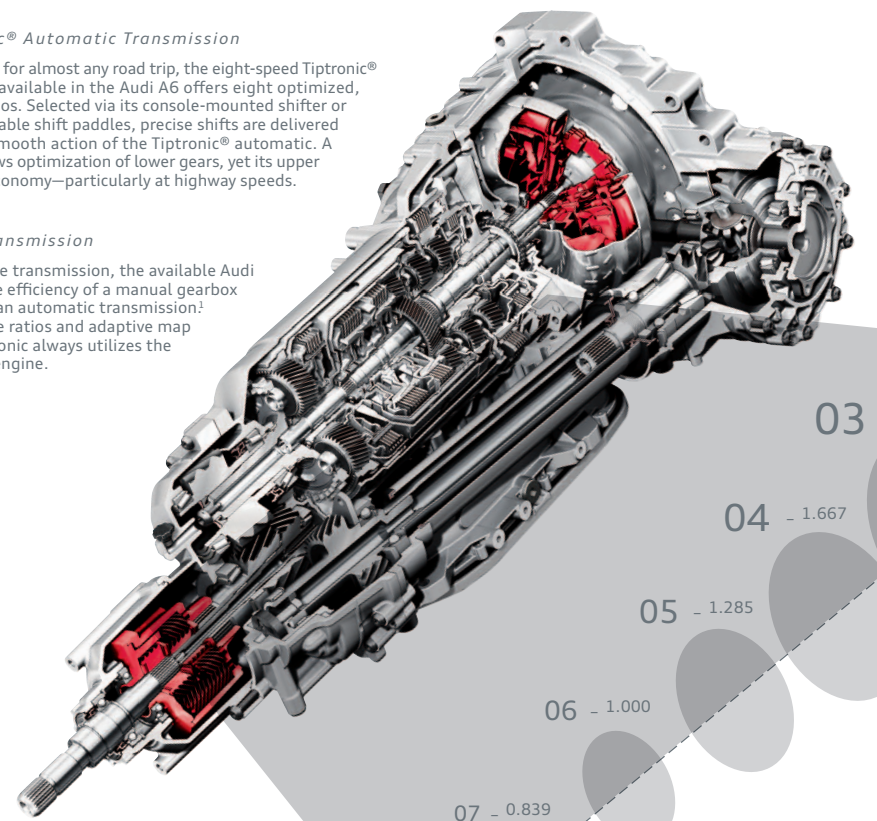

gears  
01 - 4.714 gear ratios

02 - 3.143

03 - 2.106

04 - 1.667

05 - 1.285

06 - 1.000

07 - 0.839

08 - 0.667

<sup>1</sup> 25 city/33 highway mpg (2013 A6 2.0T, with Audi multitronic® continuously variable transmission with front-wheel drive). EPA estimates. 2013 A6 3.0T EPA estimates not available at time of printing. Your mileage will vary.



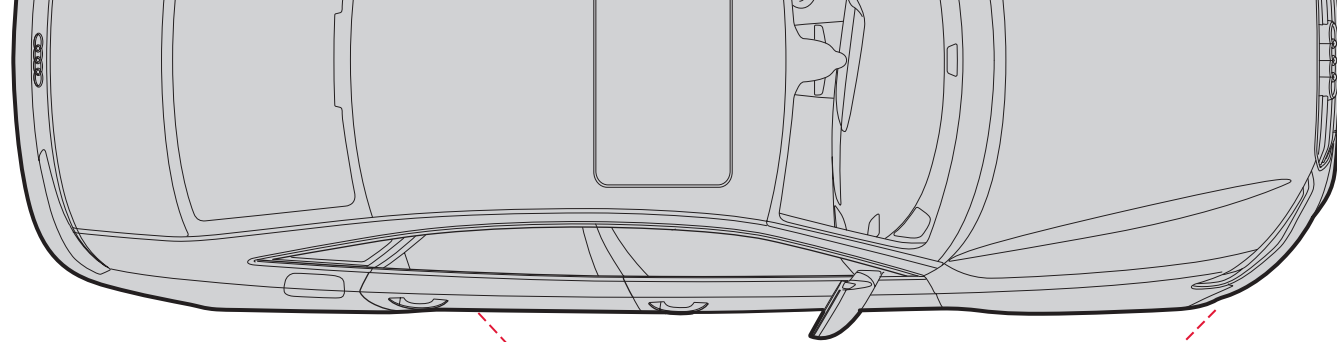

.16 - Head-up Display



Easy-to-view, accurate visual information right at eye level, this available feature displays important driving information and even pedestrian-detection warnings.

.17 - Night Vision Assistant



With an infrared camera detecting what lies ahead, this available feature uses thermal-imaging technology to help you avoid trouble. Pedestrians can be detected over 300 feet in front of the vehicle, while objects can be detected over 900 feet ahead—all shown on the 7" color driver information system.

.18 - Top and Corner View Cameras

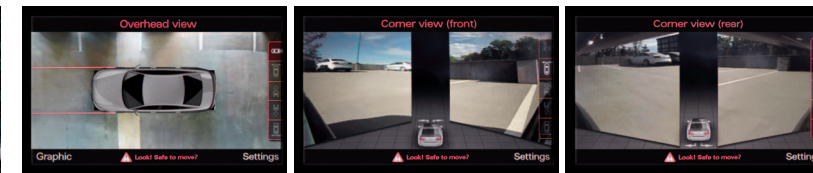

Four cameras on this available technology allow for an overhead view of your surroundings, making parking just a little easier. The technology shows you where your vehicle is in relation to obstacles nearby, giving you the confidence to maneuver in practically any environment!

.15 - Audi Side Assist

The available Audi side assist uses radar sensors and two different optical warnings to help keep the driver informed of what is approaching from hard-to-see angles behind and to the side of the vehicle.

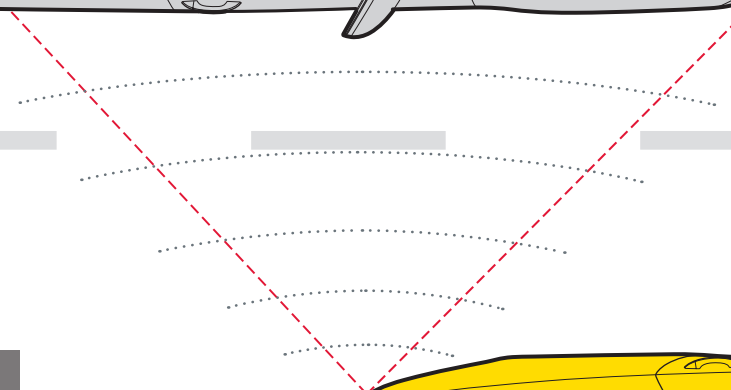

.19 - Audi Active Lane Assist

Operating at speeds above 38 mph, this available system helps detect when the vehicle begins to leave the lane without signaling. Then, through gentle, corrective steering efforts, it helps the vehicle remain in the lane and vibrates the steering wheel as an additional warning. This way, Audi active lane assist complements the driver's decision-making process to further solidify the bond between driver and machine.

.20 - Audi Adaptive Cruise Control with Stop & Go

Not only retains a preset distance from vehicles ahead, but resumes acceleration when you're ready. Using long-range radar and a camera, the available Audi adaptive cruise control with stop & go helps read the traffic conditions and adjusts the speed, helping to bring the vehicle to a full stop before accelerating when traffic flow resumes.

.21 - Audi Pre Sense Plus

The available Audi pre sense plus offers comprehensive driving assistance with sensors in the front, side, and rear. After visual, physical and aural collision warnings, there are four distinct phases for automatic preparation for the unavoidable: an upsurge of brake pressure, safety belt pre-tensioning, partial braking, and sunroof and window preparation. In severe cases, Audi pre sense plus will engage full braking and deceleration.

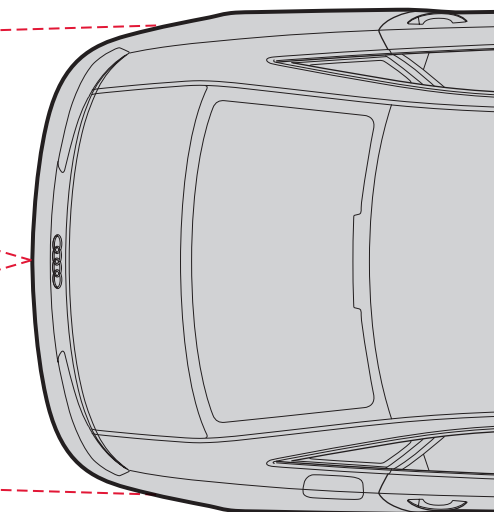
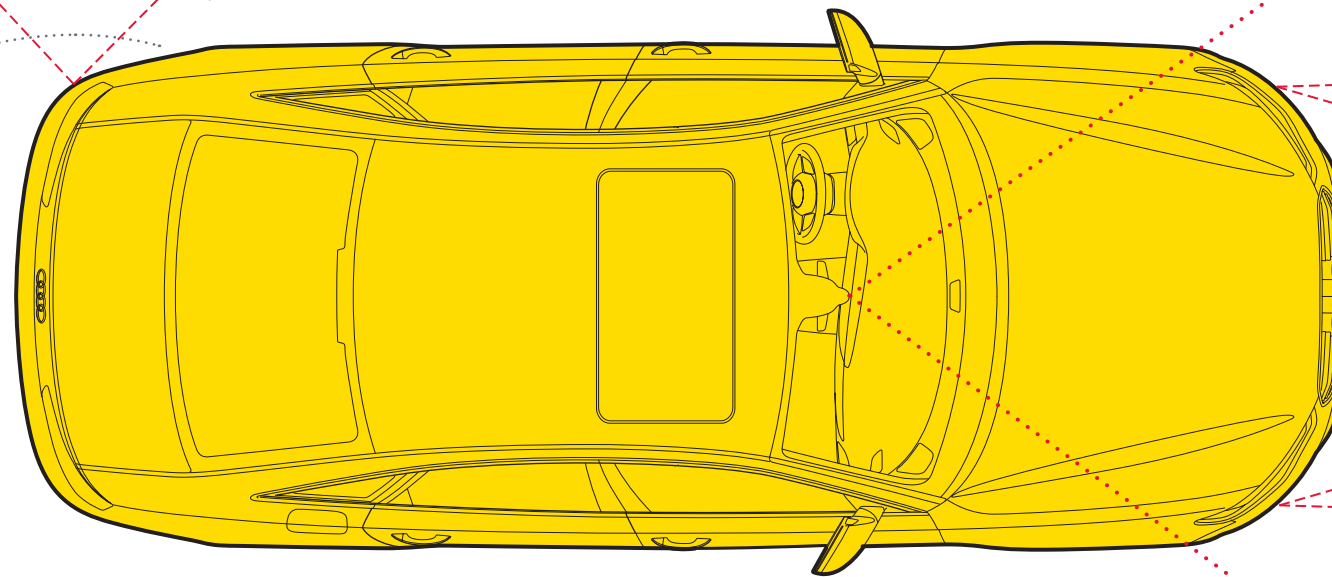

## Focused on the other drivers' distractions.

The suite of available driver-assistance technologies takes into account the actions of other drivers—while helping make your drive a little easier. From seemingly sentient Audi adaptive cruise control with stop & go to Audi active lane assist, the Audi A6 has incorporated innovative, anticipatory technologies that don't see your future so much as help change it.



## Being prepared means dressing the part.

You wouldn't wear shorts and sandals to opening night at the opera, right? That's why the innovative safety features of the Audi A6 come dressed for the occasion, so you can concentrate on better things, like the great performance of your A6. With up to ten airbags<sup>1</sup> helping to protect nearly every inch of the cabin, an adaptive restraint system protecting its occupants, and Audi ultra<sup>®</sup> lightweight technology such as aluminum hybrid construction that reduces the static weight of your vehicle to help shorten stopping distances, Audi thinks of safety in a comprehensive way. Surrounding you with it. So your A6 will not only look the part, it'll act the part.



.22 - ESC and ABS

Computerized technology that works in perfect sync with the Anti-lock Brake System (ABS), Electronic Stability Control (ESC) helps minimize any loss of stability, applying brake pressure to individual wheels and reducing throttle input to help counter oversteer or understeer when the vehicle needs it.

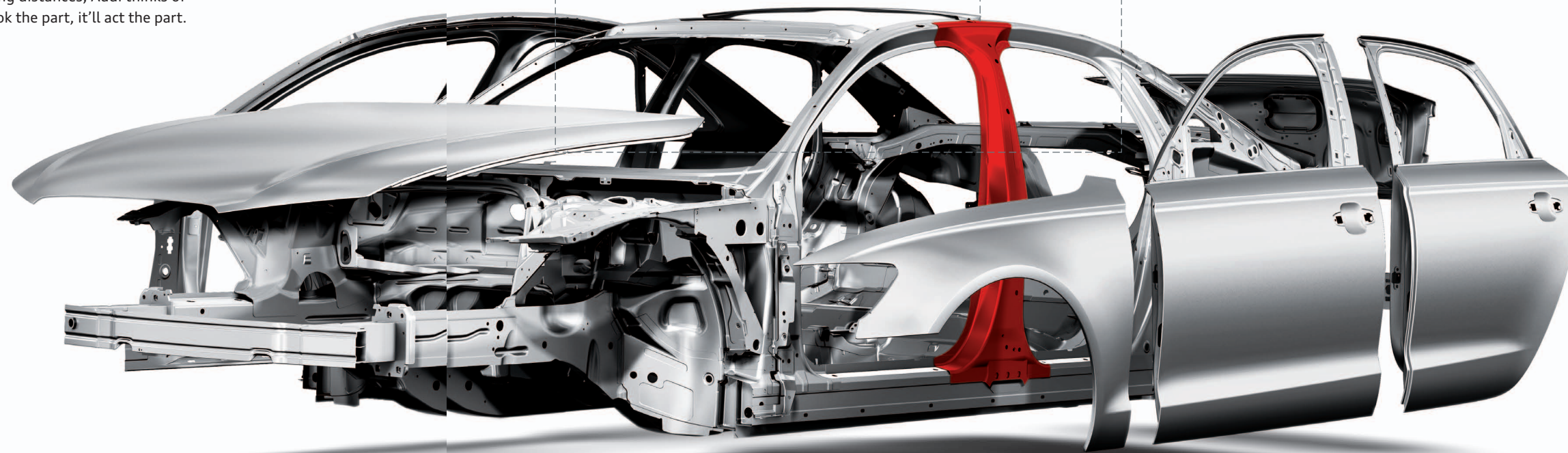

- 06 driver's head airbag
- 07 driver's knee airbag
- 08 driver's seat-mounted thorax side airbag
- 09 driver-side Sideguard<sup>®</sup> head curtain airbag for both rows of seats
- 10 driver-side rear seat-mounted thorax side airbag<sup>2</sup>

- 06 front-passenger head airbag
- 07 front-passenger knee airbag
- 08 front-passenger seat-mounted thorax side airbag
- 09 passenger-side Sideguard<sup>®</sup> head curtain airbag for both rows of seats
- 10 passenger-side rear seat-mounted thorax side airbag<sup>2</sup>

.23 - Ten Airbags

Strategically placed around the occupants, the option of up to ten airbags in the Audi A6 offers passive safety in the event of a collision, helping to protect the driver and passengers on all sides.<sup>1</sup>

.24 - Tailor-made Blanks

Developed to make the best possible use of the body's potential, tailor-made blanks use a special manufacturing process that can help strengthen the upper zone of the B-pillars, while the lower zone is designed to help mitigate the impact in the event of a side collision.

<sup>1</sup> Airbags are supplemental restraints only and will not deploy under all crash circumstances. Always use safety belts and seat children in the rear, using restraint systems appropriate for their size and age. <sup>2</sup> Optional feature.



# Input as unique as your fingerprint.

What does your handwriting say about you? We aren't really sure. We just know it speaks to us. A revolution in intelligent simplicity, the available Audi MMI® touch with handwriting recognition is a technology that gives you the ability to give commands and retrieve media simply by recognizing a few strokes of your finger. Access information such as music files, contact information, and destinations through the Audi MMI touch—or give input to the optional Audi connect™, an innovative media system with Google Earth™ mapping service. The world isn't simply at your fingertips—your fingertips open up a new way to interact with the world.<sup>1</sup>

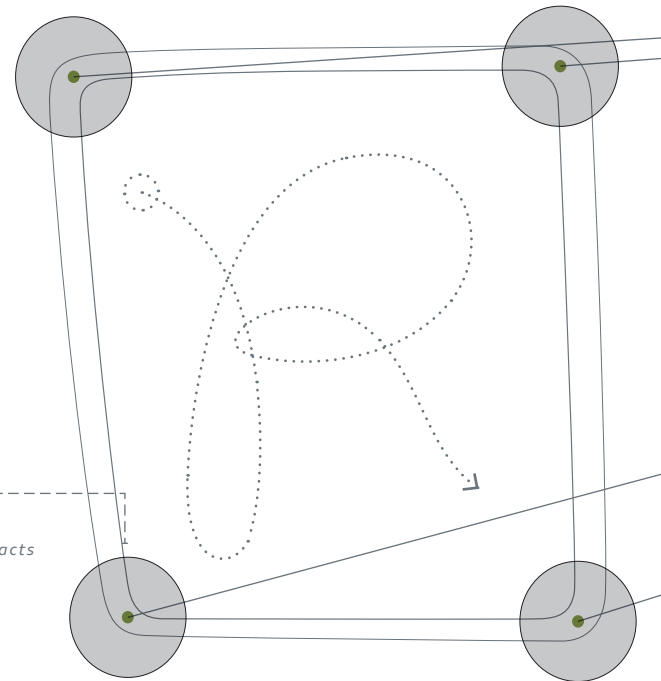

- fig. 03

- letter and number entries for destinations and contacts
- radio preset selection
- album-cover scrolling
- map scrolling
- sound distribution adjustment

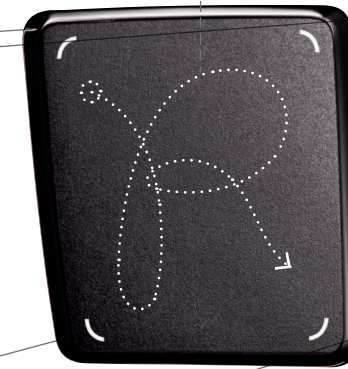

.25 - Audi MMI Touch

Developed by the Audi Human Machine Interface (HMI) team, Audi MMI touch illustrates why making something simple to use can be so complex. The HMI team designed a system so advanced, it can read almost anyone's handwriting—even if you choose to write with your non-dominant hand.



<sup>1</sup> Distracted driving can cause a loss of vehicle control. The features and technologies discussed above are offered for convenience, and should be used only when it is safe and appropriate. The Wi-Fi hotspot feature is intended for passenger use only. Always pay careful attention to the road, and do not drive while distracted. Features may require an additional subscription plan. See dealer for details.



# No one connects you the way we do.



38° 57' 8.1" N  
77° 23' 41.1" W

33° 46' 3.1" N  
118° 11' 26.5" W



## Google Earth™ 3D satellite imagery

With Google Earth™ integration, you'll enjoy 3D topography, including Google Maps Street View, displayed right on the Audi MMI® screen.

## SiriusXM Traffic

Working with your Google Earth™ overlay, you can get traffic conditions and plan alternate routes to help get around traffic backups.<sup>2</sup>

## Reported local fuel prices

Find the lowest reported local price for fuel—and the directions to the station—right through the MMI system.

## Google™ Local Search

Search for destinations via text or voice, using the cloud processing power of Google™ speech recognition and their point-of-interest database.

## myAudi features

Plan your destination from your personal computer and send your route to your A6, for a preprogrammed trip plan.

## Weather information

Current local conditions and forecasts for your destination can help you prepare for your trip.

## News feeds

Stay on top of the news by having headlines and stories delivered right to your MMI display.

## Mobile Wi-Fi hotspot

Provides high-speed connectivity for up to eight passenger devices through an onboard wireless hub.

We set out to change how people interact in and out of their automobiles. A suite of available technologies has made the Audi A6 a true champion of progress. And with Audi connect™ with Google Earth™ imagery and Wi-Fi connectivity for up to eight passenger devices, you have multiple ways to stay connected.<sup>1</sup> You can also access information and navigate entirely with your voice in just a few commands. With that kind of access, Audi helps build on your interactive life while helping enhance your ownership experience.

<sup>1</sup> Distracted driving can cause a loss of vehicle control. The features and technologies discussed above are offered for convenience, and should be used only when it is safe and appropriate. The Wi-Fi hotspot feature is intended for passenger use only. Always pay careful attention to the road, and do not drive while distracted. Features may require additional subscription plan. See dealer for details. <sup>2</sup> See Infotainment/Technology section of the Featured Content page for important information regarding required SiriusXM subscriptions.

To see video and get more information, scan this QR code on your smart phone. Standard text and data usage rates apply.





# Striking a deep note for a shared passion.

For years, while other sound-system engineers were obsessed with what they thought you should be hearing, Audi sound engineers thought about how we impact what people are feeling when they are enjoying music. We found a partner who shared our passion—Bang & Olufsen®—who has helped us conceive a new way of experiencing sounds in your Audi A6. We use speaker positioning, speaker design and precise sound calibration to work in concert with the ambient noise in your car. The results are crisper, more resonant—you might even say, more emotional. Because, if you are only listening, you're not really feeling it.<sup>1</sup>



5.1 surround sound

## .26 - Bang & Olufsen® Advanced Sound System

The passion of Bang & Olufsen® matches well with Audi. By focusing on design and performance together, we bring out the best in outstanding acoustics. Bang & Olufsen® engineers help to sculpt meticulously rendered sound through two innovative retractable aluminum acoustic lenses and an impressive 1,300 watts of pure power.<sup>1</sup>

1,300 watts

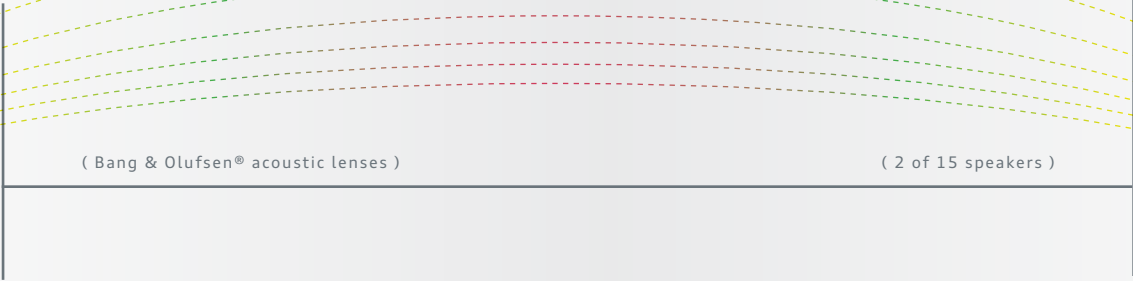

## .27 - ICEpower® Amplifiers

This revolutionary acoustic technology from Bang & Olufsen® helps ensure a powerful sound base without taking up the amount of space or emitting the level of heat that conventional amplifiers do. No wonder Bang & Olufsen® and Audi complement each other so well.<sup>1</sup>



To see video and get more information, scan this QR code on your smart phone. Standard text and data usage rates apply.

<sup>1</sup> Bang & Olufsen® Advanced Sound System is optional on A6 3.0T Prestige models.





## Don't be surprised if you have a lot of tailgaters.

Relish the thought that you just made the day for the people you glided past in your Audi A6. Known for our stylish, signature headlights, Audi also takes pride in how we say goodbye to others with our stunning LED taillight technology. Not only will you leave every straggler pining for more, when they disappear in your rearview mirror, you'll be left with much more than just a grin on your face: a passing realization that you are ushering in a whole new chapter of the automobile.

.28 - LED Taillight Technology

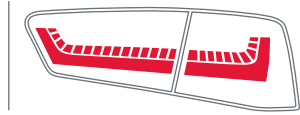

- fig. 04

Sleek and stylish, these rear light-emitting diodes are brighter and longer-lasting than conventional bulbs and illuminate faster than traditional brake lights, which can help give the driver behind you more time to respond.



# Exterior Colors



# Interior Colors | Seat Selections



Standard Seat



Comfort Seat<sup>1</sup>



<sup>1</sup> Standard on Prestige models.

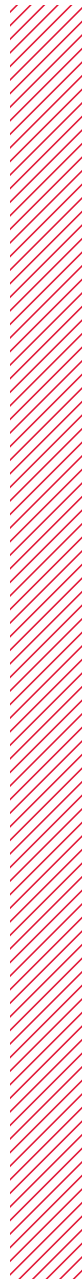



## Decorative Inlays

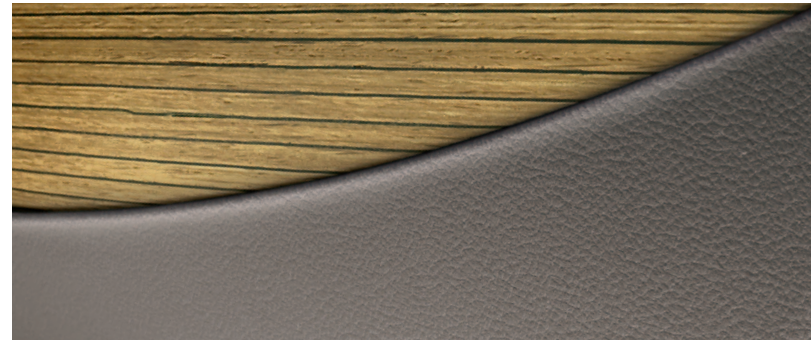
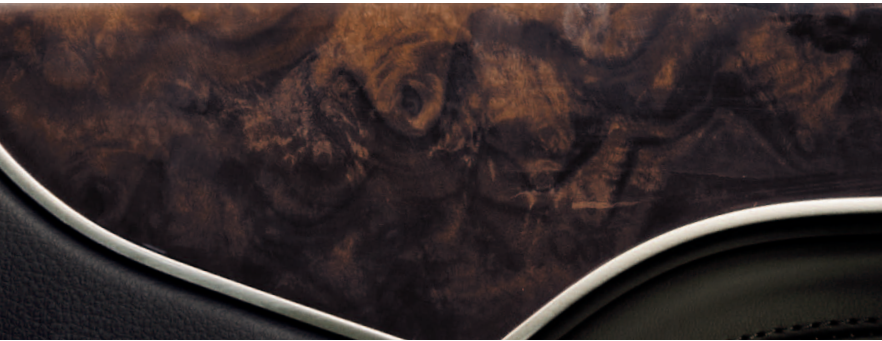

Dark Brown Walnut Wood inlay<sup>1</sup>

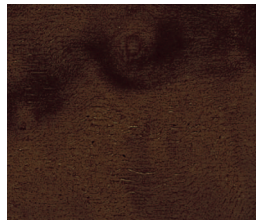

Brushed Aluminum inlay<sup>1</sup>



Fine Grain Ash Natural Brown Wood inlay<sup>1</sup>

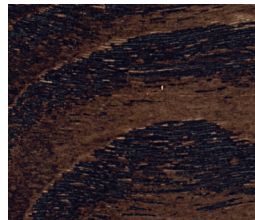

Layered Oak Wood inlay<sup>1</sup>



<sup>1</sup> Decorative inlay options will vary based on model and interior color combination. See your dealer for details.

## Wheels

17" 10-spoke design  
225/55 all-season tires



Premium

18" 5-V-spoke design  
245/45 all-season tires



Premium plus and Prestige

19" 15-spoke-star design  
255/40 summer performance tires<sup>2</sup>



19" Sport package

20" 10-spoke V design  
255/35 summer performance tires<sup>2</sup>



20" Sport package  
Premium plus and Prestige (optional)

<sup>2</sup> Tires are supplied and warranted by their manufacturer. High-performance tires are designed for optimum performance and handling in warm climates. They are not suitable for cold, snowy, or icy weather conditions. If you drive under those circumstances, you should equip your vehicle with all-season or winter tires, which offer better traction under those conditions. We suggest you use the recommended winter or all-season tire specified for your car or its equivalent. These high-performance tires also have a lower aspect ratio that aids performance and handling; however, in order to avoid tire, rim or vehicle damage, it is important that the inflation pressure is regularly checked and maintained at optimum levels. Please also remember in making your selection that, while these tires deliver responsive handling, they may ride less comfortably and make more noise than other choices. Finally, these tires may wear more quickly than other choices.



## Technical Specifications

Engineering   Performance	A6 2.0T	A6 3.0T
Engine type	Four-cylinder	Six-cylinder
Engine block/Cylinder head	Cast iron/aluminum-alloy	Aluminum-alloy
Displacement (cc)/Bore and stroke (mm)	1,984/82.5 x 92.8	2,995/84.5 x 89
Horsepower @ rpm	211 @ 4,300	310 @ 5,500
Torque (lb-ft @ rpm)	258 @ 1,500	325 @ 2,900
Compression ratio	9.6:1	10.3:1
Valvetrain	16-valve DOHC with valvelift system	24-valve DOHC with variable valve timing
Induction/Fuel injection	Turbocharged/TFSI®	Supercharged/TFSI®
Start-stop efficiency system	—	■
Acceleration with Audi multitronic®/Tiptronic® transmission (0–60 mph)	7.5/6.7 seconds	5.3 seconds
Top track speed <sup>1</sup>	130 mph	130 mph

Transmission   Drivetrain	A6 2.0T	A6 3.0T
Audi multitronic® continuously variable transmission with front-wheel drive Gear Ratios: 1st: 3.829, 2nd: 1.686, 3rd: 1.241, 4th: 0.960, 5th: 0.760, 6th: 0.605, 7th: 0.481, 8th: 0.608, Reverse: 4.633, Final Drive: 3.091	Available	—
Eight-speed Tiptronic® automatic transmission with Audi quattro® all-wheel drive Gear Ratios: 1st: 4.714, 2nd: 3.143, 3rd: 2.106, 4th: 1.667, 5th: 1.285, 6th: 1.000, 7th: 0.839, 8th: 0.667, Reverse: 3.317, Final Drive: 2.848	Available	■

Body   Suspension   Chassis	A6 2.0T	A6 3.0T
Audi ultra® lightweight technology-aluminum exterior body panels and a steel frame	■	■
Five-link front suspension	■	■
Trapezoidal-link rear suspension	■	■
Sport suspension calibration	SP	SP/TS
Electromechanical power steering system	■	■

■ Standard    — Not applicable    NA Information not available at time of printing    CW Cold Weather package    DA Driver Assistance package (3.0T only)    IP Innovation package (3.0T only)    SP 19" Sport package    TS 20" Sport package

Exterior measurements	A6 2.0T	A6 3.0T
Wheelbase (in)	114.7	114.7
Length (in)	193.9	193.9
Height (in)	57.8	57.8
Overall width (in)	73.8	73.8
Track, front/rear (in)	64.1/63.7	64.1/63.7
Curb weight with Audi multitronic® transmission (lb)	3,726	—
Curb weight with Tiptronic® transmission (lb)	3,891	4,045
Drag coefficient (Cw)	0.26	0.28

Interior measurements	A6 2.0T	A6 3.0T
Head room (in, front/rear)	37.2/37.8	37.2/37.8
Leg room (in, front/rear)	41.3/37.4	41.3/37.4
Shoulder room (in, front/rear)	57.5/56.3	57.5/56.3
Cargo volume (cu ft)	14.1	14.1
Passenger volume (cu ft)	97.2	97.2
Seating capacity	5	5

EPA mileage estimates   Capacities	A6 2.0T	A6 3.0T
Audi multitronic® transmission (city/highway/combined) <sup>2</sup>	25/33/28	—
Tiptronic® automatic transmission (city/highway/combined) <sup>2</sup>	20/30/24	NA
Engine oil (qt)	5.9	7.2
Fuel (gal)	19.8	19.8
Recommend fuel	Premium	Premium

<sup>1</sup> Top track speed is electronically limited in the U.S. Obey all speed and traffic laws.    <sup>2</sup> 2013 A6 2.0T EPA estimates. 2013 A6 3.0T EPA estimates not available at time of printing. Your mileage will vary.



## Featured Content

Safety   Security	Premium	Premium plus	3.0T Prestige
Driver and front passenger dual-stage airbags, thorax side airbags and Sideguard® head curtain airbags <sup>1</sup>	■	■	■
Driver and front passenger knee airbags <sup>1</sup>	■	■	■
Rear-passenger thorax side airbags <sup>1</sup>	Optional	Optional	Optional
Front passenger occupant detection—for airbags	■	■	■
Safety belt reminder for driver and front passenger	■	■	■
Lower Anchors and Tethers for CHildren (LATCH) in rear seats	■	■	■
Power central locking system with safety unlock feature if airbags deploy	■	■	■
Electronic Stability Control (ESC) with traction control (ASR)	■	■	■
Anti-lock Brake System (ABS) with Electronic Brake-pressure Distribution (EBD) and brake assist	■	■	■
Tire pressure monitoring system	■	■	■
Electromechanical parking brake	■	■	■

Exterior	Premium	Premium plus	3.0T Prestige
Audi Singleframe® grille	■	■	■
Halogen headlights with daytime running lights	■	—	—
Xenon plus headlights with LED daytime running light technology	—	■	—
Adaptive xenon plus headlights with LED daytime running light technology	—	—	■
Full LED headlight technology	—	—	Optional
Automatic headlights	■	■	■
LED taillight technology and rear fog lights	■	■	■
Power-adjustable, heated exterior side mirrors with memory	■	—	—
Power-adjustable, auto-dimming, heated exterior side mirrors with memory	—	■	■
Power-adjustable, power-folding, auto-dimming, heated exterior side mirrors with memory	Optional	DA/Optional	DA/IP/Optional
LED indicator light technology integrated into the exterior side mirrors	■	■	■
Heated windshield washer nozzles	■	■	■
Aluminum trim around exterior windows	■	■	■
Dual exhaust outlets with chrome tips	■	■	■
Audi S line® exterior appearance	—	—	■

■ Standard  
 — Not applicable

NA Information not available at time of printing

CW Cold Weather package

DA Driver Assistance package (3.0T only)

IP Innovation package (3.0T only)

SP 19" Sport package

TS 20" Sport package

Interior	Premium	Premium plus	3.0T Prestige
Three-zone automatic climate control	■	■	—
Four-zone automatic climate control	—	—	■
Four-spoke multifunction steering wheel	■	■	■
Three-spoke multifunction steering wheel with shift paddles	SP	SP/TS	SP/TS
Heated steering wheel	CW	CW	CW
Tilt and telescopic manually adjustable steering column	■	■	—
Power tilt and telescopic adjustable steering column with memory	—	—	■
Decorative interior inlays (see Decorative Inlays page for more detail)	■	■	■
Black cloth headliner	Optional	Optional	Optional
Power windows with one-touch up/down operation and pinch protection	■	■	■
Manual rear-side window and power rear window sunshades	Optional	Optional	Optional
Sunroof	■	■	■

Seating	Premium	Premium plus	3.0T Prestige
Leather seating surfaces (perforated on 3.0T Prestige) (see Interior Colors page for more details)	■	■	■
Eight-way power front seats and four-way power lumbar adjustment for driver	■	■	—
Twelve-way power front comfort seats, including four-way power lumbar adjustment	—	—	■
Heated front seats (2.0T/2.0T with Audi quattro®)	CW/■	CW/■	■
Heated front seats (3.0T)	■	■	■
Ventilated front seats	—	—	■
Heated rear seats	CW	CW	CW
Folding rear seatback with pass-through	■	■	■

Infotainment   Technology	Premium	Premium plus	3.0T Prestige
Audi MMI® Navigation plus with voice control system <sup>2</sup>	—	■	■
Audi MMI® touch with handwriting-recognition technology	—	■	■
Audi connect™ with six-month trial subscription <sup>3</sup>	—	■	■
7" color driver information system	—	■	■

<sup>1</sup> Airbags are supplemental restraints only and will not deploy under all crash circumstances. Always use safety belts and seat children only in the rear, using restraint systems appropriate for their size and age. <sup>2</sup> Audi Navigation plus depends on signals from the worldwide Global Positioning Satellite network. The vehicle's electrical system and existing wireless and satellite technologies must be available and operating properly for the system to function. The system is designed to provide you with suggested routes in locating addresses, destinations and other points of interest. Changes in street names, construction zones, traffic flow, points of interest and other road system changes are beyond the control of Audi of America, Inc. Complete detailed mapping of lanes, roads, streets, toll roads, highways, etc., is not possible, therefore you may encounter discrepancies between the mapping and your actual location. Please rely on your individual judgment in determining whether or not to follow a suggested Audi Navigation plus route. Periodically mapping updates will be available for purchase at an additional cost. Consult your dealer or call 1-800-FOR-AUDI for details. <sup>3</sup> See Audi connect page for important information regarding Audi connect.



## Featured Content

Infotainment   Technology (continued)	Premium	Premium plus	3.0T Prestige
Audi MMI® Radio plus with ten speakers and single CD player with MP3 playback capability	■	■	—
BOSE® sound system with 14 speakers, AudioPilot® noise-compensation and 630 watts	—	Optional	■
Bang & Olufsen® Advanced Sound System with 15 speakers and 1,300 watts	—	—	Optional
HD Radio™ Technology	—	■	■
SiriusXM Satellite Radio with 90-day trial subscription <sup>1</sup>	■	■	■
SiriusXM Traffic with four-year subscription <sup>1</sup>	—	■	■
Audi music interface with iPod® integration	■	■	■
BLUETOOTH® wireless technology preparation for mobile phone	■	■	■
Garage door opener (HomeLink®)	■	■	■
Keyless start	■	■	—
Audi advanced key—keyless start, stop and entry <sup>2</sup>	—	■	■
Cruise control with coast, resume and accelerate features	■	■	■
Audi adaptive cruise control with stop & go	—	DA	DA/IP
Audi active lane assist	—	—	IP
Audi side assist	Optional	DA/Optional	DA/IP/Optional
Audi pre sense rear	Optional	DA/Optional	DA/IP/Optional
Audi pre sense plus—includes Audi pre sense rear	—	DA	DA/IP
Night vision assistant with pedestrian detection and head-up display	—	—	IP
Audi drive select	■	■	■
Parking system plus with rearview camera	—	■	■
Top and corner view camera system	—	—	IP
Rain/light sensor for automatic windshield wipers and headlights	■	■	■

■ Standard   
 NA Information not available at time of printing   
 CW Cold Weather package   
 DA Driver Assistance package (3.0T only)   
 IP Innovation package (3.0T only)   
 SP 19" Sport package   
 TS 20" Sport package

<sup>1</sup> SiriusXM Satellite Radio and Traffic subscriptions sold separately or as a package after trial expires. SiriusXM Traffic service available in select markets. Subscriptions are governed by SiriusXM Customer Agreement (see [www.siriusxm.com](http://www.siriusxm.com)) and are continuous until you call SiriusXM to cancel. Sirius U.S. Satellite Service available only to those 18 and older in the 48 contiguous U.S.A., D.C. and Puerto Rico (with coverage limitations).   
<sup>2</sup> Some Audi models are equipped with a keyless ignition feature. The details as to how the system works can vary and Audi owners should consult their owner's literature or an authorized Audi dealer if they have further questions about the operation of this feature. Please note that Audi warns against leaving the vehicle unattended with the engine running, particularly in enclosed spaces.

## An even bolder way to make an entrance.

If the A6 makes a statement, the Audi A6 Prestige with S line® exterior appearance package is an outright declaration. First off, unique front and rear bumpers give the vehicle a wider, sportier appearance. With the addition of a Platinum Gray rear diffuser, this effect becomes even more pronounced. And with flared side sills adding a muscular, lowered look, the impression all those staring people will be left with will be a lasting one.



2013 Audi A6 3.0T Prestige shown in Dakota Gray metallic with available 19" Sport package and optional full LED headlight technology.



## Accessories

Imagine a cherry on top of your sundae. Sweet, right? Now imagine a cherry that helps protect your A6 in the garage. Or carries your bikes for a serious weekend on the trails. Or makes heads turn as you drive by. Audi Genuine Accessories are the little extras that make your Audi even sweeter. Designed by the same visionaries

who designed your vehicle, all accessories feature a tailored fit and the expert craftsmanship you'd expect from Audi. They are also backed by the 4-year/50,000-mile Audi New Vehicle Limited Warranty or the accessory's 12-month/12,000-mile limited warranty, whichever extends longer from the accessory purchase date.<sup>1</sup>



*Compact Cargo Carrier*

A trim, aerodynamic design that offers a generous 16.95-cu-ft capacity. Size: 81" long, 30" wide, 15" high.<sup>2</sup>



*Aluminum Luggage Basket*

High-quality anodized-aluminum construction and a generous load area make this an excellent carrier. Side rails help prevent load-shifting. Straps sold separately.<sup>2,3</sup>



*20" Diversas Alloy Wheels*

A sporty yet elegant design with five multi-spoke arms. Every Audi alloy wheel design is engineered, manufactured and tested to meet rigorous factory and regulatory standards—an area where other wheels often fall short.



*All-weather Trunk Liner*

Custom fit for the A6. Textured material helps control load-shifting. Raised lip helps contain spills and protect cargo-area carpeting from stains.



*Textile Floor Mats*

These precision-fit mats are made of long-life fabric to help protect the vehicle's interior from the elements. Skid-resistant. Available in black. Set of four mats.



*Splash Protectors*

Help protect the vehicle's finish with custom-fit splash protectors. Made of crack-resistant rubber. Available in sets of two for front or rear. Not compatible with S or Prestige models.



*All-weather Floor Mats*

Deep-ribbed, channeled design helps protect the floor and carpeting from water, mud, sand and snow. Set of four rubber mats come in black and feature the vehicle logo.

*Other accessories not shown* - - - -

### *Audi Genuine Sport and Design Accessories*

Your Audi vehicle features a bold, aggressive stance and strong, stunning lines. Enhance it by adding Audi Genuine Sport and Design Accessories. All are carefully scrutinized in the design and development process. So while they're striking in appearance, they've also passed rigorous quality assessments, including corrosion testing. If you're looking for a bolder appearance or a finishing touch, there is a solution designed by Audi that makes every mile more enjoyable—and more yours.

### *Audi Genuine Alloy Wheels*

Strike the perfect balance between breathtaking design and awe-inspiring performance with Audi Genuine Alloy Wheels. Audi experts have meticulously designed these wheels especially for each Audi model. They're engineered to the highest standards and endure rigorous testing to help ensure long-term quality. Experience eye-catching style that is yours and yours alone. Nothing enhances the bold, dynamic look of your Audi vehicle faster.

### *Audi TravelSpace Transport Accessories*

You go almost everywhere. Give your Audi the proper invitation to be part of your adventures. Never leave the necessary gear behind. Bring it with Audi TravelSpace Transport Accessories. The list includes bike racks, ski racks, a variety of watersports equipment carriers and various sizes of cargo carriers. Wherever you go, make sure almost everything fits with a variety of intelligent and innovative solutions. Accessories designed for your life—the passionate, active part.

### *Audi Genuine Electronics Accessories*

The illuminating technology that graces each Audi vehicle provides the inspiration for Audi Genuine Electronics Accessories. Similarly, all of these accessories are impressively advanced and inspiring. Our audio options let you enhance your listening pleasure. Other accessory options help promote safer, more convenient travel. All are designed and tested to help ensure compatibility with the vehicle's electrical systems, allowing you to enjoy every aspect of Audi technology with almost all your senses. Demand the best and drive with added confidence.

### *Audi Guard Comfort and Protection Accessories*

Protect what you love. Audi Guard Comfort and Protection Accessories offer functional, practical items that help keep your Audi in pristine condition. Choose from such useful items as trunk liners that help make clean-up quick and easy or an easy-to-use storage cover that helps shield the vehicle. Use them all to help reduce wear and tear and keep the vehicle looking like new—inside and out. All are engineered to stringent Audi standards, so you can be assured of their quality and durability.

<sup>1</sup> See dealer for details. <sup>2</sup> All roof-rack system attachments require the base carrier bars. All attachments sold separately. <sup>3</sup> Recreational equipment, sporting equipment and luggage not included.