

A7



A7

Audi A7

Note: A word about this brochure. Audi of America, Inc., believes the specifications in this brochure to be correct at the time of printing. However, specifications, standard equipment, options, fabrics, and colors are subject to change without notice. Some equipment may be unavailable when your vehicle is built. Please ask your dealer for advice concerning current availability of standard and optional equipment, and your dealer will verify that your vehicle will include the equipment you ordered. Vehicles in this brochure are shown with optional equipment. See your dealer for complete details on the New Vehicle Limited Warranty, twelve-year limited warranty against corrosion perforation, and Audi 24/7 Roadside Assistance. (Roadside assistance coverage provided by Road America in the U.S. Certain conditions apply; see your dealer for details.) Tires supplied by various manufacturers. "Audi," all model names, "Audi connect," "FSI," "MMI," "quattro," "Sideguard," "Singleframe" and the Singleframe grille design, "S line," "S tronic," "TFSI," "Truth in Engineering," "ultra" and the four rings logo are trademarks or registered trademarks of AUDI AG. "Bang & Olufsen" and "ICEpower" are registered trademarks of Bang & Olufsen. The BLUETOOTH word mark and logos are owned by the Bluetooth SIG, Inc., and use of any such marks by AUDI AG is under license. "BOSE" and "AudioPilot" are registered trademarks of the Bose Corporation. "GOOGLE," "Google Earth" and "Google Maps Street View" are trademarks of Google Inc. "HD Radio" and the HD Radio logo are proprietary trademarks of iBiquity Digital Corporation. "Home-Link" is a registered trademark of Johnson Controls Technology Company. "iPod" is a registered trademark of Apple Inc. "SiriusXM" and all related marks and logos are trademarks of SiriusXM Radio Inc. and its subsidiaries. "Tiptronic" is a registered trademark of Dr. Ing h.c. F. Porsche AG. All other trademarks are the property of their respective owners. Some European models shown.

2013 | A7

Audi of America
Audiusa.com
Facebook.com/Audi

The wisdom of staying young and bold.

There is a way to announce that you enjoy life on your own terms without saying a single word. Introducing the 2013 Audi A7. Its captivating lines and striking silhouette tell a story of design unimpeded by convention. And the signature Audi Singleframe® grille and sloping roofline speak volumes about its affection for timeless style. But there's more to this narrative than just attractive sheet metal. Consider the extensive list of available advanced technologies—Audi MMI® touch, Google Earth™ imagery, and embedded Wi-Fi hotspot, to name just a few.¹ And when it comes to performance, you can rest assured the 310-hp supercharged V6 engine and legendary Audi quattro® all-wheel drive will lay to rest any notion that this car prefers style over substance.



- fig. 01

.01 - Full LED Headlight Technology

The Audi A7 offers full LED headlights. With an approximate lifespan of 10,000 hours, these lights are the closest re-creation of daylight yet.² Bright and stylish, they offer signature brilliance from Audi.



Standard text and data usage rates apply.

¹ Distracted driving can cause a loss of vehicle control. The features and technologies discussed above are offered for convenience, and should be used only when it is safe and appropriate. The Wi-Fi hotspot feature is intended for passenger use only. Always pay careful attention to the road, and do not drive while distracted. Features may require an additional subscription plan. See dealer for details. ² Based on brightness comparison to the sun and 5,500 K color temperature. Full LED headlights are an optional upgrade.

Forget the quo, enjoy the status.

Some molds should never be broken—but that doesn't mean new ones can't be imagined. This was the opportunity the A7 presented. Audi designers were given a blank canvas, and the typical constraints of design were lifted. The result? A sculpted body that was shaped from the ground up instead of molded by conventional, top-down thinking. You see the difference in every curve of the A7. Each line, slope and angle represents a novel approach to design, giving style a muscular profile—and muscle a sleek side. Think of driving one as art appreciation in its most dynamic form.



A story is only as good as its characters.

Some writers try to conceive one brilliant character and let the plot organically build and flow from there. We took a page from their book, so to speak, when designing the Audi A7. To create and define that brilliant character, we started with one great line. The Tornado line. Bisecting the body profile, it runs strongly through the middle of the vehicle to give it a bold, progressive stance that tells the world that there's pedigree here, but not a predictable one. After that, the narrative becomes yours.



.02 - Adaptive Rear Spoiler

Automatically deployed at speeds over 80 mph, the adaptive rear spoiler helps provide additional downforce to enhance the dynamic performance of the A7.¹



.03 - Design Lines

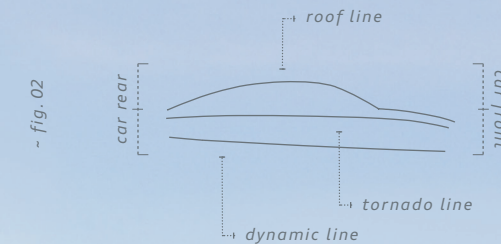

See how the A7 model's Dynamic line defines the lighting surfaces while also bringing the vehicle closer to the road. Its Roof line creates a sporty coupe-like silhouette, while the Tornado line extends along the entire body to provide its visual muscle.

¹ Always obey local speed and traffic laws.



S7

A wolf in wolf's clothing.

There's no hiding this vehicle's ultimate purpose—as with all Audi Sport performance cars, the visceral reaction you get at first glance is more than validated when you get behind the wheel. The bold, muscular body and S-specific design cues of the Audi S7 are constant reminders that this is a performance car above all else. A 420-hp, 4.0-liter TFSI® V8 harnessed to the relentless grip of Audi quattro® all-wheel drive makes clear the intentions of the S7. One only has to peek at the interior, featuring signature sport seats with integrated head restraints and specialized design cues, to know that this is a luxury sports car that doesn't play dress-up. This isn't the model for sheep.



- ENGINE // 4.0-liter turbocharged TFSI V8 developing 420 hp and 406 lb-ft of torque

- DRIVETRAIN // Audi quattro® all-wheel drive with sports differential
Seven-speed Audi S tronic® dual-clutch transmission

- CHASSIS // S7 tuned Audi adaptive air suspension, Audi drive select

- BRAKES // 15.7" ventilated front disc brakes with S7 logo, 14" ventilated rear disc brakes

- PERFORMANCE // Top track speed of 155 mph¹; acceleration from 0 to 60 mph in 4.5 seconds

Audi Sport

There's more information on the Audi Sport model line in the all-new 2013 Audi Sport brochure. See your dealer or go to audiusa.com for details.

2013 Audi S7 shown in Glacier White metallic with available Driver Assistance package, and optional full LED headlight technology and 20" 5-parallel-spoke-star design wheels.

¹ Top track speed is electronically limited in the U.S. Obey all speed and traffic laws.



**Progressive design,
in duplicate.**



Our designers held nothing back when it came to creating a unique space, even going so far as to replicate shapes throughout the vehicle, inside and out. Notice how the shape of the decorative inlay around the inside door handle echoes the window behind the rear passenger door. And the way the aluminum trim surrounding the windows closely mirrors the aluminum trim accenting the interior wood inlays. This kind of unique design pairing was done to enhance the connection between the interior and exterior.



The image shows the driver's side interior of a 2013 Audi A7 Prestige. The steering wheel is black with the Audi logo and 'AIRBAG' text. The dashboard is black with wood inlays and a 'quattro' badge. The center console features a gear shifter, handbrake, and various controls. The seats are upholstered in light-colored leather with perforated sections. A digital display on the dashboard shows 'Audi drive select' with options for Comfort, Auto, and Dynamic. The instrument cluster includes a tachometer and speedometer. The overall design is sleek and modern.

From here, the potential is plain to see.

It's time to put yourself in the driver's seat. Feel how the wraparound curve of the Audi A7 dashboard invites your exploration. See how it integrates intuitively with the overall driver-centric layout. Discover how the highly acclaimed fit and finish is reflected in places like the extremely tight panel gaps. Then admire the finely crafted wood inlays and aluminum trim that wrap around inside the car on the door and the dash. Now spark the ignition. It's your time to drive.

4.04 - Decorative Inlays

Beautifully crafted wood or aluminum inlays add a warm and sophisticated touch to an already regal interior. And with numerous finishes available, you can be sure this space will be all yours.

Stylized function in its revolutionary form.

Why challenge conventions when you can make new ones? Our innovative design team rewrote the rules for interior appointments, and built style with purpose in mind. With luxurious materials, and available twelve-way power front seats and four-zone automatic climate control in the Audi A7, you literally create a unique cabin environment to fit your own unique style. This is true for the smallest details too, like an available heated steering wheel, or heated and ventilated front seats that help keep you comfortable so you can enjoy driving the A7 even more.

.05 - Climate Control

Personal attention has been taken to new heights in the A7. With the available four-zone automatic climate control, every person in the vehicle has the ability to dial in their ideal temperature.



.06 - Heated Rear Seats

In here, no passenger is left out in the cold. When the mercury drops, your two rear passengers can take soothing comfort in the available heated rear seats.



2013 Audi A7 Prestige shown in Velvet Beige leather with optional Dark Brown Walnut Wood decorative inlays.

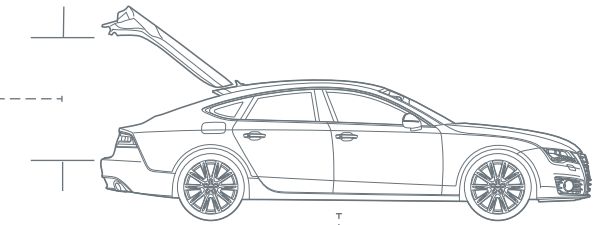

.07 - Power Rear Tailgate

Carefully integrated into the rear design, the power rear tailgate on the A7 gives you programmable endpoints so you can adjust the opening to the height you choose, better to accommodate personal preferences and tighter spaces.

.08 - Cargo Capacity

With 24.5 cu ft of cargo capacity, with the rear seats in place, you'd be forgiven for thinking the A7 might moonlight as a much larger vehicle.¹ And with all that extra space, you can forget about deciding between bringing an extra golf bag or more clothes. Bring it all.



1				
2	3			
4	5	6		
7	8	9		
10	11	12		
13	14	15	16	
17	18	19	20	
21	22	23	24	.5

24.5

quattro

It's a bond between your car and the road.

It's true that while Audi quattro® all-wheel drive may have been engineered to help drive through inclement weather and in low-traction situations, the real magic of this advanced system is how it performs in the dry. Power is distributed to all four wheels working in concert to help grip every corner while giving you the optimal amount of power delivery where and when it's needed. In other words, quattro® helps enhance performance by appropriately transferring power to the necessary wheels when accelerating and turning, so you have confidence-inspiring performance when the road isn't at its best. Inclement weather aside, the really gripping story about quattro® is how it performs overall, forging a sure bond between you, your Audi A7 and the road.¹

Confidence-inspiring

Under ideal conditions, power is 40:60 rear-wheel-biased to help maximize acceleration and cornering, but the instant conditions become more challenging, the ratio is optimized for superior grip and control.

Torque split

When accelerating out of a turn, up to 80% of the power is mechanically shifted to the rear wheels, where it's best allocated to propel the vehicle to your desired speed and onto the straightaway. Once traveling in a straight line again, the 40:60 power distribution that quattro® delivers to the front and rear wheels, respectively, gives you maximum torque to push onward.

Torque vectoring

It's a handling feature that seems to respond to your impulses before your steering input. An evolution of cross-axle lock, this system works within quattro®, while utilizing ESC and ABS to help sense traction loss from the inside cornering tire.

¹ When driving during cold, rainy, snowy or icy weather conditions, ensure that your vehicle is equipped with appropriate all-season or winter-weather tires. Even with appropriate tires, you must always drive in a manner appropriate for the weather, visibility and road conditions.

It's time to throw the road a curve.

Audi quattro® all-wheel drive is more than visionary engineering—it's actually a response to the conditions around our Ingolstadt headquarters. With the weather and the terrain the way they are, all-wheel drive seemed like a smart solution for the problems presented. Since they design mountain roads with hairpin turns, it's only natural that we wanted to turn the tables on the road. Here's how it works:

It might feel like we read your mind.

While the engineering on the Audi A7 helps to elevate the driving profile and performance characteristics, it's not a totally refined sensibility we're after. We are a performance company as much as an engineering or luxury one. The result is intensity that uses technology to its benefit, without taking away from the visceral thrill of driving.

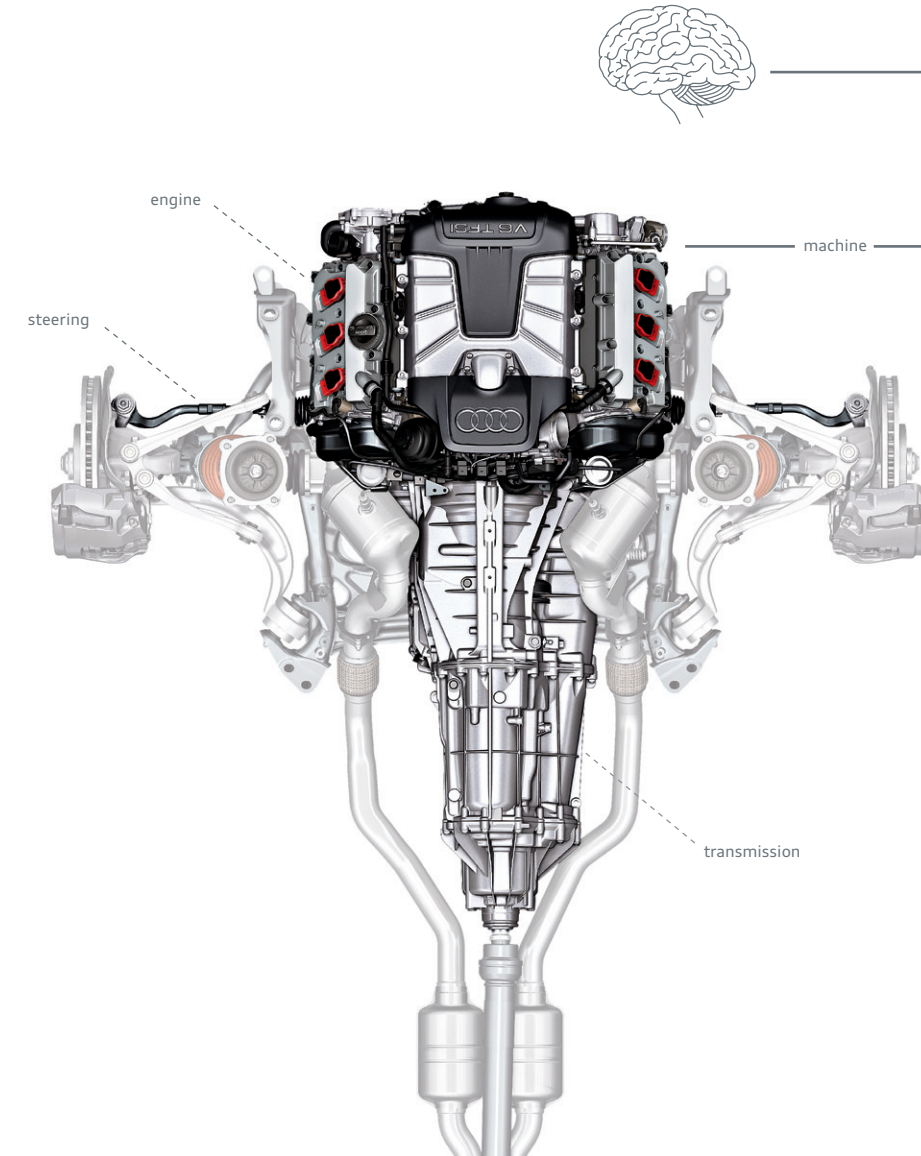
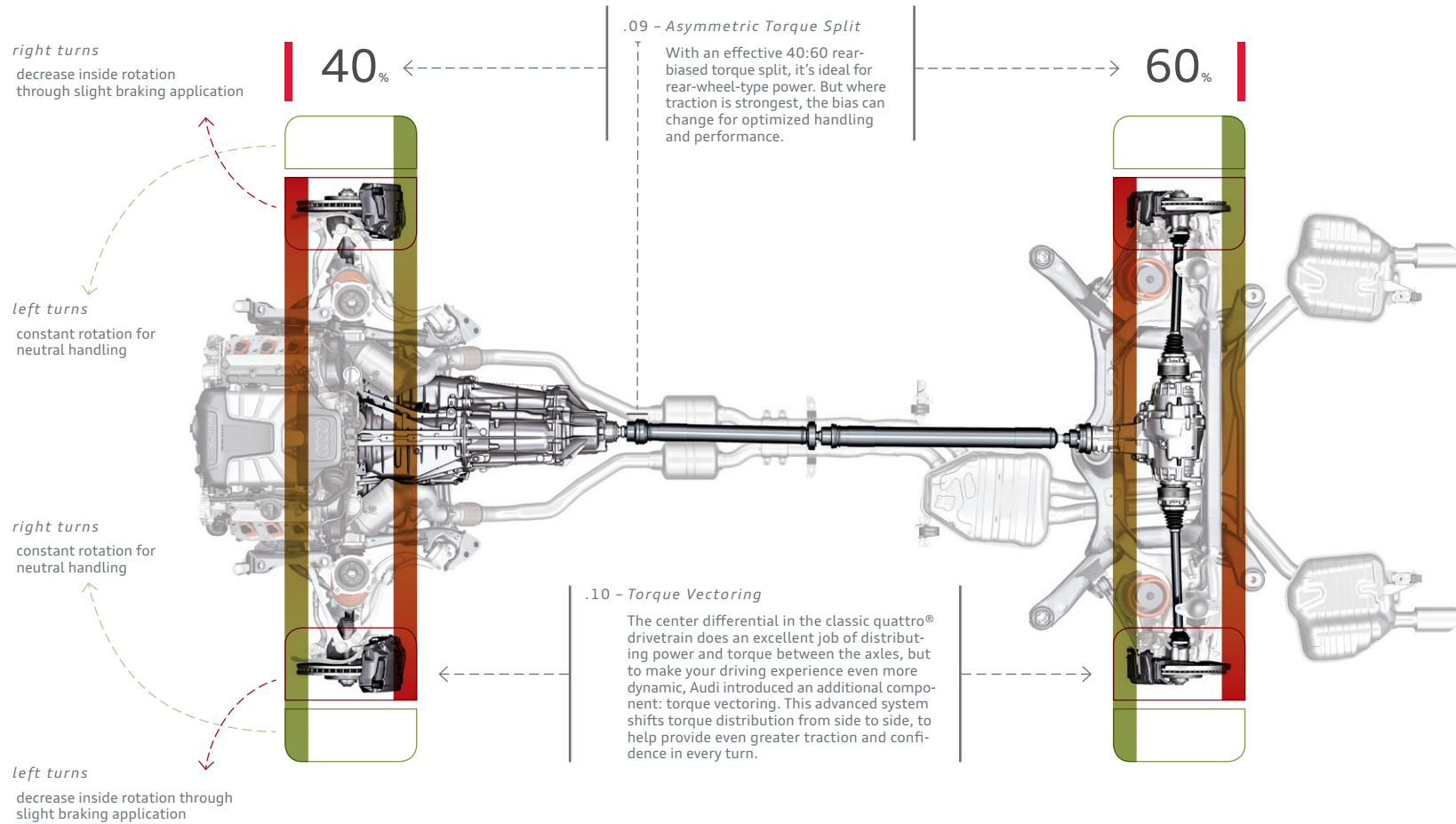

- peaceful
- balanced
- fun
- individualized

.11 - Audi Drive Select

Our drive is responsive, but we also demand that you respond to the drive. With Audi drive select, you choose Comfort, Dynamic, Auto or Individual settings that configure the engine, transmission and steering to respond to your mood or the conditions, or just to experiment with drive settings that range from outstandingly comfortable to intensely sporty.

- **Comfort mode**
Perfect for less-than-perfect roads, this setting adds optimized steering and a closer shift pattern to help provide a more relaxed drive.
- **Dynamic mode**
More precise steering and a more responsive throttle give this setting an aggressive feel and focused performance.
- **Auto mode**
The best of both worlds, dialed to automatically adjust settings for a seamless combination of comfort and responsiveness based on your driving style and road conditions.
- **Individual mode**
Take the turn your way—this mode allows you to adjust the steering, throttle and transmission upshifts to your style.

Realize your kinetic potential faster.

We're not losing weight for looks, but because it makes us stronger and more agile. By lightening our static weight throughout our frame and our engine, we are able to harness more power more quickly—and, not incidentally, more efficiently. That means the Audi A7 has a supercharged 3.0-liter engine that delivers the potent acceleration of a traditional V8 with the efficiency of a V6. Improved mpg¹ and an increased heart rate. Great reasons for slimming down.

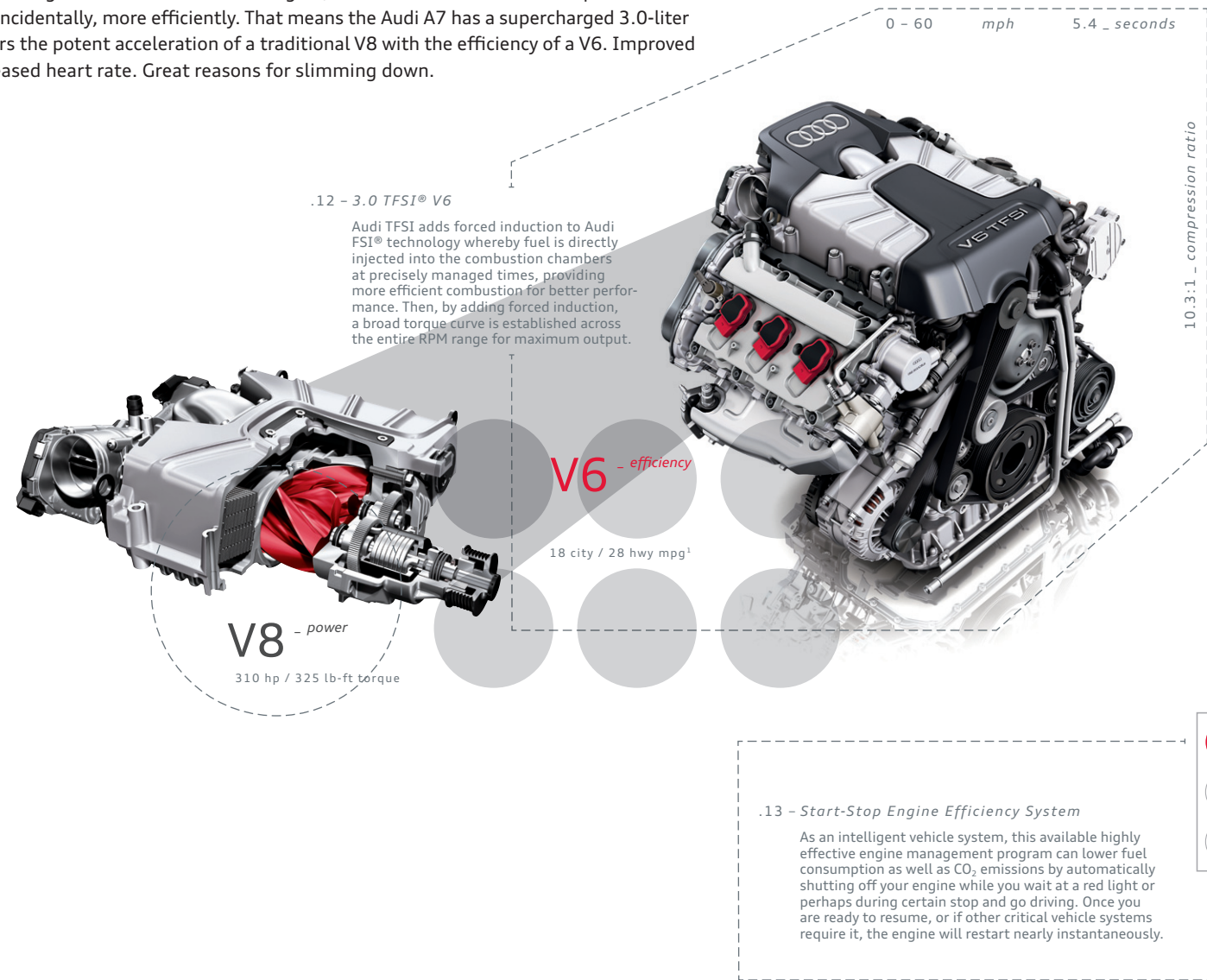

With this kind of response, you might not care how efficient you've become.

This is where German engineering finds a new gear. Not content with a heritage of performance, we've developed an even more responsive and efficient way of applying power. Our revolutionary eight-speed Tiptronic® automatic transmission with Dynamic Shift Program (DSP) helps to enhance performance while also allowing you to command upshifts or downshifts through the available steering wheel-mounted shift paddles. Basically, it's the type of transmission one would expect from Audi.

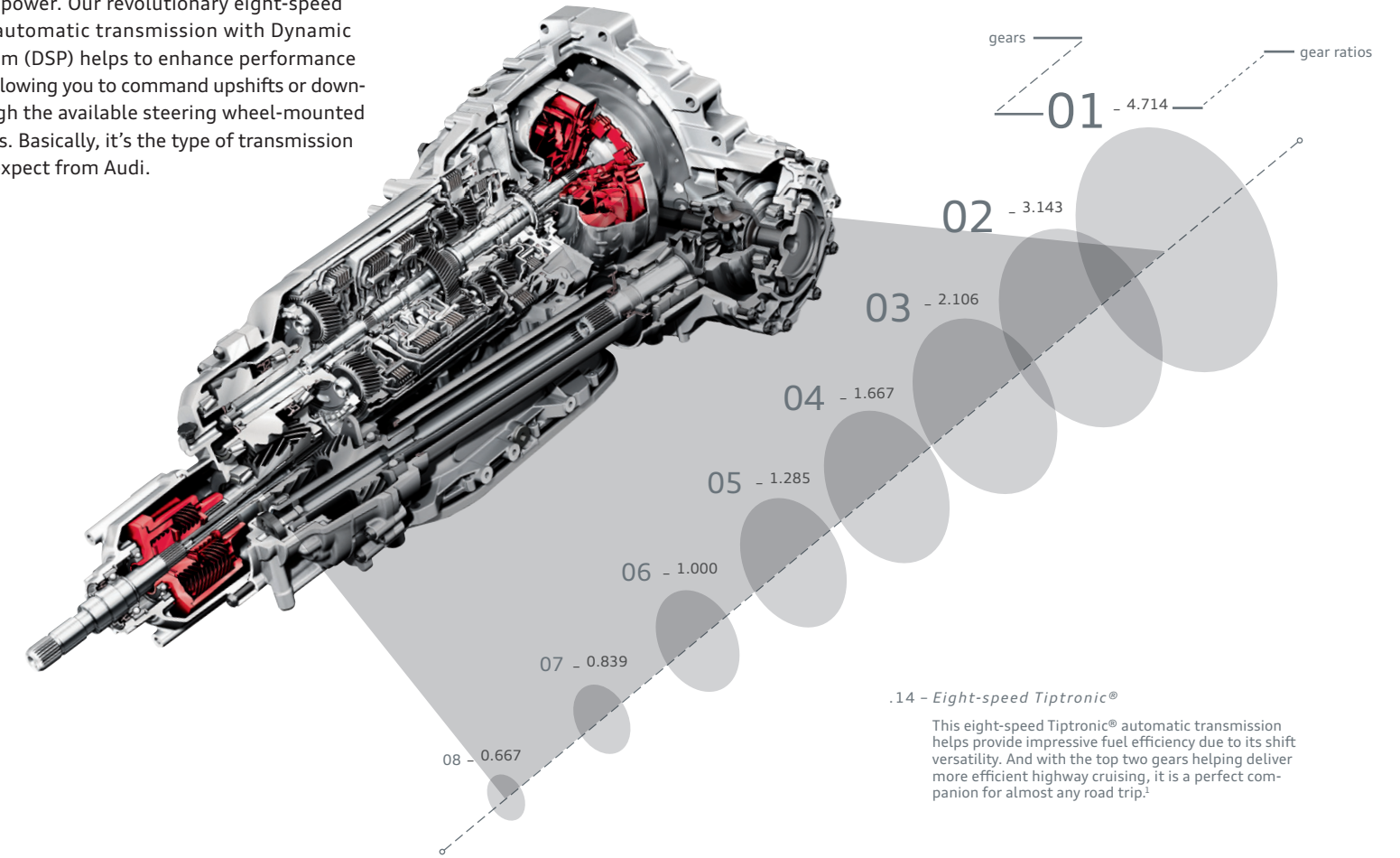

¹ 18 city/28 highway mpg (2013 A7 3.0T, with eight-speed Tiptronic® automatic transmission with Audi quattro® all-wheel drive). EPA estimates. Your mileage will vary.

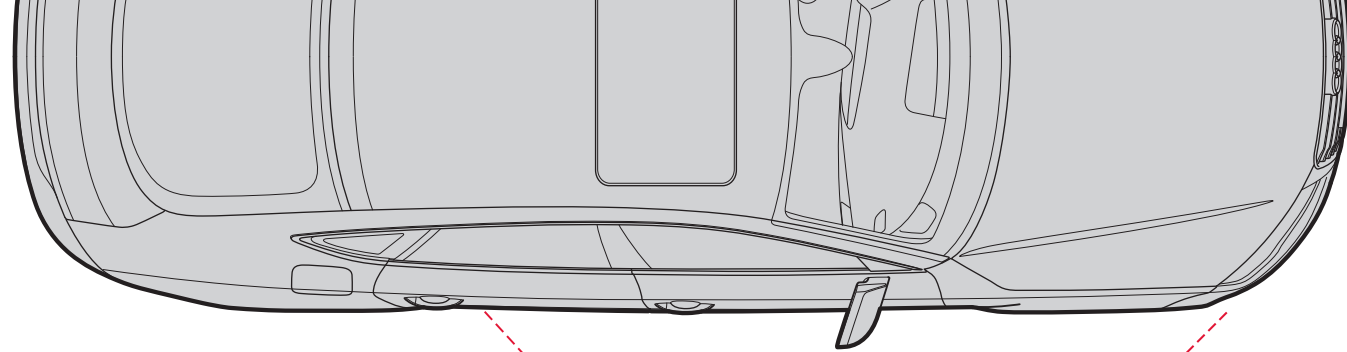

.16 - Head-up Display



Easy-to-view, accurate visual information right at eye level, this available feature displays important driving information and even pedestrian-detection warnings.

.17 - Night Vision Assistant



With an infrared camera detecting what lies ahead, this available feature uses thermal-imaging technology to help you avoid trouble. Pedestrians can be detected over 300 feet in front of the vehicle, while objects can be detected over 900 feet ahead—all shown on the 7" color driver information system.

.18 - Corner View Cameras

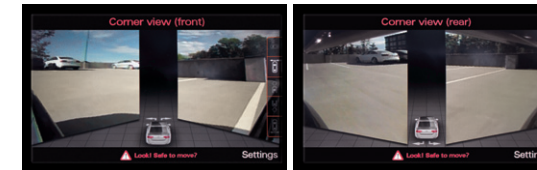

Giving you a nearly 360-degree view around the vehicle, the available corner view cameras help make parking significantly easier thanks to combined camera images from the front, rear and sides of the vehicle.¹

.15 - Audi Side Assist

The available Audi side assist uses radar sensors and two different optical warnings to help keep the driver informed of what is approaching from hard-to-see angles behind and to the side of the vehicle.

.19 - Audi Active Lane Assist

Operating at speeds above 38 mph, this available system helps detect when the vehicle begins to leave the lane without signaling. Then, through gentle, corrective steering efforts, it helps the vehicle remain in the lane and vibrates the steering wheel as an additional warning. This way, Audi active lane assist complements the driver's decision-making process to further solidify the bond between driver and machine.

.20 - Audi Adaptive Cruise Control with Stop & Go

Not only retains a preset distance from vehicles ahead, but resumes acceleration when you're ready. Using long-range radar and a camera, the available Audi adaptive cruise control with stop & go helps read the traffic conditions and adjusts the speed, helping to bring the vehicle to a full stop before accelerating when traffic flow resumes.

.21 - Audi Pre Sense Plus

The available Audi pre sense plus offers comprehensive driving assistance with sensors in the front, side and rear. After visual, physical and aural collision warnings, there are four distinct phases for automatic preparation for the unavoidable: an upsurge of brake pressure, safety belt pre-tensioning, partial braking, and sunroof and window preparation. In severe cases, Audi pre sense plus will engage full braking and deceleration.

Focused on the other drivers' distractions.

The suite of available driver-assistance technologies takes into account the actions of other drivers—while helping make your drive a little easier. From seemingly sentient Audi adaptive cruise control with stop & go to Audi active lane assist, the Audi A7 has incorporated innovative, anticipatory technologies that don't see your future so much as help change it.

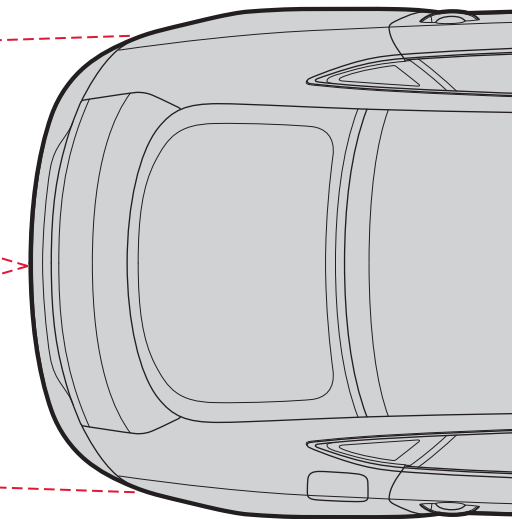
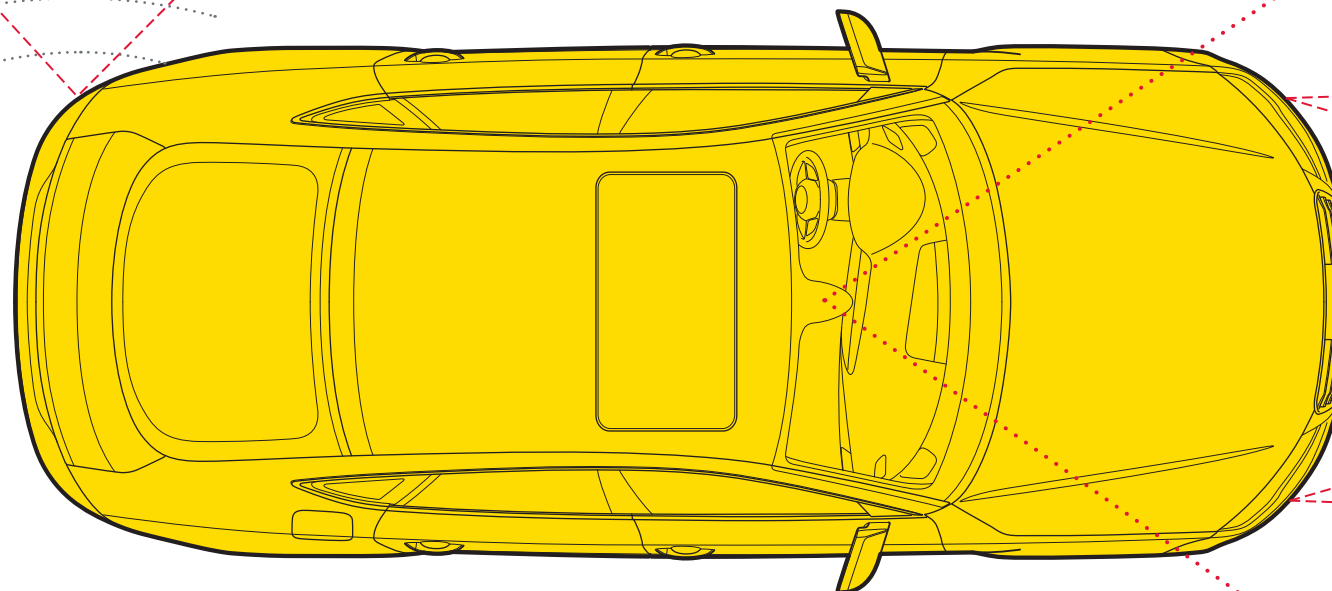

Safety does better with a little structure.

The Audi A7 might not be the car for you if you don't want peace of mind. Innovative safety features lead the way in Audi progressive thinking, so you can concentrate on better things, like the great performance of your A7. With up to ten airbags¹ helping to protect nearly every inch of the cabin, an adaptive restraint system protecting its occupants, and advanced safety technologies that help you maintain control, Audi thinks of safety in a comprehensive way. Surrounding you with it. So you know you're not alone out there.

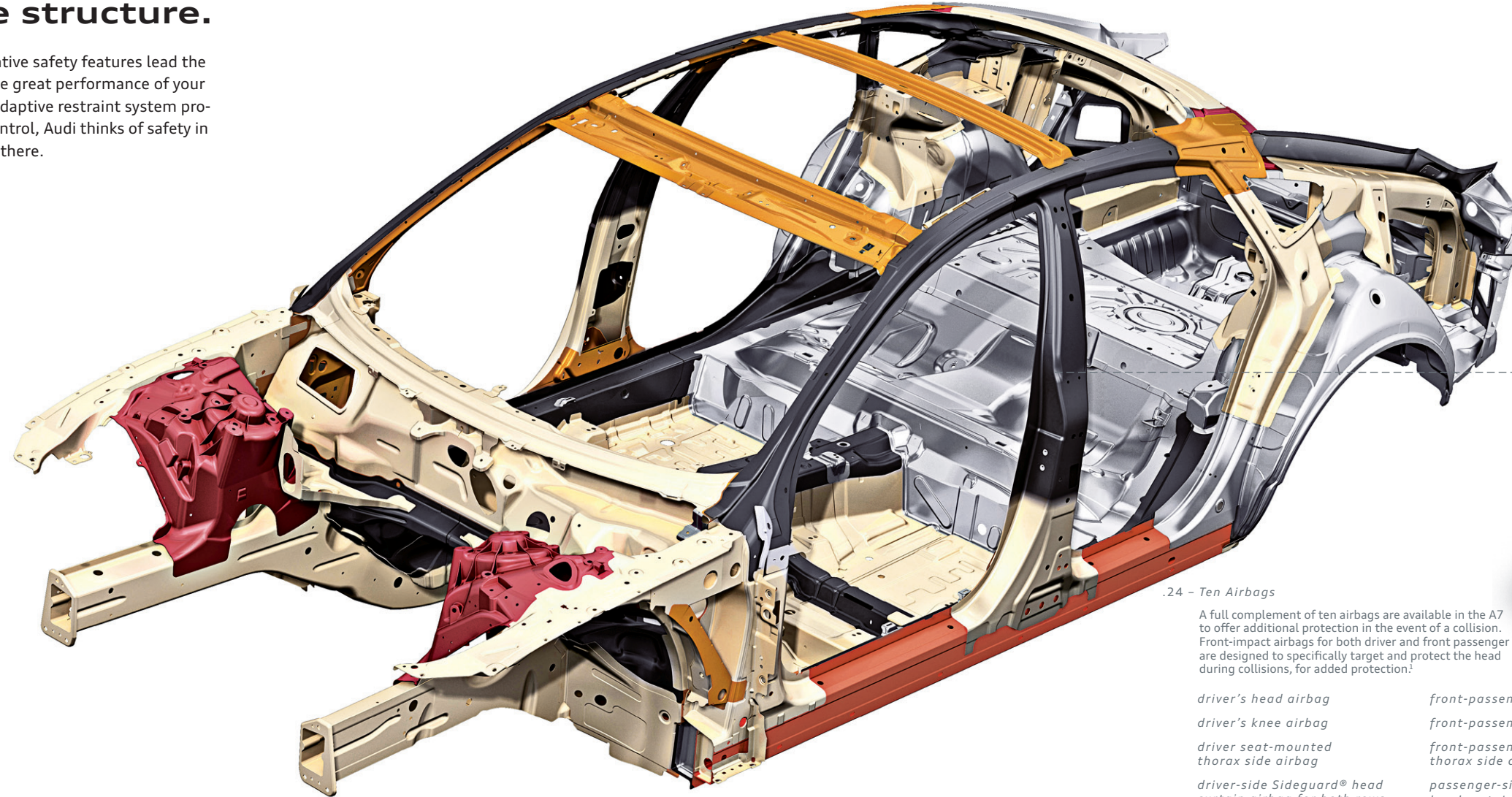

.22 - Passive Safety

Referring to all dedicated measures that help protect the car's occupants against injury, the passive safety measures in the A7 include its safety belt system, ten airbags¹, the rigid occupant cell and crumple zones at the front and rear of the vehicle.

.23 - ESC and ABS

Computerized technology that works in perfect sync with the Anti-lock Brake System (ABS), Electronic Stability Control (ESC) helps minimize any loss of stability, applying brake pressure to individual wheels and reducing throttle input to help counter oversteer or understeer when the vehicle needs it.



.25 - Tailor-made Blanks

Developed to make the best possible use of the body's potential, tailor-made blanks use a special manufacturing process that can help strengthen the upper zone of the B-pillars while the lower zone is designed to help mitigate the impact in the event of a side collision.



Dramatization²

.24 - Ten Airbags

A full complement of ten airbags are available in the A7 to offer additional protection in the event of a collision. Front-impact airbags for both driver and front passenger are designed to specifically target and protect the head during collisions, for added protection.¹

driver's head airbag

driver's knee airbag

driver seat-mounted

thorax side airbag

driver-side Sideguard® head curtain airbag for both rows of seats

driver-side rear seat-mounted thorax side airbag

front-passenger head airbag

front-passenger knee airbag

front-passenger seat-mounted

thorax side airbag

passenger-side Sideguard® head curtain airbag for both rows of seats

passenger-side rear seat-mounted thorax side airbag

■ mild steel

■ high strength steel

■ modern high strength steel

■ ultra high strength steel

■ cast aluminum

■ ultra high strength steel (hot formed)

¹ Airbags are supplemental restraints only and will not deploy under all crash circumstances. Always use safety belts and seat children only in the rear, using restraint systems appropriate for their size and age. ² This is a dramatization and does not depict what will happen in a collision. All bags will not inflate in real-world collisions, and, if multiple bags do deploy, they will be in various stages of inflating/deflating and will never all be inflated at the same time.

Input as unique as your fingerprint.

What does your handwriting say about you? We aren't really sure. We just know it speaks to us. A revolution in intelligent simplicity, the available Audi MMI® touch with handwriting recognition is a technology that gives you the ability to give commands and retrieve media simply by recognizing a few strokes of your finger. Access information such as music files, contact information, and destinations through the Audi MMI touch—or give input to the optional Audi connect™, an innovative media system with Google Earth™ mapping service. The world isn't simply at your fingertips—your fingertips open up a new way to interact with the world.¹

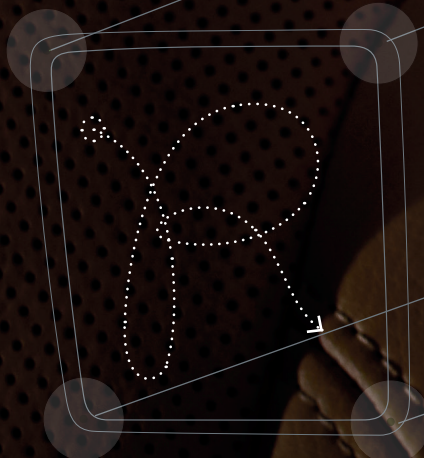

.26 - Audi MMI® Touch

Developed by the Audi Human Machine Interface (HMI) team, Audi MMI touch illustrates why making something simple to use can be so complex. The HMI team designed a system so advanced, it can read almost anyone's handwriting—even if you choose to write with your non-dominant hand.



.27 - Audi MMI Navigation plus

Count on the available advanced navigation system to home in on your destination with stunning precision while putting a little more depth in your journey with help from Google Earth™.²

.28 - BLUETOOTH® Technology

Unlock your mobile phone's potential through the MMI system. Simply pair them up and start enjoying near complete control at the touch of a button.³



.29 - SiriusXM Satellite Radio

Go ahead. Crisscross the country. We assure you, you'll never run out of entertainment options, with over 130 channels of music, talk and news.⁴

.30 - Audi Audio

The media button opens up a world of options, allowing you to control the Audi music interface, Secure Digital (SD) card slots, hard disk drive (HDD) audio jukebox or DVD player.

¹ Distracted driving can cause a loss of vehicle control. The features and technologies discussed above are offered for convenience, and should be used only when it is safe and appropriate. The Wi-Fi hotspot feature is intended for passenger use only. Always pay careful attention to the road, and do not drive while distracted. Features may require an additional subscription plan. See dealer for details. ² See Infotainment/Technology section of the Featured Content page for important information regarding Audi Navigation plus and required SiriusXM subscriptions. ³ Requires compatible phone.

No one connects you the way we do.



38° 57' 8.1" N
77° 23' 41.1" W

33° 46' 3.1" N
118° 11' 26.5" W

- **Google Earth™ 3D satellite imagery**
 With Google Earth™ integration, you'll enjoy 3D topography, including Google Maps Street View, displayed right on the Audi MMI® screen.
- **SiriusXM Traffic**
 Working with your Google Earth™ overlay, you can get traffic conditions and plan alternate routes to help get around traffic backups.²
- **Reported local fuel prices**
 Find the lowest reported local price for fuel—and the directions to the station—right through the MMI system.
- **Google™ Local Search**
 Search for destinations via text or voice, using the cloud processing power of Google™ speech recognition and their point-of-interest database.
- **myAudi features**
 Plan your destination from your personal computer and send your route to your A7, for a preprogrammed trip plan.
- **Weather information**
 Current local conditions and forecasts for your destination can help you prepare for your trip.
- **News feeds**
 Stay on top of the news by having headlines and stories delivered right to your MMI display.
- **Mobile Wi-Fi hotspot**
 Provides high-speed connectivity for up to eight passenger devices through an onboard wireless hub.

We set out to change how people interact in and out of their automobiles. A suite of available technologies has made the Audi A7 a true champion of progress. And with Audi connect™ with Google Earth™ imagery and Wi-Fi connectivity for up to eight passenger devices, you have multiple ways to stay connected.¹ You can also access information and navigate entirely with your voice in just a few commands. With that kind of access, Audi helps build on your interactive life while helping enhance your ownership experience.

¹ Distracted driving can cause a loss of vehicle control. The features and technologies discussed above are offered for convenience, and should be used only when it is safe and appropriate. The Wi-Fi hotspot feature is intended for passenger use only. Always pay careful attention to the road, and do not drive while distracted. Features may require additional subscription plan. See dealer for details. ² See Infotainment/Technology section of the Featured Content page for important information regarding required SiriusXM subscriptions.

To see video and get more information, scan this QR code on your smart phone. Standard text and data usage rates apply.



Striking a deep note for a shared passion.

For years, while other sound-system engineers were obsessed with what they thought you should be hearing, Audi sound engineers thought about how we impact what people are feeling when they are enjoying music. We found a partner who shared our passion—Bang & Olufsen®—who has helped us conceive a new way of experiencing sounds in your Audi A7. We use speaker positioning, speaker design and precise sound calibration to work in concert with the ambient noise in your car. The results are crisper, more resonant—you might even say, more emotional. Because, if you are only listening, you're not really feeling it.¹

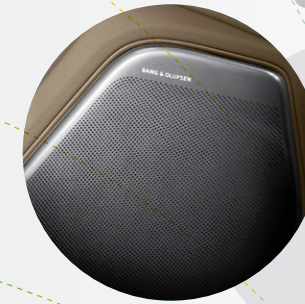

5.1 surround sound

.31 - Bang & Olufsen® Advanced Sound System

The passion of Bang & Olufsen® matches well with Audi. By focusing on design and performance together, we bring out the best in outstanding acoustics. Bang & Olufsen® engineers help to sculpt meticulously rendered sound through two innovative retractable aluminum acoustic lenses and an impressive 1,300 watts of pure power.¹

1,300 watts



(Bang & Olufsen® acoustic lenses)

(2 of 15 speakers)

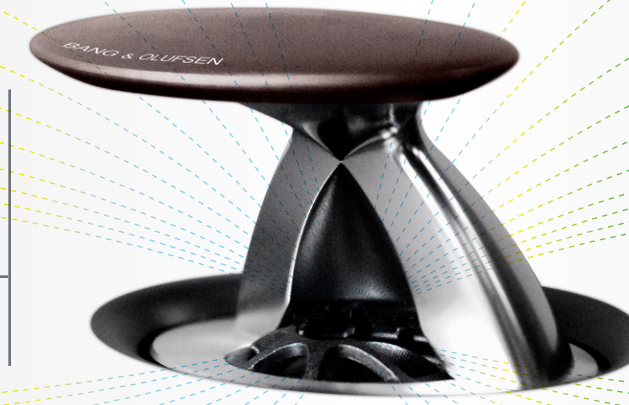

To see video and get more information, scan this QR code on your smart phone. Standard text and data usage rates apply.

.32 - ICEpower® Amplifiers

This revolutionary acoustic technology from Bang & Olufsen® helps ensure a powerful sound base without taking up the amount of space or emitting the level of heat that conventional amplifiers do. No wonder Bang & Olufsen® and Audi complement each other so well.¹

¹ Bang & Olufsen® Advanced Sound System is optional on A7 Prestige models.



2013 Audi A7 Prestige shown in Dakota Gray metallic with optional 20" 10-parallel-spoke design wheels.

Get a good look. It'll be gone before you know it.

You better take it all in while you can, because from this angle the A7 won't be around for long. Its gorgeous, swooping lines culminate in a spectacular finish. Highlighted by the unmistakable look of its LED taillight technology, the last thing you'll see will surely leave a powerful impression. If you can catch a glimpse of it before it's gone, that is.

.33 - LED Taillight
Technology

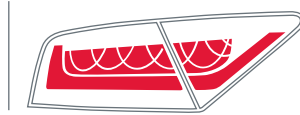

- fig. 03

Sleek and stylish, these rear light-emitting diodes are brighter and longer-lasting than conventional bulbs and illuminate faster than traditional brake lights, which can help give the driver behind you more time to respond.

Exterior Colors

Brilliant Black

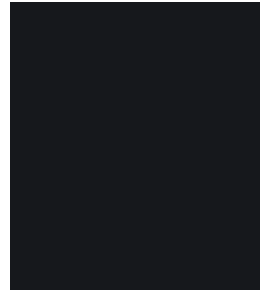

Ibis White

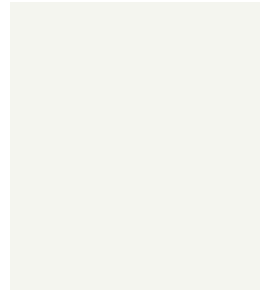

Dakota Gray metallic

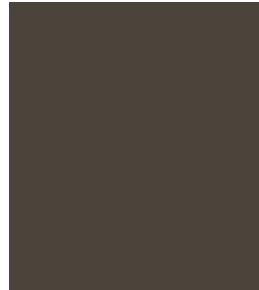

Glacier White metallic

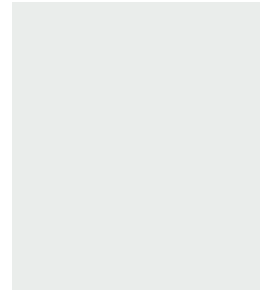

Havana Black metallic



Ice Silver metallic

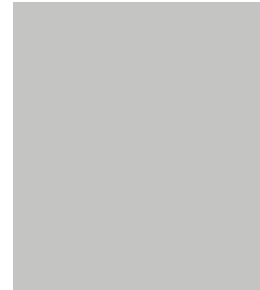

Moonlight Blue metallic



Oolong Gray metallic

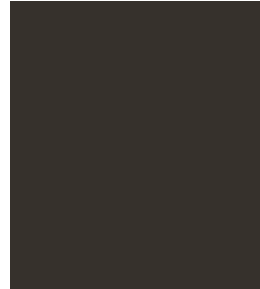

Quartz Gray metallic

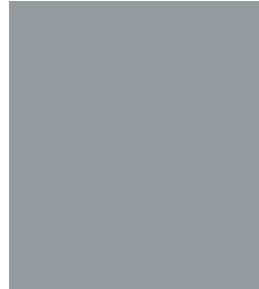

Daytona Gray pearl



Garnet Red pearl



Phantom Black pearl

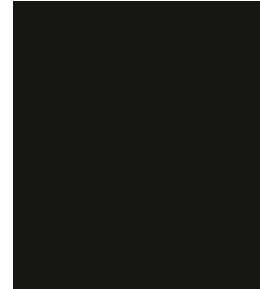

Prestige only

Interior Colors | Seat Selections



Standard seat

Black leather



Nougat Brown leather



Titanium Gray leather

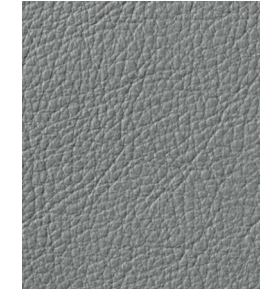

Velvet Beige leather



Comfort seat¹

Black perforated leather



Nougat Brown perforated leather

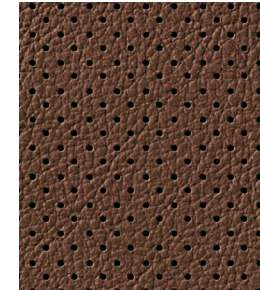

Titanium Gray perforated leather

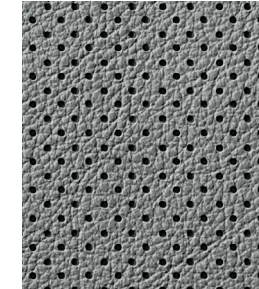

Velvet Beige perforated leather

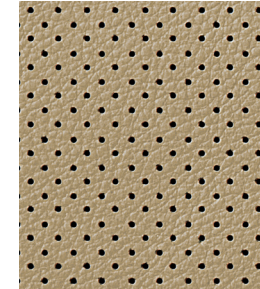

¹ Standard on Prestige models.

Decorative Inlays



Fine Grain Ash Natural Brown Wood inlay¹



Dark Brown Walnut Wood inlay¹

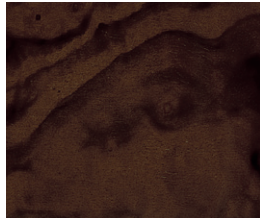

Layered Oak Wood inlay¹



Brushed Aluminum inlay¹



¹ Decorative inlay options will vary based on model and interior color combination. See your dealer for details.

Wheels

18" 7-spoke design
255/45 all-season tires



A7 Premium

19" 10-spoke design
255/40 all-season tires



A7 Premium plus and Prestige

19" 5-double-spoke design
255/40 summer performance tires²



19" Sport package

20" 10-parallel-spoke design
265/35 summer performance tires²



20" Sport package (Premium plus and Prestige)
Premium plus and Prestige (Optional)

² Tires are supplied and warranted by their manufacturer. High-performance tires are designed for optimum performance and handling in warm climates. They are not suitable for cold, snowy, or icy weather conditions. If you drive under those circumstances, you should equip your vehicle with all-season or winter tires, which offer better traction under those conditions. We suggest you use the recommended winter or all-season tire specified for your car or its equivalent. These high-performance tires also have a lower aspect ratio that aids performance and handling; however, in order to avoid tire, rim or vehicle damage, it is important that the inflation pressure is regularly checked and maintained at optimum levels. Please also remember in making your selection that, while these tires deliver responsive handling, they may ride less comfortably and make more noise than other choices. Finally, these tires may wear more quickly than other choices.

Technical Specifications

Engineering Performance	A7 3.0T
Engine type	Six-cylinder
Engine block/Cylinder head	Aluminum-alloy
Displacement (cc)/Bore and stroke (mm)	2,995/84.5 x 89
Horsepower @ rpm	310 @ 5,500
Torque (lb-ft @ rpm)	325 @ 2,900
Compression ratio	10.3:1
Valvetrain	24-valve DOHC with variable valve timing
Induction/Fuel injection	Supercharged/TFSI®
Start-stop efficiency system	■
Acceleration (0–60 mph)	5.4 seconds
Top track speed ¹	130 mph

Transmission Drivetrain	
Eight-speed Tiptronic® automatic transmission with Audi quattro® all-wheel drive	■
Gear Ratios: 1st: 4.714, 2nd: 3.143, 3rd: 2.106, 4th: 1.667, 5th: 1.285, 6th: 1.000, 7th: 0.839, 8th: 0.667, Reverse: 3.317, Final Drive: 2.848	■

Body Suspension Chassis	
Audi ultra® lightweight technology–aluminum exterior body panels and a steel frame	■
Five-link front suspension	■
Trapezoidal-link rear suspension	■
Sport suspension calibration	SP/TS
Electromechanical power steering system	■

Exterior measurements	A7 3.0T
Wheelbase (in)	114.7
Length (in)	195.6
Height (in)	55.9
Overall width with mirrors (in)	84.2
Track, front/rear (in)	64.7/64.4
Curb weight (lb)	4,167
Drag coefficient (Cw)	0.30

Interior measurements	
Head room (in), front/rear	36.9/36.6
Leg room (in), front/rear	41.3/37.0
Shoulder room (in), front/rear	57.2/55.9
Cargo volume (cu ft)	24.5
Passenger volume (cu ft)	94.3
Seating capacities	4 or 5

EPA mileage estimates Capacities	
Tiptronic® automatic transmission (mpg), city/highway/combined ²	18/28/21
Engine oil (qt)	7.2
Fuel (gal)	19.8
Recommended fuel	Premium

■ Standard
— Not applicable

CW Cold Weather package

DA Driver Assistance package

IP Innovation package

SP 19" Sport package

TS 20" Sport package

¹ Top track speed is electronically limited in the U.S. Obey all speed and traffic laws. ² EPA estimates. Your mileage will vary.

Featured Content

Safety Security	Premium	Premium plus	Prestige
Driver and front passenger dual-stage airbags, thorax side airbags and Sideguard® head curtain airbags ¹	■	■	■
Driver and front passenger knee airbags ¹	■	■	■
Rear-passenger thorax side airbags ¹	Optional	Optional	Optional
Front passenger occupant detection—for airbags	■	■	■
Safety belt reminder for driver and front passenger	■	■	■
Lower Anchors and Tethers for CHildren (LATCH) in rear seats	■	■	■
Power central locking system with safety unlock feature if airbags deploy	■	■	■
Electronic Stability Control (ESC) with traction control (ASR)	■	■	■
Anti-lock Brake System (ABS) with Electronic Brake-pressure Distribution (EBD) and brake assist	■	■	■
Tire pressure monitoring system	■	■	■
Electromechanical parking brake	■	■	■

Exterior	Premium	Premium plus	Prestige
Audi Singleframe® grille	■	■	■
Xenon plus headlights with LED daytime running light technology	■	■	—
Adaptive xenon plus headlights with LED daytime running light technology	—	—	■
Full LED headlight technology	—	—	Optional
Automatic headlights	■	■	■
LED taillight technology and rear fog lights	■	■	■
Power-adjustable, heated exterior side mirrors with memory	■	—	—
Power-adjustable, auto-dimming, heated exterior side mirrors with memory	—	■	■
Power-adjustable, power-folding, auto-dimming, heated exterior side mirrors with memory	Optional	DA/Optional	DA/IP/Optional
LED indicator light technology integrated into the exterior side mirrors	■	■	■
Heated windshield washer nozzles	■	■	■
Aluminum trim around exterior windows	■	■	■
Power tailgate open/close	■	■	■
Adaptive rear spoiler	■	■	■
Dual exhaust outlets	■	■	■
Audi S line® exterior appearance	—	—	■

■ Standard CW Cold Weather package DA Driver Assistance package IP Innovation package

SP 19" Sport package
TS 20" Sport package

Interior	Premium	Premium plus	Prestige
Three-zone automatic climate control	■	■	—
Four-zone automatic climate control	—	—	■
Four-spoke multifunction steering wheel	■	■	■
Three-spoke multifunction steering wheel with shift paddles	SP	SP/TS	SP/TS
Heated steering wheel	CW	CW	CW
Tilt and telescopic manually adjustable steering column	■	■	—
Power tilt and telescopic adjustable steering column with memory	—	—	■
Decorative interior inlays (see Decorative Inlays page for more detail)	■	■	■
Black cloth headliner	Optional	Optional	Optional
Power windows with one-touch up/down operation and pinch protection	■	■	■
Sunroof	■	■	■

Seating	Premium	Premium plus	Prestige
Leather seating surfaces (perforated on Prestige) (see Interior Colors page for more details)	■	■	■
Eight-way power front seats and four-way power lumbar adjustment for driver	■	■	—
Twelve-way power front seats, including four-way power lumbar adjustment	—	—	■
Heated front seats	■	■	■
Ventilated front seats	—	—	■
Five-seat configuration	Optional	Optional	Optional
Heated rear seats	CW	CW	CW
Folding rear seatback with pass-through	■	■	■

Infotainment Technology	Premium	Premium plus	Prestige
Audi MMI® Navigation plus with voice control system ²	—	■	■
Audi MMI® touch with handwriting-recognition technology	—	■	■
Audi connect™ with six-month trial subscription ³	—	■	■
5" driver information system	■	—	—
7" color driver information system	—	■	■

¹ Airbags are supplemental restraints only and will not deploy under all crash circumstances. Always use safety belts and seat children only in the rear, using restraint systems appropriate for their size and age. ² Audi Navigation plus depends on signals from the worldwide Global Positioning Satellite network. The vehicle's electrical system and existing wireless and satellite technologies must be available and operating properly for the system to function. The system is designed to provide you with suggested routes in locating addresses, destinations and other points of interest. Changes in street names, construction zones, traffic flow, points of interest and other road system changes are beyond the control of Audi of America, Inc. Complete detailed mapping of lanes, roads, streets, toll roads, highways, etc., is not possible, therefore you may encounter discrepancies between the mapping and your actual location. Please rely on your individual judgment in determining whether or not to follow a suggested Audi Navigation plus route. Periodically mapping updates will be available for purchase at an additional cost. Consult your dealer or call 1-800-FOR-AUDI for details. ³ See Audi connect page for important information regarding Audi connect.

Featured Content

Infotainment Technology (continued)	Premium	Premium plus	Prestige
Audi MMI® Radio plus with ten speakers and single CD player with MP3 playback capability	■	■	—
BOSE® sound system with 14 speakers, AudioPilot® noise-compensation and 630 watts	—	Optional	■
Bang & Olufsen® Advanced Sound System with 15 speakers and 1,300 watts	—	—	Optional
HD Radio™ Technology	—	■	■
SiriusXM Satellite Radio with 90-day trial subscription ¹	■	■	■
SiriusXM Traffic with four-year subscription ¹	—	■	■
Audi music interface with iPod® integration	■	■	■
BLUETOOTH® wireless technology preparation for mobile phone	■	■	■
Garage door opener (HomeLink®)	■	■	■
Keyless start	■	—	—
Audi advanced key—keyless start, stop and entry ²	—	■	■
Cruise control with coast, resume and accelerate features	■	■	■
Audi adaptive cruise control with stop & go	—	DA	DA/IP
Audi active lane assist	—	—	IP
Audi side assist	Optional	DA/Optional	DA/IP/Optional
Audi pre sense rear	Optional	DA/Optional	DA/IP/Optional
Audi pre sense plus—includes Audi pre sense rear	—	DA	DA/IP
Night vision assistant with pedestrian detection and head-up display	—	—	IP
Audi drive select	■	■	■
Parking system plus with rearview camera	—	■	■
Corner view camera system	—	—	IP
Rain/light sensor for automatic windshield wipers and headlights	■	■	■

■ Standard CW Cold Weather package DA Driver Assistance package IP Innovation package SP 19" Sport package
 — Not applicable TS 20" Sport package

¹ SiriusXM Satellite Radio and Traffic subscriptions sold separately or as a package after trial expires. SiriusXM Traffic service available in select markets. Subscriptions are governed by SiriusXM Customer Agreement (see www.siriusxm.com) and are continuous until you call SiriusXM to cancel. SiriusXM U.S. Satellite Service available only to those 18 and older in the 48 contiguous U.S.A., D.C. and Puerto Rico (with coverage limitations).
² Some Audi models are equipped with a keyless ignition feature. The details as to how the system works can vary, and Audi owners should consult their owner's literature or an authorized Audi dealer if they have further questions about the operation of this feature. Please note that Audi warns against leaving the vehicle unattended with the engine running, particularly in enclosed spaces.

An even bolder way to make an entrance.

If the A7 makes a statement, the Audi A7 Prestige with S line® exterior appearance package is an outright declaration. First off, unique front and rear bumpers give the vehicle a wider, sportier appearance. With the addition of a Platinum Gray rear diffuser, this effect becomes even more pronounced. And with flared side sills adding a muscular, lowered look, the impression all those staring people will be left with will be a lasting one.



2013 Audi A7 Prestige shown in Ice Silver metallic.

Accessories

Imagine a cherry on top of your sundae. Sweet, right? Now imagine a cherry that helps protect your A7 in the garage. Or carries your bikes for a serious weekend on the trails. Or makes heads turn as you drive by. Audi Genuine Accessories are the little extras that make your Audi even sweeter. Designed by the same visionaries

who designed your vehicle, all accessories feature a tailored fit and the expert craftsmanship you'd expect from Audi. They are also backed by the 4-year/50,000-mile Audi New Vehicle Limited Warranty or the accessory's 12-month/12,000-mile limited warranty, whichever extends longer from the accessory purchase date.¹



20" Castesia

Add an impressive finishing touch with this eye-catching design.

19" Castiza

Show off the dramatic profile and superior performance of the Castiza design on the A7.

A7 Base Carrier Bars

Attached to strong side brackets, these are the durable foundation of the Audi roof-rack system.²

Aluminum Luggage Basket

High-quality anodized-aluminum construction and a generous load area make this an excellent carrier. Side rails help prevent load shifting. Straps sold separately.^{2,3}

Aluminum Bike Rack

This locking holder fits 20- to 80-mm bike frames with both wheels on the bike and helps keep the bike upright as you secure it in place.^{2,3}

Splash Protectors

Help protect the vehicle's finish with custom-fit splash protectors. Made of crack-resistant rubber. Available in sets of two for front or rear. Not compatible with S or Prestige models.

Valve Stem Covers

These handsome covers are made of polished stainless steel with a composite center cap. Emblazoned with the iconic Audi rings.

All-weather Floor Mats

Deep-ribbed, channeled design helps protect the floor and carpeting from water, mud, sand and snow. Rubber mats come in black and feature vehicle logo. Available in sets of two for front or rear.

Load-protection Film

This custom-fit transparent film helps protect the rear bumper from scratches while loading and unloading. Product is transparent. Outline depicts coverage area.

Other accessories not shown -----

Audi Genuine Sport and Design Accessories

Your Audi vehicle features a bold, aggressive stance and strong, stunning lines. Enhance it by adding Audi Genuine Sport and Design Accessories. All are carefully scrutinized in the design and development process. So while they're striking in appearance, they've also passed rigorous quality assessments, including corrosion testing. If you're looking for a bolder appearance or a finishing touch, there is a solution designed by Audi that makes every mile more enjoyable—and more yours.

Audi Genuine Alloy Wheels

Strike the perfect balance between breathtaking design and awe-inspiring performance with Audi Genuine Alloy Wheels. Audi experts have meticulously designed these wheels especially for each Audi model. They're engineered to the highest standards and endure rigorous testing to help ensure long-term quality. Experience eye-catching style that is yours and yours alone. Nothing enhances the bold, dynamic look of your Audi vehicle faster.

Audi TravelSpace Transport Accessories

You go almost everywhere. Give your Audi the proper invitation to be part of your adventures. Never leave the necessary gear behind. Bring it with Audi TravelSpace Transport Accessories. The list includes bike racks, ski racks, a variety of watersports equipment carriers and various sizes of cargo carriers. Wherever you go, make sure almost everything fits with a variety of intelligent and innovative solutions. Accessories designed for your life—the passionate, active part.

Audi Genuine Electronics Accessories

The illuminating technology that graces each Audi vehicle provides the inspiration for Audi Genuine Electronics Accessories. Similarly, all of these accessories are impressively advanced and inspiring. Our audio options let you enhance your listening pleasure. Other accessory options help promote safer, more convenient travel. All are designed and tested to help ensure compatibility with the vehicle's electrical systems, allowing you to enjoy every aspect of Audi technology with almost all your senses. Demand the best and drive with added confidence.

Audi Guard Comfort and Protection Accessories

Protect what you love. Audi Guard Comfort and Protection Accessories offer functional, practical items that help keep your Audi in pristine condition. Choose from such useful items as trunk liners that help make clean-up quick and easy or an easy-to-use storage cover that helps shield the vehicle. Use them all to help reduce wear and tear and keep the vehicle looking like new—inside and out. All are engineered to stringent Audi standards, so you can be assured of their quality and durability.

¹ See dealer for details. ² All roof-rack system attachments require the base carrier bars. All attachments sold separately. ³ Recreational equipment, sporting equipment and luggage not included.