



allroad

Audi allroad®

Audi  
Truth in Engineering



# If it was this easy, it wouldn't be an Audi.

Obsession



IMAGINE DEVOTING YOUR LIFE TO BUILDING YOUR MODEL.

When you were a kid, you probably felt quite proud when you completed a model kit. We understand. At Audi, it takes countless hours for a single Audi to go from idea to design to roadworthy, and that's time we are very proud to devote. Our obsession for detail,

commitment to premium fit and finish and passion for unparalleled engineering go into every model. It's the kind of discipline that the word "painstaking" was invented to describe. Not to say it's a chore—no, assembling an Audi is a labor of love, and it shows every time you sit in one, engage the ignition and nudge the accelerator. Creating an Audi isn't easy, but the results help define what Audi means to the people who drive one.

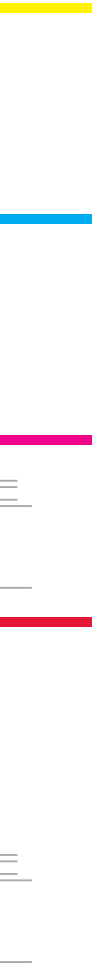
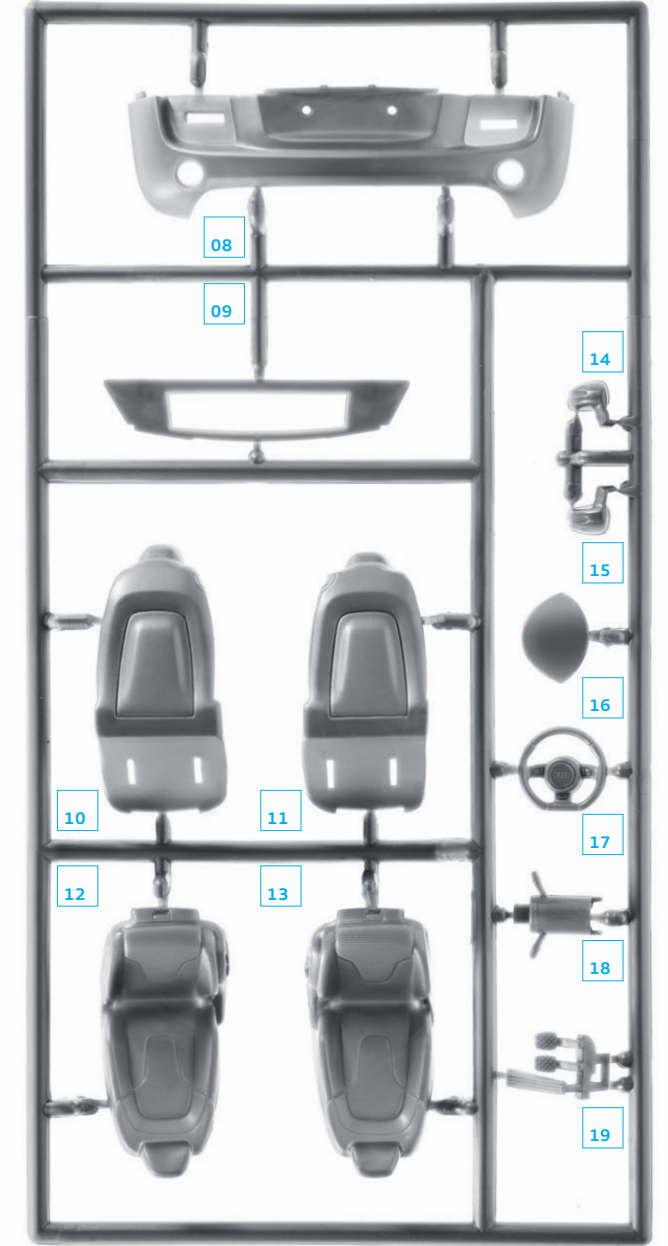
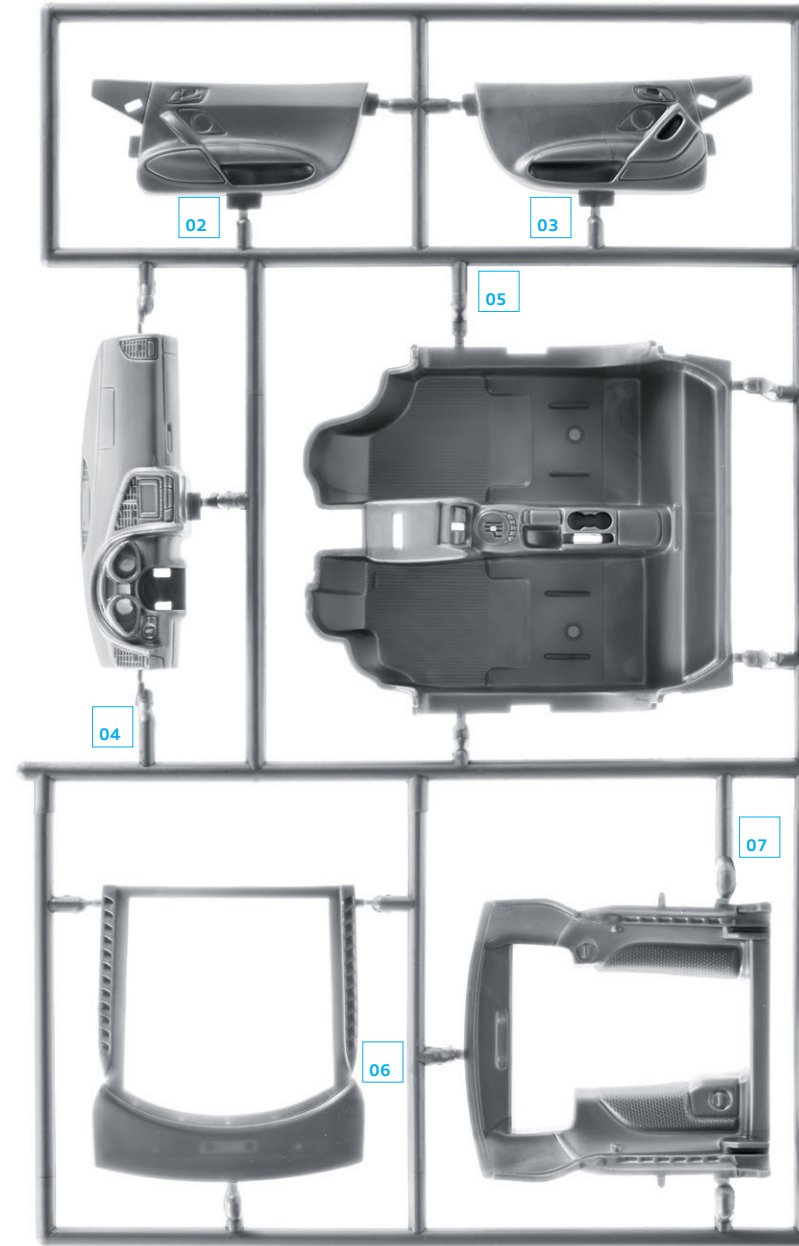





# The door of perception.

OUR REPUTATION HINGES ON THE QUALITY OF THINGS YOU DON'T SEE.

It's said that, when one door closes, another one opens. It sounds as if whoever said it spent some time at an Audi research and development facility. After all, while you'll open and close the door on your Audi thousands of times without thinking about it, we've obsessed about it for you, in detail. Not just about the reliability of it opening and

closing, but on the proper weight that will make it more pleasing to close. How the locks should click when they are engaged. The optimal acoustic placement for the speaker port. There are the hinges too, of course. And the door itself, which we designed to take the brunt of side-impact collisions, and several dozen other safety considerations (to say nothing of the countless other components, processors, sensors, window features and the inner workings most people will never see). Our doors are more than a symbol of welcoming you into your vehicle, they are products of Audi engineering, and the very perception of Audi hinges on them as much as our hinges help support the door.

## ACOUSTIC ENHANCEMENTS

We use soft mounts on our window regulator and a sound-absorbing backing within the door cavity itself to make the cabin even quieter.

## INNOVATIVE DESIGN

By using fully pressed aluminum doors in the Audi A6, the door structures were reduced by an astonishing 44 lb compared to the previous model.

## SPEAKER PLACEMENT

Optimal speaker placement helps deliver the most extraordinary sound you can find in the automotive space.

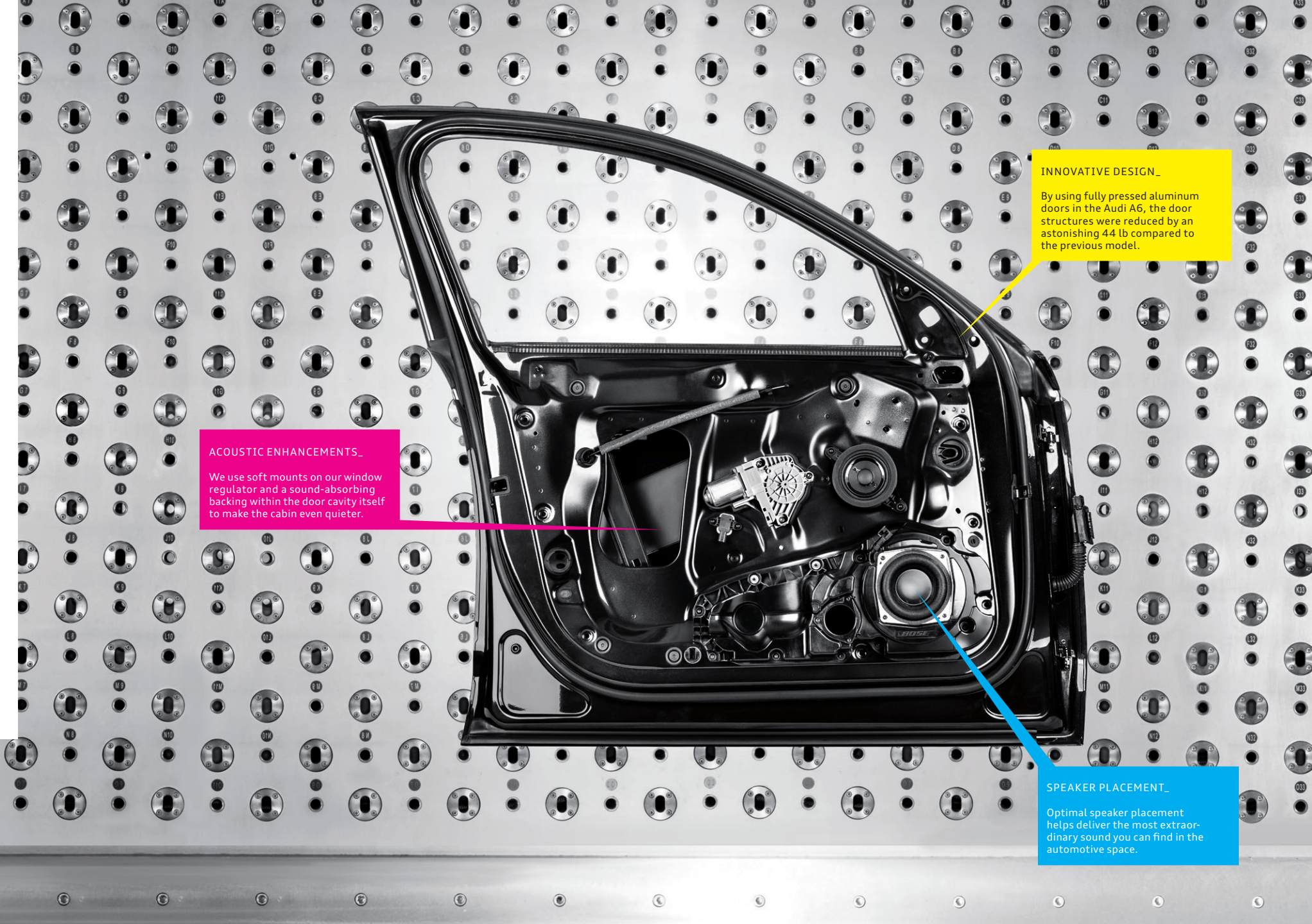



# When we think of a good idea, it sticks.



SURFACES

WET  
DRY  
SLIPPERY  
UNEVEN

Torque is distributed to all four wheels in varying amounts.

Torque vectoring

By independently braking the inside cornering wheels, torque is then transferred to the outside cornering wheels. This intelligent application of power, known as torque vectoring, is available on select quattro models and helps promote neutral handling by calculating the driver's steering input and desired level of acceleration.

Sport differential

To help ensure high cornering agility, the available sport differential uses torque vectoring, and then adds to that by mechanically applying additional torque to the outside rear cornering wheel. Through an electrohydraulic multiplate clutch pack and gear-set, the outside rear cornering wheel speed is increased by as much as 10%.

CORNERS

CURVES  
MOUNTAINS  
OBSTACLES  
HANDLING  
UNEXPECTED

Impressive stability, more assured road-holding, enhanced agility and improved steering precision.

TRACTION

ACCELERATION  
TOWING  
SNOW  
CRUISING  
GRAVEL

quattro directs the amount of torque required to suit the job at hand.

quattro® HAS MAINTAINED ITS GRIP ON OUR THINKING AND THE ROADS WE TRAVEL.

For more than 30 years, Audi has been focused on quattro® all-wheel drive. During that time, it has evolved into an overarching idea of performance, a technological system of ratios, power delivery and driving dynamics working seamlessly together, orchestrated through the drivetrain, providing power where and when it is needed most. In

many ways, this has been a three-decade drive, from the Alps to the autobahn—and points beyond. You've seen quattro® capabilities in the way we dominated the World Rally Championship for years, in the grip you have in inclement weather, and in the variable power distribution you enjoy in good conditions.<sup>1</sup> For more than 30 years, and with over five million quattro® systems on the road, we have continued to refine the technology, developing an available rear sport differential to help maximize performance and available torque vectoring to assist with cornering traction while helping to improve handling. We've boldly stuck to what worked while the world was trying to catch up, and we built on it.

<sup>1</sup> When driving during cold, rainy, snowy or icy weather conditions, ensure that your vehicle is equipped with appropriate all-season or winter tires. Even with appropriate tires, you must always drive in a manner appropriate for the weather, visibility and road conditions.



# The obsessive engineering of maximum fitness.

ENGINEERING POWER IS MORE THAN JUST ADDING MUSCLE.

There is an art to fitness. Yes, there are some who go for the massive, sculptured muscle look. But there is something more compelling out there for those with more refined tastes. The kind of sculpted efficiency found in Audi engines elevates the driving experience through smaller, finely tuned forced-

induction engines. For the drive to feel lean and precise, we've shaved off unwanted pounds. Sure, large numbers might distract some, but a champion impresses with its grace, power and athletic balance—captured in the right suspension setting, or a torque-vectoring corner. Audi engineers taste the shape of power that celebrates a true dedication to craft. It means strength that pulses at the moment of acceleration, provides a true, quick response as you change lanes, and turns the most routine cloverleaf into a joyful application of performance handling.<sup>1</sup> This is the art of maximum fitness, to the point where others just feel a little flabby.

## FSI<sup>®</sup>

The FSI direct injection fuel system directly injects fuel into the combustion chambers at precisely managed times and depths. What that means for drivers is that a fully homogenized intake charge helps increase power while also reducing fuel consumption and emissions, making efficiency more powerful.<sup>2</sup>

## TFSI<sup>®</sup>

At Audi, TFSI represents a combination of two of the brand's core areas of expertise—direct injection and forced induction. By adding turbocharging or supercharging to FSI direct injection, the pressurized intake charge is cooled by directly injected fuel, thus achieving efficiency and performance combined with higher compression ratios—previously only attainable by naturally aspirated engines.<sup>2</sup>

## TDI<sup>®</sup>

A turbocharged, fuel-sipping variant, our TDI<sup>®</sup> clean diesel engines deliver uncompromising Audi performance with bold efficiency.<sup>1</sup> Yes, it gets better mileage per gallon than comparable gasoline engines,<sup>2</sup> but it also produces more low-end torque, which is best expressed in the elasticity you have when passing in the 30- to 60-mph range.

<sup>1</sup> Always obey all speed and traffic laws.  
<sup>2</sup> See [www.fueleconomy.gov](http://www.fueleconomy.gov) for EPA estimates and emissions data. Your mileage and emissions will vary and depend on several factors, including your driving habits and vehicle condition.



### ELEPHANT SKULL\_

How nature solved the apparent conundrum of an elephant's skull didn't escape the notice of Heinrich Timm, the longtime lead engineer for Audi. The weight of the tusks and the general size of an elephant's head would seem to make it impossible for the animal to actually be able to carry it. But the design genius behind the elephant's skull is to make it lightweight yet sturdy. Its predominantly hollow design is buffered by thin, connective bone walls, which act as strong, weight-bearing cells. Audi designers used that idea when building our aluminum and steel structures. Reducing weight, yet enabling strength.



ultra

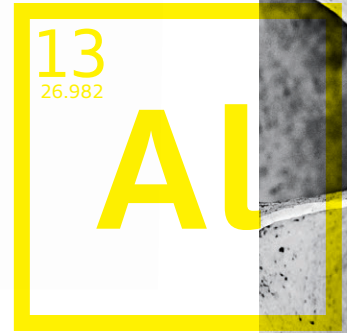
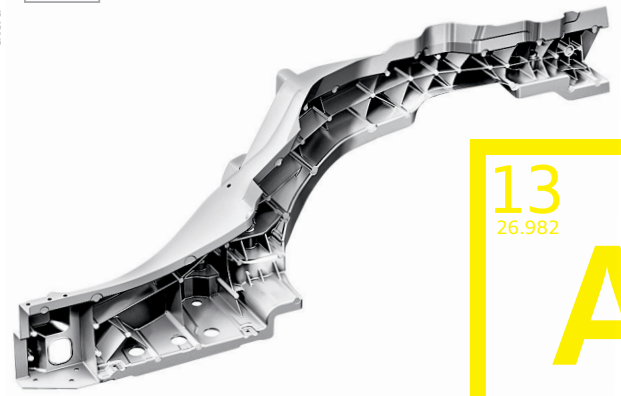

### ALUMINUM\_

Our large aluminum castings are a telling example of ultra lightweight technology. Primarily used in high-stress areas, these castings achieve exceptional rigidity while also allowing for freedom of design, all while remaining extremely lightweight!

# How studying elephant skulls makes for superior handling.

THE ELEGANT STRUCTURE OF NATURE BECOMES A BLUEPRINT OF EFFICIENCY.

It seems strange to say that, while we build strong, complex and high-performing machines, we're naturalists at heart. Then again, it might not be that unusual, seeing how nature itself builds strong, complex and high-performing machines as well. When we developed the thinking behind our ultra® lightweight technology initiative,

we knew that nature would serve as an inspiration to greater structural efficiency. Take the structure of the elephant skull pictured here. It has to be lightweight, yet capable of carrying a heavy load. It's porous, but its structure is such that it enhances its stability and strength. We do the same, for example, with aluminum. Positioned one way, aluminum materials can be flexible. Positioned another, they are strong and rigid, and help give better support. We also looked to bamboo, which is strong at the conjoined areas (nodes), and flexible along its stem. Our designs allow for both rigidity and flexibility where each is most needed, and for efficiency overall. As we continue to develop strategies to improve the performance aspects and efficiency of our vehicles, we don't shy away from the world around us? We boldly engage it even closer still.

1. Features and technologies listed are not available on all models. 2. See [www.fueleconomy.gov](http://www.fueleconomy.gov) for EPA estimates and emissions data. Your mileage and emissions will vary and depend on several factors, including your driving habits and vehicle condition.



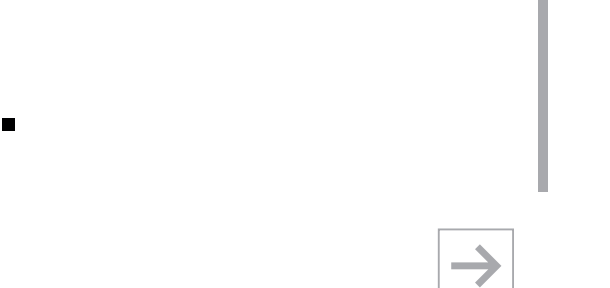
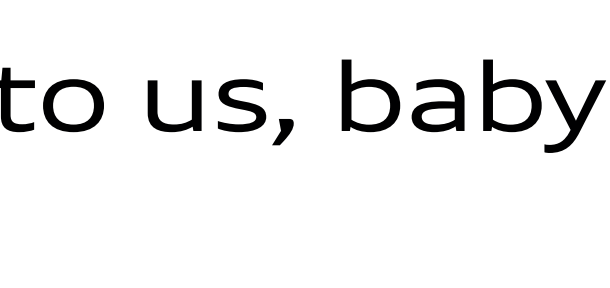

# Just talk to us, baby.



AUDI CONNECT® REALLY GETS WHAT YOU ARE SAYING.

Share what's on your mind. Looking for a great Chinese food place? We'll help you get there. Thinking about a rest stop? We'll locate the nearest gas station for you, and even give you the price of their fuel. In fact, in your Audi, just say the word, and we'll help you find almost anything, even your home phone number. With available Audi connect with Google

Voice™ command capabilities, we've developed a way to let you articulate your desires, even if that's just finding the closest burger stand or the best hotel.<sup>1</sup> MMI® navigation plus with Audi connect helps integrate networking capabilities on the go, along with Google Earth™ with 3D satellite imagery, to help you avoid traffic (and possibly saying things you might regret)<sup>2</sup> Audi connect also provides fast data transfer speeds and Wi-Fi® connectivity for up to eight passenger devices to help you stay informed. It offers a full suite of services and interactivity, and, yes, even the closest Szechuan restaurant, which you can find by using its Google™ Local Search capabilities. Best of all, you don't even have to say "Thank you," even if we appreciate it when you do.

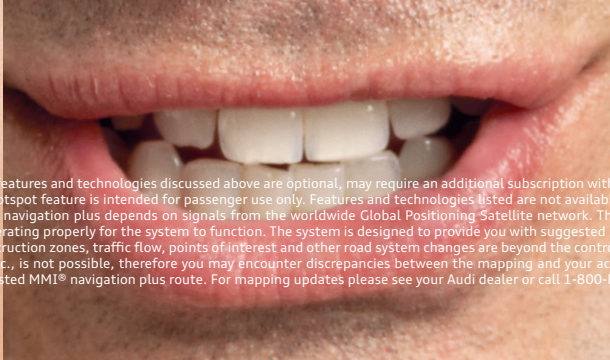
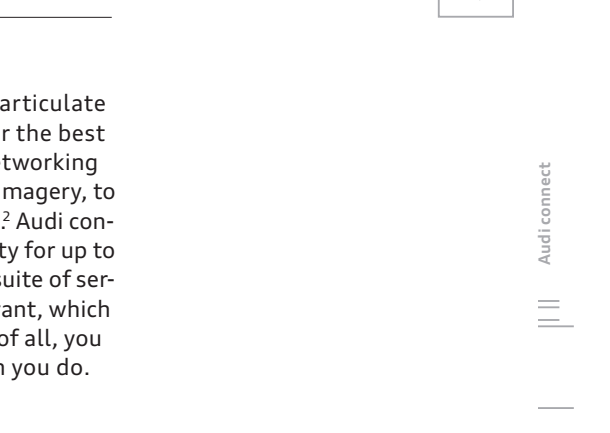
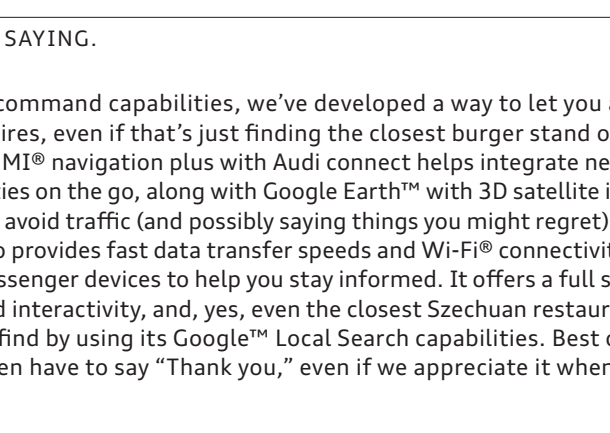
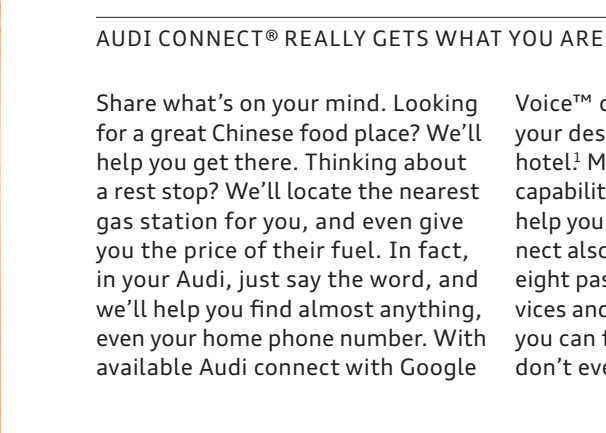

1. Always pay careful attention to the road, and do not drive while distracted. The features and technologies discussed above are optional, may require an additional subscription with separate terms and conditions, and should be used only when it is safe and appropriate. The Wi-Fi® hotspot feature is intended for passenger use only. Features and technologies listed are not available on all models. The voice control feature is not available on Cabriolet or Roadstar models. 2. MMI® navigation plus depends on signals from the worldwide Global Positioning Satellite network. The vehicle's electrical system and existing wireless and satellite technologies must be available and operating properly for the system to function. The system is designed to provide you with suggested routes in locating addresses, destinations and other points of interest. Changes in street names, construction zones, traffic flow, points of interest and other road system changes are beyond the control of Audi of America, Inc. Complete detailed mapping of lanes, roads, streets, toll roads, highways, etc., is not possible, therefore you may encounter discrepancies between the mapping and your actual location. Please rely on your individual judgment in determining whether or not to follow a suggested MMI® navigation plus route. For mapping updates please see your Audi dealer or call 1-800-FOR-AUDI for details. Features and technologies listed are not available on all models.





Hey, bright eyes.



DESIGNING A WINDOW TO OUR SOUL.

Even in the dark, you know when you're staring at an Audi. In fact, it might just be love at first sight. That's because, instead of cursing the darkness, we celebrate the light. Available full LED headlights stand out from the rest: their color inten-

sity is engineered to be reminiscent of daylight. But while we illuminate the night, we don't forget the day—so we made our LED daytime running lights to look even more dramatic. Now featuring a sleek diode design that gives us the freedom to elegantly reshape our signature style, Audi LED lighting is once again ours. It is an efficient, beautiful way to help you see and be seen from dusk to dawn and back again. Look deep into our eyes, and you might just see the soul of a company.





# How we know exactly what you feel.

CLEAN, BEAUTIFUL DESIGN COMES FROM DEDICATED CRAFTSMEN UNAFRAID OF GETTING THEIR HANDS DIRTY.

Our hands give you shade and sanctuary. Our hands give you comfort and control. You might not sense our hands nearby, but our hands know exactly what you feel. That's because we've been there. After all, our hands crafted a customized world that's dedicated to control, comfort and entertainment. We're talking,

of course, about the cabin of your Audi vehicle. Optimized luxury, designed by committed craftsmen who had you in mind when they chose the leather seating surfaces, created the contoured seats or provided the refinement of ergonomic design and an available more intuitive MMI® system. There are small touches that help simplify the overall design, and there are large statements to help you feel at ease. It is your Audi interior, shaped by the kind of people who know you want to experience luxury firsthand.





As you can see, our design will help channel water away from the mirror, allowing you a clearer view of what's behind you.



The molding on the inner A-pillar helps direct water away from the area where the windshield and A-pillar meet. Once the water is there, aerodynamic forces take over and funnel the water up and out of the windshield area rather than back and across the side windows.

## You have to weather adversity to know things like this.

WHAT YOU DON'T KNOW MIGHT HELP YOU.

Think of it this way—if it rains, would you notice a dry side view mirror? Maybe not, but compared to one with beads of rain on it and distorted reflections, you would. It's a little thing, perhaps, but these little things are part of our deep obsession with crafting a premium driving experience.

We design our exterior side mirrors with small sills to channel water along their upper edge, helping leave your view unobstructed. We also design our windshield moldings with channels that allow rain water to efficiently run off instead of returning to the windshield wiper path. These are small touches, thought of by engineers and crafted by designers who don't necessarily call attention to their skills. Instead, these details reflect a commitment to quality that you might never notice—until a moment of bad weather or adversity, when you might. But don't worry. We don't mind if you don't notice us, now and then.





# Either think about the future, or make history.



e-tron

# e-tron®



SUPREMELY PRACTICAL LUXURY WITH A SUNNY KIND OF ENERGY.

Talking about a better future is easy. After all, how can you be held accountable for something that never arrives? But if you really want to affect it, to make history, you have to do more than talk. Enter e-tron®. It's not the first plug-in electric hybrid to the market, but we are making it the most forward-thinking Audi ever produced. For example, we will be including a

level 2 charger with our A3 Sportback e-tron PHEV for owners who want to drive on electricity as much as possible. We also plan to offer unique sustainable energy offerings like an available solar powered connection to your charger. It's not just practical, it's premium too, in style, in performance and in fit and finish, like any other Audi vehicle. The A3 e-tron will be able to take on the average daily commute on electric-only before the efficient 1.4 TFSI® gas engine is needed.<sup>1</sup> But more than that, it will be Audi making smart technology smarter, with innovative kinetic-energy-harnessing when you brake, and better performing than what came before it. With the Audi e-tron vehicles, we're saying the future is now.

<sup>1</sup> Preliminary manufacturer's estimates.

Pre-production vehicle shown.





# The little things that add up

01 Audi connect  
Our Google™ powered information system.<sup>1</sup>

02 Audi Care  
Available convenient service option.

03 MMI updates  
MMI navigation and other software updates.<sup>1</sup>

04 SiriusXM® Satellite Radio  
Endlessly diverse music channels with a complimentary trial offer.<sup>1</sup>

05 Audi exclusive  
Available customizable exterior and interior color and material options.

SENSE OF HUMOR

RESOURCEFUL

ROMANTIC

SENSE OF STYLE

GENEROUS

LOVING



# to a long-term love.

MOVING FROM LUST TO APPRECIATION TAKES A DEEPER UNDERSTANDING.

When you are attracted to something, the effects are immediate, the domination, total. For a relationship to last, though, it must move beyond that passionate initial phase. It's what comes next that turns a bright flame into an eternal torch. That's why Audi doesn't simply design premium vehicles for the

short-term, but offers an entire experience that we hope lasts a lifetime. Do you want to customize your Audi? We offer Audi exclusive materials and colors. Do you want care-free service options? Audi Care is available. MMI® updates, trial offers for Audi connect®, a full suite of available Audi driver assistance technologies—these might not be the reasons why you fell in love with an Audi, but they are, perhaps, the things that help keep the heart fires stoked.<sup>1</sup>

1 Optional features and technologies listed are not available on all models. See Infotainment/Technology section of the Featured Content page for important information regarding MMI® navigation plus and required SiriusXM® subscriptions.



UPHILL, IN THE SNOW,  
YOU'LL FIND THE TRUTH. THE  
**allroad**<sup>®</sup> IS IN ITS ELEMENT AS  
WELL AS IN STYLE, ENGINEERING  
EMOTION AS YOU LAY DOWN  
FRESH TRACKS ON THE  
BLANK CANVAS.

**Inspirations that build an icon.**

The alchemy needed to build an automotive icon is elusive. Sure, it's found, partly, on an assembly line, with committed artisans taking pride in every stitch they oversee. It's also on a drafting board, sketched by visionaries looking to further expand what we look for in automotive design lines. But it's also in the countless inspirations, ones little and large, that not only capture a bold thought or striking idea, but execute them. Examples of these can be found in the foundational stories we tell about our company and our vehicles. These stories show how an abstract idea can turn into a powerful, sculpted machine, and then how that machine can help forge an iconic reputation for a brand. Out of the inspirations we find in engineering, art and the large world of ideas, we have created a fearless, iconic company of substance and luxury: Audi.





### *Enlighten*

A new light on illumination just happened to be a design boon.

## The luxury of adventure is wide open.

There's something to be said for acting on an impulse. When the itch for adventure hits, you don't waste any time—you just pack up your allroad® and go. Of course, with so many recreational opportunities afforded by the allroad, it doesn't take an advanced degree in mathematics to figure out that acting on every impulse could mean a very busy schedule. Luckily for you, you'll have the benefits of surefooted quattro® all-wheel drive and a potent 2.0-liter TFSI® engine at your beck and call. All while the stylish and iconic LED daytime running lights provide your allroad with an unmistakable look. And just because you may plan on roughing it when you reach your destination doesn't mean you and your passengers can't indulge in a little opulence on the way. So no matter what activity comes calling next, you can be confident that the allroad will let you answer it as never before.<sup>1</sup>

<sup>1</sup> When driving during cold, rainy, snowy or icy weather conditions, ensure that your vehicle is equipped with appropriate all-season or winter tires. Even with appropriate tires, you must always drive in a manner appropriate for the weather, visibility and road conditions. <sup>2</sup> Always obey all speed and traffic laws.



Dramatization<sup>1,2</sup>





### *Design*

We do not follow design trends. We set them.

## Exceptional beauty blazes its own trail.

It may be its muscular silhouette that first captures your imagination, or maybe it's the way its increased ride height and widened track tell a story of adventure off the beaten path. Whatever it is, you know it didn't arrive here by following others. That's why it's possible to stare at the allroad® for hours and still not pinpoint its most alluring feature. So let us offer some insight. Something we call the Tornado line, a characteristic crease that lies below the window line, draws your eye along a flowing path from front to rear. This line, combined with the fender cladding and robust aluminum roof rails, adds to its magnetic appeal. And while it may be difficult to pin down, its beauty is a product of taking its own path.

### **Electronic Stability Control with Offroad mode**

Detecting loss of traction almost immediately, ESC helps you stay pointed in your intended direction by automatically adjusting the throttle and brakes. And when activated, the Offroad mode can sense changes in terrain, and varies ESC assistance to help optimize control.







## A pioneer in plush expeditions.

Traditionally, one would never equate a trek into the wilderness to a relaxing day at the spa. Then came the allroad®, where you'll be hard pressed to tell the difference between becoming one with nature and immersing oneself in exquisite luxury. Just imagine settling in on the supple, leather-appointed seating surfaces and taking hold of the available three-spoke multifunction steering wheel. From this comfortable position, you'll notice how the simple, intuitive controls are all within an easy arm's reach, and the available Fine Grain Ash Natural Brown Wood decorative inlays establish a serene, Zen-like atmosphere.

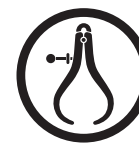

### *Craftsmanship*

We've ensured that every stitch represents the detail that we put into every aspect of an Audi.



### *Cavernous interior*

With the convenience of a power tailgate and up to 50.5 cu ft of cargo capacity when the split folding 60/40 rear seatbacks are down, the question of bringing more luggage or more toys has been answered. Bring more of both!<sup>1</sup>

<sup>1</sup> All cargo should be properly secured before driving the vehicle. See your owner's manual for details.



## A gripping story of twists and turns.

The luxurious allroad® was designed with unruly roads in mind. That means, luxury aside, those gravel-strewn switchbacks and steep, graded highways are natural terrain for the quattro® all-wheel drive system. The quattro® system is designed to help provide maximum grip and optimized power delivery for practically all road conditions. So while your commute may not be as thrilling as a trip to the summit, you can be confident in the balance and enhanced performance quattro® offers day-in and day-out, while giving you no good excuse for taking a snow day.<sup>1</sup>

# quattro

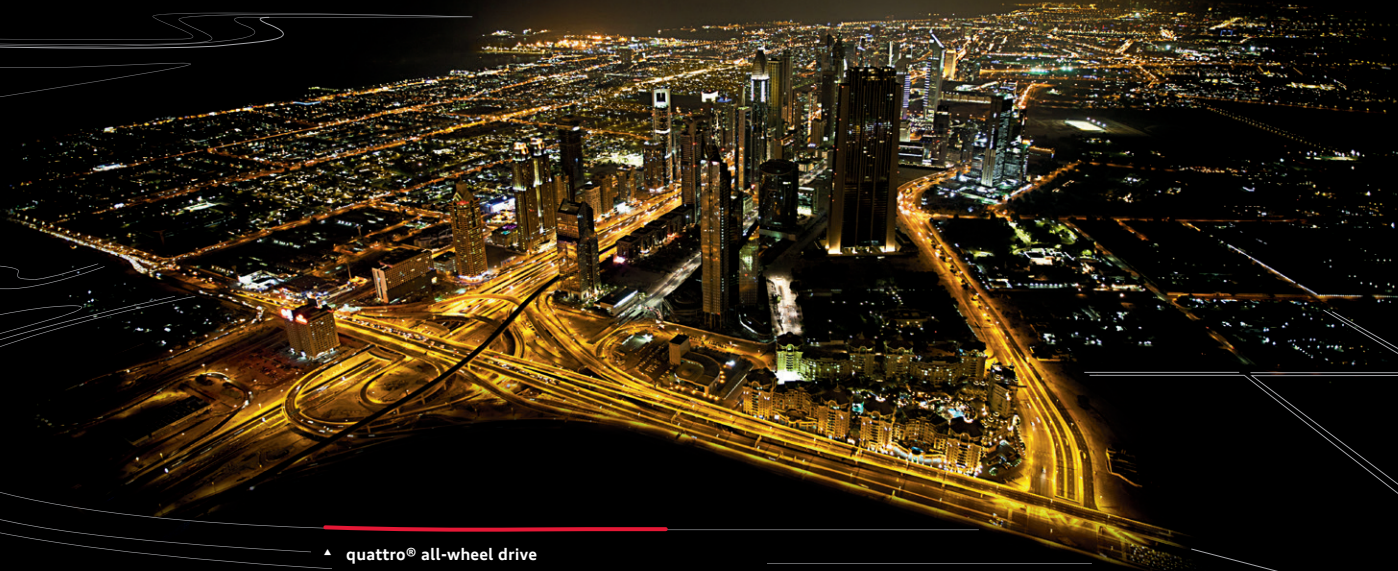

### ▲ quattro® all-wheel drive

With quattro®, the allroad can “read” the road, sensing changes in the surface beneath the wheels and adjusting their grip accordingly. So when driving conditions become more demanding, quattro® adapts to deliver precisely distributed power to where it's needed to handle the change in the terrain.

### ◀ Torque vectoring

It's a handling feature so quick that it seems to respond to your impulses instead of your steering input. An evolution of cross-axle lock, this system works within quattro®, utilizing ESC and ABS to help sense traction loss from the inside cornering tire.

### ◀ All-around confidence

Just like life, the road can throw you a curve. So throw one right back with the superior grip and control of quattro®. It helps provide the legendary performance and confidence you would expect from Audi, no matter if you're commuting in the city or crisscrossing the country. This is advanced engineering you can live with.

### ▼ Seasonal stability

There is a reason quattro® all-wheel drive is a friend in foul weather.<sup>1</sup> Under normal driving conditions, the center differential splits torque at a ratio of 40:60, front to rear, but as conditions change and become more challenging, the ratio is optimized to help maximize grip.

<sup>1</sup> When driving during cold, rainy, snowy or icy weather conditions, ensure that your vehicle is equipped with appropriate all-season or winter tires. Even with appropriate tires, you must always drive in a manner appropriate for the weather, visibility and road conditions.





## Never be accused of being underprepared.

We don't just make beautiful cars. We make them with purpose. And when you consider the ultimate purpose of the allroad®, it should come as no surprise that it's equipped with rugged features that even the most hardened adventurer can appreciate. But not every day will be spent exploring long-forgotten roads. That's why these features are meant to be just as striking in an urban landscape as they are useful on an extended camping trip.



### Ride height

Obstacles to your journey can be overcome easily with the increased ride height. With over seven inches of ground clearance, there's more than enough to help get you out there and back.



### Cladding

Just in case anyone was unsure about this vehicle's capability, the allroad features robust exterior cladding, making its intentions clear. And with an available full-paint finish, its refinement is just as apparent.



### Specialized tires

With an increase in tire sidewall height, the allroad has the perfect combination of useful ground clearance and impressive, all-terrain capability.



### Underbody protection

Stainless steel underbody protection not only helps serve as a barrier between your allroad and errant rocks, but adds to its timeless, artistic beauty.



### Roof rails

With the standard raised aluminum roof rails, the possibilities for multiple activities open up. Whether your trip calls for a ski carrier, a bike carrier or a luggage carrier, there's an attachment for it.<sup>1</sup>

<sup>1</sup> All roof-rack system attachments require the base carrier bars. All attachments sold separately.





A

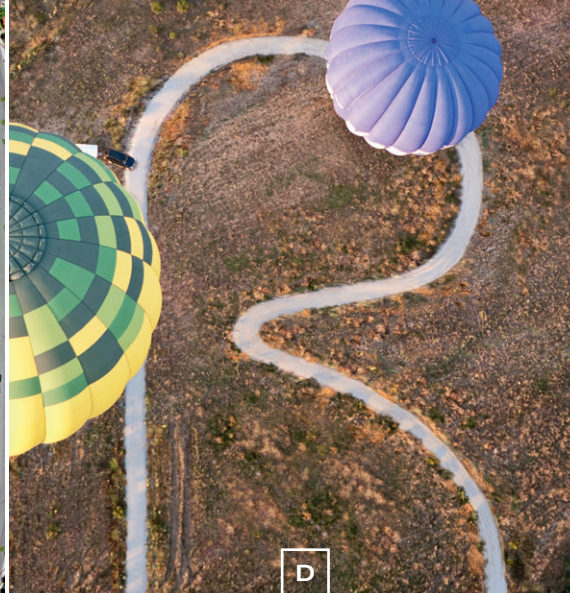

D



C

C



C

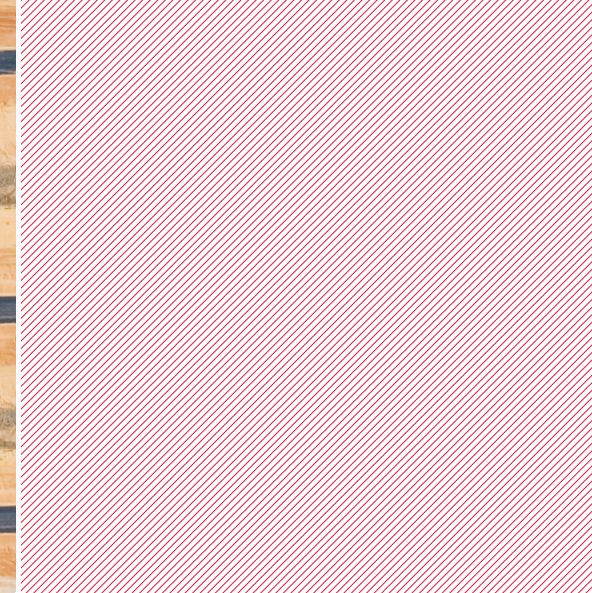

C

**Comfort mode**

Perfect for those long highway stretches, this setting adds optimized steering and a closer shift pattern to help provide a more relaxed drive.

D

**Dynamic mode**

Tighter steering and a more responsive throttle give this setting an aggressive feel and focused performance.

A

**Auto mode**

The best of both worlds, dialed to automatically adjust settings for a seamless combination of comfort and responsiveness based on your driving style and road conditions.

I

**Individual mode**

Take the turn your way—this mode allows you to adjust the steering, throttle and transmission upshifts to your style.

At Audi, we believe you should be the ultimate master of your road-going domain. That's why we created the available Audi drive select system. It gives you the ability to adjust the vehicle's steering, throttle response and transmission shift characteristics with the utmost of ease. And with four modes to choose from, when almost any kind of road comes into question, Audi drive select will let you answer.

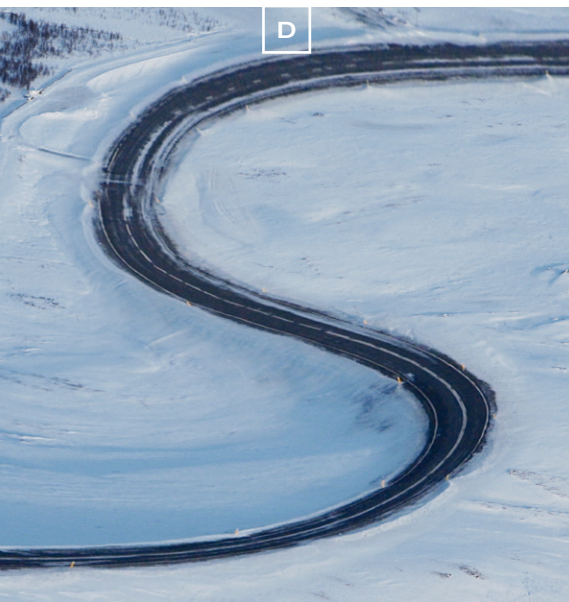

D

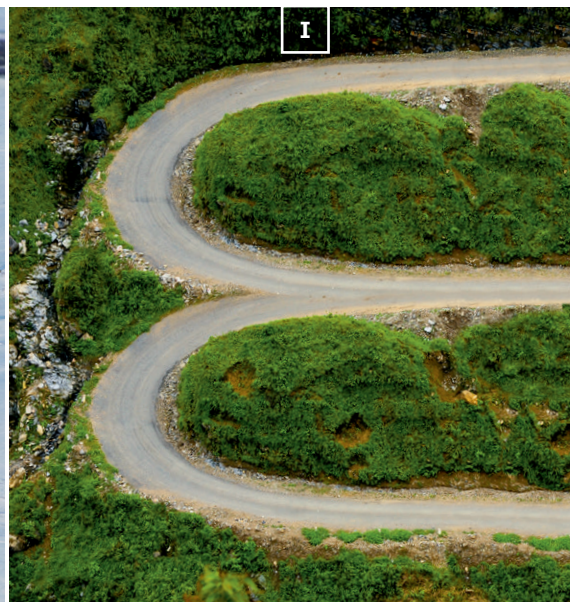

I



C

I



D

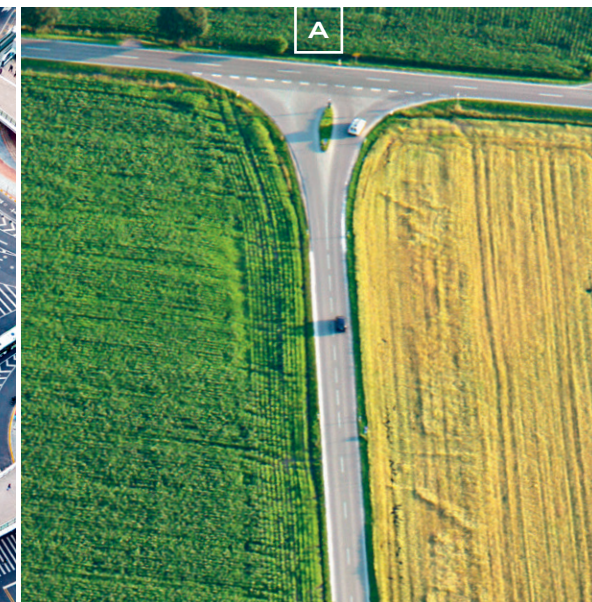

A



## Under pressure over efficiency.

There is an old school of thought in the automotive world that bigger is better. More horsepower, greater displacement—these were once the hallmark of the industry. Audi, on the other hand, progressed past this antiquated notion of engine design and adopted a system that refines the driving experience. By utilizing a turbocharger, the powerful 2.0-liter engine delivers a broad torque curve and impressive off-the-line acceleration. And since more responsive vehicles breed better performance, the result is an exhilarating driving experience at every turn.

### 2.0 TFSI® four-cylinder

This 2.0-liter turbocharged DOHC engine produces 220 horsepower and 258 lb-ft of torque, and combines the valvelift system, FSI® direct injection and turbocharging for great power and overall performance.

air out to intercooler  
↑ ↑ ↑ ↑ ↑ ↑ ↑ ↑

220 horsepower  
258 lb-ft of torque  
maximum boost pressure: up to 17.4 psi

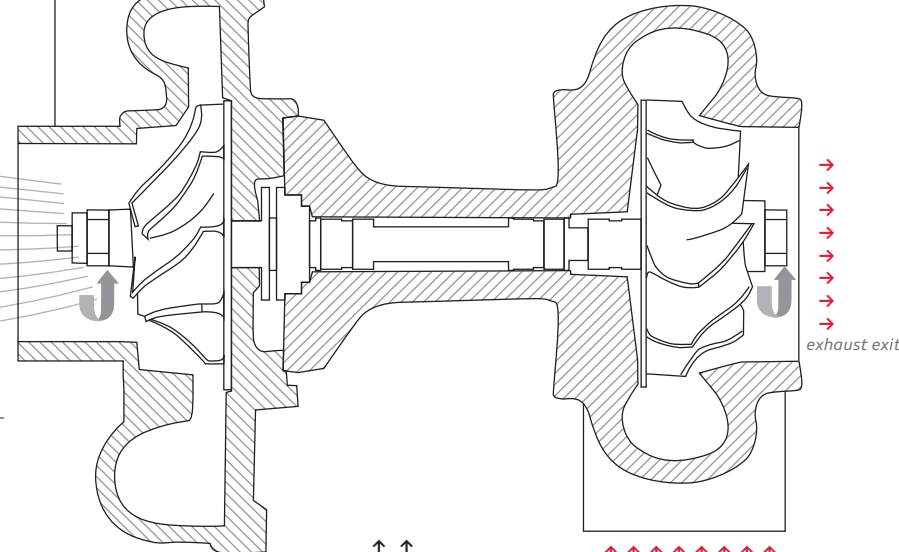

↑ ↑

Exhaust gas intake

Exhaust from the engine spins the turbine that is connected by a shaft to a compressor that pressurizes air. The compressor forces this pressurized air into the cylinders at boosted pressures up to 17.4 psi, thus producing more power from a smaller displacement engine.

↑ ↑ ↑ ↑ ↑ ↑ ↑ ↑  
exhaust in

exhaust exit

### Eight-speed Tiptronic® automatic transmission

As the perfect compromise between a dedicated manual and an automatic gearbox, the eight-speed Tiptronic® automatic transmission in the allroad offers eight optimized, carefully chosen gear ratios. Selected automatically or via its console-mounted shifter or available shift paddles on the steering wheel, precise shifts are delivered without sacrificing the smooth action of the Tiptronic® automatic. A high final drive ratio allows optimization of lower gears, yet the transmission's upper range emphasizes cruising at highway speeds.

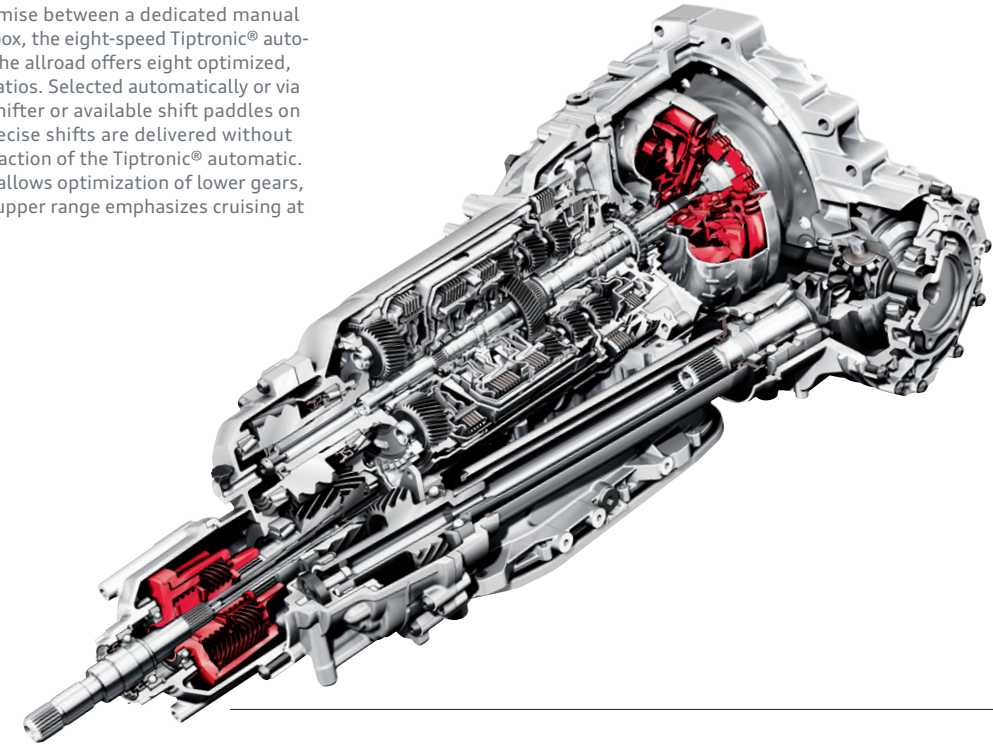

gear	ratio
1ST	4.714:1
2ND	3.143:1
3RD	2.106:1
4TH	1.667:1
5TH	1.285:1
6TH	1.000:1
7TH	0.839:1
8TH	0.667:1



### Performance

The adage “good things come in small packages” has never been more true.

### Induction-technology turbocharger

Compressing the airflow to the engine allows more air into the cylinder and, ultimately, more power from each combustion cycle, helping to improve the engine's power-to-displacement ratio.

## Driving to the tune you choose.

The allroad® offers an eight-speed Tiptronic® automatic transmission that precisely transmits the power produced by the 2.0-liter TFSI engine. With its wide gear ratios for smooth shifting, it doesn't matter which gear you're in, you can count on seamless power delivery. Available steering wheel-mounted shift paddles let you shift up or down with minimal effort, while giving you the control that performance drivers crave. A shift has been made in your favor. What you do with it is your choice.



## A little insight into the things you cannot see.

With a suite of available driver assistance options, we strive to constantly up the ante on driver convenience. Available Audi side assist helps inform you of other vehicles in the lanes next to you, while available Audi adaptive cruise control helps monitor the distance between you and the vehicle ahead, and adjusts your speed appropriately to help keep you moving smoothly. There are also the simple things, like the available parking system plus, which adds a rear view camera and rear acoustic parking sensors to help ease you into that spot. It's another testament to the effort that Audi puts into helping ensure that you're not the only one keeping an eye on the road.



### Driver Assistance

We're solving problems before you even know you have them.



### Audi adaptive cruise control

Everyone has their own comfort zone. The available Audi adaptive cruise control helps maintain a driver-selected distance from the vehicle in front by using a special long-range radar sensor. The system constantly measures the space between your vehicle and the vehicle ahead and helps manage it by automatically adjusting your speed. Once the road ahead is clear, the vehicle effortlessly resumes the previously preset speed, helping to make your drive that much more relaxing.

### Audi side assist

The available Audi side assist uses radar sensors and two different optical warnings to help keep the driver informed about what is approaching from hard-to-see angles behind and to the side of the vehicle.

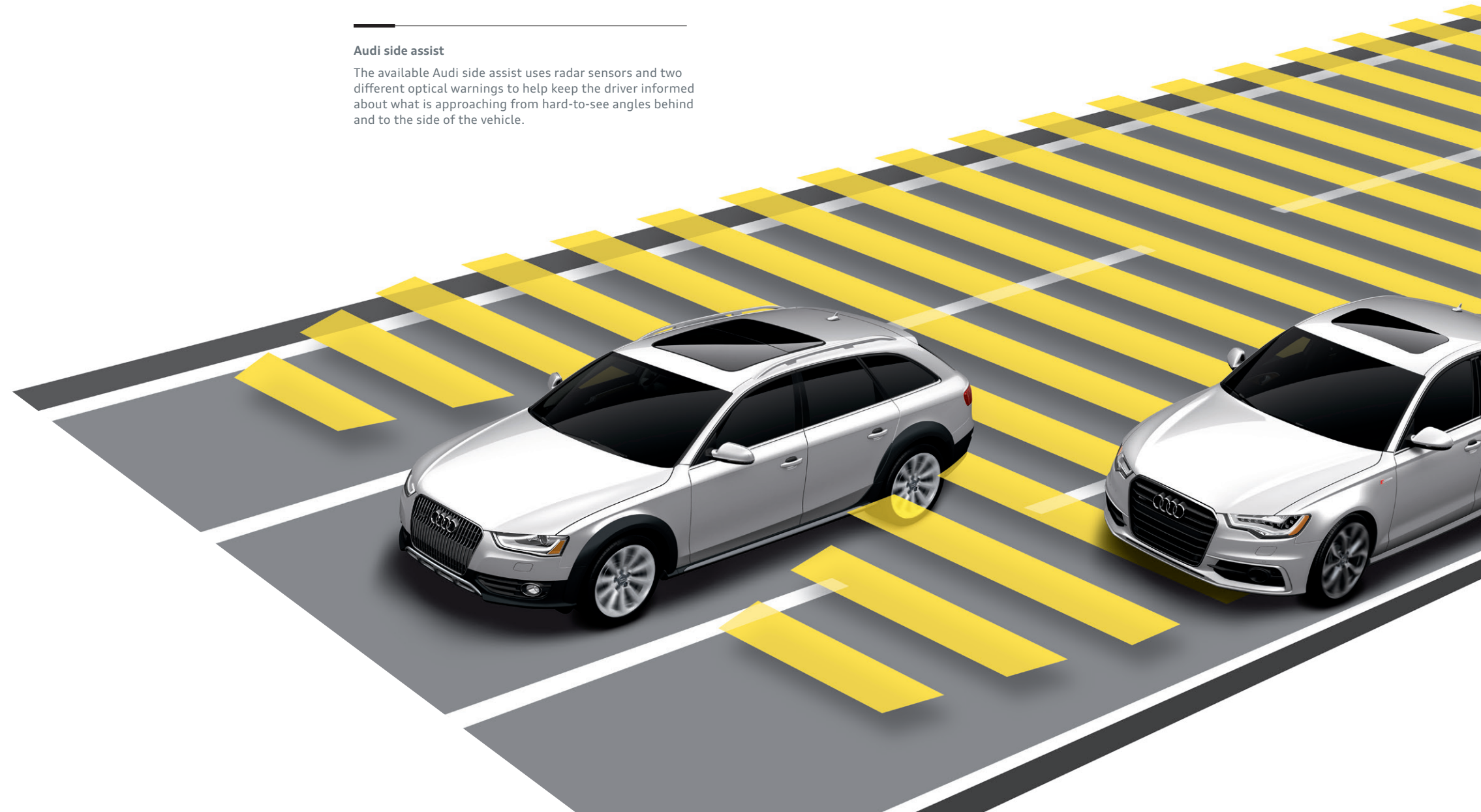



## Get in touch with your inner techie.

We believe intelligence is key to a higher form of luxury. You can see this philosophy fully represented in the available MMI® system. Simply put, it's an intuitive system that intimately connects you to almost every facet of the vehicle. It's the nerve center of your vehicle, allowing you to control virtually every interior function of your Audi with a simplified source control button system. Whether it's MMI navigation plus, or the available BLUETOOTH® streaming audio, MMI helps you access information with a few easy clicks. And even without it, you can pair your compatible phone with the vehicle for added convenience. With this kind of brainpower onboard, you can leave the little stuff to us, and just concentrate on how good it feels to drive.<sup>1,2</sup>



### MMI System

Putting your needs front and center.

#### SiriusXM® Satellite Radio

Go ahead. Crisscross the country. We assure you, you'll never run out of entertainment options, with over 150 channels of music, talk, sports and news.<sup>1</sup>

#### Audi media

The media function opens up a world of options when equipped with the MMI navigation plus, allowing you to control the Audi music interface, Secure Digital (SD) card slots, hard disk drive (HDD) audio jukebox or DVD, and BLUETOOTH® streaming audio from a compatible device.<sup>1,2</sup>

#### MMI navigation plus

Count on the available advanced navigation system to home in on your destination with stunning precision while putting a little more depth in your journey with help from the available Audi connect®.<sup>1,2</sup>

#### BLUETOOTH® wireless technology

Unlock your compatible mobile phone's potential through the MMI system. Simply pair them up and start enjoying near complete control at the touch of a button.

<sup>1</sup> See Infotainment/Technology section of the Featured Content page for important information regarding MMI® navigation plus and required SiriusXM® subscriptions. <sup>2</sup> Always pay careful attention to the road, and do not drive while distracted. The features and technologies discussed above are optional, may require an additional subscription with separate terms and conditions, and should be used only when it is safe and appropriate. The Wi-Fi® hotspot feature is intended for passenger use only.

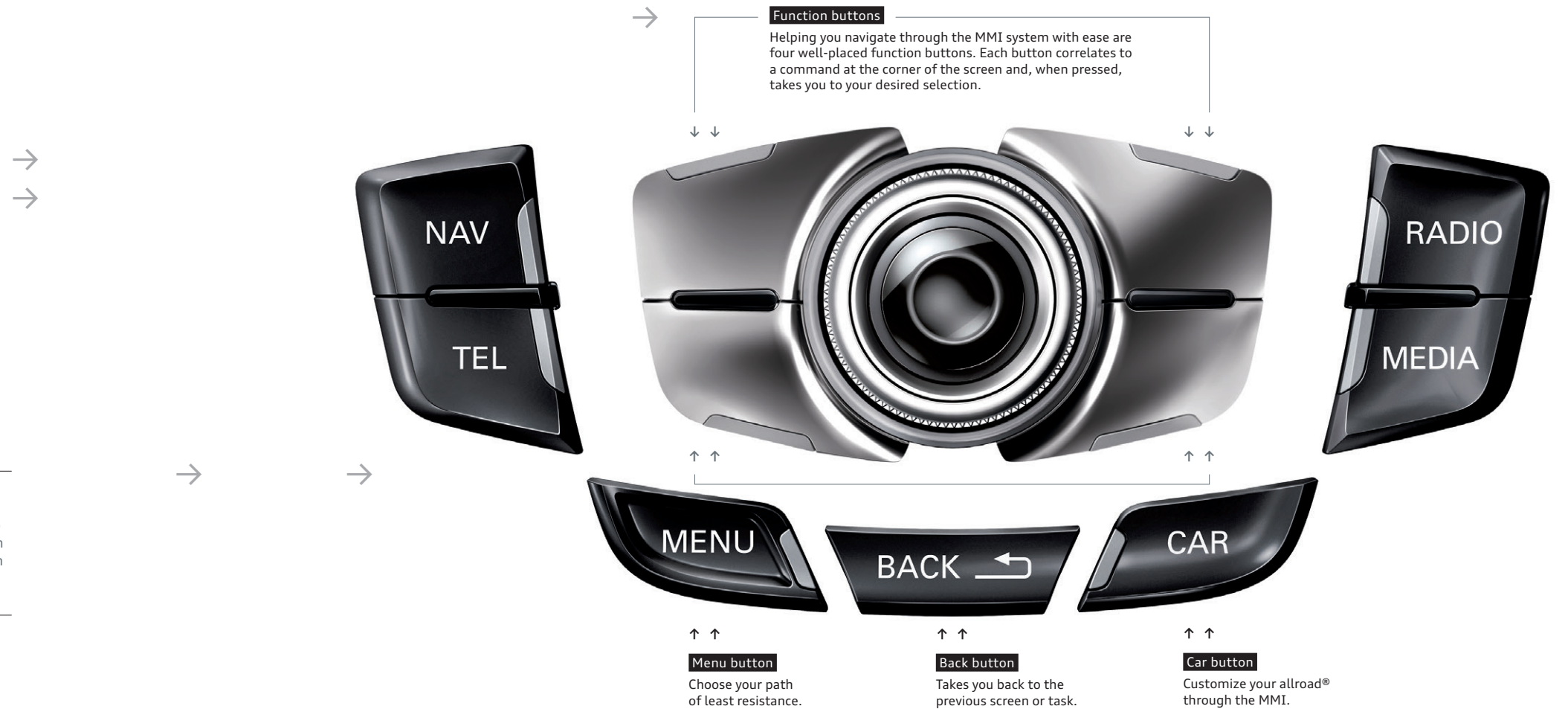



# Tell us what you're looking for and we'll deliver you to it.

Don't reach—relax. While touchscreens are seemingly everywhere, they don't need to be in your vehicle. With available Audi connect®, you may never have to reach out again.<sup>1</sup> Thanks to Google Voice™ Local Search, Audi connect allows you to quickly search Google™ by simple voice commands (use only when the car is stationary).<sup>1</sup> The crisp display is mounted farther up, closer to the windshield and near your sight line to the road ahead. For those times when you are feeling tactile, we've placed toggle buttons near the gear shifter, where your hand naturally rests when using them. So while other automobile manufacturers still want you to reach out, we've found a few ways for you to make information a lot more accessible while your hands are on the wheel.<sup>1</sup>

## POI

### Point-of-interest

The point-of-interest search with voice control means that the digital world is with you on every journey.<sup>1</sup>

myAudi

### myAudi features

Plan travel from your personal computer. Send your desired destinations to your vehicle ahead of time and access your route from your vehicle later.<sup>1</sup>

NEWS

### News feeds

Stay on top of the news by having headlines and stories delivered right to your MMI® display.<sup>1</sup>



### Mobile Wi-Fi® hotspot

Provides high-speed connectivity for up to eight passenger devices through an onboard wireless hub.<sup>1</sup>



### SiriusXM® Traffic

Get traffic information overlaid onto available 3D satellite imagery to visualize a true aerial view of your route, and let the MMI navigation plus system reconfigure your route to help avoid traffic.<sup>1,2</sup>



### Google Earth™ with 3D satellite imagery

With Google Earth™ integration, you'll enjoy 3D satellite imagery, including Google Maps Street View, displayed right on the MMI display.<sup>1</sup>



### Weather information

Current local conditions and forecasts for your destination can help you prepare for your trip.<sup>1</sup>



### Google Voice™ Local Search

Simply tell your Audi what you are in the mood for, then let the cloud-processing power of Google™ speech recognition interpret your request and bring up a list of destinations in the area of your choice.<sup>1</sup>



### Google Maps Street View

With Google Maps Street View, your vehicle can show you a driver's-eye view of your destination right before you arrive so it's easy to recognize.<sup>1</sup>



### Parking information

Search for parking in your area of interest, check space availability and set your selection as a destination to help navigate directly to the garage entrance.<sup>1,3</sup>



### City events

Get information about current events, exciting locations and places of interest at your travel destination, current location or other chosen location instantly.<sup>1</sup>



### Travel info

Discover local landmarks in your area of interest, set them as your destinations, and let your vehicle lead the way as you explore the world around you.<sup>1</sup>

<sup>1</sup> Always pay careful attention to the road, and do not drive while distracted. The features and technologies discussed above are optional, may require an additional subscription with separate terms and conditions, and should be used only when it is safe and appropriate. The Wi-Fi® hotspot feature is intended for passenger use only. <sup>2</sup> See Infotainment/Technology section of the Featured Content page for important information regarding MMI® navigation plus and required SiriusXM® subscriptions. <sup>3</sup> Parking feature is not available everywhere and requires participation by parking provider.





### Sound

Audi is Latin for "listen," so you know we take sound very seriously.

52 Hz

#### Low note on a kick drum

True bass tones are something you feel more than hear, and when a kick drum hits you with a frequency of 52 Hz, you definitely feel it. Knowing this, Audi sound engineers worked to reproduce sounds at this level for an exceptionally realistic experience.

2,093 Hz

#### High note on a piano

Even at a frequency of 2,093 Hz, the equivalent of the double high C note found on a piano, the sound system clearly and effortlessly reproduces the sound, giving you front row seats to every symphony.

261 Hz

#### Singing middle C

At a frequency of around 261 Hz, you'll find middle C. It is around this frequency that much of the brilliantly orchestrated sound is reproduced by the numerous, strategically placed speakers.

## Lend us your ear.

It's been said that people only hear what they want to. That what they don't like just goes in one ear and out the other. Well, for those people and everyone else, we've created a sound system that makes every note worthy of your eardrum's full attention. From perfectly sculpted high notes to a crystal clear mid-range to deep-diving lows, the available Bang & Olufsen® Sound System is a veritable orchestra of engineering that fills the cabin with faithfully rendered, thrilling sound. Which shouldn't be surprising at all, considering that Bang & Olufsen® and Audi sound engineers worked tirelessly to craft a perfect acoustic environment, and the ideal delivery system for it. So whether you're the type that wants to be soothed by sound or the type that wants to be inspired by it, we promise, if you take a moment to listen, that what you'll hear will be utterly impossible to ignore.

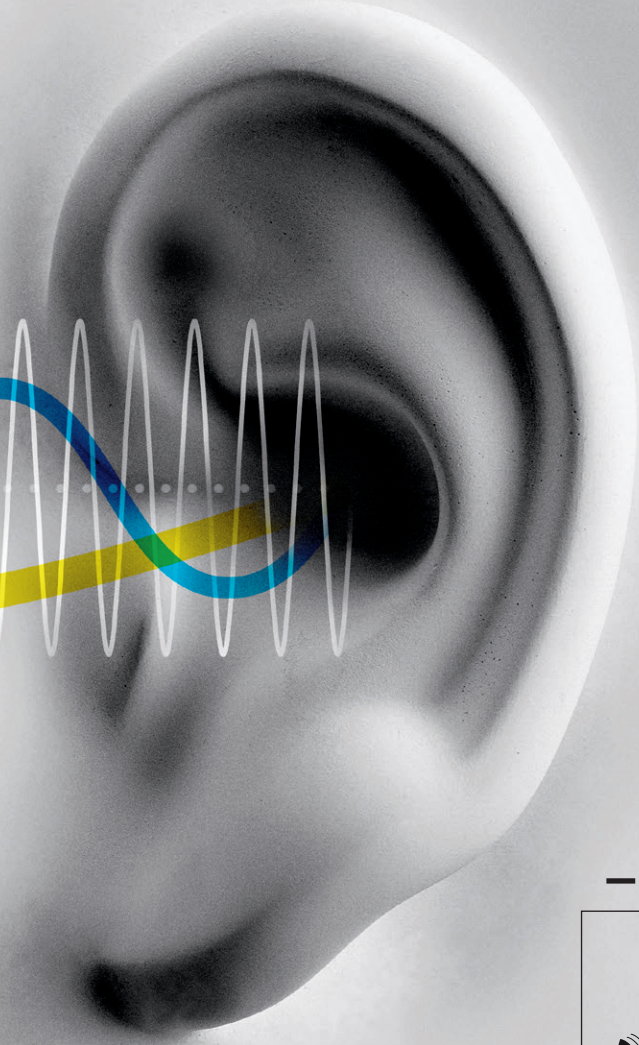

### Bang & Olufsen® Sound System

Dedicated to the idea of "honest music reproduction," Bang & Olufsen® is a sound engineer's dream. Through an available 505-watt, 14-speaker system perfectly integrated within your Audi, Bang & Olufsen® is set on transcending the limits of audio technology. By automatically adjusting volume and timbre balance to changing ambient noise levels and offering richly tuned acoustics, you'll hear the truth about how good life can sound in your Audi.

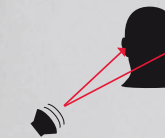

Unlike with high-frequency sounds, the brain cannot detect where low bass frequencies are coming from, making it seem as if the sound is hitting both ears at the same time. Because of this, Bang & Olufsen® sound engineers only had to design one custom-fitted subwoofer to reproduce the kind of deep, cabin-filling bass that brings music to life.



#### LED taillights

LEDs are among the most luminous taillights available. And, like Audi vehicles, they are efficient, technologically advanced and long-lasting.

## A brilliant way to lead wayward travelers home.

Distinct and brilliant, LED taillights will be the first indication to other outdoor enthusiasts that they are finally headed in the right direction. And, as if that were not enough to hurt their map-reading egos, the mesmerizing design of the allroad® comes to a bold finale around two perfectly sculpted exhaust tips, invoking jealousy to go along with the steady stream of profanity issuing, perhaps, from those who are less directionally inclined. At least you'll give them a lot to think about while they try to keep up with you.<sup>1</sup>

<sup>1</sup> Always obey all speed and traffic laws. <sup>2</sup> When driving during cold, snowy or icy weather conditions, ensure that your vehicle is equipped with appropriate all-season or winter tires. Even with appropriate tires, you must always drive in a manner appropriate for the weather, visibility and road conditions.





## Premium

### allroad® Premium featured highlights

- ▶ Singleframe® grille
- ▶ Xenon plus headlights with LED daytime running lights
- ▶ Headlight washing system
- ▶ Front and rear fog lights
- ▶ LED taillights
- ▶ Power-adjustable heated exterior side mirrors
- ▶ LED turn indicator lights integrated into the exterior side mirrors
- ▶ Heated windshield washer nozzles
- ▶ Aluminum roof rails
- ▶ Aluminum trim around exterior windows
- ▶ Power tailgate
- ▶ allroad® exterior appearance with contrasting cladding, stainless steel underbody protection and side sill inserts
- ▶ Three-zone automatic climate control
- ▶ Leather-wrapped shift knob
- ▶ Folding and sliding front center armrest with height adjustment
- ▶ Ambient LED interior lighting
- ▶ Power windows with one-touch up/down operation and pinch protection
- ▶ Panoramic sunroof
- ▶ Leather seating surfaces
- ▶ Eight-way power front seats and four-way power lumbar adjustment for driver
- ▶ Split folding 60/40 rear seatbacks
- ▶ Driver information system
- ▶ Audi concert radio with ten speakers and single CD player with MP3 playback capability
- ▶ SiriusXM® Satellite Radio with 90-day trial subscription<sup>1</sup>
- ▶ SD card slot with 32GB operating capacity (dual slots if equipped with MMI® navigation plus)
- ▶ Audi music interface with iPod® integration
- ▶ BLUETOOTH® wireless technology preparation for mobile phone<sup>2</sup>
- ▶ Garage door opener (HomeLink®)

### Available packages and stand-alone options

- ▶ MMI® navigation plus package<sup>3</sup>
- ▶ 18" 10-arm design wheels
- ▶ allroad® exterior appearance with full-paint finish
- ▶ Heated front seats
- ▶ Rear-passenger thorax side airbags<sup>4</sup>
- ▶ Dark Brown Walnut Wood decorative inlays
- ▶ Fine Grain Ash Natural Brown Wood decorative inlays



Up to 50.5 cu ft of cargo space<sup>5</sup>



LED taillights



Xenon plus headlights with LED daytime running lights

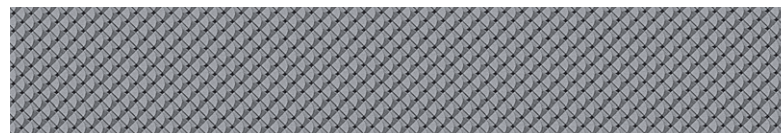

Aluminum Trigon decorative inlays



18" 5-arm-allroad® design wheels with 245/45 all-season tires<sup>5</sup>



Three-zone automatic climate control



Aluminum roof rails



Power tailgate



Aluminum door sill inlays



<sup>1</sup> See Infotainment/Technology section of the Featured Content page for important information regarding required SiriusXM® subscriptions. <sup>2</sup> Requires compatible device. <sup>3</sup> MMI® navigation plus depends on signals from the worldwide Global Positioning Satellite network. The vehicle's electrical system and existing wireless and satellite technologies must be available and operating properly for the system to function. The system is designed to provide you with suggested routes in locating addresses, destinations and other points of interest. Changes in street names, construction zones, traffic flow, points of interest and other road system changes are beyond the control of Audi of America, Inc. Complete detailed mapping of lanes, roads, streets, toll roads, highways, etc., is not possible, therefore you may encounter discrepancies between the mapping and your actual location. Please rely on your individual judgment in determining whether or not to follow a suggested MMI® navigation plus route. For mapping updates please see your Audi dealer or call 1-800-FOR-AUDI for details. <sup>4</sup> Airbags are supplemental restraints only and will not deploy under all crash circumstances. Always use safety belts and seat children only in the rear, using restraint systems appropriate for their size and age. <sup>5</sup> High-performance tires are designed for better performance and handling in warm climates. When driving in cold, snowy or icy weather, you should equip your vehicle with four all-season or winter tires, which offer better traction under those conditions. We suggest you use the Audi-recommended winter or all-season tires specified for your Audi. High-performance tires also have a lower aspect ratio that aids performance and handling. Driving over rough or damaged road surfaces, as well as debris, curbs and other obstacles, can cause serious damage to wheels, tires, vehicle body and suspension parts. Be careful to avoid road hazards and reduce your speed, especially if your vehicle is equipped with low-profile tires. Please also remember when making your selection that, while these tires deliver responsive handling, they may ride less comfortably and make more noise than others. Finally, these tires may wear more quickly than other choices. It is important that the inflation pressure is regularly checked and maintained at recommended levels. <sup>6</sup> All cargo should be properly secured before driving the vehicle. See your owner's manual for details.



## Premium Plus

The following highlighted features of the allroad® Premium Plus add to or replace the highlighted features of the allroad® Premium.

- ▶ Power-adjustable, power-folding, auto-dimming, heated exterior side mirrors with memory
- ▶ Three-spoke multifunction steering wheel
- ▶ Auto-dimming interior rear view mirror with digital compass
- ▶ Driver seat memory
- ▶ Heated front seats
- ▶ Audi advanced key—keyless start, stop and entry<sup>1</sup>

### Available packages and stand-alone options

- ▶ Sport Interior package
- ▶ Technology package
- ▶ 18" 10-arm design wheels
- ▶ allroad® exterior appearance with full-paint finish
- ▶ Bang & Olufsen® Sound System with 14 speakers and 505 watts
- ▶ Rear-passenger thorax side airbags<sup>2</sup>
- ▶ Dark Brown Walnut Wood decorative inlays
- ▶ Fine Grain Ash Natural Brown Wood decorative inlays



Audi advanced key—keyless start, stop and entry<sup>1</sup>



Driver seat memory

Heated front seats

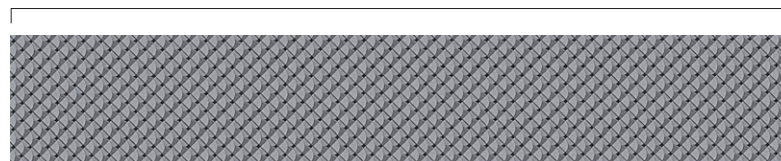

Aluminum Trigon decorative inlays



18" 5-arm-allroad® design wheels with 245/45 all-season tires<sup>3</sup>



Auto-dimming interior rear view mirror with digital compass



Power-adjustable, power-folding, auto-dimming, heated exterior side mirrors with memory



Three-spoke multifunction steering wheel



<sup>1</sup> Some Audi models are equipped with a keyless ignition feature. The details as to how the system works can vary, and Audi owners should consult their owner's literature or an authorized Audi dealer if they have further questions about the operation of this feature. Please note that Audi warns against leaving the vehicle unattended with the engine running, particularly in enclosed spaces. <sup>2</sup> Airbags are supplemental restraints only and will not deploy under all crash circumstances. Always use safety belts and seat children only in the rear, using restraint systems appropriate for their size and age. <sup>3</sup> High-performance tires are designed for better performance and handling in warm climates. When driving in cold, snowy or icy weather, you should equip your vehicle with four all-season or winter tires, which offer better traction under those conditions. We suggest you use the Audi-recommended winter or all-season tires specified for your Audi. High-performance tires also have a lower aspect ratio that aids performance and handling. Driving over rough or damaged road surfaces, as well as debris, curbs and other obstacles, can cause serious damage to wheels, tires, vehicle body and suspension parts. Be careful to avoid road hazards and reduce your speed, especially if your vehicle is equipped with low-profile tires. Please also remember when making your selection that, while these tires deliver responsive handling, they may ride less comfortably and make more noise than others. Finally, these tires may wear more quickly than other choices. It is important that the inflation pressure is regularly checked and maintained at recommended levels.



## Prestige

The following highlighted features of the allroad® Prestige add to or replace the highlighted features of the allroad® Premium Plus.

- ▶ Adaptive xenon plus headlights with LED daytime running lights
- ▶ Manual rear-side window sunshades
- ▶ MMI® navigation plus with voice control system<sup>1</sup>
- ▶ Audi connect® with six-month trial subscription<sup>2</sup>
- ▶ Color driver information system
- ▶ Bang & Olufsen® Sound System with 14 speakers and 505 watts
- ▶ HD Radio™ Technology
- ▶ SiriusXM® Traffic with four-year subscription<sup>3</sup>
- ▶ BLUETOOTH® streaming audio<sup>4</sup>
- ▶ Audi side assist
- ▶ Parking system plus with rear view camera

### Available packages and stand-alone options

- ▶ Sport Interior package
- ▶ Driver Assistance package
- ▶ 18" 10-arm design wheels
- ▶ allroad® exterior appearance with full-paint finish
- ▶ Rear-passenger thorax side airbags<sup>5</sup>
- ▶ Dark Brown Walnut Wood decorative inlays
- ▶ Fine Grain Ash Natural Brown Wood decorative inlays



MMI® navigation plus with voice control system<sup>1</sup>



Parking system plus with rear acoustic sensors



Parking system plus with rear view camera

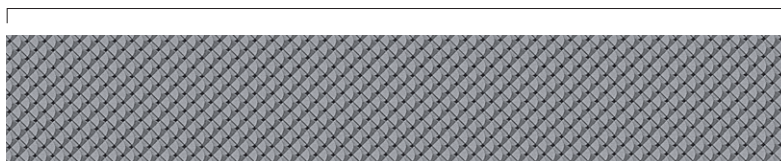

Aluminum Trigon decorative inlays



18" 5-arm-allroad® design wheels with 245/45 all-season tires<sup>6</sup>



Adaptive xenon plus headlights with LED daytime running lights



Audi connect® with Google Earth™ mapping service<sup>2</sup>



Audi side assist



Bang & Olufsen® Sound System with 14 speakers and 505 watts



<sup>1</sup> MMI® navigation plus depends on signals from the worldwide Global Positioning Satellite network. The vehicle's electrical system and existing wireless and satellite technologies must be available and operating properly for the system to function. The system is designed to provide you with suggested routes in locating addresses, destinations and other points of interest. Changes in street names, construction zones, traffic flow, points of interest and other road system changes are beyond the control of Audi of America, Inc. Complete detailed mapping of lanes, roads, streets, toll roads, highways, etc., is not possible, therefore you may encounter discrepancies between the mapping and your actual location. Please rely on your individual judgment in determining whether or not to follow a suggested MMI® navigation plus route. For mapping updates please see your Audi dealer or call 1-800-FOR-AUDI for details. <sup>2</sup> Always pay careful attention to the road, and do not drive while distracted. The features and technologies discussed above are optional, may require an additional subscription with separate terms and conditions, and should be used only when it is safe and appropriate. The Wi-Fi® hotspot feature is intended for passenger use only. <sup>3</sup> See Infotainment/Tech-

nology section of the Featured Content page for important information regarding required SiriusXM® subscriptions. <sup>4</sup> Requires compatible device. <sup>5</sup> Airbags are supplemental restraints only and will not deploy under all crash circumstances. Always use safety belts and seat children only in the rear, using restraint systems appropriate for their size and age. <sup>6</sup> High-performance tires are designed for better performance and handling in warm climates. When driving in cold, snowy or icy weather, you should equip your vehicle with four all-season or winter tires, which offer better traction under those conditions. We suggest you use the Audi-recommended winter or all-season tires specified for your Audi. High-performance tires also have a lower aspect ratio that aids performance and handling. Driving over rough or damaged road surfaces, as well as debris, curbs and other obstacles, can cause serious damage to wheels, tires, vehicle body and suspension parts. Be careful to avoid road hazards and reduce your speed, especially if your vehicle is equipped with low-profile tires. Please also remember when making your selection that, while these tires deliver responsive handling, they may ride less comfortably and make more noise than others. Finally, these tires may wear more quickly than other choices. It is important that the inflation pressure is regularly checked and maintained at recommended levels.



## Packages

Analogous to the progressive nature in which all our vehicles are engineered are the technologies and offerings available in a variety of packages to enhance the experience of driving an Audi vehicle. To prove that luxury has progressed, we invite you to explore the package that best outfits your allroad®.

### MMI® navigation plus package

Available on Premium models

- ▶ MMI® navigation plus with voice control<sup>1</sup>
- ▶ Color driver information system
- ▶ HD Radio™ Technology
- ▶ SiriusXM® Traffic with four-year subscription<sup>2</sup>
- ▶ BLUETOOTH® streaming audio<sup>3</sup>



### Sport Interior package

Available on Premium Plus and Prestige models

- ▶ Shift paddles
- ▶ Black cloth headliner
- ▶ Audi drive select
- ▶ Twelve-way power front sport seats, including four-way power lumbar adjustment



### Technology package

Available on Premium Plus models

- ▶ MMI® navigation plus with voice control<sup>1</sup>
- ▶ Audi connect® with six-month trial subscription<sup>4</sup>
- ▶ Color driver information system
- ▶ HD Radio™ Technology
- ▶ SiriusXM® Traffic with four-year subscription<sup>2</sup>
- ▶ BLUETOOTH® streaming audio<sup>3</sup>
- ▶ Audi side assist
- ▶ Parking system plus with rear view camera



### Driver Assistance package

Available on Prestige models

- ▶ Dynamic steering
- ▶ Audi adaptive cruise control
- ▶ Audi drive select



## Options

In addition to the many packages available for your allroad, there are also a host of a la carte options to outfit your vehicle. From a wheel offering and choices of elegant interior trims to features like rear-passenger thorax side airbags and a full-paint finish to the body cladding, there's an option to help better complement your lifestyle.



18" 10-arm design wheels with 245/45 all-season tires<sup>5</sup> (optional on all models)



allroad® exterior appearance with full-paint finish (limited exterior colors, optional on all models)



Rear-passenger thorax side airbags<sup>6</sup> (optional on all models)



Heated front seats (optional on Premium models)



Bang & Olufsen® Sound System with 14 speakers and 505 watts (optional on Premium Plus models)



Dark Brown Walnut Wood decorative inlays (optional on all models)



Fine Grain Ash Natural Brown Wood decorative inlays (optional on all models)

<sup>1</sup> MMI® navigation plus depends on signals from the worldwide Global Positioning Satellite network. The vehicle's electrical system and existing wireless and satellite technologies must be available and operating properly for the system to function. The system is designed to provide you with suggested routes in locating addresses, destinations and other points of interest. Changes in street names, construction zones, traffic flow, points of interest and other road system changes are beyond the control of Audi of America, Inc. Complete detailed mapping of lanes, roads, streets, toll roads, highways, etc., is not possible, therefore you may encounter discrepancies between the mapping and your actual location. Please rely on your individual judgment in determining whether or not to follow a suggested MMI® navigation plus route. For mapping updates please see your Audi dealer or call 1-800-FOR-AUDI for details. <sup>2</sup> See Infotainment/Technology section of the Featured Content page for important information regarding required SiriusXM® subscriptions. <sup>3</sup> Requires compatible device. <sup>4</sup> Always pay careful attention to the road, and do not drive while distracted. The features and technologies discussed above are optional, may require an additional subscription with separate terms and conditions, and should be used only when it is safe and appropriate. The Wi-Fi® hotspot feature is intended for passenger use only. <sup>5</sup> High-performance tires are designed for better performance and handling in warm climates. When driving in cold, snowy or icy weather, you should equip your vehicle with four all-season or winter tires, which offer better traction under those conditions. We suggest you use the Audi-recommended winter or all-season tires specified for your Audi. High-performance tires also have a lower aspect ratio that aids performance and handling. Driving over rough or damaged road surfaces, as well as debris, curbs and other obstacles, can cause serious damage to wheels, tires, vehicle body and suspension parts. Be careful to avoid road hazards and reduce your speed, especially if your vehicle is equipped with low-profile tires. Please also remember when making your selection that, while these tires deliver responsive handling, they may ride less comfortably and make more noise than others. Finally, these tires may wear more quickly than other choices. It is important that the inflation pressure is regularly checked and maintained at recommended levels. <sup>6</sup> Airbags are supplemental restraints only and will not deploy in all crash circumstances. Always use safety belts and seat children only in the rear, using restraint systems appropriate for their size and age.



## Exterior Colors

Brilliant Black



Ibis White

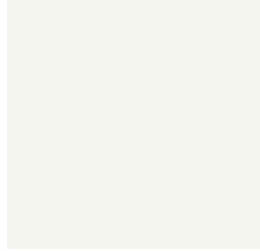

Cuvée Silver metallic

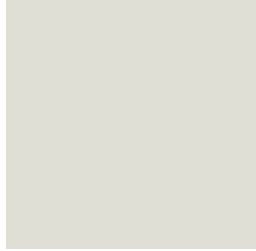

Dakota Gray metallic

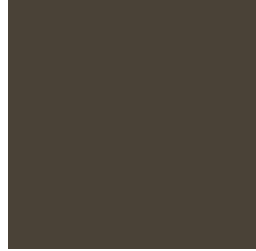

Florett Silver metallic

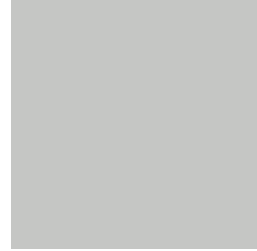

Full-paint finish (optional)

Glacier White metallic

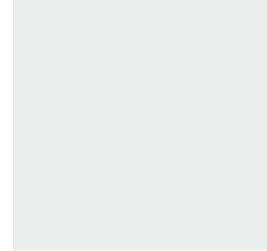

Full-paint finish (optional)

Monsoon Gray metallic

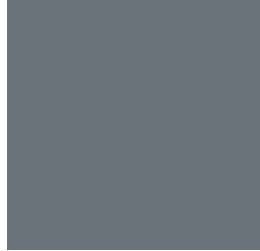

Moonlight Blue metallic



Mythos Black metallic

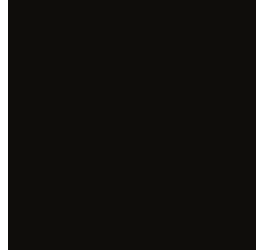

Full-paint finish (optional)

Scuba Blue metallic



Tornado Gray metallic



Utopia Blue metallic



Volcano Red metallic



## Seat Selections | Interior Colors | Decorative Inlays

Standard Seat



Sport Seat



Black leather



Standard, Sport

Titanium Gray leather

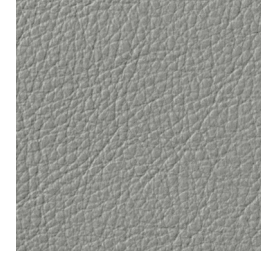

Standard, Sport

Chestnut Brown leather



Standard, Sport

Velvet Beige leather



Standard

Aluminum Trigon decorative inlays

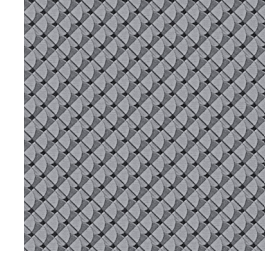

Dark Brown Walnut Wood decorative inlays

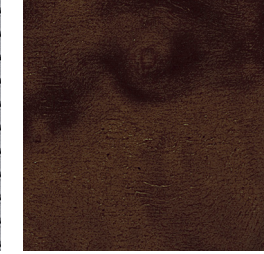

Fine Grain Ash Natural Brown Wood decorative inlays

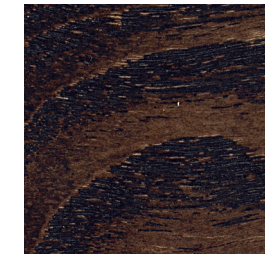



## Technical Specifications

### Engineering | Performance

	allroad®
Engine type	Four-cylinder
Engine block/Cylinder head	Cast-iron/Aluminum-alloy
Displacement (cc)/Bore and stroke (mm)	1,984/82.5 x 92.8
Horsepower (@ rpm)	220 @ 4,450–6,000
Torque (lb-ft @ rpm)	258 @ 1,500–4,300
Compression ratio	9.6:1
Valvetrain	16-valve DOHC with valvelift system
Induction/Fuel injection	Turbocharged/TFSI®
Acceleration (0–60 mph)	<b>NA</b>
Top track speed <sup>1</sup>	130 mph

### Transmission | Drivetrain

Eight-speed Tiptronic® automatic transmission with quattro® all-wheel drive (Gear ratios: 1st: 4.714, 2nd: 3.143, 3rd: 2.106, 4th: 1.667, 5th: 1.285, 6th: 1.000, 7th: 0.839, 8th: 0.667, Reverse: 3.317, Final drive: 3.076)	■
---	---

### Body | Suspension | Chassis

Fully galvanized steel unibody with multistep anti-corrosion protection	■
Five-link front suspension	■
Trapezoidal-link rear suspension	■
Ventilated front disc/Solid rear disc brakes (in)	12.6/11.8
Electromechanical power steering system	■
Dynamic steering (Prestige)	Available
Steering ratio	15.9:1
Turning diameter, curb-to-curb (ft)	37.7

### Exterior measurements

	allroad®
Wheelbase (in)	110.4
Length (in)	185.9
Height (in)	58.0
Overall width with mirrors (in)	79.0
Overall width without mirrors (in)	72.5
Track front/rear (in)	62.3/62.0
Ground clearance, loaded (in)	7.1
Curb weight (lb)	3,891
Drag coefficient (C <sub>w</sub> )	.36

### Interior measurements

Head room with sunroof (in, front/rear)	38.5/38.2
Leg room (in, front/rear)	41.3/35.2
Shoulder room (in, front/rear)	55.5/54.3
Cargo volume (cu ft, rear seatbacks up/with seats folded)	27.6/50.5
Seating capacity	5

### EPA mileage estimates | Capacities | Emissions

Tiptronic® automatic transmission (city/highway/combined) <sup>2</sup>	<b>NA</b>
Engine oil (qt)	4.9
Fuel (gal)	16.1
Recommended fuel	Premium
Emissions rating	ULEV II



## Featured Content

Safety   Security	Premium	Premium Plus	Prestige
Driver and front passenger dual-stage airbags, front thorax side airbags and Sideguard® head curtain airbags <sup>1</sup>	■	■	■
Rear-passenger thorax side airbags <sup>1</sup>	Available	Available	Available
Front-passenger occupant detection for airbags <sup>1</sup>	■	■	■
Safety belt reminder for driver and front passenger	■	■	■
Lower Anchors and Tethers for CHildren (LATCH) in rear seats	■	■	■
Power central locking system with safety unlock feature if airbags deploy	■	■	■
Electronic Stability Control (ESC) with Offroad mode and traction control (ASR)	■	■	■
Anti-lock Brake System (ABS) with Electronic Brake-pressure Distribution (EBD) and brake assist	■	■	■
Tire-pressure monitoring system	■	■	■
Electromechanical parking brake	■	■	■
Anti-theft alarm system with immobilizer	■	■	■

Exterior	Premium	Premium Plus	Prestige
Singleframe® grille	■	■	■
Xenon plus headlights with LED daytime running lights	■	■	—
Adaptive xenon plus headlights with LED daytime running lights	—	—	■
Headlight washing system	■	■	■
Automatic headlights	■	■	■
Front and rear fog lights	■	■	■
LED taillights	■	■	■
Power-adjustable heated exterior side mirrors	■	—	—
Power-adjustable, power-folding, auto-dimming, heated exterior side mirrors with memory	—	■	■
LED turn indicator lights integrated into the exterior side mirrors	■	■	■
Heated windshield washer nozzles	■	■	■
Aluminum roof rails	■	■	■
Aluminum trim around exterior windows	■	■	■
Rear privacy glass	■	■	■
Power tailgate	■	■	■
Dual exhaust outlets	■	■	■
allroad® exterior appearance with contrasting cladding, stainless steel underbody protection and side sill inserts	■	■	■

■ Standard    — Not applicable

Exterior (continued)	Premium	Premium Plus	Prestige
allroad® exterior appearance with full-paint finish (limited exterior colors)	Available	Available	Available

Interior	Premium	Premium Plus	Prestige
Three-zone automatic climate control	■	■	■
Four-spoke multifunction steering wheel	■	—	—
Three-spoke multifunction steering wheel	—	■	■
Shift paddles	—	Available	Available
Tilt and telescopic manually adjustable steering column	■	■	■
Auto-dimming interior rear view mirror with digital compass	—	■	■
Illuminated locking glove compartment	■	■	■
Leather-wrapped shift knob	■	■	■
Folding and sliding front center armrest with height adjustment	■	■	■
Eight beverage holders (four cup and four bottle)	■	■	■
Decorative interior inlays	■	■	■
Aluminum door sill inlays	■	■	■
Front and rear footwell LED lighting	■	■	■
Front and rear floor mats	■	■	■
Ambient LED interior lighting	■	■	■
Black cloth headliner	Available	Available	Available
Dual front sun visors with lighted vanity mirrors	■	■	■
Power windows with one-touch up/down operation and pinch protection	■	■	■
Manual rear-side window sunshades	—	—	■
Panoramic sunroof	■	■	■

Seating	Premium	Premium Plus	Prestige
Leather seating surfaces	■	■	■
Eight-way power front seats and four-way power lumbar adjustment for driver	■	■	■
Twelve-way power front sport seats, including four-way power lumbar adjustment	—	Available	Available
Driver seat memory	—	■	■
Heated front seats	Available	■	■
Split folding 60/40 rear seatbacks	■	■	■

<sup>1</sup> Airbags are supplemental restraints only and will not deploy under all crash circumstances. Always use safety belts and seat children only in the rear, using restraint systems appropriate for their size and age.



## Featured Content

Infotainment   Technology	Premium	Premium Plus	Prestige
MMI® navigation plus with voice control system <sup>1</sup>	Available	Available	■
Audi connect® with six-month trial subscription <sup>2</sup>	—	Available (with navigation)	■
Driver information system	■	■	—
Color driver information system	Available (with navigation)	Available (with navigation)	■
Audi concert radio with ten speakers and single CD player with MP3 playback capability	■	■	—
Bang & Olufsen® Sound System with 14 speakers and 505 watts	—	Available	■
HD Radio™ Technology	Available (with navigation)	Available (with navigation)	■
SiriusXM® Satellite Radio with 90-day trial subscription <sup>3</sup>	■	■	■
SiriusXM® Traffic with four-year subscription <sup>3</sup>	Available (with navigation)	Available (with navigation)	■
SD card slot with 32GB operating capacity (dual slots if equipped with MMI® navigation plus) <sup>1</sup>	■	■	■
Audi music interface with iPod® integration	■	■	■
BLUETOOTH® streaming audio <sup>4</sup>	Available (with navigation)	Available (with navigation)	■
BLUETOOTH® wireless technology preparation for mobile phone <sup>4</sup>	■	■	■
Four 12-volt power outlets	■	■	■
Garage door opener (HomeLink®)	■	■	■
Audi advanced key—keyless start, stop and entry <sup>5</sup>	—	■	■
Cruise control with coast, resume and accelerate features	■	■	■
Audi adaptive cruise control	—	—	Available
Audi side assist	—	Available	■
Audi drive select	—	Available	Available
Parking system plus with rear view camera	—	Available	■
Rain/light sensor for automatic windshield wipers and headlights	■	■	■

■ Standard    — Not applicable

<sup>1</sup> MMI® navigation plus depends on signals from the worldwide Global Positioning Satellite network. The vehicle's electrical system and existing wireless and satellite technologies must be available and operating properly for the system to function. The system is designed to provide you with suggested routes in locating addresses, destinations and other points of interest. Changes in street names, construction zones, traffic flow, points of interest and other road system changes are beyond the control of Audi of America, Inc. Complete detailed mapping of lanes, roads, streets, toll roads, highways, etc., is not possible, therefore you may encounter discrepancies between the mapping and your actual location. Please rely on your individual judgment in determining whether or not to follow a suggested MMI® navigation plus route. For mapping updates please see your Audi dealer or call 1-800-FOR-AUDI for details. <sup>2</sup> Always pay careful attention to the road, and do not drive while distracted. The features and technologies discussed above are optional, may require an additional subscription with separate terms and conditions, and should be used only when it is safe and appropriate. The Wi-Fi® hotspot feature is intended for passenger use only. <sup>3</sup> SiriusXM® Satellite Radio and Traffic subscriptions sold separately or as a package after trial expires. SiriusXM® Traffic service available in select markets. Subscriptions are governed by SiriusXM® Customer Agreement (see www.siriusxm.com) and are continuous until you call SiriusXM® to cancel. SiriusXM® U.S. Satellite Service available only to those 18 and older in the 48 contiguous U.S.A., D.C. and Puerto Rico (with coverage limitations). <sup>4</sup> Requires compatible device. <sup>5</sup> Some Audi models are equipped with a keyless ignition feature. The details as to how the system works can vary, and Audi owners should consult their owner's literature or an authorized Audi dealer if they have further questions about the operation of this feature. Please note that Audi warns against leaving the vehicle unattended with the engine running, particularly in enclosed spaces. <sup>6</sup> Audi Genuine Accessories purchased from an authorized Audi dealer are covered for the greater of: (1) the accessory limited warranty period (12 months or 12,000 miles, whichever occurs first) from the time of purchase; or (2) the remainder of the Audi New Vehicle Limited Warranty period (4 years or 50,000 miles, whichever occurs first). See your authorized Audi dealer for details. <sup>7</sup> All roof-rack system attachments require the base carrier bars. All attachments sold separately. <sup>8</sup> Recreational equipment and sporting equipment not included.

## Accessories

Add distinction, versatility and the ultimate in self-expression with Audi Genuine Accessories. Whether you load the cargo carrier with climbing gear or add a set of stylish new wheels, we have the accessories that will help enhance every facet of your lifestyle. When purchased from an authorized dealer, all pieces are backed by your vehicle's 4-year/50,000-mile limited warranty or for 12 months/12,000 miles from the accessory purchase date, whichever is greater.<sup>6</sup> If you're looking to personalize or protect the vehicle you love, we have an Audi-designed solution that works for you.



### Ski and snowboard rack

This rack transports your equipment to the slopes easily and securely. The standard attachment (shown) holds two sets of skis or two snowboards. A deluxe attachment is also available.<sup>7,8</sup>

### Fork-mount bike rack

Safely take along your favorite bike. Made of anodized aluminum, this rack features a quick-clamping device that can be secured with the included lock.<sup>7,8</sup>

### Splash guards

Help protect the finish of your allroad with custom-fit splash guards made of crack-resistant rubber. They are available in sets of two for front or rear.

### All-weather floor mats

Deep-ribbed, channeled design helps protect the floor and carpeting from water, mud, sand and snow. Black mats are available in sets of two for front or rear. Front mats feature the allroad® logo.

### Premium textile floor mats

These skid-resistant, precision-fit mats are made of long-life fabric to help protect your vehicle's interior from the elements. Mats are black with silver piping, and available in a set of four.

### All-weather cargo mat

Custom fit for your allroad, the raised outside edge of the cargo mat helps contain spills and protects cargo-area carpeting from stains. The textured material helps control load shifting.

### More allroad accessories

#### Audi Genuine Sport and Design Accessories

Your allroad features a bold, aggressive stance and strong, stunning lines. Enhance it by adding Audi Genuine Sport and Design accessories. All are carefully scrutinized in the design and development process. So while they're striking in appearance, they've also passed rigorous quality assessments, including corrosion testing. If you're looking for a bolder appearance or a finishing touch, there is a solution designed by Audi that makes every mile more enjoyable—and more yours.

#### Audi Guard Car Care Products

Your Audi allroad deserves the very best, and this is it: the only car care line designed specifically for Audi. Audi Guard Car Care Products provide gentle cleansing formulas and special tools to help give all interior and exterior surfaces the finest in cleaning and protection. Our shampoos and waxes undergo testing for cleaning performance, change in luster and material compatibility. For the ultimate in shine and sparkle, trust Audi Guard. Pristine, perfect.

See all the accessories offered for your allroad® by visiting [parts.audiusa.com](http://parts.audiusa.com).



Notes: A word about this brochure. Audi of America, Inc., believes the specifications in this brochure to be correct at the time of printing. However, specifications, standard equipment, options, fabrics, and colors are subject to change without notice. Some equipment may be unavailable when your vehicle is built. Please ask your dealer for advice concerning current availability of standard and optional equipment, and your dealer will verify that your vehicle will include the equipment you ordered. Vehicles in this brochure are shown with optional equipment. See your dealer for complete details on the Audi New Vehicle Limited Warranty, twelve-year limited warranty against corrosion perforation, and Audi 24/7 Roadside Assistance. (Roadside assistance coverage provided by Road America in the U.S. Certain conditions apply; see your dealer for details.) Tires supplied by various manufacturers. "Audi," all model names, "allroad," "Audi connect," "e-tron," "FSI," "MMI," "quattro," "Sideguard," "Singleframe," and the Singleframe grille design, "TFSI," "Truth in Engineering," "ultra," and the four rings logo are registered trademarks of AUDI AG. "Bang & Olufsen" is a registered trademark of Bang & Olufsen. The BLUE TOOTH word mark and logos are owned by the Bluetooth SIG, Inc., and any use of such marks by AUDI AG is under license. "Google," "Google Earth" and "Google Voice" are trademarks of Google Inc. "HD Radio" and the HD Radio logo are proprietary trademarks of iBiquity Digital Corporation. "HomeLink" is a registered trademark of Johnson Controls Technology Company. "iPod" is a registered trademark of Apple Inc. "SiriusXM" and all related marks and logos are trademarks of Sirius XM Radio Inc. and its subsidiaries. "TDI" is a registered trademark of Volkswagen AG. "Tiptronic" is a registered trademark of Dr. Ing h. c. F. Porsche AG. "Wi-Fi" is a trademark of the Wi-Fi Alliance. All other trademarks are the property of their respective owners. Some European models shown.

---

2015 | **allroad** Audi of America

[AudiUSA.com](http://AudiUSA.com)

[Facebook.com/Audi](https://www.facebook.com/Audi)

AoA1515488



© 2014 Audi of America, Inc. Printed in the U.S.A.