



Q7

Audi Q7

Audi
Truth in Engineering



If it was this easy, it wouldn't be an Audi.

Obsession



IMAGINE DEVOTING YOUR LIFE TO BUILDING YOUR MODEL.

When you were a kid, you probably felt quite proud when you completed a model kit. We understand. At Audi, it takes countless hours for a single Audi to go from idea to design to roadworthy, and that's time we are very proud to devote. Our obsession for detail,

commitment to premium fit and finish and passion for unparalleled engineering go into every model. It's the kind of discipline that the word "painstaking" was invented to describe. Not to say it's a chore—no, assembling an Audi is a labor of love, and it shows every time you sit in one, engage the ignition and nudge the accelerator. Creating an Audi isn't easy, but the results help define what Audi means to the people who drive one.

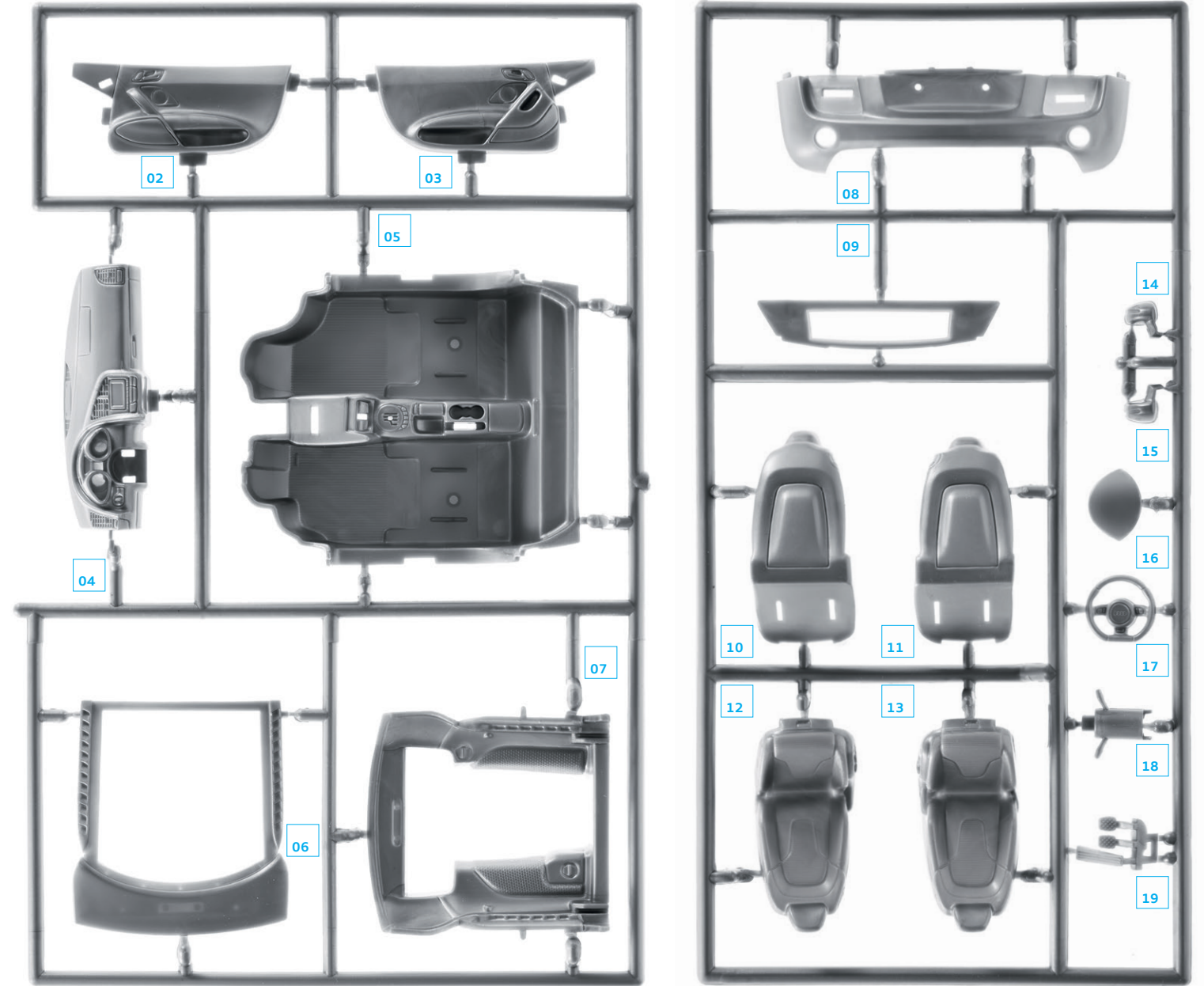



The door of perception.

OUR REPUTATION HINGES ON THE QUALITY OF THINGS YOU DON'T SEE.

It's said that, when one door closes, another one opens. It sounds as if whoever said it spent some time at an Audi research and development facility. After all, while you'll open and close the door on your Audi thousands of times without thinking about it, we've obsessed about it for you, in detail. Not just about the reliability of it opening and

closing, but on the proper weight that will make it more pleasing to close. How the locks should click when they are engaged. The optimal acoustic placement for the speaker port. There are the hinges too, of course. And the door itself, which we designed to take the brunt of side-impact collisions, and several dozen other safety considerations (to say nothing of the countless other components, processors, sensors, window features and the inner workings most people will never see). Our doors are more than a symbol of welcoming you into your vehicle, they are products of Audi engineering, and the very perception of Audi hinges on them as much as our hinges help support the door.

ACOUSTIC ENHANCEMENTS

We use soft mounts on our window regulator and a sound-absorbing backing within the door cavity itself to make the cabin even quieter.

INNOVATIVE DESIGN

By using fully pressed aluminum doors in the Audi A6, the door structures were reduced by an astonishing 44 lb compared to the previous model.

SPEAKER PLACEMENT

Optimal speaker placement helps deliver the most extraordinary sound you can find in the automotive space.

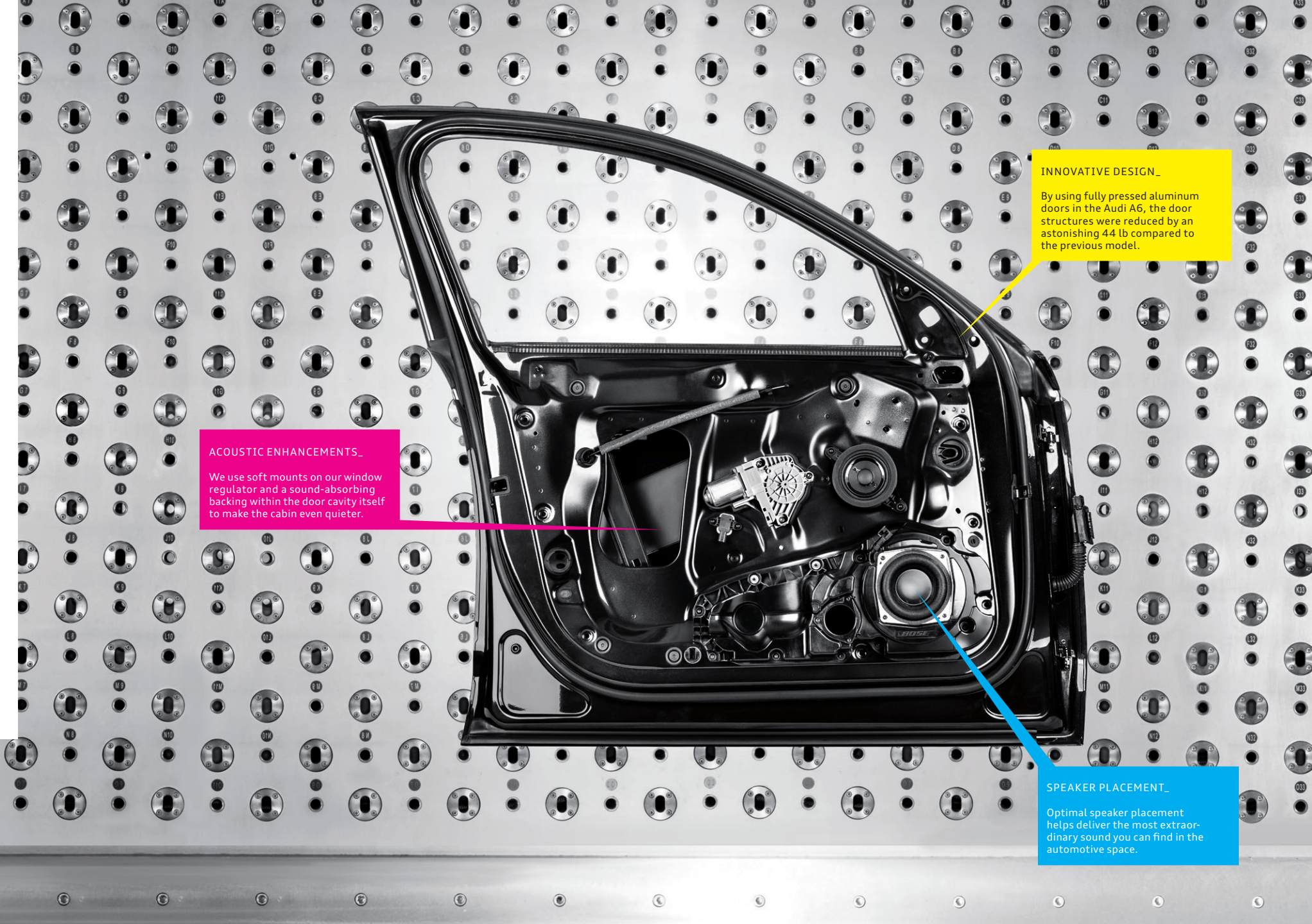

When we think of a good idea, it sticks.



SURFACES

WET
DRY
SLIPPERY
UNEVEN

Torque is distributed to all four wheels in varying amounts.

Torque vectoring

By independently braking the inside cornering wheels, torque is then transferred to the outside cornering wheels. This intelligent application of power, known as torque vectoring, is available on select quattro models and helps promote neutral handling by calculating the driver's steering input and desired level of acceleration.

Sport differential

To help ensure high cornering agility, the available sport differential uses torque vectoring, and then adds to that by mechanically applying additional torque to the outside rear cornering wheel. Through an electrohydraulic multiplate clutch pack and gear-set, the outside rear cornering wheel speed is increased by as much as 10%.

CORNERS

CURVES
MOUNTAINS
OBSTACLES
HANDLING
UNEXPECTED

Impressive stability, more assured road-holding, enhanced agility and improved steering precision.

TRACTION

ACCELERATION
TOWING
SNOW
CRUISING
GRAVEL

quattro directs the amount of torque required to suit the job at hand.

quattro® HAS MAINTAINED ITS GRIP ON OUR THINKING AND THE ROADS WE TRAVEL.

For more than 30 years, Audi has been focused on quattro® all-wheel drive. During that time, it has evolved into an overarching idea of performance, a technological system of ratios, power delivery and driving dynamics working seamlessly together, orchestrated through the drivetrain, providing power where and when it is needed most. In

many ways, this has been a three-decade drive, from the Alps to the autobahn—and points beyond. You've seen quattro® capabilities in the way we dominated the World Rally Championship for years, in the grip you have in inclement weather, and in the variable power distribution you enjoy in good conditions.¹ For more than 30 years, and with over five million quattro® systems on the road, we have continued to refine the technology, developing an available rear sport differential to help maximize performance and available torque vectoring to assist with cornering traction while helping to improve handling. We've boldly stuck to what worked while the world was trying to catch up, and we built on it.

¹ When driving during cold, rainy, snowy or icy weather conditions, ensure that your vehicle is equipped with appropriate all-season or winter tires. Even with appropriate tires, you must always drive in a manner appropriate for the weather, visibility and road conditions.

The obsessive engineering of maximum fitness.

ENGINEERING POWER IS MORE THAN JUST ADDING MUSCLE.

There is an art to fitness. Yes, there are some who go for the massive, sculptured muscle look. But there is something more compelling out there for those with more refined tastes. The kind of sculpted efficiency found in Audi engines elevates the driving experience through smaller, finely tuned forced-

induction engines. For the drive to feel lean and precise, we've shaved off unwanted pounds. Sure, large numbers might distract some, but a champion impresses with its grace, power and athletic balance—captured in the right suspension setting, or a torque-vectoring corner. Audi engineers taste strength that pulses at the moment of acceleration, provides a true, quick response as you change lanes, and turns the most routine cloverleaf into a joyful application of performance handling.¹ This is the art of maximum fitness, to the point where others just feel a little flabby.

FSI[®]

The FSI direct injection fuel system directly injects fuel into the combustion chambers at precisely managed times and depths. What that means for drivers is that a fully homogenized intake charge helps increase power while also reducing fuel consumption and emissions, making efficiency more powerful.²

TFSI[®]

At Audi, TFSI represents a combination of two of the brand's core areas of expertise—direct injection and forced induction. By adding turbocharging or supercharging to FSI direct injection, the pressurized intake charge is cooled by directly injected fuel, thus achieving efficiency and performance combined with higher compression ratios—previously only attainable by naturally aspirated engines.²

TDI[®]

A turbocharged, fuel-sipping variant, our TDI[®] clean diesel engines deliver uncompromising Audi performance with bold efficiency.¹ Yes, it gets better mileage per gallon than comparable gasoline engines,² but it also produces more low-end torque, which is best expressed in the elasticity you have when passing in the 30- to 60-mph range.

¹ Always obey all speed and traffic laws.
² See www.fueleconomy.gov for EPA estimates and emissions data. Your mileage and emissions will vary and depend on several factors, including your driving habits and vehicle condition.

ELEPHANT SKULL_

How nature solved the apparent conundrum of an elephant's skull didn't escape the notice of Heinrich Timm, the longtime lead engineer for Audi. The weight of the tusks and the general size of an elephant's head would seem to make it impossible for the animal to actually be able to carry it. But the design genius behind the elephant's skull is to make it lightweight yet sturdy. Its predominantly hollow design is buffered by thin, connective bone walls, which act as strong, weight-bearing cells. Audi designers used that idea when building our aluminum and steel structures. Reducing weight, yet enabling strength.



ultra

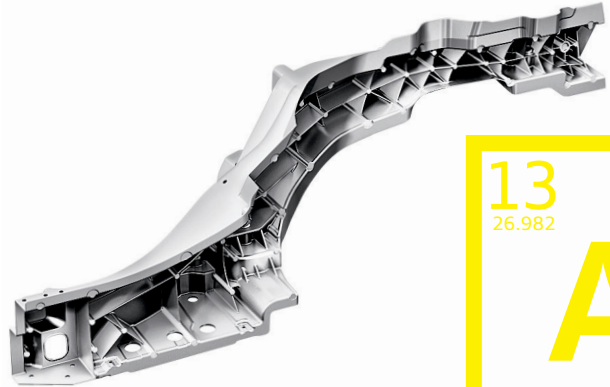

13
26.982

AU

ALUMINUM_

Our large aluminum castings are a telling example of ultra lightweight technology. Primarily used in high-stress areas, these castings achieve exceptional rigidity while also allowing for freedom of design, all while remaining extremely lightweight!

How studying elephant skulls makes for superior handling.

THE ELEGANT STRUCTURE OF NATURE BECOMES A BLUEPRINT OF EFFICIENCY.

It seems strange to say that, while we build strong, complex and high-performing machines, we're naturalists at heart. Then again, it might not be that unusual, seeing how nature itself builds strong, complex and high-performing machines as well. When we developed the thinking behind our ultra® lightweight technology initiative,

we knew that nature would serve as an inspiration to greater structural efficiency. Take the structure of the elephant skull pictured here. It has to be lightweight, yet capable of carrying a heavy load. It's porous, but its structure is such that it enhances its stability and strength. We do the same, for example, with aluminum. Positioned one way, aluminum materials can be flexible. Positioned another, they are strong and rigid, and help give better support. We also looked to bamboo, which is strong at the conjoined areas (nodes), and flexible along its stem. Our designs allow for both rigidity and flexibility where each is most needed, and for efficiency overall. As we continue to develop strategies to improve the performance aspects and efficiency of our vehicles, we don't shy away from the world around us? We boldly engage it even closer still.

1. Features and technologies listed are not available on all models. 2. See www.fueleconomy.gov for EPA estimates and emissions data. Your mileage and emissions will vary and depend on several factors, including your driving habits and vehicle condition.

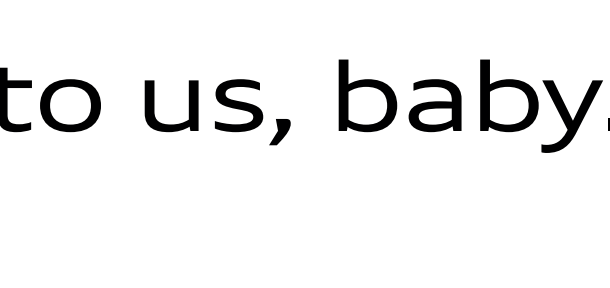

Just talk to us, baby.



AUDI CONNECT® REALLY GETS WHAT YOU ARE SAYING.

Share what's on your mind. Looking for a great Chinese food place? We'll help you get there. Thinking about a rest stop? We'll locate the nearest gas station for you, and even give you the price of their fuel. In fact, in your Audi, just say the word, and we'll help you find almost anything, even your home phone number. With available Audi connect with Google

Voice™ command capabilities, we've developed a way to let you articulate your desires, even if that's just finding the closest burger stand or the best hotel.¹ MMI® navigation plus with Audi connect helps integrate networking capabilities on the go, along with Google Earth™ with 3D satellite imagery, to help you avoid traffic (and possibly saying things you might regret)² Audi connect also provides fast data transfer speeds and Wi-Fi® connectivity for up to eight passenger devices to help you stay informed. It offers a full suite of services and interactivity, and, yes, even the closest Szechuan restaurant, which you can find by using its Google™ Local Search capabilities. Best of all, you don't even have to say "Thank you," even if we appreciate it when you do.

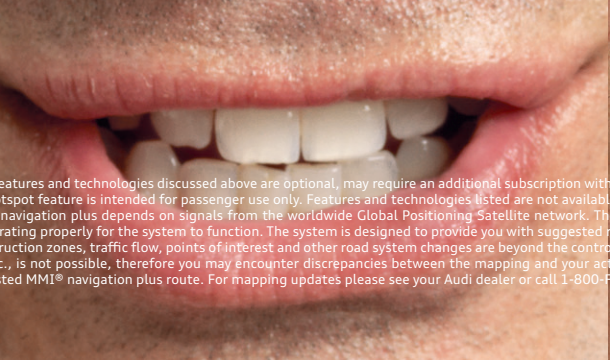
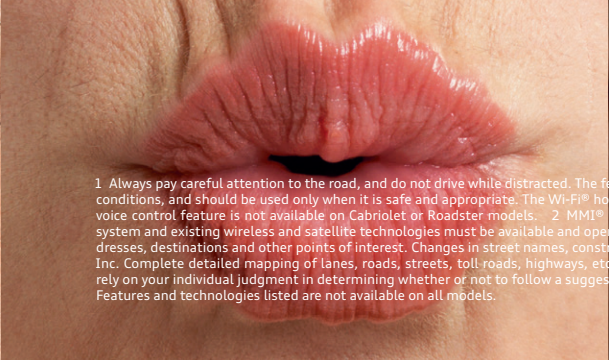
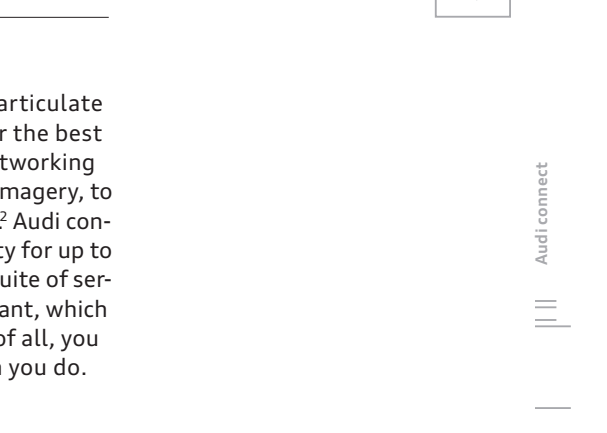
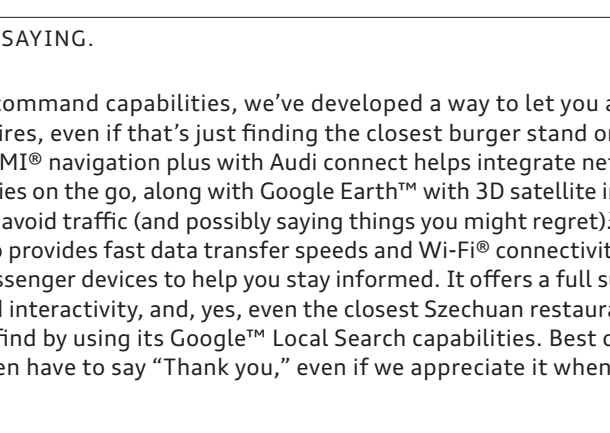
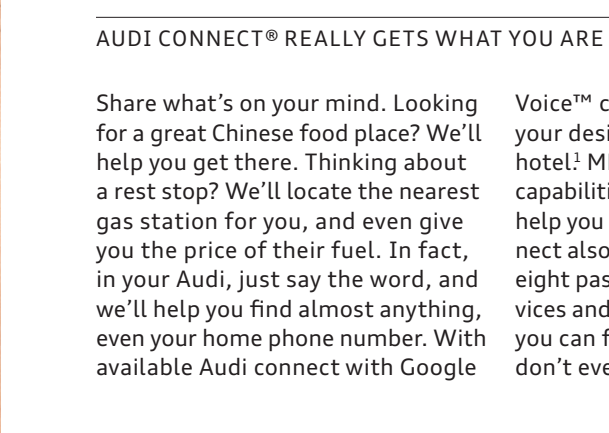

1. Always pay careful attention to the road, and do not drive while distracted. The features and technologies discussed above are optional, may require an additional subscription with separate terms and conditions, and should be used only when it is safe and appropriate. The Wi-Fi® hotspot feature is intended for passenger use only. Features and technologies listed are not available on all models. The voice control feature is not available on Cabriolet or Roadstar models. 2. MMI® navigation plus depends on signals from the worldwide Global Positioning Satellite network. The vehicle's electrical system and existing wireless and satellite technologies must be available and operating properly for the system to function. The system is designed to provide you with suggested routes in locating addresses, destinations and other points of interest. Changes in street names, construction zones, traffic flow, points of interest and other road system changes are beyond the control of Audi of America, Inc. Complete detailed mapping of lanes, roads, streets, toll roads, highways, etc., is not possible, therefore you may encounter discrepancies between the mapping and your actual location. Please rely on your individual judgment in determining whether or not to follow a suggested MMI® navigation plus route. For mapping updates please see your Audi dealer or call 1-800-FOR-AUDI for details. Features and technologies listed are not available on all models.



Hey, bright eyes.



DESIGNING A WINDOW TO OUR SOUL.

Even in the dark, you know when you're staring at an Audi. In fact, it might just be love at first sight. That's because, instead of cursing the darkness, we celebrate the light. Available full LED headlights stand out from the rest: their color inten-

sity is engineered to be reminiscent of daylight. But while we illuminate the night, we don't forget the day—so we made our LED daytime running lights to look even more dramatic. Now featuring a sleek diode design that gives us the freedom to elegantly reshape our signature style, Audi LED lighting is once again ours. It is an efficient, beautiful way to help you see and be seen from dusk to dawn and back again. Look deep into our eyes, and you might just see the soul of a company.



How we know exactly what you feel.

CLEAN, BEAUTIFUL DESIGN COMES FROM DEDICATED CRAFTSMEN UNAFRAID OF GETTING THEIR HANDS DIRTY.

Our hands give you shade and sanctuary. Our hands give you comfort and control. You might not sense our hands nearby, but our hands know exactly what you feel. That's because we've been there. After all, our hands crafted a customized world that's dedicated to control, comfort and entertainment. We're talking,

of course, about the cabin of your Audi vehicle. Optimized luxury, designed by committed craftsmen who had you in mind when they chose the leather seating surfaces, created the contoured seats or provided the refinement of ergonomic design and an available more intuitive MMI® system. There are small touches that help simplify the overall design, and there are large statements to help you feel at ease. It is your Audi interior, shaped by the kind of people who know you want to experience luxury firsthand.



As you can see, our design will help channel water away from the mirror, allowing you a clearer view of what's behind you.



The molding on the inner A-pillar helps direct water away from the area where the windshield and A-pillar meet. Once the water is there, aerodynamic forces take over and funnel the water up and out of the windshield area rather than back and across the side windows.

You have to weather adversity to know things like this.

WHAT YOU DON'T KNOW MIGHT HELP YOU.

Think of it this way—if it rains, would you notice a dry side view mirror? Maybe not, but compared to one with beads of rain on it and distorted reflections, you would. It's a little thing, perhaps, but these little things are part of our deep obsession with crafting a premium driving experience.

We design our exterior side mirrors with small sills to channel water along their upper edge, helping leave your view unobstructed. We also design our windshield moldings with channels that allow rain water to efficiently run off instead of returning to the windshield wiper path. These are small touches, thought of by engineers and crafted by designers who don't necessarily call attention to their skills. Instead, these details reflect a commitment to quality that you might never notice—until a moment of bad weather or adversity, when you might. But don't worry. We don't mind if you don't notice us, now and then.



Either think about the future, or make history.



e-tron

e-tron®



SUPREMELY PRACTICAL LUXURY WITH A SUNNY KIND OF ENERGY.

Talking about a better future is easy. After all, how can you be held accountable for something that never arrives? But if you really want to affect it, to make history, you have to do more than talk. Enter e-tron®. It's not the first plug-in electric hybrid to the market, but we are making it the most forward-thinking Audi ever produced. For example, we will be including a

level 2 charger with our A3 Sportback e-tron PHEV for owners who want to drive on electricity as much as possible. We also plan to offer unique sustainable energy offerings like an available solar powered connection to your charger. It's not just practical, it's premium too, in style, in performance and in fit and finish, like any other Audi vehicle. The A3 e-tron will be able to take on the average daily commute on electric-only before the efficient 1.4 TFSI® gas engine is needed.¹ But more than that, it will be Audi making smart technology smarter, with innovative kinetic-energy-harnessing when you brake, and better performing than what came before it. With the Audi e-tron vehicles, we're saying the future is now.

¹ Preliminary manufacturer's estimates.

Pre-production vehicle shown.



The little things that add up

01 Audi connect
Our Google™ powered information system.¹

02 Audi Care
Available convenient service option.

03 MMI updates
MMI navigation and other software updates.¹

04 SiriusXM® Satellite Radio
Endlessly diverse music channels with a complimentary trial offer.¹

05 Audi exclusive
Available customizable exterior and interior color and material options.

SENSE OF HUMOR

RESOURCEFUL

ROMANTIC

SENSE OF STYLE

GENEROUS

LOVING



to a long-term love.

MOVING FROM LUST TO APPRECIATION TAKES A DEEPER UNDERSTANDING.

When you are attracted to something, the effects are immediate, the domination, total. For a relationship to last, though, it must move beyond that passionate initial phase. It's what comes next that turns a bright flame into an eternal torch. That's why Audi doesn't simply design premium vehicles for the

short-term, but offers an entire experience that we hope lasts a lifetime. Do you want to customize your Audi? We offer Audi exclusive materials and colors. Do you want care-free service options? Audi Care is available. MMI® updates, trial offers for Audi connect®, a full suite of available Audi driver assistance technologies—these might not be the reasons why you fell in love with an Audi, but they are, perhaps, the things that help keep the heart fires stoked.¹

¹ Optional features and technologies listed are not available on all models. See Infotainment/Technology section of the Featured Content page for important information regarding MMI® navigation plus and required SiriusXM® subscriptions.

HAVING
IS TRUTH FOR
THE **Q7**, SPACE
IMAGINATION

Inspirations that build an icon.

The alchemy needed to build an automotive icon is elusive. Sure, it's found, partly, on an assembly line, with committed artisans taking pride in every stitch they oversee. It's also on a drafting board, sketched by visionaries looking to further expand what we look for in automotive design lines. But it's also in the countless inspirations, ones little and large, that not only capture a bold thought or striking idea, but execute them. Examples of these can be found in the foundational stories we tell about our company and our vehicles. These stories show how an abstract idea can turn into a powerful, sculpted machine, and then how that machine can help forge an iconic reputation for a brand. Out of the inspirations we find in engineering, art and the large world of ideas, we have created a fearless, iconic company of substance and luxury: Audi.

EXPAND,
A BIGGER
FOR YOUR

ENOUGH ROOM
GROWTH. IN
GIVES YOUR
A CHANCE TO
ENGINEERING
NARRATIVE
ROAD AHEAD.



Design

We do not follow design trends. We set them.

Luxury and utility

loom large in our world.

It's no coincidence the Audi Q7 accommodates more than one great quality. You see, the idea Audi engineers had while designing the Q7 was to create a beautifully styled limousine for seven, with the SUV versatility you'd expect. And while limousine may sound like an exaggeration, this is the kind of luxury not normally found in an SUV. It may be the grain of the burled Walnut Wood inlays, or the standard leather seating surfaces that are as inviting to the eye as they are comfortable to the body. Perhaps it is the available Audi connect® with mobile Wi-Fi®¹ for up to eight passenger devices, the rest of the technological suite available in this vehicle, the standard quattro® all-wheel drive, or the variety of engines you can choose from to power it. Whatever it is, you might feel a bit spoiled as you drive down the highway, but we don't think there is anything wrong with that.

¹ Always pay careful attention to the road, and do not drive while distracted. The features and technologies discussed above are optional, may require an additional subscription with separate terms and conditions, and should be used only when it is safe and appropriate. The Wi-Fi® hotspot feature is intended for passenger use only.



Enlighten

A new light on illumination just happened to be a design boon.

There's more than a little brilliance on display.

For most people, the sport utility vehicle is for sport and utility. At Audi, we feel the same way, but that doesn't mean you and your party don't deserve style, nor does it mean you have to compromise your need for performance. We constantly strive to illuminate the automotive world with new efficiencies and design philosophies. See, at Audi, we don't think being enlightened is enough—we also need to be enlightening. It's part of why you'll see the signature LED daytime running lights leading the Audi Q7. And why the available Offroad Style plus package, featuring stainless steel underbody protection and impressive 20" or 21" wheels, ensures that you'll stand out brilliantly in any crowd. It's just another part of the attention we pay to the balance and composition of every vehicle we make.



A retreat of considerable magnitude.

If you're going to spoil yourself, why not do it in a big way? That was our intention when we dressed the seven-passenger Audi Q7—all 144.1 cu ft of its interior space—to the nines. Beautiful leather seating surfaces, Walnut Wood inlays and plush carpeting adorn the interior, complementing one another perfectly, and elevate the interior of the Q7 into a truly magnificent space. Add in the many combinations of exquisite interior choices, and you can see why getting away from it all is something we take seriously.

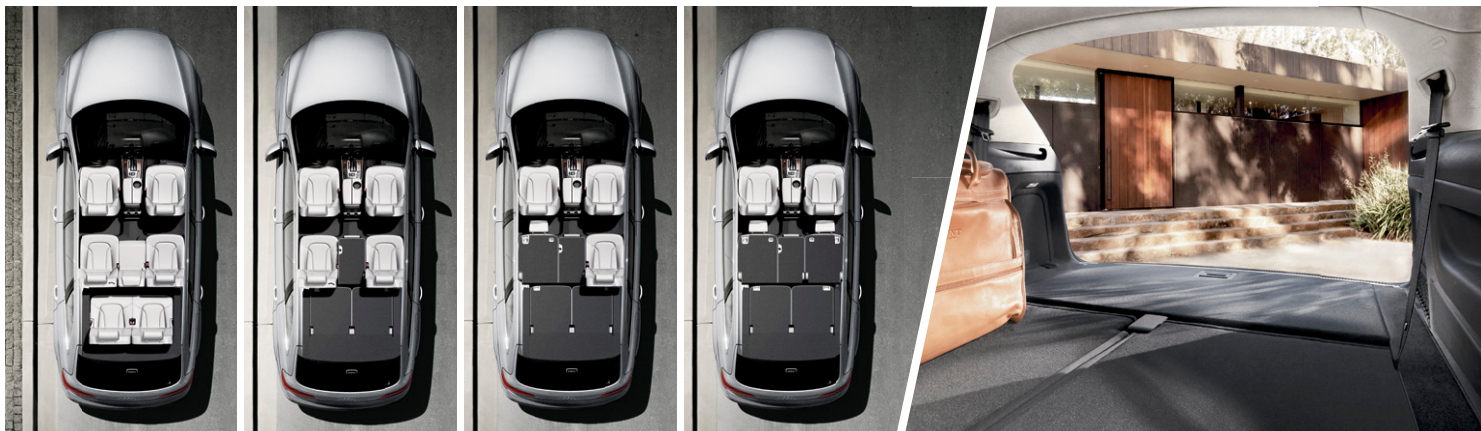

Seven seats

We also take comfort seriously for all seven potential occupants in the Q7, with sumptuous, supple leather seating surfaces and 12-way power adjustable front seats, as well as reclining and sliding second-row seats. We take functionality seriously too, with second- and third-row seats that can be easily folded (without removing the head restraints) to provide extra cargo capacity, while an overall design flexibility allows for 28 possible seating and cargo configurations.

Cargo capacity

Perfect for the family road trip or the golf weekend, the Q7 brings the goods when it comes to bringing the luggage. With 10.9 cu ft of cargo capacity behind the third row, and up to 72.5 cu ft with the second and third row folded down, there's room for just about anything you'd want to pack, and most likely room to spare. Leaving you with only one worry—where you want to go.



Standard in the second- and third-row outboard seating positions, the Lower Anchors and Tethers for Children (LATCH) system, combined with the possibilities offered by the Q7 seating configurations, gives you flexibility when your children are your passengers.



Ventilated front seats

Available front seat ventilation offers multiple speeds of cooling, which, along with front seat-back nets and useful storage compartments in the doors, center console and cargo area, provides comfort and convenience throughout.

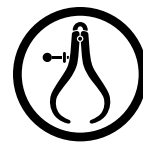

Craftsmanship

We've ensured that every stitch represents the detail that we put into every aspect of an Audi vehicle.

The small touches that make up a grand gesture.

When a statement as impressive as the interior of the Audi Q7 is made, it's easy to forget that it's the details that are ultimately responsible for ensuring that it makes an impact. Luxurious touches, like a generously sized, leather-wrapped steering wheel, supple leather seating surfaces and soft-touch materials throughout, provide a worthy, and plush, starting point, while offering a glimpse of our unwavering dedication to craftsmanship. Further embellishing this detail-obsessed mantra is the elegant Alu-optic trim, perfectly positioned around the dash, as well as the beautifully appointed leather armrest and shifter. Include available features that let you do everything from fine-tune your personal comfort to bask in stunning natural light, and what you have is a truly compelling sum that owes everything to its meticulously crafted parts.



Four-zone automatic climate control

The available four-zone automatic climate control has four distinct climate zones. The driver, front passenger and second-row outboard rear passengers can set their perfect level of heating or cooling with a simple twist of a dial.



Panoramic sunroof

The available panoramic sunroof brings seemingly endless light to your ample interior cabin. The front and rear glass elements can be tilted, the front panel can be opened and, if you should need a break from the sun, the sunroof features a power sunshade in the front and a manual sunshade in the rear.

A gripping story of twists and turns.

The luxurious Q7 was designed with unruly roads in mind. That means, luxury aside, those gravel-strewn switchbacks and steep, graded highways are natural terrain for the quattro® all-wheel drive system. The quattro® system is designed to help provide maximum grip and optimized power delivery for practically all road conditions. So while your commute may not be as thrilling as a trip to the summit, you can be confident in the balance and enhanced performance quattro® offers day-in and day-out, while giving you no good excuse for taking a snow day.¹

quattro

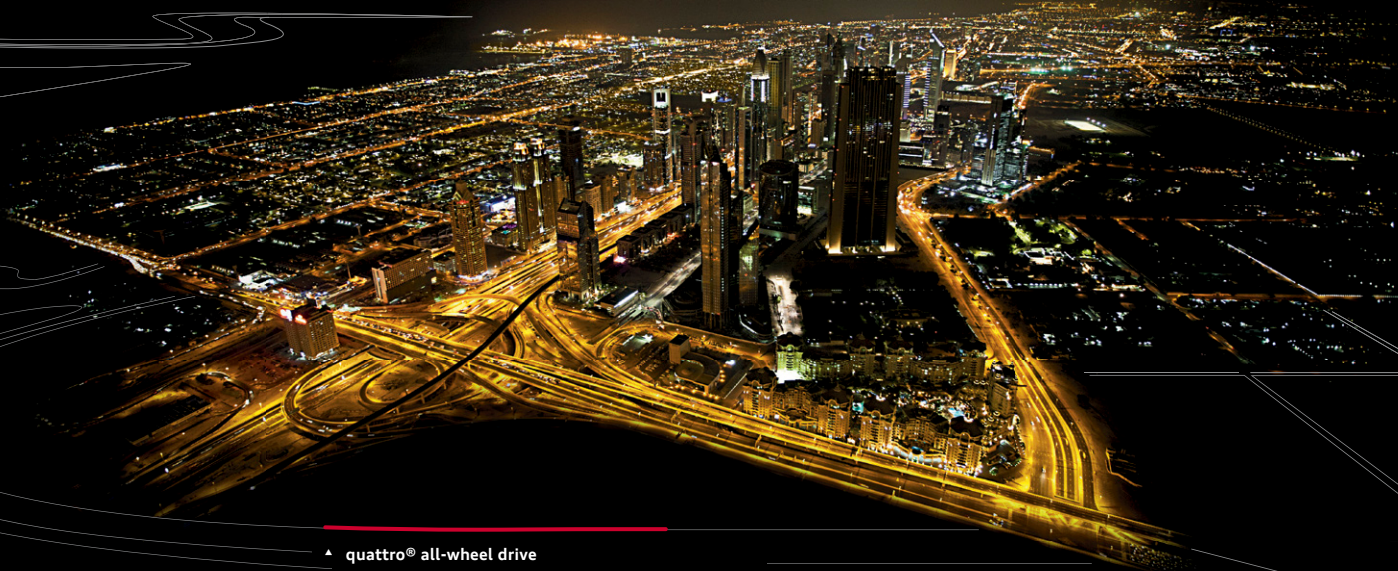

▲ quattro® all-wheel drive

With quattro®, the Q7 can “read” the road, sensing changes in the surface beneath the wheels and adjusting their grip accordingly. So when driving conditions become more demanding, quattro® adapts to deliver precisely distributed power to where it’s needed to handle the change in the terrain.

◀ All-around confidence

Just like life, the road can throw you a curve. So throw one right back with the superior grip and control of quattro® all-wheel drive. It helps provide the legendary performance and confidence you would expect from Audi, no matter if you’re commuting in the city or crisscrossing the country. This is advanced engineering you can live with.

▼ Seasonal stability

There is a reason quattro® all-wheel drive is a friend in foul weather.¹ Under normal driving conditions, the center differential splits torque at a ratio of 40:60, front to rear, but as conditions change and become more challenging, the ratio is optimized to help maximize grip.

¹ When driving during cold, rainy, snowy or icy weather conditions, ensure that your vehicle is equipped with appropriate all-season or winter tires. Even with appropriate tires, you must always drive in a manner appropriate for the weather, visibility and road conditions.

Tell us what you're looking for and we'll deliver you to it.

Don't reach—relax. While touchscreens are seemingly everywhere, they don't need to be in your vehicle. With available Audi connect®, you may never have to reach out again.¹ Thanks to Google Voice™ Local Search, Audi connect allows you to quickly search Google™ by simple voice commands (use only when the car is stationary).¹ The crisp display is mounted farther up, closer to the windshield and near your sight line to the road ahead. For those times when you are feeling tactile, we've placed toggle buttons near the gear shifter, where your hand naturally rests when using them. So while other automobile manufacturers still want you to reach out, we've found a few ways for you to make information a lot more accessible while your hands are on the wheel.¹

POI

Point-of-interest

The point-of-interest search with voice control means that the digital world is with you on every journey.¹

myAudi

myAudi features

Plan travel from your personal computer. Send your desired destinations to your vehicle ahead of time and access your route from your vehicle later.¹

NEWS

News feeds

Stay on top of the news by having headlines and stories delivered right to your MMI® display.¹



Mobile Wi-Fi® hotspot

Provides high-speed connectivity for up to eight passenger devices through an onboard wireless hub.¹



SiriusXM® Traffic

Get traffic information overlaid onto available 3D satellite imagery to visualize a true aerial view of your route, and let the MMI navigation plus system reconfigure your route to help avoid traffic.^{1,2}



Google Earth™ with 3D satellite imagery

With Google Earth™ integration, you'll enjoy 3D satellite imagery, including Google Maps Street View, displayed right on the MMI display.¹



Weather information

Current local conditions and forecasts for your destination can help you prepare for your trip.¹



Google Voice™ Local Search

Simply tell your Audi what you are in the mood for, then let the cloud-processing power of Google™ speech recognition interpret your request and bring up a list of destinations in the area of your choice.¹



Google Maps Street View

With Google Maps Street View, your vehicle can show you a driver's-eye view of your destination right before you arrive so it's easy to recognize!¹



Parking information

Search for parking in your area of interest, check space availability and set your selection as a destination to help navigate directly to the garage entrance.^{1,3}



City events

Get information about current events, exciting locations and places of interest at your travel destination, current location or other chosen location instantly.¹



Travel info

Discover local landmarks in your area of interest, set them as your destinations, and let your vehicle lead the way as you explore the world around you!¹

¹ Always pay careful attention to the road, and do not drive while distracted. The features and technologies discussed above are optional, may require an additional subscription with separate terms and conditions, and should be used only when it is safe and appropriate. The Wi-Fi® hotspot feature is intended for passenger use only. ² See Infotainment/Technology section of the Featured Content page for important information regarding MMI® navigation plus and required SiriusXM® subscriptions. ³ Parking feature is not available everywhere and requires participation by parking provider.



Sound

Audi is Latin for "listen," so you know we take sound very seriously.

52 Hz

Low note on a kick drum

True bass tones are something you feel more than hear, and when a kick drum hits you with a frequency of 52 Hz, you definitely feel it. Knowing this, Audi sound engineers worked to reproduce sounds at this level for an exceptionally realistic experience.

2,093 Hz

High note on a piano

Even at a frequency of 2,093 Hz, the equivalent of the double high C note found on a piano, the sound system clearly and effortlessly reproduces the sound, giving you front row seats to every symphony.

261 Hz

Singing middle C

At a frequency of around 261 Hz, you'll find middle C. It is around this frequency that much of the brilliantly orchestrated sound is reproduced by the numerous, strategically placed speakers.

Lend us your ear.

It's been said that people only hear what they want to. That what they don't like just goes in one ear and out the other. Well, for those people and everyone else, we've created a sound system that makes every note worthy of your eardrum's full attention. From perfectly sculpted high notes to a crystal clear mid-range to deep-diving lows, the available Bang & Olufsen® Advanced Sound System is a veritable orchestra of engineering that fills the cabin with faithfully rendered, thrilling sound. Which shouldn't be surprising at all, considering that Bang & Olufsen® and Audi sound engineers worked tirelessly to craft a perfect acoustic environment, and the ideal delivery system for it. So whether you're the type that wants to be soothed by sound or the type that wants to be inspired by it, we promise, if you take a moment to listen, that what you'll hear will be utterly impossible to ignore.

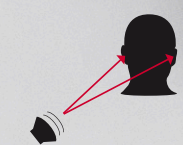
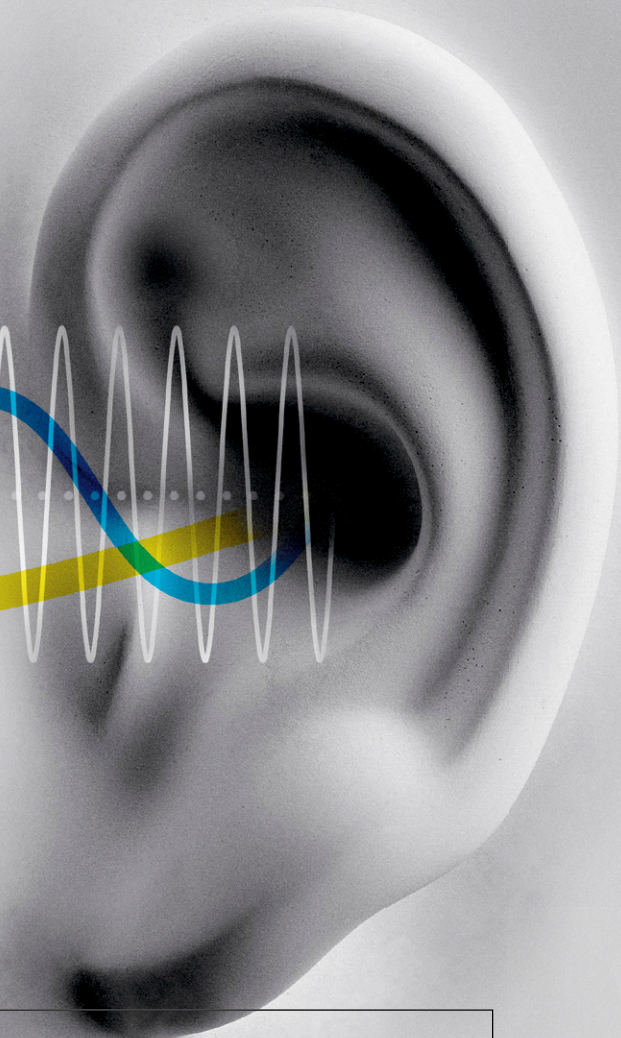

Unlike with high-frequency sounds, the brain cannot detect where low bass frequencies are coming from, making it seem as if the sound is hitting both ears at the same time. Because of this, Bang & Olufsen® sound engineers only had to design one custom-fitted subwoofer to reproduce the kind of deep, cabin-filling bass that brings music to life.



Bang & Olufsen® Advanced Sound System

Dedicated to the idea of "precise music reproduction," Bang & Olufsen® has created a sound engineer's dream. An available 1,000-watt advanced sound system brilliantly re-creates music using 14 enclosed speakers, including two acoustic lens tweeters, placed throughout the cabin. The system features revolutionary smartphone-sized ICEpower® amplifiers to supply power to all 14 speakers. Bang & Olufsen® is set on music reaching your ears by transcending the limits of audio technology. In other words, they design systems for the human heart as much as for the human ear.

BOSE® Surround Sound System

Hitting the right note on every drive, the available BOSE® Surround Sound System turns your Audi into a 14-speaker powerhouse with the help of innovative sound engineering and optimized speaker placement. Add to that AudioPilot® noise compensation, which helps maintain a consistent volume under varying speeds and road conditions, and you get an acoustic listening environment that rivals any live performance.

We take efficiency lightly.

Another way we continue to share Truth in Engineering® with Audi fans across the world is by building power and performance from all our engines without compromise. With the options of two supercharged and lightweight V6 engines, and one TDI® clean diesel, we've done just that. It's fair to say the Audi Q7 gives you more out of less with every drive.

Induction technology—TVS supercharger

Compressing the airflow to the engine allows more air into the cylinder and, ultimately, more power from each combustion cycle, helping to improve the engine's power-to-displacement ratio.

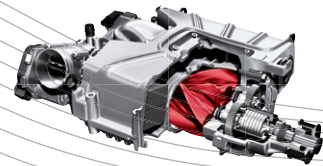

280–333 horsepower 295–325 lb-ft of torque

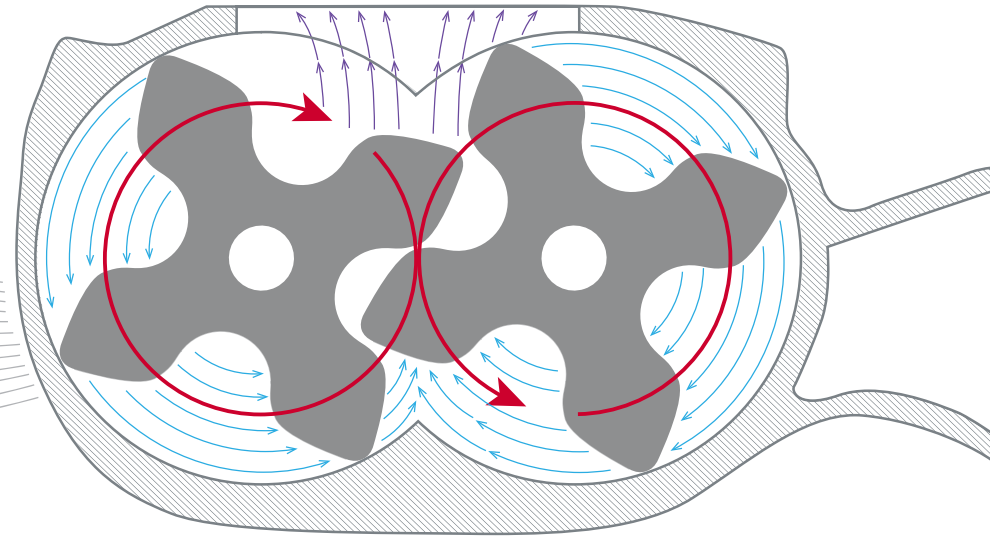

Four-vane w/160° twist



Three-vane w/60° twist

↑ ↑

More twist for power

Modern supercharger rotor-vanes have a 160° twisted shape for higher pressures and improved efficiency. And by using a four-vane design instead of a three-vane design, thermal efficiency and air-handling characteristics are improved without increasing the size of the supercharger unit.

3.0-liter TFSI® V6

Bolstered by the lively 3.0-liter TFSI V6 that produces 280 hp and a strong 295 lb-ft of torque, the Q7 starts with strength that comes standard. More performance-driven types can choose the S line® Prestige model with the 333-hp supercharged 3.0-liter TFSI V6 that generates an immense 325 lb-ft of torque.

Eight-speed Tiptronic® automatic transmission

As the perfect compromise between a dedicated manual and an automatic gearbox, the eight-speed Tiptronic® automatic transmission in the Audi Q7 offers eight optimized, carefully chosen gear ratios. Selected automatically or via its console-mounted shifter or steering wheel with available shift paddles, precise shifts are delivered without sacrificing the smooth action of the Tiptronic® automatic. A high final drive ratio allows optimization of lower gears, yet the transmission's upper range emphasizes lower engine rpm—particularly at highway speeds.

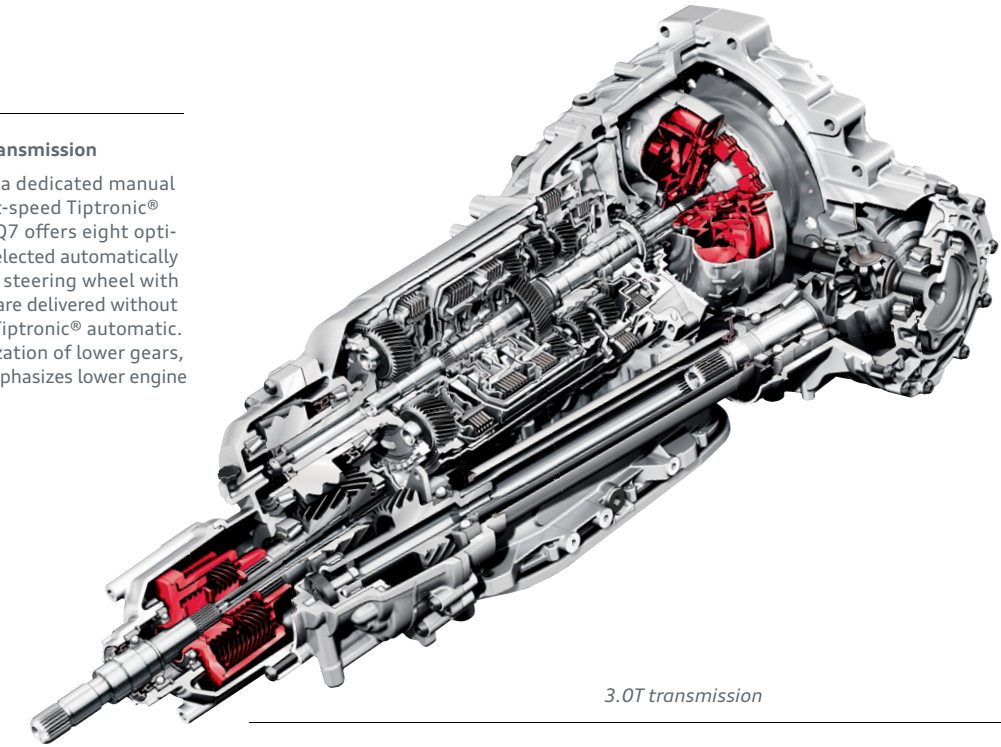

3.0T transmission

gear	ratio
1ST	4.845:1
2ND	2.840:1
3RD	1.864:1
4TH	1.437:1
5TH	1.217:1
6TH	1.000:1
7TH	0.816:1
8TH	0.672:1



Performance

The adage "good things come in small packages" has never been more true.

You've never seen rugged drive so smooth.



Though we've long been in the business of luxury vehicles, we didn't want to leave you without an option for the less conventional journey. Hitting the slopes or heading out for a weekend in the desert isn't for the faint of heart, and we designed a utility vehicle geared to match the passion you have for the outdoors. But there's more to it than just grit, because we know you'll also be driving in the city—so we gave utility the black-tie treatment. Powerful yet elegant, the Audi Q7 gives you the power you need to take on those exciting trips, as well as the look and feel of a daily city driver. An eight-speed Tiptronic® automatic transmission helps ensure that you're getting optimum power delivery, and a variety of engines to choose from gives you the flexibility to make the drive suit your many needs.

Fuel for thought.

We thought you should know: Diesel sports a greater power density than traditional gasoline, which means that a gallon of diesel fuel has about 15% more energy than a comparable amount of gas, and combusts more efficiently in the engine. The TDI® clean diesel engine available in the Q7 has achieved ultra-low emissions vehicle (Bin-5/ULEV II) status in all 50 states while producing approximately 7.0% fewer CO₂ emissions than its comparable gasoline-fueled engine.¹ And the brainy attributes don't hide the brawn—in fact, Audi has dominated the 24 Hours of Le Mans over the years with TDI® prototype race cars. With these facts in mind, maybe you are thinking that a TDI® might be your choice—which goes to show that clean diesel really is fuel for thought.

→ → → TDI® clean diesel

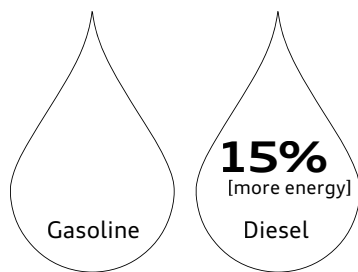

↑ ↑

Diesel packs more energy

On average, one gallon of diesel contains about 147,000 BTUs, versus 125,000 for gasoline.

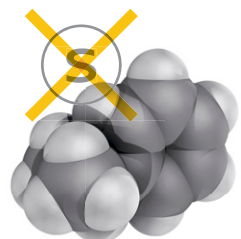

↑ ↑

Making diesel cleaner

A new refinement process has reduced sulfur in diesel fuel by more than 97% in years past.

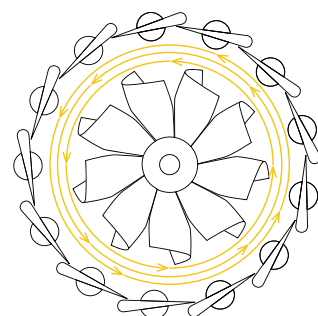

↑ ↑

Variable vane turbocharger

Adding turbo power to clean diesel engines, our variable vane turbocharger produces impressive torque punch at mid-range highway speeds.²

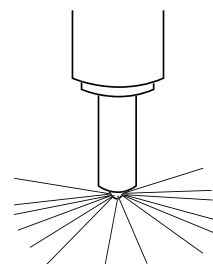

↑ ↑

Piezo direct injection

Precise injections help lower the combustion noise normally associated with diesel engines, while optimizing the distribution of fuel in the combustion chamber, helping to further reduce exhaust emissions.

↓ ↓ mileage	↓ ↓ range	↓ ↓ torque
19 city/28 highway/22 combined mpg³	Up to 501 (city) or 739 (highway) miles per tank⁴	406 lb-ft of torque along with 240 hp from the 3.0-liter TDI® clean diesel V6

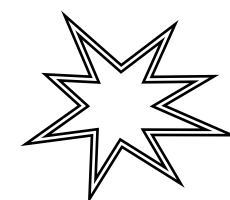

↑ ↑

Combustion

Combining a high compression ratio with direct injection makes combustion more efficient, and produces emissions cleaner than those of engines with a lower compression ratio.

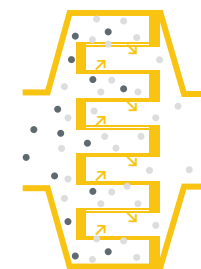

↑ ↑

After-exhaust treatment

With innovative diesel particulate filters and the nontoxic AdBlue® reducing agent, we help eliminate up to 95% of diesel NO_x emissions.

up to
22%
better efficiency

↑ ↑

Increased fuel efficiency

Another way diesel creates fewer emissions is that it gets better mileage, up to 22% more mpg than comparable gasoline engines, in fact.⁵

There is more information on the TDI® clean diesel model line in the 2015 TDI® clean diesel brochure. For details, see your dealer, go to audiusa.com or download the digital brochure from the Audi library app.

¹ 7.0% fewer CO₂ emissions based on 2015 EPA emissions data versus its comparable gasoline-powered model. See www.fueleconomy.gov for details. Your vehicle emissions will vary, and depends on several factors, including your driving habits and vehicle condition. ² Always obey all speed and traffic laws. ³ 2015 EPA estimates. Your mileage will vary, and depends on several factors, including your driving habits and vehicle condition. See www.fueleconomy.gov for details. ⁴ 19 city/28 highway mpg (2015 Q7 3.0-liter TDI® clean diesel V6 with eight-speed Tiptronic® automatic transmission and quattro® all-wheel drive). 2015 EPA estimates. Range based on EPA estimates of 19 mpg city/28 mpg highway and a 26.4-gallon fuel tank. Your mileage will vary, and depends on several factors, including your driving habits and vehicle condition. ⁵ 22% better mileage over comparable gasoline engines is based on 2015 Q7 TDI® model's 22 combined mpg as rated by the EPA vs. the EPA-rated gasoline-powered equivalent. Your mileage will vary, and depends on several factors, including your driving habits and vehicle condition.



Driver Assistance

We're solving problems before you even know you have them.

A little insight into the things you cannot see.

Audi strives to constantly up the ante on the driver assistance tools built right into the vehicle. Whether it's Audi side assist, which helps inform you if there are vehicles in the lanes next to you, or something as simple as our corner view camera system, which gives you a panoramic view of your surroundings as you park, it's another testament to the effort that Audi puts into helping to keep you safe. All of this, along with six standard airbags,¹ shows the effort we put into helping ensure that you're not the only one keeping an eye on the road.



Dramatization²



Parking system plus with corner view cameras

Helping to make parking a significantly easier task, the available parking system plus features front and rear acoustic parking sensors, as well as an available corner view camera system that gives you a panoramic view of what is ahead. For added benefit, the rear view camera offers selectable guidelines for parking in parallel or perpendicular spaces.

Six standard airbags

With six standard airbags that include front-impact, front side and side curtain airbags for both driver and outboard passengers and available rear side airbags helping protect the second-row outboard occupants, for an available airbag total of up to eight, you'll feel practically surrounded.¹ And that's a good thing.

The available **Audi side assist** uses radar sensors and two different optical warnings to help keep the driver informed about what is approaching from hard-to-see angles behind and to the side of the vehicle.



¹ Airbags are supplemental restraints only and will not deploy in all crash circumstances. Always use safety belts and seat children only in the rear, using restraint systems appropriate for their size and age. ² This is a dramatization and does not depict what will happen in a collision. All bags will not inflate simultaneously in real-world collisions, and, if multiple bags do deploy, they will be in various stages of inflating/deflating and will never all be inflated at the same time.

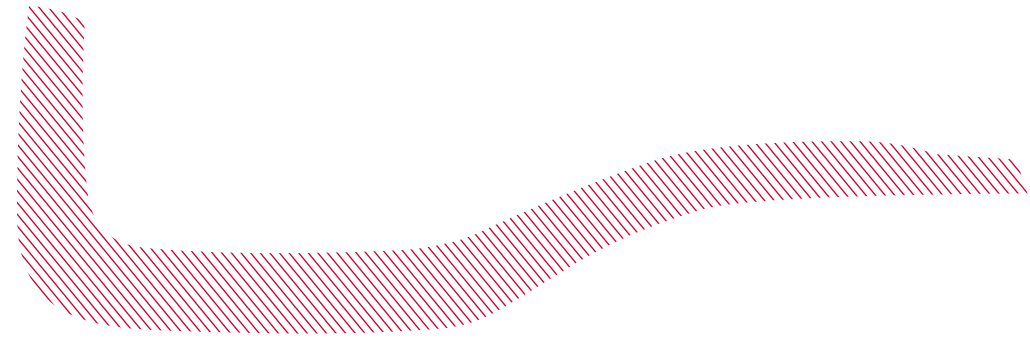

LED taillights

LEDs are among the most luminous taillights available. And, like Audi vehicles, they are efficient, technologically advanced and long-lasting.

Enlightening to the very end.

Parting is no longer just about saying goodbye—it's about expressing it in a brilliant way. Beautiful LED taillights on the Audi Q7 ensure that you'll always leave people in want, whether you're backing out of your garage or pulling away in the passing lane. This is even more true when you opt for the Sport Style plus package, featuring oversized dual oval exhaust outlets that are beautifully integrated into the lower bumper. And while we might be talking about what you see when the vehicle leaves, there is still much more to experience, so the next steps to ensure that you never have to say farewell to the Q7 again are up to you.

3.0T Premium

Q7 3.0T Premium featured highlights

- ▶ Xenon plus headlights with LED daytime running lights
- ▶ Front and rear fog lights
- ▶ LED taillights
- ▶ Power-adjustable heated exterior side mirrors
- ▶ Aluminum roof rails
- ▶ Aluminum trim around exterior windows
- ▶ Power tailgate
- ▶ Body color lower body paint finish with chrome accents
- ▶ Flat-bottom dual exhaust outlets with polished tips
- ▶ Dual-zone automatic climate control
- ▶ Four-spoke multifunction steering wheel
- ▶ Auto-dimming interior rear view mirror with compass
- ▶ Leather-wrapped shift knob
- ▶ Folding front center armrest with height adjustment
- ▶ Ten beverage holders (six cup and four bottle)
- ▶ Front and rear footwell LED lighting
- ▶ Ambient LED interior lighting
- ▶ Power windows with one-touch up/down operation and pinch protection
- ▶ Leather seating surfaces
- ▶ Twelve-way heated power front seats, including power lumbar adjustment
- ▶ Sliding 40/20/40 split folding second-row seatbacks with pass-through and adjustable recline
- ▶ Split folding 50/50 third-row seatbacks with collapsible head restraints and one-action lowering from cargo area
- ▶ Audi premium sound system with 11 speakers and a single CD player with MP3 playback capability
- ▶ SiriusXM® Satellite Radio with 90-day trial subscription¹
- ▶ Audi music interface with iPod® integration
- ▶ BLUETOOTH® wireless technology preparation for mobile phone²
- ▶ Garage door opener (HomeLink®)
- ▶ Cruise control with coast, resume and accelerate features
- ▶ Parking system with rear acoustic parking sensors
- ▶ Rain/light sensor for automatic windshield wipers and headlights

Available packages and stand-alone options

(for more details, refer to the Packages and Options pages)

- ▶ Cold Weather package
- ▶ Technology package
- ▶ Towing package
- ▶ Panoramic sunroof
- ▶ Rear-passenger thorax side airbags³
- ▶ 19" 5-arm structure design wheels



Seating for seven passengers



Xenon plus headlights with LED daytime running lights



LED taillights



Walnut Wood decorative inlays



18" 6-arm design wheels with 255/55 all-season tires

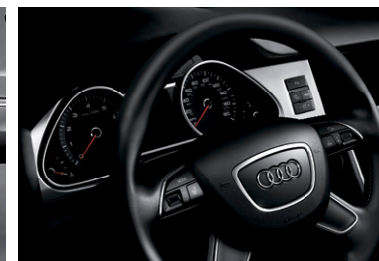

Four-spoke multifunction steering wheel



Aluminum roof rails



Up to 72.5 cu ft of cargo space⁴



MMI® display



¹ SiriusXM Satellite Radio and SiriusXM Traffic subscriptions are sold separately or as a package after trial period and are continuous until you call SiriusXM to cancel. See Customer Agreement for complete terms and more information at www.siriusxm.com. SiriusXM Traffic service available in select markets. SiriusXM U.S. Satellite Service available only to those in the 48 contiguous U.S.A., D.C. and Puerto Rico (with coverage limitations). ² Requires compatible device. ³ Airbags are supplemental restraints only and will not deploy in all crash circumstances. Always use safety belts and seat children only in the rear, using restraint systems appropriate for their size and age. ⁴ All cargo should be properly secured before driving the vehicle. See your owner's manual for details.

3.0T Premium Plus

The following highlighted features of the Q7 3.0T Premium Plus add to or replace the highlighted features of the Q7 3.0T Premium.

- ▶ Power-adjustable, power-folding, auto-dimming, heated exterior side mirrors with memory
- ▶ Power tilt and telescopic adjustable steering column
- ▶ Panoramic sunroof
- ▶ Driver seat memory
- ▶ MMI® navigation plus with voice control system¹
- ▶ Audi connect® with six-month trial subscription²
- ▶ Color driver information system
- ▶ BOSE® Surround Sound System with 14 speakers and AudioPilot® noise-compensation
- ▶ HD Radio™ Technology
- ▶ SiriusXM® Traffic with four-year subscription³
- ▶ BLUETOOTH® streaming audio⁴
- ▶ Audi advanced key—keyless start, stop and entry⁵
- ▶ Audi side assist
- ▶ Parking system plus with rear view camera (front and rear acoustic parking sensors)

Available packages and stand-alone options

(for more details, refer to the Packages and Options pages)

- ▶ Cold Weather package
- ▶ Warm Weather package
- ▶ Offroad Style plus package
- ▶ Towing package
- ▶ Rear-passenger thorax side airbags⁶
- ▶ Running boards
- ▶ 19" 5-arm structure design wheels
- ▶ 20" 10-spoke V design wheels
- ▶ 21" 5-arm rotor design wheels (with Offroad Style plus package)



BOSE® Surround Sound System



Audi side assist



Driver seat memory



Walnut Wood decorative inlays



18" 6-arm design wheels with 255/55 all-season tires

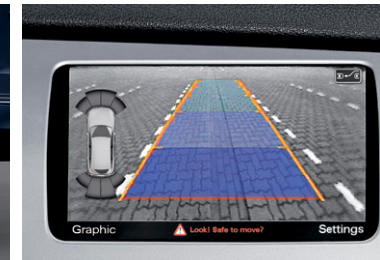

Parking system plus with rear view camera



Panoramic sunroof



MMI® navigation plus¹



Audi connect® online services²



¹ MMI® navigation plus depends on signals from the worldwide Global Positioning Satellite network. The vehicle's electrical system and existing wireless and satellite technologies must be available and operating properly for the system to function. The system is designed to provide you with suggested routes in locating addresses, destinations and other points of interest. Changes in street names, construction zones, traffic flow, points of interest and other road system changes are beyond the control of Audi of America, Inc. Complete detailed mapping of lanes, roads, streets, toll roads, highways, etc., is not possible, therefore you may encounter discrepancies between the mapping and your actual location. Please rely on your individual judgment in determining whether or not to follow a suggested MMI® navigation plus route. For mapping updates please see your Audi dealer or call 1-800-FOR-AUDI for details. ² Always pay careful attention to the road, and do not drive while distracted. The features and technologies discussed above are optional, may require an additional subscription with separate terms and conditions, and should be used only when it is safe and appropriate. The Wi-Fi® hotspot feature is intended for passenger use only. ³ SiriusXM Satellite Radio and SiriusXM Traffic subscriptions are sold separately or as a package after trial period and are continuous until you call SiriusXM to cancel. See Customer Agreement for complete terms and more information at www.siriusxm.com. SiriusXM Traffic service available in select markets. SiriusXM U.S. Satellite Service available only to those in the 48 contiguous U.S.A., D.C. and Puerto Rico (with coverage limitations). ⁴ Requires compatible device. ⁵ Some Audi models are equipped with a keyless ignition feature. The details as to how the system works can vary, and Audi owners should consult their owner's literature or an authorized Audi dealer if they have further questions about the operation of this feature. Please note that Audi warns against leaving the vehicle unattended with the engine running, particularly in enclosed spaces. ⁶ Airbags are supplemental restraints only and will not deploy in all crash circumstances. Always use safety belts and seat children only in the rear, using restraint systems appropriate for their size and age.

3.0T S line® Prestige

The following highlighted features of the Q7 3.0T S line® Prestige add to or replace the highlighted features of the Q7 3.0T Premium Plus.

- ▶ 20" 5-spoke Audi Sport design wheels
- ▶ Adaptive xenon plus headlights with LED daytime running lights
- ▶ Headlight washing system
- ▶ S line® exterior appearance
- ▶ Four-zone automatic climate control
- ▶ Aluminum door sill inlays
- ▶ Manual rear-side window (second row) and tailgate sunshades
- ▶ Panoramic sunroof with deep tint
- ▶ Ventilated front seats
- ▶ Corner view camera system

Available packages and stand-alone options

(for more details, refer to the Packages and Options pages)

- ▶ Cold Weather package
- ▶ Luxury package
- ▶ Towing package
- ▶ S line® Interior package
- ▶ 20" S line® plus package
- ▶ 21" S line® plus package
- ▶ Sport Style plus package
- ▶ Audi adaptive air suspension
- ▶ Bang & Olufsen® Advanced Sound System
- ▶ Running boards
- ▶ Rear-passenger thorax side airbags¹
- ▶ Carbon decorative inlays



Limestone Gray Perforated leather



S line® exterior appearance



Adaptive xenon plus headlights with LED daytime running lights



Aluminum S line® door sills



Walnut Wood decorative inlays



20" 5-spoke Audi Sport design wheels with 275/45 all-season tires²



Parking system plus with corner view camera



Deep tinted panoramic sunroof



Four-zone automatic climate control and second-row seat temperature controls



Front seat temperature controls



¹ Airbags are supplemental restraints only and will not deploy in all crash circumstances. Always use safety belts and seat children only in the rear, using restraint systems appropriate for their size and age. ² High-performance tires are designed for better performance and handling in warm climates. When driving in cold, snowy or icy weather, you should equip your vehicle with four all-season or winter tires, which offer better traction under those conditions. We suggest you use the Audi-recommended winter or all-season tires specified for your Audi. High-performance tires also have a lower aspect ratio that aids performance and handling. Driving over rough or damaged road surfaces, as well as debris, curbs and other obstacles, can cause serious damage to wheels, tires, vehicle body and suspension parts. Be careful to avoid road hazards and reduce your speed, especially if your vehicle is equipped with low-profile tires. Please also remember when making your selection that, while these tires deliver responsive handling, they may ride less comfortably and make more noise than others. Finally, these tires may wear more quickly than other choices. It is important that the inflation pressure is regularly checked and maintained at recommended levels.

TDI® Premium

Q7 TDI® Premium featured highlights

- ▶ 19" 5-arm structure design wheels
- ▶ Xenon plus headlights with LED daytime running lights
- ▶ Front and rear fog lights
- ▶ LED taillights
- ▶ Power-adjustable heated exterior side mirrors
- ▶ Aluminum roof rails
- ▶ Aluminum trim around exterior windows
- ▶ Power tailgate
- ▶ Body color lower body paint finish with chrome accents
- ▶ Flat-bottom dual exhaust outlets with polished tips
- ▶ Dual-zone automatic climate control
- ▶ Four-spoke multifunction steering wheel
- ▶ Auto-dimming interior rear view mirror with compass
- ▶ Leather-wrapped shift knob
- ▶ Folding front center armrest with height adjustment
- ▶ Front and rear footwell LED lighting
- ▶ Ambient LED interior lighting
- ▶ Power windows with one-touch up/down operation and pinch protection
- ▶ Leather seating surfaces
- ▶ Twelve-way heated power front seats, including power lumbar adjustment
- ▶ Sliding 40/20/40 split folding second-row seatbacks with pass-through and adjustable recline
- ▶ Split folding 50/50 third-row seatbacks with collapsible head restraints and one-action lowering from cargo area
- ▶ Audi premium sound system with 11 speakers and a single CD player with MP3 playback capability
- ▶ SiriusXM® Satellite Radio with 90-day trial subscription¹
- ▶ Audi music interface with iPod® integration
- ▶ BLUETOOTH® wireless technology preparation for mobile phone²
- ▶ Garage door opener (HomeLink®)
- ▶ Cruise control with coast, resume and accelerate features
- ▶ Parking system with rear acoustic parking sensors
- ▶ Rain/light sensor for automatic windshield wipers and headlights

Available packages and stand-alone options

(for more details, refer to the Packages and Options pages)

- ▶ Cold Weather package
- ▶ Technology package
- ▶ Towing package
- ▶ Panoramic sunroof
- ▶ Rear-passenger thorax side airbags³



Seating for seven passengers



Xenon plus headlights with LED daytime running lights



LED taillights



Walnut Wood decorative inlays



19" 5-arm-structure design wheels with 265/50 all-season tires



Four-spoke multifunction steering wheel



Aluminum roof rails



Up to 72.5 cu ft of cargo space⁴



MMI® display



¹ SiriusXM Satellite Radio and SiriusXM Traffic subscriptions are sold separately or as a package after trial period and are continuous until you call SiriusXM to cancel. See Customer Agreement for complete terms and more information at www.siriusxm.com. SiriusXM Traffic service available in select markets. SiriusXM U.S. Satellite Service available only to those in the 48 contiguous U.S.A., D.C. and Puerto Rico (with coverage limitations). ² Requires compatible device. ³ Airbags are supplemental restraints only and will not deploy in all crash circumstances. Always use safety belts and seat children only in the rear, using restraint systems appropriate for their size and age. ⁴ All cargo should be properly secured before driving the vehicle. See your owner's manual for details.

TDI® Premium Plus

The following highlighted features of the Q7 TDI® Premium Plus add to or replace the highlighted features of the Q7 TDI® Premium.

- ▶ Power-adjustable, power-folding, auto-dimming, heated exterior side mirrors with memory
- ▶ Power tilt and telescopic adjustable steering column
- ▶ Panoramic sunroof
- ▶ Driver seat memory
- ▶ MMI® navigation plus with voice control system¹
- ▶ Audi connect® with six-month trial subscription²
- ▶ Color driver information system
- ▶ BOSE® Surround Sound System with 14 speakers and AudioPilot® noise-compensation
- ▶ HD Radio™ Technology
- ▶ SiriusXM® Traffic with four-year subscription³
- ▶ BLUETOOTH® streaming audio⁴
- ▶ Audi advanced key—keyless start, stop and entry⁵
- ▶ Audi side assist
- ▶ Parking system plus with rear view camera (front and rear acoustic parking sensors)

Available packages and stand-alone options

(for more details, refer to the Packages and Options pages)

- ▶ Cold Weather package
- ▶ Warm Weather package
- ▶ Offroad Style plus package
- ▶ Towing package
- ▶ Rear-passenger thorax side airbags⁶
- ▶ Running boards
- ▶ 20" 10-spoke V design wheels
- ▶ 21" 5-arm rotor design wheels (with Offroad Style plus package)



BOSE® Surround Sound System



Audi side assist



Driver seat memory



Walnut Wood decorative inlays



19" 5-arm-structure design wheels with 265/50 all-season tires

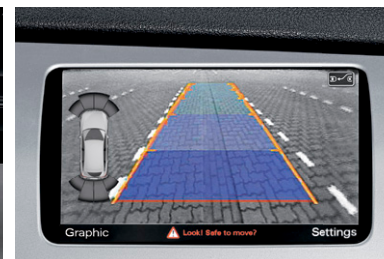

Parking system plus with rear view camera



Panoramic sunroof



MMI® navigation plus¹



Audi connect® online services²



¹ MMI® navigation plus depends on signals from the worldwide Global Positioning Satellite network. The vehicle's electrical system and existing wireless and satellite technologies must be available and operating properly for the system to function. The system is designed to provide you with suggested routes in locating addresses, destinations and other points of interest. Changes in street names, construction zones, traffic flow, points of interest and other road system changes are beyond the control of Audi of America, Inc. Complete detailed mapping of lanes, roads, streets, toll roads, highways, etc., is not possible, therefore you may encounter discrepancies between the mapping and your actual location. Please rely on your individual judgment in determining whether or not to follow a suggested MMI® navigation plus route. For mapping updates please see your Audi dealer or call 1-800-FOR-AUDI for details. ² Always pay careful attention to the road, and do not drive while distracted. The features and technologies discussed above are optional, may require an additional subscription with separate terms and conditions, and should be used only when it is safe and appropriate. The Wi-Fi® hotspot feature is intended for passenger use only. ³ SiriusXM Satellite Radio and SiriusXM Traffic subscriptions are sold separately or as a package after trial period and are continuous until you call SiriusXM to cancel. See Customer Agreement for complete terms and more information at www.siriusxm.com. SiriusXM Traffic service available in select markets. SiriusXM U.S. Satellite Service available only to those in the 48 contiguous U.S.A., D.C. and Puerto Rico (with coverage limitations). ⁴ Requires compatible device. ⁵ Some Audi models are equipped with a keyless ignition feature. The details as to how the system works can vary, and Audi owners should consult their owner's literature or an authorized Audi dealer if they have further questions about the operation of this feature. Please note that Audi warns against leaving the vehicle unattended with the engine running, particularly in enclosed spaces. ⁶ Airbags are supplemental restraints only and will not deploy in all crash circumstances. Always use safety belts and seat children only in the rear, using restraint systems appropriate for their size and age.

TDI® Prestige

The following highlighted features of the Q7 TDI® Prestige add to or replace the highlighted features of the Q7 TDI® Premium Plus.

- ▶ 20" 10-spoke V design wheels
- ▶ Adaptive xenon plus headlights with LED daytime running lights
- ▶ Four-zone automatic climate control
- ▶ Manual rear-side window (second row) and tailgate sunshades
- ▶ Panoramic sunroof with deep tint
- ▶ Ventilated front seats
- ▶ Corner view camera system

Available packages and stand-alone options

(for more details, refer to the Packages and Options pages)

- ▶ Cold Weather package
- ▶ Luxury package
- ▶ S line® package
- ▶ 20" S line® plus package
- ▶ 21" S line® plus package
- ▶ Sport Style plus package
- ▶ Towing package
- ▶ Audi adaptive air suspension
- ▶ Bang & Olufsen® Advanced Sound System
- ▶ Running boards
- ▶ Rear-passenger thorax side airbags¹
- ▶ Carbon decorative inlays



Heated and ventilated twelve-way power front seats



Adaptive xenon plus headlights with LED daytime running lights



Front seat temperature controls



Walnut Wood decorative inlays

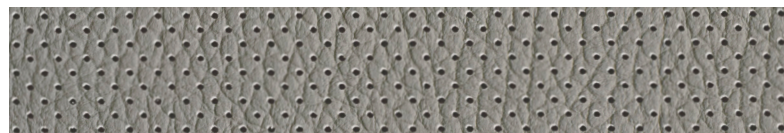

Limestone Gray Perforated leather



20" 10-spoke V design wheels with 275/45 all-season tires²



Deep-tinted panoramic sunroof



Four-zone automatic climate control and second-row seat temperature controls



Parking system plus with corner view camera



¹ Airbags are supplemental restraints only and will not deploy in all crash circumstances. Always use safety belts and seat children only in the rear, using restraint systems appropriate for their size and age. ² High-performance tires are designed for better performance and handling in warm climates. When driving in cold, snowy or icy weather, you should equip your vehicle with four all-season or winter tires, which offer better traction under those conditions. We suggest you use the Audi-recommended winter or all-season tires specified for your Audi. High-performance tires also have a lower aspect ratio that aids performance and handling. Driving over rough or damaged road surfaces, as well as debris, curbs and other obstacles, can cause serious damage to wheels, tires, vehicle body and suspension parts. Be careful to avoid road hazards and reduce your speed, especially if your vehicle is equipped with low-profile tires. Please also remember when making your selection that, while these tires deliver responsive handling, they may ride less comfortably and make more noise than others. Finally, these tires may wear more quickly than other choices. It is important that the inflation pressure is regularly checked and maintained at recommended levels.

Packages

Emblematic to the progressive nature in which all our vehicles are engineered are the technologies and offerings available in a variety of packages to enhance the experience of driving an Audi vehicle. To prove that luxury has progressed, we invite you to explore the package that best outfits your Audi Q7.

Cold Weather package

Available on all models

- ▶ Heated second-row seats
- ▶ Heated steering wheel



Technology package

Available on Premium models

- ▶ Audi side assist
- ▶ MMI® navigation plus with voice control¹
- ▶ Audi connect® with six-month trial subscription¹
- ▶ HD Radio™ Technology
- ▶ SiriusXM® Traffic with four-year subscription¹
- ▶ BLUETOOTH® streaming audio¹
- ▶ Color driver information system
- ▶ Parking system plus with rear view camera



Offroad Style plus package

Available on Premium Plus models

- ▶ Gloss Black Singleframe® grille
- ▶ Matte Black trim around exterior windows
- ▶ Matte Black aluminum roof rails
- ▶ Offroad-style fender flares and side sills
- ▶ Full paint finish offroad-style bumpers with stainless steel skid plates front and rear
- ▶ 20" 5-spoke Audi Sport design wheels (Titanium-finished) with 275/45 all-season tires²
- ▶ 21" 5-arm rotor-design wheels (Titanium-finished) with 275/40 summer performance tires²



Warm Weather package

Available on Premium Plus models

- ▶ Manual rear-side window (second row) and tailgate sunshades
- ▶ Four-zone automatic climate control
- ▶ Panoramic sunroof with deep tint



Luxury package

Available on Prestige models

- ▶ Extended leather package (door armrests, pulls and center console are wrapped in leather)
- ▶ Alcantara® headliner



S line® package

Available on TDI® Prestige models

- ▶ S line® exterior appearance
- ▶ Headlight washing system
- ▶ Aluminum door sill inlays with S line® logo
- ▶ Heated second-row rear seats
- ▶ Brushed Aluminum decorative inlays
- ▶ Three-spoke multifunction steering wheel with shift paddles
- ▶ Black cloth headliner
- ▶ S line® leather-wrapped shift knob



S line® Interior package

Available on 3.0T Prestige models

- ▶ Heated second-row rear seats
- ▶ Brushed Aluminum decorative inlays
- ▶ Three-spoke multifunction steering wheel with shift paddles
- ▶ Black cloth headliner
- ▶ S line® leather-wrapped shift knob



20" S line® plus package

Available on Prestige models

- ▶ Gloss Black Singleframe® grille
- ▶ Matte Black aluminum roof rails
- ▶ Matte Black trim around exterior windows
- ▶ 20" 5-spoke Audi Sport design wheels (Titanium-finished) with 275/45 all-season tires²



21" S line® plus package

Available on Prestige models

- ▶ Gloss Black Singleframe® grille
- ▶ Matte Black aluminum roof rails
- ▶ Matte Black trim around exterior windows
- ▶ 21" 5-segment-spoke design (Titanium-finished) wheels with 295/35 summer performance tires²



Sport Style plus package

Available on Prestige models

- ▶ Gloss Black Singleframe® grille
- ▶ Matte Black aluminum roof rails
- ▶ Matte Black trim around exterior windows
- ▶ Unique front and rear bumpers with polished oval exhaust outlets
- ▶ 21" 5-segment-spoke design (High-gloss Black-finished) wheels with 295/35 summer performance tires²

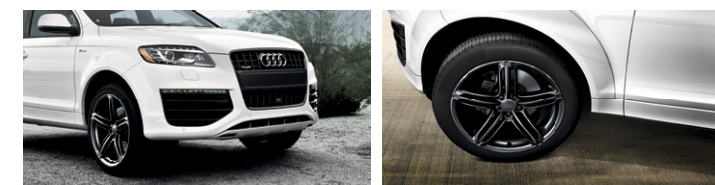

¹ See Infotainment/Technology section of the Featured Content page for important information regarding MMI® navigation plus, Audi connect®, required SiriusXM® subscriptions, and BLUETOOTH®-required device.
² See Options page for important safety information regarding summer performance tires.

Options

In addition to the many packages available for your Audi Q7, there are also a host of a la carte options to outfit your vehicle. From a variety of wheel offerings and choices of elegant interior trims to features like rear-passenger thorax side airbags and running boards, there's an option to help better complement your lifestyle.



19" 5-arm-structure design wheels with 265/50 all-season tires
(optional on 3.0T Premium and Premium Plus models, standard on TDI® Premium and Premium Plus models)



20" 10-spoke V design wheels with 275/45 all-season tires¹
(optional on 3.0T and TDI® Premium Plus models, standard on TDI® Prestige models)



21" 5-arm rotor design wheels (Titanium-finished) with 275/40 summer performance tires¹
(optional on Premium Plus models with Offroad Style plus package)



Running boards
(optional on Premium Plus and Prestige models)

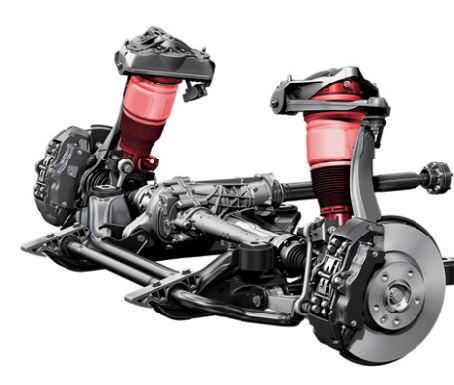

Audi adaptive air suspension
(optional on Prestige models)



Bang & Olufsen® Advanced Sound System
(optional on Prestige models)



Rear-passenger thorax side airbag²
(optional on all models)



Towing package³
(optional on all models)



Panoramic sunroof
(optional on Premium models)



Alcantara® headliner
(optional on Prestige models)

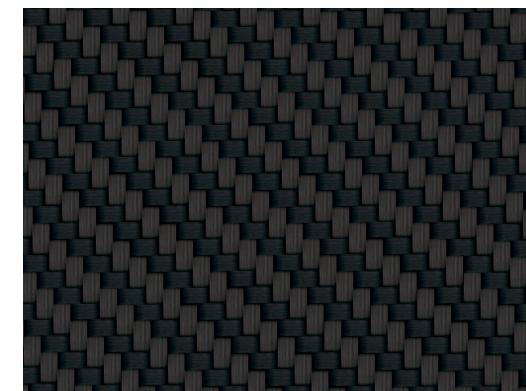

Carbon decorative inlays
(optional on Prestige models)

¹ High-performance tires are designed for better performance and handling in warm climates. When driving in cold, snowy or icy weather, you should equip your vehicle with four all-season or winter tires, which offer better traction under those conditions. We suggest you use the Audi-recommended winter or all-season tires specified for your Audi. High-performance tires also have a lower aspect ratio that aids performance and handling. Driving over rough or damaged road surfaces, as well as debris, curbs and other obstacles, can cause serious damage to wheels, tires, vehicle body and suspension parts. Be careful to avoid road hazards and reduce your speed, especially if your vehicle is equipped with low-profile tires. Please also remember when making your selection

that, while these tires deliver responsive handling, they may ride less comfortably and make more noise than others. Finally, these tires may wear more quickly than other choices. It is important that the inflation pressure is regularly checked and maintained at recommended levels. ² Airbags are supplemental restraints only and will not deploy in all crash circumstances. Always use safety belts and seat children only in the rear, using restraint systems appropriate for their size and age. ³ Towing package with 6,600-lb maximum towing capacity and a 660-lb tongue weight. Maximum tow rating when properly equipped with towing accessories. Other accessories and options may reduce maximum towing capacity. See vehicle owner's manual for details.

Exterior Colors

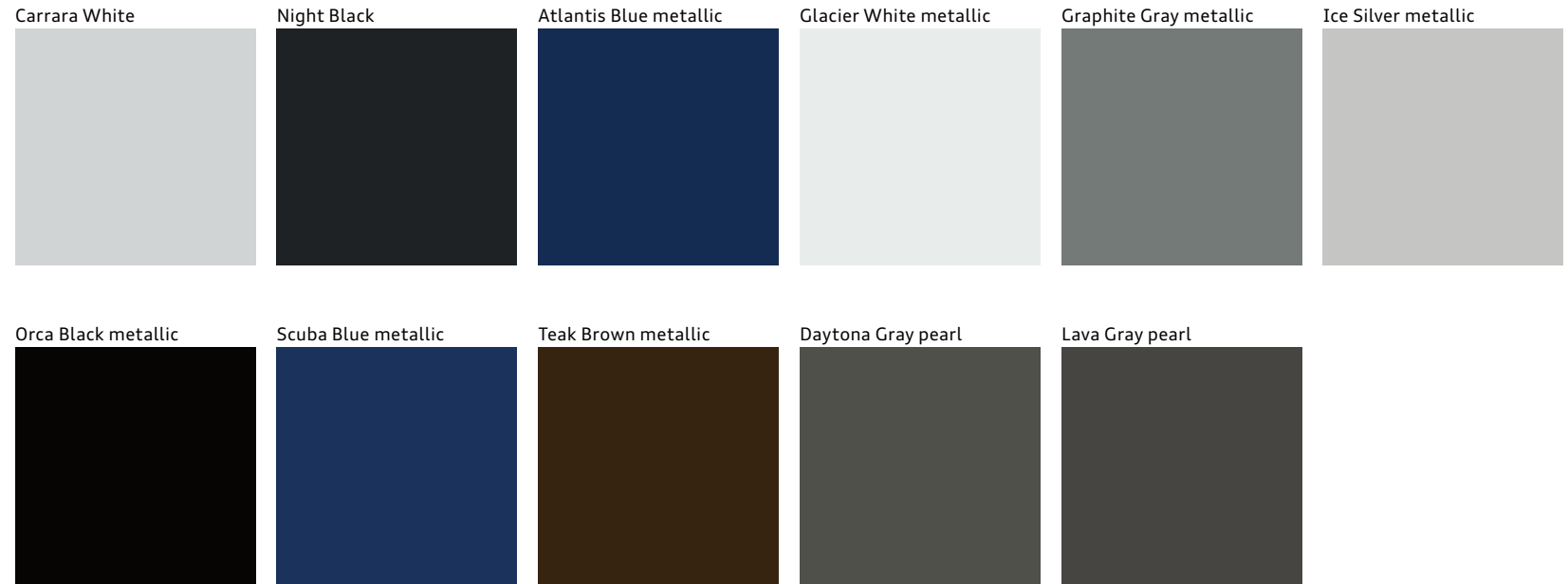

Seat Selections | Interior Colors



Exterior colors, interior colors and decorative inlay options will vary based on model and trim level combination. See your dealer for details.

Technical Specifications

Engineering Performance	Q7 3.0T	Q7 3.0T S line® Prestige	Q7 TDI®
Engine type	Six-cylinder	Six-cylinder	Six-cylinder
Engine block/Cylinder head	Aluminum-alloy	Aluminum-alloy	Cast-iron/Aluminum-alloy
Displacement (cc)/Bore and stroke (mm)	2,995/84.5 x 89.0	2,995/84.5 x 89.0	2,967/83.0 x 91.4
Horsepower (@ rpm)	280 @ 4,920–6,500	333 @ 5,500–6,500	240 @ 3,500–4,000
Torque (lb-ft @ rpm)	295 @ 2,150–4,915	325 @ 2,900–5,300	406 @ 1,750–2,250
Compression ratio	10.5:1	10.5:1	16.8:1
Valvetrain	24-valve DOHC	24-valve DOHC	24-valve DOHC
Induction/Fuel injection	Supercharged/TFSI®	Supercharged/TFSI®	Turbocharged/TDI®
Acceleration (0–60 mph)	7.7 seconds	6.9 seconds	7.7 seconds
Top track speed ¹	130 mph	130 mph	130 mph

Transmission | Drivetrain

Eight-speed Tiptronic® automatic transmission with quattro® all-wheel drive	■	■	■
(Gear ratios: 1st: 4.845, 2nd: 2.840, 3rd: 1.864, 4th: 1.437, 5th: 1.217, 6th: 1.000, 7th: 0.816, 8th: 0.672, Reverse: 3.825, Final drive: 3.700)	■	■	—
(Gear ratios: 1st: 4.970, 2nd: 2.840, 3rd: 1.864, 4th: 1.437, 5th: 1.210, 6th: 1.000, 7th: 0.825, 8th: 0.686, Reverse: 4.066, Final drive: 3.273)	—	—	■

Body | Suspension | Chassis

Fully galvanized steel unibody with aluminum hood, front fenders, tailgate and multi-step anti-corrosion protection	■	■	■
Double-wishbone front suspension	■	■	■
Four-link rear suspension	■	■	■
Audi adaptive air suspension (Prestige)	—	Available	Available
Ventilated front disc/Ventilated rear disc brakes (in)	13.8/13.0	13.8/13.0	13.8/13.0
Servotronic® power steering system	■	■	■
Steering ratio	16.5:1	16.5:1	16.5:1
Turning diameter, curb-to-curb (ft)	39.4	39.4	39.4

■ Standard — Not applicable

Exterior measurements

	Q7 3.0T	Q7 3.0T S line® Prestige	Q7 TDI®
Wheelbase (in)	118.2	118.2	118.2
Length (in)	200.3	200.3	200.3
Height (in)	68.4	68.4	68.4
Overall width with mirrors (in)	85.7	85.7	85.7
Overall width without mirrors (in)	78.1	78.1	78.1
Track front/rear (in)	65.0/66.0	65.0/66.0	65.0/66.0
Ground clearance, loaded (in)	8.1	8.1/9.4 with Audi adaptive air suspension	8.1/9.4 with Audi adaptive air suspension
Curb weight (lb)	5,192	5,412	5,412
Drag coefficient (Cw)	0.37	0.37/0.34 with Audi adaptive air suspension	0.37/0.34 with Audi adaptive air suspension
Trailer hitch provision with 5,500-lb maximum towing capacity and 550-lb tongue weight ²	■	■	■
Towing package, including tow bar and increased cooling capacity, with a 6,600-lb maximum towing capacity and 660-lb tongue weight ²	Available	Available	Available

Interior measurements

Head room without panoramic sunroof (in, front/middle/rear)	39.5/39.0/35.6	39.5/39.0/35.6	39.5/39.0/35.6
Head room with panoramic sunroof (in, front/middle/rear)	40.0/37.2/35.4	40.0/37.2/35.4	40.0/37.2/35.4
Leg room (in, front/middle/rear)	41.3/37.1/29.2	41.3/37.1/29.2	41.3/37.1/29.2
Shoulder room (in, front/middle/rear)	58.7/58.1/48.6	58.7/58.1/48.6	58.7/58.1/48.6
Cargo volume (cu ft, behind third row/behind second row with the seats folded/behind first row with the seats folded)	10.9/42.0/72.5	10.9/42.0/72.5	10.9/42.0/72.5
Seating capacity	7	7	7

EPA mileage estimates | Capacities | Emissions

Tiptronic® automatic transmission (city/highway/combined) ³	16/22/18	16/22/18	19/28/22
Engine oil (qt)	8.5	8.5	8.6
Fuel (gal)	26.4	26.4	26.4
Required fuel	Premium	Premium	Ultra-low-sulfur diesel
Emissions rating	LEV II	LEV II	ULEV II

¹ Top track speed is electronically limited in the U.S. Always obey all speed and traffic laws. ² Maximum tow rating when properly equipped with towing accessories. Other accessories and options may reduce maximum towing capacity. See vehicle owner's manual for details. ³ EPA estimates. Your mileage will vary, and depends on several factors, including your driving habits and vehicle condition. See www.fueleconomy.gov for details.

Featured Content

Safety Security	3.0T/TDI® Premium	3.0T/TDI® Premium Plus	3.0T S line®/TDI® Prestige
Driver and front passenger dual-stage airbags, front thorax side airbags, and Sideguard® head curtain airbags ¹	■	■	■
Rear-passenger thorax side airbags ¹	Available	Available	Available
Front-passenger occupant detection for airbags ¹	■	■	■
Lower Anchors and Tethers for CHILDREN (LATCH) in second- and third-row seating positions	■	■	■
Power central locking system with safety unlock feature if airbags deploy	■	■	■
Electronic Stability Control (ESC) with Offroad mode and traction control (ASR)	■	■	■
Anti-lock Brake System (ABS) with Electronic Brake-pressure Distribution (EBD) and brake assist	■	■	■
Hill descent control	■	■	■
Tire-pressure monitoring system	■	■	■
Anti-theft alarm system with immobilizer	■	■	■

Exterior

Singleframe® grille	■	■	■
Gloss Black Singleframe® grille	—	Available	Available
Xenon plus headlights with LED daytime running lights	■	■	—
Adaptive xenon plus headlights with LED daytime running lights	—	—	■
Headlight washing system	—	—	■/Available
Front and rear fog lights	■	■	■
LED taillights	■	■	■
Power-adjustable heated exterior side mirrors	■	—	—
Power-adjustable, power-folding, auto-dimming, heated exterior side mirrors with memory	—	■	■
LED turn indicator light technology integrated into the exterior side mirrors	■	■	■
Aluminum roof rails	■	■	■
Matte Black aluminum roof rails	—	Available	Available
Aluminum trim around exterior windows	■	■	■
Matte Black trim around exterior windows	—	Available	Available
Power tailgate	■	■	■
Rear privacy glass	■	■	■
Body color lower body paint finish with chrome accents	■	■	■
S line® exterior appearance	—	—	■/Available

■ Standard — Not applicable

Interior	3.0T/TDI® Premium	3.0T/TDI® Premium Plus	3.0T S line®/TDI® Prestige
Dual-zone automatic climate control	■	■	—
Four-zone automatic climate control	—	Available	■
Four-spoke multifunction steering wheel	■	■	■
Three-spoke multifunction steering wheel with shift paddles	—	—	Available
Heated steering wheel	Available	Available	Available
Power tilt and telescopic adjustable steering column	—	■	■
Auto-dimming interior rear view mirror with compass	■	■	■
Illuminated locking glove compartment	■	■	■
Ten beverage holders (six cup and four bottle)	■	■	■
Aluminum door sill inlays	—	—	■/Available
Front and rear footwell LED lighting	■	■	■
Ambient LED interior lighting	■	■	■
Alcantara® headliner	—	—	Available
Extended Leather package (door armrests, pulls and center console are wrapped in leather)	—	—	Available
Black cloth headliner	—	—	Available
Dual front sun visors with lighted vanity mirrors	■	■	■
Power windows with one-touch up/down operation and pinch protection	■	■	■
Manual rear-side window (second row) and tailgate sunshades	—	Available	■
Panoramic sunroof	Available	■	—
Panoramic sunroof with deep tint	—	Available	■
Panoramic sunroof deletion	—	Available	Available

Seating

Leather seating surfaces	■	■	■
Twelve-way power front seats, including four-way power lumbar adjustment	■	■	■
Driver seat memory	—	■	■
Heated front seats	■	■	■
Ventilated front seats	—	—	■
Heated second-row seats	Available	Available	Available
Sliding 40/20/40 split folding rear seat with pass-through and adjustable recline	■	■	■
Split folding 50/50 third-row seatbacks with collapsible head restraints and one-action lowering from cargo area	■	■	■

¹ Airbags are supplemental restraints only and will not deploy in all crash circumstances. Always use safety belts and seat children only in the rear, using restraint systems appropriate for their size and age.

Featured Content

Infotainment | Technology

	3.0T/TDI® Premium	3.0T/TDI® Premium Plus	3.0T S line®/TDI® Prestige
MMI® navigation plus with voice control system ¹	Available	■	■
Audi connect® with six-month trial subscription ²	Available (with navigation)	■	■
Color driver information system	Available (with navigation)	■	■
Audi premium sound system with 11 speakers, single CD player and MP3 playback capability	■	—	—
BOSE® Surround Sound System with 14 speakers and AudioPilot® noise compensation	—	■	■
Bang & Olufsen® Advanced Sound System with 14 speakers and 1,000 watts	—	—	Available
HD Radio™ Technology	Available (with navigation)	■	■
SiriusXM® Satellite Radio with 90-day trial subscription ³	■	■	■
SiriusXM® Traffic with four-year subscription ³	Available (with navigation)	■	■
Audi music interface with iPod® integration	■	■	■
BLUETOOTH® streaming audio ⁴	Available (with navigation)	■	■
BLUETOOTH® wireless technology preparation for mobile phone ⁴	■	■	■
Six 12-volt power outlets	■	■	■
Garage door opener (HomeLink®)	■	■	■
Audi advanced key—keyless start, stop and entry ⁵	—	■	■
Cruise control with coast, resume and accelerate features	■	■	■
Audi side assist	Available	■	■
Parking system with rear acoustic parking sensors	■	—	—
Parking system plus with rear view camera (front and rear acoustic parking sensors)	Available	■	■
Corner view camera system	—	—	■
Rain/light sensor for automatic windshield wipers and headlights	■	■	■

■ Standard — Not applicable

¹ MMI® navigation plus depends on signals from the worldwide Global Positioning Satellite network. The vehicle's electrical system and existing wireless and satellite technologies must be available and operating properly for the system to function. The system is designed to provide you with suggested routes in locating addresses, destinations and other points of interest. Changes in street names, construction zones, traffic flow, points of interest and other road system changes are beyond the control of Audi of America, Inc. Complete detailed mapping of lanes, roads, streets, toll roads, highways, etc., is not possible, therefore you may encounter discrepancies between the mapping and your actual location. Please rely on your individual judgment in determining whether or not to follow a suggested MMI® navigation plus route. For mapping updates please see your Audi dealer or call 1-800-FOR-AUDI for details. ² Always pay careful attention to the road, and do not drive while distracted. The features and technologies discussed above are optional, may require an additional subscription with separate terms and conditions, and should be used only when it is safe and appropriate. The Wi-Fi® hotspot feature is intended for passenger use only. ³ SiriusXM Satellite Radio and SiriusXM Traffic subscriptions are sold separately or as a package after trial period and are continuous until you call SiriusXM to cancel. See Customer Agreement for complete terms and more information at www.siriusxm.com. SiriusXM Traffic service available in select markets. SiriusXM U.S. Satellite Service available only to those in the 48 contiguous U.S.A., D.C. and Puerto Rico (with coverage limitations). ⁴ Requires compatible device. ⁵ Some Audi models are equipped with a keyless ignition feature. The details as to how the system works can vary, and Audi owners should consult their owner's literature or an authorized Audi dealer if they have further questions about the operation of this feature. Please note that Audi warns against leaving the vehicle unattended with the engine running, particularly in enclosed spaces.

Make an entrance on an even grander scale.

The 21" S line® plus package dresses your Q7 with Titanium-finished 5-segment-spoke wheels, a Gloss Black Singleframe® grille surround and Black roof rails. There's even Black trim around the exterior windows. An impressive ensemble any way you look at it.



Accessories

Add distinction, versatility and the ultimate in self-expression with Audi Genuine Accessories. Whether you load the cargo carrier with climbing gear or add a set of stylish new wheels, we have the accessories that will help enhance every facet of your lifestyle. When purchased from an authorized dealer, all pieces are

backed by your vehicle's 4-year/50,000-mile limited warranty or for 12 months/12,000 miles from the accessory purchase date, whichever is greater! If you're looking to personalize or protect the vehicle you love, we have an Audi-designed solution that works for you.



Aluminum bike rack

This locking holder fits 20- to 80-mm bike frames with both wheels on the bike and helps keep the bike upright as you secure it in place.^{2,3}



Ski and snowboard rack

This rack transports your equipment to the slopes easily and securely. The standard attachment (shown) holds two sets of skis or two snowboards. A deluxe attachment is also available.^{2,3}



Compact cargo carrier

Your gear won't take up valuable cargo space with our aerodynamic carrier that offers a generous 16.95-cu-ft capacity. Size: 81" long, 30" wide, 15" high.²



20" 10 double-spoke wheels

With a distinctive two-tone design, this wheel is sure to draw attention to the already imposing Q7.



Offroad Styling package

This attractive body-styling package includes a front valance, door guards, wheel arch protectors, protection strips and a rear valance. Shown with optional running boards.



All-weather cargo mat

Custom fit for your Q7, the raised outside edge of the cargo mat helps contain spills and protect cargo-area carpeting from stains. The textured material helps control load shifting.

Splash guards

Help protect the finish of your Q7 with custom-fit splash guards made of crack-resistant rubber. They are available in sets of two for front or rear.⁴

20" 5-arm Pikes Peak wheels

This progressive, muscular five-spoke design is the perfect match for a powerfully elegant vehicle.

Q7 all-weather floor mats

Nubbled design helps protect your vehicle's floor and carpeting from water, mud, sand and snow. Black mats are available in sets of two for front or rear. Front mats feature the Q7 logo.

Other accessories

Audi Genuine Sport and Design Accessories

Your Audi vehicle features a bold, aggressive stance and strong, stunning lines. Enhance it by adding Audi Genuine Sport and Design accessories. All are carefully scrutinized in the design and development process. So while they're striking in appearance, they've also passed rigorous quality assessments, including corrosion testing. If you're looking for a bolder appearance or a finishing touch, there is a solution designed by Audi that makes every mile more enjoyable—and more yours.

Audi Genuine Alloy Wheels

Strike the perfect balance between breathtaking design and awe-inspiring performance with Audi Genuine Alloy Wheels. Audi experts have meticulously designed these wheels especially for each Audi model. They're engineered to the highest standards and endure rigorous testing to help ensure long-term quality. Experience eye-catching style that is yours and yours alone. Nothing enhances the bold, dynamic look of your Audi vehicle faster.

Audi TravelSpace Transport Accessories

For every season and every getaway, Audi takes you there. Never leave the necessary gear behind. Be ready for any journey with Audi TravelSpace Transport Accessories. The list includes bike racks, ski racks, a variety of water sports equipment carriers and various sizes of cargo carriers. Wherever you go, make sure everything fits with a variety of intelligent and innovative solutions. Accessories designed for your active, passionate lifestyle.

Audi Genuine Electronics Accessories

The illuminating technology that graces each Audi vehicle provides the inspiration for Audi Genuine Electronics Accessories. Similarly, all of these accessories are impressively advanced and inspiring. Our audio options let you enhance your listening pleasure. Other accessory options help promote more convenient travel. All are designed and tested to help ensure compatibility with the vehicle's electrical systems, allowing you to enjoy every aspect of Audi technology with almost all your senses. Demand the best and drive with added confidence.

Audi Genuine Comfort and Protection Accessories

Help protect what you love. Audi Guard Comfort and Protection Accessories offer functional, practical items that help keep your Audi in pristine condition. Choose from such useful items as trunk liners that help make clean-up quick and easy, or an easy-to-use storage cover that helps shield the vehicle. Use them all to help reduce wear and tear and keep the vehicle looking like new—inside and out. All are engineered to stringent Audi standards, so you can be assured of their quality and durability.

¹ Audi Genuine Accessories purchased from an authorized Audi dealer are covered for the greater of: (1) the accessory limited warranty period (12 months or 12,000 miles, whichever occurs first) from the time of purchase; or (2) the remainder of the Audi New Vehicle Limited Warranty period (4 years or 50,000 miles, whichever occurs first). See your authorized Audi dealer for details. ² All roof-rack system attachments require the base carrier bars. All attachments sold separately. ³ Recreational and sporting equipment not included. ⁴ Not compatible with Q7 Prestige models.

Note: A word about this brochure. Audi of America, Inc., believes the specifications in this brochure to be correct at the time of printing. However, specifications, standard equipment, options, fabrics, and colors are subject to change without notice. Some equipment may be unavailable when your vehicle is built. Please ask your dealer for advice concerning current availability of standard and optional equipment, and your dealer will verify that your vehicle will include the equipment you ordered. Vehicles in this brochure are shown with optional equipment. See your dealer for complete details on the Audi New Vehicle Limited Warranty, twelve-year limited warranty against corrosion perforation, and Audi 24/7 Roadside Assistance. (Roadside assistance coverage provided by Road America in the U.S. Certain conditions apply; see your dealer for details.) Tires supplied by various manufacturers. "Audi," all model names, "Audi connect," "e-tron," "FSI," "MMI," "quattro," "S line," "TFSI," "Truth in Engineering," "ultra," and the four rings logo are registered trademarks of AUDI AG. "AdBlue" is a registered trademark of the Verband der Automobilindustrie. "Alcantara" is a registered trademark of Alcantara S.p.A. "AudioPilot" is a registered trademark of the BOSE Corporation. "Bang & Olufsen" is a registered trademark of Bang & Olufsen. The BLUETOOTH word mark and logos are owned by the Bluetooth SIG, Inc., and any use of such marks by AUDI AG is under license. "BOSE" is a registered trademark of the BOSE Corporation. "Google," "Google Earth" and "Google Voice" are trademarks of Google Inc. "HD Radio" and the HD Radio logo are proprietary trademarks of iBiquity Digital Corporation. "HomeLink" is a registered trademark of Johnson Controls Technology Company. "ICEpower" is a registered trademark of Bang & Olufsen. "iPod" is a registered trademark of Apple Inc. "Servotronic" is a registered trademark of the AM General Corporation. "SiriusXM" and all related marks and logos are trademarks of Sirius XM Radio Inc. and its subsidiaries. "TDI" is a registered trademark of Volkswagen AG. "Tiptronic" is a registered trademark of Dr. Ing h.c. F. Porsche AG. "Wi-Fi" is a registered trademark of the Wi-Fi Alliance. All other trademarks are the property of their respective owners. Some European models shown.

2015 | Q7 Audi of America

Audiusa.com

Facebook.com/Audi

AoA1515493



© 2014 Audi of America, Inc. Printed in the U.S.A.