

2019 RAM

COMMERCIAL



PURE CAPABILITY.

AMERICA'S
MOST EFFICIENT
WORK VAN*

AMERICA'S
LONGEST-LASTING
HEAVY-DUTY PICKUPS*

MOTORTREND
TRUCK OF THE YEAR 2019



RAM
COMMERCIAL

THIS IS THE RAM
COMMERCIAL FAMILY:
RELENTLESS STRENGTH,
WELCOME REFINEMENT,
TOTAL VERSATILITY.

RAM CHASSIS CAB

3500/4500/5500

BEST-IN-CLASS: MAX DIESEL TRAILERING:

25,890 LB (3500)³

29,770 LB (4500)⁴

35,220 LB (5500)⁵

BEST-IN-CLASS: MAX GCWR:

33,000 LB (3500)^{3,6}

37,500 LB (4500)^{4,6}

43,000 LB (5500)^{5,6}

MAX DIESEL TORQUE: 800 LB-FT

RAM HEAVY DUTY

2500/3500

BEST-IN-CLASS: AVAILABLE MAX DIESEL TOWING:

35,100 LB (3500)⁷

BEST-IN-CLASS: AVAILABLE MAX DIESEL TORQUE:

1,000 LB-FT (3500)⁷

BEST-IN-CLASS: AVAILABLE FIFTH-WHEEL TOWING:

30,000 LB (3500)⁸

BEST-IN-CLASS: MAX GAS PAYLOAD:

7,680 LB (3500)⁷

BEST-IN-CLASS: GAS HORSEPOWER:

410 HP⁷

*All disclosures can be found on page 43.

MORE ON PAGE 5

MORE ON PAGE 10

PURE CAPABILITY.

AMERICA'S
MOST EFFICIENT
WORK VAN¹²

AMERICA'S
LONGEST-LASTING
HEAVY-DUTY PICKUPS¹³

MOTORTREND
TRUCK OF THE YEAR 2019

Ram Chassis Cab shown with aftermarket upfit.

RAM LIGHT DUTY

1500

BEST-IN-CLASS: V8 TOWING: 12,750 LB⁹

LARGEST BRAKES IN ITS CLASS⁹

CLASS-EXCLUSIVE: AVAILABLE 12" TOUCHSCREEN⁹

MOST AWARDED LIGHT-DUTY TRUCK IN AMERICA¹⁰

MAX PAYLOAD: 2,300 LB¹¹

[MORE ON PAGE 22](#)

1500 CLASSIC

MAX TOWING: 10,710 LB¹¹

MAX PAYLOAD: 1,920 LB¹¹

[MORE ON PAGE 26](#)

RAM PROMASTER[®]

CARGO VAN/CHASSIS CAB/CUTAWAY

BEST-IN-CLASS: STANDARD CARGO HEIGHT: 66.3 IN¹²

BEST-IN-CLASS: WIDTH BETWEEN WHEEL WELLS: 56 IN¹²

BEST-IN-CLASS: MAX CARGO WIDTH: 75.6 IN¹²

BEST-IN-CLASS: LOWEST LOAD FLOOR HEIGHT: 24.4 IN¹²

BEST-IN-CLASS: TURNING DIAMETER: 36.3 FEET
(118" WHEELBASE)¹²

CLASS-EXCLUSIVE: FRONT-WHEEL DRIVE¹²

MAX PAYLOAD: 4,430 LB (CARGO VAN)¹¹

MAX TOWING: 6,800 LB (CARGO VAN)¹¹

[MORE ON PAGE 28](#)

RAM PROMASTER CITY[®]

CARGO VAN/PASSENGER WAGON

BEST-IN-CLASS: HWY FUEL ECONOMY:
28 MPG HWY¹³

BEST-IN-CLASS: CARGO CAPACITY: 131.7 CU FT
(CARGO VAN)¹⁴

BEST-IN-CLASS: PAYLOAD: UP TO 1,883 LB
(CARGO VAN)¹⁴

BEST-IN-CLASS: HORSEPOWER: 178 HP¹⁴

BEST-IN-CLASS: TORQUE: 174 LB-FT¹⁴

BEST-IN-CLASS: MAX GVWR: 5,395 LB^{6,14}

[MORE ON PAGE 31](#)

SOLID SUPPORT.



RAM COMMERCIAL: SUPPORTING YOU AND YOUR BUSINESS. EVERYWHERE. For 2019, this portfolio is tougher, more refined—and with more support than ever. The facts: stronger frame strength and ramped-up towing for 2019 Ram 1500. Impressive best-in-class strengths and a new 8-speed transmission for new 2500/3500 pickups. Incredible towing, payload, GCWR and GVWR for Chassis Cab. Stellar versatility and a wealth of best-in-class assets for Ram ProMaster[®] models. Innovative standard and available technology to make trailering easier and more secure, plus available Ram Telematics[™]—helping fleets improve productivity and profits. This is support every business needs.

Get more at ramtrucks.com/commercial

RAM 4500/5500 CHASSIS CABS

PHENOMENAL TORQUE, POWER-AND SOPHISTICATION.



Properly secure all cargo. Always tow within the vehicle's capacity. Shown with aftermarket upfit.

TOP-TIER CREDENTIALS MAKE RAM CHASSIS CAB READY FOR THE TOUGHEST JOBS.

A 2019 Ram 4500/5500 Chassis Cab comes to work with exceptional capability, measured by towing and hauling, with impressive versatility for available PTO. The best-in-class assets of 2019 Ram Chassis Cab include superior GCWR^{4,5} and max trailering^{4,5} best-in-class available torque¹⁵ from the available Cummins[®] Turbo Diesel, and best-in-class oil change intervals of 12,500 miles¹⁵ for the available Cummins Turbo Diesel.



UP TO **360 HORSEPOWER**
AND **800 LB-FT OF TORQUE**

RAM 4500 CHASSIS CAB

BEST-IN-CLASS MAX GCWR: 37,500 LB^{4,6}

UNSURPASSED MAX GVWR: 16,500 LB^{4,6}

BEST-IN-CLASS Gas GCWR—up to **28,500 lb^{4,6}**

BEST-IN-CLASS Available Max Diesel Towing—up to **29,770 lb⁴**

BEST-IN-CLASS Max Gas Towing—up to **21,540 lb⁴**

RAM 5500 CHASSIS CAB

BEST-IN-CLASS MAX GCWR: 43,000 LB^{5,6}

UNSURPASSED MAX GVWR: 19,500 LB^{5,6}

BEST-IN-CLASS Gas GCWR—up to **28,500 lb^{5,6}**

BEST-IN-CLASS Available Max Diesel Towing—up to **35,220 lb⁵**

BEST-IN-CLASS Max Gas Towing—up to **21,490 lb⁵**



Shown with aftermarket upfits.

TOUGHER, STRONGER, AND MORE RESILIENT FRAME. All 2019 Ram Chassis Cabs are designed for robust performance and no-nonsense service over the miles and over the years. Frame improvements for the 2019 Ram 4500/5500 Chassis Cab models include a new front engine crossmember made with 63,000-psi steel and a new cast-iron front track bar bracket. All models feature hydroformed front rail sections and 50,000-psi rear C-channel frame rails with eight separate crossmembers.

FRONT SUSPENSION STRENGTH. Ram 4500/5500 models feature a robust five-link coil spring front suspension and beam axle; shock absorber tuning is unique to each Chassis Cab wheelbase-and-engine combination.

Ram 4500/5500 Chassis Cabs offer an optional Heavy-Duty Front Suspension Package. Recommended for any vehicle with a forward-biased weight upfit (like an aerial boom or our Snow Plow Package), it beefs up capability with taller springs, higher spring rates and a strengthened engine crossmember.

REAR SUSPENSION TECHNOLOGY. What works is what's been long proven: our two-stage longitudinal leaf springs have been ideally tuned to maintain impressive payload and towing capacities, engineering that helps retain vehicle attitude at load and which provides handling benefits in terms of roll steering and overall vehicle dynamics.

BEST-IN-CLASS MAX TRAILERING^{4,5} ACROSS THE BOARD.

These workers are built to tow. For Ram 4500 Chassis Cab with the 6.4L HEMI[®] V8, towing reaches up to 21,540 lb¹¹; with the available 6.7L Cummins,[®] it's up to 29,770 lb¹¹. Towing with a Ram 5500 Chassis Cab with the HEMI V8 maxes out at 21,490 lb¹¹; with the available Cummins, it's up to a remarkable 35,220 lb¹¹.

OUTSTANDING POWER. Run the numbers, and you're running with stream-lined capability. The Class 4 max GVWR with the gas or diesel powertrain is 16,500 lb⁶; the Class 5 max GVWR is a solid 19,500 lb⁶.

MEASURING UP: GCWR. GCWRs are all best-in-class^{4,5}: for gas-powered Ram models, GCWR comes in at 28,500 lb⁶. Opt for a Cummins Turbo Diesel in your Ram 4500 Chassis Cab, and GCWR jumps up to 37,500 lb⁶; our biggest worker with that Cummins, Ram 5500 Chassis Cab, boasts a max GCWR of 43,000 lb⁶.

IT'S EITHER BEST-IN-CLASS ADVANTAGES OR CLASS-EXCLUSIVE. Our focus on getting it right is unrelenting.

Increasingly, we're the only one to offer it, and frequently, it's best-in-class. Example: our best-in-class oil change intervals of 12,500 miles¹⁵ for the available Cummins Turbo Diesel. Available class-exclusive assets? Adaptive Cruise Control¹⁶ Trailer Reverse Guidance¹⁷ 270° Surround-View Camera System¹⁷... and much more. Spec it out at ramtrucks.com/commercial

WHEN IT COMES TO PTO, YOU'VE COME TO THE RIGHT PLACE.

POWER YOUR PROFITS: RAM 4500/5500 CHASSIS CABS.



RAM 4500/5500 CHASSIS CAB features an ultra-versatile design and formidable strength, starting with unsurpassed rear frame steel strength of 50,000 psi¹⁵ and best-in-class available torque of 800 lb-ft¹⁵ from the available Cummins Turbo Diesel mated to the AISIN[®] Heavy-Duty automatic. New upgrades for 2019 include: additional inputs and outputs for the Vehicle System Interface Module (VSIM), with access to more than 70 distinctive upfitter features—including new lighting outputs and new PTO controls. Six programmable in-cabin auxiliary switches with a combined 135-amp output. Left- or right-side PTO-mounting capability. Seven trailer-tow circuits, with easy-to-access Back-Up Camera¹⁸ and Rear Park Assist¹⁸ connectors.

▶ **BEST-IN-CLASS STANDARD GAS HORSEPOWER¹⁵:** count on 370 horsepower backed with 429 lb-ft of torque from the standard 6.4L HEMI[®] V8, with Multi-Displacement Technology kicking in for static PTO applications.

▶ **BEST-IN-CLASS LARGEST SINGLE REAR-MOUNTED FUEL TANK¹⁵:** on Ram 4500/5500, the standard fuel tank is 52 gallons.

▶ **BEST-IN-CLASS AVAILABLE DIESEL HORSEPOWER AND TORQUE¹⁵:** the Cummins[®] Turbo Diesel churns out 360 horsepower and a no-nonsense and commercial-grade 800 lb-ft of torque.

▶ **BEST-IN-CLASS DIESEL ENGINE OIL CHANGE INTERVALS¹⁵:** for the available Cummins Turbo Diesel, it's up to 12,500 miles.

RAM 3500 CHASSIS CABS

TECHNOLOGY JOINS REMARKABLE CAPABILITY.



Properly secure all cargo. Shown with aftermarket upfit.



Shown with aftermarket upfits.

IT STANDS FAR ABOVE—AND PROUDLY APART. One look delivers a powerful message—namely, that a 2019 Ram 3500 Chassis Cab warrants a deeper examination. The range of available technological advantages to carry your business forward is exactly what's needed. Class-exclusive features include: electronic front-axle disconnect¹⁹; Trailer Reverse Guidance¹⁷; 270° Surround-View Camera System¹⁷ and Power Convex Trailer-Tow Mirrors.¹⁹ Add in all those incredible numbers for capability, and you're looking at perfection on wheels.



RAM 3500 CHASSIS CAB

BEST-IN-CLASS MAX GCWR: 33,000 LB^{3,6}

UNSURPASSED MAX GVWR: 14,000 LB^{6,19}

BEST-IN-CLASS Gas GCWR up to **25,000 lb^{3,6}**

BEST-IN-CLASS Available Max Diesel Towing up to **25,890 lb⁹**

BEST-IN-CLASS Max Gas Towing up to **18,950 lb⁹**

BEST-IN-CLASS Gas Horsepower **410 hp³**

Shown with aftermarket upfit.

A TOUGHER FRAME IS READY FOR YOUR UPFIT. 2019 Ram Chassis Cab 3500 models give you a robust and solid platform. Cases in point: a new front track bar bracket of cast aluminum; a new lower engine crossmember, now rated at 63,000-psi steel; new spring tower reinforcements—of 50,000- and 63,000-psi steel; hydroformed front rail sections; and 50,000-psi rear C-channel frame rails with eight separate crossmembers, including a new two-piece front suspension crossmember structure for a longer welded interface and greater frame strength.

RAM ELECTRICAL SYSTEMS and associated features completely facilitate upfits. Included: additional inputs/outputs, all of which are addressable through the SAE J1939-compliant CAN-bus Vehicle System Interface Module, access to over 70 vehicle features (including new lighting outputs and new PTO controls), seven trailer-tow circuits, six programmable in-cabin switches ... and much more.

THE PHYSICS OF 3500 CHASSIS CAB. It's all here: industry-standard 34-inch frame rail spacing; pre-drilled frame mounting holes; fuel-fill hose through the frame, and under-the-cab DEF tank positioned away from the upfit zone. Smart transmission design gives you left- or right-side PTO mounting—making choices simple and upfits a breeze.

NEW DEVELOPMENTS FOR IMPROVED PTO CAPABILITY. A quick summary shows an abundance of new PTO advantages: the auxiliary switch bank now offers six buttons—up from five. The new Mobile Mode RPM Up allows higher RPM (in stationary mode) via steering-wheel controls; it eliminates “feathering” the accelerator. The available Cummins® now provides a choice of two speeds in split-shaft mode; the PTO ramp rate is adjustable via the instrument cluster, plus a new Hard-Wire Remote Start/Stop, new PTO alarm—and even a new “memory” feature for its last known state.

RAM 2500/3500 PICKUPS

PUSH. PULL. HAUL. TOW. RAM HEAVY DUTY GETS IT DONE.

**AMERICA'S
LONGEST-LASTING
HEAVY-DUTY PICKUPS**²

UP
TO

**400 HORSEPOWER
1,000 LB-FT OF TORQUE
35,100-LB TOWING¹¹**



Properly secure all cargo. Always tow within the vehicle's capacity.

TOTALLY GROUNDED WITH HIGH-STRENGTH STEEL. YOUR CHOICE TO RIDE ON AIR. When you design a pickup meant to carry jaw-dropping payloads and haul heavy trailers, it's all about capability. The new 2019 Ram Heavy Duty 2500/3500 pickups take it to extremes, and it all comes together—with scores of best-in-class attributes, an upgraded rear-axle structural crossmember for available fifth-wheel and gooseneck hitches, new and tougher frames, exceptional suspensions and new, innovative technology.

RAM 2500 PICKUP

MAX GVWR: 10,000 LB⁶ • MAX GCWR: 27,000 LB⁶

BEST-IN-CLASS Available Max Diesel Towing up to **19,780 lb²⁰**

BEST-IN-CLASS Max Gas Towing up to **17,580 lb²⁰**

BEST-IN-CLASS Gas Horsepower **410 hp⁷**

MAX PAYLOAD: up to **4,050 lb¹¹**

CLASS-EXCLUSIVE Link coil Rear Suspension⁷

CLASS-EXCLUSIVE Available Rear Air Suspension⁷

RAM 3500 PICKUP

MAX GVWR: 14,000 LB⁶ • MAX GCWR: 43,000 LB⁶

BEST-IN-CLASS Available Diesel Torque up to **1,000 lb-ft⁷**

BEST-IN-CLASS Available Diesel Towing up to **35,100 lb⁷**

BEST-IN-CLASS Fifth wheel Towing up to **30,000 lb⁸**

BEST-IN-CLASS Available Diesel Payload up to **6,910 lb⁷**

BEST-IN-CLASS Gas Towing up to **18,210 lb⁷**

BEST-IN-CLASS Gas Payload up to **7,680 lb⁷**

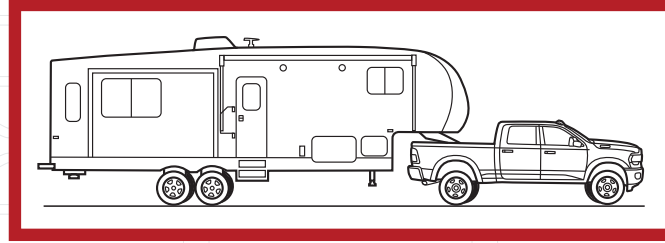
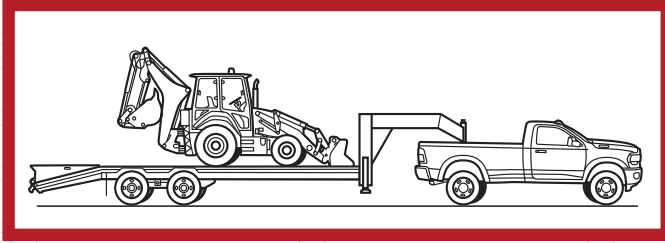

FIFTH-WHEEL/GOOSENECK varieties of towing rely on an upgraded, rear-axle structural crossmember. Note: along with the standard 4-/7-pin connector, the factory-installed Fifth-Wheel/Gooseneck Prep Group option includes an additional 7-pin connector integrated into the rear of the bed for easier access.

ANTICIPATE INCREASED HEAVY-DUTY CAPACITY.

Modifications to the frame, brakes and suspensions all result in improved capacity. The frames for all models in both weight classes benefit from the increased use of advanced high-strength steel and re-engineered crossmembers, along with the first use of aluminum in a Ram Heavy Duty chassis.

THE FINE-TUNED RAM 2500. For 2019 models, the chassis has an entirely new suspension tune, featuring smarter shock absorbers and progressive-rate springs. Bushings were re-engineered for greater durability and comfort. Further upgrades, including new engine mounts, help mitigate Noise, Vibration and Harshness (NVH).

CLASS-EXCLUSIVE: AVAILABLE AUTO-LEVEL REAR AIR SUSPENSION? This available asset allows selection between multiple modes. In Payload Mode, load-leveling is improved, so you're assured of a constant and level performance—especially while undertaking serious payload. The system constantly monitors heights on both sides of the vehicle, making critical adjustments in the cases of load shift or changes in road camber.

In Trailer Mode, the system maintains an even vehicle/trailer rake by lowering the rear suspension (about an inch), thus ensuring a parallel relationship between vehicle and trailer. There's also a Bed Lowering Mode, which brings the rear suspension to its lowest for easier trailer hook-up.

ONE OF THE BEST MEASURES OF TOWING: THE HITCH. Hitch receivers for Ram 2500/3500 pickups provide Class V capability. Offered in 2.5-inch sizes, hitch capacity for Ram 2500 is a robust 19,780 lb¹¹; for 2019 Ram 3500 pickups, the hitch capacity rating jumps up to 23,000 lb¹¹

FORTIFIED BACKBONE. RESILIENT STEEL FRAME. TOUGH CROSSMEMBERS. FORMIDABLE BRAKES.

RAM HEAVY DUTY. STRENGTH THAT ENDURES.

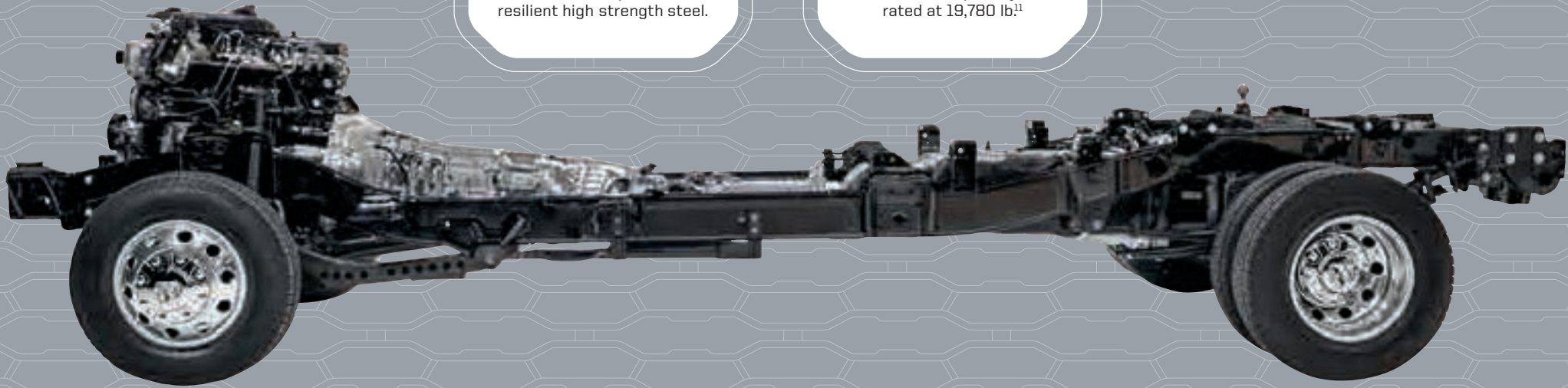

Durability is built into every Ram pickup. 98.5% of the redesigned Heavy Duty frame is comprised of resilient high strength steel.

Conventional hitch capability for a Ram 3500 pickup is a jaw dropping 23,000 lb.¹¹ For 2500, capability is rated at 19,780 lb.¹¹

On 4x4 pickup models, a 9.25 inch front axle features new pinion seals; a new axle housing reduces Noise, Vibration and Harshness (NVH).

Toughness is part of the engineering. Count on robust 63,000 psi steel for the new engine crossmember.

New suspension tuning on Ram 2500 includes new Frequency Response Damping (FRD) shocks and tough, progressive rate coil springs.

Upsized towing and brake system hardware now feature upgraded components to manage the increased max payload and tow ratings.

Working with the redesigned frame and the new suspension tuning for Ram 2500 is the new ZF 8HP75 8-speed automatic paired to the 6.4L HEMI[®] V8. To handle the increased towing and payload capacities, the ZF features torque-converter brazing, two gearsets with additional pinion gears and a heavy-duty Park system. Offering a level of shift refinement not usually seen in heavy-duty trucks, it also features fully electronic operation, an innovative and convenient rotary e-shifter, and on-the-fly shift mapping with more than 40 individual maps to optimize shift quality/points—regardless of load or conditions.



THE CLASS-EXCLUSIVE AVAILABLE AUTO-LEVEL REAR AIR SUSPENSION SYSTEM.⁷ We invite you to find another suspension system as refined as this one, available only for Ram 2500/3500 Heavy Duty models. This class exclusive system⁷ provides a comfortable ride while increasing control when hauling. The system includes Normal Load Leveling Mode and the driver selectable Alternate Ride Height Mode invaluable for trailer alignment, and sharply ramping up road manners; also included is a Bed Lowering Mode, which brings the rear suspension to its lowest setting for easier trailer hook up and which directs “bed spray” away from the truck. Shown at left is the Air Suspension on a Ram 3500 DRW where leaf springs are augmented with the axle mounted air springs.



CAPABILITY



400_{HP} 1,000_{LB-FT} OF TORQUE

AVAILABLE CUMMINS® HIGH OUTPUT TURBO DIESEL • THE AISIN® HEAVY-DUTY AUTOMATIC
With its available best in class diesel torque⁷, the available Cummins is stronger and more capable yet weighs some 60 lb less than the previous version. Major upgrades for 2019 address nearly every component, with the aim to improve torque responsiveness and capability. Among them: a new cylinder head. New exhaust valves and springs. New rocker arms. New forged connecting rods and bearings. Lighter, stronger pistons with new low friction rings. Improved variable geometry turbocharger. New fuel pump, fuel filter and fuel line system with a new 2,000 bar fuel rail.



LEGENDARY



410_{HP} 429_{LB-FT} OF TORQUE

THE 6.4L HEMI® V8 WITH VCT AND MDS • THE NEW ZF 8HP75 8-SPEED AUTOMATIC
Now mated to a new transmission for Ram Heavy Duty, the 6.4L HEMI V8 employs a number of engineering advantages for sheer power and refined performance, starting with Variable Cam Timing (VCT), which helps ensure stellar towing and payload capability with consistent power across a wide torque band. Efficient by design, the HEMI V8 also employs MDS/Fuel Saver Technology (transforming the tough V8 into an efficient 4 cylinder during highway cruising) and iDFSO, the interactive Deceleration Fuel Shut Off.

AVAILABLE INNOVATIVE SUSPENSIONS AND VIEWING TECHNOLOGY.

TOWING: ALWAYS READY TO GO.



Properly secure all cargo. Always tow within the vehicle's capacity.

LIGHTS. CAMERAS.
THESE ACTIONS HELP
YOU MASTER THE TOW.



ACTIVE FORWARD LIGHTING SYSTEM

TRAILER CAMERA¹⁸ WITH DISPLAY



SELF-LEVELING AIR SUSPENSION

BED LOWERING MODE WITH AIR SUSPENSION

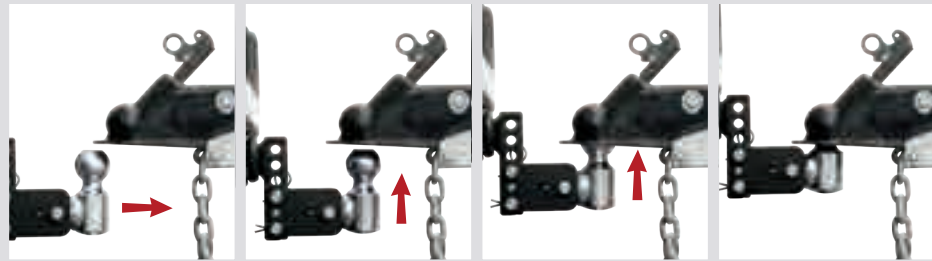

AVAILABLE: INDISPENSABLE SURROUND-VIEW AND BACK-UP CAMERAS.¹⁸

TOWING WITH RAM TRUCKS: ENJOY THE VIEWS.



Properly secure all cargo. Always tow within the vehicle's capacity.

FULL-TIME MONITORING OF YOUR TRAILER AND CARGO—AND IN REAL TIME. New thinking translates into towing operations that are faster, safer and more efficient. Above: the new available Trailer Reverse Guidance View¹⁸ delivers smart technology that lets you watch your trailer in real time, delivers a more secure means to park and maneuver long or short setups, and ensures greater confidence when dealing with tight loading docks. The system “stitches together” select views to create a single scene of both trailer sides; on-screen buttons let the driver pan left/right to better frame the trailer in the image when backing up. No active lines are provided.

NEW: AVAILABLE SURROUND-VIEW CAMERA SYSTEM:¹⁸ The 2019 Ram Heavy Duty and Chassis Cab models deliver next-generation camera technology, and it's another class-exclusive feature on Ram Chassis Cabs.¹⁷ The Surround-View Camera System¹⁸ takes images from multiple cameras to provide a “stitched-together” view as from above. It delivers a complete picture to the driver—especially helpful when parking in tight spaces, preparing to load or unload, or when hooking up a trailer. Ram 2500/3500 pickups display 360° visibility; Ram Chassis Cabs deliver 270° visibility. The combination of Surround-View and model-specific back-up images dramatically improves confidence and capability.

Ram 2500/3500 pickup: 360° Surround-View

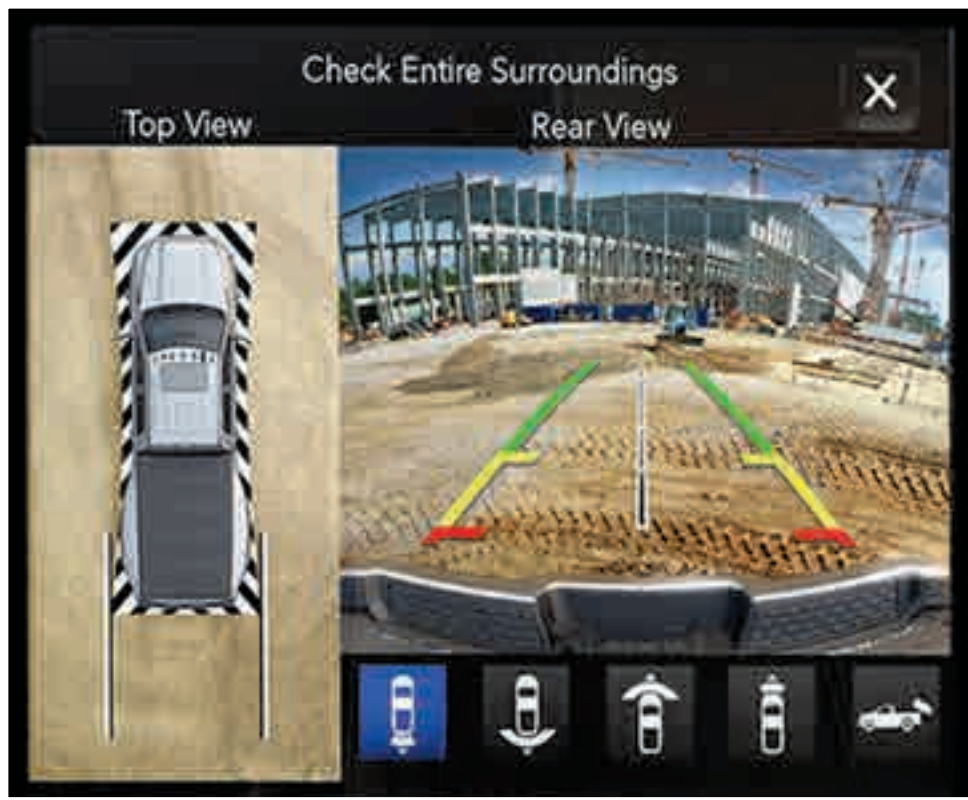

Ram Chassis Cab: 270° Surround-View

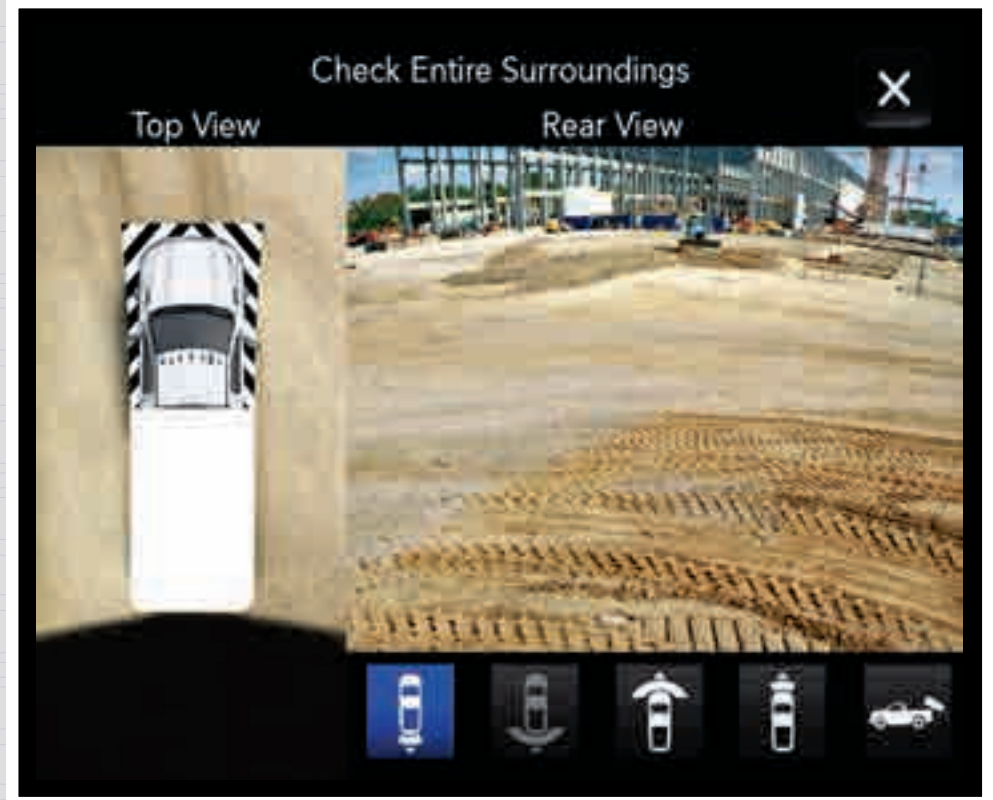

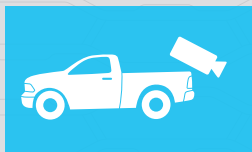
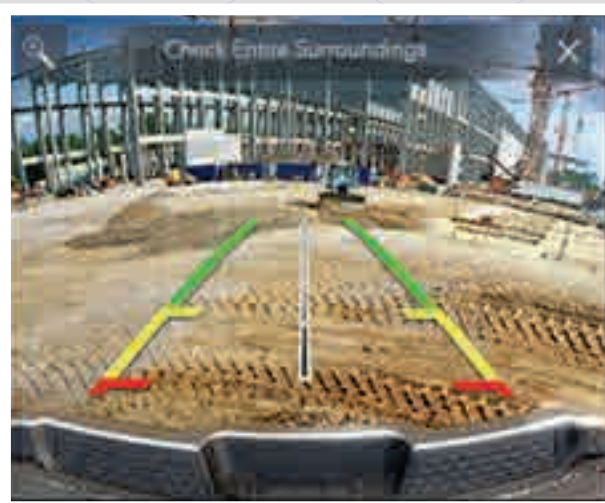
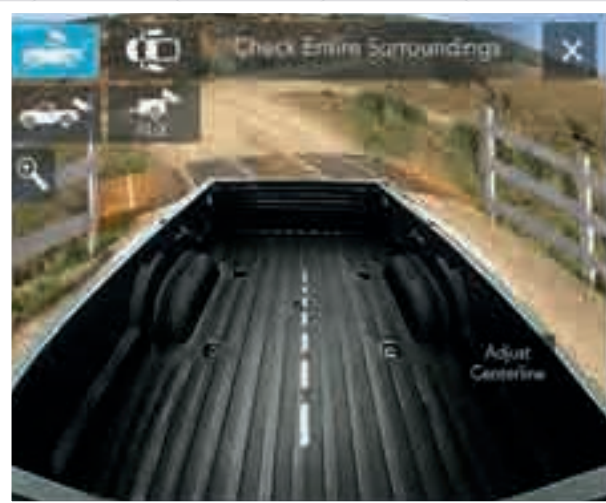

THE CHMSL CAMERA:¹⁸ Located in the Center High-Mount Stop Light (CHMSL), this available camera gives a high-perspective view of the vehicle rear, with the image displayed on the center-stack screen. Count on real-time views of the box cargo or in-box hitch status—like available fifth-wheel or gooseneck applications on pickups—or, on all models, aftermarket upfits.

THE PARKVIEW® REAR BACK-UP CAMERA:¹⁸ On pickups, the tailgate-integrated camera projects a center-stack image with dynamic gridlines and a centerline; when in Reverse, the gridlines become guide paths as the steering wheel is turned. On Chassis Cabs, the camera is upfit-mounted; gridlines are not included. Depending on model, the image is displayed on the center stack or in the rearview mirror.

AUXILIARY CAMERA SYSTEM:¹⁸ This system, available from Mopar®, enables complete customization: you determine the optimal position of the camera on your trailer, as shown on the inset above. Ample wiring will handle trailers up to 40 feet. The larger image displays the rear view as seen on the available full-color center-stack display. This system requires the Auxiliary Camera Prep Package.

ONE SYSTEM. ULTIMATE TECH CAPABILITY.

Customize the display to best serve your needs. Intuitive Uconnect® touchscreen lets you communicate, navigate and stay entertained. Available features include:



SIRIUSXM® RADIO²¹

Listen to music, talk shows and sports. Access all genres, favorite artists, winning teams—all the time—with SiriusXM Radio,²¹ including a one-year trial subscription.

NEW SIRIUSXM WITH 360L²¹ delivers more content and variety along with a personalized experience that is tailored to your listening habits.

SPEAK UP and be heard, all while driving safely with hands-free phone capability.²²

NAVIGATE to every adventure; get turn-by-turn directions so you don't get lost on the way (unless you want to).

UTILIZE Remote Services²³ from almost anywhere using your smartphone with SiriusXM Guardian^{TM24} and the Uconnect app.

DISCOVER new places, the best shopping, entertainment and restaurants from the Uconnect smartphone app, then easily send the address to your vehicle.

CONNECT faster than ever; expand your options by turning your truck into an on demand WiFi Hotspot²⁵ with rapid 4G LTE WiFi.²⁵

KEEP informed; receive weather and traffic reports with a five-year trial subscription to SiriusXM Travel Link^{21,26} and SiriusXM Traffic Plus.²¹



APPLE CARPLAY^{®27} SUPPORT

This is smarter iPhone® integration, so you'll experience your favorite features through your dashboard. With Siri,^{®28} all you have to do is ask—catch up on calls and messages, get directions from Apple Maps, or request a song through Apple Music.[®] The system lets you browse music or discover nearby gas stations, parking, restaurants and more. Plus, Maps helps predict where you're headed. Apple CarPlay screen shown above, top.



ANDROID AUTO^{TM29} INTEGRATION

For those who know and love Android,TM Android Auto brings your favorite smartphone apps into one place, making it easier to access your favorite apps on the road. Ask your Google Assistant to play your favorite songs and to help you get to your destination with Google Maps. Stay focused and connected while on the road with voice controls that allow you to send a message, set reminders, and more.



Images are for illustrative purposes only and may not reflect exact software for your vehicle.

RAM | **RAM TELEMATICS**
— POWERED BY VERIZON CONNECT —

-  VEHICLE DIAGNOSTICS
-  VEHICLE PERFORMANCE
-  VEHICLE TRACKING
-  DRIVER BEHAVIOR
-  DRIVER SAFETY & VEHICLE SECURITY

REAL-TIME DATA—FROM DRIVER TO VEHICLE. Ram Telematics™ is a comprehensive set of diagnostics available for all Ram Commercial Vehicles in our portfolio. For fleets of all sizes, it's the way to track expenses, operations and efficiencies.

Engineered specifically for the Ram Brand and powered by Verizon, new available Ram Telematics gives you instant and real-time on-screen monitoring of your vehicle(s); it provides complete visibility of your fleet operations; it communicates essential information about driver behavior, including seat belt usage, harsh braking, speeding and more. Most importantly, it delivers bottom-line, business-savvy efficiencies with proven return on investment. Tracking nearly 100 mechanical functions, the system helps keep your vehicle in top-notch condition, lets drivers make better decisions and increases uptime. The numbers say it all: **15% greater productivity. 20% more vehicle utilization. 25% less fuel expenses. 30% reduction in idle time. 10% fewer miles driven—and 15% less overtime.**

SMART TECH IS HOW WE WORK.

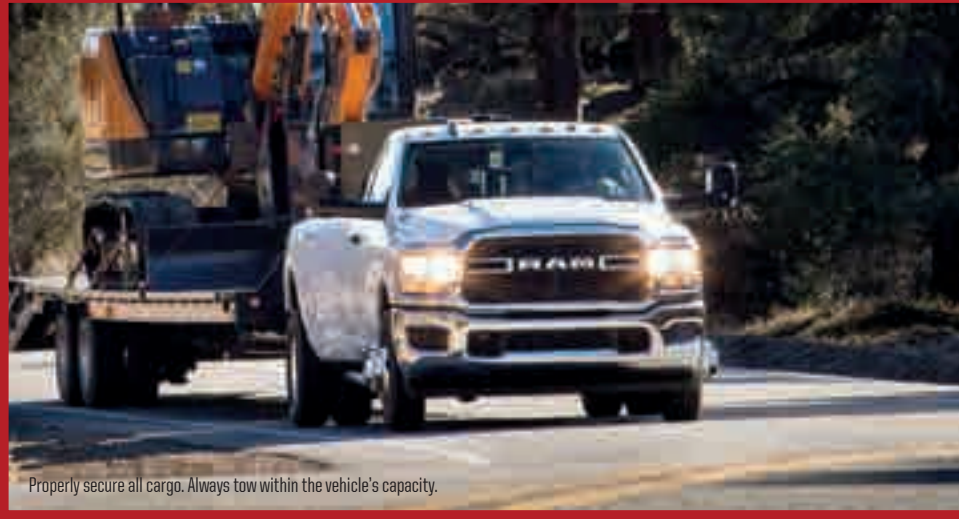

A 2019 Ram truck embraces safety and security—and new additions in this area provide greater control and confidence than ever. New available features include:

- ▶ **Forward Collision Warning with Braking³¹** detects when the vehicle is approaching another vehicle or large obstacle too quickly. It prepares the brakes for emergency braking and visually and audibly alerts the driver (including a quick “brake jerk”). If the driver isn’t braking hard or fast enough, the system will apply the brakes automatically, even bringing the vehicle to a stop if traveling under 31 mph.
- ▶ **Adaptive Cruise Control with Stop³²** This system features full functionality between zero and 100 mph, automatically adjusting the cruise control to a safe distance (selected by the driver) when slower traffic speeds are detected.
- ▶ **Blind Spot Monitoring³³ with Rear Cross-Path Detection¹⁸** Available only for Ram 2500/3500 Heavy Duty, it uses dual wide-band radar sensors to monitor the pickup’s blind spots and notifies the driver when a vehicle is present—during lane changes, when passing other vehicles or when being passed.

All Ram braking systems feature Electronic Stability Control (ESC)³⁴. ESC³⁴ features multiple assets for braking, including:

- ▶ **All-Speed Traction Control.** If slippage occurs during acceleration, automatic throttle control will reduce torque; in extremes, it will apply the brakes and reduce engine power to maintain control.
- ▶ **Trailer Sway Damping³⁴** detects yaw and applies the tow vehicle’s brakes to reduce the sway.

- ▶ **Electronic Brake-Force Distribution** regulates brake pressure to minimize stopping distances.
- ▶ **Ready Alert Braking** senses when the driver’s foot is lifted from the accelerator; it applies an imperceptible brake force to ensure that pads and discs are lined up should an emergency stop be required.
- ▶ **Rain Brake Support** automatically activates when the windshield wipers engage; brake calipers pulse against their rotors to remove water from the pads.
- ▶ **Hydraulic Boost Compensation.** Should a failure occur in the vacuum brake booster or any related line, the brake controller will run the ABS pump and convey the problem to the driver. The brakes perform as normal until the failure is serviced.
- ▶ **Hill Start Assist.** On an incline, this system keeps the vehicle stationary for two seconds after release of the brakes or until the accelerator is depressed.
- ▶ **ParkSense® Front and Rear Park Assist¹⁸** Available. It detects objects as far as 47 inches away from the bumpers; read-outs located in the gauge cluster display team up with audible chimes to notify the driver of proximity to front and/or rear objects.

AN OVERRIDING CONCERN FOR YOUR SAFETY AND SECURITY. The more technology we put into your Ram truck, the greater the benefit. Case in point and based on model: comprehensive standard and available safety and security features that now include Trailer Reverse Guidance,¹⁹ Lane Departure Warning³⁰ (1500 only) and Adaptive Headlamps. Illustrated above, counterclockwise: available ParkSense® Front and Rear Park Assist;¹⁸ Forward Collision Warning³¹ and Adaptive Cruise Control with Stop³². More at ramtrucks.com/commercial

NEXT-LEVEL STORAGE SOLUTIONS.

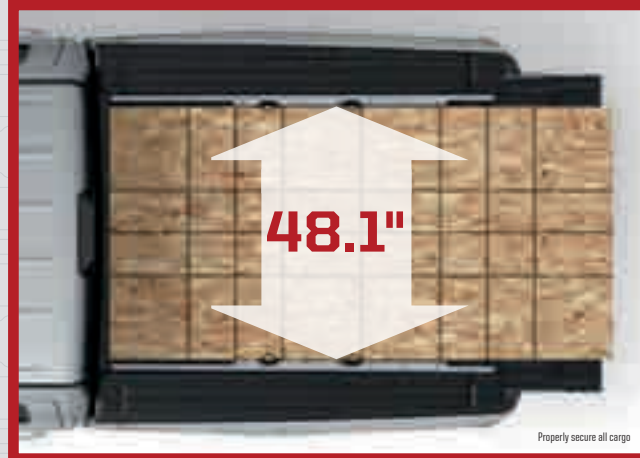

If your commercial vehicle is a Ram pickup, count on using smarter and more efficient ways to handle cargo. Alongside scores of in-cab storage compartments (on all pickup models) is a brilliant and innovative asset: the available RamBox Cargo Management System, now including a built-in 400-watt, 115-volt power outlet. For multiple solutions in a single pickup, welcome to the real-world capability of 2019 Ram trucks.

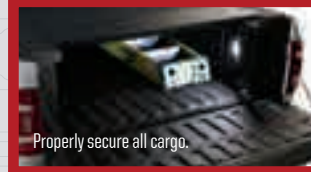

STANDARD 4x8 SHEETS FIT. Opting for the available RamBox® Cargo Management System doesn't reduce the cargo carrying capability you count on. All cargo beds with the RamBox System easily accommodate everyday sheets of building materials.

NEW TAILGATE TECHNOLOGY. A new damped tailgate lets you open it more slowly and close it with less force. The tailgate also features an available power release function; open it with the key fob button or via the in cabin control on the overhead console.

IN-BED LED LIGHTING. Controlled by a switch or a key fob button, these available side cargo bed lights let you load anytime. If your cargo bed is protected by an available tonneau cover, no adjustments are necessary.

NEW RETRACTABLE BED STEP. The available Mopar® Bed Step makes getting in and out of your cargo bed easier than ever. A simple foot motion pops it out for easy access; reverse it to tuck it under the cargo bed. Made of tough steel, it's easily installed and is covered with a slip resistant rubber coating for sure footing. Available as a factory installed option or as a stand alone Mopar Accessory.

MANAGE AND SECURE YOUR CARGO. The RamBox System offers available features like a cargo rail system with four adjustable tie down cleats that'll keep your cargo securely in place. Want to keep certain items of cargo separate? The RamBox System offers a bed divider that lets you accomplish what the name implies outstanding cargo management.

RAM 1500 PICKUP

NEW FOR 2019, IT'S STRONGER THAN EVER.

MOTORTREND
TRUCK OF THE YEAR 2019



STRONGER FRAME. RAMPED-UP CAPABILITY. The new 2019 Ram 1500 is all about capability, comfort and technology. Among its top-tier advantages: best-in-class standard V6 horsepower.⁹ Best-in-class V8 towing.⁹ The largest brakes in its class⁹—14.9-inch rotors in front, 14.8-inch in the rear. Ample bed volume with spacious available interior storage. Even the new aerodynamics are best-in-class.⁹ For comfort and technology, count on an available class-exclusive 12-inch touchscreen media center,⁹ the highest number of speakers in its class⁹ and the most powerful audio system in its class⁹—the available Harman Kardon[®] Surround Sound.

eTORQUE TECHNOLOGY: MAIN FEATURES. Now available for 2019 Ram 1500 engines, eTorque is a mild hybrid system which eliminates the alternator and combines a motor generator with a 48 volt battery. Main technological features include:

- ▶ **ELECTRIC POWER BOOST**, which provides increased efficiency and greater supplemental torque during acceleration and enables the HEMI[®] V8 Multi Displacement System to operate longer while in 4 cylinder mode.
- ▶ **STOP/START TECHNOLOGY** helps to measurably improve efficiency by seamlessly turning off the engine at idle stops and restarting operation at acceleration. With eTorque, the engine restart takes only half the time compared to normal Stop/Start.
- ▶ **REGENERATIVE BRAKING** recovers braking energy and converts it into electricity which helps recharge the onboard battery system.

RAM 1500 PICKUP

MAX GVWR: 7,100 LB⁶ • MAX GCWR: 18,200 LB⁶

CLASS-EXCLUSIVE Available Active Level Four Corner Air Suspension System⁹

CLASS-EXCLUSIVE Available RamBox[®] Cargo Management System⁹

CLASS-EXCLUSIVE Link coil Rear Suspension⁹

CLASS-EXCLUSIVE Available 12 inch Touchscreen Media Center⁹

BEST-IN-CLASS V8 TOWING—up to 12,750 lb⁹ (HEMI V8)

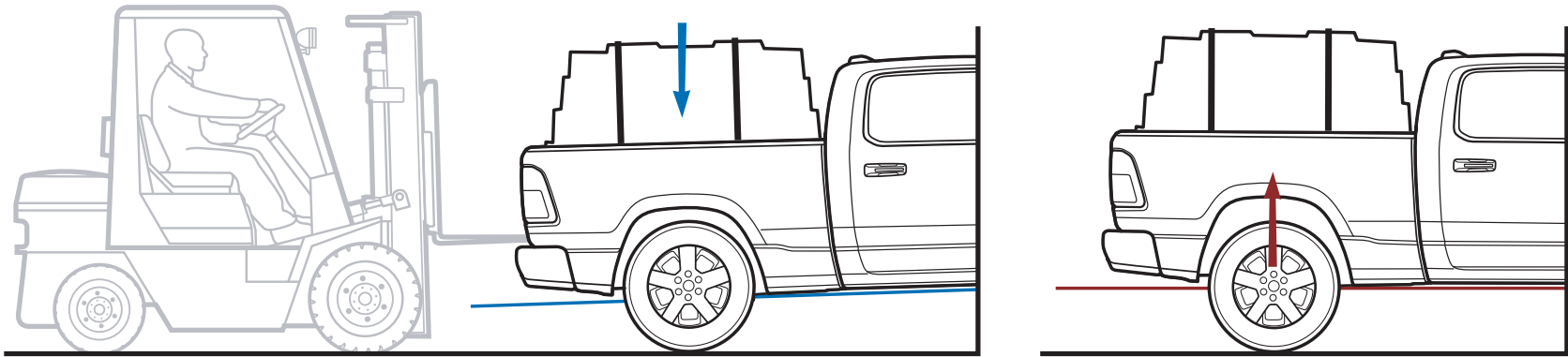

THE AVAILABLE CLASS-EXCLUSIVE ACTIVE-LEVEL™ FOUR-CORNER AIR SUSPENSION SYSTEM⁹ Pioneered by Ram 1500, it remains unique to the Light Duty Truck segment. Either automatic or driver operated, the system is available on select trim levels, with five modes that address a wide variety of needs, including off road ride height, aerodynamic efficiency, ease of cargo access and occupant convenience.

Modified for the new 2019 Ram 1500, the Active Level Four Corner Air Suspension System uses a redesigned air supply component in a single unit to reduce weight and increase capacity. It's also been retuned for the new, lighter weight frame and chassis components.

The five operational modes are engineered to deliver outstanding performance from your Ram 1500. They include two Off Road heights, the Aero Mode, Normal Ride Height and the chassis lowering Entry/Exit Mode.



ALL-NEW MULTIFUNCTION TAILGATE. Our newest available innovation greatly expands access to the cargo bed of your 2019 Ram 1500. The new design features conventional tailgate operation along with 60/40 split swing away doors that open 88° wide. Thoroughly robust with a 2,000 lb load rating, this tailgate design offers many benefits, including the ability to access the bed closer to the bumper for easier step up, loading/unloading even forklift loading. Washing out the bed is more convenient and, unlike other multi element tailgates, the Ram multifunction tailgate doesn't require removal of a trailer and hitch before opening. Optional on all trims except HFE; requires spray in bedliner.

BREAKTHROUGH SUSPENSIONS FOR AWESOME TOWING.

TAKE IT ON. *CONFIDENTLY.*



INCREASED COMFORT.
GREATER CONTROL
FOR ALL TOWING.

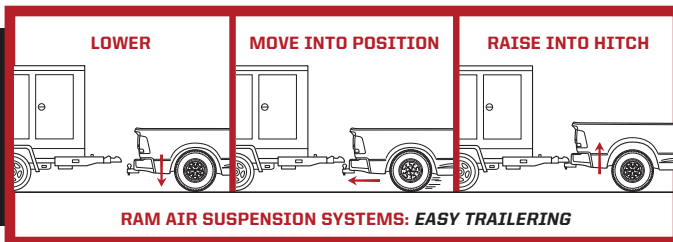

The new frame is comprised of high-strength steel, advanced high-strength steel and, in select areas, aluminum. From there, a long list of Ram 1500 advantages takes your towing to commercial-grade levels. Among them: the available Active-Level™ Four-Corner Air Suspension and the standard Tow/Haul Mode—both controlled with fingertip ease from the switch bank. Further assets include the standard Parkview® Rear Back-Up Camera,¹⁸ available 7- x 11-inch trailer-tow mirrors, huge brake rotors and the new standard Pentastar® V6 with eTorque. For added capability, Ram 1500 can take your trailering up to best-in-class V8 towing of 12,750 lb⁹ with the available 5.7L HEMI® V8 with eTorque and Max Tow Package.

SILENT, SLEEK, WELCOMING: THIS IS A PREMIUM WORK TRUCK.

RAM INTERIORS. THE FINER SIDE OF REFINEMENT.



Ram Chassis Cab SLT interior shown with optional equipment.

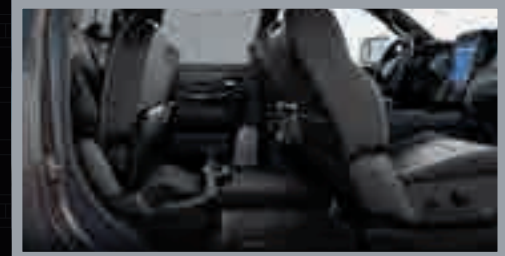
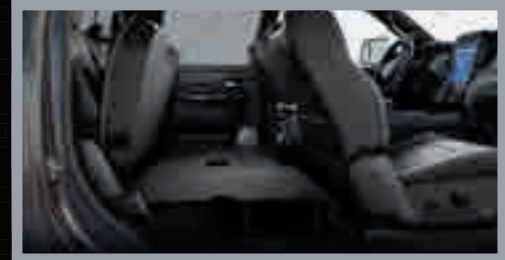

RIDE A WORKHORSE WITH UNEXPECTED SOPHISTICATION. You've made it in business—and Ram trucks make your drive a pleasure. With true-fidelity audio. Media hubs with USB ports. Eye-pleasing instrumentation. From the rugged Tradesman[®] to the cloth treatment of SLT, above, to the leather/real wood trim of Limited to a Ram 2500/3500 Mega Cab[®] pickup—think best-in-class interior storage⁷ and class-exclusive reclining rear seat^{7,41}—every Ram truck delivers exceptional comfort and technology.

CONVENIENT FOLD-FLAT LOAD FLOORS. When you need to carry valuable cargo best left inside, we have the answer: a rear area that converts to a genuinely flat floor in moments. On Ram 1500 Classic Quad Cab[®] and Crew Cab; on 2500/3500 Crew Cab; and on 3500/4500/5500 Chassis Cab Crew Cab models.

MEGA CAB[®]: BEST-IN-CLASS INTERIOR STORAGE⁷ and a class exclusive rear reclining seat^{7,41} show ample proof of our focus on occupant comfort.

THE REAR IN-FLOOR STORAGE OF CREW CAB. All models give you handy in cab storage, but Ram Crew Cab models take it one step further, making available two removable, drainable and practical in floor bins.

RAM 1500 CLASSIC PICKUP

TRADITIONAL VALUES BUILT ON STRENGTH AND STYLE.



Properly secure all cargo. Always tow within the vehicle's capacity.

CLASSIC FRAME STRENGTH CONTINUES. Think high strength steel core, eight ultra tough crossmembers for formidable structural integrity and a hydroformed tubular front frame unit also high strength steel. Working together, it all creates the ideal foundation for the commercial grade towing and hauling assignments you'll face.

CLASS-EXCLUSIVE LINK-COIL REAR SUSPENSION³⁵ It's still one of the major engineering features that separates Ram 1500 from the competition. Our long established multi link coil spring rear suspension offers a degree of strength and durability the others simply can't match.

WHERE IT ALL COUNTS: TOWING. The structural rear bumper is rated for Class III towing. To address more arduous commercial grade assignments, add the available factory installed Class IV hitch receiver to confidently take on trailers up to 10,710 lb¹¹

IDEAL, FROM AERODYNAMIC EXTERIOR TO REMARKABLE POWERTRAINS. Look beyond its proven towing and hauling capability, and you'll see that the strengths of Ram 1500 Classic are also measured in awards, in resale value, and by its classic styling—three of many reasons why the Ram 1500 Classic remains a top pick. Sleek exterior lines, impressive interiors with state-of-the-art technology and your choice of three superb engines—including the available and groundbreaking 3.0L EcoDiesel V6—all add up to one pickup that will carry on when competitive models fade in the dust. Ram 1500 Classic has it: traditional style and long-proven strength.



INSTANT CONTROL AT YOUR FINGERTIPS. Ram 1500 Classic features an at hand integrated switch bank for instant operational control over multiple areas. Among them: an on/off switch for the Electronic Stability Control³⁴ system, buttons for the available ParkSense[®] Park Assist System,¹⁹ operating the Trailer Brake Controller, and maintaining the available heated seats and heated steering wheel on Ram Big Horn models.

RAM 1500 CLASSIC PICKUP

MAX GVWR: 6,950 LB⁶ • MAX GCWR: 15,975 LB⁶

CLASS-EXCLUSIVE Rear multi-link coil spring rear suspension³⁵

CLASS-EXCLUSIVE Available RamBox[®] Cargo Management System³⁵

MAX TOWING: up to 10,710 lb¹¹ (HEMT[®] V8);

up to 9,260 lb¹¹ (EcoDiesel V6)

STANDARD Class IV hitch receiver (Tradesman[®])



SHARP, SMART INSTRUMENTATION. Ram 1500 Classic controls and gauges are hand friendly and easy on the eye. The Big Horn® model, above, is all about convenience: steering wheel mounted controls, six ring instrumentation cluster, rotary dial shifter, full color touchscreen and bright painted accents.

KEEP THE IMPORTANT STUFF SAFE AND SECURE. Subtle storage pays off big for items best left out of sight. The in floor, removable bins on Ram 1500 Classic Crew Cab models come in very handy for valuables and small tools.

INSTANT FLAT-FLOOR STORAGE. Quad Cab® and Crew Cab rear seating area easily converts into a true flat load floor when cargo is best transported inside.



THE 3.0L ECODIESEL V6. Ram 1500 made history with its introduction of this diesel in a light duty pickup. Ram 1500 Classic carries it on. With its B20 (biodiesel) compliance, this available powerhouse delivers significant torque for towing and hauling, great efficiency and an exceptional warranty.



THE 5.7L HEMI® V8 WITH MDS/ FUEL SAVER TECHNOLOGY. Few engines carry its clout or its heritage of the innovative hemispherical head. Fewer still feature the ingenious Multi Displacement System, which transforms the mighty V8 into an efficient yet robust 4 cylinder during highway cruising.



THE 3.6L PENTASTAR® V6. This engine exhibits numerous performance and engineering attributes which include a thermal management system that helps keep critical components operating at ideal temperatures.

RAM PROMASTER®

PURE FUNCTIONALITY MEETS NEAR UNLIMITED POTENTIAL.



Properly secure all cargo.



Properly secure all cargo.

IT'S MUCH GREATER THAN THE SUM OF ITS PARTS. The nimble Ram ProMaster steps up to virtually every task out there. Consider: a selection of Cargo and Windowed Vans, Chassis Cabs and Cutaways for whatever fits your requirements. Three series: 1500, 2500 and 3500. Standard front-wheel drive. Depending on your selection, Standard or High Roof. Three wheelbases: 118-, 136- and 159-inch. For Cargo Van, four overall lengths. Now in its third generation, this long-proven commercial van features standard ABS, Traction Control, Trailer Sway Control³⁴ and an available factory-installed trailer hitch for towing up to 6,800 lb.¹¹

BEST-IN-CLASS STANDARD V6 HORSEPOWER¹² Nothing quite matches the award winning 3.6L Pentastar® V6 and Ram ProMaster makes the most of it. Churning out a no nonsense 280 horsepower backed with 260 lb ft of torque, this engine has proven itself over multiple generations and applications.

CARGO VAN: MEETING EVERY MAJOR CARGO AREA REQUIREMENT. What counts big here is what you're counting on, and it measures up every time and in every dimension. Ram ProMaster gives you best in class standard cargo height,¹² best in class maximum cargo width,¹² best in class width between the wheel wells,¹² and the combination that works: best in class tallest and widest standard cargo area,¹² with interior volume maxing out at a jaw dropping 462.9 cu ft.

WHAT'S NEXT IS WHAT YOU MAKE IT. With this degree of designed in versatility, any Ram ProMaster model can become pretty much anything. Cargo Vans become mobile workshops, moving offices and custom delivery vehicles which frequently take advantage of our available partitions. Ram ProMaster Chassis Cab and Cutaway models have been modified into everything from service vehicles to ambulances. For more, visit us at ramtrucks.com/commercial

SHORT WHEELBASE MODELS: BEST-IN-CLASS TURNING DIAMETER¹² All models have impressively compact turning diameters it's what makes Ram ProMaster the ideal choice for cities and suburbs but our short, 118 inch wheelbase takes top honors with its best in class 36.3 ft turning diameter.¹²

ALL MODELS: CLASS-EXCLUSIVE FRONT-WHEEL DRIVE (FWD)¹² FWD is the ideal way to go. It offers a balance between the front of the vehicle and the weight of cargo in back, while also lowering the overall platform and thus lowers the center of gravity for more confident handling and maneuvering.



RAM PROMASTER

MAX GCWR: 12,000 LB⁹

MAX TOWING: 6,800 LB¹¹ • MAX PAYLOAD: 4,430 LB¹¹

BEST-IN-CLASS Turning Diameter (118 inch Wheelbase)¹²

BEST-IN-CLASS Lowest Load Floor Height¹²

BEST-IN-CLASS Standard V6 Horsepower 280 hp¹² with 260 lb-ft of Torque

CLASS-EXCLUSIVE Front Wheel Drive (FWD)¹²

CLASS-EXCLUSIVE
FRONT WHEEL DRIVE CAPABILITY¹²

BEST-IN-CLASS
LOWEST LOAD FLOOR HEIGHT¹²

BEST-IN-CLASS
TALLEST AND WIDEST STANDARD CARGO AREA¹²

BEST-IN-CLASS
STANDARD V6 280 HORSEPOWER¹²

STANDARD
ELECTRONIC STABILITY CONTROL³⁴

MONITOR IT ALL REMOTELY
AVAILABLE RAM TELEMATICS™

STANDARD
PARKVIEW® REAR BACK UP CAMERA¹⁸

FORKLIFT-FRIENDLY
SIDE AND REAR DOORS WELCOME A STANDARD PALLET

NEAR-VERTICAL SIDE WALLS
FOR CUSTOM UPFITS AND TO MAXIMIZE CAPABILITY



COMPLETE VISIBILITY, FOR BUSINESSES AND FLEETS. Whether you run a company or a fleet, get the most from your Ram ProMaster® with Ram Telematics. Available for all vehicles in the Ram Commercial portfolio, Ram Telematics tracks expenses and follows driver behavior, with a solid return on investment.

Dealer or factory installed, available Ram Telematics performs numerous functions to transform your business. It connects your vehicles. It provides insights to driver behavior like seat belt use, harsh braking and speeding. It creates actionable fleet analytics, with real time alerts and extensive reporting.

Tracking some 100 mechanical functions, the focus of this comprehensive system is all about reducing total costs of ownership, helping to keep your vehicle in top notch condition, encouraging drivers to make better decisions and increasing uptime. The numbers say it all: **15% greater productivity. 20% more vehicle utilization. 25% less fuel expenses. 30% reduction in idle time. 10% fewer miles driven. 15% less overtime.** See more at ramtrucks.com/telematics



RAM TELEMATICS
— POWERED BY VERIZON CONNECT —



YOUR BUSINESS ON THE MOVE.

RAM PROMASTER® CARGO VAN: DESIGNED TO ADAPT AND SERVE. BUILT TO EXCEL.

It's a clean slate that you'll turn into a working masterpiece. Every interior of a 2019 Ram ProMaster delivers exactly the right features that translate into a customized workspace, delivery van—or whatever suits you best. With its flat load floor and best-in-class lowest floor height,¹² Ram ProMaster gives you nearly vertical side walls and pallet-welcoming rear and side sliding doors, while the available High Roof option provides enough standing room that a 6-foot, 3-inch occupant can work without stooping. It all boils down to pure adaptability, inviting the installation of shelving, the creation of a mobile workspace or the design of an interior specific to your needs. See more at ramtrucks.com/commercial

BEST-IN-CLASS

CARGO WIDTH¹²
(CARGO VAN)



4 CARGO LENGTHS



118 inch wheelbase



136 inch wheelbase



159 inch wheelbase



159 inch wheelbase, extended

2 ROOF HEIGHTS

STANDARD ROOF



BEST-IN-CLASS
STANDARD ROOF CARGO HEIGHT¹²

AVAILABLE HIGH ROOF



RAM PROMASTER CITY[®]

RIGHT-SIZED FOR THE RIGHT REASON: TOTAL EFFICIENCY.

**AMERICA'S
MOST EFFICIENT
WORK VAN¹**



Properly secure all cargo.

BEST-IN-CLASS 28 MPG HWY FUEL ECONOMY.¹³

GAIN HUGE ADVANTAGES WITH AMERICA'S MOST EFFICIENT WORK VAN!¹

Make your next work van a 2019 Ram ProMaster City Cargo Van and reap the benefits of best-in-class payload¹⁴ and cargo capacity.¹⁴ All models boast best-in-class highway fuel economy of 28 mpg hwy¹³—thanks in part to the 2.4L Tigershark[®] MultiAir[®]2 inline 4-cylinder with its best-in-class horsepower and torque¹⁴ and 0-30 mph in 3.7 seconds.³⁶ Add a 9-speed automatic, a class-exclusive bi-link rear suspension¹⁴ and time-saving oil change intervals. Every ProMaster City model features an ultra-comfortable interior, with Cargo Van models welcoming an upfit.

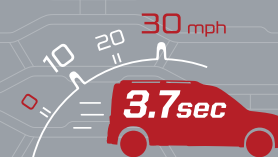

IMPECCABLE HANDLING, STEERING AND LOADING CAPABILITY. Hydraulic steering and front wheel drive (FWD) ensure a tight turning radius and contribute to the low, flat load floor. The standard adjustable tilt/telescoping steering column is an unusual convenience for the commercial sector.

RESILIENT FRAME STRENGTH AND UNIBODY DESIGN. Both contribute to the best in class payload of up to 1,883 lb¹⁴ and best in class GVWR of 5,395 lb^{6,14}. Further capability comes from the GCWR of 5,900 lb⁶ and the unsurpassed towing in its class of up to 2,000 lb¹⁴.



RAM PROMASTER CITY®

MAX GVWR: 5,395 LB⁶ • MAX GCWR: 5,900 LB⁶

BEST-IN-CLASS Highway Fuel Economy **28 mpg hwy¹³**

BEST-IN-CLASS Cargo Capacity **131.7 cu ft¹⁴** (Cargo Van Models)

BEST-IN-CLASS Max Payload: **1,883 lb¹⁴** (Cargo Van Models)

CLASS-EXCLUSIVE **9-speed** Automatic Transmission¹⁴

UNSURPASSED Max Towing: **2,000 lb¹⁴** (Cargo Van Models)

BEST-IN-CLASS Horsepower and Torque **178 hp/174 lb-ft of torque¹⁴**

CLASS-EXCLUSIVE Bi link Rear Suspension¹⁴

BEST-IN-CLASS GVWR **5,395 lb^{6,14}**

CLASS-EXCLUSIVE BI-LINK REAR SUSPENSION!¹⁴ Our bi link rear suspension engineering meets two major mandates: be super comfortable for the ride and be super capable for the payload. Confident hauling and enhanced stability come from the tough suspension, telescopic twin tube hydraulic shocks and a solid 16 mm stabilizer bar.

SMARTLY STYLED AERODYNAMIC EXTERIOR. Those side sliding doors close snugly into the sides to create a smooth surface that allows wind to glide around Ram ProMaster City. Thoroughly wind tunnel tested, these tough partners deliver a sleek and super low drag coefficient [CD] of only 0.30 a factor behind the quiet ride and a contributor to efficiency.

EFFICIENT PERFORMANCE, BEST-IN-CLASS DRIVING RANGE with standard motor³⁷ estimated up to 448 miles with 87 octane regular gas. It means every drop of fuel counts and you're reducing your time spent at the pump. Time and money saving oil change intervals round it out: you can actually drive up to 10,000 miles between recommended oil changes.

DESIGNED FOR VIRTUALLY UNLIMITED VERSATILITY.

IT'S A GREAT PLACE TO WORK: RAM PROMASTER CITY.®

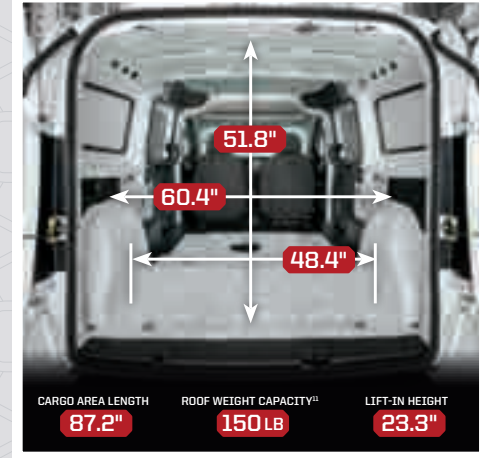

IMAGINE A MULTI-DIMENSIONAL TOOLBOX THAT OPENS UP POSSIBILITIES. It's surprising just how much you can do with a 2019 Ram ProMaster City Cargo Van. Consider: best-in-class payload—up to 1,883 lb.¹⁴ Best-in-class cargo capacity—131.7 cubic feet,¹⁴ pretty much the volume of three washer/dryer sets. Best-in-class cargo width¹⁴—which permits loading a standard pallet. As shown, an aftermarket shelf system can be installed on the walls with easy accessibility from the rear door. This versatile Cargo Van opens up a world of possibility.

INTELLIGENTLY APPOINTED, INCLUDING REAR BACK-UP CAMERA¹⁸ Standard on Ram ProMaster City, the ParkView[®] Rear Back-Up Camera System¹⁸ automatically displays the rear scene on the Uconnect[®] 3 with 5-inch color touchscreen display when in Reverse. The on-screen gridlines help when backing up to docks and trailers or into parking spaces.

AVAILABLE PARKSENSE[®] REAR PARK ASSIST SYSTEM¹⁹ This system is an important asset, helping keep the driver alert to his or her surroundings. Activated under 8 mph when in Reverse, it projects audible warnings that increase in intensity as the vehicle nears obstructions to the rear.

FLAT FLOOR, NEARLY VERTICAL SIDE WALLS. These are two upfit-enabling factors that welcome customization. The walls allow upfitters to efficiently install materials; the floor gives you access and freedom to design it.

READILY ACCOMMODATES A STANDARD PALLET. Rear doors are designed with practicality and safety in mind, using a 60/40 split with the larger door logically on the left. Open both rear doors, and you've got a huge, 180° opening, with enough door and interior width to accommodate a pallet.

NEED MORE CAPABILITY? CHECK OUT THE FLOOR—AND HIT THE ROOF. When it came to maximizing capability, our designers considered it all—which is why you'll find six standard in-floor tie-down rings on this Cargo Van.

Add further capability by using the roof. Six pre-drilled, factory-installed, in-roof anchor points are in place—and ready for numerous aftermarket accessories, including available Roof Rails from Mopar[®]. Molded in color with a Silver finish, they carry a max rating up to 150 lb¹¹—a figure that easily enables items like aluminum ladders and other equipment to be loaded and secured on top.

YOU SHOULD ALWAYS BE COMFORTABLE ON THE JOB.

THE RAM PROMASTER interior is spacious, designed for easy operation, and features many personal touches. Among them: huge windshield with solar-filter glass. High-positioned seats for great visibility. Your choice of numerous available seating configurations. Instrumentation is hand- and eye-friendly. Storage includes cup holders, glove boxes—and an optional overhead shelf that can hold up to 44 lb.



Properly secure all cargo.

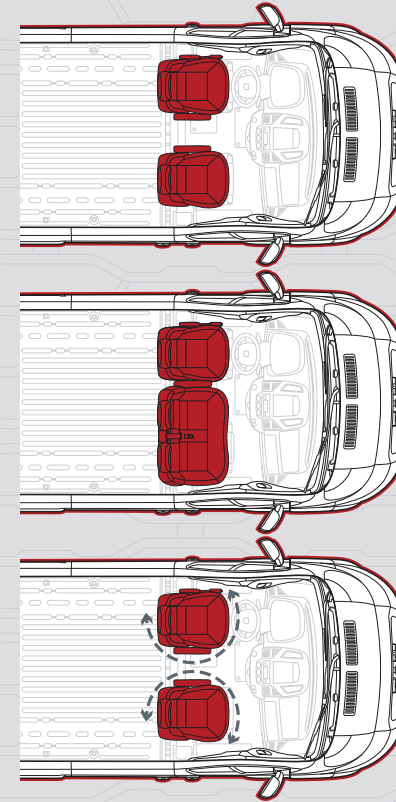

NEW SECOND-ROW SEATING. Many will need every square inch of cargo room for the job—but if you're looking to accommodate people as well as cargo, there's an easy aftermarket solution. This available crew van seat upfit for Cargo Van is from our colleagues at Snoeks Automotive.



BUCKET SEATS. Standard tubular structured four way bucket seats feature spring suspension and woven cloth. Available: six way adjustable seats in cloth or vinyl with manual lumbar support and heated seat surfaces.

DRIVER'S SUSPENSION BUCKET SEAT. The available premium driver's suspension bucket seat adds a pneumatic suspension and a weight/size conformity adjustment knob.

THREE-OCCUPANT SEATING. Here, the single driver's bucket seat is joined by an integrated two person bench seat; in cab capability is also enhanced: the middle seatback insert folds down to become a convenient writing surface.

SWIVEL SEATING. Need to access the rear compartment with ease? Available swivel bucket seats in long wearing cloth are the answer with 180° inboard swivel range, 35° outboard swivel, a 58° recliner and a continuous height adjuster.

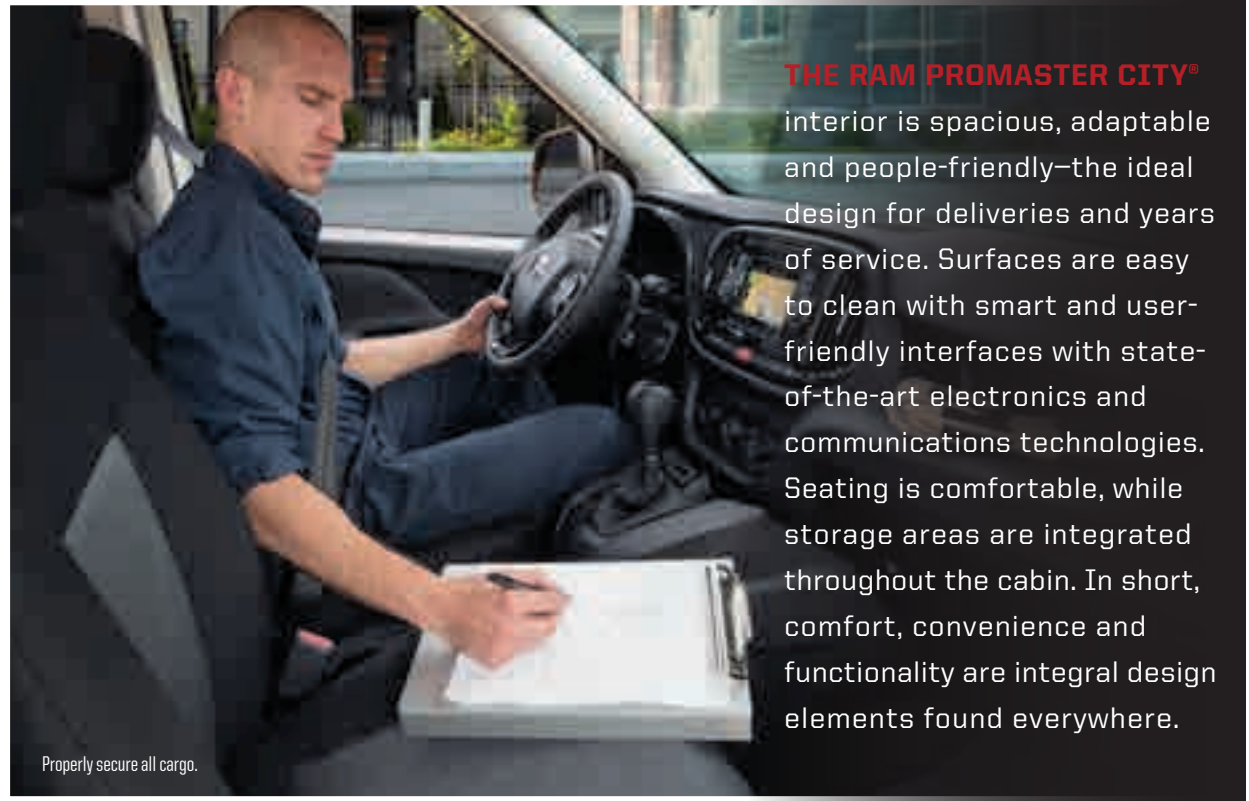

THE RAM PROMASTER CITY[®] interior is spacious, adaptable and people-friendly—the ideal design for deliveries and years of service. Surfaces are easy to clean with smart and user-friendly interfaces with state-of-the-art electronics and communications technologies. Seating is comfortable, while storage areas are integrated throughout the cabin. In short, comfort, convenience and functionality are integral design elements found everywhere.

RAM PROMASTER CITY: DETAILS THAT ARE JUST PLAIN SMART.

The large, standard overhead front shelf system stashes everything from gloves to ice scrapers to notebooks. An oversized glove box (176.9 cu in) joins a large, open, 12 x 4 inch in dashboard storage bin; the concave storage tray in front of the driver is ideal for valuables and personal devices. To that, add multiple storage pockets and trays around the media center, a center console with two cup holders, two 12 volt capped auxiliary power outlets, and USB and auxiliary connections for smart and intuitive charging.



RAM POWERTRAINS

RAM 3500/4500/5500 CHASSIS CAB



360 HP / 800 LB-FT

6.7L CUMMINS® TURBO DIESEL

WITH THE AISIN® HEAVY-DUTY 6-SPEED AUTOMATIC TRANSMISSION

Significant advantages come with the available Cummins Turbo Diesel starting with available torque of 800 lb ft. The 360 hp/800 lb ft Cummins is partnered solely to the single transmission meant to handle this level of output over the long term: the AISIN AS69RC 6 speed automatic with its Chassis Cab friendly available Power Take Off (PTO) capability. This Cummins iteration is available for all Ram Chassis Cabs.



410 HP / 429 LB-FT WITH 8-SPEED AUTO (3500);

370 HP / 429 LB-FT WITH 6-SPEED AUTO (3500/4500/5500)

6.4L HEMI® V8 WITH MDS/FUEL SAVER TECHNOLOGY

The standard engine for all Ram Chassis Cab models provides outstanding gas powered V8 performance with 87 octane unleaded gas. Mate the 6.4L HEMI V8 with the available AISIN 6 speed transmission, and you've got stellar available PTO capability that efficiently uses only four of its cylinders (static). Configurations: HEMI V8/NEW 8HP75 8 speed, standard on 3500; HEMI V8/AISIN AS66RC 6 speed, optional on 3500 and standard on 4500/5500.

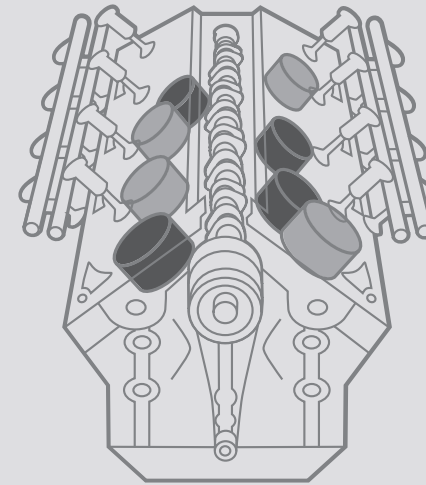

MDS/FUEL SAVER TECHNOLOGY

It's exactly what business needs. Engineered for the 5.7L HEMI V8 on Ram 1500 and the 6.4L HEMI V8 on Heavy Duty and 3500 Chassis Cab with the HEMI V8/NEW 8HP75 8 speed auto, the Multi Displacement System supplies a tough 8 cylinder for the job and then seamlessly transforms the engine into a smooth and efficient 4 cylinder for the highway. And if you're using available PTO on a 6.4L HEMI V8/AISIN powered 3500/4500/5500 Chassis Cab, the MDS operates while in the stationary (static) mode.

RAM POWERTRAINS

RAM 2500/3500 PICKUP



400 HP / 1,000 LB-FT (3500)

6.7L CUMMINS HIGH OUTPUT TURBO DIESEL

WITH THE AISIN HEAVY-DUTY 6-SPEED AUTOMATIC TRANSMISSION

The available High Output (HO) is mated only to the AISIN 6 speed automatic. With its best in class available diesel torque of 1,000 lb ft,⁷ the Cummins HO gives Ram 3500 pickup models indisputable superiority for all towing and hauling. An ingenious Diesel Exhaust Fluid (DEF) system means all Cummins Turbo Diesels meet stringent federal emissions standards. The Cummins High Output is available only on Ram 3500 pickups.

Numerous updates to the 2019 Cummins Turbo Diesel result in greater power and torque that translate into outstanding towing capability. Among them: a new compacted graphite iron cylinder block, a new cylinder head with new exhaust valves and springs, a new 2,000 bar fuel rail, new fuel pump and new fuel filter along with a weight reduction of some 60 lb.

370 HP / 850 LB-FT (2500/3500)

6.7L CUMMINS TURBO DIESEL

WITH THE 68RFE 6-SPEED AUTOMATIC TRANSMISSION

This calibration translates into radically high torque output, giving Ram Heavy Duty models extra clout for the job. Like all Cummins engines, it features the "smart" diesel exhaust brake and offers superb, unaided cold start capability in temperatures as low as 20°F. The 370 hp/800 lb ft calibration is partnered with the dependable 68RFE 6 speed automatic transmission. Availability is solely on Ram 2500/3500 Heavy Duty pickups.



410 HP / 429 LB-FT (2500/3500)

6.4L HEMI V8 WITH MDS/FUEL SAVER TECHNOLOGY AND THE TORQUEFLITE® 8-SPEED AUTOMATIC TRANSMISSION

This engineering combines the best: VVT, MDS/Fuel Saver Technology, Individual Cylinder Fuel Control and interactive Deceleration Fuel Shut Off (iDFSO) all using 87 octane unleaded. Performance is exceptional.

For 2019, the 6.4L HEMI V8 gets a new partner the ZF 8HP75 8 speed automatic. Upgrades include additional torque converter brazing and two gear sets with additional pinion gears, as well as a heavy duty Park system all to handle the increased towing and payload capacities. The 8HP75 offers a level of shift refinement not usually seen in heavy duty trucks, with fully electronic operation, an innovative and convenient rotary dial e shifter, and on the fly shift mapping with more than 40 individual maps to optimize shift quality/points regardless of load or conditions.

RAM POWERTRAINS

RAM 1500 PICKUP

HEMI 5.7L

395 HP / 410 LB-FT

5.7L HEMI® V8 WITH eTORQUE TECHNOLOGY AND THE TORQUEFLITE® 8-SPEED AUTOMATIC TRANSMISSION

Even an engine that carries the legendary reputation of the 5.7L HEMI V8 can achieve new generation status. For 2019, the addition of eTorque technology to this powerhouse takes engineering to the next level and radically boosts capability. The new HEMI V8 with eTorque increases supplemental torque by 130 lb ft power you'll appreciate when launching from a full stop while towing a heavy trailer. Available only for Ram 1500.



RAM 1500 CLASSIC PICKUP

HEMI 5.7L

395 HP / 410 LB-FT

5.7L HEMI V8 WITH MDS/FUEL SAVER TECHNOLOGY AND THE TORQUEFLITE 8-SPEED AUTOMATIC TRANSMISSION

Nothing says capability as well as a 5.7L HEMI V8 in a Ram 1500 with a comprehensive description immediately to the left. To that, add the fact that all 5.7L HEMI V8 engines are mated to the TorqueFlite 8 speed automatic transmission with its easy to use and dashboard mounted rotary dial shifter. This is one powertrain that gives every owner of a Ram 1500 confidence, capability and character. Available for all Ram 1500 Classic pickups.



HEMI 5.7L

395 HP / 410 LB-FT

5.7L HEMI V8 WITH MDS/FUEL SAVER TECHNOLOGY AND THE TORQUEFLITE 8-SPEED AUTOMATIC TRANSMISSION

The resilient HEMI V8 for Ram 1500 reflects its legendary heritage but it's really the engineering that makes this the engine of choice for business. Smart refinements to get the most from every drop of fuel include dual spark plug technology and Variable Valve Timing (VVT); both contribute to outstanding engine efficiency and torque levels. The Multi Displacement System (MDS)/Fuel Saver Technology transforms this legendary V8 into an efficient 4 cylinder under many of the everyday and specialized driving conditions in industry and agriculture. Available for Ram 1500 pickups.

3.6L VVT

305 HP / 269 LB-FT

THE 3.6L PENTASTAR® V6 WITH eTORQUE TECHNOLOGY AND THE TORQUEFLITE 8-SPEED AUTOMATIC TRANSMISSION

Our engineers left no area untouched with the design of the new 2019 Ram 1500 pickup and that includes the standard powerplant. The next generation of the proven engine for this tough worker is the 3.6L Pentastar V6 with eTorque a move that delivers the welcome addition of 90 lb ft of supplemental torque to an already impressive torque curve. eTorque technology for the Pentastar V6 is on new 2019 Ram 1500 only.

ECODIESEL

240 HP / 420 LB-FT

THE 3.0L ECODIESEL V6 WITH THE TORQUEFLITE 8-SPEED AUTOMATIC TRANSMISSION

This engine is an exclusive part of our arsenal of groundbreaking powerplants. The 3.0L EcoDiesel V6 engine (available only for the Ram 1500 Classic pickup) provides exceptional performance, with a focus on muscular torque. Breakthrough technology includes a standard oil cooler that helps save you time and money and which extends your oil change intervals up to 10,000 miles.

3.6L VVT

305 HP / 269 LB-FT

THE 3.6L PENTASTAR V6 WITH THE TORQUEFLITE 8-SPEED AUTOMATIC TRANSMISSION

As standard powerplant on select Ram 1500 Classic pickups, the Pentastar V6 delivers ultra capable performance with notable gas powered efficiency working with its standard partner, the innovative TorqueFlite 8 speed automatic transmission. One of the many invaluable assets of this engine is its thermal management system technology that helps keep internal components operating at ideal temperatures.

RAM POWERTRAINS

RAM PROMASTER®

3.6L
VVT

280 HP / 260 LB-FT

3.6L PENTASTAR® V6 WITH 6-SPEED AUTOMATIC TRANSMISSION

The impressive and reliable Pentastar V6 remains the preferred and standard engine for the 2019 Ram ProMaster models. Light and efficient, it features outstanding horsepower and torque curves, Electronic Throttle Control, and a serious compression ratio of 10.2:1.



RAM PROMASTER CITY®

2.4L *multiair*

178 HP / 174 LB-FT

2.4L TIGERSHARK® MULTIAIR® 2 I-4 WITH 9-SPEED AUTOMATIC TRANSMISSION

Here's what propels your business forward: The 2.4L Tigershark mated to the class exclusive 9 speed automatic transmission¹⁴; working together, this powertrain delivers best in class horsepower,¹⁴ best in class torque¹⁴ and best in class 28 mpg highway fuel economy.¹³













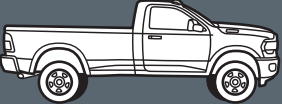

5 YEAR / 60,000 MILE³⁸
POWERTRAIN LIMITED WARRANTY

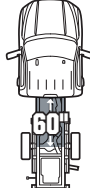
**EVERY GAS POWERTRAIN IN THE PORTFOLIO
IS COVERED BY OUR 5/60 WARRANTY.³⁸**

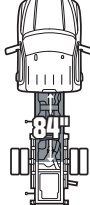
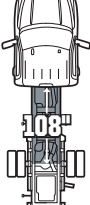
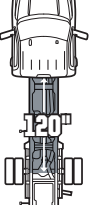
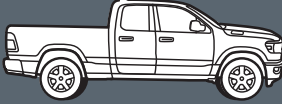
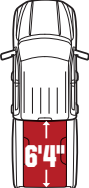
5 YEAR / 100,000 MILE³⁹
POWERTRAIN LIMITED WARRANTY

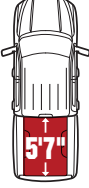
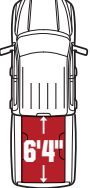
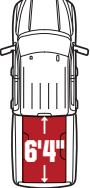
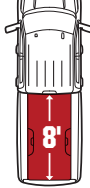
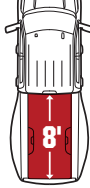
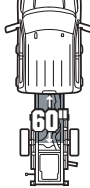
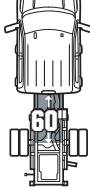
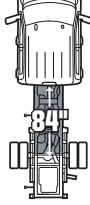

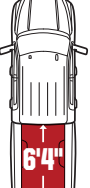
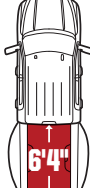





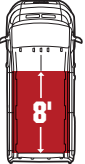
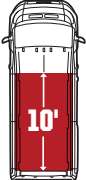

**EVERY DIESEL POWERTRAIN IN THE PORTFOLIO
IS COVERED BY OUR 5/100 WARRANTY.³⁹**

VEHICLE CONFIGURATIONS

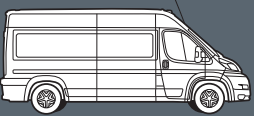

	PICKUP				CHASSIS CAB						
	1500 SRW		2500 AND 3500 SRW		DRW	SRW	3500, 4500 AND 5500 DRW				
 <p>REGULAR CAB</p>	 <p>1500 CLASSIC ONLY</p>	 <p>1500 CLASSIC ONLY</p>	 <p>2500, 3500</p>	 <p>3500</p>	 <p>3500</p>	 <p>3500, 4500, 5500</p>	 <p>3500, 4500, 5500</p>	 <p>4500, 5500</p>	 <p>4500, 5500</p>		
 <p>QUAD CAB®</p>											
 <p>CREW CAB</p>			 <p>2500, 3500</p>	 <p>2500, 3500</p>	 <p>3500</p>	 <p>3500</p>	 <p>3500, 4500, 5500</p>	 <p>4500, 5500</p>			
 <p>MEGA CAB®</p>			 <p>2500, 3500</p>	 <p>3500</p>	<p>RAMBOX® SYSTEM AVAILABILITY:</p> <p>1500 CLASSIC PICKUP REG, QUAD & CREW CAB, 5'7" & 6'4" BOX</p> <p>1500 PICKUP CREW CAB, 5'7" BOX</p> <p>2500/3500 PICKUPS SRW CREW AND MEGA CAB, 6'4" BOX</p>					<p> BED LENGTH</p> <p> CAB TO AXLE LENGTH</p> <p>SRW SINGLE REAR WHEEL</p> <p>DRW DUAL REAR WHEEL</p>	

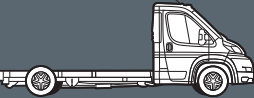
VEHICLE CONFIGURATIONS

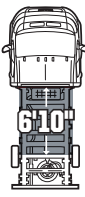
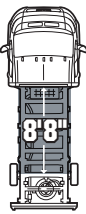
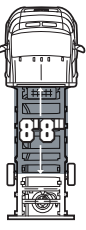
RAM PROMASTER®

	1500		2500		3500		
	118" WB	136" WB	136" WB	159" WB	136" WB	159" WB	159" WB EXT
 <p>CARGO VAN STANDARD ROOF</p>							
 <p>CARGO VAN AVAILABLE HIGH ROOF</p>							
 <p>WINDOWED VAN HIGH ROOF ONLY</p>							
 <p>CHASSIS CAB/ CUTAWAY STANDARD ROOF ONLY</p>	<div style="border: 1px solid red; padding: 5px;"> <p> LOAD FLOOR LENGTH</p> <p> CAB TO AXLE LENGTH</p> <p>WB WHEELBASE</p> </div>						

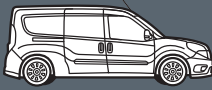
RAM PROMASTER CITY®

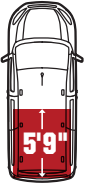
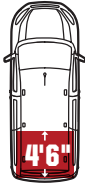
 <p>CARGO VAN 122.4" WHEELBASE</p>	 <p>CARGO LOAD FLOOR</p>	
 <p>PASSENGER WAGON 122.4" WHEELBASE</p>	 <p>CARGO LOAD FLOOR 2ND-ROW SEATS FOLDED</p>	 <p>CARGO LOAD FLOOR BEHIND 2ND-ROW SEATS</p>



RAMTRUCKS.COM/COMMERCIAL



BusinessLink has you covered.

- ▶ Full Range of FCA Commercial Vehicles
- ▶ Free Membership
- ▶ Priority Service
- ▶ Extended Service Hours
- ▶ Dedicated Staff of Commercial Vehicle Experts
- ▶ Free Alternate Transportation
- ▶ Generous Incentives
- ▶ Expertise in Commercial Financing Options
- ▶ 24/7 Towing Service Available

For more information, log on to FCAUSFLEET.COM or call us toll free at **877-2THELINK (877-284-3546)**.

THE DEALER NETWORK FOR YOUR BUSINESS.

Your **BusinessLink** dealer is committed to providing you, the small business owner, with the vehicle support you need for your business, from servicing all makes and models of your existing vehicles to selling you the right vehicles needed to perform the work that you do. Your **BusinessLink** dealer provides priority service because we know downtime is costing you money. Your **BusinessLink** dealer has sales professionals trained to properly "job-rate" the right vehicle for your work application along with providing commercial finance options. New vehicle sales to qualified small business owners also receive a free alternate transportation contract, in the event your vehicle is in for service.

Membership in the **BusinessLink** program is free. Membership helps us to identify you as a small business owner so we can provide you with both the service you deserve and update you with offers that can help reduce the cost of doing business. Ask your **BusinessLink** dealer to register today.

ON THE JOB

ON THE JOB⁴⁰ allowances make your business more profitable!

- ▶ **NO-EXTRA-CHARGE.** 2 Year Gas/4 Year Diesel Lube Oil Filter Allowance
- ▶ **UP TO \$1,000.** Commercial Graphics Program Allowances
- ▶ **UP TO \$1,000.** Commercial Equipment/Upfit Allowances
- ▶ **\$300 - \$1,000.** Allowance on Select Mopar® Service Contracts

See your dealer for specific program rules and details, log on to FCAUSFLEET.COM or call us toll free at **877-2THELINK (877-284-3546)**.

INCENTIVES FOR SMALL BUSINESSES.

Running a business presents plenty of challenges. Like cutting costs, not corners. Like saving time and money and eliminating hassles. The **ON THE JOB**⁴⁰ commercial incentive program provides assistance in customizing and servicing your business vehicles.



A commercial line of credit from Chrysler Capital is ideal for qualified business customers looking for a flexible, easy way to manage growing vehicle needs. Chrysler Capital streamlines the process—and, with pre-qualification, you're ready to buy a vehicle when you need it. Ask your **BusinessLink** dealer for details.



JOIN IN



Join fellow Ram enthusiasts and tell your story by posting comments, participating in discussions, and sharing your photos and videos. Join our community on Facebook, Twitter, YouTube, Pinterest and Instagram.

RAM OUTFITTER



YOUR GO-TO ONLINE SOURCE FOR RAM GEAR: ramtrucks.com/outfitter

1 Based on best-in-class cargo capacity, best-in-class payload and best-in-class hwy mpg. Class is Small Commercial Van segment (Class 1). 2 Based on the average of VIO vs New Registrations for each model year using IHS Markit Data as of July 1, 2018 for Model Years 1998-2018. 3 Based on Class 3 pickup-based conventional cab chassis. When properly equipped. See dealer for details. 4 Based on Class 4 pickup-based conventional cab chassis. When properly equipped. See dealer for details. 5 Based on Class 5 pickup-based conventional cab chassis. When properly equipped. See dealer for details. 6 Assumes properly equipped vehicle and 150-lb allowance for driver. Additional options, equipment, passengers and cargo weight must be subtracted. See dealer for details. 7 Class based on 250/2500 and 350/3500 pickups. When properly equipped. See dealer for details. 8 Class based on 350/3500 pickups. When properly equipped. See dealer for details. 9 Class based on light-duty pickups. When properly equipped. See dealer for details. 10 Based on awards within the Light-Duty Pickup segment from January 15, 2018 - January 1, 2019. 11 When properly equipped. See dealer for details. 12 Class is based on Large Commercial Van segment (Class 2). 13 Based on EPA-estimated 21 mpg city/28 mpg hwy with 2.4L engine and automatic 9-speed transmission and on FCA US LLC Small Commercial Van segment (Class 1). Actual mileage may vary. 14 Based on FCA US LLC Small Commercial Van segment (Class 1). When properly equipped. See dealer for details. 15 Based on Class 4-5 pickup-based conventional cab chassis. When properly equipped. See dealer for details. 16 Based on Class 3-5 pickup-based conventional cab chassis. Adaptive Cruise Control is a driver convenience system, not a substitute for active driver involvement. The driver must remain aware of traffic conditions and be prepared to use the brakes to avoid collisions. 17 Based on Class 3-5 pickup-based conventional cab chassis. Always check entire surroundings visually before proceeding. 18 Always check entire surroundings and look before proceeding. An electronic drive aid is not a substitute for conscientious driving. Always be aware of your surroundings. 19 Based on Class 3-5 pickup-based conventional cab chassis. When properly equipped. See dealer for details. 20 Class based on 250/2500 pickups. When properly equipped. See dealer for details. 21 SiriusXM Radio, SiriusXM Traffic and SiriusXM Travel Link each require a subscription sold separately, or as a package, by Sirius XM Radio Inc. **If you decide to continue service after your 1-year/5-year trial included with the new vehicle purchase, the subscription plan you choose will automatically renew thereafter and you will be charged according to your chosen payment method at then-current rates.** Trial service is not transferable. Fees and taxes apply. Please see the Customer Agreement at www.siriusxm.com for complete terms and how to cancel, which includes calling SiriusXM at 1-866-635-2349. All fees and programming are subject to change. Not all vehicles or devices are capable of receiving all services offered by SiriusXM. Data displays and individual product availability vary by vehicle hardware. Current information and features may not be available in all locations, or on all receivers. Weather Forecast, Current Conditions may not be available in all locations. 22 The Uconnect Phone requires a mobile phone equipped with the Bluetooth Hands-Free Profile. To check phone compatibility, please visit www.UconnectPhone.com. 23 Remote Vehicle Start is not available on all vehicles. You are responsible for using remote features in accordance with any laws, rules or ordinances in effect in your vehicle's location. You must have an active subscription to SiriusXM Guardian in order to use remote services. See Terms of Service for service limitations. 24 All SiriusXM Guardian equipped vehicles come with a 12-month trial effective on the date of purchase or lease of a new vehicle. Enrollment in the trial is required to receive service. Upon expiration of the trial period, purchase of a subscription is required to continue SiriusXM Guardian. SiriusXM Guardian is available only on equipped vehicles purchased within the United States and Puerto Rico. Services can only be used where cellular coverage is available. See Uconnect and SiriusXM Guardian Terms of Service for complete service limitations. 25 Three-month/1GB trial included with the purchase or lease of a new vehicle. Upon expiration of the trial period, purchase of a subscription is required. WiFi Hotspot available through third-party subscription. Requires Internet-enabled mobile device. See dealer for details. This feature is not intended for use by the driver while the vehicle is in motion. Always drive carefully. 26 This feature does not work while the vehicle is in motion. 27 Requires compatible iPhone. See dealer for phone compatibility. Data plan rates apply. Vehicle user interface is a product of Apple. Apple CarPlay, Apple Music and Siri are trademarks of Apple Inc. iPhone is a trademark of Apple Inc., registered in the US and other countries. Apple terms of use and privacy statements apply. 28 Requires an iPhone with Siri. Certain features are not available while the vehicle is in motion. iPhone must be within active cellular range. Customer's existing iPhone data rates apply to Internet-supported features. 29 To use Android Auto on your phone screen, you'll need an Android phone running 5.0 (Lollipop) or higher and the Android Auto app. Android and Android Auto are trademarks of Google LLC. 30 This system is a driver convenience system, not a substitute for active driver involvement. The driver must remain aware of traffic conditions and maintain control of the vehicle. 31 This system is an alert system for the front of the vehicle. It is not a substitute for active driver involvement. The driver must remain aware of traffic conditions and be prepared to use brakes to avoid collisions. 32 Adaptive Cruise Control is a driver convenience system, not a substitute for active driver involvement. The driver must remain aware of traffic conditions and be prepared to use the brakes to avoid collisions. 33 Always check visually for vehicles prior to changing lanes. 34 Always drive carefully, consistent with conditions. Always wear your seat belt and obey traffic laws. 35 Class based on light-duty pickups. Excludes other FCA US LLC vehicles. 36 Based on manufacturer testing. Always drive carefully, consistent with conditions. Always wear your seat belt and obey posted speed limits. 37 Based on EPA-estimated 28 hwy mpg and 16-gallon fuel tank, and on FCA US LLC Small Commercial Van segment (Class 1). Actual mileage may vary. 38 Visit Mopar.com for complete details and a copy of the 5-Year/60,000-Mile Powertrain Limited Warranty. 39 Visit Mopar.com for complete details and a copy of the 5-Year/100,000-Mile Powertrain Limited Warranty. 40 ON THE JOB is a retail incentive program; see your dealer for official rules. Inquire about eligibility by calling 877-ONTHEJOB or by logging on to www.fcausfleet.com. The purchaser or lessee must be a qualified commercial customer for more than 30 days prior to the date of the vehicle purchase. An official ON THE JOB Customer Acknowledgment Form must be signed by the customer (provided by the dealer). 41 Never operate the vehicle with the seats reclined to the extent that the seat belts are not secure and flat against your torso.

©2019 FCA US LLC. All Rights Reserved. Ram, Mopar, Big Horn, BusinessLink & design, HEMI, Mega Cab, ParkSense, ParkView, Pentastar, Quad Cab, the Ram's Head logo, RamBox, Ram ProMaster, Ram ProMaster City, Tigershark, TorqueFlite, Tradesman and Uconnect are registered trademarks, and Active-Level, On The Job & design and Ram Telematics are trademarks of FCA US LLC. Chrysler Capital is a registered trademark of FCA US LLC and licensed to Santander Consumer USA Inc. MultiAir is a registered trademark of C.R.F. Società Consortile per Azioni, used under license by FCA US LLC.

Harman Kardon is a registered trademark of Harman International Industries, Inc. Cummins is a registered trademark of Cummins, Inc. AISIN is a registered trademark of Aisin Seiki Co., Ltd. CNH, Case IH and New Holland are registered trademarks of CNH America LLC. Bluetooth is a registered trademark of Bluetooth SIG, Inc. Sirius XM Connected Vehicles Services Inc. Sirius, XM, SiriusXM and SiriusXM Guardian and all related marks and logos are registered trademarks of Sirius XM Radio Inc. Facebook and logo are registered trademarks of Facebook, Inc. The Twitter logo is a service mark of Twitter, Inc. Instagram and logo are registered trademarks of Instagram, Inc. Pinterest and logo are registered trademarks of Pinterest, Inc. BIG TEX TRAILERS is a trademark and brand of Big Tex Trailer Manufacturing, Inc. Katerack is a registered trademark of Dejana Truck & Utility Equipment Co. All rights reserved.

About this catalog: since the time of printing, some of the information you'll find in this catalog may have been updated. Ask your dealer for details. Some of the equipment shown or described throughout this catalog may be available at extra cost. Specifications, descriptions, illustrative materials and all competitive comparisons contained herein are as accurate as known at the time this publication was approved for printing. FCA US LLC reserves the right to discontinue models at any time or change specifications without notice or without incurring obligation. Options may be required in combination with other options. For the price of the model with the equipment you desire, or verification of specifications contained here, see your Ram dealer.



RAM
COMMERCIAL

RAMTRUCKS.COM/COMMERCIAL

©2019 FCA US LLC. All Rights Reserved.
Ram is a registered trademark of FCA US LLC.