

The new 2007
BMW X3
Sports Activity
Vehicle



The Ultimate
Driving Machine®

X3 3.0si





X3: Putting the “sport” in Sports Activity Vehicle.

Rugged good looks are just the beginning.





D M TT 4313



X3



The look and feel of luxury.

■ Standard equipment

□ Optional equipment or included in a Package



□ **Xenon Adaptive Headlights** optimize road illumination when the X3 enters a curve or bend, helping to enhance safety when driving at night. Sensors continuously monitor the angle of the steering wheel, the vehicle's speed, yaw and other factors to determine the direction in which the X3 is heading. The headlights swivel accordingly, up to 15 degrees left or right.

Xenon low- and high-beam headlights illuminate the road ahead and to the side with brilliant clarity. Includes auto-leveling to adjust for varying passenger and cargo loads. The Corona light-rings that circle both headlights and high beams also act separately as Daytime Running Lights and parking lights. (shown with optional Cold Weather Package)



■ **Halogen free-form foglights** are cleanly integrated into the front air dam, illuminating the road ahead in bad weather and poor visibility.



□ **High-intensity retractable headlight washers** help keep lights clean of ice, mud, road salt and other coatings, for maximum road lighting and enhanced driving safety.



■ **White indicator lights** add a fresh, dynamic look when lit, while sending a clear signal to other drivers. The orange reflectors, now positioned on the forward part of the fender, add to the X3's sporty redesign.

■ Standard equipment

□ Optional equipment or included in a Package

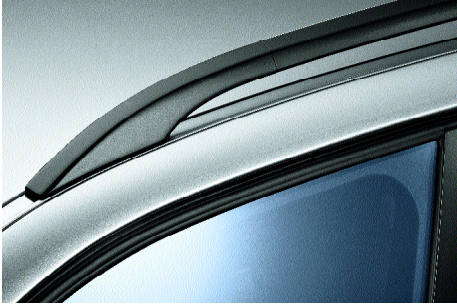

■ **Roof rails**, blending harmoniously with the X3's design, provide the foundation for BMW's (accessory) multifunctional roof support system.

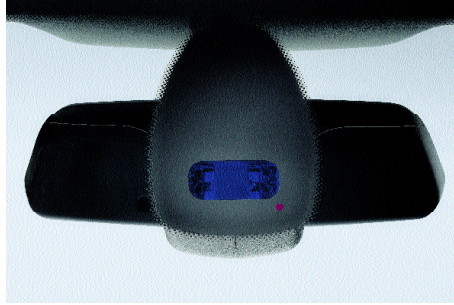

■ **Rain sensor** uses infrared light to measure the amount of rain. When the wipers are in the "intermittent" mode, the rain sensor automatically adjusts the windshield-wiping interval as needed. **Automatic headlight control** (not shown), included with rain sensor, activates headlights by means of a sensor that responds to darkness.



■ **Rear window wiper** with adjustable, intermittent wipe feature keeps the rear window clear for enhanced visibility in wet weather.



□ **Power-adjustable folding exterior side-view mirrors**, in matching body color, automatically dim when reflecting bright lights, helping to eliminate glare when driving at night. (included in Premium Package)



■ **Additional brake light**, above the rear hatch, gives drivers further back an advance warning that you are applying the brakes.



■ **Adaptive Brake Lights** increase vehicle visibility and signal the intensity of your braking action. When the vehicle detects panic stopping, this feature activates additional brake light surfaces, warning following traffic to quickly slow down.



□ **Park Distance Control** uses ultrasonic sensors in the front and rear bumpers to help you judge the distance to other cars and unseen objects when parking. The beeping becomes faster as your bumper approaches the object, turning into a constant tone when the distance is less than 12 inches.

■ Standard equipment

□ Optional equipment

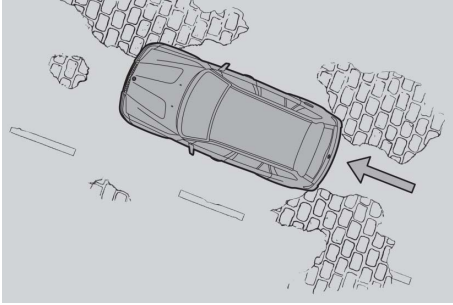

■ **Automatic Differential Brake (ADB-X)** is similar to the function of a differential lock, braking each wheel independently, as needed. As soon as wheelspin is detected at any wheel, ADB-X applies that brake automatically until the wheel regains traction. DSC assists ADB-X by modulating the amount of power sent to each wheel; with DSC turned off, full power continually flows to all four wheels.

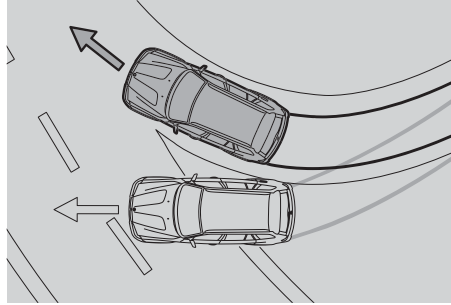

■ **Dynamic Stability Control** provides remarkable tenacity on slippery road surfaces. If the system senses over- or understeer, it modulates engine power and can apply brakes individually to help keep the vehicle under control and going in the intended direction.

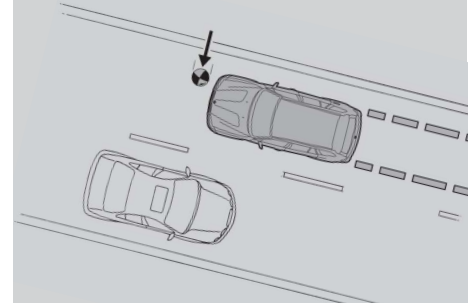

■ **Dynamic Brake Control (DBC)** senses “panic” braking maneuvers, and immediately builds up maximum brake pressure. This significantly cuts down the overall braking distance. When DBC is activated, the system also deploys **Adaptive Brake Lights**, warning following drivers to brake quickly.

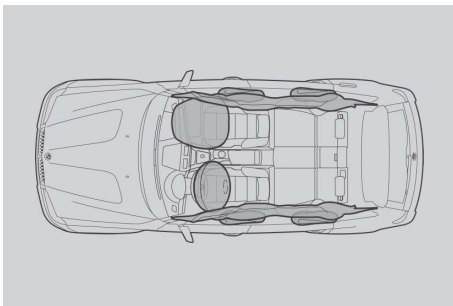

■ In the event of a collision, only the **airbags** that are needed are deployed. For the driver and front passenger, this includes “smart” front airbags, door-mounted side-impact airbags, and HPS (Head Protection System). For rear-seat passengers this includes HPS and optional rear side-impact airbags.



■ In the event of a severe frontal collision, **automatic safety belt pretensioners** automatically tighten the lap and shoulder belts around front-seat occupants. **Always wear your safety belt and always place children in the rear seat.**

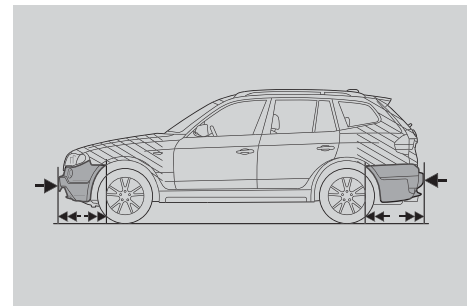

■ **Impact-absorbing bumpers** and compressible “crush tubes” front and rear help absorb the force of impact in collisions up to 9 mph, minimizing damage to the vehicle’s body and simplifying repairs. Only at higher impact speeds do structural supports begin to deform, dissipating impact energy to help protect occupants.

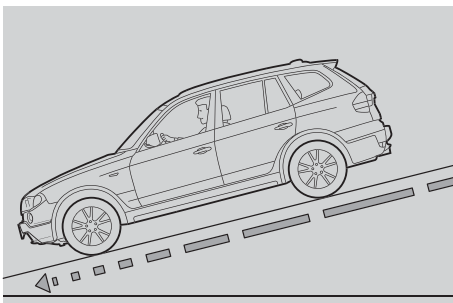

■ **Hill Descent Control (HDC)** helps the X3 drive down steep hills without having to “ride the brake.” By pressing the HDC button, the system keeps the X3’s speed under control automatically.

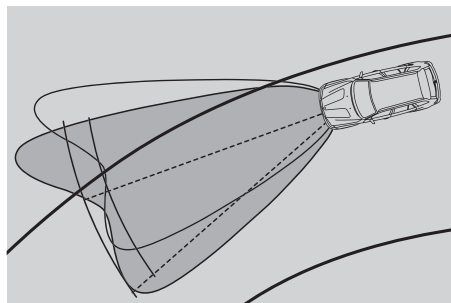



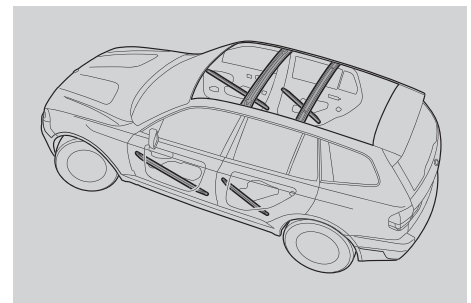



□ **Optional Xenon Adaptive Headlights** with corona light rings automatically swivel to follow the curves of the road. The system uses data from on-board sensors and the steering wheel angle to determine the car’s direction, then adjusts the headlights accordingly, for excellent nighttime vision.



■ **BMW’s door anchoring system** includes reinforcing bars with hook-like members within each door. In a serious side collision, the bars hook the door to the body, locking them together to make a more rigid passenger cell. When the pressure is released, the anchoring system is designed to disengage so that the doors can be opened (unless further damage from the impact prevents them from opening).

Combinations

Interior colors	Sensatec Leatherette ¹		Nevada Leather ²			
Upholstery color	Sand Beige	Black	Sand Beige	Sand Beige/Black	Gray	Black
Exterior colors						
Non-metallic³ 300 Alpine White	●	●	●	●	●	●
Non-metallic³ A61 Crimson Red	●	●	●	●	●	●
Non-metallic³ 668 Jet Black	●	●	●	●	●	●
Metallic⁴ 354 Titanium Silver		●		●	●	●
Metallic⁴ A53 Platinum Bronze	●	●	●	●	●	●
Metallic⁴ A08 Silver Gray	●	●	●	●	●	●
Metallic⁴ A51 Montego Blue	●	●	●	●	●	●
Metallic⁴ A35 Monaco Blue	●	●	●	●	●	●
Metallic⁴ A11 Highland Green	●	●	●	●	●	●
Metallic⁴ 475 Black Sapphire	●	●	●	●	●	●
Interior trims						
4BN Ash Dark Wood ⁵						
4BP Poplar Natural Light Wood ⁶						
4AS Poplar Gray Wood ⁶						

¹ Sensatec Leatherette: Standard. Not available with Premium Package.
² Nevada Leather: Optional. Included in Premium Package.
³ Non-metallic exterior paint: Standard.
⁴ Metallic exterior paint: Optional.
⁵ Ash Dark Wood interior trim: Standard.
⁶ Poplar Natural Light Wood and Poplar Gray Wood interior trim: No-cost option.

The pages in this section of the brochure show available colors and materials for the BMW X3 SAV. Use these samples to compare paint, upholstery and trim colors and combinations. Please note that these samples are representations; they are not exact

reproductions. To see the actual colors, visit your local BMW center. They will be happy to show you original samples and assist you with special requests.

Equipment

Performance and efficiency	X3 3.0si
3.0-liter dual overhead cam (DOHC), 260-horsepower, 24-valve inline 6-cylinder engine with magnesium/aluminum composite engine block, Valvetronic, and Double-VANOS steplessly variable valve timing	●
Electronic throttle control	●
Dual resonance intake system	●
6-speed manual transmission	●
6-speed STEPTRONIC automatic transmission with Adaptive Transmission Control ¹	○

Handling, ride and braking	X3 3.0si
xDrive all-wheel-drive system	●
Dynamic Stability Control (DSC), including Brake Drying, Brake Stand-by, Start-off Assistant and Brake Fade Compensation	●
Hill Descent Control (HDC)	●
Engine-speed-sensitive power steering	●
Servotronic vehicle-speed-sensitive power steering	○
Unitary body structure with independent suspension	●
Gas pressure shock absorbers	●
Front and rear anti-roll (stabilizer) bars	●
4-wheel ventilated anti-lock disc brakes with Dynamic Brake Control	●
Sport suspension calibration ²	□

Exterior	X3 3.0si
17 x 8.0 Star Spoke (Style 204) alloy wheels, 235/55R-17 all-season tires	●
18 x 8.0 Double Spoke (Style 205) alloy wheels, 235/50R-18 all-season tires ³	○
18 x 8.0 Double Spoke (Style 192M) alloy wheels, 235/50R-18 all-season tires	□
Y Spoke (Style 191M) alloy wheels, 19 x 9.0 front, 19 x 9.5 rear; 235/45R-19 front, 255/40R-19 rear performance tires ⁴	○
Space-saver spare wheel and tire	●
Xenon Adaptive Headlights with auto-leveling, and corona light rings	○
Halogen free-form foglights	●
Retractable headlight washer system	★
Door handles in matching body color	●
Full body-color aerodynamic kit with painted side skirts	□
Shadowline exterior trim	□
Privacy glass	○
Roof rails	●
Metallic paint	○
Chrome tail pipes	●
Power folding exterior mirror with automatic-dimming feature	◇

- Standard
- Optional
- Included in Sport Package
- ◇ Included in Premium Package
- ★ Included in Cold Weather Package

¹ No-cost option.

² Note: Sport suspension consists of stiffer springs and anti-roll bars. While these features improve the sporty handling of the X3, they can also create a firmer ride, which may not be acceptable for all customers.

³ Not available with Sport Package.

⁴ Sport Package required. Due to low-profile tires, please note: wheels, tires and suspension parts are more susceptible to road hazard and consequential damages. Performance tires not recommended for driving in ice and snow conditions.

Equipment

Interior seating	X3 3.0si
8-way power adjustable front seats with 2-way manual headrests, and driver seat and mirror memory	●
8-way power adjustable front sport seats with 2-way manual thigh support ⁵	□
Comfort seats, including power lumbar support, headrests and two-way upper backrest angle adjustment ^{6,7}	○
4-way lumbar support for front seats	◇
Sensatec Leatherette upholstery	●
Nevada Leather upholstery	○/◇
Heated front seats	○/★
Heated rear seats	★
3-spoke leather-wrapped multi-function steering wheel with fingertip cruise control	●
3-spoke leather-wrapped multi-function M Sport steering wheel	□
Heated steering wheel ⁸	○
Front center console armrest	●
Storage nets on front seatbacks, in front passenger footwell and luggage compartment; two aluminum fastening cargo rails and slip-proof reversible flooring in rear cargo compartment	●
Split 60/40 fold-down rear seats	●
Ski bag ⁸	★

Comfort and convenience	X3 3.0si
Vehicle & Key Memory	●
Remote entry, including 2-step unlocking and remote tailgate release	●
Automatic climate control with micro-filter and air recirculation	●
Panoramic moonroof with fully automatic, two-piece glass panels, power slide and lift control, trap release, wind deflector and power interior sunshade	●
Tilt/telescopic steering wheel column	●
Park Distance Control (PDC), front and rear	○
Rain-sensing windshield wipers with Automatic Headlight Control	●
Automatic-dimming inside rear-view mirror with digital compass	◇
Power front windows with "one-touch" up/down operation; power rear windows with "one-touch" down	●
Front/rear map-reading, footwell and visor-mirror lights	●
Locking glovebox with rechargeable take-out flashlight	●
Dual cupholders	●
Retractable cargo net	○
Pre-wiring for cellular phone, integrated garage-door opener, and satellite radio	●
BMW Universal transceiver (garage door opener)	◇

Audio system	X3 3.0si
Anti-theft AM/FM stereo/CD/MP3 audio system with 8 speakers, Radio Data System (RDS), Auto-Store, 3-channel FM diversity antenna system and auxiliary audio input adapter compatible with portable music players; pre-wired for 6-disc CD changer ⁹ and satellite radio ⁹	●
Premium sound with DSP (Digital Sound Processor) AM/FM stereo/CD/MP3 audio system with 8 upgraded speakers, upgraded amplification, vehicle-speed-sensitive equalization, and auxiliary audio input adapter compatible with portable music players; pre-wired for 6-disc CD changer ⁹ and satellite radio ⁹	○
Auxiliary input	●
SIRIUS Satellite Radio ¹⁰	△

- Standard
- Optional
- Included in Sport Package
- ◇ Included in Premium Package
- ★ Included in Cold Weather Package
- △ BMW center-installed accessory

⁵ Requires optional Nevada Leather upholstery.

⁶ Not available with Sport Package.

⁷ Comfort seats not available with Sensatec Leatherette upholstery.

⁸ Upon BMW X3 SAV delivery, the ski bag is detached and stored beneath the load floor in the rear cargo area.

⁹ Available as an accessory.

¹⁰ For additional information, please visit your authorized BMW SAV Center.

Equipment

Instrumentation and controls	X3 3.0si
Service Interval Indicator with miles-to-service readout	●
Check Control vehicle monitor system with pictogram display	●
Tire Pressure Monitor	●
4-function on-board computer	●
On-board navigation system with 16:9 display and folding monitor	○

Safety and security	X3 3.0si
Automatic Differential Brake (ADB-X)	●
Head Protection System (HPS), front and rear	●
Driver's and passenger's front airbag supplemental restraint system (SRS) with "smart" dual-threshold, dual-stage deployment and sensor to help prevent unnecessary passenger's airbag deployment	●
Adaptive Brake Lights	●
Front-door-mounted side-impact airbags	●
Rear-door-mounted side-impact airbags	○
Intelligent Safety and Information System (ISIS) for deployment of safety systems	●
Automatic-locking retractors (ALR) on all passenger safety belts (for installation of child restraint seats)	●
Latch for child-restraint safety seat installation	●
Battery Safety Terminal	●
Central locking system with center console switch (leaves gas filler door unlocked), double-lock feature and 2-step unlocking	●
Coded Driveaway Protection	●
Front safety belts with automatic pretensioners and force limiters	●
Crash sensor that automatically turns on hazard lights and interior lights, and unlocks doors	●
Daytime running lights (via Vehicle Memory system – programmed at BMW SAV center)	●
Prewiring for alarm system	●
BMW Assist™ ¹¹ (4 years of service) with Bluetooth® integrated wireless communication system	○/◇

BMW Services	X3 3.0si
BMW Ultimate Service™	●

- Standard
- Optional
- Included in Sport Package
- ◇ Included in Premium Package
- ★ Included in Cold Weather Package

Equipment

Premium Package	X3 3.0si
Automatic-dimming inside rear-view mirror with digital compass	◇
Automatic-dimming power folding side-view mirrors	◇
BMW Universal transceiver (garage door opener)	◇
BMW Assist™ (4 years of service) with Bluetooth® integrated wireless communication system	◇
Nevada Leather upholstery	◇
4-way lumbar support for front seats	◇

Sport Package ¹³	X3 3.0si
18 x 8.0 Double Spoke (Style 192M) alloy wheels, 235/50R-18 all-season tires	□
Y Spoke (Style 191M) alloy wheels, 19 x 9.0 front, 19 x 9.5 rear; 235/45R-19 front, 255/40R-19 rear performance tires ¹⁴	○
8-way power adjustable front sport seats with 2-way manual thigh support	□
3-spoke leather-wrapped multi-function M Sport steering wheel	□
Sport suspension calibration ¹⁵	□
Full body-color aerodynamic kit with painted side skirts	□
Shadowline exterior trim	□

Cold Weather Package	X3 3.0si
Ski bag ¹⁶	★
Heated front seats	★
Heated rear seats	★
Retractable headlight washer system	★

- Optional
- Included in Sport Package
- ◇ Included in Premium Package
- ★ Included in Cold Weather Package
- △ BMW center-installed accessory

¹³ X3 3.0si Sport Package requires optional Nevada Leather upholstery or Premium Package.

¹⁴ Sport Package required. Due to low-profile tires, please note: wheels, tires and suspension parts are more susceptible to road hazard and consequential damages. Performance tires not recommended for driving in ice and snow conditions. Spare is a space-saver wheel and tire.

¹⁵ Note: Sport suspension consists of stiffer springs and anti-roll bars. While these features improve the sporty handling of the X3, they can also create a firmer ride, which may not be acceptable for all customers.

¹⁶ Upon BMW X3 SAV delivery, the ski bag is detached and stored beneath the load floor in the rear cargo area.

Equipment

Stand-alone Optional Equipment	X3 3.0si
6-speed STEPTRONIC automatic transmission with Adaptive Transmission Control ¹⁷	○
Servotronic vehicle-speed-sensitive power steering	○
18 x 8.0 Double Spoke (Style 205) alloy wheels, 235/50R-18 all-season tires ¹⁸	○
Y Spoke (Style 191M) alloy wheels, 19 x 9.0 front, 19 x 9.5 rear; 235/45R-19 front, 255/40R-19 rear performance tires ¹⁹	○
Xenon Adaptive Headlights with auto-leveling, adaptive light control and corona light rings	○
Privacy glass	○
Metallic paint	○
Nevada Leather upholstery	○
Comfort seats ^{18,20}	○
Poplar Natural Light Wood trim ^{17,21}	○
Poplar Gray Wood trim ^{17,21}	○
Heated front seats	○
Heated steering wheel ¹⁸	○
Park Distance Control (PDC), front and rear	○
Retractable cargo net	○
Premium sound with DSP (Digital Sound Processor) AM/FM stereo/CD/MP3 audio system with 8 upgraded speakers, upgraded amplification, vehicle-speed-sensitive equalization, and auxiliary audio input adapter compatible with portable music players; pre-wired for 6-disc CD changer ²² and satellite radio ²²	○
On-board navigation system with 16:9 display and folding monitor	○
Rear-door-mounted side-impact airbags	○
BMW Assist™ (4 years of service) with Bluetooth® integrated wireless communication system ¹²	○

Accessories	X3 3.0si
CD changer (6-disc)	△
Alarm system	△
Floor mats	△
Bicycle rack that attaches to cargo rails	△
Trailer hitch ²³	△
Aerodynamic components	△
iPod Seamless Integration System ²⁴	△
SIRIUS Satellite Radio ²⁴	△

All optional equipment listed is factory-installed.
For additional requests see the extensive catalog of accessories at your BMW center.

¹⁷ No-cost option.

¹⁸ Not available with Sport Package.

¹⁹ Sport Package required. Due to low-profile tires, please note: wheels, tires and suspension parts are more susceptible to road hazard and consequential damages. Performance tires not recommended for driving in ice and snow conditions.

²⁰ Not available with Sensatec Leatherette upholstery.

²¹ Ash Dark Wood trim is standard.

²² Available as an accessory.

²³ Please view X3 Owner's Manual for towing guidelines.

²⁴ For additional information, please visit your authorized BMW SAV center.

Technical data

Weight		X3 3.0si
Unladen	lbs	4012 (4067)
Weight distribution, front/rear		
Manual transmission	%	50.8/49.2
Automatic transmission	%	50.9/49.1

Engine³		X3 3.0si
Liter/type		3.0/inline 6
Bore/stroke	inch	3.35/3.46
Nominal output/rpm	hp	260/6600
Max torque/rpm	lb-ft	225/2750
Compression ratio	:1	10.7
Fuel grade		Unleaded premium

Transmission		X3 3.0si
Manual gear ratios		
I/II/III	:1	4.35/2.50/1.66
IV/V/VI/R	:1	1.23/1.00/0.85/3.93
Final drive ratio	:1	3.73
Automatic gear ratios		
I/II/III	:1	4.07/2.37/1.55
IV/V/VI/R	:1	1.16/0.85/0.67/3.20
Final drive ratio	:1	4.44

Performance		X3 3.0si
Drag coefficient	Cd	0.35
Top speed ¹	mph	130/143 ² (130/142 ²)
Acceleration 0-60 mph ³	sec	6.9(7.1)
Fuel consumption ⁴		
6-speed manual transmission		
City/Highway	mpg	TBD ⁵
6-speed automatic transmission		
City/Highway	mpg	TBD ⁵

General		X3 3.0si
Maximum payload	lbs	1036
Gross Vehicle Weight Rating – GVWR	lbs	5049 (5104)
Roof load limit	lbs	165
Breakover angle @ curb weight	°	18°
Angle of approach @ curb weight	°	24°
Angle of departure @ curb weight	°	21.9°
Ground clearance	inch	8.0
Fording ability	inch	19.7
EPA cargo volume with rear seats folded down	cu ft	71

Figures in () apply to vehicles with automatic transmission.

Technical data

Wheels		X3 3.0si
Tire dimensions	(standard)	235/55R-17 all-season
Wheel dimensions	(standard)	17x8.0
Material		Cast alloy
Tire dimensions	(Sport Package)	235/50R-18 all-season
Wheel dimensions	(Sport Package)	18x8.0
Material		Cast alloy

Brakes		X3 3.0si
Front Type/Diameter	inch	Ventilated disc/12.8
Rear Type/Diameter	inch	Ventilated disc/12.6

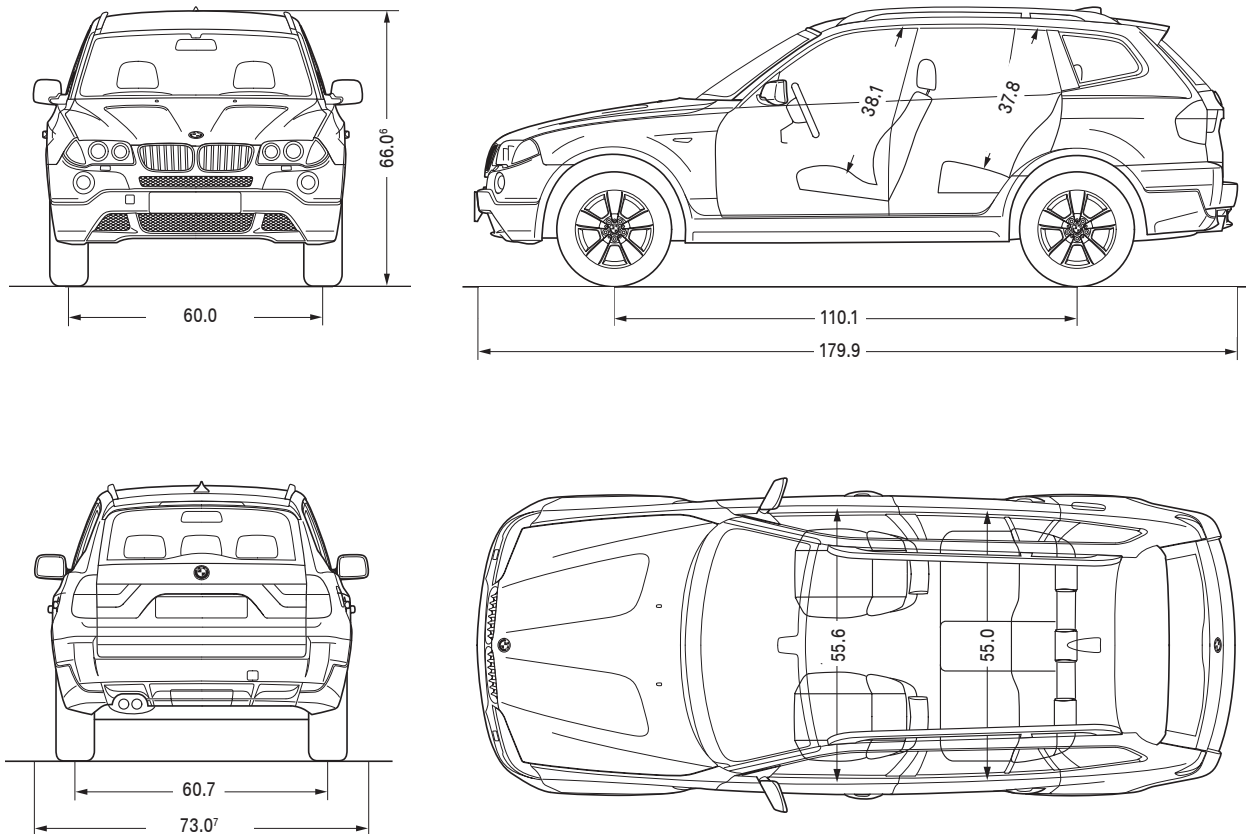

All dimensions are shown in inches.

¹ Top speed limited electronically.

² With optional Y Spoke (Style 191M) alloy wheels and performance tires; requires Sport Package.

³ BMW AG test results. Actual acceleration results may vary, depending on specification of vehicle; road and environmental conditions; testing procedures and driving style. These results should be used for comparison only and verification should not be attempted on public roads.

BMW urges you to obey all posted speed laws and always wear safety belts.

⁴ EPA-estimated figures are for comparison purposes only. Your actual mileage will vary, depending on speed, driving habits, trip length and driving conditions; actual mileage will most likely be lower.

⁵ At time of printing fuel economy numbers were not available. Please go to bmwusa.com for further information.

⁶ Includes antenna.

⁷ Measurement does not include vehicle side-view mirrors.

U.S. Importer: BMW of North America, LLC, Woodcliff Lake, NJ 07677. All illustrations and specifications contained in this brochure are based on the latest product information available at the time of printing. BMW reserves the right to make changes at any time, without notice, in colors, materials, equipment, specifications and models. BMW may, subject to legal requirements, determine the Model Year designation of its vehicles. The Model Year designation on any particular model may be longer or shorter than 12 months. Some vehicles pictured may contain non-U.S. equipment. Some models may be shown with optional equipment. While BMW NA makes all reasonable efforts to provide accurate information in this brochure, there is no guarantee or warranty of accuracy. Furthermore, we do not assume any liability for the accuracy or completeness of information presented. This brochure shall not be used or relied upon as a substitute for information that is available from your BMW SAV center. Further information can be obtained from your authorized BMW SAV center or bmwusa.com.

©2006 BMW of North America, LLC. Not to be reproduced wholly or in part without written permission of BMW NA. The BMW name and logo are registered trademarks.

BMW recommends 