

# 1968 POLARA

*one look... one drive and you've got it-* **DODGE** *fever*



***Unless you've owned a car  
as luxurious as this one—  
you've missed something.***

It begins with a pride of ownership. The knowledge that you are the custodian of a precisioned road machine put together with great care. Not just a means of transportation. But a way to carry you from one point to another in unabashed style and comfort.

Polara looks longer than other popularly priced cars. Roomier and heavier, too. And it is. With the solid ride that only cars almost 20 feet long and weighing over 4000 pounds can provide. With a unique feeling of command that only cars of Polara's size can give you.

Polara is for those of you who appreciate the subtler conveniences of the bigger car. The ease of entry and exit through Polara's big doors. The extra headroom—the extra legroom—the fact that even the rear seats are foam-cushioned on all models.

Sometimes the little things—like rear seat foam cushions—are the things that make big cars like Polara more appealing. Or it could be other things. Like the price. (You see, it's a lot less than you'd guess.) No wonder you've got it. Dodge Fever.

**Polara didn't enter the low-priced field—but you can leave it, for a lot less than you'd guess.**

They said it couldn't be done. That no one could build a car with all of Polara's luxury, size and comfort—and offer it at a price most car buyers could afford. But "they" obviously have not seen Polara close up or checked the low price on its rear window sticker.

Have you?

If not, do it now. You'll find that the price difference between Polara and lesser cars is a lot less than you might suspect. And while you're there, run your finger down the list of standard items on Polara—items that are extra-cost options on some of the other cars. Things like V8 power, sway bar, Safety-Rim wheels and more.

Dodge Fever is nice to have. But it's easier to cure—with a Polara all your own. Go ahead. Step up to Polara. It's easier than you think.

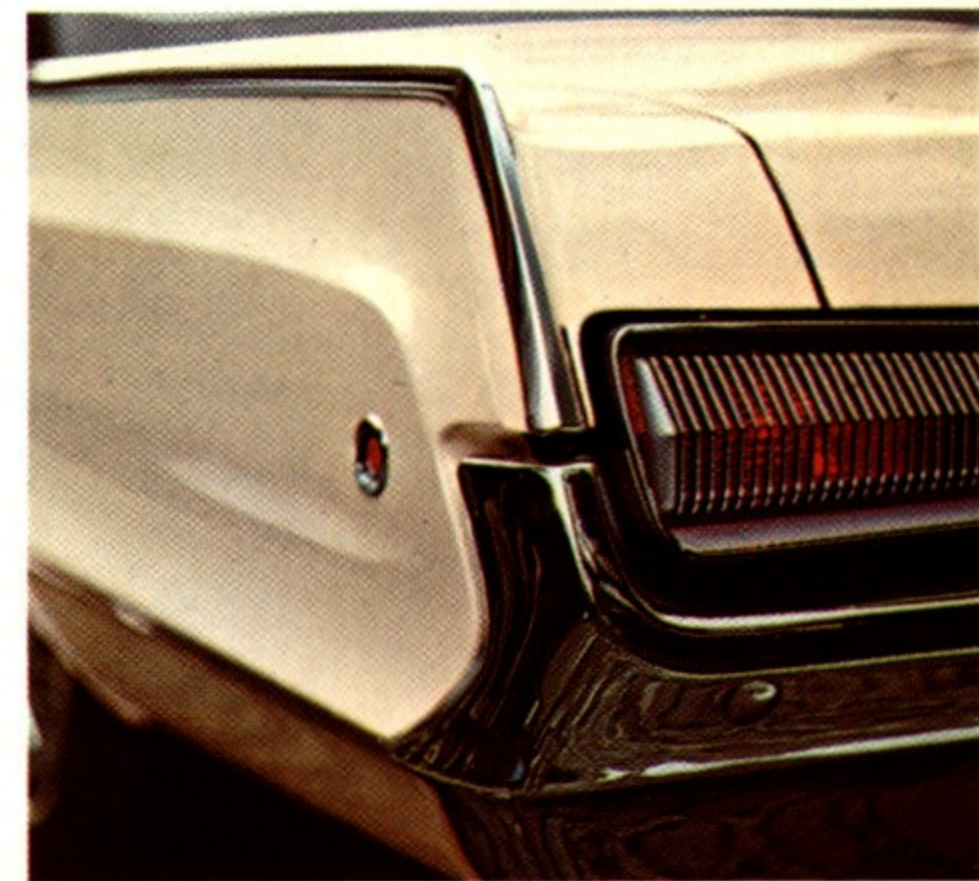
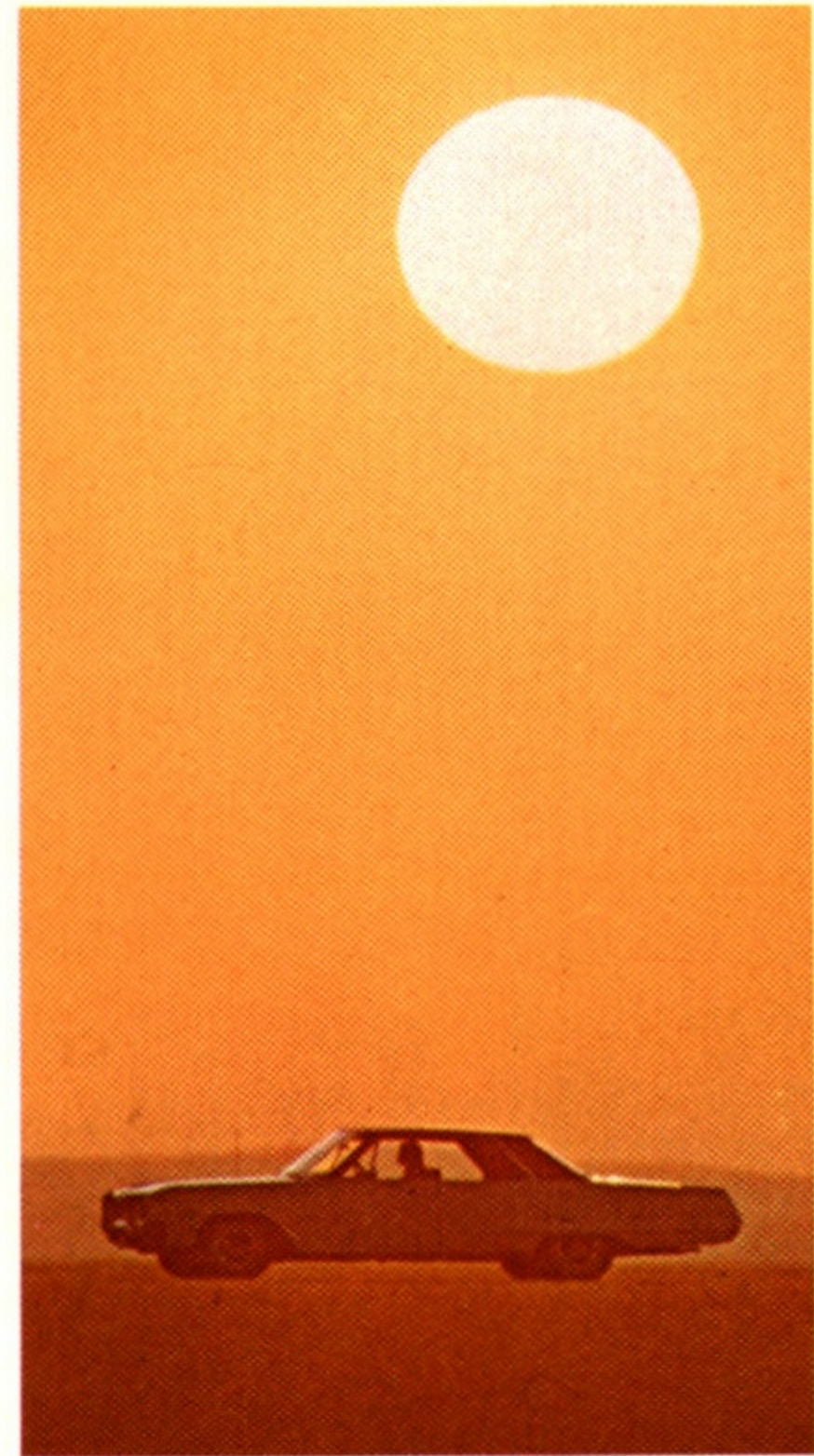

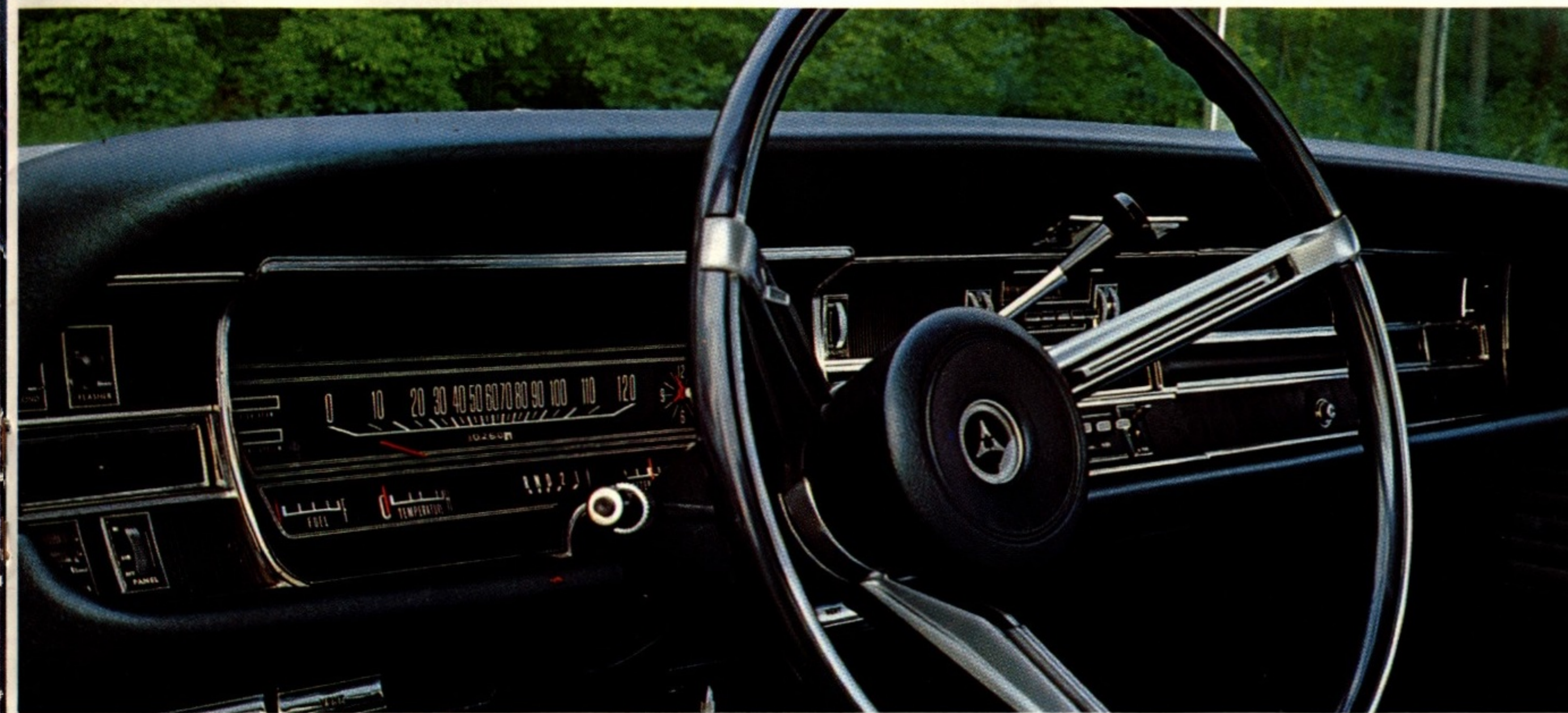

**If you think Polara's extra room, luxury and comfort aren't important—don't take long trips.**

What's it like to travel in seats, deep and high and padded? To discover a shape that slips silently across the landscape, even at superhighway speeds? To set off for anywhere in a luxurious land yacht with a stance 122 inches long? To control a myriad of conveniences from aircraft-type switches—to feel the velvet effortlessness of a 318 V8 that purrs along on regular gasoline—to discover you can stretch and turn and wriggle your toes in the softness of deep-pile carpets?

What's it like?

It's great. It's Polara. It's the way travel should be. It used to be the sole province of the wealthy. But not any more. Why not throw a week's worth of luggage in Polara's mammoth, flat-floored trunk, drop that great-looking rear deck, fill the tank with gas and take off?

Wherever you go, the trip will seem shorter. And you'll be almost sorry to get there.

Sound tempting to you? You've got Dodge Fever.

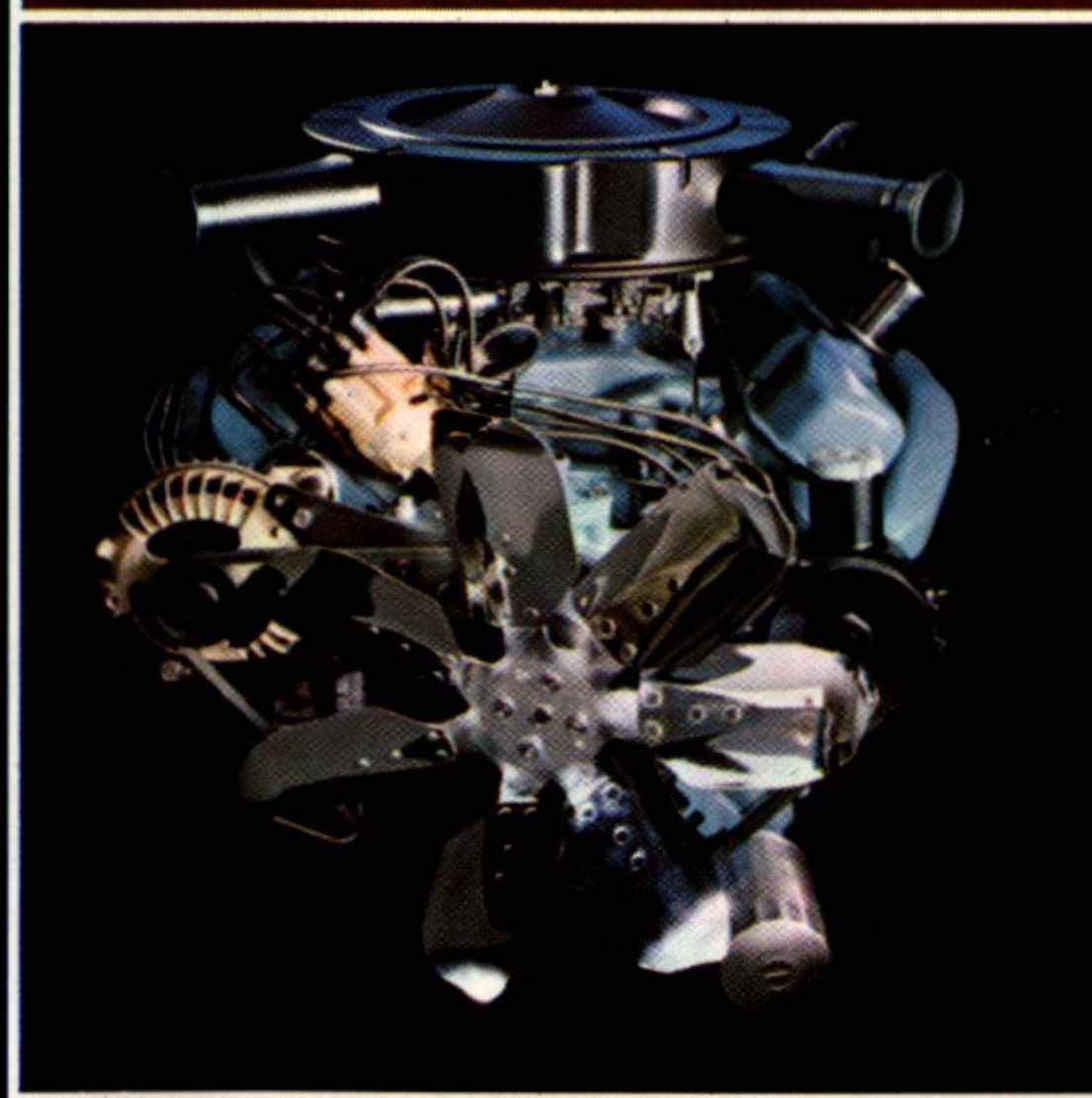
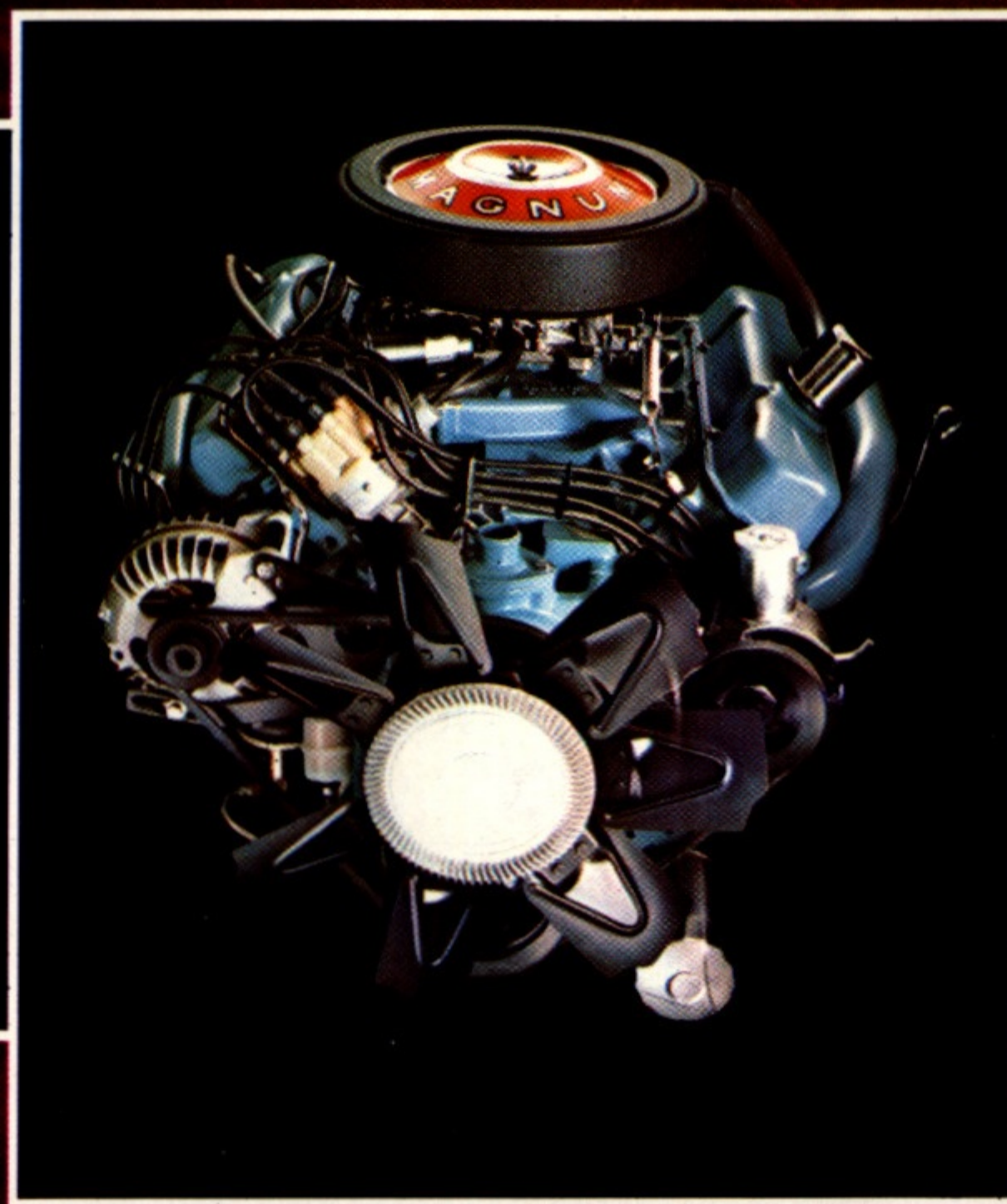
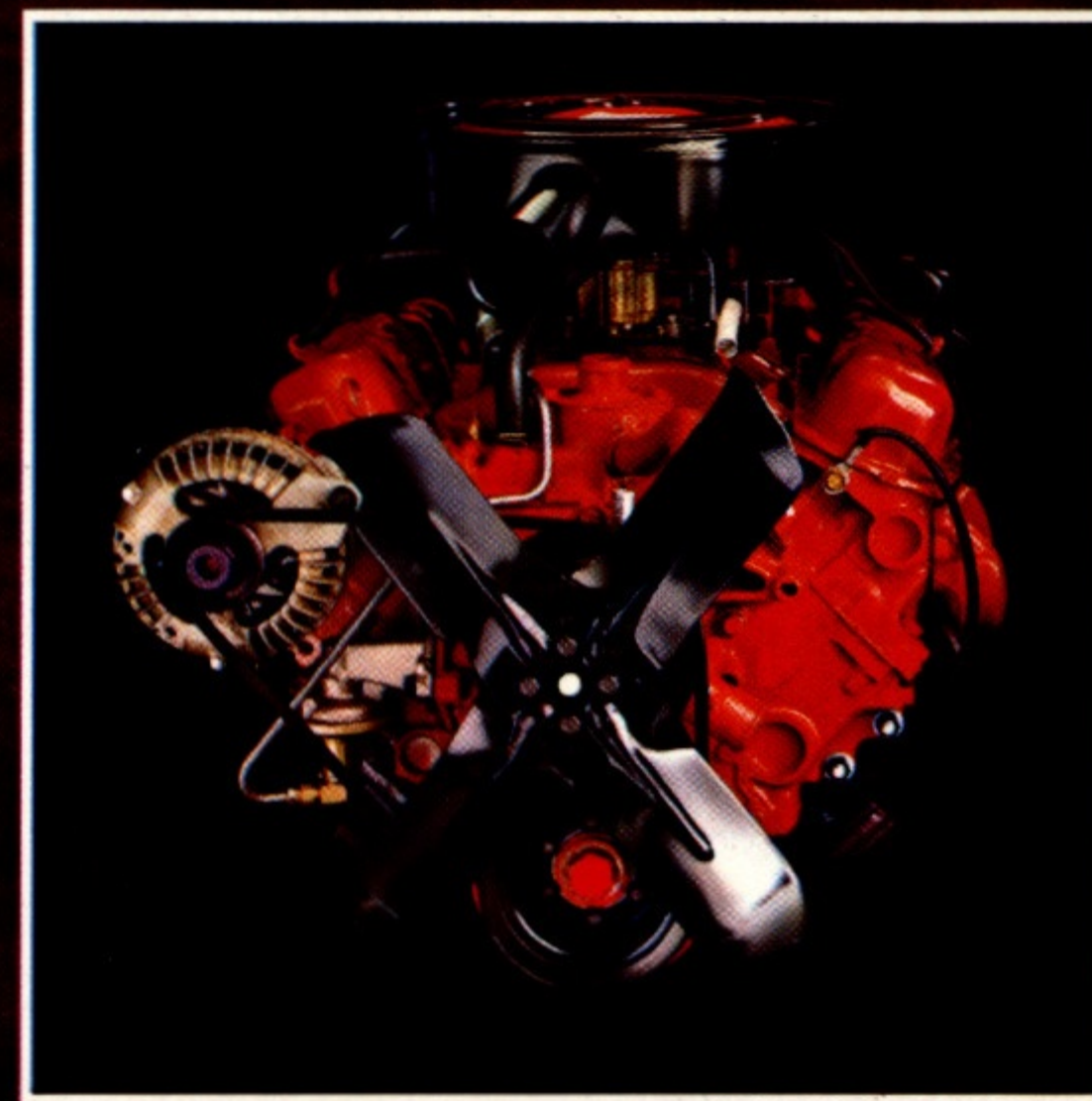
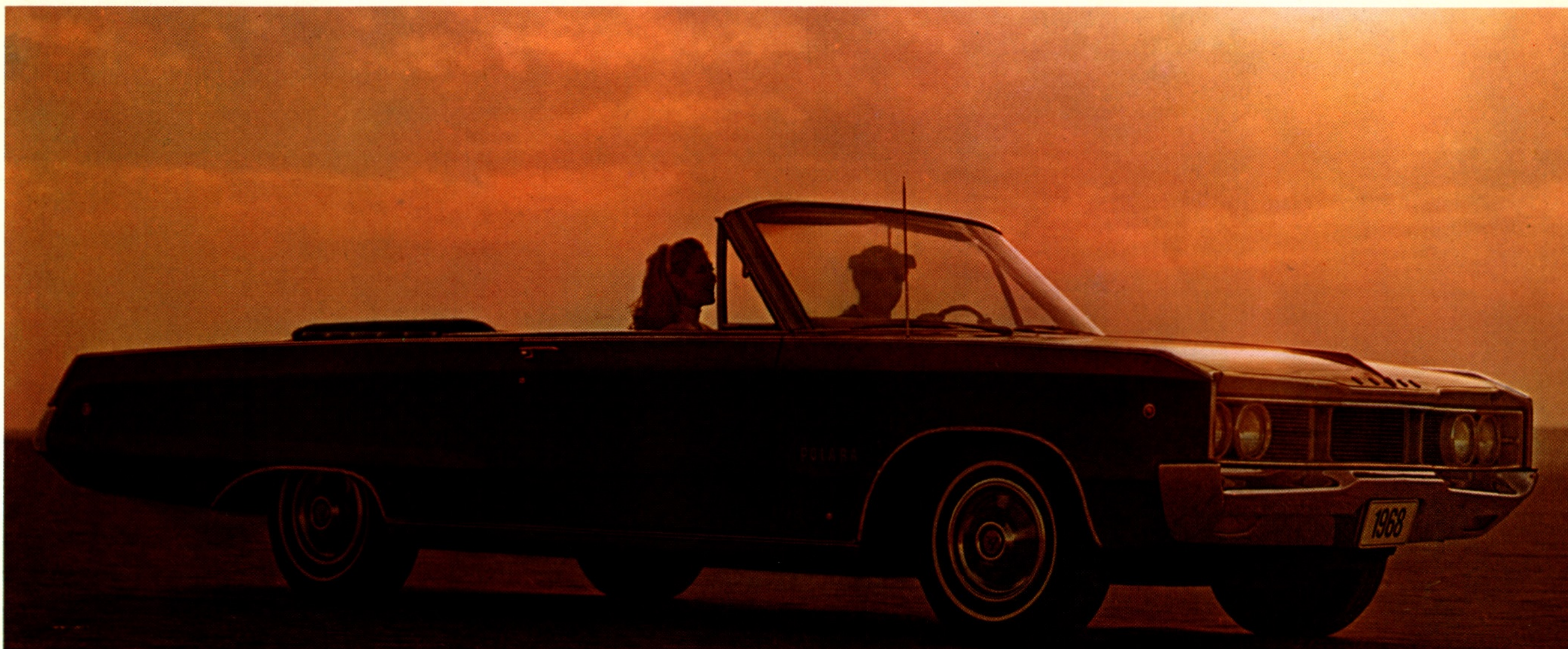

318 V8, standard on all Polara models.

440-Magnum V8, optional on all models, except wagons.  
440 4-bbl. V8, optional on Polara station wagons only.

383 2-bbl. V8, optional on all Polara models. Regular fuel.  
383 4-bbl. V8, optional on all Polara models. Premium fuel.

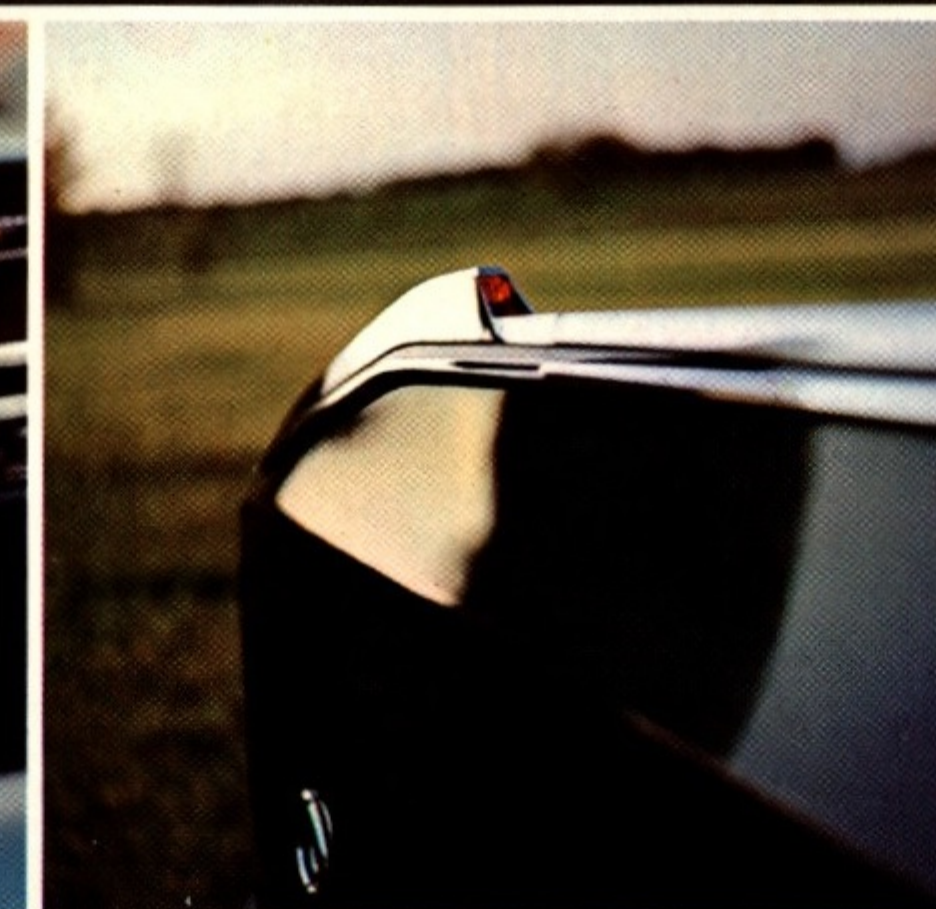
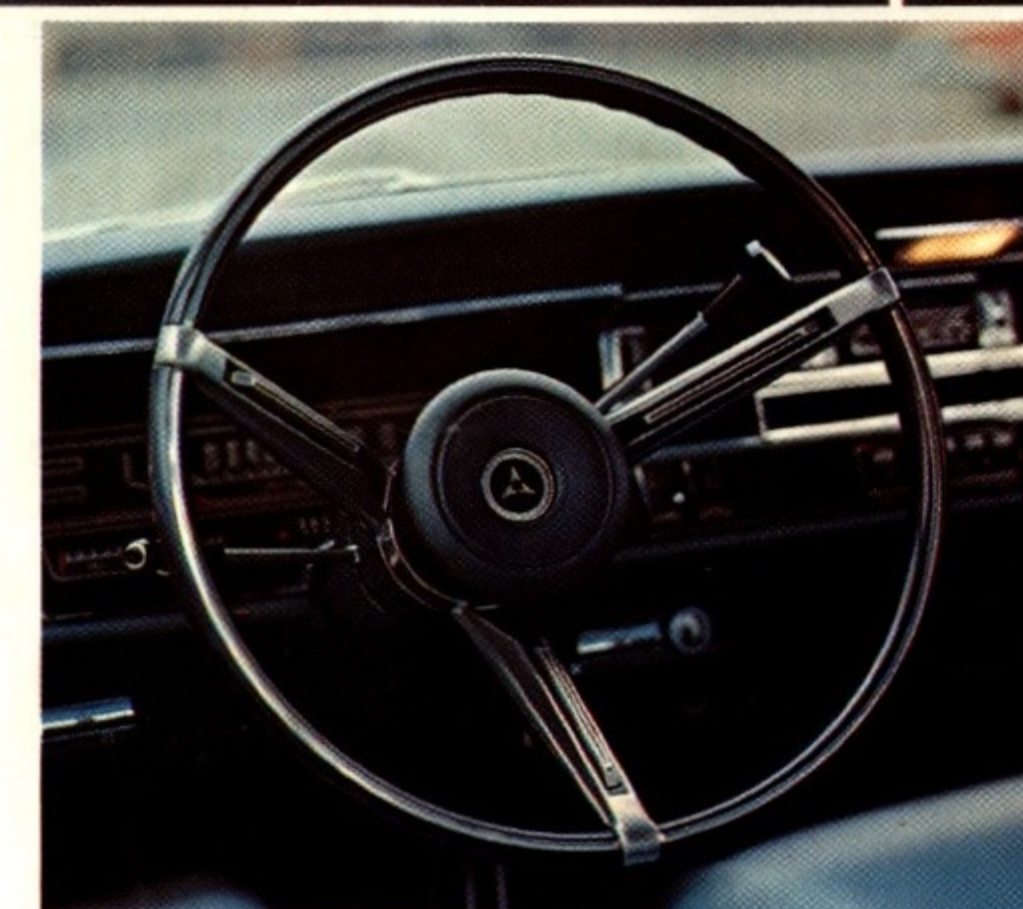

**What better way  
to put a big-car man  
in a sporting  
frame of mind?**

Just because you're a big-car man doesn't mean you have to do without a convertible. Or give up bucket seats or 4-on-the-floor. Or a wide choice of horsepower. Or all the other things you want when

you're out gunning for the car that looks and drives as young as you feel.

If you find yourself catching Dodge Fever, keep in mind that Polara has more levels of excitement than many smaller cars. With a lot of extra room to work it all in.

For example, you have two big convertibles to choose from—Polara and Polara 500. You can take your pick of four Dodge V8 engines—the standard 318-cubic-inch, a two-barrel 383-cubic-inch\* (both running

beautifully on regular gasoline)—or two more high performers that go up to the Dodge 440-Magnum.\*

The transmission lineup for Polara goes like this: standard 3-speed manual, full-sync 4-on-the-floor,\* and Dodge TorqueFlite 3-speed automatic. Naturally, there are many more options to choose from. (You'll find a partial list of them on the next page.) The beauty of them all is simply this: With Polara, you can add any or all of these things without feeling the least bit crowded. \*Optional, at extra cost.

**For the man with taste:  
over 100 ways  
to exercise it.**

Tastes vary, because they are individual and extremely personal. Polara gives you an exceptionally wide choice of optional equipment items. To help you select the ones you'd like to have installed on your '68 Polara, we have arranged them in groupings:

**Comfort and Convenience**

Polara air conditioning is available several ways. A new Automatic Temperature Control option (which is an extra option, in addition to the regular air-conditioning option) lets you dial the interior temperature desired, and this temperature will be maintained regardless of the outside weather. This means you can order any Polara model with regular air conditioning, or with air conditioning plus Automatic Temperature Control. In addition, for Polara station wagons, you have the option of selecting dual air conditioning, or dual air conditioning with Automatic Temperature Control.

Rear window defogger (except convertibles and wagons)

Four radio options are offered on '68 Polara models: AM radio, AM deluxe radio, AM-FM radio,\* AM radio with 8-track stereo-tape player and three instrument-panel-mounted speakers for "orchestra shell" fidelity.

Rear seat speaker (except wagons)

Electric clock on instrument panel

6-way power seat adjuster

3-spoke steering wheel with horn bars and padded hub

2-spoke tilt/telescope steering wheel (available only with power steering and automatic or 4-speed manual transmission)

Power steering

Power brakes

Power windows

Automatic Speed Control (available only with radio, automatic transmission and power brakes)—control is conveniently located on tip of turn signal control lever.

Electric door locks

Power deck release (except wagons)

Tinted windshield

Tinted windshield and windows

Fender-mounted turn signal indicators

Undercoating and hood insulation

Thicker (2 3/4") foam front seat-cushion padding (for models with front bench seat only)

Custom color-keyed vinyl head restraints, front seat, left and right

Remote-control, left, outside mirror

Right, outside mirror

Front, center seat belts

Rear, center seat belts

Front shoulder belts, left and right

Rear shoulder belts, left and right

3-speed electric windshield wiper (2-speed, std.)

**Polara Light Package**

Fender-mounted turn signal indicator

Glove box light

Ashtray light

Time-delay ignition switch light

(This is a little delay switch that leaves your ignition switch light "on" for a short time after the car doors are closed. It lets you find the ignition switch in the dark without switching on the interior lights.)

Rear-door, automatic dome lamp switches (front-door switches, std.)

Trunk light (cargo light on wagons; std., on 3-seat wagons)

Map and courtesy light (std., on convertibles)

**Optional for Polara Station Wagons**

Rear pillar assist handle

Adjustable roof luggage rack

Power tailgate window (std., 3-seat wagons)

Power tailgate window, with washer/wiper

Lockable luggage compartment (or 3rd seat well)

Sill moulding

**Performance**

383 (2-bbl.) V8 engine (regular fuel)

383 (4-bbl.) V8 engine

440 (4-bbl.) V8 engine (station wagons only)

440-Magnum V8 engine (all Polara, Polara 500, except wagons)

TorqueFlite automatic transmission

4-speed manual transmission (Polara 500 models with optional center console only)

Sure Grip differential

Tachometer (Polara 500 with optional center console only)

Front disc brakes (optional power brakes also required)

Heavy-Duty Suspension Package (optional, all Polara models)

Heavy-duty torsion bars, heavy-duty rear springs, heavy-duty sway bar.

Heavy-duty shock absorbers (optional, all Polara models)

15" wheels and tires (14" are std.)

Trailer-Towing Package (not offered with 318 V8)

(fully described on back cover)

**Appearance**

Center console (Polara 500 models only)

Vinyl interior trim for Polara 2-door hardtop, 4-door hardtop and sedan

Silver Metallic exterior paint

Two-tone exterior paint (except convertibles)

Vinyl roof covering, in choice of black, antiqued white or antiqued green (sedan and hardtops only)

Deluxe wheel covers (std., Polara 500)

Deep-dish wheel covers

Chromed road wheels (available in 14" size only)

Front/rear bumper guards

Door-edge moulding

Sill moulding, wheel-lip mouldings (std., Polara 500; not available on station wagons)

White sidewall tires

Red Streak tires (G70 x 15)

White sidewall tires (G70 x 15)

**Polara Exterior Trim Group (Sedan Only)**

Wheel-lip mouldings

Sill mouldings

Upper door-frame mouldings \*Dealer-installed option.

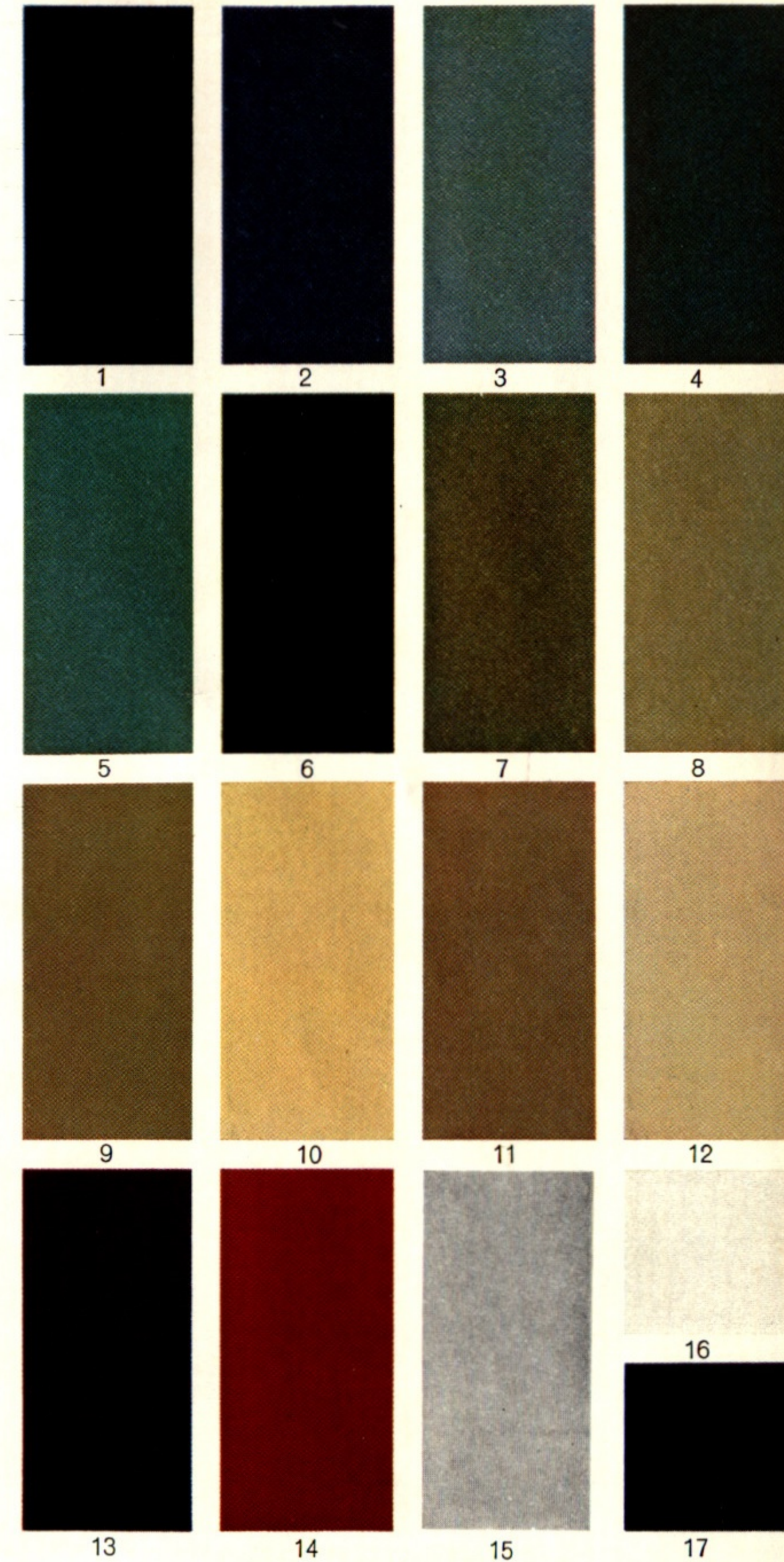

- |                             |                        |
|-----------------------------|------------------------|
| 1-Dark Blue Metallic        | 9-Medium Gold Metallic |
| 2-Medium Blue Metallic      | 10-Light Gold          |
| 3-Pale Blue Metallic        | 11-Medium Tan Metallic |
| 4-Medium Turquoise Metallic | 12-Beige               |
| 5-Light Turquoise Metallic  | 13-Burgundy Metallic   |
| 6-Racing Green Metallic     | 14-Red                 |
| 7-Medium Green Metallic     | 15-Silver Metallic *   |
| 8-Light Green Metallic      | 16-White / 17-Black    |

\*Optional, at extra cost.



Polara 500 2-door hardtop



Polara 500 convertible



Polara convertible



Polara 4-door hardtop

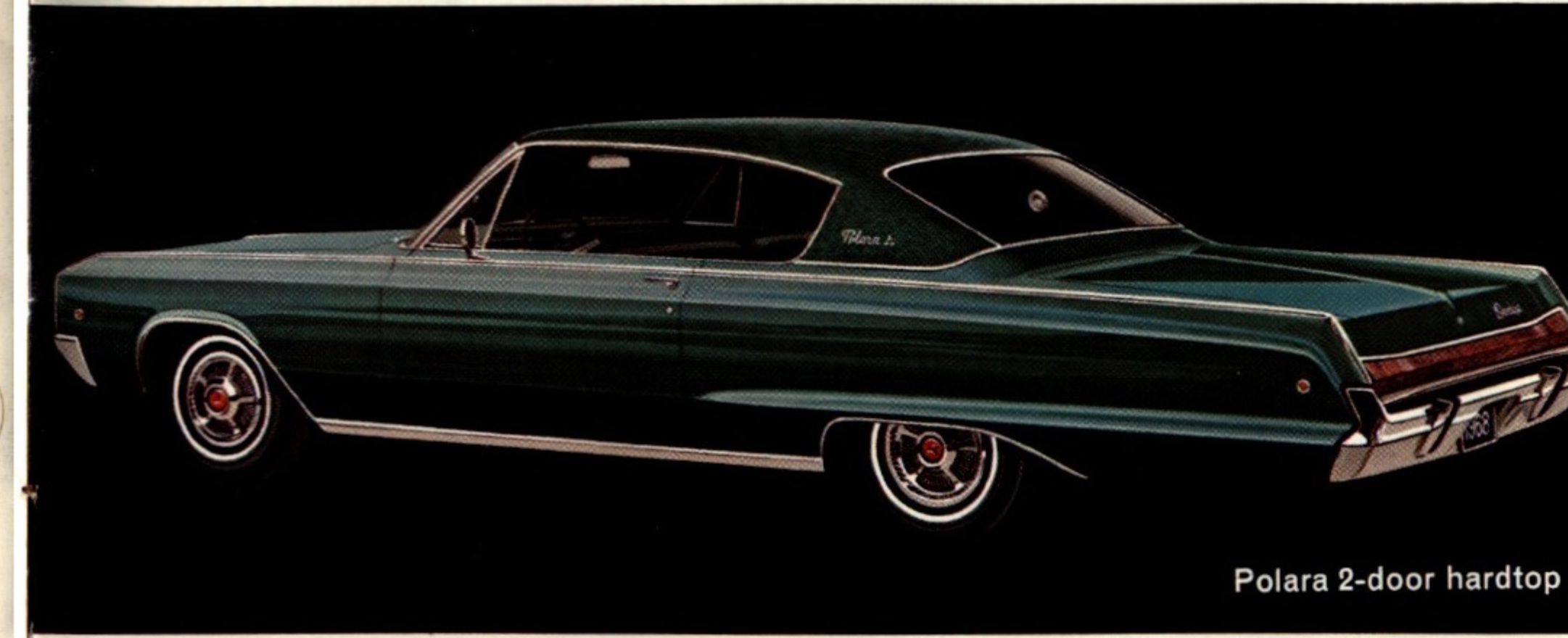

Polara 2-door hardtop



Polara 4-door sedan



Polara station wagon  
(2-seat and 3-seat models)

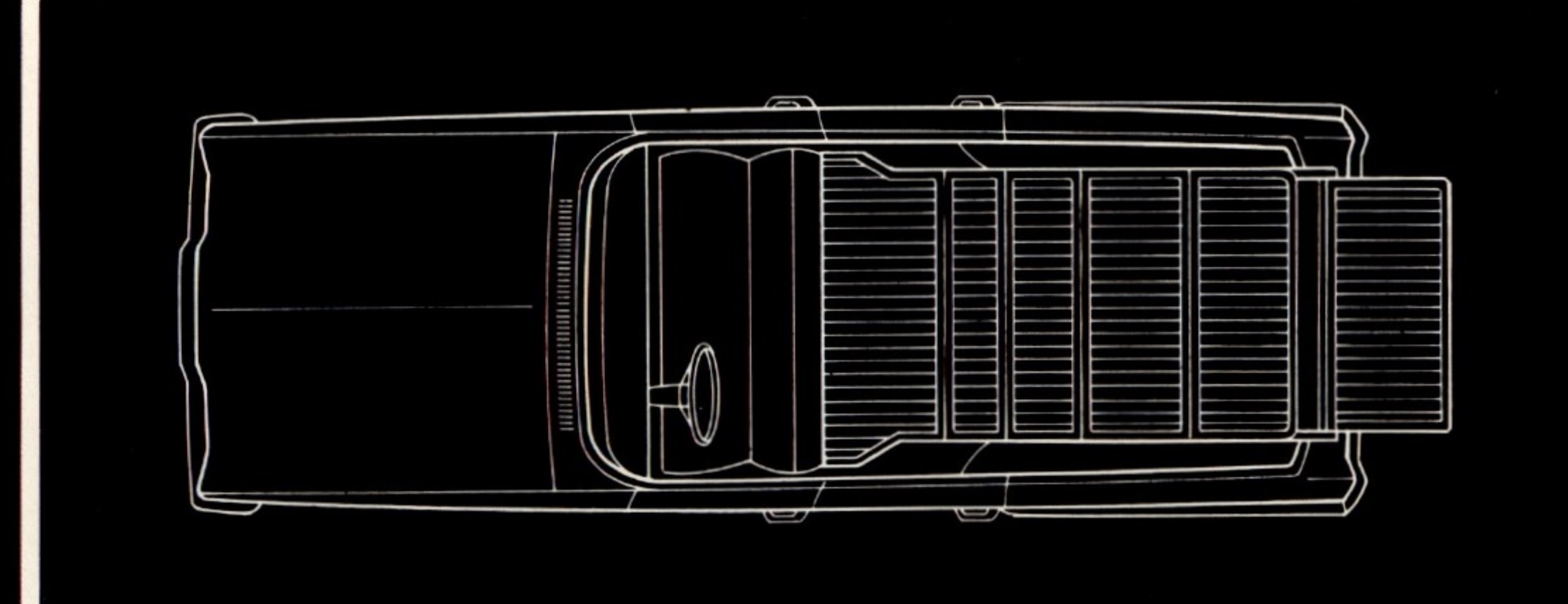

# 1968 Dodge Polara Specifications

## Dimensions

(These are 1968 Polara 4-door-sedan dimensions. Other body styles may vary in some degree.)

Wheelbase 122"  Track, front/rear 62.0"/60.7"  Overall length 219.0"  Overall width 80.0"  Overall height 57.1"

## Suspension

All Polara and Polara 500 models have torsion bars and ball joints in front, asymmetrical leaf springs in the rear, Oriflow shock absorbers at each wheel. The entire suspension is rubber-isolated. A sway bar is standard equipment. A Polara Heavy-Duty Suspension Package (optional, all models) is described on the Optional Equipment page.

## Brakes

Hydraulic, servo-contact, self-energizing, self-adjusting. Bonded linings. Dual Braking System. Parking brake is foot-pedal-operated, with hand-released lever—mechanically actuating shoes on each rear wheel. Master cylinder/parking brake warning light is standard on all models. Polara station wagon brakes are 11 x 3 (front), 11 x 2½ (rear). All other Polara and Polara 500 models have 11 x 2¾ (front), 11 x 2 (rear). Heavy-duty, manually adjusted brakes (11 x 3, front and rear) are optional, all Polara models. Power brakes are also optional, as are front wheel disc brakes (front disc brakes require optional 15" wheels and tires).

## Tires

All Polara models (except wagons) . . . 8.25 x 14 (5.5JK wheels). Polara station wagons . . . . . 8.55 x 14 (6.0JK wheels). 15" wheels and tires are optional on all Polara models and are included when car is equipped with front disc brakes. G70 x 15 Red Streak or white sidewall tires are optional on all Polara models except station wagons.

## Electrical System

Battery: 12-volt, 6-cell, 48-amp-hr, standard on Polara and Polara 500 models equipped with 318 V8. 59-amp-hr, standard with 383-cu.-in. engines. 70-amp-hr, standard with 440-cu.-in. engines and optional with other engines. Alternator: 37-amp, standard. (46-amp standard with air conditioning and optional on Polara models not so equipped.)

## Transmissions

Four basic transmissions are offered on 1968 Dodge Polara models. (1) The Polara 3-speed manual, with column-mounted shift lever. It is standard only on models powered by the 318 V8 or 383 (2-bbl.) V8, and not available on Polara models equipped with other V8s. (2) The 3-speed TorqueFlite automatic\* has a column-mounted selector (console-mounted in Polara 500 models equipped with optional center console). It is water-cooled, has an aluminum housing, and an internally actuated parking sprag. TorqueFlite automatic is available on all Polara models. (3) The fully synchronized 4-on-the-floor manual-shift transmission\* is available only on Polara 500 models, also equipped with optional 383 (4-bbl.) V8 and optional center console. (4) A special heavy-duty 4-on-the-floor\* is available only on Polara 500 models, also equipped with optional 440-Magnum V8 and optional center console.

## Rear Axle Ratios

A number of rear axle ratios are offered with each Polara engine and transmission team. Standard ratios have been carefully chosen to provide a balance of performance and economy. However, for more specialized applications, your Dodge Dealer can order your Polara or Polara 500 delivered with a more suitable ratio.

You will also want to consider the many advantages offered by the Dodge Sure Grip differential (optional, at extra cost). In sand, snow, and mud, power is transferred to the rear wheel with the better traction.

\*Optional, at extra cost.

## Polara Engines

displacement	318 cu. in.	383 cu. in.	383 cu. in.	440 cu. in.	440-Magnum
no. of cylinders	V8	V8	V8	V8	V8
bore and stroke (in.)	3.91 x 3.31	4.25 x 3.38	4.25 x 3.38	4.32 x 3.75	4.32 x 3.75
tappets	all Polara V8 engines have hydraulic tappets				
carburetor	2-bbl.	2-bbl.	4-bbl.	4-bbl.	4-bbl.
compression ratio	9.2:1	9.2:1	10.0:1	10.1:1	10.1:1
air cleaner	silenced	silenced	double snorkel	double snorkel	double snorkel
exhaust system	single	single	dual	dual	dual
crankcase	4 quarts for all engines—5 quarts when replacing oil filter				
coolant	18 qts.	17 qts.	17 qts.	17 qts.	18 qts.
horsepower @ rpm	230 @ 4400	290 @ 4400	330 @ 5000	350 @ 4400	375 @ 4600
torque (lbs.-ft.) @ rpm	340 @ 2400	390 @ 2800	425 @ 3200	480 @ 2800	480 @ 3200
recommended fuel	regular	regular	premium	premium	premium

440 V8 is offered on wagons only; 440-Magnum V8 is offered on all other models, except wagons.

## Trailer-Towing Package

A Trailer-Towing Package for Dodge Polara models is required for towing trailers with a loaded gross weight of 2,500 lbs. and not exceeding 5,500 lbs. A frame-type load-equalizing hitch is required for trailers having a loaded tongue-weight of 250 lbs. (Hitch not supplied by Dodge.)

Basic equipment includes: maximum cooling system with high-capacity radiator. Larger 7-blade fan. Fan shroud and hood seal. Heavy-duty performance axle, 3.23 ratio. Heavy-duty suspension, front and rear, with sway bar and station wagon shock absorbers. Special, 11" diameter, heavy-duty brakes (manually adjustable). Heavy-duty turn signal flasher. Heavy-duty spotlight switch. Wide-rim, 6-JK wheels.

Trailer-Towing Package is not available on Polara models with 318-cu.-in. V8.

The following, extra-cost equipment is also required: 383 (2-bbl.) V8. TorqueFlite automatic transmission. 8.55 x 14 tires (except station wagons); 8.55 x 14 8PR tires on wagons.

Recommended, additional optional equipment for trailer towing: Sure Grip differential. High-output, 46-amp alternator. Heavy-duty, 70-amp-hr battery with rubber separators and battery heat shield. Power brakes. Air conditioning. High-performance engines like the optional 383 (4-bbl.) V8, 440 (4-bbl.) V8 or 440-Magnum. Automatic Speed Control.

## All Polara models include these items as standard safety equipment.

- Dual Braking System
- turn signals
- padded instrument panel (upper and lower pads)
- master cylinder/parking brake warning light
- windshield washers
- Safety-Action inside door handles
- left, outside, rearview mirror
- retractable, front seat belts
- break-away ashtray on instrument panel
- side marker lights
- soft knobs on window cranks
- Cleaner Air System
- energy-absorbing steering column and wheel

- backup lights
- padded sun visors
- windshield wipers, 2-speed, electric; parallel action blades with glare-resistant finish
- Hazard Warning System
- Safety-Rim wheels
- prismatic, day/night, inside rearview mirror with double-ball-joint safety mount
- rear seat belts
- manual latch on front seatbacks (2-door models)
- padded front seatback
- nonoverride door locks

## Polara Standard Equipment

318-cu.-in. V8 engine  
3-speed manual transmission  
cloth-vinyl interior trim in Polara hardtops and sedan  
all-vinyl interior trim in Polara convertible and station wagons  
front bucket seats, with center cushion/folding armrest, in Polara 500 models  
deep-pile carpeting  
2-spoke steering wheel with padded hub and partial horn ring  
heater/defroster  
cigarette lighter  
glove box door lock  
power top (Polara and Polara 500 convertibles)  
foot-operated parking brake  
sway bar  
choice of 16 exterior colors  
deluxe wheel covers (Polara 500 models)  
crank-operated vent panes  
rear seat foam cushion pad  
24-gallon fuel tank (wagons, 22)

## WARRANTY

Chrysler Corporation warrants to the first and second registered owners the engine block, head and internal parts, intake manifold, water pump, transmission case and internal parts (except manual clutch), torque converter, drive shaft, universal joints, rear axle and differential, suspension system (except shock absorbers), steering gear and linkage system, wheels and wheel bearings of its 1968 automobiles for 5 years or 50,000 miles, whichever occurs first, and all other parts (excluding tires) for 24 months or 24,000 miles, whichever occurs first, against defects in materials and workmanship and will repair or replace such defective parts without charge for parts or labor at any Dodge, Chrysler, Plymouth or Imperial Authorized Dealer's place of business. Maintenance, such as replacement of spark plugs, condensers, ignition points, filters, brake and clutch lining, etc., and normal deterioration of hoses, belts, upholstery, soft trim and appearance items are not included. Maintenance services required under the warranty are: Change engine oil every 3 months or 4,000 miles, whichever occurs first, and replace oil filter every second oil change; check operation of crankcase ventilator valve and clean oil filler cap every 6 months and replace ventilator valve every year; clean carburetor air filter every 6 months and replace every 2 years; lubricate front suspension ball joints and tie rod ends at 3 years or 36,000 miles, whichever occurs first; and every 12 months, (A) have an authorized Dodge, Chrysler, Plymouth or Imperial Dealer certify on an approved Warranty Validation form (i) receipt of evidence of performance of the required services and (ii) the car's then current mileage, and (B) the owner must submit such completed form to Chrysler Motors Corporation. To qualify for continuing warranty coverage, the second registered owner must have an authorized Dodge, Chrysler, Plymouth or Imperial Dealer submit a Transfer of Warranty form to Chrysler Motors Corporation within 30 days from the date of his purchase and receive from Chrysler Motors Corporation validation that the vehicle is eligible for such coverage.

PALM BEACH DODGE, INC.  
2101 OKEECHOBEE RD.  
WEST PALM BEACH, FLA. 33401



**Dodge**

