



Fleet and Commercial

IT ALL ADDS UP.™

2008

Car & Truck Guide



GMC



HUMMER



Updated September 2007

IT ALL ADDS UP

When it comes to using vehicles for business, it's all about getting the job done—and with the broadest lineup in the industry GM, will work with you, our customer, to find a vehicle to meet your needs within your budget. More than 80 car and truck-lines are illustrated in our 2008 Car and Truck Guide, each in its own way offering great value to our customers. But they are just one piece of our overall effort to ensure that you have the best vehicles and the best possible ownership experience now and in the future. GM has the products, technology and experience to lower your operating costs.

GM'S BROAD VEHICLE LINEUP from Chevrolet Aveo to Cadillac DTS in passenger vehicles; Saturn VUE to Buick Enclave in SUV's; the top-selling lineup of full-size pickups; hardworking vans, chassis cabs and cutaways; and the medium duty models; GM offers a range that can't be matched by any other manufacturer. And that means one-stop shopping for all your vehicle needs.

HYBRID VEHICLES are an important part of this year's Guide. The Chevrolet Malibu, Saturn AURA and VUE are all offered with the available GM Hybrid System. The Tahoe and Yukon Hybrids use a new 2-mode full hybrid system.

COST SAVINGS for our commercial customers in the form of specialized programs like OnStar's Business Vehicle Manager to help manage your fleet; GM FleetTrac to provide efficient service to get your drivers back on the road as quickly and safely as possible; and longer service intervals through GM's Oil Life Monitoring System that tells your drivers when to change the vehicle's oil. This is all a part of the General Motors total value proposition for our fleet customers.

TECHNOLOGY on the vehicle and in our operations that provides safe vehicles with advancements in air bags and StabiliTrak; greater fuel efficiency through passenger car and truck hybrid engines and Active Fuel Management; FlexFuel vehicles that can run on E85 ethanol or gasoline; and on the Internet with www.gmfleet.com and the Online Order Guide that provides a wealth of information.

PROFESSIONALS within General Motors and its dealerships are able to meet all of your business transportation needs. The many members of GM Fleet and Commercial are listed on the following pages, but it's important to know the depth of our professional staffs:

- Fleet Account Executives work with our larger fleet accounts and are always ready to answer your questions
- GM Fleet Service Contact Group personnel are dedicated to resolving all vehicle service issues quickly and efficiently
- Fleet Action Center staff offer managers of smaller fleets reliable information and answers
- More than 7,000 GM Dealerships across the country are staffed by salespeople and service technicians ready to assist you with your vehicle purchase, financing and service

All of these groups work together to support all of your vehicle sales and service needs.

Thanks for your business. It's appreciated by every member of the GM team and we will go out of our way each and every day during 2008 – and beyond – to exceed your expectations and continue to earn your loyalty.



Brian McVeigh
General Manager



TABLE OF CONTENTS

INTRODUCTION

Fleet and Commercial Personnel	3
gmfleet.com	6
Fleet Account Number Information	7
Business Central	8
Business Choice	9
Fuel Economy	10
GMAC Commercial Services	11
Warranty and Other Programs	12
GM Technology	14
Alternative Fuels	16
OnStar®	18
XM® Satellite Radio	20
GM Fleet Service and Parts	21
GM North American Assembly Plants	22
Vehicle Segmentation	23

COMPACT CAR

Chevrolet Aveo	24
Chevrolet Cobalt	25
Pontiac G5	26
Pontiac Vibe	27
Saturn ASTRA	28

MIDSIZE CAR

Buick LaCrosse	31
Chevrolet Impala	32
Chevrolet Malibu	33
Pontiac G6	36
Pontiac Grand Prix	37
Pontiac G8	38
Saturn AURA	40

LUXURY CAR

Buick Lucerne	43
Cadillac CTS	44
Cadillac DTS	46
Cadillac STS	47
Saab 9-3	48
Saab 9-5	50

SPORT CAR

Cadillac XLR	52
Chevrolet Corvette	53
Pontiac Solstice	54
Saturn SKY	55

SPORT UTILITY/CROSSOVER

Buick Enclave	56
Cadillac Escalade/ESV	58
Cadillac Escalade EXT	59
Cadillac SRX	60
Chevrolet Avalanche	61
Chevrolet Equinox	62
Chevrolet HHR	63
Chevrolet HHR Panel	64
Chevrolet Tahoe Hybrid	66
Chevrolet Tahoe/Suburban	68
Chevrolet TrailBlazer	69
GMC Acadia	70
GMC Envoy	71
GMC Yukon Hybrid	72
GMC Yukon/ Yukon XL	74
HUMMER H2 SUV/SUT	75
HUMMER H3	76
Pontiac Torrent	77
Saab 9-7X	78
Saturn OUTLOOK	79
Saturn VUE	80

MIDSIZE PICKUP

Chevrolet Colorado	82
GMC Canyon	83

FULL-SIZE PICKUP

Chevrolet Silverado 1500	84
Chevrolet Silverado 2500HD/3500HD	85
GMC Sierra 1500	86
GMC Sierra 2500HD/3500HD	87
GMC Sierra Denali	88

CHASSIS CAB

Chevrolet Colorado	89
Chevrolet Colorado Astro/Mid Box	90
Chevrolet Silverado 3500HD	91
GMC Canyon	92
GMC Canyon Astro/Mid Box	93
GMC Sierra 3500HD	94

PASSENGER VAN

Chevrolet Uplander	95
Chevrolet Express	96
GMC Savana	98

CARGO/CUTAWAY VAN

Chevrolet Express Cargo	100
Chevrolet Uplander Cargo	101
GMC Savana Cargo	102
Chevrolet Express Cutaway	103
GMC Savana Cutaway	104

MEDIUM DUTY

Chevrolet Kodiak C4500/C5500	105
Chevrolet Kodiak C6500/C7500/C8500	106
Chevrolet T-Series	107
GMC TopKick C4500/C5500	108
GMC TopKick C6500/C7500/C8500	109
GMC T-Series	110

SPECIALTY VEHICLES

Chevrolet Impala Police Package	111
Chevrolet Tahoe Police Package	112
Chevrolet Tahoe Special Services	113
Chevrolet Express Transport	114
Silverado/Sierra 3500HD Chassis Cab	115

MOBILITY/PARATRANSIT

Chevrolet Uplander Mobility	116
Chevrolet Express Mobility	117
GMC Savana Mobility	118

Trademark and Disclaimer Information	119
--------------------------------------	-----

FLEET AND COMMERCIAL

General Motors Corporation
MC 482-A20-B76
100 Renaissance Center
Detroit, MI 48265-1000
1-800-FLEETOP (1-800-353-3867)

EXECUTIVE STAFF

Brian McVeigh
General Manager
313-667-8805
MC 482-A20-D76

Teresa L. Orr
Administrative Assistant
313-667-9430
MC 482-A20-D76

William D. Gibson
Director – Fleet & Commercial Sales
313-655-1407
MC 482-A19-C98

Julie Gruber
Director – Finance/Admin.
313-667-3146
MC 482-A19-B68

Richard T. Hagenbach
Director – Rental Sales
313-667-3269
MC 482-A20-D98

David M. Kanous
Director – Fleet Service
313-667-8917
MC 482-A20-D76

Mark E. Mathews
Director – Used Vehicle Activities
313-665-1599
MC 482-A16-B36

James McCallum
Director – Commercial Dealer
Operations
313-667-8508
MC 482-A20-D18

Robert Minton
Director – Communications FCO
313-667-2634
MC 482-A20-D76

Neil Stirling
Director – Customer Support &
Forecasting/Planning
313-667-2390
MC 482-A19-D96

John P. Gaydash
Director – Marketing FCO
313-667-8695
MC 482-A20-B98

Brian E. Bowden
Mktg. Director – Cross Vehicle
Marketing & Commercial Incentives
313-665-0123
MC 482-A20-B98

Mark Karney
Marketing Director – Vans &
Medium Duty
313-665-1430
MC 482-A20-B986

David G. Spence
Director – Commercial Product &
Specialty Vehicles
313-667-1122
MC 482-A20-B98

NORTHEAST REGION

Regional Office
1 Pepsi Way
P.O. Box 8500
Somers, NY 10589-8500
Fax: 914-244-4644

Eddie Messenger
Regional Fleet & Commercial Manager
914-244-6066

Rosemarie Sobel
Administrative Assistant
914-244-6030

Robert Paxton
Regional Commercial Manager
914-244-6068

Larry Turner
Commercial Sales Manager
Washington/Baltimore
800-321-0164 x 8868

Jim Emmi
Commercial Sales Manager
Philadelphia
800-321-0164 x 8869

Michele Zeiss
Commercial Sales Manager
CT, VT, Upstate NY-East
1-800-321-0164 x 8866

Brad Rose
Commercial Sales Manager
New England
800-321-0164 x 8874

Sharon K. Bradley
Commercial Sales Manager
Pittsburgh, Upstate NY-West
800-321-0164 x 8362

Jeff Tomlin
Fleet Account Executive
Pittsburgh, Upstate NY-West
1-800-321-0164 x 6907

Elliott Eichenholz
Fleet Account Executive
New England
800-321-0164 x 6869

Mark Leddy
Fleet Account Executive
New York
800-321-0164 x 6191

Mark Harris
Fleet Account Executive
CT, Upstate NY-East
800-321-0164 x 6190

Michael Paritee
Fleet Account Executive
S. New Jersey & Delaware
800-321-0164 x 6192

Ron Teasley
Fleet Account Executive
Washington/Baltimore
800-321-0164 x 6897

Bev Presti
Fleet Account Executive
North New Jersey
800-321-0164 x 6918

Bob Staub
Fleet Account Executive
Philadelphia
800-321-0164 x 6884

Hank Sullivan
Fleet Service Manager
NY, VT, NH, CT, MA, RI, ME
800-321-0164 x 6195

Lorraine Heinicke
Fleet Service Manager
PA, DE, MD, VA, NV, NJ, DC
800-321-0164 x 6194

Chuck Compagnoni
FAE – Government Sales
NY, VT, NH, CT, MA, RI, ME
1-800-321-0164 x 6189

Jay Ferraro
FAE – Government Sales
PA, DE, MD, VA, NV, NJ, DC
1-800-321-0164 x 8870

NORTH CENTRAL REGION

Regional Office

387 Shuman Blvd. – 300 E.
Naperville, IL 60563
Fax: 630-961-6371

Roy Pikus

Regional Fleet & Commercial Manager
630-961-6425

Sue Bara

Regional Coordinator
630-961-6365

Larry Speicher

Regional Commercial Manager
630-961-6868

Lee Kirby

Commercial Sales Manager
Chicago & East WI
815-230-3631

Rich Kruzel

Commercial Sales Manager
IN & Central IL
574-231-1634

Geoff Lewellen

Commercial Sales Manager
Michigan
248-889-1299

Mike Wilson

Commercial Sales Manager
Ohio
330-637-0965

Rob Stewart

Commercial Sales Manager
Iowa, MN, NC, W-WI
952-435-3386

Jerry Leanderson

Fleet Account Executive – Municipal
MI, OH, IN
630-778-4941

Rich Gunther

Fleet Account Executive – Municipal
MI, OH, IN
630-961-6353

Jack Welsh

Fleet Account Executive – Service
MI, OH, IN
330-418-3860

Rich Moore

Fleet Service Manager
IL, IA, MN, ND, SD, WI
630-551-0670

Roger Beedle

Fleet Account Executive
N. IL/Wisconsin
630-961-6307

Bob Lawler

Fleet Account Executive
Chicago/Northern IN
630-961-6833

Eric Raich

Fleet Account Executive
North/Central Ohio
216-337-0219

L.V. Turner

Fleet Account Executive
IN, Central IL & Cincinnati
317-745-5492

Mike Lambregtse

Fleet Account Executive
Michigan
248-375-5256

Jeff Haag

Fleet Account Executive
IA & MN
952-831-6958

Larry Hauglie

Commercial Trainer – West
1-800-248-0765 x 8526

Ed Cordon

Commercial Trainer – East
1-800-248-0765 x8477

SOUTHEAST REGION

Regional Office

11700 Great Oaks Way, Suite 4
Alpharetta, GA 30022
Fax: 678-240-9709

Michael A Washington

Regional Fleet & Commercial
Manager
678-240-9907
770-634-4928 (cell)

Kathy East

Fleet/Commercial Coordinator
678-240-9801

John Freking

Regional Commercial Manager
678-240-9873
404-210-0378 (cell)

Ted Pfister

Commercial Sales Manager
FL, Puerto Rico
407-319-4621 (cell)

Ray Nowowiecki

Commercial Sales Manager
GA, S-AL, W-SC
404-217-0331 (cell)

Amos Zain

Commercial Sales Manager
TN, N-AL, KY, WV
615-347-2735 (cell)

Kevin Frasz

Commercial Sales Manager
NC, E-SC, VA
704-651-9390 (cell)

Julian Knox

Fleet Account Executive – Sales
GA, AL
404-217-9786 (cell)

Jay Surratt

Fleet Account Executive – Sales
S-FL
561-357-3449
305-710-4729 (cell)

Leland Wallace

Fleet Account Executive – Sales
N-FL
813-654-7557
813-541-5623 (cell)

Steven English

Fleet Account Executive – Sales
E-NC, VA, WV
919-761-9065
919-280-6136 (cell)

Matt Benjamin

Fleet Account Executive – Sales
AL, TN, KY
615-426-7083 (cell)

Griffin Mack

Fleet Account Executive – Sales
NC, SC
704-517-5103

Jim Mellon

Fleet Account Executive – Municipal
AL, GA, KY, TN
407-656-7265
407-375-4801 (cell)

Randy Queen

Fleet Account Executive – Municipal
AL, GA, KY, TN
770-321-6140
404-272-7147 (cell)

Billy Regar

Sales Support Manager –
Police/Municipal
FL
386-295-5637 (cell)

Alan Zak

Fleet Account Executive – Service
KY, GA, TN, AL, NC, SC
770-844-7765
404-210-9409 (cell)

Dana Brodbeck

Fleet Account Executive – Service
FL, Puerto Rico, VA, WV
239-272-5752 (cell)

SOUTH CENTRAL REGION

Regional Office

225 E. John Carpenter Freeway
Suite 1100
Irving, TX 75062
Fax: 972-443-2921

Steve Pottenger

Regional Fleet & Commercial
Manager
972-443-2920

Alice Mason

Administrative Assistant
972-443-3401

Brighton Greene

Regional Commercial Manager
972-443-2917

Dee J. Walls

Commercial Sales Manager
Houston
800-211-3611 x 8020

David Koziol

Commercial Sales Manager
Memphis
800-211-3611 x 6307

Dan Wong

Commercial Sales Manager
Dallas E
800-211-3611 x 8341

Rick Maybury

Commercial Sales Manager
Dallas W
800-211-3611 x 8345

Ron Mealman

Commercial Sales Manager
St. Louis
800-211-3611 x 8343

Lynda Croft

Regional Trainer
800-211-3611 x 8432

Chuck Husby

Fleet Account Executive
Dallas
972-443-2916

Sarah Jensen

Fleet Account Executive
Dallas
972-443-2919

Ernie Albers

Fleet Account Executive
Houston
936-447-3968

Charles Harkless

Fleet Account Executive
Houston
913-705-4257

Phillip Mailey

Fleet Account Executive
Kansas City
913-491-4877

Jerry Meyer

Fleet Account Executive
St. Louis
314-591-1054 (cell)

Frank Ellis

Fleet Account Executive
Memphis
314-512-3976

Doug Jackson

Fleet Account Executive – Service
800-211-3611 x 8377

Robert Cole

Fleet Account Executive – Service
800-211-3611 x 8177

Mark Warren

Alternative Fuel Vehicle Manager
972-443-2918

WESTERN REGION

Regional Office

515 Marin St., Suite 101
Thousand Oaks, CA 91360
Fax: 805-373-8432

Bill Palace

Regional Fleet & Commercial Manager
805-373-9654

Kim Mellon-Smith

Administrative Assistant
805-373-9635

Mark Franczek

Regional Commercial Sales
Manager
805-373-9625

Paul Ryan

Commercial Sales Manager
No. Cal. – Area 1
800-248-5507
Mail Box 35434

Joseph Milton

Commercial Sales Manager
So. Cal. – Area 2
800-248-5507
Mail Box 58853

Paul Dunbar

Commercial Sales Manager
Northwest – Area 3
800-248-5507
Mail Box 58535

Susan Smithson

Commercial Sales Manager
Mountain – Area 4
800-248-5508
Mail Box 58537

Rich Patterson

Commercial Sales Manager
Desert – Area 5
800-248-5507
Mail Box 58536

Mike Sprinkel

Fleet/Commercial Service Manager
North
800-248-5507
Mail Box 58539

Scott Bruske

Fleet/Commercial Service Manager
South
800-248-5507
Mail Box 58541

Dwight Leski

Fleet Account Executive
Denver
800-248-5507
Mail Box 35421

Max Bell

Fleet Account Executive
Los Angeles
800-248-5507
Mail Box 58542

Geoff Spickler

Fleet Account Executive
South CA
800-248-5507
Mail Box 58702

Tom Reilly

Fleet Account Executive
San Diego
800-248-5507
Mail Box 58544

Mark Cummings

Fleet Account Executive
Pacific NW
800-248-5507
Mail Box 35439

Jack Smith

Fleet Account Executive
Phoenix
800-248-5507
Mail Box 35488

Clay Okabayashi

Fleet Account Executive
Alt. Fuels/Gov.
800-248-5507
Mail Box 58820

MEET YOUR NEW BUSINESS PARTNER

To get started, visit gmfleet.com and click on the appropriate tab: Small Business, Fleet, or Government.

Small Business

We're here to help you make the best business decisions without wasting time or resources.

- Search our comprehensive Vehicle Showroom to review all GM models, including commercial applications and other specialty vehicles
- Find current offers, review pricing, and access our Business Choice program
- Locate a dealer and learn what our dedicated Business Central dealers can do for you

Fleet

Find extensive information and tools to help simplify your vehicle management decisions throughout the year.

- Streamline your fleet vehicle research with our comprehensive Vehicle Showroom and resources like the Online Order Guide
- Get details on GM's industry-leading vehicle technologies like StabiliTrak® and OnStar®
- Find a Fleet Account Executive (FAE) in your area who will assist you with fleet purchasing and management
- Access fleet ordering, service, and warranty tools

Government

Get specific information and tools to meet the needs of federal, state and municipal government fleets.

- Research police, alternative fuel, and commercial application vehicles – and the rest of the wide range of vehicles GM offers
- Find a Municipal FAE to help you through the bid process
- Locate GSA catalogs, GSA Auto Choice, and vehicle standards

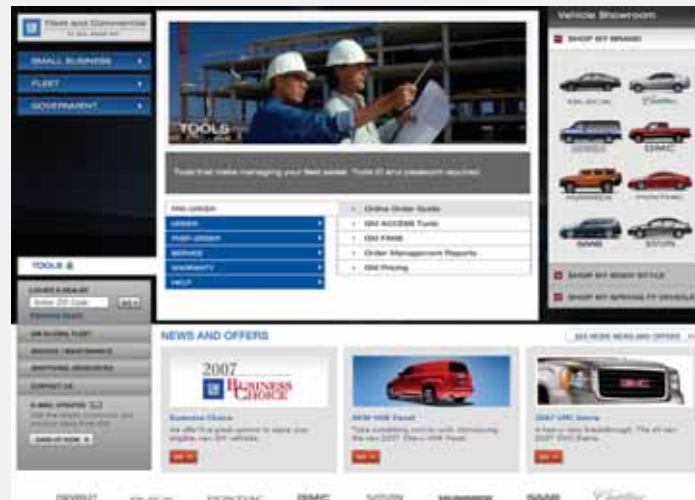

FEATURES AND TOOLS TO TAKE YOUR BUSINESS TO THE NEXT LEVEL

A Comprehensive Vehicle Showroom

More than 80 car and truck models make up GM's broad lineup and each offers an excellent value. The Vehicle Showroom is where you can locate the models that best meet your business needs, including detailed specs, features, photo galleries, and more.

Tools

Access ordering, maintenance and account tools – all the resources that can help take your business to the next level are only one click away.

- Fleet Order Status
- Product Availability
- Online Order Guide and more

Service and Maintenance

We offer a wide variety of helpful service and warranty tools, all in one convenient location, including:

- Service Bulletins and Manuals
- Vehicle Warranty Information
- Fleet Service Programs
- Service and Technical Training

News and Offers

Learn about new GM vehicles, current offers, and new programs and services designed to help your business succeed.

FLEET ACCOUNT NUMBERS

Fleet Account Numbers (FANs) are assigned to qualified fleet users upon application to General Motors Fleet and Commercial through the GM Fleet Account Number System (GMFANS) website. All marketing divisions of General Motors utilize a Common FAN when ordering vehicles for fleets. Qualified fleet users may be eligible for fleet incentives, fleet programs and/or other incentives in conjunction with the purchase or lease of new cars and trucks. Dealers' orders for qualified fleet users may be eligible for fleet allocation, fleet programs and/or other incentives in conjunction with the sale or lease of new cars and trucks.

FLEET ENROLLMENT FORMS

Fleet customers should complete the Fleet Enrollment Screen on the GMFANS website at their GM dealer to be submitted to GM for approval. A qualified fleet user is defined as any company that has purchased and registered or leased 5 or more new cars and/or trucks (any combination of manufacturers) solely for use in its operation during the current or preceding calendar or model year or preceding 12-month period, or that owns or leases 15 or more cars and/or trucks. Political Subdivisions and Public Utilities are qualified fleet users — registration and ownership certifications are not required. All required fields on the enrollment screen must be completed prior to submission to GM for processing. Failure to complete required fields will result in immediate rejection of the application back to the dealer for completion. Qualified fleet users and/or GM Dealers who do not comply with the Fleet Program requirements may have FANs canceled and may be charged back the amount of incentives or allowances. See the GMFANS website for retention rules and other stipulations.

FLEET ENROLLMENT APPLICATION PROCESSING

General Motors Fleet and Commercial Operations receives electronic applications for processing from the website. Each enrollment screen is reviewed prior to issuing new Fleet Account Numbers. The dealer will be informed of the results of this review via electronic mail. If the dealer or the fleet customer needs further clarification concerning a Fleet Account Number, a call should be placed to the Fleet Action Center at 1-800-FLEETOP (1-800-353-3867).

GENERAL MOTORS DUAL FAN (FLEET ACCOUNT NUMBERS) PROCESS

To process orders and deliveries for passenger cars and light duty trucks for Fleet Leasing and Fleet Management Companies, General Motors requires the use of two (2) Fleet Account Numbers. Orders of this type should be entered to the Order Workbench system using the order type "FLS — Fleet Leasing Company." Deliveries of these types of sales should be reported through the Customer Delivery Reporting system using the delivery type "014 — Fleet Leasing Company." The primary FAN to be entered is that of the Fleet Management or Fleet Leasing Company (lessor). The second FAN is that of the end user customer. This procedure allows both the dealers and GM to accurately track orders for its fleet customers.

DEALERS DEDICATED TO YOUR BUSINESS

Chevrolet and GMC dealerships in the coast-to-coast Business Central network feature professionally trained staff dedicated to helping businesses like yours find the right vehicles to do the job — no matter what the job.

Trained professionals know which vehicles are the best for the jobs you do, and can make the widest selection of work-ready vehicles available to you on a moment's notice. They can also advise you on the vehicle features that provide the most sensible working solution.

Each Business Central dealership features service facilities equipped to keep business work vehicles operating at peak efficiency.

The Chevrolet and GMC Business Central network dealerships have the equipment, space and expertise to conduct routine service on your commercial vehicles quickly and efficiently to keep them on the road.

Chevrolet and GMC Business Central Dealers:

- Have dedicated, specially trained business sales staff
- Maintain an inventory of work-ready business trucks, vans and utility vehicles for prompt delivery
- Assist you in outfitting vehicles for your specific needs with access to Special Vehicle Manufacturers and upfit pools
- Offer service facilities that cater to the unique needs of business customers



For full information and the location of Chevrolet and GMC Business Central dealers, visit our websites:

chevybusinesscentral.com

gmcbusinesscentral.com



DESIGNED FOR BUSINESS OWNERS

GM Business Choice offers a wide range of dependable and hard working Chevrolet and GMC vehicle choices that can make things more rewarding and more affordable for your business.[†] GM Business Choice is one of the strongest programs of its kind in the industry and offers up to five options created to help meet your specific business needs with little or no cost.

Visit www.gmbusinesschoice.com for full program details and option information or see your local Chevrolet or GMC dealer to see how your business can benefit.

Choose one great option for each eligible new vehicle you purchase or lease.				
Work-Ready Equipment ¹	Business Resource Cash ²	Business Rewards ³	Business Advantage ⁴	Business Technology ⁵
Your Storage Solution	Resources to Manage Your Business	Let's Build Something Together	Unlimited Rewards	Your Technology Partner
				

[†] The 2007 GM Business Choice program runs from October 1, 2006 through September 30, 2007. The 2008 GM Business Choice program runs from October 1, 2007 through September 30, 2008. To qualify for the GM Business Choice program, your vehicles must be part of the day-to-day operations of your business and you must provide proof of your business. Visit www.gmbusinesschoice.com or see your GMC or Chevy dealer for complete program details.

¹ Adrian Steel warrants all their product against defective workmanship and material for 36 months or 36,000 miles, whichever comes first. Adrian Steel is a registered trademark of Adrian Steel.

² See www.gmbusinesschoice.com for further program details.

³ The entire gift card may be used for future purchases only. No cash back is given on any unused amount.

⁴ The 2007 GM Business Choice program runs from October 1, 2006 through September 30, 2007. The 2008 GM Business Choice program runs from October 1, 2007 through September 30, 2008. Only GM Business Card applicants not meeting credit requirements will receive a GM Business Choice Mastercard® Stored Value Card (amount of card depends on vehicle purchased). Earnings may only be earned on transaction amounts up to a Cardmember's available credit line. Please see the GM World MasterCard for Business Card Program Rules that are applicable to your account. Earnings are administered by Chase. GM World MasterCard for Business Cards are issued by Chase Bank USA, N.A. and may be serviced by its affiliates. Some services may be provided by MasterCard® or other providers. Certain restriction and limitations may apply. Complete details will be provided upon establishing an account. MasterCard is a registered trademark of MasterCard International.

⁵ The entire gift card may be used for future purchases only. No cash back is given on any unused amount. BEST BUY™ is not affiliated with General Motors.

FUEL ECONOMY

EPA CHANGES

EPA recently revised methods for estimating vehicle fuel economy to better represent current driving styles and conditions. The new methods — which apply to model year 2008 and later vehicles — include the city and highway tests used for previous models along with additional tests to represent:

- Faster speeds and acceleration
- Air conditioner use
- Colder outside temperatures

Miles Per Gallon (MPG) estimates will also be adjusted downward to account for factors that are difficult to replicate in a laboratory, such as wind and road surface resistance.

The tests will likely lower MPG estimates for most vehicles.

2008 EPA Estimates were not available at the time this guide was produced. Look for updates to this guide for 2008 Fuel Economy numbers, when they are available.

Also, to more clearly convey fuel economy information to consumers, EPA has updated the vehicle label's design and content. The label on the right reflects the new label design.

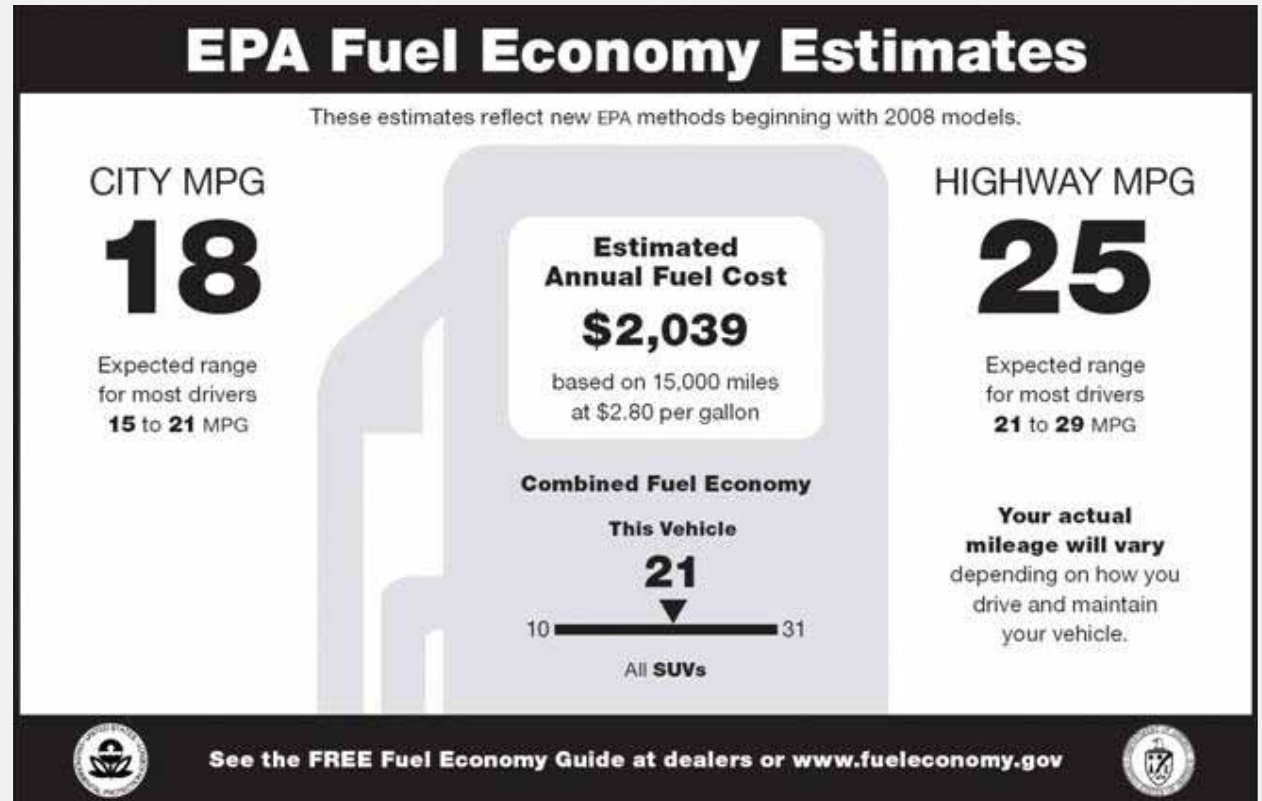

The GMAC Commercial Services Group, located in Dallas, Texas, services business accounts for the entire United States. We have the knowledge and special programs to fit most business transactions that you, as a business customer, depend on to meet your day-to-day requirements. Please contact your local General Motors dealer to inquire about the various plans and programs we offer.

GMAC Commercial SmartLease

(Closed-End Lease Plan) — SmartLease is an affordable way for qualified commercial customers to obtain the new vehicles they need. Terms can be up to 48 months and the residuals can be enhanced for special incentives. With SmartLease, customers pay for the portion of the vehicle they expect to use during the lease term, plus a rental charge, taxes and fees. As a result, SmartLease offers a number of distinct advantages over traditional financing, including potentially lower monthly payments, no resale or trade-in worries, and possible tax benefits. This option also allows customers to lease vehicles with certain specialized upfits. Contact your local GM dealership for additional information.

GMAC ComTRAC Lease

(Open-End Lease Plan) — ComTRAC Lease is an open-end lease plan designed as an alternative to our closed-end Commercial SmartLease. ComTRAC Lease allows customers to take advantage of leasing benefits without the typical security deposit, mileage restrictions and wear-and-tear issues associated with a closed-end lease. In addition, most specialized equipment (upfits) can be financed in the ComTRAC Lease program. Think of ComTRAC as leasing to own; the customer is responsible for the residual value. ComTRAC Lease is available to qualified commercial customers who use their vehicles more than 50% of the time for business purposes. With terms up to 60 months and residuals possibly as low as 0%, the plan is flexible. GMAC owns the vehicle during the lease term, which could give customers potential tax and accounting benefits. If there is a residual balance due to GMAC at the end of the lease term, the customer can purchase the vehicle, trade the vehicle, or sell the vehicle by paying GMAC the residual value plus any unpaid payments and charges. Also, the customer can return the vehicle to

GMAC for remarketing for a fee of \$250 for light duty vehicles and \$500 for medium duty vehicles. If the net sale proceeds are less than the residual value plus unpaid payments and charges, the customer is responsible for the difference. Contact your local GM dealership for additional information.

GMAC Municipal Lease-Purchase Plan

The Municipal Lease is a retail financing program for use by eligible municipalities or political subdivisions for their essential-use vehicles at favorable tax-exempt interest rates. Essential-use vehicles are those vehicles required for the proper functioning of the municipality. Specifically, this plan is designed for municipalities that intend to own their vehicles. The agreement offered to the municipality is highly specialized and includes requisite clauses that allow municipalities to enter into this type of transaction. Eligible vehicles include any new or used passenger car or light- or medium-duty truck up to one model-year old acquired from a dealership with a GM franchise. Upfitted vehicles are also eligible. Municipalities may choose monthly, quarterly, semiannual, or annual payment options. Contact your local GM dealership for additional information.

GMAC Commercial Line of Credit

The Commercial Line of Credit is designed for commercial applications of financing or leasing and is a quick and convenient way for companies to build their commercial fleets. It is flexible enough to meet the individual needs of almost any business. GMAC's Commercial Line of Credit can provide businesses with an additional source of capital designed specifically for the purchase or lease of commercial

vehicles. By using the Commercial Line of Credit, the bank credit lines can be preserved for other business needs. Our goal is to provide quick, easy and flexible service. Once the Credit Line is established with GMAC, a business can build its commercial fleet quickly and easily. Credit Lines remain in effect for a full year. Talk to your local GM dealership about a Line of Credit now in order to make the buying process more efficient. GMAC's Commercial Line of Credit can be a great tool for your business. A Credit Line can be established at your local GM dealership.

GMAC Third Party Guaranty

The Third Party Guaranty program is an exceptional selling point for some customers who require a Co-Applicant. The program offers a method to keep the Co-Applicant's name off the title (e.g., for insurance purposes, etc.) by executing a Third Party Guaranty form. The Third Party Guarantor is not an owner of the vehicle and is not named on the contract or title. The Third Party Guarantor is only responsible should the owner default. The Third Party Guaranty provides an alternative for some customers in an effort to meet a wider variety of customer needs.



WARRANTY AND OTHER PROGRAMS

CHEVROLET, BUICK, GMC, HUMMER, PONTIAC AND SATURN PASSENGER CARS AND LIGHT DUTY TRUCKS

2008 Chevrolet, Buick, GMC, HUMMER, Pontiac and Saturn owners are covered by a limited warranty and services that include the following:

Bumper-To-Bumper Coverage

- The 3-year/36,000 mile (whichever comes first) limited warranty covers repairs for all Chevrolet, GMC, Pontiac and Saturn vehicles, including labor and parts, to correct any defect in materials or workmanship occurring during the warranty period.
- A 4-year/50,000 mile (whichever comes first) limited warranty covers repairs for HUMMER and Buick vehicles, including labor and parts, to correct any defect in materials or workmanship occurring during the warranty period.
- The 6.6L Duramax Diesel engine is covered for 5 years or 100,000 miles, whichever comes first. Please consult your dealer for details.
- Hybrid vehicles have separate component specific coverage. Please consult your dealer for details.

Sheet Metal Coverage

- Corrosion: Body sheet metal panels are covered against rust for 3 years or 36,000 miles, whichever comes first. HUMMER and Buick models are covered for 4 years or 50,000 miles, whichever comes first.
- Rust-through: Any body sheet metal panel that rusts through continues to be covered for up to 6 years or 100,000 miles, whichever comes first. HUMMER and Buick models are covered for 6 years/unlimited mileage.

Courtesy Transportation

- For 5 years or 100,000 miles, whichever comes first, interim transportation may be available under Chevrolet, Buick, Pontiac, Saturn and GMC Courtesy Transportation Programs. Courtesy Transportation is not a part of the New Vehicle Limited Warranty. Please consult your dealer for details. (Excludes vehicles in daily and long-term rental service.)

THE BEST COVERAGE IN AMERICA

100,000 MILE
5 YEAR TRANSFERABLE POWERTRAIN LIMITED WARRANTY*

+

100,000 MILE
5 YEARS OF COURTESY TRANSPORTATION*

+

100,000 MILE
5 YEARS OF ROADSIDE ASSISTANCE*

In addition to the standard 3 year/36,000-mile (whichever comes first) New Vehicle Limited Warranty, all 2008 GM passenger cars, light duty trucks or vans (excluding Medium Duty) come with a 5 Year/100,000-mile (whichever comes first) Powertrain Limited Warranty that:

- has a \$0 deductible
- is transferable to another owner at no charge

Plus, 5 years/100,000 miles of 24/7 Courtesy Transportation and Roadside Assistance*

* Whichever comes first. See dealer for details. Excludes Medium Duty Trucks.

Roadside Assistance

- Chevrolet, Buick, Hummer, Pontiac, Saturn and GMC are proud to offer the response, security and convenience of 24-Hour Roadside Assistance Programs. Roadside Assistance is not a part of the New Vehicle Limited Warranty. Please consult your dealer for details.

CADILLAC OWNER PRIVILEGES

Ownership of a Cadillac encompasses the highest standard of privileges and benefits in addition to the renowned Cadillac Gold Key Delivery System, as listed below.

24-Hour Customer Assistance

- Contact Cadillac by calling the Customer Assistance Center at 1-800-458-8006, or through our website at www.cadillac.com. Our trained professionals are available to assist with any question or concern — 24 hours a day, 365 days a year.

Cadillac Roadside Service

- Cadillac Roadside Assistance is available 24 hours a day, 365 days a year. Should you need Roadside Service, where available, a trained Cadillac technician will be sent to perform the needed repairs/service.

Trip-Interruption Protection

- If Cadillac customers should ever need overnight accommodations due to a warranted repair, Cadillac may reimburse the customer for reasonable hotel, food and even alternate transportation expenses incurred as a result of that repair.

Warranty Protection

- The Cadillac Gold Key Bumper-To-Bumper new vehicle limited warranty covers the vehicle for 4 years/50,000 miles, whichever comes first, with no deductible. The body of every Cadillac is warranted against rust-through for 6 years/unlimited mileage, whichever comes first.

Alternate Transportation

- If the Cadillac vehicle requires warranty repair service for the day, the dealers can furnish shuttle service. The dealer can provide an alternate vehicle if one is available, or reimburse for rental or transportation expense.

Gold Key Delivery

- The Sales Consultant will conduct a thorough inspection, then provide a complete tour of the new Cadillac and present a package of ownership materials.

THE SAAB OWNERSHIP EXPERIENCE WARRANTY PROTECTION

- The Saab new vehicle limited warranty includes bumper-to-bumper coverage for 4 years/50,000 miles, whichever comes first. Safety belt and supplemental restraint coverage is 5 years/unlimited mileage. The perforation limited warranty coverage is 6 years/unlimited mileage for 9-7X and 9-5 and 10 years for 9-3.

Around-the-Clock Emergency Assistance

- Saab owners can call Saab Roadside Assistance toll-free for emergency assistance 24 hours a day, 365 days a year, anywhere in the United States, for the duration of the Powertrain Warranty (5-years/100,000 miles).

Saab Dedicated Delivery Program

- The Saab retailer will conduct a thorough inspection of the new Saab prior to delivery. At the time of delivery, the Saab Sales Consultant will present a complete tour of the vehicle and a package of ownership materials.

MEDIUM DUTY TRUCK VEHICLE AND CHASSIS

Please note: The following warranty information is intended as an overview only for on-highway truck applications. Warranties are valid on original equipment only; upfitted components are not covered. For complete detailed warranty coverage and eligibilities, refer to your GM Warranty Booklet and individual component supplier warranty information.

Warranty Coverage at a Glance

Warranty coverage applies up to the time or mileage limitation, whichever comes first. The warranty remains with the vehicle regardless of ownership.

Tires: See tire manufacturer's information supplied with vehicle.

Note: Courtesy transportation is not available for Medium Duty.

1 An optional limited warranty of 3 years/36,000 miles is available through GM dealers for C4500/C5500 models. See GM dealer.

2 Limited warranty administered by Caterpillar. Towing is covered for 12 months only and labor is not covered in the third year. See Caterpillar Owner's Manual for details.

3 Allison Edge Standard Transmission Coverage administered by Allison. See Allison Owner's Manual for details.

4 3 years for Shuttle Bus.

5 4 years for Shuttle Bus.

* The warranty coverages are determined by the mileage of the vehicle and the number of months from the delivery date.

The warranty coverages are limited by whichever occurs first.

** 50% of dealer's normal charge paid by owner.

*** For diesel units under 14,000 lbs. GVW and all gas units.

VEHICLE COVERAGE FOR TOPKICK/KODIAK C4500-C8500 AND T-SERIES

	Warranty Limitation (time or mileage, whichever comes first)	
	TIME	VEHICLE MILEAGE
Basic Coverage ¹ (except where specified below)	2 years	Unlimited
Vortec 8.1L Gas Engine	2 years	Unlimited
Duramax 6.6L Diesel Engine	5 years	100,000 (\$100 deductible charge per event after 36,000 miles)
Isuzu 6H Diesel Engine	3 years	Unlimited
Caterpillar C7 Diesel Engine (Caterpillar Warranty applies) ²	3 years	150,000 ² (or 3,600 hours)
Allison 1000, 2200, 2300, 2500 RDS or HS Series	3 years	Unlimited
Allison 1000 PTS Series	4 years ⁴	100,000
Allison 2200 PTS	5 years ⁵	100,000
Allison 1000, 2200 MH Series	5 years	200,000
Allison 1000, 2200, 3000, 3500 EVS Series	5 years	Unlimited
Allison 3000, 3500 RDS	3 years	Unlimited
Manual Transmission	2 years	Unlimited
Rear Axle	2 years	Unlimited
Frame Rails & Cross Members	5 years	Unlimited
Cab Corrosion – Perforation	5 years	Unlimited
Emissions – Gas Engines	5 years	50,000
Emissions – Diesel Engine	5 years	100,000

VEHICLE COVERAGE FOR W-SERIES

Basic Coverage (except where specified below)	3 Years	Unlimited (Diesel); 36,000 (Gas)
Engine	3 Years	Unlimited (Diesel); 36,000 (Gas)
• Transmission	3 Years	Unlimited (Diesel); 36,000 (Gas)
• Axles	3 Years	Unlimited (Diesel); 36,000 (Gas)
Frame Rails and Crossmembers	5 Years	** Unlimited**
Engine Emissions (Diesel)	5 Years	100,000
Engine Emissions (Gas)		
• Control System Federal	5 Years	50,000
• Control System Warranty Performance California***	3 Years	50,000
• Control System Defects (Long Term) Warranty California***	7 Years	70,000
Corrosion (Rust Through)	4 Years	Unlimited

STABILITRAK®

Electronic Stability Control systems, such as GM's StabiliTrak, are becoming increasingly important on today's vehicles. StabiliTrak not only helps to enhance vehicle safety but also increases driver confidence and control.

Electronic Stability Control goes by many names. It's called Active Handling on Corvette; Electronic Stability Program (ESP) on Saab; and StabiliTrak on most other GM vehicles. In all cases it provides the same benefits.

Key benefits include:

- Helps the driver maintain control of the vehicle during certain low traction driving conditions such as ice, snow, gravel, wet pavement and uneven road surfaces
- Helps the driver maintain control of the vehicle in emergency lane changes or avoidance maneuvers
- Helps the driver avoid collisions
- Helps automatically — no driver action to activate the system is required

The StabiliTrak system works by recognizing the start of an understeer or oversteer condition. Sensors detect the difference between the direction the driver is actually turning and the vehicle's response by "reading" the steering wheel position, the amount of sideways force in place, vehicle speed, and how the vehicle is turning.

When necessary, the system automatically applies precise amounts of brake pressure at individual wheels and reduces the engine torque to help the driver keep the vehicle on track. These brake and engine interventions help realign the vehicle's path with that being steered by the driver.

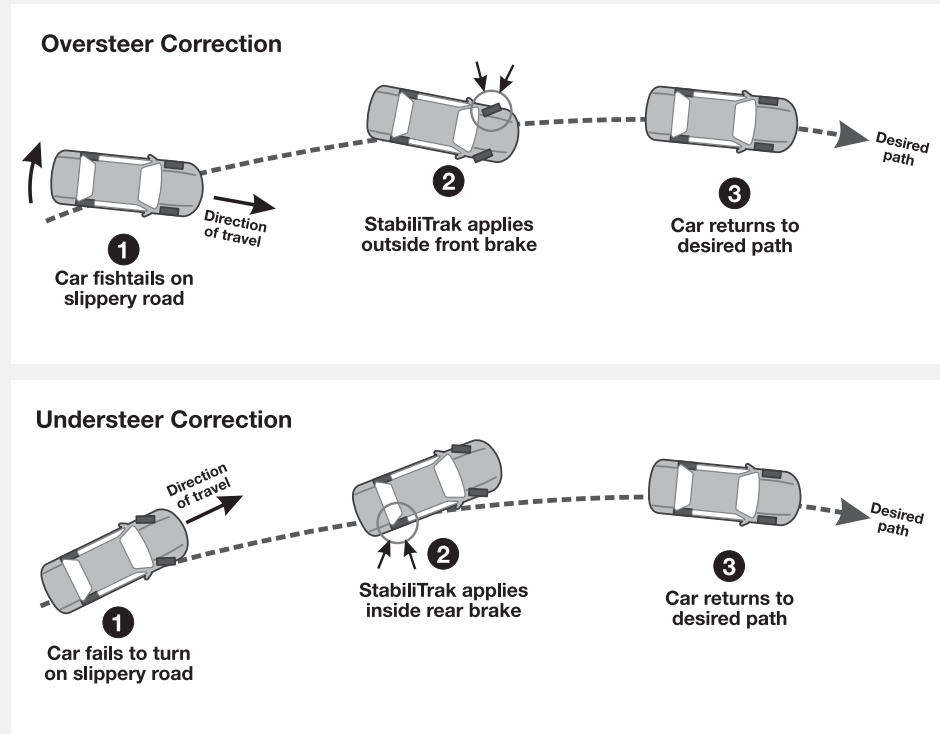

GM OIL LIFE MONITORING SYSTEM™

The GM Oil Life Monitoring System, available on most GM vehicles, is a computer-based algorithm that assesses engine oil conditions and optimizes oil change intervals based on vehicle and environmental operating conditions. The system lets you know when to change the engine oil and filter based on engine usage, engine temperature and driving distances, not on mileage alone. When the system has calculated that oil life has been diminished, a CHANGE ENG OIL light/message will come on to indicate that an oil change is necessary. For the oil life monitoring system to work properly, the system must be reset every time the oil is changed.

Benefits of the system include:

- Reduces oil change frequency by changing the oil only when necessary — this lowers overall operating costs and saves time
- Takes guesswork out of the proper time to change engine oil and filter
- Provides reassurance that the engine is running with good oil, which improves the long-term performance and reliability of the vehicle
- Helps minimize environmental waste, by reducing the amount of oil used and disposed



TIRE PRESSURE MONITORING SYSTEM

This system, available on many GM vehicles, monitors tire pressure and uses a visual display to alert the driver of a low-pressure condition in one or more tires. Two types of systems are used in GM vehicles:

- Indirect Tire Pressure Monitoring System monitors tire pressure by assessing wheel speed. Decreasing inflation results in increasing wheel speed
- Direct Tire Pressure Monitoring System monitors pressure through pressure transducers. Sensors are located in each wheel integral with the valve. Actual tire pressure information for each tire is available to the driver

By informing the driver of low tire pressure situations, the Tire Pressure Monitoring System helps:

- Reduce tire deterioration
- Save fuel, since under-inflated tires make the engine work harder
- Increase vehicle stability and safety

This system does not apply to the spare tire.



CONTINUOUS SAFETY

Only GM is committed to offering a full range of cars, trucks and SUVs that offer GM Continuous Safety: protection before, during and after vehicle collisions. That means more peace of mind on the road. The following features are standard or optional on GM vehicles.

Safety Before: Helping You Avoid a Crash

- Standard Daytime Running Lamps (DRLs)
- StabiliTrak® Control System available
- Antilock Brake System (ABS) available
- Traction control available
- All-Wheel Drive (AWD) available

Safety During: Helping to Protect the Driver and Passengers

- Standard safety belts
- Standard crush zones
- Standard protective safety cage
- GM vehicles offer a variety of advanced air bags:¹
 - Frontal air bag sensing system
 - Side-impact air bags
 - Head curtain side-impact air bags
 - Dual-depth air bags

Safety After: Help can be on the way when you need it

- OnStar^{®2} — If your vehicle is equipped with OnStar[®] and your air bag deploys, OnStar[®] is designed to send a signal to a trained Advisor, who is there for you 24 hours a day, 7 days a week
- Advanced Automatic Crash Notification (AACN) — enables an OnStar[®] Advisor to provide emergency personnel with crash severity information even if airbags do not deploy

ALTERNATIVE FUELS

GENERAL MOTORS — DRIVING CHANGE WITH ADVANCED TECHNOLOGIES AND ALTERNATIVE FUELS

As you consider the possibility of adding alternative fuel vehicles to your fleet, consider GM's leadership role in developing vehicles capable of using alternative fuel sources.

Consider these GM facts:

- First original equipment manufacturer (OEM) to offer hybrid full-size pickups
- Chevrolet Malibu and Saturn VUE and AURA Hybrids available for the 2008 model year
- Full-size SUV Hybrids are available in 2008 model year
- Wide availability of E85 capabilities
- Leadership role in developing fuel cell vehicles

GM is a leader in producing a complete range of FlexFuel vehicles that can run on either E85 or gasoline. General Motors is now building 400,000 new FlexFuel vehicles a year.



E85

What it is

E85 ethanol is a blend of 85% ethanol and 15% gasoline. It's a renewable fuel made mostly from U.S.-grown corn.

Because it helps to reduce greenhouse gas emissions, E85 ethanol is an exciting new energy resource. That's why GM already has over 2 million FlexFuel vehicles, capable of running on E85 ethanol, gasoline, or a combination of both, on the road today in all 50 states. And GM is building 400,000 new FlexFuel vehicles a year.

Where it is

Because GM FlexFuel vehicles can run on E85 ethanol or gasoline, you can choose the fuel that's best for you at over 1,000 E85 service stations nationwide. That number is growing. Go to <http://www.e85refueling.com/> to find a station near you.

Why it's great

GM keeps offering E85 capability because it helps to:

- Reduce greenhouse gas emissions
- Reduce dependence on petroleum
- Reduce smog-forming emissions
- Support the domestic agriculture industry in the U.S.

livegreen
goyellow
.com

2008 GM VEHICLES OFFERING FLEXFUEL CAPABILITY

Chevrolet	Avalanche Express Impala Silverado Suburban Tahoe Uplander Police Impala Police Tahoe
GMC	Savana Sierra Yukon Yukon XL



HYBRID VEHICLES

Hybrid Vehicles Help GM Improve Fuel Economy, Reduce Emissions

Producing hybrid vehicles is one piece of GM's strategy to improve fuel economy and reduce vehicle emissions, along with improving the efficiency of the traditional internal combustion engine and developing hydrogen fuel cell vehicles. GM is applying hybrid technology to high-volume and high-fuel-consuming vehicles first to save as many gallons of fuel as possible.

VUE, AURA and Malibu

Very affordable hybrid-powered powertrains are offered in the Saturn VUE Green Line, Saturn AURA Green Line and Malibu Hybrid.

These vehicles use GM's hybrid system. The Ecotec 4-cylinder engine works with the sophisticated electric motor/generator to shut off the engine at stops, restart the engine when the brake pedal is released, charge the advanced nickel metal hydride battery through regenerative braking, and perform intelligent battery charging when it is most efficient.

Tahoe and Yukon

Chevrolet Tahoe and GMC Yukon Hybrid models use a two-mode patented full hybrid technology optimized for both city and highway driving.

At low speed and light loads, the first mode operates by electric power or engine power or any combination.

The second mode is primarily for highway speeds providing electric assist and full V8 power when needed. It integrates sophisticated electronic controls, Active Fuel Management™, cam phasing and late-intake valve closure for efficient engine operation.

A 300-volt battery pack is larger than a typical battery, but fits in without compromising passenger space. No plug-in is required.



ADDITIONAL TECHNOLOGY

More Efficient Powertrains

Gasoline-powered engines and transmissions are continuing to be further refined to improve fuel economy and performance, and reduce exhaust emissions. Powertrain technologies available today include cam phasing, port deactivation, direct injection, diesel particulate filters and 6-speed automatic transmissions. Today, GM offers many vehicles with Active Fuel Management™, a cylinder-deactivation system that allows engines to operate on only half their cylinders under certain low-load conditions.

Cleaner Diesel Engines

Chevrolet Silverado and GMC Sierra Heavy-Duty Pickups with the new Duramax 6.6L Turbo Diesel V8 comply with regulations that require the reduction of nitrogen oxide and hydrocarbons by more than 50%, and particulate matter by 90%. New technology and the use of Ultra Low Sulfur Diesel fuel are combined with the new engine to deliver the power and torque demanded by commercial customers.

Additionally, the Duramax engine is bio-diesel compatible. That means fuel-grade bio-diesel (B5 or up to 5% bio-diesel) — produced to strict industry standards — can be used.



Life happens while your drivers are on the road.



That's why there's OnStar.

Help your drivers can count on — that's OnStar.

Life can surprise you, even when you're driving. That's why OnStar is there: to offer your drivers help when they need it. With OnStar, they'll have access to a knowledgeable Advisor who knows their names and locations, as well as nearby service providers available to them.

If it happens on the road, OnStar Advisors are there.

Having OnStar is like traveling with a trusted companion, ready to help with most situations. OnStar includes safety features that can help drivers with everything from door unlock assistance to calling for emergency help. In fact, OnStar has answered over 53 million calls for help since its inception in 1996.

The choice is easy.

With availability on over 50 GM cars, trucks, and SUVs, OnStar can fit into almost any price range — helping you save money and allowing your entire fleet to drive with the enhanced peace of mind OnStar offers. A GM vehicle equipped with OnStar is a better choice to help keep your drivers — and your investment — protected while on the road.

GM vehicles offer the peace of mind of OnStar. Ford, Chrysler, Toyota, and Honda don't offer OnStar.



Safety and convenience just took a new turn! New OnStar Turn-by-Turn Navigation will be available on more than one million GM vehicles in 2008. Customers who require an upgrade to the Directions & Connections Plan to receive the added benefits of OnStar Turn-by-Turn Navigation can do so during their initial year of service for only \$100. Ask your dealer or press your blue OnStar button for more details!

ONSTAR IS AVAILABLE FACTORY-INSTALLED ON THESE 2008 MODELS:

 <i>Cadillac</i> CTS DTS Escalade Escalade ESV Escalade EXT SRX STS XLR STS-V XLR-V	 BUICK Enclave LaCrosse Lucerne Terraza	 PONTIAC G5 G6 Coupe G6 Convertible G6 Sedan G8 Grand Prix Solstice Torrent Vibe	 CHEVROLET Avalanche Cobalt Colorado Corvette Equinox HHR Impala Malibu Silverado Suburban Tahoe TrailBlazer Uplander
 9-3 9-5 9-7X	 Acadia Canyon Envoy Envoy Denali Sierra Sierra Denali Yukon Yukon Denali Yukon XL Yukon XL Denali	 SATURN AURA OUTLOOK SKY VUE	HUMMER H2 H2 SUT H2 SUV H3









Visit onstar.com/fleet for details.

OnStar is available on over 50 GM models.

The first year of OnStar service is included on all new OnStar-equipped GM models.

After the first year, the Safe & Sound Plan costs just \$16.95 a month.*

ONSTAR SERVICES

	Safe & Sound SM	Directions & Connections [®]
 OnStar Vehicle Diagnostics¹ Automatic diagnostic check of certain key vehicle operating systems with monthly e-mail reports.	●	●
 OnStar Turn-by-Turn Navigation² Simple, audio-based directions to safely get you to your destination.		●
 Advanced Automatic Crash Notification³ An Advisor can call for help if the vehicle is involved in frontal-, rear-, or side-impact crashes — regardless of air bag deployment.	●	●
 Automatic Notification of Air Bag Deployment If your air bags deploy, we can contact you to ask if you need assistance.	●	●
 Emergency Services If you ever need help, OnStar is your link to emergency services.	●	●
 Stolen Vehicle Location Assistance⁴ If your vehicle is stolen, an Advisor can help authorities attempt to locate it.	●	●
 Remote Door Unlock⁵ An Advisor can send a signal to unlock your doors in most cases.	●	●
 Hands-Free Calling⁶ Allows you to make and receive voice-activated phone calls in your vehicle.	●	●
 Roadside Assistance If you run out of gas or get a flat tire, we can send assistance to your exact location.	●	●
 AccidentAssist Get step-by-step guidance about what to do in the event of an accident.	●	●
 RideAssist Call OnStar if you're incapable of driving, and we'll call a taxicab.		●
 Point of Interest/Convenience Services Get service recommendations and directory information from an Advisor.		●

* Plus tax. Credit card payment required for monthly subscription.

** Plus tax. Prices/Packages subject to change.

¹Available on 2004 MY and newer GM models equipped with the GM Oil Life System. Diagnostics not available on Pontiac Vibe; Saab 9-3, 9-5. Diagnostic services vary on Cadillac SRX V8; Saturn VUE, ION, and L-Series; Chevy Silverado Diesel; and GMC Sierra Diesel. For details, call 1.888.4.ONSTAR (1.888.466.7827). ²Turn-by-Turn Navigation is not available in certain areas. See dealer for details. Antilock brakes required. ³Advanced Automatic Crash Notification vehicle availability varies by model. Ability to ⁴locate stolen vehicles and ⁵Remote Door Unlock success vary with conditions. Not available on Saab 9-3, 9-5 models. ⁶OnStar Hands-Free Calling (HFC) requires an HFC-enabled vehicle, existing OnStar service contract, and prepaid minutes or enrollment in a shared minutes plan. Not available in certain markets. Calls may be made to the U.S. and Canada only. OnStar services require vehicle electrical system (including battery), wireless service, and GPS satellite signals to be available and operating for features to function properly. OnStar acts as a link to existing emergency service providers. ©2007 OnStar Corp. All rights reserved. OnStar and the OnStar emblem are registered trademarks of OnStar Corp. The marks of General Motors, its divisions, slogans, emblems, vehicle model names, vehicle body designs, and other marks appearing in this document are the trademarks and/or service marks of General Motors Corporation, its subsidiaries, affiliates, or licensors.

OnStar Business Vehicle Manager

Your fleet management solution.

Each month, vehicles enrolled in OnStar Business Vehicle Manager (BVM) automatically send OnStar the current odometer reading, oil life and any open recalls. Two consolidated reports (summary, detail by VIN) are sent to participating fleets each month. To receive BVM, fleets must order code **RFA**. RFA is a **no-charge option** and matches the length of OnStar multiyear service.

The benefits of BVM include:

- Timely and optimal maintenance
- Reduction of unnecessary maintenance costs
- Accurate vehicle mileage logs

ONSTAR FACTORY OPTION PACKAGES FOR FLEET

Package Description	Option Code	Vehicles with Safe & Sound Standard**	Vehicles with D & C Standard**	Free Flow (UE1)**
One additional year of Safe & Sound (24-month total)	R8G	\$199	\$199	N/A
Two additional years of Safe & Sound (36-month total)	R8P	\$379	\$379	N/A
First year upgrade to Directions & Connections or Turn-by-Turn	R8W	\$100	N/A	N/A
One additional year of Directions & Connections (24-month total)	R8Y	\$399	\$299	N/A
Two additional years of Directions & Connections (36-month total)	R8Z	\$679	\$579	N/A
Three years of S & S "Free Flow," including hardware (36-month total)	R8U	N/A	N/A	\$679
Three years of Directions & Connections "Free Flow," including hardware (36-month total)	R8V	N/A	N/A	\$979
Three additional Years of Safe & Sound (48-month total)	RFG	\$539	\$679	N/A
Four additional Years of Safe & Sound (60-month total)	RFH	\$679	\$679	N/A

ONSTAR BUSINESS VEHICLE MANAGER FACTORY OPTIONS

Package Description	Option Code	Vehicles with Safe & Sound Standard**	Vehicles with D & C Standard**	Free Flow (UE1)**
OnStar Business Vehicle Manager requires: (A) Multiyear OnStar order (length of BVM service mirrors length of multiyear service), (B) Signed Fleet Master Agreement, (C) CODE MUST BE ORDERED TO RECEIVE SERVICE.	RFA (Requires UE1)	N/C	N/C	N/A





ON WHEREVER YOUR FLEET GOES.

Purchase GM fleet vehicles with factory-installed XM*, and give your drivers the programming variety that will keep them productive and entertained:

- Instant traffic & weather channels in 21 major metropolitan areas, helping your fleet avoid slowdowns and prepare for bad weather
- The biggest names in news (CNN, FOX News, CNBC), keeping your fleet informed around the clock
- 69 channels of commercial-free music, from old favorites to new discoveries
- The most sports coverage — Major League Baseball®, NHL hockey games, the PGA TOUR®, ESPN Radio and more, so your drivers can hear the big games and events while they're on the road



TURN YOUR DRIVE ON.

HEAR IT FOR YOURSELF.

VISIT GM.XMRADIO.COM ANYTIME AND SIGN UP FOR A FREE ONLINE TRIAL.



*Available in the 48 contiguous United States. Required \$12.95 monthly subscription sold separately after three trial months. All fees and programming subject to change. Subscription subject to customer agreement. For more information, visit gm.xmradio.com. The XM name and related logos are registered trademarks of XM Satellite Radio Inc. ©2007 XM Satellite Radio Inc. All rights reserved. The GM Emblem is a registered trademark of General Motors Corp. ©2007 General Motors Corp. All rights reserved.

Table of Contents

GM FLEET SERVICE — VALUE FOR YOU!

Best Coverage in Industry

- 100,000-mile/5-year Powertrain Limited Warranty*
- 100,000-mile/5-year Roadside Assistance*
- 100,000-mile/5-year Courtesy Transportation*
- Transfer to subsequent owner
- \$0 Deductible

*Whichever comes first. See dealer for details.

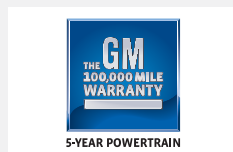

Fleet Focused Solutions

- Dedicated Fleet Sales, Service and Parts organization
- Experienced in assisting fleets with maximizing vehicle uptime and driver convenience
- Operating expense consultation
- Fleet Customer Support Center 1-800-FleetOp (1-800-353-3867)



GM FleetTrac

- Nationwide network of over 4,200 GM FleetTrac Dealers
- Consolidated billing service
- No client administration fees
- No enrollment fees
- Designed for businesses with 25 to 5,000 vehicles
- 1-888-4GM FLEET (1-888-446-3533)
- Visit www.gmfleettrac.com



Maintenance Savings Technology

- Oil Life Monitoring System (available on select models)
- Simplified maintenance
- Tire Pressure Monitoring System (available on select models)
- Business Vehicle Manager available through OnStar (available on OnStar-equipped models)



Training

- Web based technical training
- Instructor-led classroom sessions provide hands-on technical training
- For more information, please go to
 - www.gmtraining.com
 - www.acdelcotechconnect.com



FOR FLEETS WITH IN-HOUSE MAINTENANCE AND REPAIR FACILITIES, GM HAS QUALITY PARTS FOR YOUR GM AND NON-GM VEHICLES

GM Parts

- High quality GM Parts designed, manufactured, and tested to help keep your GM vehicle running at peak performance
- Your GM Goodwrench dealer carries a full line of genuine GM Parts — Maintenance/Repair, Collision, Powertrain, and GM Accessories



ACDelco Parts

- Meet stringent quality standards and available for GM and non GM vehicles
- ACDelco is a global leader in the independent automotive aftermarket and offers over 100,000 quality parts across 37 product lines



ACDelco Key Fleet Program

Offers fleets technical and related benefits to increase efficiency and reduce downtime

- Provides no charge product training and service seminars
- Technical assistance hot line
- Discounts on SPX tools, equipment, service and training manuals
- For additional information www.acdelcotechconnect.com



Fleet Parts Purchase Program (FPPP)

ACDelco program for fleets with multiple repair facilities

- Competitive pricing on ACDelco parts
- Consolidated billing
- Standardized fleet pricing
- Local delivery from ACDelco Warehouse Distributors
- For additional information www.acdelcotechconnect.com



WIP (WISE Internet Parts)

On-line parts/ordering link to local ACDelco WDs

- Order history and saved order sheets
- Labor, tech specs, and other optimal modules available soon
- For additional information call 1-800-825-5886, option 3



UNMATCHED GM DEALER NETWORK

- Over 6,800 GM Goodwrench locations nationwide — the industry's largest automotive service provider
- Goodwrench Multi-Point Vehicle Inspection
- Advanced diagnostic equipment and a link to GM engineers that supply daily service information
- GM-trained and ASE-certified technicians with over 1 million hours of training annually

- Genuine GM Parts, manufactured to meet the exact specifications of your GM vehicle
- One-stop shopping for all your service needs — including tires and glass
- Go to GMGoodwrench.com for a location near you



GM NORTH AMERICAN ASSEMBLY PLANTS

PASSENGER CAR ASSEMBLY PLANT ASSIGNMENT

Assembly Location	Division	Brand
Bowling Green	CADILLAC CHEVROLET	XLR CORVETTE
Detroit/Hamtramck	BUICK CADILLAC	LUCERNE DTS
Fairfax	SATURN CHEVROLET	AURA MALIBU
Lansing Grand River	CADILLAC CADILLAC	STS CTS
Lordstown	CHEVROLET PONTIAC	COBALT G5
Orion	PONTIAC	G6
Oshawa 1	CHEVROLET	IMPALA
Oshawa 2	BUICK PONTIAC	LACROSSE GRAND PRIX
Wilmington	PONTIAC SATURN	SOLSTICE SKY
Nummi (Joint Venture)	PONTIAC	VIBE

TRUCK ASSEMBLY PLANT ASSIGNMENT

Assembly Location	Division	Brand
Arlington	CHEVROLET GMC CADILLAC CHEVROLET GMC CADILLAC	TAHOE YUKON ESCALADE SUBURBAN YUKON XL ESCALADE ESV
Doraville	CHEVROLET	UPLANDER
Flint 3	CHEVROLET GMC ISUZU CHEVROLET GMC ISUZU	C SERIES C SERIES C SERIES T SERIES T SERIES T SERIES
Flint 1	CHEVROLET GMC	SILVERADO CREW SIERRA CREW
Fort Wayne	CHEVROLET GMC CHEVROLET GMC	SILVERADO REG SIERRA REG SILVERADO EXT SIERRA EXT
Janesville 1	CHEVROLET GMC CHEVROLET GMC	TAHOE YUKON SUBURBAN YUKON XL
Lansing Delta Township	SATURN BUICK GMC	OUTLOOK ENCLAVE ACADIA
Lansing Grand River	CADILLAC	SRX

Assembly Location	Division	Brand
Moraine	CHEVROLET GMC SAAB	TRAILBLAZER ENVOY 9-7X
Oshawa Truck	CHEVROLET GMC CHEVROLET GMC	SILVERADO EXT SIERRA EXT SILVERADO CREW SIERRA CREW
Pontiac Assembly	CHEVROLET GMC CHEVROLET GMC	SILVERADO REG SIERRA REG SILVERADO EXT SIERRA EXT
Ramos Arizpe 2	CHEVROLET SATURN	HHR VUE
Shreveport	CHEVROLET GMC HUMMER	COLORADO CANYON H3
Silao Assembly Plant	CHEVROLET CHEVROLET CADILLAC CHEVROLET GMC	SUBURBAN AVALANCHE ESCALADE EXT SILVERADO CREW SIERRA CREW
Toluca Assembly	CHEVROLET	SILVERADO
Wentzville	CHEVROLET GMC	EXPRESS SAVANA
Cami (Joint Venture)	CHEVROLET PONTIAC	EQUINOX TORRENT
Mishawaka (Joint Venture)	HUMMER HUMMER	H2 SUV H2 SUT

COMPACT CAR

Chevrolet Aveo/Cobalt
 Pontiac G5/Vibe
 Saturn ASTRA

Dodge Caliber
 Ford Focus
 Honda Civic/Fit/FCX/Insight
 Hyundai Accent/Elantra
 Kia Rio/Rondo/Spectra
 Mazda 3,5
 Mini Cooper/Clubman
 Mitsubishi Lancer
 Nissan Sentra/Versa
 Scion tC/xA/xB
 Subaru Impreza
 Suzuki Aerio/Forenza/Reno/SX4/Swift
 Toyota Corolla/Matrix/Yaris/Prius
 Volkswagen Beetle/Golf/GTI/Jetta/Rabbit/ EOS

MIDSIZE

Buick LaCrosse
 Chevrolet
 Impala/Malibu/
 Pontiac G6/Grand Prix/G8
 Saturn AURA

Chrysler 300/Sebring
 Dodge Avenger/Charger/Magnum
 Ford Crown Victoria/Five Hundred/Fusion
 Honda Accord
 Hyundai Azera/Sonata/XG
 Kia Amanti/Optima
 Mazda 6
 Mercury Grand Marquis/Milan/Montego
 Mitsubishi Galant
 Nissan Altima/Maxima
 Subaru Legacy/Outback
 Toyota Avalon/Camry/Solara
 Volkswagen Passat

LARGE/LUXURY

Buick Lucerne
 Cadillac CTS/DTS/STS
 Saab 9-3/9-5

Aston Martin
 Bentley Arnage/Azure/Continental/
 Flying Spur
 Acura RL/TL/TSX
 Audi A3/A4/Avant A4/A5/A6/Avant A6/A8
 BMW 3-, 5-, 6-, 7-Series
 Infinity G35/M35/M45
 Jaguar S-, X-Type/XJ/XK
 Lexus ES/GS/IS/LS/SC
 Lincoln Town Car/Zephyr/MKZ
 Maybach
 Mercedes-Benz CLK/C-, CL-, CLS-, E-, S-, SL-Class
 Rolls Royce
 Volvo Volvo C30/C70/S40/S60/S80/V50/V70/XC70

SPORT

Cadillac XLR
 Chevrolet Corvette
 Pontiac Solstice
 Saturn SKY

Audi TT/R8
 BMW Z4
 Chrysler Crossfire
 Dodge Viper
 Ferrari
 Ford Mustang
 Honda S2000
 Hyundai Tiburón
 Lamborghini
 Lotus Elise/Exige
 Maserati
 Mazda MX-5 Miata/RX-8
 Mercedes-Benz SLK/SLR
 MG TF
 Mitsubishi Eclipse
 Nissan 350Z/GT-R
 Porsche 911/Boxter/Cayman

SPORT UTILITY

Buick Enclave
 Cadillac Escalade/SRX
 Chevrolet Avalanche/Equinox/HHR/Tahoe/TrailBlazer/Suburban
 GMC Acadia/Envoy/Yukon/Yukon XL
 HUMMER H2/H3
 Pontiac Torrent
 Saab 9-7X
 Saturn VUE/OUTLOOK

Acura MDX/RDX
 Audi Q7
 BMW X3/X5
 Chrysler Aspen/Pacifica/PT Cruiser
 Dodge Durango/JC49/Nitro
 Ford Edge/Escape/Expedition/Expedition EL/Explorer/Freestyle/SportTrac
 Honda CR-V/Element/Pilot
 Hyundai Santa Fe/Tucson/Veracruz
 Infinity CX/FX/QX56
 Isuzu Ascender
 Jeep Commander/Compass/Grand Cherokee/Liberty/Patriot/Wrangler
 Kia Sorento/Sportage
 Land Rover LR2/LR3/Range Rover/Range Rover Sport
 Lexus GX470/JX/LX/RX/VX
 Lincoln MARK LT/MKX/Navigator/Navigator L
 Mazda CX-5/CX-7/CX-9/Tribute
 Mercedes-Benz G-, GL, M-, R-Class
 Mercury Mariner/Mountaineer
 Mitsubishi Endeavor/Montero/Outlander
 Nissan Armada/Murano/Pathfinder/Serenity/Xterra
 Porsche Cayenne
 Subaru B9 Tribeca/Forester
 Suzuki Grand Vitara/XL7
 Toyota 4Runner/FJ-Cruiser/Highlander/Land Cruiser/RAV4/Sequoia
 Volkswagen Touareg
 Volvo XC90

MEDIUM PICKUPS

Chevrolet Colorado
 GMC Canyon

Dodge Dakota
 Ford Ranger
 Honda Ridgeline
 Isuzu I-Series
 Mazda B-Series
 Mitsubishi Raider
 Nissan Frontier
 Toyota Tacoma

FULLSIZE PICKUPS

Chevrolet Silverado 1500/2500/3500
 GMC Sierra 1500/2500/3500

Dodge Ram 1500/2500/3500
 Ford F-150
 Ford SuperDuty F250/F350
 Nissan Titan
 Toyota Tundra

PASSENGER VAN

Chevrolet Express/Uplander
 GMC Savana

Chrysler Town & Country
 Dodge Caravan/Sprinter
 Ford Econoline/Freestar/Traveler
 Freightliner Sprinter
 Honda Odyssey
 Hyundai Entourage
 Kia Sedona
 Mercury Monterey
 Nissan Quest
 Toyota Sienna
 Volkswagen Minivan

CARGO VAN

Chevrolet Express/Uplander
 GMC Savana

Dodge Sprinter
 Ford Econoline
 Freightliner Sprinter

SELECTED STANDARD FEATURES
Safety and Security

- Advanced dual-stage front air bags with Passenger Sensing System¹
- Side-impact air bags¹ for driver and front passenger
- 3-point safety belts, all positions, with front seat height adjustment
- Child security rear door locks
- LATCH (Lower Anchors and Top tethers for CHildren) system
- Daytime Running Lamps
- Tire Pressure Monitoring System⁹

Interior

- Reclining cloth front bucket seats with driver height adjustment
- 60/40 split-folding rear seat; flip-and-fold on 5-door
- Floor console
- Full instrumentation including tachometer
- Tilt adjustable steering column
- Padded visors with vanity mirrors
- 12-volt power outlet
- AM/FM stereo with digital clock and auxiliary input jack
- Cargo shade (Aveo5)

- Air conditioning (LS & LT)
- Air conditioning provisions and kit for dealer install (SVM)
- Rear-window defogger
- Carpeted floor mats (LS & LT)

Mechanical

- Front-wheel drive
- ETEC II 1.6L DOHC 16-valve L4 with 103 hp and 100,000-mile/5-year Powertrain Limited Warranty (whichever comes first, see dealer for details)
- Electronic throttle control
- 5-speed manual transmission
- Power front disc/rear drum brakes
- Independent front/semi-independent rear suspension
- Power rack-and-pinion steering
- Stainless steel exhaust system

Exterior

- Intermittent front windshield wipers
- Fold-away rearview mirrors
- P185/60R14 all-season tires
- Full bolt-on wheelcovers
- Rear wiper/washer on Aveo5

SELECTED OPTIONAL FEATURES

- Antilock brake system
- Leatherette seats
- Cruise Control
- Power Package includes Remote Keyless Entry, power door locks, power windows and content theft-deterrent system
- Power sunroof
- Audio: CD/MP3 player, 6-disc CD changer, 6-speaker premium sound system
- Engine block heater
- 4-speed automatic transmission
- Front fog lamps
- 15-inch aluminum wheels
- P185/55R15 all-season tires
- Rear spoiler

OVERVIEW

Aveo — Chevrolet's entry-level vehicle — is available in the 4-door sedan model or the Aveo5 model with a rear hatchback. Both models comfortably seat five, and include plenty of extra features.

NEW FOR 2008

- Tire Pressure Monitoring System standard
- Chromed door handles available (standard on LT)
- Cruise control is now orderable on LS models

MODEL AVAILABILITY

	4-door	Aveo5
Aveo SVM	—	1TD48
Aveo LS	1TD69	1TD48
Aveo LT	1TG69	—

SPECIFICATIONS (inches unless otherwise stated)

Wheelbase	97.6	97.6
Length	169.7	152.7
Width	67.3	65.7
Height	58.9	58.8
Seating f/r	2/3	2/3
Head room f/r	39.3/37.4	39.2/37.6
Shoulder room f/r	53.6/52.8	53.6/52.7
Leg room f/r	41.3/35.4	41.2/35.3
Max. cargo vol. ⁴ (cubic feet)	12.4	42.0
Fuel capacity ⁸ (gallons)	11	11

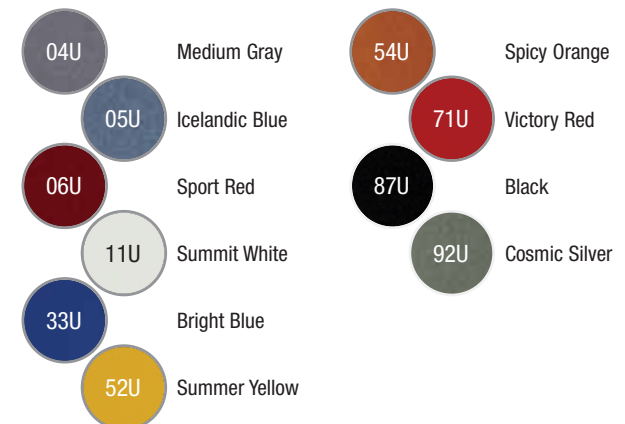

Shown with optional equipment

AVAILABLE EXTERIOR COLORS¹⁵



SELECTED STANDARD FEATURES
Safety and Security

- Dual-stage front air bags with Passenger Sensing System¹
- Head curtain side-impact air bags¹ (fleet delete available)
- 3-point safety belts, all positions
- Child security rear door locks
- LATCH (Lower Anchors and Top tethers for Children) system
- PASS-Key III+ theft-deterrent system
- Daytime Running Lamps with automatic lamp control
- OnStar 1-year Safe & Sound Plan² (fleet delete available)
- Tire Pressure Monitoring System⁹

Interior

- Reclining front bucket seats with driver height adjustment
- 60/40 split-folding rear seat
- Floor console includes 2 power outlets
- Air conditioning with air filtration system
- Rear and side window defoggers
- Tilt adjustable steering column

- Full instrumentation including tachometer and Driver Information Center
- Power door locks and Remote Keyless Entry (available LS)
- AM/FM stereo with CD player, auxiliary input jack, XM Satellite Radio³

Mechanical

- Front-wheel drive
- 2.2L Ecotec DOHC 16-valve L4 with 145 hp — LS, LT
- 2.4L Ecotec DOHC 16-valve L4 with 171 hp — Sport
- 5-speed manual transmission
- Power front disc/rear drum brakes
- Electric power rack-and-pinion steering
- Stainless steel exhaust system

Exterior

- Intermittent speed-sensitive front windshield wipers
- P195/60R15 touring tires
- Full bolt-on wheelcovers
- Halogen headlamps

SELECTED OPTIONAL FEATURES

- StabiliTrak[®] stability enhancement system
- Antilock brake system
- Leather-appointed front bucket seats
- Power sunroof
- Remote Vehicle Starter System
- Cruise control
- Performance Package (LT)
- Audio: MP3 player, Pioneer premium sound, 6-disc CD changer
- Traction control
- 4-speed automatic transmission
- 16- and 17-inch aluminum wheels
- Rear spoiler

OVERVIEW

For 2008, Chevrolet Cobalt offers both coupes and sedans with added safety features as standard items. Its comfortable ride and long list of standard and available features make it particularly well suited to a wide variety of fleet customers.

NEW FOR 2008

- Models now include LS, LT and Sport
- StabiliTrak[®] stability enhancement system standard on Sport
- Traction control available
- Head curtain side-impact air bags¹ standard (fleet delete available)
- OnStar 1-year Safe & Sound Plan² standard (fleet delete available)
- Chromed Package available on LT Sedan
- Tire Pressure Monitoring System⁹ standard
- XM Satellite Radio³ standard (fleet delete available)

MODEL AVAILABILITY

	Coupe	Sedan
Cobalt LS	1AK37	1AK69
Cobalt LT	1AL37	1AL69
Cobalt Sport	1AM37	1AM69

SPECIFICATIONS (inches unless otherwise stated)

Wheelbase	103.3	103.3
Length	180.5	180.3
Width	67.9	67.9
Height	55.5	57.1
Seating f/r	2/3	2/3
Head room f/r	38.7/35.7	38.5/37.7
Shoulder room f/r	53.0/49.0	53.0/51.4
Leg room f/r	42.0/32.2	41.8/33.7
Max. cargo vol. ⁴ (cubic feet)	13.9	13.9
Fuel capacity ⁸ (gallons)	13	13

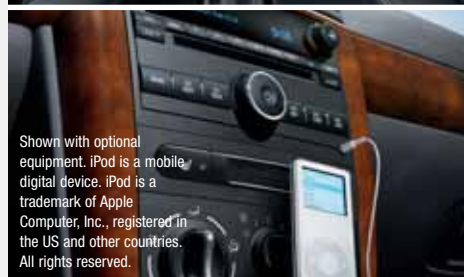
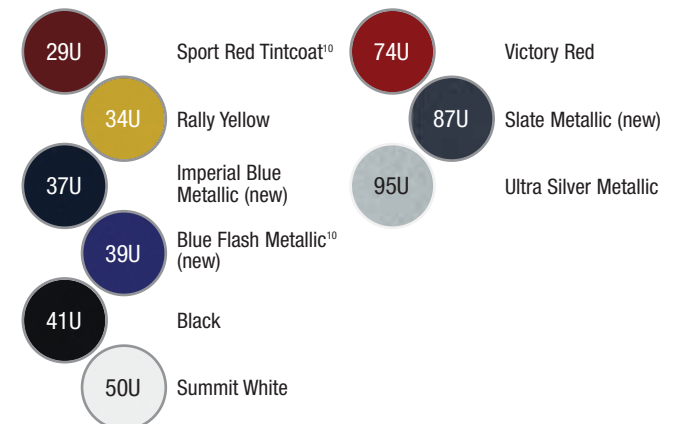
AVAILABLE EXTERIOR COLORS¹⁵



SELECTED STANDARD FEATURES
Safety and Security

- Dual-stage front air bags with Passenger Sensing System¹
- Head curtain side-impact front/rear air bags¹
- 3-point safety belts, all positions
- Trunk emergency release handle
- LATCH (Lower Anchors and Top tethers for Children) system
- PASS-Key III+ theft-deterrent system
- Daytime Running Lamps with automatic lamp control
- Tire Pressure Monitoring System⁹

Interior

- Reclining front bucket seats with driver height adjustment and manual lumbar control
- 60/40 split-folding rear seat
- Floor console includes 2 power outlets
- Air conditioning with air filtration system
- Rear and side window defoggers
- Full instrumentation including tachometer and Driver Information Center

- Tilt adjustable steering column
- Power door locks and Remote Keyless Entry
- AM/FM stereo with CD/MP3 player and auxiliary input jack
- XM Satellite Radio³

Mechanical

- Front-wheel drive
- 2.2L Ecotec DOHC 16-valve L4 with 148 hp — G5
- 2.4L Ecotec DOHC VVT 16-valve L4 with 173 hp — GT
- 5-speed manual transmission
- Power front disc/rear drum brakes
- Electric power rack-and-pinion steering
- Stainless steel exhaust system

Exterior

- Intermittent speed-sensitive front windshield wipers
- P195/60R15 touring tires
- 15-inch steel wheels with full bolt-on wheelcovers
- Rear spoiler

SELECTED OPTIONAL FEATURES

- Antilock brake system (G5)
- StabiliTrak[®] stability enhancement system (standard GT)
- OnStar 1-year Safe & Sound Plan² (GT only, fleet delete available)
- Leather-appointed seating
- Heated front seats
- Power sunroof
- Remote Vehicle Starter System
- Sport Package
- Audio: Pioneer premium 7-speaker sound system, 6-disc CD changer, steering wheel controls
- Traction control
- 4-speed automatic transmission
- 16- and 17-inch aluminum wheels
- Preferred Package including cruise control, cargo net, antilock brake system, body-color bodyside moldings, 16-inch custom spoke wheels

OVERVIEW

Pontiac G5 provides buyers with an entry-level sports coupe with many standard features. In 2008 many safety features become standard, including head curtain air bags,¹ Tire Pressure Monitoring System⁹ and, on GT, StabiliTrak[®] stability enhancement system and OnStar² with 1-year standard service.

NEW FOR 2008

- Head curtain side-impact front/rear air bags¹ standard
- Tire Pressure Monitoring System⁹ standard
- XM Satellite Radio³ standard
- OnStar 1-year Safe & Sound Plan² standard on GT (fleet delete available)
- StabiliTrak[®] stability enhancement system standard on GT

MODEL AVAILABILITY

	Coupe
G5	2AL37
G5 GT	2AN37

SPECIFICATIONS (inches unless otherwise stated)

Wheelbase	103.5
Length	179.8
Width	67.5
Height	55.6
Seating f/r	2/3
Head room f/r	38.1/35.7
Shoulder room f/r	53.1/49.3
Leg room f/r	42.0/32.2
Max. cargo vol. ⁴ (cubic feet)	13.9
Fuel capacity ⁸ (gallons)	13

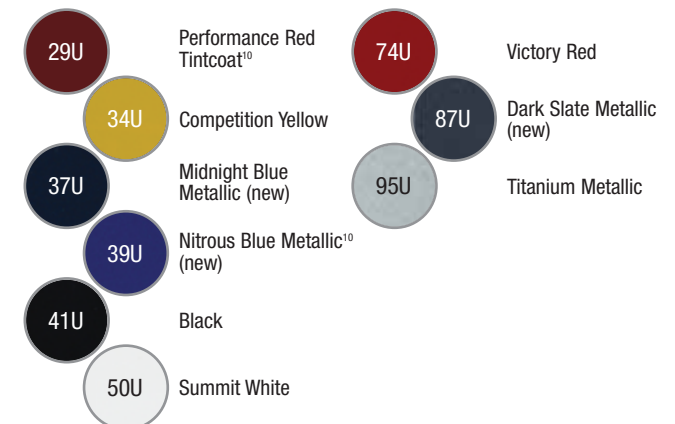
AVAILABLE EXTERIOR COLORS¹⁵



SELECTED STANDARD FEATURES
Safety and Security

- Front air bags with Passenger Sensing System¹
- 3-point safety belts, all positions; height-adjustable in front
- Child security rear door locks
- LATCH (Lower Anchors and Top tethers for CHILDREN) system
- Daytime Running Lamps with automatic lamp control

Interior

- Front bucket seats with driver height adjustment
- Fold-flat front passenger seat, with table surface
- 60/40 split-folding rear seat
- Floor console
- Air conditioning with air filtration system
- Full instrumentation including tachometer and outside temperature display
- Tilt adjustable steering column

- 8 storage compartments and rear cargo track system with tie-downs
- 115-volt, 2-prong power outlet
- AM/FM stereo with CD
- Electric rear window defogger

Mechanical

- Front-wheel drive
- 1.8L VVT-i L4 with 126 hp
- 5-speed manual transmission
- Power front disc/rear drum brakes
- Front independent suspension; rear torsion beam

Exterior

- Fog lamps
- Power mirrors
- Luggage rack with side rails
- P205/55R16 all-season tires
- Full bolt-on wheelcovers
- Rear liftgate with liftglass
- Intermittent front and rear wipers

SELECTED OPTIONAL FEATURES

- Side-impact and head curtain side-impact air bags¹
- StabiliTrak[®] stability enhancement system
- Theft-deterrent alarm system
- Preferred Package including Remote Keyless Entry, power programmable door locks, power windows, cruise control, dual reading lights, illuminated entry
- OnStar 1-year Safe & Sound Plan²
- Premium Package with leather seating surfaces
- Power sunroof
- Audio: MP3 player, 6-disc CD changer, XM Satellite Radio,³ Monsoon premium sound
- 4-speed automatic transmission
- Antilock brake system
- 16- and 17-inch aluminum wheels
- Premium Monotone Package
- Sport Package

OVERVIEW

Pontiac Vibe offers a blend of performance, style and functionality that makes it a great choice for personal and business use. Flip the rear seats and the 54.1 cubic feet of cargo space⁴ provides room for supplies, deliveries or samples.

NEW FOR 2008

- Tire Pressure Monitoring System⁹ standard

MODEL AVAILABILITY

	Hatchback
Vibe	2SL26

SPECIFICATIONS (inches unless otherwise stated)

Wheelbase	102.4
Length	171.9
Width	69.9
Height	62.2
Seating f/r	2/3
Head room f/r	40.6/39.8
Shoulder room f/r	53.2/52.6
Leg room f/r	41.8/36.3
Max. cargo vol. ⁴ (cubic feet)	54.1
Fuel capacity ⁸ (gallons)	13



All equipment should be properly secured.



Shown with optional equipment

AVAILABLE EXTERIOR COLORS¹⁵

14U	Platinum (Silver)	62U	Neptune (Blue)
19U	Abyss (Black)	90U	Moonstone (Charcoal)
22U	Wave (Blue)		
40U	Frosty (White)		
44U	Salsa (Dark Red)		
46U	Stealth Gray Metallic		



OVERVIEW

The all-new ASTRA brings a decidedly European flavor to the North American compact car market. It is packed with a wide range of standard equipment and safety features, and delivers sporty performance with very good fuel economy. ASTRA is offered in 3-Door and 5-Door models.

MODEL AVAILABILITY

	3-Door	5-Door
ASTRA XE	-	ZAR48
ASTRA XR	ZAT08	ZAT48

SPECIFICATIONS (in. unless otherwise stated)

Wheelbase	102.9	102.9
Length	170.5	170.5
Width	69.0	69.0
Height	55.8	57.4
Seating (max.)	2/3	2/3
Head room f/r	37.8/36.6	38.9/38.3
Shoulder room f/r	53.9/52.7	53.9/52.8
Leg room f/r	42.3/35.0	42.0/35.3
Max. cargo vol. ⁴ (cu. ft.)	12.0	12.2
Fuel capacity ⁸ (gal.)	12	12

All ASTRA models convey a sporting character through firm, well-supported seats and a thick, three-spoke steering wheel with rake and telescopic adjustments.





SELECTED STANDARD FEATURES

Safety and Security

- Dual-stage front, side-impact and head curtain side-impact air bags¹
- OnStar 1-year Safe & Sound Plan²
- Theft-deterrent system
- LATCH system (Lower Anchors and Top tethers for CHildren) for child safety seats in all 3 rear seating positions
- Daytime Running Lamps and automatic lamp control
- Pedal release system
- Tire Pressure Monitoring System⁹

Interior

- Front reclining bucket seats with active, adjustable and removable head restraints. 3-Door has enhanced bolsters, driver lumbar and seat height adjuster
- Rear 60/40 split-folding seat with retractable dual cupholders in seat cushion
- Driver manual lumbar adjustment, high-sport seats (3-Door)
- Cruise control
- Power windows
- Steering wheel audio and Driver Information Center controls

- Rake/telescoping adjustable steering column
- Front floor console with cupholder and power outlet
- AM/FM stereo with CD player and 6-speaker system
- Remote Keyless Entry
- Driver Information Center with external temperature display

Mechanical

- Front-wheel drive
- 1.8L VVT DOHC 4-cylinder engine with 138 horsepower
- 5-speed manual transmission
- 4-wheel disc antilock brake system
- Independent front and torsion beam axle rear suspension
- Electro-hydraulic power steering

Exterior

- Rain-sensing intermittent front windshield wipers and rear wiper
- Halogen headlamps with auto on/off
- P205/55R16 all-season touring tires
- Steel wheels with full wheelcovers

SELECTED OPTIONAL FEATURES

- StabiliTrak[®] vehicle stability control system
- Front projector beam fog lamps (standard on XR)
- Air conditioning (standard on XR)
- Seating options: heated front seats, leather seating surfaces
- Ambient LED interior lighting
- Audio options: Advanced Audio Package, MP3 playback, 6-disc CD changer, premium speaker system
- Power dual-panel sunroof (5-Door only)
- 4-speed automatic transmission
- Alloy 16-, 17- and 18-inch wheels

StabiliTrak vehicle stability control system with traction control is standard on all 3-Door ASTRAs, and available on 5-Door models. This system works in concert with the standard four-wheel antilock brake system to help the driver maintain control during adverse road conditions or during sudden emergency driving situations.

AVAILABLE EXTERIOR COLORS¹⁵

- 10U Arctic White
- 2HU Black Sapphire
- 63U Salsa Red
- 1RU Silver Sand
- 2AU Star Silver
- 4CU Twilight Blue

OVERVIEW

For Buick LaCrosse the big news in 2008 is the new Super model with a V8 engine. In addition, many features have been added to the standard list, offering fleet customers a premium midsize sedan that only Buick can provide.

NEW FOR 2008

- LaCrosse Super model including a V8 engine
- Chromed waterfall grille
- Standard features on all models include dual-zone automatic climate control, Driver Information Center, Remote Vehicle Starter System, XM Satellite Radio,³ tilt/telescoping adjustable steering column, steering wheel-mounted audio controls, content theft alarm, Chromed Appearance Package, trunk cargo net

MODEL AVAILABILITY

	Sedan
LaCrosse CX	4WC19
LaCrosse CXL	4WD19
LaCrosse CXS	4WE19
LaCrosse Super	4WN19

SPECIFICATIONS (inches unless otherwise stated)

Wheelbase	110.5
Length	198.1
Width	73.0
Height	57.4
Seating f/r (max.)	3/3
Head room f/r	39.4/37.2
Shoulder room f/r	57.2/57.0
Leg room f/r	42.3/37.6
Max. trunk vol. ⁴ (cubic feet)	16.0
Fuel capacity ⁸ (gallons)	17

SELECTED STANDARD FEATURES
Safety and Security

- Dual-stage front and head curtain side-impact air bags with Passenger Sensing System¹
- 3-point safety belts, all positions
- Rear child security locks
- OnStar 1-year Directions & Connections Plan² with Turn-by-Turn Navigation
- PASS-Key III theft-deterrent system
- Content theft alarm
- Daytime Running Lamps and Twilight Sentinel[®]
- Tire Pressure Monitoring System[®]
- Antilock brake system with traction control

Interior

- QuietTuning
- Front bucket seats with 6-way power driver seat
- Floor console
- Dual zone automatic climate control and air filtration system
- Full instrumentation including tachometer, Driver Information Center, compass
- Cruise control

- Remote Keyless Entry and Remote Vehicle Starter System
- Tilt/telescoping adjustable steering column
- Programmable power door locks
- AM/FM stereo with CD, XM Satellite Radio³ and digital clock

Mechanical

- Front-wheel drive
- 3.8L V6 with 200 hp (CX, CXL)
- 3.6L VVT DOHC V6 with 240 hp (CXS)
- 5.3L V8 with 300 hp (Super)
- 4-speed automatic transmission
- Power 4-wheel disc brakes
- 4-wheel independent suspension
- Power rack-and-pinion steering; Magnasteer on CXS, Super

Exterior

- Intermittent front windshield wipers with flat blades
- Full bolt-on wheelcovers
- Power outside rearview mirrors
- P225/60R16 all-season tires
- Chromed Appearance Package

SELECTED OPTIONAL FEATURES

- StabiliTrak[®] stability enhancement system with full-function traction control
- 6-passenger seating with center flip-and-fold console (CX, CXL)
- Leather-appointed seating
- Split-folding rear seat
- Heated front seats
- Power sunroof
- Universal Home Remote
- Audio options: 6-disc CD changer, MP3 player, Concert Sound III
- 16-, 17- or 18-inch aluminum wheels
- Ultrasonic Rear Parking Assist

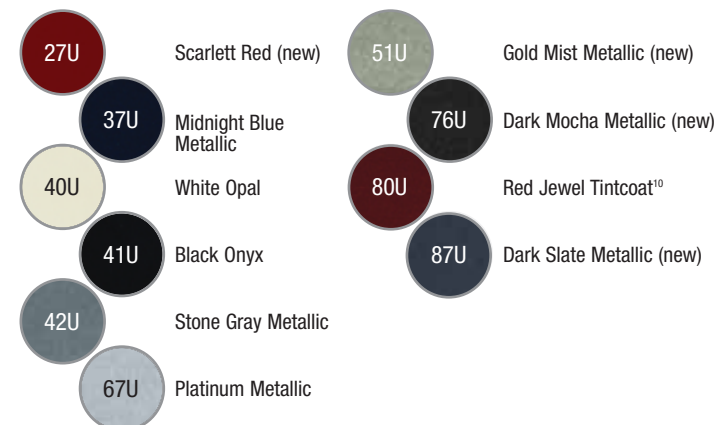
AVAILABLE EXTERIOR COLORS¹⁵



Shown with optional equipment

OVERVIEW

Chevrolet Impala remains a midsize favorite for fleet buyers. It has large car room, utility and value, with premium quality features and attention to detail. Impala's available flip-and-fold-flat rear seats provide a variety of uses for passengers and/or cargo.

NEW FOR 2008

- StabiliTrak® stability enhancement system standard on 3.9L V6 and 5.3L V8
- 6-way power driver seat standard (8-way standard on LTZ and SS)
- New 18-inch wheels — machined aluminum standard on LTZ and chrome aluminum available on SS
- XM Satellite Radio³ and MP3 capability are standard

MODEL AVAILABILITY

	Sedan
Impala LS	1WB19
Impala LT 3.5L	1WT19
Impala LT 3.9L	1WC19
Impala LTZ	1WU19
Impala SS	1WD19

SPECIFICATIONS (inches unless otherwise stated)

Wheelbase	110.5
Length	200.4
Width	72.9
Height	58.7
Seating f/r (max.)	3/3
Head room f/r	39.4/37.8
Shoulder room f/r	58.7/58.6
Leg room f/r	42.3/37.6
Max. cargo vol. ⁴ (cubic feet)	18.6
Fuel capacity ⁸ (gallons)	17

For 2 years in a row, 2006 and 2007, Impala has won the prestigious Fleet Car of the Year Award from *Automotive Fleet & Business Fleet* magazines.





Shown with optional equipment

SELECTED STANDARD FEATURES

Safety and Security

- Dual-stage front air bags with Passenger Sensing System¹
- Head curtain side-impact air bags¹ (fleet delete available)
- 3-point safety belts, all positions (except front center)
- LATCH (Lower Anchors and Top tethers for CHildren) system
- Rear door child security locks
- OnStar 1-year Safe & Sound Plan² (fleet delete available)
- PASSlock theft-deterrent system
- Daytime Running Lamps and automatic lamp control
- Tire Pressure Monitoring System⁹

Interior

- Front bucket seats
- 6-way power driver seat with ratcheting lumbar control
- Floor console with shifter
- Air conditioning with filtration
- Cruise control
- Programmable power door locks
- Full instrumentation including Driver Information Center
- Remote Keyless Entry

Mechanical

- Tilt adjustable steering column
- Visors with vanity mirrors
- Power windows include driver Express Down
- AM/FM stereo with CD/MP3 and auxiliary input jack
- XM Satellite Radio³ (fleet delete available; also removes RDS and MP3 capability)
- Front-wheel drive
- 3.5L VVT V6 with 211 hp and FlexFuel capability (LS & LT V6)
- Oil Life Monitoring System
- Power 4-wheel disc brakes
- 4-wheel independent suspension
- Power rack-and-pinion steering
- Battery rundown protection and retained accessory power
- StabiliTrak[®] stability enhancement system standard on 3.9L V6 and 5.3L V8

Exterior

- Intermittent front windshield wipers with flat blades
- Power outside rearview mirrors
- P225/60R16 all-season tires
- Full bolt-on wheelcovers

SELECTED OPTIONAL FEATURES

- StabiliTrak[®] stability enhancement system (standard 3.9L V6 and 5.3L V8)
- Antilock brake system
- Front seat options: front split-bench seats, leather seating surfaces, heated, 8-way power driver (standard on LTZ and SS)
- Flip-and-fold flat rear seat with underseat storage
- Power sunroof
- Universal Home Remote
- Audio options: 6-disc CD changer, Bose premium system, steering wheel-mounted controls
- Dual-zone climate control
- 3.9L VVT V6 with 233 hp, FlexFuel capability, Active Fuel Management[™] (LT V8 & LTZ)
- 5.3L V8 with 303 hp, FlexFuel capability, Active Fuel Management[™] (SS)
- Full-function traction control
- Fog lamps
- Heated outside rearview mirrors
- 16-, 17- and 18-inch aluminum wheels
- Remote Vehicle Starter System



Impala's standard E85 FlexFuel capability allows the vehicle to run on either gasoline or E85 — a blend of 85% ethanol and 15% gasoline or a combination of both. E85 is a mostly cleaner-burning, mostly renewable fuel source made from U.S.-grown biomaterial, such as corn or other grain products. It helps reduce greenhouse gases and can enhance the nation's economy and energy independence.

AVAILABLE EXTERIOR COLORS¹⁵

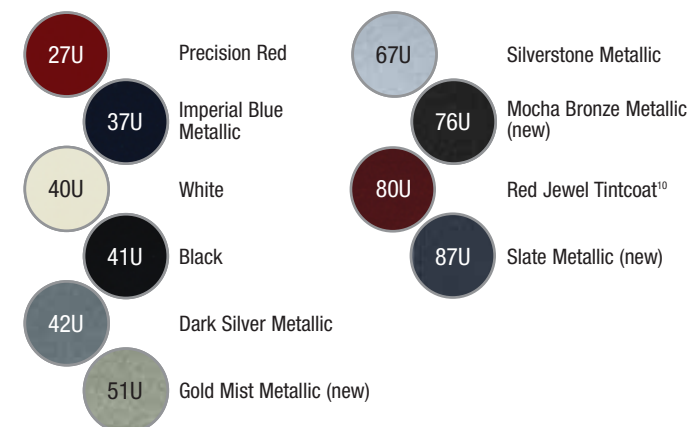



Shown with optional equipment

OVERVIEW

The new Malibu sets a high standard in class, quality, confidence and control for the midsize segment. It has expressive new styling, exciting powertrain combinations – including a hybrid model available later in the year – and technology advancements.

MODEL AVAILABILITY

	Sedan
Malibu LS	1ZG69
Malibu LT	1ZH69
Malibu LTZ	1ZK69
Malibu Hybrid	1ZF69

SPECIFICATIONS (inches unless otherwise stated)

Wheelbase	112.3
Length	191.8
Width	70.3
Height	57.1
Seating	2/3
Head room f/r	39.4/37.2
Shoulder room f/r	55.9/53.9
Leg room f/r	42.2/37.6
Max. cargo vol. ⁴ (cubic feet)	15.1
Fuel capacity ⁸ (gallons)	16.4



A classic Chevrolet dual-cockpit theme, along with harmonious, elegant colors and fabrics, immediately create a feeling of refinement and precision.



SELECTED STANDARD FEATURES

Safety and Security

- Dual-stage front and side-impact air bags with Passenger Sensing System¹
- Head curtain side-impact air bags¹
- LATCH system in all 3 rear seats for child safety seats
- Rear door child security locks
- OnStar 1-year Safe & Sound Plan² (fleet delete available)
- PASS-Key III+ theft-deterrent system
- Daytime Running Lamps and automatic lamp control
- Tire Pressure Monitoring System⁹

Interior

- Front bucket seats with driver manual lumbar control and power height adjustment
- Rear 60/40 split-folding seats
- Console with sliding armrest, power outlets, storage
- Driver Information Center
- Specific hybrid instrumentation
- Air conditioning
- Cruise control

- Tilt/telescoping adjustable steering column
- AM/FM stereo with CD/MP3, XM Satellite Radio³ (fleet delete available)
- Remote Keyless Entry
- Programmable power door locks

Mechanical

- Front-wheel drive
- 2.4L Ecotec 4-cylinder with 169 hp
- 4-speed automatic transmission
- 4-wheel disc antilock brake system
- Independent front and rear suspension
- Traction control
- Variable-effort electric power steering

Exterior

- Intermittent front windshield wipers
- P215/60R16 touring tires
- Folding, power outside rearview mirror
- Acoustic laminated windshield and front glass

SELECTED OPTIONAL FEATURES

- StabiliTrak[®] stability enhancement system (LT and LTZ)
- Seating options: 8-way power driver, leather seating surfaces, heated seats
- Power adjustable pedals
- Automatic climate control
- Rear power center (110-volt and 12-volt outlets)
- Audio options: 6-disc CD changer, Premium Sound System, steering wheel controls
- 3.6L VVT V6 with 252 hp
- Hybrid Propulsion Equipment (Hybrid)
- 6-speed automatic transmission with tap-up/tap-down manual shift control on the steering wheel
- Power sunroof
- 17- and 18-inch aluminum wheels
- Remote Vehicle Starter System
- LED taillamps (LTZ)

The Malibu Hybrid uses GM's Hybrid system to reduce fuel consumption. The Ecotec 4-cylinder engine works with the sophisticated electric motor/generator to shut off the engine at stops, restarts the engine when the brake pedal is released, charges the advanced nickel metal hydride battery through regenerative braking, and performs intelligent battery charging when it is most efficient.

AVAILABLE EXTERIOR COLORS¹⁵

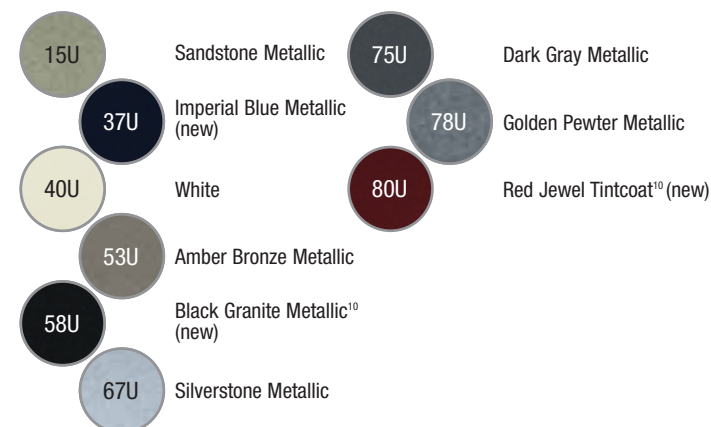

SELECTED STANDARD FEATURES
Safety and Security

- Dual-stage front, side-impact and head curtain side-impact air bags with Passenger Sensing System¹ (head curtain not available on Convertible)
- 3-point safety belts
- LATCH (Lower Anchors and Top tethers for CHildren) system
- PASS-Key III+ theft-deterrent system
- Daytime Running Lamps and automatic lamp control
- OnStar 1-year Safe & Sound Plan²

Interior

- Front reclining bucket seats
- 60/40 split-folding rear seat (except Convertible)
- 4-way power driver seat adjuster with ratcheting lumbar
- Front console with armrest and storage
- Full instrumentation including Driver Information Center
- Tilt/telescoping adjustable steering column

Air conditioning

- AM/FM stereo with CD and auxiliary input jack
- Programmable power door locks

Mechanical

- Front-wheel drive
- 2.4L Ecotec 4-cylinder engine with 169 hp (G6)
- 3.5L V6 with 219 hp (GT)
- 3.6L V6 with 252 hp and 6-speed automatic transmission (GXP)
- 4-speed automatic transmission
- Power 4-wheel disc antilock brake system
- Full-function traction control
- 4-wheel independent suspension
- Electric power rack-and-pinion steering; hydraulic on GT, GXP

Exterior

- Intermittent front windshield wipers with flat blades
- Power rearview mirrors
- Touring tires
- Wheelcovers (Sedan); aluminum wheels (Coupe, Convertible)

SELECTED OPTIONAL FEATURES

- StabiliTrak[®] stability enhancement system
- Leather seating surfaces, heated
- 6-way power driver seat
- Power adjustable pedals
- Cruise control
- Remote Keyless Entry
- Remote Vehicle Starter System
- Audio: 6-disc CD changer, XM Satellite Radio,³ Monsoon premium system, steering wheel-mounted controls
- 3.9L V6 engine
- 17- and 18-inch aluminum wheels
- Power sunroof

OVERVIEW

Pontiac G6, with a fun and spirited driving experience, offers fleet customers a full range of coupes, sedans and convertibles. Many safety features were added as standard equipment for 2008.

NEW FOR 2008

- GXP models (were GTP models in 2007)
- 6 air bags¹ standard on Sedan and Coupe
- Front and side-impact air bags¹ standard on Convertible
- OnStar² 1-year Safe & Sound Plan standard
- 4-wheel antilock brake system with full-function traction control standard

MODEL AVAILABILITY

	Coupe	Sedan	Convertible
G6 Value Leader	-	2ZF69	-
G6	-	2ZG69	-
G6 GT	2ZH37	2ZH69	2ZH67
G6 GXP	2ZM37	2ZM69	-

SPECIFICATIONS (inches unless otherwise stated)

Wheelbase	112.3	112.3	112.3
Length	189.1	189.0	189.1
Width	70.4	70.6	70.6
Height	56.4	57.1	56.7
Seating f/r	2/2	2/3	2/2
Head room f/r	38.9/36.3	39.0/36.5	38.4/36.1
Shoulder room f/r	54.2/51.1	55.4/55.4	54.0/44.8
Leg room f/r	42.2/35.8	42.2/37.6	42.2/34.2
Max. cargo vol. ⁴ (cubic feet)	12.0	14.0	12.6
Fuel capacity ⁵ (gallons)	16	16	16

AVAILABLE EXTERIOR COLORS¹⁵

- 13U Cranberry Metallic (new)
- 15U Sedona Beige Metallic
- 37U Midnight Blue Metallic (new)
- 38U Emerald Green Metallic
- 40U Ivory White
- 41U Black
- 58U Carbon Black Metallic (available Jan. 08)
- 67U Liquid Silver Metallic
- 75U Dark Steel Gray Metallic (new)
- 78U Blue-Gold Crystal Metallic
- 98U White Diamond Tricoat[®] (new)



SELECTED STANDARD FEATURES

Safety and Security

- Dual-stage front air bags with Passenger Sensing System¹
- 3-point safety belts, all positions
- LATCH (Lower Anchors and Top tethers for CHILDREN) system
- OnStar 1-year Safe & Sound Plan² (fleet delete available)
- PASS-Key III and content theft-deterrent system
- Daytime Running Lamps and automatic lamp control
- Tire Pressure Monitoring System⁹

Interior

- Front bucket seats with 6-way power driver seat
- 60/40 split-folding rear seat
- Floor console with armrest, storage
- Air conditioning
- Cruise control
- Programmable power door locks
- Full instrumentation, including tachometer
- Driver Information Center; add trip computer on GXP
- Remote Keyless Entry
- Tilt adjustable steering column

- Visors with vanity mirrors, illuminated on GXP
- Power windows
- AM/FM stereo with CD
- Rear-window defogger

Mechanical

- Front-wheel drive
- 3.8L Series III V6 with 200 hp (Grand Prix)
- 4-speed automatic transmission
- Power 4-wheel disc brakes with Electronic Brakeforce Distribution
- 4-wheel independent suspension
- Power rack-and-pinion steering; Magnasteer II on GXP
- Stainless steel exhaust system

Exterior

- Intermittent front windshield wipers
- Wide-opening rear doors
- Rear spoiler
- P225/60R16 touring tires
- Aluminum wheels

SELECTED OPTIONAL FEATURES

- Head curtain side-impact air bags¹
- Antilock brake system
- Seat options: power driver lumbar, flat-folding front passenger seat, heated seats
- Remote Vehicle Starter System
- Power sunroof
- Audio options: 6-disc CD changer, MP3, XM Satellite Radio,³ Monsoon system, navigation system¹¹, steering wheel-mounted controls
- Traction control
- Fog lamps

OVERVIEW

It provides the performance of a sports sedan along with big car roominess. The Grand Prix interior reflects an attention to detail and flexibility to handle any fleet customer needs.

SELECTED STANDARD FEATURES GXP ONLY

- 5.3L V8 with 303 hp and Active Fuel ManagementTM
- StabiliTrak[®] Sport stability enhancement system
- TAPshift transmission controls
- Head-Up Display (HUD)

MODEL AVAILABILITY

	Sedan
Grand Prix	2WP69
Grand Prix GXP	2WC69

SPECIFICATIONS (inches unless otherwise stated)

Wheelbase	110.5
Length	198.3
Width	71.6
Height	55.9
Seating f/r	2/3
Head room f/r	38.8/36.2
Shoulder room f/r	58.0/54.8
Leg room f/r	42.2/36.2
Max. cargo vol. ⁴ (cubic feet)	57.0 (rear and front seat down)
Fuel capacity ⁸ (gallons)	17



AVAILABLE EXTERIOR COLORS¹⁵





Pre-production show car, shown with optional equipment

OVERVIEW

The G8 is the first North American application of GM's new global rear-wheel-drive architecture developed by Holden, GM's Australian subsidiary. It has progressive styling highlighted by strong Pontiac design cues, such as a dual-port grille, fog lamps, bold wheels and a confident, wheels-at-the-corners stance.

MODEL AVAILABILITY

	Sedan
G8 V6	2EC69
G8 GT V8	2ER69

SPECIFICATIONS (inches unless otherwise stated)

Wheelbase	114.8
Length	196.1
Width	74.8
Height	57.7
Seating (max.)	2/3
Head room f/r	38.7/38.0
Shoulder room f/r	59.1/59.1
Leg room f/r	42.2/39.4
Max. cargo vol. ⁴ (cubic feet)	17.5
Fuel capacity ⁸ (gallons)	19



Pre-production show car, shown with optional equipment

With the availability of V8 power, the G8 represents another step in Pontiac's commitment to its performance DNA.





Pre-production show car,
shown with optional equipment



Pre-production show car,
shown with optional equipment

SELECTED STANDARD FEATURES

Safety and Security

- Dual-stage front and side-impact air bags with Passenger Sensing System¹
- Head curtain side-impact air bags¹
- OnStar 1-year Safe & Sound Plan²
- StabiliTrak[®] stability enhancement system
- Daytime Running Lamps and automatic lamp control

Interior

- Highly bolstered front bucket seats with power adjustment
- Driver Information Center
- AM/FM stereo with CD, XM Satellite Radio³
- Remote Keyless Entry
- Programmable power door locks

Mechanical

- Rear-wheel drive
- 3.6L VVT V6 with 261 hp
- True dual exhausts with chrome outlets
- 5-speed automatic transmission with manual mode
- 4-wheel disc antilock brake system with vented rotors and brake assist
- Full-function traction control
- Independent front and rear suspension
- Trunk-mounted battery
- Variable-ratio power steering

Exterior

- Intermittent front windshield wipers
- Projector beam headlamps
- Fog lamps
- 18-inch aluminum wheels

SELECTED OPTIONAL FEATURES

- Seating options: leather seating surfaces, heated seats, two-tone inserts
- Dual-zone electronic climate control
- Audio options: 230-watt system with color display
- 6.0L V8 with 362 hp with Active Fuel Management[™]
- 6-speed automatic transmission with manual mode
- Limited slip differential (standard on GT; not available on Base V6)
- 19-inch aluminum wheels (optional on GT only)

Superb near-50/50 front-to-rear weight balance, steering precision and a refined chassis contribute to the G8's great vehicle handling performance.

AVAILABLE EXTERIOR COLORS¹⁵





Shown with optional equipment

OVERVIEW

The Saturn AURA is a European-influenced midsize sedan with a highly refined interior. StabiliTrak® is standard on all models and AURA is now available in a Green Line Hybrid version.

NEW FOR 2008

- Green Line Hybrid model
- Auto-dimming outside rearview mirror available
- StabiliTrak® stability enhancement system standard on all models (except XE I-4)
- 2.4L EcoTec 4-cylinder engine standard on XE and Green Line

MODEL AVAILABILITY

	Sedan
AURA XE	ZZS69
AURA XR	ZZV69
AURA Green Line	ZZR69

SPECIFICATIONS (inches unless otherwise stated)

Wheelbase	112.3
Length	190.9
Width	70.3
Height	57.6
Seating	2/3
Head room f/r	39.4/37.4
Shoulder room f/r	55.9/54.0
Leg room f/r	42.2/37.6
Max. cargo vol. ⁴ (cubic feet)	14.9 (13.1 Green Line)
Fuel capacity ⁸ (gallons)	16

AURA's refined interior includes premium materials with low-gloss appearance and tight tolerances throughout.

The gauge cluster uses LED-lit analog instruments, with amber lighting.





AURA GREEN LINE

SELECTED STANDARD FEATURES

Safety and Security

- Dual-stage front and side-impact air bags with Passenger Sensing System¹
- Head curtain side-impact air bags¹
- LATCH system for child safety seats
- Rear door child security locks
- OnStar 1-year Safe & Sound Plan²
- PASS-Key III+ theft-deterrent system
- Daytime Running Lamps and automatic lamp control
- Tire Pressure Monitoring System⁹
- StabiliTrak[®] stability enhancement system (XE V6, XR, Green Line)
- Traction control
- 5-Star front and side crash ratings

Interior

- Bucket seats, driver power height adjuster and manual lumbar control
- Rear 60/40 split-folding seats
- Console with sliding armrest, power outlets, storage
- Driver Information Center
- Green Line instrumentation includes Charge/Assist gauge, Eco light, Autostop indicator

Mechanical

- Air conditioning
- Cruise control
- AM/FM stereo with CD/MP3
- XM Satellite Radio³
- Remote Keyless Entry
- Front-wheel drive
- 2.4L 4-cylinder with 164 hp (XE, Green Line)
- 3.6L VVT V6 DOHC with 252 hp (XR)
- Hybrid Propulsion Equipment (Green Line)
- 4-speed automatic transmission (XE, Green Line)
- 6-speed automatic transmission with TAPshift manual shift control (standard XR; not available XE)
- 4-wheel disc antilock brake system
- Independent front and rear suspension
- Variable-effort power steering

Exterior

- Intermittent front windshield wipers
- Touring tires
- Folding, power outside rearview mirror

SELECTED OPTIONAL FEATURES

- Seating options: 8-way power, leather seating surfaces, heated seats (XE V6, XR)
- Universal Home Remote (XE, XR)
- Power adjustable pedals (XE V6, XR)
- OnStar 3- and 4 additional years of Safe & Sound Plan
- Audio options: 6-disc CD changer, rear audio, Saturn Advanced Audio System, steering wheel controls (XE, XR)
- 3.5L VVT V6 with 219 hp (XE)
- Power sunroof
- 17-inch alloy wheels (XE)
- 18-inch aluminum wheels (standard XR; not available XE)
- Remote Vehicle Starter System (XE, XR)



The AURA Green Line uses GM's Hybrid system. The Ecotec 4-cylinder engine works with the sophisticated electric motor/generator to shut off the engine at stops, restart the engine when the brake pedal is released, charge the advanced nickel metal hydride battery through regenerative braking, and perform intelligent battery charging when it is most efficient.

AVAILABLE EXTERIOR COLORS¹⁵

15U Golden Cashmere	75U Techno Gray
37U Deep Blue (new)	78U Ocean Mist
40U Cream White	80U Red Jewel Tintcoat ¹⁰ (new)
53U Bronzed Pewter	
58U Carbon Flash ¹⁰ (new)	
67U Silver Pearl	

SELECTED STANDARD FEATURES
Safety and Security

- Dual-stage front air bags, side-impact thorax air bags and head curtain side-impact air bags¹
- 3-point safety belts, all positions
- Rear child security door locks
- OnStar 1-year Directions & Connections Plan² with advanced automatic crash notification and Turn-by-Turn Navigation² (fleet delete available)
- PASS-Key III theft-deterrent system
- Tire Pressure Monitoring System⁹
- Daytime Running Lamps and Twilight Sentinel⁹

Interior

- QuietTuning
- Front bucket seats with center storage/armrest
- 5-passenger or available 6-passenger seating
- Air conditioning with filtration
- Cruise control
- Programmable power door locks
- Driver Information Center
- Remote Keyless Entry

- Tilt adjustable steering column
- AM/FM stereo with CD/MP3, XM Satellite Radio,³ 6 speakers and auxiliary input jack

Mechanical

- Front-wheel drive
- 3.8L Series III V6 with 197 hp (CX, CXL)
- 4.6L DOHC V8 with 275 hp (CXS)
- 4-speed automatic transmission
- Power 4-wheel disc antilock brake system with Dynamic Rear Proportioning and full-function traction control
- 4-wheel independent suspension with automatic level control
- Power rack-and-pinion steering

Exterior

- Front fender portholes
- Intermittent front windshield wipers with flat blades
- Laminated front and rear side door glass
- Foldaway power rearview mirrors
- Aluminum wheels

SELECTED OPTIONAL FEATURES

- 4-channel StabiliTrak[®] stability enhancement system with Brake Assist
- Seats: 8-way power front seats with 4-way lumbar, heated front outboard seats, memory, 6-passenger split-bench seat with fold-down inboard armrest, leather seating surfaces, heated and cooled front seats
- Option Packages: Driver Confidence, Comfort & Convenience, and Luxury
- Dual-zone climate control
- Heated steering wheel
- Audio: MP3, 6-disc CD changer, harman/kardon premium audio system, navigation system¹¹
- Magnetic Ride Control and Magnasteer variable-assist power steering (standard CXS)
- Lane Departure Warning
- Side Blind Zone Alert
- Rainsense[™] wipers
- Heated washer fluid
- Ultrasonic Rear Parking Assist
- Remote Vehicle Starter System
- 17- and 18-inch aluminum wheels

OVERVIEW

Buick Lucerne is so well-equipped, very few choices are needed. Just pick a model – CX, CXL or CXS – then pick the V6 or V8 engine, and finally, choose an option package – Driver Confidence, Comfort & Convenience, or Luxury. New available safety features for 2008 include Lane Departure Warning and Side Blind Zone Alert options.

NEW FOR 2008

- Lane Departure Warning and Side Blind Zone Alert available
- Heated wood steering wheel and wood shift knob available
- Unique grilles for each model
- XM Satellite Radio³ standard
- StabiliTrak[®] available on V6 models
- Power tilt/telescoping adjustable steering column on CXS

MODEL AVAILABILITY

	Sedan
Lucerne CX	4HP69
Lucerne CXL	4HD69
Lucerne CXS	4HE69

SPECIFICATIONS (inches unless otherwise stated)

Wheelbase	115.6
Length	203.2
Width	73.8
Height	58.0
Seating f/r (max.)	3/3
Head room f/r	39.5/37.7
Shoulder room f/r	58.0/57.0
Leg room f/r	42.5/41.4
Max. cargo vol. ⁴ (cubic feet)	17.0
Fuel capacity ⁸ (gallons)	18

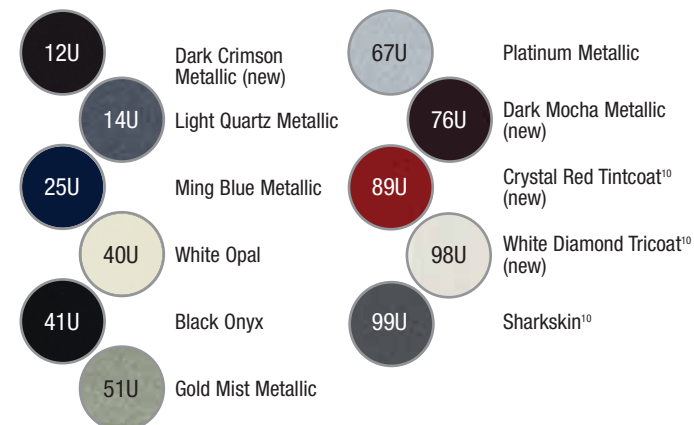
AVAILABLE EXTERIOR COLORS¹⁵



Shown with optional equipment

OVERVIEW

Aggressive and elegant, expressive and sophisticated, the all-new Cadillac CTS exudes a dramatic design presence. Added performance comes from the two-inch-wider track than previous model and optional all-wheel-drive configuration.

MODEL AVAILABILITY

	Sedan
CTS 1SA	6DM69
CTS 1SB	6DP69

SPECIFICATIONS (inches unless otherwise stated)

Wheelbase	113.4
Length	191.6
Width	70.6
Height	56.7
Seating	2/3
Head room f/r	38.9/36.9
Shoulder room f/r	56.6/56.2
Leg room f/r	42.4/36.2
Max. cargo vol. ⁴ (cubic feet)	12.5
Fuel capacity ⁸ (gallons)	17

Side air extractors located forward of the front doors are a modern homage to Cadillac's grand heritage. Additional bright details include three-inch chromed exhaust outlets.





Shown with optional equipment



SELECTED STANDARD FEATURES

Safety and Security

- Dual-stage front and side-impact air bags with Passenger Sensing System¹
- Head curtain side-impact air bags¹
- Rear door child security locks
- OnStar 1-year Directions & Connections Plan² with Turn-by-Turn Navigation²
- PASS-Key III theft-deterrent system
- Daytime Running Lamps and Twilight Sentinel[®]
- StabiliTrak[®] stability enhancement system
- Tire Pressure Monitoring System⁹

Interior

- Front bucket seats with driver 8-way power adjustment
- Rear seat center armrest pass-through
- Dual-zone automatic climate control
- Cruise control
- Remote Keyless Entry
- Auto-dimming rearview mirror

- Tilt/telescoping adjustable steering column
- AM/FM stereo with CD/MP3, XM Satellite Radio,³ steering wheel controls, Bose speaker system
- Programmable power door locks

Mechanical

- Rear-wheel drive
- 3.6L VVT V6 with 258 hp
- 6-speed automatic transmission
- 4-wheel disc antilock brake system
- Full-function traction control
- Independent front and rear suspension
- Power rack-and-pinion steering
- Stainless steel exhaust system

Exterior

- Intermittent front windshield wipers
- Halogen headlamps with wiper activation
- Folding, heated power rearview mirrors
- P235/55R17 H-rated all-season tires
- 17-inch painted aluminum wheels

SELECTED OPTIONAL FEATURES

- All-wheel drive
- Seating options: 10-way power driver seat with power lumbar, rear split folding seats, heated seats, heated/ventilated seats, memory
- Universal Home Remote
- Ambient interior LED lighting
- Wood trim package
- Audio options: 6-disc CD changer, touch-screen navigation, hard drive, 5.1 Surround Sound
- 3.6L VVT SIDI V6 with 300 hp
- 6-speed manual transmission
- Performance Braking System
- Sport Suspension
- Performance Handling Suspension
- Limited slip differential
- Passive Entry System with Remote Vehicle Starter System
- Double-sized power sunroof with power sunshade
- High Intensity Discharge (HID) headlamps with Adaptive Forward Lighting
- 17- and 18-inch aluminum wheels

At the rear, where many sedans are ordinary, Cadillac designers injected charisma. The vertical taillamps are a Cadillac trademark. The roofline and rear backlight have a coupe-like profile. At the centerline, the decklid carries the angular and directional theme of the front.

AVAILABLE EXTERIOR COLORS¹⁵

12U	Black Cherry (new)	67U	Light Platinum
25U	Blue Chip	78U	Sunset Blue
30U	Thunder Gray ¹⁰	89U	Crystal Red Tintcoat ¹⁰ (new)
41U	Black Raven	98U	White Diamond Tricoat ¹⁰
51U	Gold Mist Metallic		
53U	Radiant Bronze		



SELECTED STANDARD FEATURES

Safety and Security

- Dual-stage front air bags, side-impact thorax air bags and head curtain side-impact air bags¹
- 3-point safety belts
- Rear child security door locks
- OnStar 1-year Directions & Connections Plan² with Turn-by-Turn Navigation²
- PASS-Key III+ theft-deterrent system
- Tire Pressure Monitoring System⁹
- Daytime Running Lamps and Twilight Sentinel[®]
- StabiliTrak[®] stability enhancement system with Brake Assist

Interior

- Front bucket seats with center console, leather seating surfaces, heated, 8-way power, power lumbar control
- Dual-zone automatic climate control, air filtration system
- Programmable power door locks
- Driver Information Center
- Remote Keyless Entry

- Adaptive Remote Starter System
- Electrochromic inside rearview mirror with compass
- Tilt adjustable steering column
- AM/FM stereo with CD/MP3, RDS, XM Satellite Radio,³ 8 speakers

Mechanical

- Front-wheel drive
- 4.6L V8 Northstar with 275 hp
- 4-speed automatic transmission
- Power 4-wheel disc antilock brake system
- 4-wheel independent suspension with automatic level control
- Full-function traction control
- Magnasteer variable-assist, power rack-and-pinion steering

Exterior

- Xenon high-intensity discharge headlamps
- Fog and cornering lamps
- Power heated rearview mirrors with turn signals
- P255/55R17 S-rated tires
- Aluminum wheels

SELECTED OPTIONAL FEATURES

- Lane Departure Warning
- Side Blind Zone Alert
- 40/20/40 split-bench seats with column shift and fold-down inboard armrest
- Heated rear outward seats, heated and cooled front seats
- Massaging seats
- Memory Package includes seats, mirrors, steering wheel
- Heated steering wheel
- Adaptive Cruise Control
- Power rear window sunshade
- Universal Home Remote
- Audio options: 6-disc CD changer, Advanced Navigation System, Bose premium speaker system
- 4.6L DOHC V8 Northstar with 292 hp
- Magnetic Ride Control
- Performance Algorithm Shifting
- Front and rear Ultrasonic Parking Assist
- IntelliBeam automatic low/high beam headlamps
- Heated windshield washer fluid
- Rainsense[™] windshield wipers
- Power sunroof

OVERVIEW

Cadillac DTS is a front-wheel-drive luxury sedan with distinctive upscale features and outstanding performance. Professional vehicles are available in Funeral Coach, Coachbuilder Limousine and Livery Package.

NEW FOR 2008

- StabiliTrak[®] stability enhancement system standard
- Lane Departure Warning available
- Side Blind Zone Alert available

MODEL AVAILABILITY

	Sedan
DTS	6KD69
DTS Funeral Coach	6KH69
DTS Coachbuilder Limousine	6KJ69
DTS Livery Package	6KD69

SPECIFICATIONS (inches unless otherwise stated)

Wheelbase	115.6
Length	207.6
Width	74.8
Height	57.6
Seating f/r (maximum)	3/3
Head room f/r	39.2/38.6
Shoulder room f/r	60.0/59.2
Leg room f/r	42.5/41.6
Max. cargo vol. ⁴ (cubic feet)	18.8
Fuel capacity ⁸ (gallons)	18



AVAILABLE EXTERIOR COLORS¹⁵

12U Black Cherry (new)	54U Cognac Frost Tricoat ¹⁰
14U Mystic Gray	67U Light Platinum
25U Blue Chip	76U Double Espresso (new)
40U Cotillion White (Professional vehicles only)	89U Crystal Red Tintcoat ¹⁰ (new)
51U Black Raven	98U White Diamond Tricoat ¹⁰ (new)
54U Gold Mist	99U Titanium ChromaFlair ¹⁰



SELECTED STANDARD FEATURES

Safety and Security

- Dual-stage frontal, side-impact thorax and head curtain side-impact air bags with Passenger Sensing System¹
- 3-point safety belts, all positions
- LATCH (Lower Anchors and Top tethers for Children) system
- Child security rear door locks
- OnStar 1-year Directions & Connections Plan² with Turn-by-Turn Navigation²
- StabiliTrak[®] stability enhancement system
- PASS-Key III theft-deterrent system
- Daytime Running Lamps and Twilight Sentinel[®]
- Tire Pressure Monitoring System[®]

Interior

- Front bucket seats with 8-way power, leather seating surfaces
- Floor console with armrest, storage
- Keyless ignition
- Dual-zone automatic climate control
- Full instrumentation including Driver Information Center

- Programmable power door locks
- Electrochromic rearview mirror with compass
- Steering wheel-mounted controls
- Power tilt/telescoping adjustable steering column
- AM/FM stereo with CD, XM Satellite Radio³ and Bose system

Mechanical

- Rear- or all-wheel drive
- 3.6L VVT V6 with 298 hp and Direct Injection (V6)
- 6-speed automatic transmission with Driver Shift Control
- Power 4-wheel disc antilock brake system with Brake Assist
- 4-wheel independent suspension
- Full-function traction control
- Power, speed-sensitive steering

Exterior

- Adaptive Remote Vehicle Starter System and Keyless Access
- P235/50R17 V-rated all-season tires
- 17-inch aluminum wheels
- Ultrasonic Rear Parking Assist

SELECTED OPTIONAL FEATURES

- Adaptive Cruise Control with Head-Up Display
- Seat options: heated front and rear, heated and ventilated front, Tuscany all-leather seats
- Memory Package
- Universal Home Remote
- Audio: 6-disc CD changer, navigation,¹¹ Bose 5.1 Studio Surround System, Bluetooth phone interface
- 4.6L Northstar VVT V8 with 320 hp (V8)
- 4.4L Northstar Supercharged V8 with 469 hp (STS-V)
- Automatic level control
- Active steering with enhanced StabiliTrak[®]
- Magnetic Ride Control
- Limited slip differential
- IntelliBeam automatic low/high beam control headlamps
- Xenon headlamps with washers
- 17-, 18- or 19-inch aluminum wheels
- Rainsense[™] wipers
- Power sunroof
- Lane Departure Warning
- Side Blind Zone Alert

OVERVIEW

The new 2008 Cadillac STS performance sedan delivers precise handling and plenty of performance. For driving enthusiasts, the STS-V features a supercharged V8 engine. Like the performance under foot, the STS technologies also stir the senses.

NEW FOR 2008

- New exterior styling with faceted grille and fender air extractors
- New interior styling featuring deep chrome gauges and Sapele wood trim
- Driver Awareness Package includes Lane Departure Warning and Side Blind Zone Alert
- 3.6L V6 Direct Injection engine
- 6-speed automatic transmission standard
- Active steering with enhanced StabiliTrak[®] 3.0 Active Front Steer available

MODEL AVAILABILITY

	Sedan
STS V6 RWD/AWD	6DW29
STS V8 RWD/AWD	6DC29
STS-V RWD	6DX29

SPECIFICATIONS (inches unless otherwise stated)

Wheelbase	116.4
Length	196.7
Width	72.6
Height	57.6
Seating f/r	2/3
Head room f/r	38.7/37.9
Shoulder room f/r	58.6/57.4
Leg room f/r	42.6/38.3
Max. cargo vol. ⁴ (cubic feet)	13.8
Fuel capacity ⁸ (gallons)	17



AVAILABLE EXTERIOR COLORS¹⁵

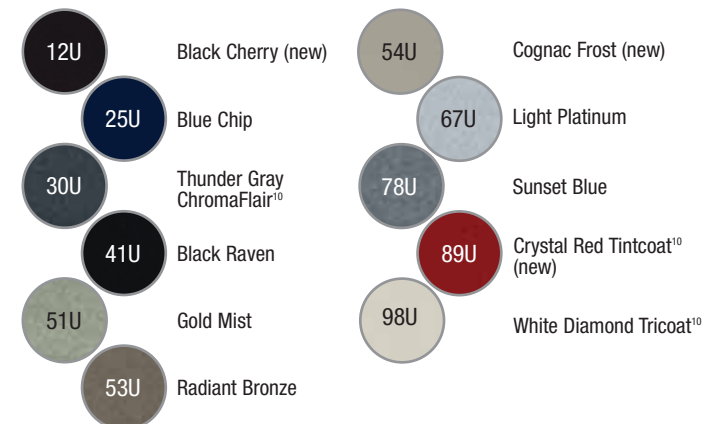



OVERVIEW

The new Saab 9-3 features bold, more assertive looks, reflecting powertrain improvements that include the introduction of all-wheel drive and a more powerful V6 turbo engine. The distinctive all-new front styling and revised rear styling are designed to reinforce the 9-3's sporty appeal.

MODEL AVAILABILITY

	Sport Sedan	SportCombi	Convertible
9-3 2.0T	FCB69	FCB35	FCB67
9-3 Aero	FCH69	FCH35	FCH67

SPECIFICATIONS (in. unless otherwise stated)

Wheelbase	105.3	105.3	105.3
Length	182.9	183.9	182.9
Width	70.9	70.9	70.1
Height	57.9	60.7	56.6
Seating (max.)	2/3	2/3	2/2
Head room f/r	38.9/37.0	38.9/37.0	38.1/37.0
Shoulder room f/r	56.3/55.1	56.3/55.1	55.9/44.7
Leg room f/r	42.3/35.1	42.3/35.1	41.4/32.3
Max. cargo vol. ⁴ (cu. ft.)	15.0	72.3	12.4
Fuel capacity ⁸ (gal.)	16	16	16



The Saab 9-3 is available in 3 models: the Sport Sedan, the versatile SportCombi with more cargo space and the open-air Convertible.

The 9-3 retains its signature ignition key switch on the console, rearward of the shifter, designed for ease of operation and safety.





An active all-wheel-drive system (Saab XWD) will be offered on Sport Sedan and SportCombi with an updated 280-horsepower V6. The system includes 2 innovative features: preemptive engagement of the rear wheels to optimize traction at takeoff and an available electronic limited-slip differential (eLSD) allowing variable torque transfer between rear wheels. The system is fully automatic, with no driver input required.

SELECTED STANDARD FEATURES

Safety and Security

- Dual-stage front air bags¹ with Passenger Sensing System
- Head curtain side-impact (Sport Sedan and SportCombi) or side-impact (Convertible) air bags¹
- Active head restraints, front seats
- Rear door child security locks (NA Convertible)
- OnStar 1-year Safe & Sound Plan²
- Electronic Stability Program (ESP)
- Content theft-deterrent system with engine immobilizer
- Daytime Running Lamps and automatic lamp control
- Tire Pressure Monitoring System⁹

Interior

- Front leather-appointed bucket seats with driver 8-way power adjustment
- Rear 60/40 split-folding seat with armrest and dual cupholders (NA Convertible)
- Driver Information Center includes outside temperature display
- Dual-zone automatic climate control with a cabin air filter

- Cruise control
- Power windows
- Tilt/telescoping adjustable steering column
- AM/FM stereo with CD, auxiliary input jack, steering wheel controls, XM Satellite Radio³
- Remote Keyless Entry

Mechanical

- Front-wheel drive
- 2.0L turbocharged 4-cylinder engine with 210 horsepower (2.0T)
- 2.8L turbocharged V6 engine with 255 horsepower (Aero)
- 6-speed manual transmission
- 4-wheel disc antilock brake system
- Independent front and rear suspension
- Power rack-and-pinion steering

Exterior

- Intermittent rain sensing front windshield wipers
- Rear fog lamp
- P215/55HR16 all-season tires
- 14-spoke alloy wheels

SELECTED OPTIONAL FEATURES

- Seating options: 8-way power passenger seat, premium natural leather surfaces, 3-position memory, heated front seats
- Audio options: 6-disc CD changer, touchscreen navigation,¹¹ Bose Centerpoint Surround Sound system (available 4th quarter 2007), 300-watt/10 speaker system
- Universal Home Remote
- All-wheel-drive system (available 2nd quarter 2008)
- 5- or 6-speed automatic transmission
- Power slide/tilt moonroof
- Xenon cornering headlamps (standard on Aero)
- Front fog lamps
- High pressure headlamp washers
- 17-in. 5-spoke alloy wheels
- Ultrasonic Rear Parking Assist

AVAILABLE EXTERIOR COLORS¹⁵

02V	Pepper Green Metallic ¹⁰	3YU	Titan Gray Metallic ¹⁰
05U	Snow Silver Metallic ¹⁰	4VU	Laser Red
10U	Parchment Silver Metallic ¹⁰	50U	Fusion Blue Metallic ¹⁰
1QU	Smoke Beige Metallic ¹⁰	5MU	Jet Black Metallic ¹⁰
1XU	Nocturne Blue Metallic ¹⁰	5PU	Polar White
2QU	Black	5TU	Ice Blue Metallic ¹⁰



SELECTED STANDARD FEATURES

Safety and Security

- Dual-stage front air bags with passenger sensing system¹
- Side-impact air bags¹
- LATCH (Lower Anchors and Top tethers for Children) system
- Theft-deterrent system with engine immobilizer
- Daytime Running Lamps
- Electronic Stability Program (ESP) with traction control
- OnStar 1-year Safe & Sound Plan²

Interior

- Front leather-appointed heated bucket seats with power adjustments, driver memory
- Split-folding heated rear seat
- Floor console with armrest
- Dual-zone automatic climate control with air filtration system
- Driver Information Center with outside temperature display
- Tilt/telescoping adjustable steering column
- Cruise control
- Universal Home Remote

Remote Keyless Entry

- AM/FM stereo with 6-disc CD changer, XM Satellite Radio³ and Harman/Kardon speaker system

Mechanical

- Front-wheel drive
- 2.3L DOHC Turbocharged 4-cylinder engine with 260 hp
- 5-speed Sentronic automatic transmission with manual shift mode
- 4-wheel disc antilock brake system with Electronic Brake-Force Distribution
- Power rack-and-pinion steering
- 4-wheel independent suspension
- Lowered, sport-tuned chassis (Aero)

Exterior

- Intermittent rain sensing front windshield wipers
- Front integral fog lamps and single rear fog lamp
- P235/45VR17 all-season tires
- Twin 5-spoke alloy wheels
- Power moonroof

SELECTED OPTIONAL FEATURES

- Ultrasonic Rear Parking Assist
- Seating options: driver and passenger ventilated seats, semi-Aniline leather surfaces, • Navigation¹¹ radio
- 5-speed manual transmission
- Xenon headlamps with auto-leveling feature

OVERVIEW

The Saab 9-5 offers excellent performance and value in the performance-oriented midsize luxury category. It is available in Sedan and versatile SportCombi models, and 2.3T and Aero levels.

NEW FOR 2008

- Aero model adds 17-inch 5-spoke high-split alloy wheels
- Premium Natural leather upholstery is available
- Rain sensing windshield wipers are standard
- Power folding outside mirrors have been added to the Visibility Package

MODEL AVAILABILITY

	Sedan	SportCombi
9-5 2.3T	FDD69	FDH69
9-5 Aero	FDD35	FDH35

SPECIFICATIONS (in. unless otherwise stated)

Wheelbase	106.4	106.4
Length	190.4	190.6
Width	70.5	70.5
Height	57.2	57.7
Seating f/r	2/3	2/3
Head room f/r	37.1/37.0	38.7/38.2
Shoulder room f/r	56.9/56.5	56.9/56.5
Leg room f/r	42.4/36.6	42.4/36.6
Max. cargo vol. ⁴ (cu. ft.)	15.9	73.0
Fuel capacity ⁸ (gal.)	18	18



AVAILABLE EXTERIOR COLORS¹⁵

- 02V Pepper Green Metallic¹⁰
- 05U Snow Silver Metallic¹⁰
- 50U Fusion Blue Metallic¹⁰
- 2QU Black
- 3YU Titan Gray Metallic¹⁰
- 4VU Laser Red
- 5MU Jet Black Metallic¹⁰
- 5PU Polar White
- 5TU Ice Blue Metallic¹⁰



SELECTED STANDARD FEATURES

Safety and Security

- Dual-stage frontal and side-impact thorax air bags with Passenger Sensing System¹
- OnStar 1-year Directions & Connections Plan² with Turn-by-Turn Navigation²
- 4-channel StabiliTrak[®] stability enhancement system
- Tire Pressure Monitoring System⁹
- Daytime Running Lamps and Twilight Sentinel[®]

Interior

- Front bucket seats, 8-way power adjuster, leather seating surfaces, adjustable lumbar support, cooled and heated seats, integrated audio
- Keyless ignition
- Dual-zone automatic climate control, air filtration system
- Head-Up Display
- Driver Information Center
- Power tilt/telescoping adjustable steering column
- AM/FM stereo, 6-disc CD changer, Bose system, navigation system,¹¹ XM Satellite Radio³

- Adaptive Cruise Control
- Universal Home Remote

Mechanical

- Rear-wheel drive
- 4.6L VVT DOHC V8 with 320 hp
- 6-speed automatic transmission with Driver Shift Control
- Power 4-wheel disc antilock brake system
- 4-wheel independent suspension with Magnetic Ride Control
- Full-function traction control
- Magnasteer speed-sensitive steering

Exterior

- Power retractable hardtop
- Steerable adaptive forward lighting system; Xenon High Intensity Discharge headlamps with washers
- Rainsense[™] windshield wipers
- Heated, memory rearview mirrors
- P235/50R18, W-rated extended mobility tires, aluminum wheels
- Power open and close decklid
- Ultrasonic Rear Parking Assist

SELECTED OPTIONAL FEATURES

- Platinum Edition includes chrome-finish grille, unique door sill plates, 18-in. 15-spoke polished aluminum wheels, leather-wrapped interior, Olive Ash wood trim, genuine aluminum accents, Ultra Suede headliner, lower doors and seating surfaces
- Light or Dark Eucalyptus wood accents (no additional charge)
- Olive Ash wood and genuine aluminum trim (Platinum Edition)
- 4.4L supercharged VVT DOHC Northstar V8 with 443 hp (XLR-V)
- P235/45R19 front and P255/40R19 rear W-rated extended mobility tires (XLR-V)
- 18-inch chrome aluminum wheels
- 19-inch platinum wheels

OVERVIEW

Cadillac XLR is a luxury roadster with high performance capabilities. The power retractable hardtop allows for open-air driving, while the Northstar V8 and rear-wheel drive provide dramatic power. An XLR-V is available with a supercharged Northstar V8 delivering 443 horsepower.

NEW FOR 2008

- Heated steering wheel
- New chrome aluminum wheels available
- Platinum Edition now available in all exterior colors

MODEL AVAILABILITY

	Hardtop Convertible
XLR	6YV67
XLR-V	6YX67

SPECIFICATIONS (inches unless otherwise stated)

Wheelbase	105.7
Length	177.7
Width	72.3
Height	50.4
Seating	2
Head room	37.6
Shoulder room	54.3
Leg room	42.6
Max. cargo vol. ⁴ (cubic feet)	11.6
Fuel capacity ⁸ (gallons)	18



Shown with optional equipment

AVAILABLE EXTERIOR COLORS¹⁵

- 11U Goldstream (new) (not available on XLR-V)
- 36U Liquid Amethyst (not available on XLR-V)
- 41U Black Raven
- 67U Light Platinum
- 85U Electra Blue Tintcoat (new)
- 89U Crystal Red Tintcoat (new)

SELECTED STANDARD FEATURES
Safety and Security

- Dual-stage frontal air bags with Passenger Sensing System¹
- OnStar 1-year Safe & Sound Plan²
- Active Handling traction and stability enhancement system
- Tire Pressure Monitoring System⁹
- Daytime Running Lamps and automatic lamp control

Interior

- Front bucket seats, 6-way power adjuster, leather seating surfaces
- Dual-zone automatic climate control, air filtration system
- Keyless access
- Driver Information Center
- Cruise control
- Tilt adjustable steering column
- Power programmable door locks
- AM/FM stereo with CD/MP3 player, XM Satellite Radio³
- Audio input jack
- Wrapped interior trim plate with cyber pattern
- Auto-dimming mirrors with compass

Mechanical

- Rear-wheel drive
- 6.2L V8 engine with 430 hp
- 7.0L 505 hp V8 for Z06
- 6-speed manual transmission
- Power 4-wheel disc antilock brake system
- 4-wheel independent suspension
- Full-function traction control
- Speed-sensitive power rack-and-pinion steering

Exterior

- Xenon High-Intensity Discharge projector headlamps
- Integral fog lamps
- Auto-dimming power heated outside mirrors
- P245/40ZR18 front and P285/35ZR19 rear extended mobility tires
- Aluminum wheels
- Manual folding convertible top (Convertible)
- Removable body-color roof panel (Coupe)

SELECTED OPTIONAL FEATURES

- Side-impact air bags¹
- Head-Up Display
- Memory Package
- Perforated leather seating surfaces, heated seats, power passenger seat
- Power telescoping adjustable steering column
- Universal home remote
- Audio options: 6-disc CD changer, Bose system, navigation,¹¹ steering wheel controls
- 6-speed automatic transmission with paddle controls
- Performance Packages
- Dual-mode performance exhaust
- Magnetic Selective Ride Control
- Power folding convertible top (Convertible)
- Removable transparent roof panel (Coupe)
- Custom leather-wrapped interior
- Forged polished aluminum wheels
- Corvette Museum Delivery

OVERVIEW

Chevrolet Corvette is the American performance icon, a world-class high-performance sports car.

NEW FOR 2008

- All-new LS3 6.2L V8 engine for Coupe and Convertible:
 - 430 hp/424 lb.-ft. of torque (321 kW/575 Nm)
 - 436 hp/428 lb.-ft. (325 kW/580 Nm) with optional dual-mode exhaust
- Improved manual transmission shift effort
- New standard and optional wheels, including polished forged aluminum
- Quicker shift times on paddle-shift 6-speed automatic
- New Keyless Access Remote key fob with integrated key
- iPod/MP3 jack on all sound systems except Navigation
- OnStar 1-year Safe & Sound Plan² and XM Satellite Radio³ standard on all models
- Auto-dimming inside mirror with compass standard on all models
- New premium exterior colors: Jetstream Blue Metallic Tintcoat and Crystal Red Metallic Tintcoat

MODEL AVAILABILITY

	Coupe/Convertible
Corvette Coupe	1YY07
Corvette Convertible	1YY67
Corvette Z06	1YY87

SPECIFICATIONS (inches unless otherwise stated)

Wheelbase	105.7
Length	174.6 (Z06 175.6)
Width	72.6 (Z06 75.9)
Height	49.0 (Convertible 49.1)
Seating	2
Head room	37.9
Shoulder room	55.3
Leg room	43.1
Max. cargo vol. ⁴ (cubic feet)	22.4 (Convertible 11.0)
Fuel capacity ⁸ (gallons)	18

AVAILABLE EXTERIOR COLORS¹⁵



Limited Availability

SELECTED STANDARD FEATURES
Safety and Security

- Frontal air bags¹ with Passenger Sensing System
- OnStar with 1-year Safe & Sound Plan²
- 3-point safety belts
- PASS-Key III+ theft-deterrent system
- Daytime Running Lamps and automatic lamp control
- Tire Pressure Monitoring System⁹

Interior

- Sport bucket seats with manual recline and driver power height adjustment
- Seatback pockets
- Full instrumentation including tachometer and Driver Information Center
- AM/FM stereo with CD player, 6 speakers, auxiliary input jack
- Rake-adjustable steering wheel
- 3 cupholders
- Rear-window defogger
- Heater, outside air with fan
- Premium acoustic headliner

Mechanical

- Rear-wheel drive
- Ecotec 2.4L DOHC VVT 4-cylinder engine with 177 hp
- Turbo Ecotec 2.0L DOHC VVT 4-cylinder engine with 260 hp (GXP)
- 5-speed close-ratio manual transmission
- 4-wheel independent suspension
- Bilstein monotube shock absorbers
- 4-wheel disc brakes
- Power rack-and-pinion steering
- Near 50/50 weight distribution
- Stainless steel exhaust system

Exterior

- 18-inch aluminum wheels
- P245/45R18 all-season tires
- Manual-folding convertible cloth top with rear glass window
- Reverse hinged hood and rear clamshell decklid
- Variable intermittent wet-arm windshield wipers
- Polished exhaust tip(s)

SELECTED OPTIONAL FEATURES

- StabiliTrak[®] stability enhancement system
- Preferred Package with power windows, door locks, mirrors plus Remote Keyless Entry
- Convenience Package with cruise control, steering wheel controls, integrated fog lamps
- Premium Package with leather seating surfaces and leather-wrapped steering wheel with accessory controls
- Audio options: CD/MP3 or CD/MP3 6-disc in-dash changer, Monsoon premium speaker system, XM Satellite Radio³
- Air conditioning
- 5-speed automatic transmission
- 4-wheel antilock brake system
- Limited-slip rear differential
- Chrome or polished aluminum wheels

OVERVIEW

Pontiac Solstice is an exciting two-seat roadster that combines sensual styling with thrilling performance. And for even more excitement, the GXP model delivers 260 horsepower with its turbocharged engine.

NEW FOR 2008

- OnStar 1-year Safe & Sound Plan² standard on all models
- Driver Information Center standard on all models
- Tire Pressure Monitoring System⁹ standard on all models
- Premium acoustic headliner standard on all models
- StabiliTrak[®] stability enhancement system available on Solstice

MODEL AVAILABILITY

	Convertible
Solstice	2MB67
Solstice GXP	2MG67

SPECIFICATIONS (inches unless otherwise stated)

Wheelbase	95.1
Length	157.2
Width	71.3
Height	50.1
Seating	2
Head room	38.5
Shoulder room	52.4
Leg room	42.7
Max. cargo vol. ⁴ (cubic feet)	5.4
Fuel capacity ⁸ (gallons)	13



Shown with optional equipment

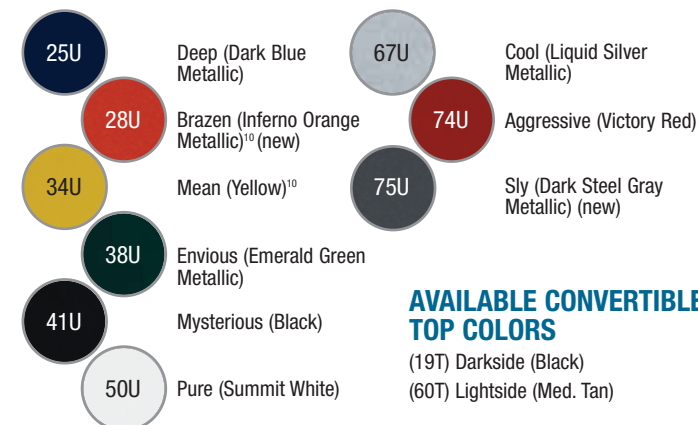

Shown with optional equipment

AVAILABLE EXTERIOR COLORS¹⁵

AVAILABLE CONVERTIBLE TOP COLORS

(19T) Darkside (Black)
(60T) Lightside (Med. Tan)



Limited Availability

SELECTED STANDARD FEATURES
Safety and Security

- Frontal air bags with Passenger Sensing System¹
- 3-point safety belts
- PASS-Key III+ theft-deterrent system
- Daytime Running Lamps, fog lamps, automatic lamp control
- StabiliTrak[®] stability enhancement system and traction control
- Tire Pressure Monitoring System⁹
- OnStar with 1-year Safe & Sound Plan²

Interior

- Bucket seats, manual recline and power driver height adjustment
- Seatback storage
- Full instrumentation with Driver Information Center
- Remote Keyless Entry
- AM/FM stereo with CD/MP3 player, XM Satellite Radio,³ 6 speakers, auxiliary input jack
- Rake-adjustable steering wheel
- Floor console
- Cruise control

- Rear-window defogger
- Power door locks

Mechanical

- Rear-wheel drive
- Ecotec 2.4L DOHC VVT 4-cylinder engine with 177 hp
- Turbo Ecotec 2.0L DOHC VVT 4-cylinder engine with 260 hp and Direct Injection (Red Line)
- 5-speed manual transmission
- 4-wheel independent suspension
- Bilstein shock absorbers
- 4-wheel disc antilock brake system
- Limited-slip rear differential
- Power rack-and-pinion steering

Exterior

- 18-inch aluminum wheels
- P245/45R18 all-season tires
- Manual-folding convertible cloth top with integral fixed glass
- Reverse hinged hood and rear clamshell decklid
- Variable intermittent windshield wipers
- Polished exhaust tip

SELECTED OPTIONAL FEATURES

- Premium Trim Package with leather seat inserts, steering wheel controls, leather-wrapped shift knob, metallic finish sill plates, stainless steel pedal covers
- Audio options: MP3 and 6-disc CD in-dash changer, Monsoon premium speaker system
- 5-speed automatic transmission
- Chrome alloy wheels

OVERVIEW

Saturn SKY is a two-seat convertible roadster with dynamic styling and outstanding performance. The fully equipped SKY is complemented by an even more powerful Red Line model with a turbocharged engine delivering 260 horsepower.

NEW FOR 2008

- StabiliTrak[®] stability enhancement system standard on both models
- Limited slip differential standard on both models
- Leather-wrapped steering wheel standard on both models
- Tire Pressure Monitoring System⁹ standard
- XM Satellite Radio³ standard
- MP3 capable radio standard

MODEL AVAILABILITY

	Convertible
SKY	ZMB67
SKY Red Line	ZMG67

SPECIFICATIONS (inches unless otherwise stated)

Wheelbase	95.1
Length	161.1
Width	71.4
Height	50.2
Seating	2
Head room	38.4
Shoulder room	52.7
Leg room	42.7
Max. cargo vol. ⁴ (cubic feet)	5.4
Fuel capacity ⁸ (gallons)	13



Shown with optional equipment



Shown with optional equipment

AVAILABLE EXTERIOR COLORS¹⁵

AVAILABLE CONVERTIBLE TOP COLORS

(19T) Black
(60T) Tan



Shown with optional equipment

OVERVIEW

The all-new Buick Enclave is a luxury crossover SUV that is designed to be very quiet on the road. Its unique and beautifully crafted exterior is complemented by a luxurious interior that comfortably seats up to 8.

MODEL AVAILABILITY

	Crossover
Enclave FWD	4R14526
Enclave AWD	4V14526

SPECIFICATIONS (inches unless otherwise stated)

Wheelbase	118.9
Length	201.8
Width	79.0
Height	72.2
Seating (max.)	2/3/3
Head room f/m/r	40.4/39.0/37.2
Shoulder room f/m/r	62.0/61.4/57.4
Leg room f/m/r	41.3/36.9/33.2
Max. cargo vol. ⁴ (cubic feet)	116.2
Fuel capacity ⁸ (gallons)	22
Max. towing capacity ⁷ (pounds)	4500
Minimum ground clearance	8.4

Premium technology includes features like the HID Xenon headlamps with available articulation, a backup camera integrated into the available navigation¹¹ screen and standard power liftgate.





Shown with optional equipment



SELECTED STANDARD FEATURES

Safety and Security

- Dual-stage front and side-impact air bags with Passenger Sensing System¹
- Head curtain side-impact air bags¹
- Rear door child security locks
- OnStar 1-year Directions & Connections Plan² with Turn-by-Turn Navigation²
- StabiliTrak[®] stability enhancement system
- PASS-Key III theft-deterrent system
- Daytime Running Lamps and automatic lamp control
- Tire Pressure Monitoring System⁹

Interior

- Buick QuietTuning
- Front reclining bucket seats
- 7-passenger seating with 2nd-row flat-folding Captain's Chairs and 3rd-row 60/40 split-bench seat
- Tri-zone automatic climate control
- Cruise control

- Power windows
- Tilt/telescoping adjustable steering column
- AM/FM stereo with CD/MP3, XM Satellite Radio³
- Remote Keyless Entry
- Programmable power door locks

Mechanical

- Front- or all-wheel drive
- 3.6L VVT V6 with 275 hp
- 6-speed automatic transmission
- 4-wheel disc antilock brake system
- Independent front and rear suspension
- Variable-effort power steering

Exterior

- Intermittent front windshield wipers
- High-intensity discharge Xenon projector headlamps
- Projector fog lamps
- P255/65R18 all-season tires
- Aluminum wheels
- Power liftgate with wiper/washer

SELECTED OPTIONAL FEATURES

- Seating options: 8-passenger seating, 8-way power, leather seating surfaces, heated seats, memory
- Audio options: 6-disc CD changer, DVD player, rear audio, touchscreen navigation system,¹¹ Bose 5.1 surround sound, rear-seat DVD entertainment center
- Trailering Provision Package
- Power sunroof with rear skylight
- Rearview camera
- Heated windshield washer fluid
- 19-inch aluminum wheels
- Remote Vehicle Starter System
- Ultrasonic Rear Parking Assist
- Luxury Package including power folding outside rearview mirrors with turn signals and driver auto-dimming, articulating headlamps, power tilt/telescoping adjustable steering column and 110-volt inverter

GM's exclusive SmartSlide™ second-row seats in the Enclave make it easy to get to and from the third row. With the pull of one lever, the seat automatically folds vertically and pushes forward. This creates an extremely large opening to and from the rear seat.

AVAILABLE EXTERIOR COLORS¹⁵





SELECTED STANDARD FEATURES

Safety and Security

- Dual-stage front air bags with Passenger Sensing System¹
- Head curtain side-impact air bags¹ with rollover sensor
- StabiliTrak[®] stability enhancement system
- OnStar 1-year Directions & Connections Plan² with Turn-by-Turn Navigation²
- Tire Pressure Monitoring System³
- Daytime Running Lamps and Twilight Sentinel[®]

Interior

- Front bucket seats with 14-way power, heated, leather seating surfaces and memory
- Middle row reclining bucket seats, heated
- 50/50 removable 3rd-row seat
- Floor console with rear seat audio and climate controls
- Universal Home Remote
- Auto-dimming mirror, compass and outside temperature
- Driver Information Center
- Tri-zone automatic climate control
- Remote Vehicle Starter System

- Power adjustable pedals
- AM/FM stereo with CD/DVD/MP3, 6-disc CD changer, Bose 5.1 Studio Surround, rear audio controls, XM Satellite Radio,³ steering wheel-mounted controls

Mechanical

- Vortec 6.2L VVT V8 with 403 hp
- 6-speed automatic transmission
- 4-wheel disc antilock brake system
- Automatic rear locking differential
- Automatic level control
- Road-sensing shock absorbers
- Full-function traction control
- Trailering equipment

Exterior

- Xenon HID headlamps
- Rainsense[™] windshield wipers with heated washer fluid
- P265/65R18 all-season tires
- Assist steps
- 18-inch aluminum wheels
- Power folding rearview mirrors with ground illumination, turn signals, curb-tilt, driver auto-dimming
- Luggage rack
- Ultrasonic Rear Parking Assist
- Rear power liftgate with liftglass

SELECTED OPTIONAL FEATURES

- Heated and cooled front seats
- Middle-row 60/40 split-folding seat
- 3rd-row 2-passenger seating
- Heated steering wheel
- Power sunroof
- Touch-screen navigation radio
- Rear-seat DVD entertainment system
- Escalade ESV Platinum Edition
- V8 Ultra Luxury Collection
- IntelliBeam headlamps
- 22-inch aluminum wheels¹⁴
- Rearview camera system
- Power-retractable assist steps
- Livery Package

OVERVIEW

Escalade and the larger Escalade ESV combine power and strength with trademark Cadillac styling and technology. Inside, there is room to seat 8 people comfortably and carry all their cargo⁴ too.

NEW FOR 2008

- V8 Ultra Luxury Collection includes audio system with navigation, rearview camera system, IntelliBeam headlamps, heated and cooled seats, heated steering wheel, power release second-row seat, 22-inch x 9-inch 7-spoke chromed aluminum wheels and power sunroof

MODEL AVAILABILITY

	Escalade	Escalade ESV
Rear-wheel drive	6C10706	-
All-wheel drive	6K10706	6K10906

SPECIFICATIONS (inches unless otherwise stated)

Wheelbase	116.0	130.0
Length	202.5	222.9
Width	79.0	79.1
Height	74.3	75.5
Seating (maximum)	2/3/3	2/3/3
Head room f/m/r	41.1/39.2/37.9	41.1/38.5/38.1
Shoulder room f/m/r	65.3/65.2/61.7	65.3/65.2/64.7
Leg room f/m/r	41.3/39.0/25.6	41.3/39.5/34.9
Max. cargo vol. ⁴ (cubic feet)	108.9	137.4
Fuel capacity ⁸ (gallons)	26	31
Max. towing capacity ⁷ (pounds)	8000	7800



AVAILABLE EXTERIOR COLORS¹⁵





SELECTED STANDARD FEATURES

Safety and Security

- Dual-stage front air bags with Passenger Sensing System¹
- Head curtain side-impact air bags¹ with rollover sensor
- StabiliTrak[®] stability enhancement system
- OnStar 1-year Directions & Connections Plan² with Turn-by-Turn Navigation²
- Tire Pressure Monitoring System⁹
- Daytime Running Lamps and Twilight Sentinel[®]

Interior

- Front bucket seats with 14-way power, heated, leather seating surfaces and memory
- 60/40 split-bench rear seat
- Folding Midgate[®]
- Floor console with rear seat audio controls
- Universal Home Remote
- Auto-dimming mirror, compass and outside temperature
- Driver Information Center
- Dual-zone automatic climate control
- Remote Vehicle Starter System
- Power adjustable pedals

- AM/FM stereo with CD/DVD/MP3, 6-disc CD changer, Bose 5.1 Studio Surround, rear audio controls, XM Satellite Radio,³ steering wheel-mounted controls

Mechanical

- Vortec 6.2L V8 with 403 hp
- 6-speed automatic transmission
- 4-wheel disc antilock brake system
- Automatic rear locking differential
- Road-sensing shock absorbers
- Full-function traction control
- Trailering equipment

Exterior

- Xenon HID headlamps
- Rainsense[™] windshield wipers with heated washer fluid
- P265/65R18 all-season tires
- Assist steps
- 18-inch aluminum wheels
- Utility Enhancement System with Midgate[®]
- Power folding rearview mirrors with ground illumination, turn signals, curb-tilt, driver auto-dimming
- Luggage rack
- Ultrasonic Rear Parking Assist

SELECTED OPTIONAL FEATURES

- Heated and cooled front seats
- Heated steering wheel
- Power sunroof
- Touch-screen navigation radio
- Rear-seat DVD entertainment system
- V8 Ultra Luxury Collection
- IntelliBeam headlamps
- 22-inch aluminum wheels¹⁴
- Rearview camera system
- Power-retractable assist steps

OVERVIEW

Combining the best elements of a luxury SUV and versatile pickup truck, the Escalade EXT is easily recognized as a Cadillac. The Utility Enhancement System includes a Midgate[®] that changes from passenger to cargo capability.

NEW FOR 2008

- V8 Ultra Luxury Collection includes audio system with navigation, rearview camera system, IntelliBeam headlamps, heated and cooled seats, heated steering wheel, 22-inch x 9-inch 7-spoke chromed aluminum wheels¹⁴ and power sunroof

MODEL AVAILABILITY

	Escalade EXT
All-wheel drive	6K10936

SPECIFICATIONS (inches unless otherwise stated)

Wheelbase	130.0
Length	222.0
Width	79.1
Height	74.5
Seating (maximum)	2/3
Head room f/r	41.1/39.2
Shoulder room f/r	65.3/65.2
Leg room f/r	41.3/39.0
Bed length — Midgate up	63.3
— Midgate down	98.2
Max. cargo vol. ⁴ (cubic feet)	60.3
Fuel capacity ⁸ (gallons)	31
Max. towing capacity ⁷ (pounds)	7600



Shown with optional equipment

AVAILABLE EXTERIOR COLORS¹⁵

- 41U Black Raven
- 46U Stealth Gray (new)
- 51U Gold Mist
- 59U Quicksilver
- 66U Sonoma Red (new)
- 98U White Diamond Tintcoat¹⁰



SELECTED STANDARD FEATURES

Safety and Security

- Dual-stage frontal and head curtain side-impact air bags with Passenger Sensing System¹
- Rear door child security locks
- OnStar 1-year Directions & Connections Plan² with Turn-by-Turn Navigation²
- StabiliTrak[®] stability enhancement system
- PASS-Key III+ theft-deterrent systems
- Daytime Running Lamps and Twilight Sentinel[®]
- Tire Pressure Monitoring System[®]

Interior

- Front reclining bucket seats with 8-way driver power, leather seating surfaces
- 2nd-row adjustable 60/40 seat
- Floor console
- Dual-zone automatic climate control
- Cruise control
- Rearview auto-dimming mirror with compass
- Remote Keyless Entry

- Tilt adjustable steering column
- AM/FM stereo with CD, Bose speakers, XM Satellite Radio,³ steering wheel-mounted controls

Mechanical

- Rear- or all-wheel drive
- 3.6L VVT V6 with 255 hp
- 4.6L Northstar V8 with 320 hp
- 5- or 6-speed automatic transmission
- Full-function traction control
- 4-wheel disc antilock brake system
- 4-wheel independent suspension
- Power speed-sensitive steering

Exterior

- Intermittent front and rear wipers/washers
- Power heated rearview mirrors
- P235/65R17 front and P255/60R17 rear H-rated all-season tires (V6)
 - Cast aluminum wheels
 - Roof rails
 - Power rear liftgate
 - Ultrasonic Rear Parking Assist

SELECTED OPTIONAL FEATURES

- Seat options: power lumbar, heated seats, 3rd row power seats
- 2nd row seats delete (fleet only)
- Memory Package
- Heated steering wheel
- Power adjustable pedals
- Rear air conditioning
- Universal Home Remote
- Reconfigurable rear cargo area storage system
- UltraView or UltraView Plus power sunroof
- Audio options: 6-disc CD changer, touch-screen navigation, rear-seat DVD entertainment center
- Theater Package with Bose 5.1 Digital Cabin Surround Sound, rear-seat entertainment, navigation¹¹
- Limited slip differential
- Magnetic Ride Control
- Trailing package
- Xenon high-intensity discharge headlamps
- 18- or 20-inch¹⁴ polished aluminum wheels

OVERVIEW

Cadillac SRX delivers performance and flexibility, with a distinctive package that combines smooth handling with ample cargo-carrying capacity⁴. This creates a crossover vehicle that drives with excellent ride and handling.

NEW FOR 2008

- New standard 17-inch painted cast aluminum wheels
- New steering wheel design

MODEL AVAILABILITY

	Crossover
SRX V6	6EB26
SRX V8	6ED26

SPECIFICATIONS (inches unless otherwise stated)

Wheelbase	116.4
Length	194.9
Width	72.6
Height	67.8
Seating (maximum)	2/3/2
Head room f/m/r	40.3/38.4/35.0
Shoulder room f/m/r	58.7/57.6/43.6
Leg room f/m/r	42.1/41.0/24.2
Max. cargo vol. ⁴ (cubic feet)	69.5
Fuel capacity ⁶ (gallons)	20
Max. towing capacity ⁷ (pounds)	2000



Shown with optional equipment



AVAILABLE EXTERIOR COLORS¹⁵

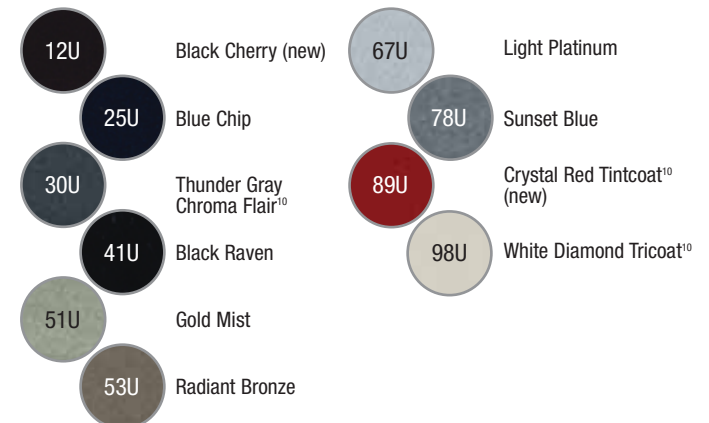



SELECTED STANDARD FEATURES

Safety and Security

- Dual-stage frontal air bags with Passenger Sensing System¹
- Head curtain side-impact air bags¹ with rollover sensor
- Daytime Running Lamps and automatic lamp control
- OnStar 1-year Safe & Sound Plan² (fleet delete available)
- StabiliTrak[®] stability enhancement system with Proactive Roll Avoidance

- Driver Information Center
- Tilt adjustable steering column
- AM/FM stereo with CD/MP3 player and XM Satellite Radio³ (fleet delete available)

Mechanical

- Vortec 5.3L V8 with 320 hp
- 4-speed automatic transmission
- 4-wheel disc antilock brake system
- Autotrac 4-wheel drive

Interior

- 40/20/40 reclining split-bench seat with lockable storage
- 60/40 split-bench flat-folding rear seat
- Dual-zone air conditioning

Exterior

- Stowable Midgate[®] to change from passenger to cargo space⁴
- Cargo cover and lockable top box
- Assist steps
- Aluminum wheels

SELECTED OPTIONAL FEATURES

- Seating options: reclining bucket seats, full-feature bucket seats, leather seating surfaces, heated
- Floor console with storage and rear-seat audio controls
- Automatic climate control
- Universal Home Remote
- Power adjustable pedals
- Power sunroof
- Audio options: 6-disc CD changer, navigation system,¹¹ Bose system, rear audio controls, DVD rear seat entertainment system
- Vortec 6.0L V8 with 366 hp
- FlexFuel capability
- Locking rear differential
- Heavy-duty trailering equipment
- Roof luggage rack
- Outside mirror options: auto-dimming, power folding, curb-tilt, turn signals, ground illumination
- Rearview camera system
- Remote Vehicle Starter System
- Power retractable assist steps
- Ultrasonic Rear Parking Assist
- Heated windshield washer fluid
- Rainsense[™] front windshield wipers

OVERVIEW

Avalanche combines the passenger comfort attributes of a full-size SUV with the cargo capabilities⁴ of a full-size pickup truck. Fleet customers will only find these features, along with outstanding Chevrolet value, with the Avalanche.

NEW FOR 2008

- New standard 40/20/40 front seats include covered storage areas
- Driver seat manual lumbar control standard
- 6-way power front passenger seat available
- New Convenience Packages available
- Head curtain side-impact air bags¹ standard on all models
- XM Satellite Radio³ standard on all models



SPECIFICATIONS

Model	Model Number/Drivetrain	Wheelbase (inches)	GVWR ⁵ (pounds)	Payload ⁶ (pounds)	Maximum Trailer Weight ⁷ (pounds)	Seating	
Avalanche	2WD 1/2-ton	CC10936/RWD	130.0	7000	1258	8200	6
	4WD 1/2-ton	CK10936/4WD	130.0	7200	1337	7800	6

AVAILABLE EXTERIOR COLORS¹⁵





SELECTED STANDARD FEATURES

Safety and Security

- Dual-stage front air bags with Passenger Sensing System¹
- LATCH (Lower Anchors and Top tethers for Children) system
- PASSKey III+ theft-deterrent system
- Rear door child security locks
- Daytime Running Lamps and automatic lamp control
- StabiliTrak[®] stability enhancement system with traction control
- OnStar 1-year Safe & Sound Plan²
- Tire Pressure Monitoring System[®]

Interior

- Front reclining bucket seats with flat-folding passenger seat
- Multi-Flex sliding, reclining rear seat with 60/40 split seatback
- Floor console with armrest and storage
- Air conditioning
- Cruise control
- Power programmable door locks
- Tachometer and Driver Information Center

Remote Keyless Entry

- Tilt adjustable steering column
- Power windows
- AM/FM stereo with CD, digital clock and auxiliary input jack

Mechanical

- Front- or all-wheel drive
- 3.4L V6 with 185 hp (LS, LT, LTZ only)
- 5-speed automatic transmission
- 4-wheel disc antilock brake system
- 4-wheel independent suspension
- Variable-assist electric power steering (LS, LT, LTZ only)

Exterior

- Intermittent front windshield wipers
- Folding, power rearview mirrors
- P235/65R16 all-season tires and aluminum wheels
- Luggage rack side rails (LS, LT, LTZ only)
- Rear liftgate with wiper/washer
- Rear window defogger

SELECTED OPTIONAL FEATURES

- Head curtain side-impact air bags¹ with rollover sensor
- Seat options: 6-way power driver adjustment, manual lumbar adjuster, leather seating surfaces, heated seats, rear seat delete (fleet only)
- Power sunroof
- Audio options: 6-disc CD changer, MP3 player, XM Satellite Radio,³ Pioneer premium speaker system, steering wheel-mounted controls, navigation system,¹¹ DVD rear seat entertainment
- 3.6L V6 with 263 hp (Sport)
- 6-speed automatic transmission with tap-up/tap-down (Sport)
- Trailering equipment
- Fog lamps
- 17- and 18-inch (Sport only) aluminum wheels
- Luggage rack crossbars
- Remote Vehicle Starter System

OVERVIEW

Chevrolet Equinox is the compact crossover with sleek styling, available all-wheel drive, innovative interior, generous rear seat room⁴ and government 5-Star frontal and side impact crash test ratings.*

NEW FOR 2008

- Sport model includes 3.6L V6 with 263 horsepower
- Driver Information Center standard

*Five-star rating is for the driver and front passenger seating positions in the frontal crash test and for the front and rear seating positions in the side-impact crash test. Side-impact crash test rating is for a model tested without optional Head Curtain side-impact air bags (SABs). Government star ratings are part of the National Highway Traffic Safety Administration's (NHTSA's) New Car Assessment Program (www.safercar.gov).

MODEL AVAILABILITY

	Compact SUV
Equinox FWD LS	1LF26
Equinox AWD LS	1LG26
Equinox FWD LT	1LN26
Equinox AWD LT	1LP26
Equinox FWD LTZ	1LS26
Equinox AWD LTZ	1LT26
Equinox FWD Sport	1LQ26
Equinox AWD Sport	1LR26

SPECIFICATIONS (inches unless otherwise stated)

Wheelbase	112.5
Length	188.8
Width	71.4
Height	69.3
Seating f/r	2/3
Head room f/r	40.9/40.1
Shoulder room f/r	55.7/55.9
Leg room f/r	41.2/40.2
Max. cargo vol. ⁴ (cubic feet)	67.1
Fuel capacity ⁸ (gallons)	20 (FWD); 16 (AWD)
Max. towing capacity ⁷ (pounds)	3500



Shown with optional equipment

AVAILABLE EXTERIOR COLORS¹⁵

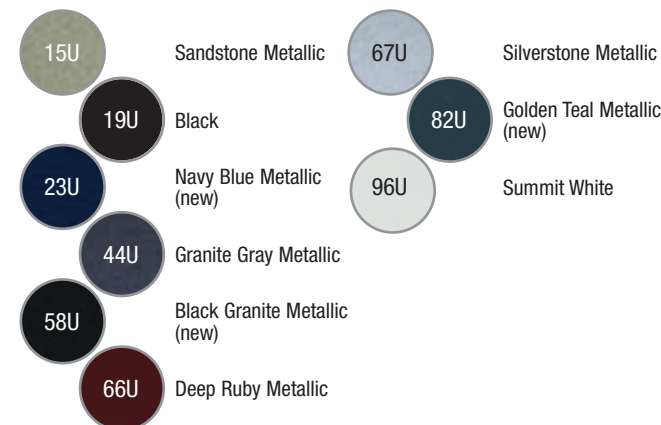



Shown with optional equipment

SELECTED STANDARD FEATURES
Safety and Security

- Frontal air bags¹
- 3-point safety belts, all positions
- LATCH (Lower Anchors and Top tethers for Children) system
- PASS-Key III+ theft-deterrent system
- Rear door child security locks
- Daytime Running Lamps
- OnStar 1-year Safe & Sound Plan²

Interior

- Front bucket seats with flat-folding passenger seat
- Driver's seatback map pocket
- 60/40 split-folding rear seat
- Air conditioning
- Cruise control
- Power door locks
- Driver Information Center
- Remote Keyless Entry
- Power windows
- AM/FM stereo with CD and auxiliary input jack

- Carpeted floor mats (front, rear and cargo area)
- Rearview auto-dimming mirror with compass
- Tilt adjustable steering column

Mechanical

- Front-wheel drive
- 2.2L Ecotec DOHC 4-cylinder engine with 149 hp
- Oil Life Monitoring System
- 5-speed manual transmission
- Front disc/rear drum brakes
- Independent front and semi-independent rear suspension
- Speed-sensitive electric steering

Exterior

- Power rearview mirrors
- P215/55R16 all-season tires
- Full bolt-on wheelcovers
- Rear liftgate with touch-pad opening
- Rear-window defogger
- Rear wiper

SELECTED OPTIONAL FEATURES

- StabiliTrak[®] stability enhancement system
- Head curtain side-impact air bags for front and rear outboard passengers¹
- Front seat options: power adjustment, leather seating surfaces, heated
- Power sunroof
- Audio options: 6-disc CD changer, MP3 player, XM Satellite Radio,³ Pioneer premium speaker system, steering wheel-mounted controls
- 2.4L Ecotec DOHC 4-cylinder engine with 175 hp
- 4-speed automatic transmission
- Full-function traction control
- 4-wheel antilock brake system
- Fog lamps
- 16- and 17-inch aluminum wheels
- Remote Vehicle Starter System
- Roof-mounted side rails
- Running boards

OVERVIEW

Chevrolet HHR has become a favorite of fleet buyers because of its large, configurable interior and its economical 4-cylinder engine. HHR now has an available Panel model.

NEW FOR 2008

- HHR Panel model added (see next page)
- StabiliTrak[®] stability enhancement system available
- OnStar 1-year Safe & Sound Plan² now standard (fleet delete available)

MODEL AVAILABILITY

	Crossover
HHR LS	1AT46
HHR LT	1AS46
HHR Panel LS	1AT26
HHR Panel LT	1AS26

SPECIFICATIONS (inches unless otherwise stated)

Wheelbase	103.5
Length	176.2
Width	69.1
Height	63.1
Seating f/r	2/3
Head room f/r	39.6/39.0
Shoulder room f/r	53.5/52.7
Leg room f/r	40.6/39.5
Max. cargo vol. ⁴ (cubic feet)	63.1
Fuel capacity ⁶ (gallons)	16
Max. towing capacity ⁷ (pounds)	1000



Shown with optional equipment

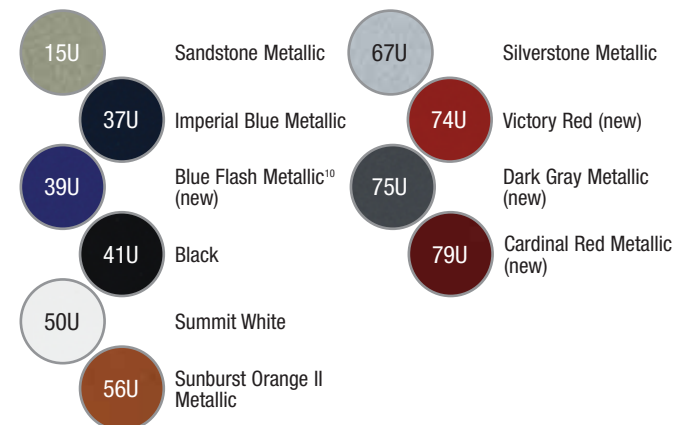

Shown with optional equipment

AVAILABLE EXTERIOR COLORS¹⁵



Shown with optional equipment



Shown with optional equipment

OVERVIEW

The Chevrolet HHR Panel, designed for a myriad of commercial and private uses, adds a new dimension of functionality to the popular HHR's lineup of stylish, efficient vehicles. It features windowless side panels that are perfect for storage for commercial signage and a flat cargo load floor with underfloor storage.⁴

NEW FOR 2008

- StabiliTrak[®] stability enhancement system available
- OnStar 1-year Safe & Sound Plan² now standard (fleet delete available)
- Remote Keyless Entry-activated rear cargo doors

MODEL AVAILABILITY

	Panel
HHR Panel LS	1AT26
HHR Panel LT	1AS26

SPECIFICATIONS (inches unless otherwise stated)

Wheelbase	103.6
Length	176.2
Width	69.1
Height	62.5
Seating	2
Head room	39.3
Shoulder room	53.5
Leg room	40.6
Max. cargo vol. ⁴ (cubic feet)	63.1
Fuel capacity ⁸ (gallons)	16
Max. towing capacity ⁷ (pounds)	1000

HHR Panel's side cargo doors open wide to enable cargo access from both sides of the vehicle. There are no external handles – the doors have a release button on the instrument panel or on the remote fob.



Shown with optional equipment



Shown with optional equipment

SELECTED STANDARD FEATURES

Safety and Security

- Frontal air bags¹
- 3-point safety belts, all positions
- PASS-Key III+ theft-deterrent system
- Daytime Running Lamps
- OnStar 1-year Safe & Sound Plan²

Interior

- Front bucket seats with flat-folding passenger seat
- Driver's seatback map pocket
- Air conditioning
- Cruise control
- Power door locks
- Driver Information Center
- Remote Keyless Entry
- 3 power outlets, one in the cargo area
- Power windows
- AM/FM stereo with CD and auxiliary input jack
- Carpeted front floor mats
- Rearview auto-dimming mirror with compass

- Tilt adjustable steering column
- Cargo storage area under the rear floor

Mechanical

- Front-wheel drive
- 2.2L Ecotec DOHC 4-cylinder engine with 149 hp
- Oil Life Monitoring System
- 5-speed manual transmission
- Front disc/rear drum brakes
- Independent front and semi-independent rear suspension
- Speed-sensitive electric steering

Exterior

- Power rearview mirrors
- P215/55R16 all-season tires
- Full bolt-on wheelcovers
- Side cargo doors with a release on the instrument panel or remote fob
- Rear liftgate with touch-pad opening
- Rear-window defogger
- Rear wiper

SELECTED OPTIONAL FEATURES

- StabiliTrak[®] stability enhancement system (standard on 2LT)
- Head curtain side-impact air bags for front and rear outboard passengers¹
- Front seat options: power adjustment, leather seating surfaces, heated
- Lockable underfloor storage area
- Power sunroof
- Audio options: 6-disc CD changer, MP3 player, XM Satellite Radio,³ Pioneer premium speaker system, steering wheel-mounted controls
- 2.4L Ecotec DOHC 4-cylinder engine
- 4-speed automatic transmission
- Full-function traction control
- 4-wheel antilock brake system
- Fog lamps
- 17-inch aluminum wheels
- Remote Vehicle Starter System
- Roof-mounted side rails
- Running boards



A large flat cargo floor has cargo tie-downs and two cargo storage compartments (shown above). These compartments can be ordered with lockable doors to secure valuable equipment.

AVAILABLE EXTERIOR COLORS¹⁵

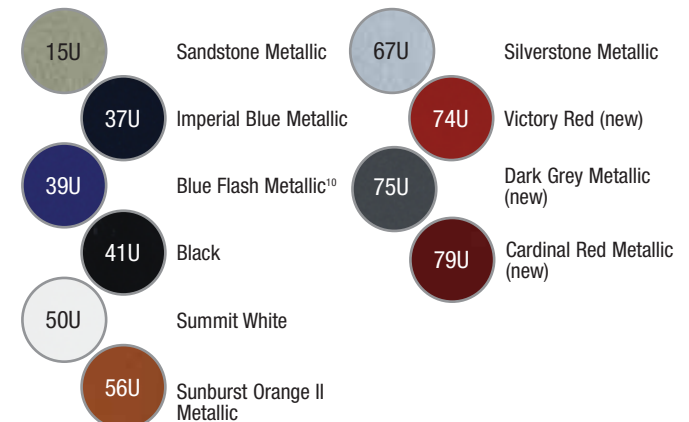



OVERVIEW

The new 2-mode full hybrid system will be launched in the Tahoe Hybrid for 2008. When combined with Active Fuel Management™, it is expected to enable the Tahoe Hybrid to deliver a composite fuel economy improvement of 25 percent (based on EPA estimated MPG 15 city/21 highway 4WD for the 2007 Tahoe (non-hybrid) with Vortec 5.3L engine). EPA-estimates for Tahoe Hybrid not available at the time of printing.

MODEL AVAILABILITY

	Full Size SUV
Tahoe 2WD	CC10706
Tahoe 4WD	CK10706

SPECIFICATIONS (inches unless otherwise stated)

Wheelbase	116.0
Length	202.0
Width	79.0
Height	76.9
Seating f/m/r (maximim)	3/3/3
Head room f/m/r	41.1/39.2/37.9
Shoulder room f/m/r	65.3/65.2/61.7
Leg room f/m/r	41.3/39.0/25.6
Max. cargo vol. ⁴ (cubic feet)	108.9
Fuel capacity ⁸ (gallons)	26
Max. towing capacity ⁷ (pounds)	6000 (Preliminary)



Specific aerodynamic features on the exterior including front and rear fascias and lightweight wheels – plus hybrid badges on the C-pillar and rear liftgate – distinguish the Tahoe Hybrid from other Tahoe models.



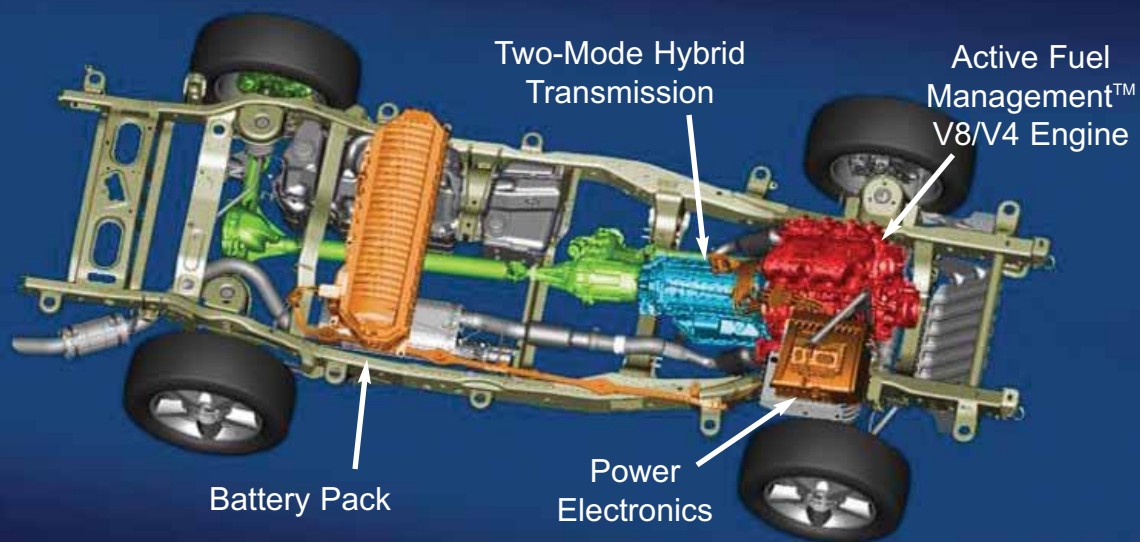

SELECTED STANDARD FEATURES

Safety and Security

- Dual-stage front air bags with Passenger Sensing System¹
- Head curtain side-impact air bags¹ with rollover sensor
- Tire Pressure Monitoring System⁹
- OnStar 1-year Directions & Connections Plan² (fleet delete available)
- StabiliTrak[®] stability enhancement system with Proactive Roll Avoidance
- PASS-Key III theft-deterrent system
- Daytime Running Lamps and automatic lamp control
- Rearview Camera System
- Tire Pressure Monitoring System

Interior

- 6-way power heated seats with leather seating surfaces
- 2nd-row 60/40 split-folding bench seat
- Driver Information Center
- 3 auxiliary power outlets
- Remote Keyless Entry
- Tilt adjustable steering column

- AM/FM with CD/MP3, XM[®] Satellite Radio,³ navigation system¹¹

Mechanical

- Vortec V8 SFI engine LVC with Active Fuel Management[™]
- Hybrid Propulsion Electric, Parallel, 14v/42v with 120v-2400w outlets
- 4-speed automatic strong hybrid transmission
- 4-wheel disc antilock brake system

Exterior

- Lowered 10mm in the front
- Aluminum streamlined hood
- Dual-port grille with large air intake
- Streamlined fascias, running boards and wheel openings
- Power, heated mirrors
- Lightweight aero-efficient wheels
- Aluminum rear liftgate, wiper/washer

2-MODE HYBRID FEATURES

The 2-mode is a patented hybrid technology with two modes optimized for city and highway driving.

- First mode: At low speed and light loads, the vehicle can operate by electric power or engine power or any combination.
- Second mode: Primarily for highway speeds providing electric assist and full V8 power when needed. It integrates sophisticated electronic controls, Active Fuel Management[™], cam phasing and late-intake valve closure for efficient engine operation
- 2-mode system allows for more compact packaging because powerful electric motors are designed to fit within the space of a conventional automatic transmission
- 300-volt battery pack is larger than typical battery, but fits in without compromising passenger space. No plug-in is required

Hybrid status information is displayed in the available instrument panel screen that is also used for the audio system and navigation.¹¹

AVAILABLE EXTERIOR COLORS¹⁵

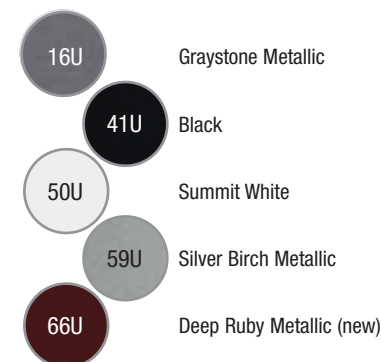



OVERVIEW

Chevrolet's full-size SUVs are offered in Tahoe and Suburban models. Styling, outstanding power and performance, and large interiors make them favorites for fleet and commercial work.

NEW FOR 2008

- 6-lug bright machined aluminum wheels available on Suburban
- 6-speed automatic transmission standard on Suburban ¾-ton models
- New standard 40/20/40 split-bench seats include a covered storage area
- StabiliTrak® stability enhancement system standard on all models

MODEL AVAILABILITY

	Tahoe	Suburban
Tahoe 2WD	CC10706	-
Tahoe 4WD	CK10706	-
Suburban 2WD ½-ton	-	CC10906
Suburban 4WD ½-ton	-	CK10906
Suburban 2WD ¾-ton	-	CC20906
Suburban 4WD ¾-ton	-	CK20906

SPECIFICATIONS (inches unless otherwise stated)

Wheelbase	116.0	130.0
Length	202.0	222.4
Width	79.0	79.1
Height	76.9	76.8
Seating f/m/r (maximum)	3/3/3	3/3/3
Head room f/m/r	41.1/39.2/37.9	41.1/38.5/38.1
Shoulder room f/m/r	65.3/65.2/61.7	65.3/65.2/64.7
Leg room f/m/r	41.3/39.0/25.6	41.3/39.5/34.9
Max. cargo vol. ⁴ (cubic feet)	108.9	137.4
Fuel capacity ⁸ (gallons)	26	31 (½-ton); 39 (¾-ton)
Max. towing capacity ⁷ (pounds)	8200	9700
Minimum ground clearance	9.1	9.1

SELECTED STANDARD FEATURES

Safety and Security

- Dual-stage front air bags with Passenger Sensing System¹
- Head curtain side-impact air bags¹ with rollover sensor
- Tire Pressure Monitoring System²
- OnStar 1-year Safe & Sound Plan² (fleet delete available)
- StabiliTrak® stability enhancement system with Proactive Roll Avoidance
- PASS-Key III theft-deterrent system
- Daytime Running Lamps and automatic lamp control

Interior

- 40/20/40 split-bench reclining front seats with lockable storage
- 2nd-row 60/40 split-folding bench seat
- 3rd-row 50/50 split-folding bench seat (available on Tahoe and Suburban 1FL)
- Driver Information Center
- 3 auxiliary power outlets
- Remote Keyless Entry
- Compass, outside temperature

- Tilt adjustable steering column
- AM/FM with CD/MP3, XM Satellite Radio³ (fleet delete available)

Mechanical

- Vortec 4.8L V8 with 295 hp (Tahoe 2WD)
- Vortec 5.3L V8 with 320 hp (Tahoe 4WD and Suburban)
- Vortec 6.0L V8 with 352 hp (Suburban ¾-ton)
- 4-speed automatic transmission (6-speed on Suburban ¾-ton)
- 4-wheel disc antilock brake system with hydroboost
- Autotrac transfer case (4WD)

Exterior

- Power, heated mirrors
- Assist steps
- P265/70R17 all-season tires
- Cast aluminum wheels (steel wheels on 1FL)
- Luggage rack side rails (fleet delete available)
- Rear liftgate with liftglass, wiper/washer

SELECTED OPTIONAL FEATURES

- Seating options: front and 2nd-row buckets, leather seating surfaces, heated 1st and 2nd row, power lumbar, memory
- Power release 2nd-row seats
- Power adjustable pedals
- Power sunroof
- Audio options: 6-disc CD changer, touch-screen navigation system,¹¹ Bose system, rear audio, rear-seat DVD entertainment
- Vortec 6.0L V8, 366 hp (½-ton)
- FlexFuel capability
- Autoride suspension
- Snow Plow Prep Package
- Z71 Off-Road Suspension
- Rear locking differential
- Trailering equipment
- 20-inch wheels¹⁴
- Outside mirror options: camper, power folding, turn signal, curb-tilt, driver auto-dimming
- Remote Vehicle Starter System
- Ultrasonic Rear Parking Assist
- Rearview camera system
- Power liftgate
- Heated windshield washer fluid
- Rainsense™ wipers
- Fleet Package



AVAILABLE EXTERIOR COLORS¹⁵

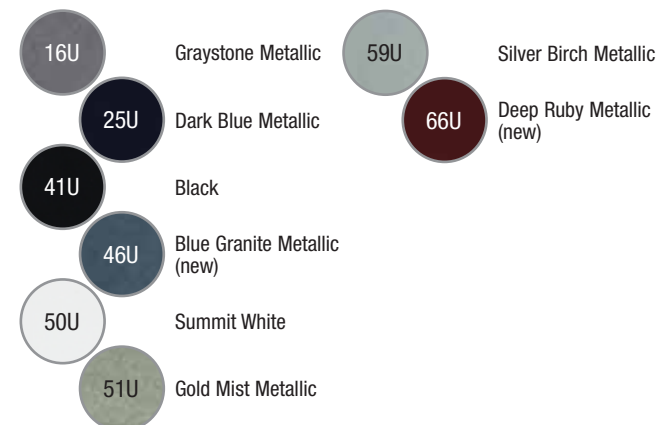

SELECTED STANDARD FEATURES
Safety and Security

- Dual-stage front air bags with Passenger Sensing System¹
- Head curtain side-impact air bags¹
- Rear door child security locks
- OnStar 1-year Safe & Sound Plan² (fleet delete available)
- StabiliTrak[®] stability enhancement system
- PASSlock theft-deterrent system
- Daytime Running Lamps and automatic lamp control
- Tire Pressure Monitoring System⁹

Interior

- Enhanced Quiet Package
- Front reclining bucket seats
- Split-folding 2nd-row seat (fleet delete available)
- Floor console
- Dual-zone climate control
- Cruise control
- Tilt adjustable steering column
- Power windows
- AM/FM stereo with CD
- Rear-window defogger (fleet delete available)

- Cargo tie-downs in rear compartment
- Programmable power door locks

Mechanical

- Rear-, 4- or all-wheel drive
- Vortec 4.2L I-6 with 291 hp
- 4-speed automatic transmission
- Autotrac automatic transfer case (4WD)
- 4-wheel disc antilock brake system
- Front independent, rear 5-link suspension
- Power steering
- Heavy-duty battery
- Trailing equipment

Exterior

- Intermittent front windshield wipers
- Aluminum wheels
- Luggage rack side rails (fleet delete available)
- Rear liftgate with liftglass, wiper/washer
- P245/65R17 all-season tires

SELECTED OPTIONAL FEATURES

- Seating options: 8-way power, leather seating surfaces, heated seats
- Universal Home Remote
- Power adjustable pedals
- Driver Information Center
- Remote Keyless Entry
- Power sunroof
- Audio options: 6-disc CD changer, rear audio, steering wheel-mounted controls, touch-screen navigation system,¹¹ XM Satellite Radio,³ Bose speaker system, rear-seat DVD entertainment center
- Cargo Convenience Package
- Vortec 5.3L V8 with 302 hp and Active Fuel Management[™]
- 6.0L V8 with 395 hp (SS)
- Rear locking differential
- Fog lamps

OVERVIEW

Chevrolet's midsize TrailBlazer is designed to deliver a refined ride, strong performance and generous passenger and cargo room⁴. Fleet Equipment Groups offer specific features for fleet customers only.

NEW FOR 2008

- Equipment Groups: Fleet (1FL, 2FL) and Retail (1LT, 2LT, 3LT, 1SS, 3SS)
- XM Satellite Radio³ standard
- Head curtain side-impact air bags¹ standard
- Cargo Convenience Package available

MODEL AVAILABILITY

	Midsize Sport Utility
Rear-wheel drive	CS15506
4- or all-wheel drive	CT15506

SPECIFICATIONS (inches unless otherwise stated)

Wheelbase	113.0
Length	191.8
Width	74.7
Height	72.5
Seating f/r	2/3
Head room f/r	40.2/39.6
Shoulder room f/r	58.5/58.5
Leg room f/r	46.9/37.0
Max. cargo vol. ⁴ (cubic feet)	80.1
Fuel capacity ⁸ (gallons)	22
Max. towing capacity ⁷ (pounds)	6800
Minimum ground clearance	7.8

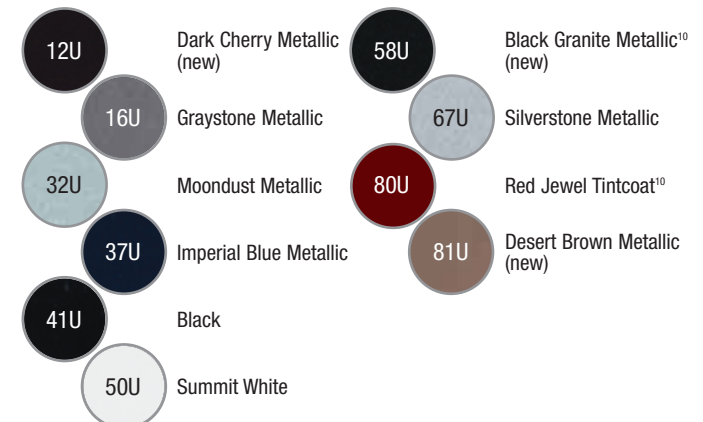
AVAILABLE EXTERIOR COLORS¹⁵



OVERVIEW

Introduced in 2007, the Acadia is GMC's first entry into the 2007 GM Medium Utility Crossover segment. It's a sleek, stylish crossover that can easily accommodate up to eight passengers. Body-frame integral construction provides a rigid foundation for an impressively smooth ride. Standard StabiliTrak® stability enhancement system, 6 air bags,¹ and one-year standard OnStar Directions & Connections Plan² help enhance safety before, during and after a collision.

NEW FOR 2008

- 2nd-row console available October 2007
- Rear view camera integrated with navigation system¹¹ available
- Hydraulic brake assist
- XM Satellite Radio³ standard (fleet delete available)
- OnStar 1-year Directions & Connections Plan² standard

MODEL AVAILABILITY

	Crossover
Acadia FWD	TR14526
Acadia AWD	TV14526

SPECIFICATIONS (inches unless otherwise stated)

Wheelbase	118.9
Length	200.7
Width	78.2
Height	69.9
Max. seating f/m/r	2/3/3
Head room f/m/r	40.4/39.3/38.4
Shoulder room f/m/r	61.9/61.1/57.8
Leg room f/m/r	41.3/36.9/33.2
Max. cargo vol. ⁴ (cubic feet)	116.9
Fuel capacity ⁸ (gallons)	22
Max. towing capacity ⁷ (pounds)	4500
Minimum ground clearance	7.4

SELECTED STANDARD FEATURES

Safety and Security

- Dual-stage front and side-impact air bags with Passenger Sensing System¹
- Head curtain side-impact air bags¹
- Rear door child security locks
- OnStar 1-year Directions & Connections Plan² with Turn-by-Turn Navigation² (fleet delete available)
- StabiliTrak® stability enhancement system
- PASS-Key III theft-deterrent system
- Daytime Running Lamps and automatic lamp control
- Tire Pressure Monitoring System⁹

Interior

- Front reclining bucket seats
- 7-passenger seating with 2nd-row flat-folding Captain's Chairs and 3rd-row 60/40 split-bench seat
- Front and rear climate control
- Cruise control
- Power windows

- Tilt/telescoping adjustable steering column
- AM/FM stereo with CD/MP3, XM Satellite Radio³
- Rear-window defogger
- Remote Keyless Entry
- Programmable power door locks

Mechanical

- Front- or all-wheel drive
- 3.6L VVT V6 with 275 hp
- 6-speed automatic transmission
- 4-wheel disc antilock brake system
- Independent front and rear suspension
- Power steering

Exterior

- Intermittent front windshield wipers
- Dual halogen projector headlamps
- Halogen fog lamps
- P255/65R18 all-season tires
- Aluminum wheels
- Roof rails
- Rear liftgate with wiper/washer

SELECTED OPTIONAL FEATURES

- Seating options: 8-passenger seating, 6- or 8-way power, leather seating surfaces, heated seats, memory
- Tri-zone automatic climate control
- Head-Up Display
- Household-style, 3-prong 115-volt power outlet
- Universal Home Remote
- Dual SkyScape 2-panel power sunroof
- Audio options: 6-disc CD changer, DVD player, rear audio, steering wheel-mounted controls, touchscreen navigation system,¹¹ Bose premium speaker system, rear-seat DVD entertainment center
- Cargo Convenience Package
- Trailing Package
- HID headlamps
- Heated windshield washer fluid
- Power liftgate
- Remote Vehicle Starter System
- Ultrasonic Rear Parking Assist



AVAILABLE EXTERIOR COLORS¹⁵

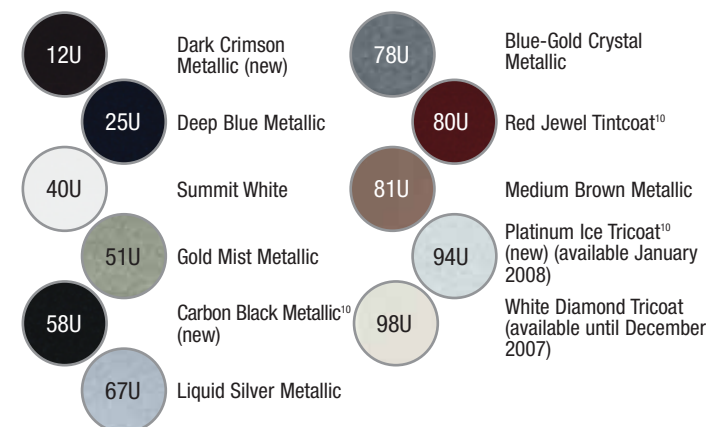



OVERVIEW

GMC Envoy offers fleet purchasers a high level of standard equipment and available features. It comes in SLE, SLT and Denali trim levels, plus 2-wheel or 4-wheel drive, to suit any buyer requirements.

NEW FOR 2008

- XM Satellite Radio³ standard
- Head curtain side-impact air bags¹ standard
- 20-in. wheels and tires¹⁴ are available on 2WD models

MODEL AVAILABILITY

	Midsize Sport Utility
Rear-wheel drive	TS15506
4-wheel drive	TT15506

SPECIFICATIONS (inches unless otherwise stated)

Wheelbase	113.0
Length	191.6
Width	74.7
Height	71.9
Seating f/r	2/3
Head room f/r	40.2/39.6
Shoulder room f/r	58.5/58.5
Leg room f/r (maximum)	46.9/37.0
Max. cargo vol. ⁴ (cubic feet)	80.1
Fuel capacity ⁸ (gallons)	22
Max. towing capacity ⁷ (pounds)	TBD
Minimum ground clearance	8.0

SELECTED STANDARD FEATURES

Safety and Security

- Dual-stage front air bags with Passenger Sensing System¹
- Head curtain side-impact air bags¹
- Rear door child security locks
- OnStar 1-year Safe & Sound Plan² (fleet delete available)
- StabiliTrak[®] stability enhancement system
- PASSlock theft-deterrent system
- Daytime Running Lamps and automatic lamp control
- Tire Pressure Monitoring System⁹

Interior

- Quiet Package
- Front reclining bucket seats
- Split-folding 2nd-row seat (fleet delete available)
- Dual-zone climate control
- Cruise control
- Tilt adjustable steering column
- AM/FM stereo with CD and XM Satellite Radio³ (fleet delete available for XM)
- Rear-window defogger (fleet delete available)

Remote Keyless Entry

- Remote Keyless Entry
- Cargo tie-downs in rear compartment

Mechanical

- Rear- or 4-wheel drive
- Vortec 4.2L I-6 with 291 hp
- 4-speed automatic transmission
- Autotrac automatic transfer case (4WD)
- 4-wheel disc antilock brake system
- Front independent, rear 5-link suspension
- Power steering
- Heavy-duty battery
- Trailering equipment

Exterior

- Intermittent front windshield wipers
- Fog and cornering lamps
- Aluminum wheels
- Luggage rack side rails
- Rear liftgate with liftglass, wiper/washer
- P245/65R17 all-season tires

SELECTED OPTIONAL FEATURES

- Seating options: 8-way power, leather-appointed and leather seating surfaces, heated seats
- Universal Home Remote
- Power adjustable pedals
- Driver Information Center
- Power sunroof
- Audio options: 6-disc CD changer, rear audio, steering wheel-mounted controls, touch-screen navigation system,¹¹ Bose speaker system, rear-seat DVD entertainment center
- Cargo Convenience Package
- Vortec 5.3L V8 with 302 hp and Active Fuel Management[™] (Denali)
- Rear locking differential
- Headlamp washers



AVAILABLE EXTERIOR COLORS¹⁵

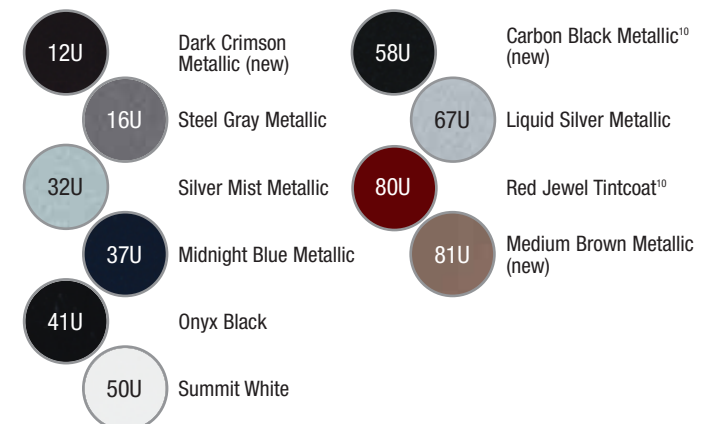

GMC YUKON HYBRID



OVERVIEW

The new 2-mode full hybrid system will be launched in the Yukon Hybrid for 2008. When combined with Active Fuel Management™, it is expected to enable the Yukon Hybrid to deliver a composite fuel economy improvement of 25 percent (based on EPA estimated MPG 15 city/21 highway 4WD for the 2007 Yukon (non-hybrid) with Vortec 5.3L engine). EPA-estimates for Yukon Hybrid not available at the time of printing.

MODEL AVAILABILITY

	Full Size SUV
Yukon 2WD	TC10706
Yukon 4WD	TK10706

SPECIFICATIONS (inches unless otherwise stated)

Wheelbase	116.0
Length	202.0
Width	79.0
Height	76.9
Seating f/m/r (maximum)	2/3/3
Head room f/m/r	41.1/39.2/37.9
Shoulder room f/m/r	65.3/65.2/61.7
Leg room f/m/r	41.3/39.0/25.6
Max. cargo vol. ⁴ (cubic feet)	108.9
Fuel capacity ⁸ (gallons)	26
Max. towing capacity ⁷ (pounds)	6000 (Preliminary)



Specific aerodynamic features on the exterior including front and rear fascias and lightweight wheels – plus hybrid badges on the C-pillar and rear liftgate – distinguish the Yukon Hybrid from other Yukon models.



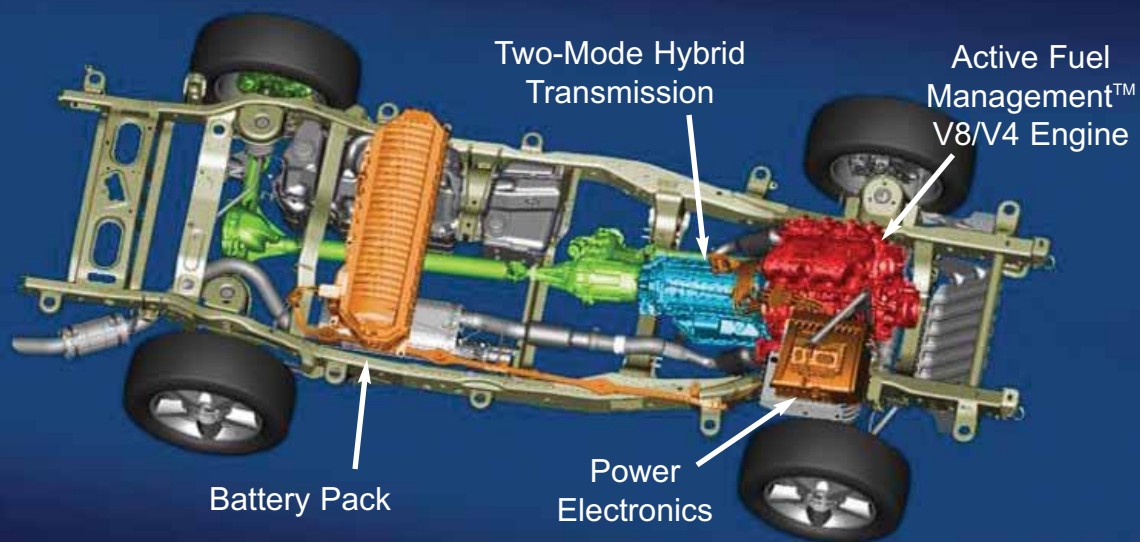

SELECTED STANDARD FEATURES

Safety and Security

- Dual-stage front air bags with Passenger Sensing System¹
- Head curtain side-impact air bags¹ with rollover sensor
- Tire Pressure Monitoring System⁹
- OnStar 1-year Directions & Connections Plan² (fleet delete available)
- StabiliTrak[®] stability enhancement system with Proactive Roll Avoidance
- PASS-Key III theft-deterrent system
- Daytime Running Lamps and automatic lamp control
- Rearview Camera System
- Tire Pressure Monitoring System

Interior

- 6-way power heated seats with leather seating surfaces
- 2nd-row 60/40 split-folding bench seat
- Driver Information Center
- 3 auxiliary power outlets
- Remote Keyless Entry
- Tilt adjustable steering column

- AM/FM with CD/MP3, XM[®] Satellite Radio,³ navigation system¹¹

Mechanical

- Vortec V8 SFI engine LVC with Active Fuel Management[™]
- Hybrid Propulsion Electric, Parallel, 14v/42v with 120v-2400w outlets
- 4-speed automatic strong hybrid transmission
- 4-wheel disc antilock brake system

Exterior

- Lowered 10mm in the front
- Aluminum streamlined hood
- Dual-port grille with large air intake
- Streamlined fascias, running boards and wheel openings
- Power, heated mirrors
- Lightweight aero-efficient wheels
- Aluminum rear liftgate, wiper/washer

2-MODE HYBRID FEATURES

The 2-mode is a patented hybrid technology with two modes optimized for city and highway driving.

- First mode: At low speed and light loads, the vehicle can operate by electric power or engine power or any combination
- Second mode: Primarily for highway speeds providing electric assist and full V8 power when needed. It integrates sophisticated electronic controls, Active Fuel Management[™], cam phasing and late-intake valve closure for efficient engine operation
- 2-mode system allows for more compact packaging because powerful electric motors are designed to fit within the space of a conventional automatic transmission
- 300-volt battery pack is larger than typical battery, but fits in without compromising passenger space. No plug-in is required



Hybrid status information is displayed in the available instrument panel screen that is also used for the audio system and navigation.¹¹

AVAILABLE EXTERIOR COLORS¹⁵





OVERVIEW

The GMC Yukon and Yukon XL, plus the Denali models, convey the Professional Grade qualities with distinct designs and premium value. Two sizes are available for a wide range of capabilities. Denali models offer enhanced performance and extra amenities with an upscale exterior.

NEW FOR 2008

- New aluminum wheels available on Yukon ¾-ton
- 6-speed automatic transmission standard on Yukon XL ¾-ton models
- New standard 40/20/40 split-bench seats include a covered storage area
- StabiliTrak® stability enhancement system standard on all models

MODEL AVAILABILITY

	Yukon	Yukon XL
Yukon 2WD	TC10706	-
Yukon 4WD/Yukon Denali AWD	TK10706	-
Yukon XL 2WD ½-ton	-	TC10906
Yukon XL 4WD/Yukon XL Denali AWD ½-ton	-	TK10906
Yukon XL 2WD ¾-ton	-	TC20906
Yukon XL 4WD ¾-ton	-	TK20906

SPECIFICATIONS (inches unless otherwise stated)

Wheelbase	116.0	130.0
Length	202.0	222.4
Width	79.0	79.1
Height	76.9	76.8
Seating f/m/r (maximum)	3/3/3	3/3/3
Head room f/m/r	41.1/39.2/37.9	41.1/38.5/38.1
Shoulder room f/m/r	65.3/65.2/61.7	65.3/65.2/64.7
Leg room f/m/r	41.3/39.0/25.6	41.3/39.5/34.9
Max. cargo vol. ⁴ (cubic feet)	108.9	137.4
Fuel capacity ⁸ (gallons)	26	31 (½-ton); 39 (¾-ton)
Max. towing capacity ⁷ (pounds)	8200	9700
Minimum ground clearance	9.1	9.1

SELECTED STANDARD FEATURES

Safety and Security

- Dual-stage front air bags with Passenger Sensing System¹
- Head curtain side-impact air bags¹ with rollover sensor
- Tire Pressure Monitoring System⁹
- OnStar 1-year Safe & Sound Plan² (fleet delete available)
- StabiliTrak® stability enhancement system with Proactive Roll Avoidance
- PASS-Key III theft-deterrent system
- Daytime Running Lamps and automatic lamp control

Interior

- 40/20/40 split-bench reclining front seats with lockable storage
- 2nd-row 60/40 split-folding bench seat
- 3rd-row 50/50 split-folding bench seat (available on Yukon and Yukon XL)
- Driver Information Center
- Remote Keyless Entry
- Tilt adjustable steering column

- AM/FM with CD/MP3, XM Satellite Radio³ (fleet delete available)

Mechanical

- Rear-, 4- or all-wheel drive
- Vortec 4.8L V8 with 295 hp (Yukon 2WD)
- Vortec 5.3L V8 with 320 hp (Yukon 4WD and Yukon XL)
- Vortec 6.0L V8 with 352 hp (Yukon XL ¾-ton)
- Vortec 6.2L V8 with 380 hp (Denali)
- 4-speed automatic transmission (6-speed on Yukon XL ¾-ton, Denali)
- 4-wheel disc antilock brake system

Exterior

- Assist steps
- P265/70R17 all-season tires
- Luggage rack side rails (fleet delete available)
- Rear liftgate with liftglass, wiper/washer

SELECTED OPTIONAL FEATURES

- Seating options: front and 2nd-row buckets, leather seating surfaces, heated 1st and 2nd row, power lumbar, memory
- Power release 2nd-row seats
- Power adjustable pedals
- Audio options: 6-disc CD changer, touchscreen navigation system,¹¹ Bose system, rear audio, rear seat DVD entertainment
- Vortec 6.0L V8 with 366 hp (½-ton)
- FlexFuel capability
- Autoride suspension
- Snow Plow Prep Package
- Z71 Off-Road Suspension
- Rear locking differential
- Trailering equipment
- 20-in. wheels¹⁴
- Outside mirror options: camper, power folding, turn signal, curb-tilt, driver auto-dimming
- Remote Vehicle Starter System
- Ultrasonic Rear Parking Assist
- Rearview camera system
- Power liftgate
- Heated windshield washer fluid
- Rainsense™ wipers
- Fleet Package



AVAILABLE EXTERIOR COLORS¹⁵

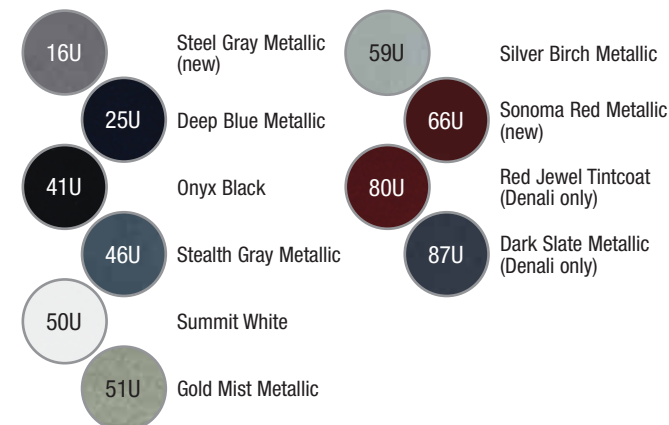



OVERVIEW

The HUMMER H2 SUV and SUT (shown above) bring a new level of capability and flexibility to the fleet marketplace. Extensive changes for 2008 add more power, enhance safety and add comfort.

NEW FOR 2008

- Vortec 6.2L V8 engine and 6-speed automatic transmission
- StabiliTrak® stability enhancement system standard
- Redesigned interior
- Head curtain side-impact air bags¹ with rollover sensor standard
- Remote Vehicle Starter System standard
- Rear auxiliary air conditioning available (SUV)
- New audio features
- Rear seat DVD player with 8-in. (diagonal) overhead display

MODEL AVAILABILITY

	SUV	SUT
H2 4WD	RN25706	RN25736

SPECIFICATIONS (inches unless otherwise stated)

Wheelbase	122.8	122.8
Length	189.8	189.8
Width	81.2	81.2
Height	79.2	79.2
Seating f/m/r (maximum)	2/3/2	2/3
Head room f/m/r	40.5/39.7/38.8	40.5/39.7
Shoulder room f/m/r	66.4/66.3/41.4	66.4/66.3
Leg room f/m/r	41.3/38.6/27.3	41.3/38.6
Max. cargo vol. ⁴ (cubic feet)	86.6	52.7 (Midgate down)
Fuel capacity ⁶ (gallons)	32	32
Max. towing capacity ⁷ (pounds)	6700	6700
Minimum ground clearance	9.9	9.9

SELECTED STANDARD FEATURES

Safety and Security

- Dual-stage front air bags with passenger deactivation switch¹
- Head curtain side-impact air bags¹ with rollover sensor
- OnStar 1-year Safe & Sound Plan²
- StabiliTrak® stability enhancement system
- Daytime Running Lamps and automatic lamp control

Interior

- Front reclining heated bucket seats with 8-way power, 4-way lumbar and driver memory
- 2nd-row 60/40 heated seat
- Leather seating surfaces
- Floor console with rear audio controls
- Dual-zone automatic climate control; rear A/C (SUV)
- Cruise control
- Driver Information Center
- 6 auxiliary power outlets
- Remote Vehicle Starter System
- Tilt adjustable steering column
- Compass, outside temperature

- Full-folding Midgate® with power window (SUT)
- AM/FM with MP3/6-disc CD player, Bose speaker system, rear audio controls, steering wheel-mounted controls, XM Satellite Radio³ (fleet delete available)

Mechanical

- 4-wheel drive
- Vortec 6.2L V8 with 403 hp
- 6-speed automatic transmission with tap-up/tap-down
- Rear locking differential
- Single wheel traction control
- 4-wheel disc antilock brake system
- Trailering equipment

Exterior

- Identification and clearance lamps, front and rear
- LT315/70R17 all-terrain tires
- Aluminum wheels
- Luggage rack side rails
- Rear liftgate with liftglass, wiper/washer (SUV)
- Rear expandable cargo bed (SUT)

SELECTED OPTIONAL FEATURES

- 3rd-row folding two-passenger seat (SUV)
- Power sunroof
- Universal Home Remote
- Audio options: touchscreen navigation system,¹¹ Bose 5.1 Cabin Surround Sound system, rear-seat DVD entertainment
- Air spring suspension
- Trailering Convenience Package
- Rearview camera system
- Heated windshield washer fluid



AVAILABLE EXTERIOR COLORS¹⁵

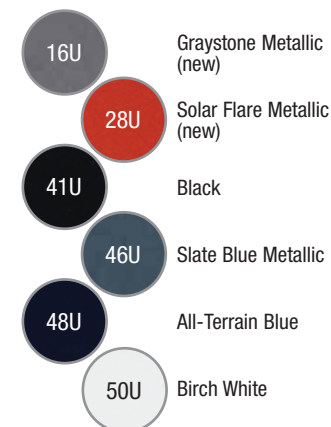



OVERVIEW

H3 delivers authentic HUMMER capability and style in a midsize package. For 2008, an Alpha model is added that boosts horsepower, torque, GVWR and trailering.

NEW FOR 2008

- H3 Alpha with 5.3L V8 engine, 4.10 rear axle ratio, 145-amp alternator, 6000-lb. GVWR⁸ and model badging
- Head curtain side-impact air bags¹ with rollover sensor standard
- Rear vision camera system available

MODEL AVAILABILITY

	Midsize Sport Utility
H3 4WD	RN15306

SPECIFICATIONS (inches unless otherwise stated)

Wheelbase	111.9
Length	186.7
Width	74.7
Height	73.7
Seating f/r (maximum)	2/3
Head room f/r	40.6/39.9
Shoulder room f/r	54.4/53.5
Leg room f/r	41.9/35.0
Max. cargo vol. ⁴ (cubic feet)	55.7
Fuel capacity ⁸ (gallons)	23
Max. towing capacity ⁷ (pounds)	TBD
Minimum ground clearance	9.1

SELECTED STANDARD FEATURES

Safety and Security

- Dual-stage front air bags with Passenger Sensing System¹
- Head curtain side-impact air bags¹ with rollover sensor
- OnStar 1-year Safe & Sound Plan² (fleet delete available)
- StabiliTrak[®] stability enhancement system
- Daytime Running Lamps and automatic lamp control
- Tire Pressure Monitoring System⁹

Interior

- Front reclining bucket seats with driver manual lumbar control
- 60/40 split-folding rear seat
- Floor console
- Air conditioning
- Cruise control
- Electrochromic mirror, compass, outside temperature
- Power door locks
- 3 auxiliary power outlets
- Remote Keyless Entry
- Tilt adjustable steering column
- Rear cargo area with Tufloor rubberized flooring

Power windows

- AM/FM with CD player and XM Satellite Radio³ (fleet delete available)

Mechanical

- 4-wheel drive
- 3.7L DOHC I-5 with 242 hp
- 5.3L V8 engine with automatic transmission (Alpha)
- 5-speed manual transmission
- Single-wheel traction control
- 4-wheel disc antilock brake system with unique calibration for 4Lo
- Skid Plate Package
- Power rack-and-pinion steering

Exterior

- HUMMER 7-slot grille
- Recovery hooks - 2 front, 1 rear
- Front and rear wiper/washer
- Fog lamps
- P265/75R16 on-/off-road tires
- Aluminum wheels
- Luggage rack side rails
- Rear swing-out gate
- Full-size gate-mounted spare tire

SELECTED OPTIONAL FEATURES

- Seat options: leather seating surfaces, 8-way power front seats, heated front seats
- Universal Home Remote
- Cargo cover
- Audio options: 6-disc CD player, MP3 player, touch-screen navigation system,¹¹ Monsoon premium speakers
- 4-speed automatic transmission
- Driver-selectable rear locking differential
- Off-Road Adventure Package
- Trailering equipment
- Chrome Appearance Package
- Large power sunroof
- Rear vision camera system
- H3X Package



AVAILABLE EXTERIOR COLORS¹⁵

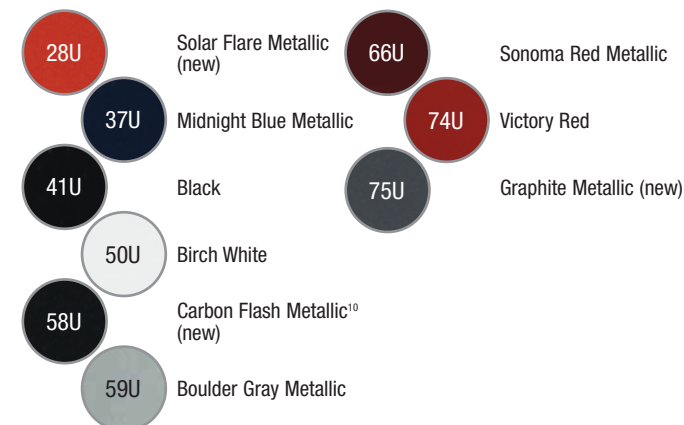



SELECTED STANDARD FEATURES

Safety and Security

- Dual-stage front air bags with Passenger Sensing System¹
- LATCH (Lower Anchors and Top tethers for Children) system
- PASSKey III+ theft-deterrent system
- Rear door child security locks
- Daytime Running Lamps and automatic lamp control
- StabiliTrak[®] stability enhancement system
- OnStar 1-year Safe & Sound Plan² (fleet delete available)
- Tire Pressure Monitoring System⁹

Interior

- Front reclining bucket seats with flat-folding passenger seat
- Multi-Flex sliding, reclining rear seat with 60/40 split seatback
- Floor console with armrest
- Air conditioning with filtration
- Cruise control
- Tachometer and Driver Information Center
- Remote Keyless Entry
- Tilt adjustable steering column

- AM/FM stereo with CD/MP3, XM Satellite Radio³ and auxiliary input jack

Mechanical

- Front- or all-wheel drive
- 3.4L V6 with 185 hp
- 5-speed automatic transmission
- 3.6L V6 with 263 hp (GXP)
- 6-speed automatic transmission with tap-up/tap-down (GXP)
- 4-wheel disc antilock brake system
- 4-wheel independent suspension
- Traction control
- Variable-effort electric power steering
- Maintenance-free battery with rundown protection

Exterior

- Intermittent front windshield wipers
- Fog lamps
- P235/65R16 all-season tires and aluminum wheels
- Luggage rack side rails
- Rear liftgate with wiper/washer

SELECTED OPTIONAL FEATURES

- Head curtain side-impact air bags¹ with rollover sensor
- Seat options: 6-way power driver adjustment, manual lumbar adjuster, leather seating surfaces, heated seats
- Power sunroof
- Rear cargo panel, height-adjustable for security cover or table
- Audio options: 6-disc CD changer, Pioneer premium speaker system, steering wheel-mounted controls, navigation system,¹¹ DVD rear-seat entertainment
- Trailing equipment
- 17- and 18-inch aluminum wheels
- Luggage rack crossbars
- Remote Vehicle Starter System

OVERVIEW

Pontiac Torrent combines comfort with SUV capability and versatility in a package with a roomy and versatile interior. 2008 adds even more performance with the Torrent GXP.

NEW FOR 2008

- GXP model includes 3.6L V6, 6-speed automatic transmission with TAPshift, 18-in. wheels and more
- OnStar 1-year Safe & Sound Plan² standard (fleet delete available)
- XM Satellite Radio³ standard
- Other standard features now include cruise control, compass and AM/FM with CD/MP3

MODEL AVAILABILITY

	Compact SUV
Torrent FWD	2LF26
Torrent AWD	2LG26
Torrent GXP FWD	2LS26
Torrent GXP AWD	2LT26

SPECIFICATIONS¹ (inches unless otherwise stated)

Wheelbase	112.5
Length	188.8
Width	71.4
Height	69.3
Seating f/r	2/3
Head room f/r	40.9/40.1
Shoulder room f/r	55.7/55.9
Leg room f/r	41.2/40.2
Max. cargo vol. ⁴ (cubic feet)	68.6
Fuel capacity ⁸ (gallons)	20 (FWD); 17 (AWD)
Max. towing capacity ⁷ (pounds)	3500
Minimum ground clearance	7.9



AVAILABLE EXTERIOR COLORS¹⁵

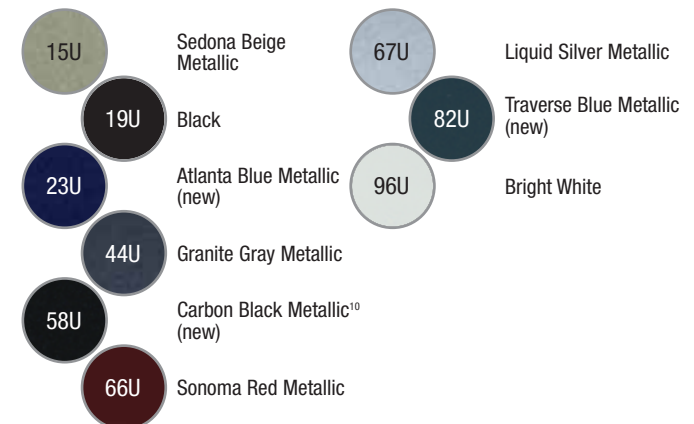



9-7X

SPORT UTILITY/ CROSSOVER



SELECTED STANDARD FEATURES

Safety and Security

- Dual-stage front air bags with Passenger Sensing System¹
- Head curtain side-impact air bags¹ with rollover sensor
- Rear door child security locks
- OnStar 1-year Directions & Connections Plan² with Turn-by-Turn Navigation²
- StabiliTrak[®] stability enhancement system
- PASS-Key theft-deterrent system
- Daytime Running Lamps and automatic lamp control
- Tire Pressure Monitoring System⁹

Interior

- Leather-appointed, heated bucket seats with 8-way power, lumbar adjustment and memory
- Split-folding 2nd-row seat
- Dual-zone automatic climate control
- Tilt adjustable steering column
- AM/FM stereo with 6-disc CD changer, Bose[®] premium audio system, rear audio and XM Satellite Radio³

- Driver Information Center
- Remote Keyless Entry
- Cruise control
- Cargo tie-downs

Mechanical

- Automatic all-wheel drive
- Vortec 4.2L I-6 with 291 hp
- 4-speed automatic transmission
- 4-wheel disc antilock brake system
- Saab-tuned sport chassis, rear air suspension with load leveling
- Limited slip differential
- Heavy-duty battery
- Trailering equipment

Exterior

- Intermittent windshield wipers
- Projector beam headlamps and fog lamps
- Aluminum wheels
- Integrated roof rails
- Power moonroof
- Rear liftgate with liftglass, wiper/washer
- P225/55R18 all-season tires

SELECTED OPTIONAL FEATURES

- Power adjustable pedals (standard 5.3i)
- Audio options: touch-screen navigation system,¹¹ rear-seat DVD entertainment center
- 5.3L V8 with 300 hp and Active Fuel Management[™] (standard 5.3i)
- Xenon headlamps (standard 5.3i)
- Headlamp washers (standard 5.3i)

OVERVIEW

Saab 9-7X brings unique Saab characteristics to the premium SUV segment, including sophisticated exterior and interior styling, advanced design features and a chassis tuned to deliver spirited performance. And Saab continues the no-charge scheduled maintenance service.

NEW FOR 2008

- Available 18-inch high-polished aluminum wheels

MODEL AVAILABILITY

	Midsize Sport Utility
9-7X 4.2i	BT15506 725
9-7X 5.3i	BT15506 755

SPECIFICATIONS (inches unless otherwise stated)

Wheelbase	113.0
Length	193.2
Width	75.4
Height	68.5
Seating f/r	2/3
Head room f/r	40.2/39.6
Shoulder room f/r	58.5/58.5
Leg room f/r (maximum)	41.4/37.1
Max. cargo vol. ⁴ (cubic feet)	80.1
Fuel capacity ⁸ (gallons)	22
Max. towing capacity ⁷ (pounds)	6500
Minimum ground clearance	7.7



AVAILABLE EXTERIOR COLORS¹⁵

- 16U Graphite Gray Metallic
- 37U Crystal Blue Metallic
- 41U Obsidian Black
- 50U Winter White
- 67U Titanium Silver Metallic
- 80U Lingonberry Red Metallic

SELECTED STANDARD FEATURES
Safety and Security

- Dual-stage front and side-impact air bags with Passenger Sensing System¹
- Head curtain side-impact air bags¹
- Rear door child security locks
- OnStar 1-year Safe & Sound Plan²
- StabiliTrak[®] stability enhancement system
- PASS-Key III theft-deterrent system
- Daytime Running Lamps and automatic lamp control
- Tire Pressure Monitoring System⁹

Interior

- 8-passenger seating with front Captain's Chairs, 2nd-row split-folding and 3rd-row flat-folding
- Floor console with sliding armrest
- Driver Information Center
- Front and rear climate control
- Cruise control
- Power windows
- Remote Keyless Entry

- Tilt/telescoping adjustable steering column
- AM/FM stereo with CD/MP3, XM Satellite Radio³
- Rear-window defogger

Mechanical

- Front- or all-wheel drive
- 3.6L VVT V6 with 270 hp (XE), 275 hp (XR)
- 6-speed automatic transmission
- 4-wheel disc antilock brake system
- Traction control
- Independent front and rear suspension
- Variable-effort power steering (XR)

Exterior

- Intermittent front windshield wipers
- Dual halogen projector headlamps
- Fog lamps
- P255/65R18 all-season tires
- Aluminum wheels
- Rear liftgate with wiper/washer

SELECTED OPTIONAL FEATURES

- Seating options: 7-passenger seating, 6- or 8-way power, leather seating surfaces, heated seats, memory, 2nd-row console
- Tri-zone automatic climate control
- Household-style, 3-prong 115-volt power outlet
- Universal Home Remote
- Dual 2-panel power sunroof
- Audio options: 6-disc CD changer, DVD player, rear audio, steering wheel-mounted controls, touch-screen navigation system,¹¹ Advanced Audio Package, rear-seat DVD entertainment center
- Trailing Package
- HID headlamps
- Heated windshield washer fluid
- Luggage rack roof rails
- Power liftgate
- Rearview camera system
- Remote Vehicle Starter System
- Ultrasonic Rear Parking Assist

OVERVIEW

Introduced in 2007, the OUTLOOK allows Saturn enthusiasts the opportunity to enter the GM medium utility crossover segment. It's a sleek, stylish crossover that can easily accommodate eight passengers. Body-frame integral construction provides a rigid foundation for an impressively smooth ride. Standard StabiliTrak[®] stability enhancement system, 6 air bags,¹ and OnStar Safe & Sound Plan² with one-year standard service, help enhance safety before, during and after a collision.

NEW FOR 2008

- Rearview camera system integrated with navigation¹¹ available
- Second row console available
- XM Satellite Radio³ standard (fleet delete available)
- Hydraulic brake assist

MODEL AVAILABILITY

	Crossover
OUTLOOK FWD	ZR14526
OUTLOOK AWD	ZV14526

SPECIFICATIONS (inches unless otherwise stated)

Wheelbase	118.9
Length	200.1
Width	78.1
Height	72.5
Seating f/r	2/3/3
Head room f/m/r	40.4/39.3/38.4
Shoulder room f/m/r	61.9/61.1/57.8
Leg room f/m/r	41.3/36.9/33.2
Max. cargo vol. ⁴ (cubic feet)	116.9
Fuel capacity ⁸ (gallons)	22
Max. towing capacity ⁷ (pounds)	4500
Minimum ground clearance	7.4

AVAILABLE EXTERIOR COLORS¹⁵



Shown with optional equipment



Shown with optional equipment

OVERVIEW

The 2008 Saturn VUE is a compact five-door crossover vehicle with all-new design, inside and out, and sporty ride and handling. The new VUE will be available in XE, XR, Green Line Hybrid and the performance Red Line.

MODEL AVAILABILITY

	FWD	AWD
VUE XE	ZLF26	ZLG26
VUE XR	ZLR26	ZLS26
VUE Green Line	ZLT26	—
VUE Red Line	ZLW26	ZLX26

SPECIFICATIONS (inches unless otherwise stated)

Wheelbase	106.6
Length	180.2
Width	72.8
Height	67.0
Seating	2/3
Head room f/r	40.2/39.3
Shoulder room f/r	56.0/55.9
Leg room f/r	40.7/36.9
Max. cargo vol. ⁴ (cubic feet)	54.3
Fuel capacity ⁸ (gallons)	16.9 (AWD)/19.5 (FWD)
Max. towing capacity ⁷ (pounds)	1500 (4-cyl.), 3500 (V6)

The VUE's clean, sculpted look is sporty, and includes tight wheel-to-body relationships, large jeweled headlamps and a sweeping upper profile.



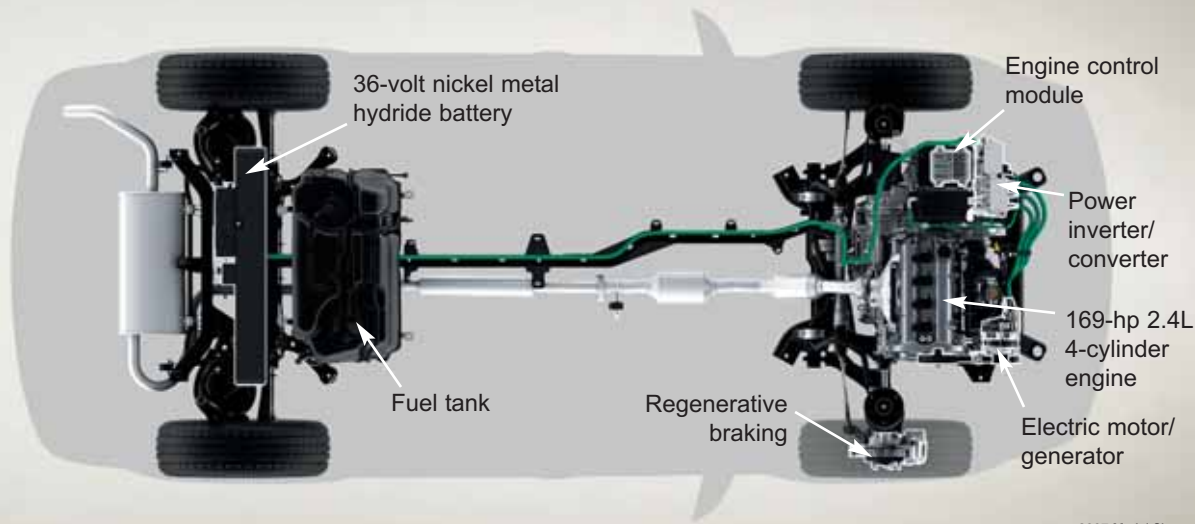

2007 Model Shown

SELECTED STANDARD FEATURES

Safety and Security

- Dual-stage front and side-thorax air bags with Passenger Sensing System¹
- Seat-mounted side air bags²
- Head curtain side-impact air bags¹
- Rear door child security locks
- OnStar 1-year Safe & Sound Plan²
- StabiliTrak[®] stability enhancement system
- Theft-deterrent system
- Daytime Running Lamps and automatic lamp control
- Tire Pressure Monitoring System⁹

Interior

- Front reclining bucket seats
- Flat-folding 60/40 split rear seats with a center console armrest and storage
- Air conditioning
- Cruise control
- Power windows
- Tilt adjustable steering column

- AM/FM stereo with CD/MP3, auxiliary input jack, steering wheel controls, XM Satellite Radio³
- Remote Keyless Entry
- Programmable power door locks

Mechanical

- Front- or all-wheel drive
- 2.4L Ecotec 4-cylinder engine with 169 hp; hybrid version with 169 hp
- 4-speed automatic transmission
- Hybrid Propulsion Equipment (Green Line)
- 4-wheel disc antilock brake system
- Independent front and rear suspension
- Power steering

Exterior

- Intermittent front windshield wipers
- P235/65R16 all-season tires
- Alloy wheels
- Liftgate with wiper/washer

SELECTED OPTIONAL FEATURES

- Seating options: 8-way power, leather seating surfaces, heated seats
- Universal Home Remote
- Audio options: 6-disc CD changer, DVD player, touch-screen navigation system,¹¹ Saturn Advanced Audio System
- 3.5L V6 engine, 222 hp
- 3.6L V6 engine, 252 hp
- 6-speed automatic transmission
- TAPshift manual shift control
- Trailering Package
- Rain-sensing windshield wipers
- Heated windshield washer fluid
- Remote Vehicle Starter System

HYBRID

The VUE Green Line uses GM's Hybrid system. The Ecotec 4-cylinder engine works with the sophisticated electric motor/generator to shut off the engine at stops, restart the engine when the brake pedal is released, charge the advanced nickel metal hydride battery through regenerative braking, and perform intelligent battery charging when it is most efficient.

AVAILABLE EXTERIOR COLORS¹⁵

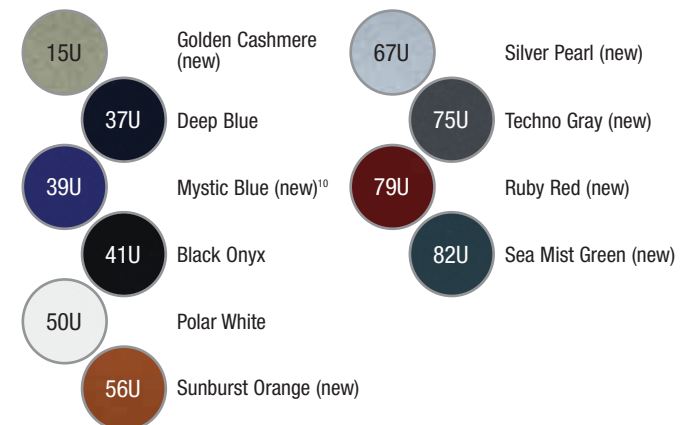



SELECTED STANDARD FEATURES

Safety and Security

- Front air bags with Passenger Sensing System¹
- 3-point safety belts, all positions except front center
- PASSlock theft-deterrent system
- Daytime Running Lamps and automatic lamp control
- OnStar 1-year Safe & Sound Plan²
- Tire Pressure Monitoring System⁹

Mechanical

- 5-speed manual transmission (not available in California and NE states with emission codes)
- Front disc/rear drum antilock brake system
- Insta-Trac 4-wheel drive (4WD)
- Front independent and rear leaf spring suspension
- Power rack-and-pinion steering

Exterior

- Intermittent windshield wipers
- Foldaway rearview mirrors
- Pickup box with 2-position tailgate

Interior

- 60/40 split-bench front seat
- Air conditioning
- Driver Information Center
- Tilt adjustable steering column
- AM/FM stereo with digital clock



Shown with optional equipment

SELECTED OPTIONAL FEATURES

- Head curtain side-impact air bags¹
- Seating options: front reclining bucket seats, leather seating surfaces, heated, 8-way driver power, 6-way front passenger power
- Inside rearview auto-dimming mirror with compass and outside temperature display
- Power windows and locks
- Rear sliding window
- Audio options: CD and MP3 players, 6-disc CD changer, XM Satellite Radio³
- 4-speed automatic transmission
- Z71 Suspension
- Automatic locking rear differential
- Traction control (2WD)
- 15-inch aluminum wheels
- Remote Keyless Entry
- Power sunroof

OVERVIEW

Chevrolet Colorado's spacious interior, wide range of payload configurations⁴ and seating for up to six make it an outstanding choice for just about any commercial or personal need.

Engine Availability

- 2.9L DOHC L4 with 185 horsepower (not available in California and NE states with emission codes)
- 3.7L DOHC L5 with 242 horsepower

NEW FOR 2008

- OnStar 1-year Safe & Sound Plan² standard

SPECIFICATIONS

Model	Box Length (feet)	Model Number/Drivetrain	Wheelbase (inches)	GVWR ⁵ (pounds)	Payload ⁶ (pounds)	Maximum Trailer Weight ⁷ (pounds)	Seating
Regular Cab	6	CS15403/RWD	111.3	4850	1547	4000	3
	6	CT15403/4WD	111.3	5150	1535	4000	3
Extended Cab	6	CS15653/RWD	126.0	5000	1532	5500	5
	6	CT15653/4WD	126.0	5300	1523	5500	5
Crew Cab	5	CS15643/RWD	126.0	5000	1316	5500	6
	5	CT15643/4WD	126.0	5300	1338	5500	6

AVAILABLE EXTERIOR COLORS¹⁵

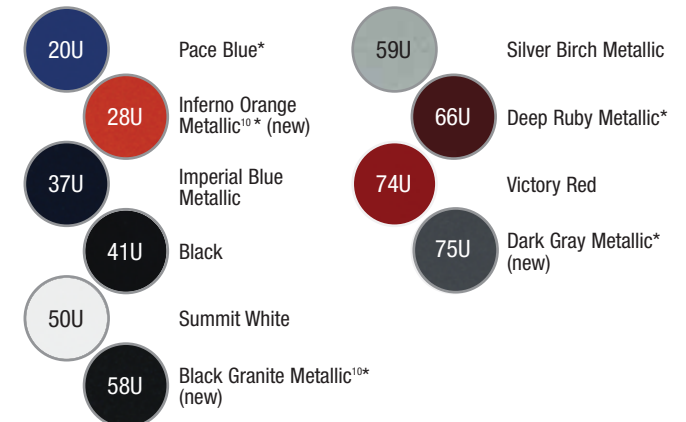

* Not available on Work Truck



OVERVIEW

GMC Canyon delivers on Professional Grade with power, comfort, cargo room⁴ and a wide range of standard and optional features. It's the midsize pickup truck suited for fleet and commercial buyers.

Engine Availability

- 2.9L DOHC L4 with 185 horsepower (not available in California or NE states with emission codes)
- 3.7L DOHC L5 with 242 horsepower

NEW FOR 2008

- OnStar 1-year Safe & Sound Plan² standard (fleet delete available)
- New Glass Package
- Trailering Package is factory installed with increased capacity

SPECIFICATIONS

Model	Box Length (feet)	Model Number/Drivetrain	Wheelbase (inches)	GVWR ⁵ (pounds)	Payload ⁶ (pounds)	Maximum Trailer Weight ⁷ (pounds)	Seating
Regular Cab	6	TS15403/RWD	111.3	4850	1547	4000	3
	6	TT15403/4WD	111.3	5150	1535	4000	3
Extended Cab	6	TS15653/RWD	126.0	5000	1532	5500	5
	6	TT15653/4WD	126.0	5300	1523	5500	5
Crew Cab	5	TS15643/RWD	126.0	5000	1316	5500	6
	5	TT15643/4WD	126.0	5300	1338	5500	6

SELECTED STANDARD FEATURES

Safety and Security

- Front air bags with Passenger Sensing System¹
- 3-point safety belts, all positions except front center
- PASSlock theft-deterrent system
- Daytime Running Lamps and automatic lamp control
- OnStar 1-year Safe & Sound Plan² (fleet delete available)
- Tire Pressure Monitoring System⁹

Mechanical

- 5-speed manual transmission (not available in California and NE states with emission codes)
- Front disc/rear drum antilock brake system
- Insta-Trac 4-wheel drive (4WD)
- Front independent and rear leaf spring suspension
- Power rack-and-pinion steering
- Heavy-duty battery

Interior

- 60/40 split-bench front seat
- Air conditioning
- Driver Information Center
- Tilt adjustable steering column
- AM/FM stereo with digital clock

Exterior

- Intermittent windshield wipers
- Foldaway rearview mirrors
- Pickup box with 2-position tailgate (locking on Crew Cab)



Shown with optional equipment

SELECTED OPTIONAL FEATURES

- Head curtain side-impact air bags¹
- Seating options: front reclining bucket seats, leather seating surfaces, heated, power lumbar, 8-way driver power, 6-way front passenger power
- Inside rearview auto-dimming mirror with compass and outside temperature display
- Power windows and locks
- Rear sliding window
- Audio options: CD and MP3 players, 6-disc CD changer, XM Satellite Radio³
- 4-speed automatic transmission
- Z71 Suspension
- Automatic locking rear differential
- Traction control (2WD)
- 15-inch aluminum wheels
- Remote Keyless Entry
- Power sunroof (Extended and Crew Cab only)

AVAILABLE EXTERIOR COLORS¹⁵

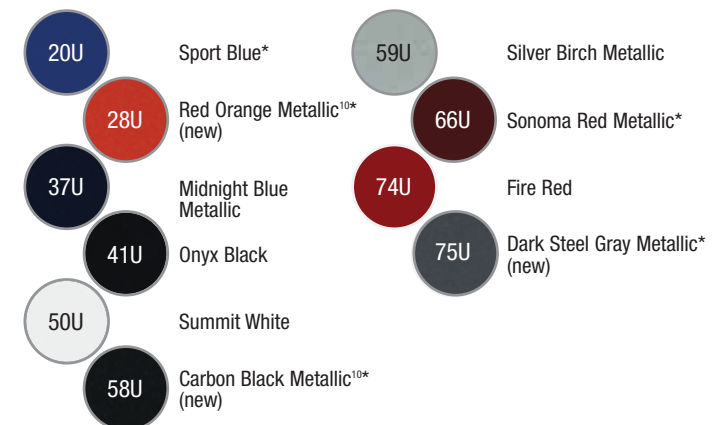

* Not available on 1SA Work Truck



OVERVIEW

For 2008, Chevrolet Silverado continues to delight fleet owners with its comfort, capability and dependability. This new full-size pickup was awarded the *Motor Trend* Truck of the Year™ for 2007.

Engine Availability

- Vortec 4.3L V6 with 195 horsepower
- Vortec 4.8L V8 with 295 horsepower
- Vortec 5.3L V8 with 315 horsepower and Active Fuel Management™; available FlexFuel
- Vortec 6.0L V8 with 367 horsepower and Active Fuel Management™

NEW FOR 2008

- XM Satellite Radio³ standard (fleet delete available)
- Integrated trailer brake controller available

SPECIFICATIONS

Model	Box Length (feet)	Model Number/ Drivetrain	Wheelbase (inches)	GVWR ⁵ (pounds)	Payload ⁶ (pounds)	Maximum Trailer Weight ⁷ (pounds)	Seating
Regular Cab	6.5	CC10703/RWD	119.0	6400	1952	8200	3
	6.5	CK10703/4WD	119.0	6400	1713	8900	3
	8.0	CC10903/RWD	133.0	6400	1812	8000	3
	8.0	CK10903/4WD	133.0	6400	1564	8900	3
Extended Cab	5.7	CC10553/RWD	133.9	6400	1657	8900	6
	5.7	CK10553/4WD	133.9	6800	1564	8600	6
	6.5	CC10753/RWD	143.5	6400	1603	10300	6
	6.5	CK10753/4WD	143.5	7000	1735	10500	6
	8.0	CC10953/RWD	157.5	6900	1687	7500	6
	8.0	CK10953/4WD	157.5	7000	1574	8300	6
Crew Cab	5.7	CC10543/RWD	143.5	6800	1658	10200	6
	5.7	CK10543/4WD	143.5	7000	1629	10500	6

SELECTED STANDARD FEATURES

Safety and Security

- Frontal air bags with Passenger Sensing System¹
- Daytime Running Lamps and automatic lamp control
- OnStar 1-year Safe & Sound Plan² (fleet delete available)
- Tire Pressure Monitoring System⁹

Interior

- Reclining front split-bench seat
- Rear bench fold-up seat (Extended and Crew Cab)
- Tilt adjustable steering column
- AM/FM stereo with CD/MP3, XM Satellite Radio³ (fleet delete available)
- Driver Information Center

Mechanical

- 4-speed automatic transmission
- Front disc/rear drum antilock brake system
- Independent front and multileaf rear suspension
- Power rack and pinion steering
- Heavy-duty battery with rundown protection and retained accessory power

Exterior

- Intermittent windshield wipers
- Foldaway rearview mirrors
- P245/70R17 all-season tires
- 6-lug steel wheels with center caps
- Stainless steel exhaust system



Shown with optional equipment

SELECTED OPTIONAL FEATURES

- Head curtain side-impact air bags¹
- StabiliTrak[®] stability enhancement system
- Seating options: power, buckets, leather seating surfaces, heated, lumbar control
- Cruise control
- Air conditioning
- Power adjustable pedals
- Power rear sliding window
- Audio options: 6-disc CD changer, navigation system,¹¹ Bose system, DVD entertainment system
- Autotrac 4WD
- Automatic locking rear differential
- Trailing packages
- Cargo management system
- Outside mirror options: camper, power, heated, curb-tilt, turn signals
- Aluminum wheels
- Remote Vehicle Starter System
- EZ-Lift Tailgate Package
- Ultrasonic Rear Parking Assist
- Heated windshield washer fluid
- Rainsense[™] wipers
- Skid Plate Package
- Snow Plow Prep Package

AVAILABLE EXTERIOR COLORS¹⁵





SELECTED STANDARD FEATURES

Safety and Security

- Frontal air bags¹
- Daytime Running Lamps and automatic lamp control
- OnStar 1-year Safe & Sound Plan² (fleet delete available)
- Tire Pressure Monitoring System³

Interior

- Reclining front split-bench seat
- Rear bench fold-up seat (Extended and Crew Cab)
- Tilt adjustable steering column
- AM/FM stereo with CD/MP3, XM Satellite Radio³ (fleet delete available)
- Driver Information Center
- Overhead console

Mechanical

- 6-speed automatic transmission
- 4-wheel disc antilock brake system
- Independent front and multileaf rear suspension
- Power steering
- Heavy-duty battery with rundown protection and retained accessory power

Exterior

- Intermittent windshield wipers
- Foldaway rearview mirrors
- All-season or on-/off-road tires
- 8-lug steel wheels with center caps
- Dual cargo area lamps



SELECTED OPTIONAL FEATURES

- Seating options: power, buckets, leather seating surfaces, heated, lumbar control
- Cruise control
- Air conditioning
- Power adjustable pedals
- Power rear sliding window
- Audio options: 6-disc CD changer, navigation system,¹¹ Bose system, DVD entertainment system
- Allison 1000 6-speed automatic transmission (with Duramax)
- Z71 Suspension
- Electronic shift 4WD
- High idle switch
- Automatic locking rear differential
- Trailing packages
- Integrated trailer brake controller
- Cargo management system
- Outside mirror options: camper, power, heated, curb-tilt, turn signals
- Aluminum wheels
- Remote Vehicle Starter System
- EZ-Lift Tailgate Package
- Ultrasonic Rear Parking Assist
- Pickup box delete
- Skid Plate Package
- Snow Plow Prep Package

OVERVIEW

Chevrolet Silverado Heavy Duty 2500HD and 3500HD are the workhorses of the lineup. Available with a gas or diesel engine, they offer payload⁴ and towing for any job site requirement.

Engine Availability

- Vortec 6.0L V8 with 353 hp (312 hp with 3500HD and 11,400 GVWR⁵)
- Duramax 6.6L Turbo Diesel V8 with 365 horsepower, 660 lb.-ft. of torque; Bio-Diesel compatible

NEW FOR 2008

- XM Satellite Radio³ standard (fleet delete available)
- High idle switch available
- 17-in. wheels and tires standard on dual rear wheel models

SPECIFICATIONS

Model	Box Length (feet)	Model Number/Drivetrain	Wheelbase (inches)	GVWR ⁵ (pounds)	Payload ⁶ (pounds)	Maximum Trailer Weight ⁷ (pounds)	Seating
Regular Cab	8.0	CC20903/RWD	133.0	9200	3892	12900	3
	8.0	CK20903/4WD	133.0	9200	3646	12700	3
(SRW w/box delete)	8.0	CC30903/RWD	133.0	9700	4608	NA	3
(SRW/DRW)	8.0	CK30903/4WD	133.0	9900/11400	3963/5307	12700/12200	3
Extended Cab	6.5	CC20753/RWD	143.5	9200	3604	12700	6
	6.5	CK20753/4WD	143.5	9200	3353	12400	6
	8.0	CC20953/RWD	157.5	9200	3465	12500	6
	8.0	CK20953/4WD	157.5	9200	3194	12200	6
(SRW/DRW)	8.0	CC30953/RWD	157.5	9900/11400	4277/5127	12200/12000	6
(SRW/DRW)	8.0	CK30953/4WD	157.5	9900/11400	3629/4863	12000/11700	6
Crew Cab	6.5	CC20743/RWD	153.0	9200	3458	12500	6
	6.5	CK20743/4WD	153.0	9200	3217	12300	6
	8.0	CC20943/RWD	167.0	9200	3301	12400	6
	8.0	CK20943/4WD	167.0	9200	3031	12100	6
(SRW/DRW)	8.0	CC30943/RWD	167.0	9900/11400	3855/4979	12100/11800	6
(SRW/DRW)	8.0	CK30943/4WD	167.0	9900/11400	3464/4706	11800/11600	6

AVAILABLE EXTERIOR COLORS¹⁵

- 12U Dark Cherry Metallic (new)
- 16U Graystone Metallic
- 25U Dark Blue Metallic
- 41U Black
- 46U Blue Granite Metallic
- 50U Summit White
- 59U Silver Birch Metallic
- 66U Deep Ruby Metallic (new)
- 74U Victory Red
- 81U Desert Brown Metallic



OVERVIEW

For 2008, GMC Sierra continues its Professional Grade capability, along with a luxurious interior. The broad lineup of body styles and powertrains provides a Sierra for any fleet owner requirement.

Engine Availability

- Vortec 4.3L V6 with 195 horsepower
- Vortec 4.8L V8 with 295 horsepower
- Vortec 5.3L V8 with 315 horsepower and Active Fuel Management™; available FlexFuel
- Vortec 6.0L V8 with 367 horsepower and Active Fuel Management™

NEW FOR 2008

- XM Satellite Radio³ standard (fleet delete available)
- Integrated trailer brake controller available

SPECIFICATIONS

Model	Box Length (feet)	Model Number/ Drivetrain	Wheelbase (inches)	GVWR ⁵ (pounds)	Payload ⁶ (pounds)	Maximum Trailer Weight ⁷ (pounds)	Seating
Regular Cab	6.5	TC10703/RWD	119.0	6400	1952	8200	3
	6.5	TK10703/4WD	119.0	6400	1713	8900	3
	8.0	TC10903/RWD	133.0	6400	1812	8000	3
	8.0	TK10903/4WD	133.0	6400	1564	8900	3
Extended Cab	5.7	TC10553/RWD	133.9	6400	1657	8900	6
	5.7	TK10553/4WD	133.9	6800	1564	8600	6
	6.5	TC10753/RWD	143.5	6400	1603	10300	6
	6.5	TK10753/4WD	143.5	7000	1735	10500	6
	8.0	TC10953/RWD	157.5	6900	1687	7500	6
	8.0	TK10953/4WD	157.5	7000	1574	8300	6
Crew Cab	5.7	TC10543/RWD	143.5	6800	1658	10200	6
	5.7	TK10543/4WD	143.5	7000	1629	10500	6

SELECTED STANDARD FEATURES

Safety and Security

- Frontal air bags with Passenger Sensing System¹
- Daytime Running Lamps and automatic lamp control
- OnStar 1-year Safe & Sound Plan² (fleet delete available)
- Tire Pressure Monitoring System⁸

Interior

- Reclining front split-bench seat
- Rear bench fold-up seat (Extended and Crew Cab)
- Tilt adjustable steering column
- AM/FM stereo with CD/MP3, XM Satellite Radio³ (fleet delete available)
- Driver Information Center

Mechanical

- 4-speed automatic transmission
- Front disc/rear drum antilock brake system
- Independent front and multileaf rear suspension
- Power rack and pinion steering
- Heavy-duty battery with rundown protection and retained accessory power

Exterior

- Intermittent windshield wipers
- Foldaway rearview mirrors
- P245/70R17 all-season tires
- 6-lug steel wheels with center caps
- Stainless steel exhaust system



Shown with optional equipment

SELECTED OPTIONAL FEATURES

- Head curtain side-impact air bags¹
- StabiliTrak[®] stability enhancement system
- Seating options: power, buckets, leather seating surfaces, heated, lumbar control
- Cruise control
- Air conditioning
- Power adjustable pedals
- Power rear sliding window
- Audio options: 6-disc CD changer, navigation system,¹¹ Bose system, DVD entertainment system
- Autotrac 4WD
- Automatic locking rear differential
- Trailing packages
- Cargo management system
- Outside mirror options: camper, power, heated, curb-tilt, turn signals
- Aluminum wheels
- Remote Vehicle Starter System
- EZ-Lift Tailgate Package
- Ultrasonic Rear Parking Assist
- Heated windshield washer fluid
- Rainsense[™] wipers
- Skid Plate Package
- Snow Plow Prep Package

AVAILABLE EXTERIOR COLORS¹⁵

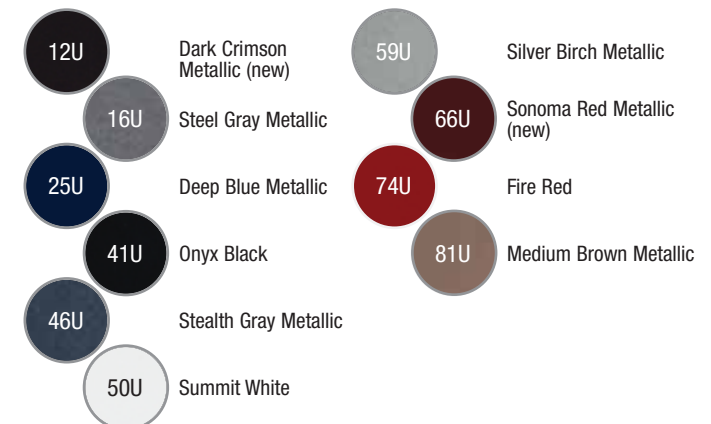



OVERVIEW

GMC Sierra Heavy Duty 2500HD and 3500HD are the workhorses of the lineup. Available with a gas or diesel engine, they offer payload⁴ and towing for any Professional Grade requirement.

Engine Availability

- Vortec 6.0L V8 with 353 hp (312 hp with 3500HD and 11,400 GVWR⁵)
- Duramax 6.6L Turbo Diesel V8 with 365 horsepower, 660 lb.-ft. of torque; Bio-Diesel compatible

NEW FOR 2008

- XM Satellite Radio³ standard (fleet delete available)
- High idle switch available
- 17-in. wheels and tires standard on dual rear wheel models

SPECIFICATIONS

Model	Box Length (feet)	Model Number/Drivetrain	Wheelbase (inches)	GVWR ⁵ (pounds)	Payload ⁶ (pounds)	Maximum Trailer Weight ⁷ (pounds)	Seating
Regular Cab	8.0	TC20903/RWD	133.0	9200	3892	12900	3
	8.0	TK20903/4WD	133.0	9200	3646	12700	3
	(SRW w/box delete)	TC30903/RWD	133.0	9700	4608	NA	3
Extended Cab	(SRW/DRW)	TK30903/4WD	133.0	9900/11400	3963/5307	12700/12200	3
	6.5	TC20753/RWD	143.5	9200	3604	12700	6
	6.5	TK20753/4WD	143.5	9200	3353	12400	6
	8.0	TC20953/RWD	157.5	9200	3465	12500	6
	8.0	TK20953/4WD	157.5	9200	3194	12200	6
	(SRW/DRW)	TC30953/RWD	157.5	9900/11400	4277/5127	12200/12000	6
Crew Cab	(SRW/DRW)	TK30953/4WD	157.5	9900/11400	3629/4863	12000/11700	6
	6.5	TC20743/RWD	153.0	9200	3458	12500	6
	6.5	TK20743/4WD	153.0	9200	3217	12300	6
	8.0	TC20943/RWD	167.0	9200	3301	12400	6
	8.0	TK20943/4WD	167.0	9200	3031	12100	6
	(SRW/DRW)	TC30943/RWD	167.0	9900/11400	3855/4979	12100/11800	6
(SRW/DRW)	TK30943/4WD	167.0	9900/11400	3464/4706	11800/11600	6	

SELECTED STANDARD FEATURES

Safety and Security

- Frontal air bags¹
- Daytime Running Lamps and automatic lamp control
- OnStar 1-year Safe & Sound Plan² (fleet delete available)
- Tire Pressure Monitoring System⁹

Interior

- Reclining front split-bench seat
- Rear bench fold-up seat (Extended and Crew Cab)
- Tilt adjustable steering column
- AM/FM stereo with CD/MP3, XM Satellite Radio³ (fleet delete available)
- Driver Information Center
- Overhead console

Mechanical

- 6-speed automatic transmission
- 4-wheel disc antilock brake system
- Independent front and multileaf rear suspension
- Power steering
- Heavy-duty battery with rundown protection and retained accessory power

Exterior

- Intermittent windshield wipers
- Foldaway rearview mirrors
- All-season or on-/off-road tires
- 8-lug steel wheels with center caps
- Dual cargo area lamps



SELECTED OPTIONAL FEATURES

- Seating options: power, buckets, leather seating surfaces, heated, lumbar control
- Cruise control
- Air conditioning
- Power adjustable pedals
- Power rear sliding window
- Audio options: 6-disc CD changer, navigation system,¹¹ Bose system, DVD entertainment system
- Allison 1000 6-speed automatic transmission (with Duramax)
- Electronic shift 4WD
- High idle switch
- Automatic locking rear differential
- Trailering packages
- Integrated trailer brake controller
- Cargo management system
- Outside mirror options: camper, power, heated, curb-tilt, turn signals
- Aluminum wheels
- Remote Vehicle Starter System
- EZ-Lift Tailgate Package
- Ultrasonic Rear Parking Assist
- Pickup box delete
- Skid Plate Package
- Snow Plow Prep Package

AVAILABLE EXTERIOR COLORS¹⁵

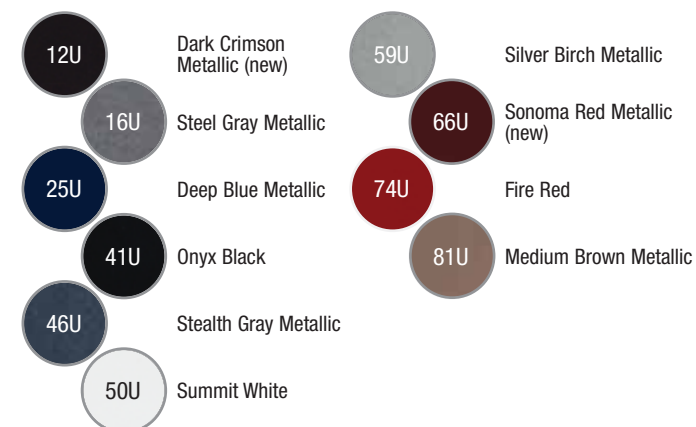



OVERVIEW

The Sierra Denali features a stunning combination of advanced engineering and luxurious interior appointments. The exterior includes the distinctive Denali grille and 18-inch polished aluminum wheels. The high-output engine delivers 403 horsepower.

Engine Availability

- Vortec high-output 6.2L V8 with 403 horsepower and 417 lb.-ft. of torque

SELECTED STANDARD FEATURES

Safety and Security

- Frontal air bags and head curtain side-impact air bags¹ with rollover sensor
- Daytime Running Lamps with automatic lamp control
- StabiliTrak[®] stability enhancement system
- OnStar 1-year Safe & Sound Plan²
- Tire Pressure Monitoring System⁹

Interior

- Full-feature leather-appointed front bucket seats, console
- Power adjustable pedals
- AM/FM stereo with MP3/6-disc CD player, Bose system, rear controls, XM Satellite Radio,³ steering wheel controls
- Driver Information Center
- Auto-dimming rearview mirror, compass, outside temperature
- Dual-zone automatic climate control

Mechanical

- 6-speed automatic transmission with Tow/Haul mode
- Automatic all-wheel drive system (AWD)
- 4-wheel disc antilock brake system
- Locking rear differential
- Heavy-duty trailering equipment

Exterior

- Heated windshield wiper fluid
- Rainsense[™] windshield wipers
- Heated, power-fold rearview mirrors with turn signals, ground illumination, curb-tilt
- P265/65R18 all-season tires
- Polished aluminum wheels
- Remote Vehicle Starter System
- Ultrasonic Rear Parking Assist
- EZ-Lift Tailgate Package

SELECTED OPTIONAL FEATURES

- Heated steering wheel
- Audio options: navigation system,¹¹ DVD entertainment system
- Power sunroof
- Cargo Management System
- Power sliding rear window
- 20-inch wheels¹⁴ and chrome aluminum wheels



SPECIFICATIONS

Model	Box Length (feet)	Model Number/ Drivetrain	Wheelbase (inches)	GVWR ⁵ (pounds)	Payload ⁶ (pounds)	Maximum Trailer Weight ⁷ (pounds)	Seating
Crew Cab	5.7	TC10543/RWD	143.5	6800	1618	8600	6
	5.7	TK10543/AWD	143.5	7000	1617	8400	6

AVAILABLE EXTERIOR COLORS¹⁵

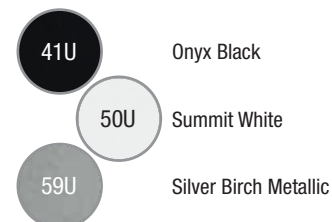

SELECTED STANDARD FEATURES
Safety and Security

- Front air bags with Passenger Sensing System¹
- 3-point safety belts, all positions except front center
- PASSlock theft-deterrent system
- Daytime Running Lamps and automatic lamp control
- Tire Pressure Monitoring System⁹

Interior

- 60/40 split-bench front seat
- Air conditioning
- Driver Information Center
- Tilt adjustable steering column
- 2 auxiliary power outlets
- AM/FM stereo with digital clock
- Cruise control

Mechanical

- 4-speed automatic transmission
- Front disc/rear drum antilock brake system
- Front independent and rear leaf spring suspension
- Z71 Off-Road Suspension
- Power rack-and-pinion steering
- Heavy-duty battery

Exterior

- Intermittent windshield wipers
- Foldaway rearview mirrors
- 2 front frame-mounted recovery hooks
- P235/75R15 all-season tires

SELECTED OPTIONAL FEATURES

- Head curtain side-impact air bags¹
- Audio options: CD and MP3 players
- 5-speed manual transmission
- Automatic locking rear differential
- Traction control
- Fog lamps
- Solar-Ray deep-tinted window glass

OVERVIEW

Chevrolet Colorado Chassis Cab gives commercial truck buyers a solid platform to meet their vocational needs. Instead of a pickup box, the chassis cab model allows specific boxes or platforms to be installed by a third-party source.

Engine Availability

- 3.7L DOHC L5 with 242 horsepower

NEW FOR 2008

- 4WD is available
- Uplevel trim available

Vehicles shown have been altered or upfitted with equipment supplied by independent suppliers. See Owner Manual for information on alterations and warranties.

SPECIFICATIONS

Model	Box Length (feet)	Model Number/Drivetrain	Wheelbase (inches)	GVWR ⁵ (pounds)	Payload ⁶ (pounds)	Maximum Trailer Weight ⁷ (pounds)	Seating
Regular Cab	RWD	CS15603	126.0	5300	1996	4000	3
	4WD	CT15603	126.0	5300	1855	4000	3

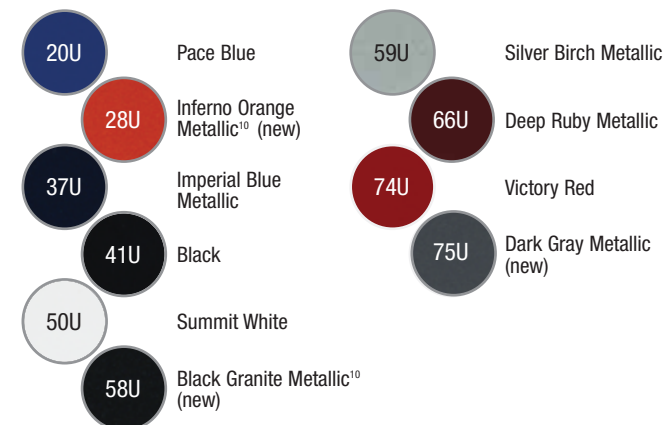
AVAILABLE EXTERIOR COLORS¹⁵



ASTRO BODY

SELECTED FEATURES

Astro Body

- Doors on both sides and rear include gas struts for ease of opening and closing
- Molded-in step well on curb side door gives access to front of work area
- Interior safety release latches on each door
- 5/8-inch FRP floor with steel understructure
- Dutch-style rear doors allow ease of access
- OEM door handles with ignition key coded lock cylinders
- Interior camera screen operates in reverse gear for rearward visibility

Mid Box and Topper

- Door locks on both sides for secure storage
- Mounts across the back of the cab and is accessible from both sides of vehicle
- Allows for separation of chemicals between box and bed
- Contoured double-paneled doors for strength and integrated styling
- Door handles and locks match the cab for finished look
- Heavy-duty door seals make the interior weather- and dust-resistant

SELECTED OPTIONAL FEATURES

Astro Body

- Bin packages
- Floor mat
- Custom ladder racks

Mid Box

- Roll-out drawers secure cargo in rough terrain
- Dome lights
- Toppers available with single or double ladder racks and PVC tub
- Bedliner
- Auxiliary power outlet

OVERVIEW

Chevrolet Colorado Chassis Cab equipped with an Astro Body, produced by Supreme Corporation, provides utility and interior space in a lightweight package.

Colorado Chassis Cab can also be ordered with a ship-thru to Decoma providing a Mid Box with secure and convenient storage accessible from both sides of the truck.

Both options allow buyers to easily order vehicles to suit their commercial needs.

NEW FOR 2008

- 4WD available on Astro Body
- Uplevel trim available on Astro Body

Vehicles shown have been altered or upfitted with equipment supplied by independent suppliers. See Owner Manual for information on alterations and warranties.



MID BOX

SPECIFICATIONS

Model	Overall height/width (inches)	Overall length (inches)	Interior height (inches)	Interior length (inches)	Interior volume ⁴ (cubic feet)	Step in height (inches)	Rear door opening (w x h, inches)
Astro Body	78/77.5	210.7	47.7	82	173.7	31.3	48.5 x 40.5

Model	Overall height (inches)	Overall width (inches)	Overall depth (inches)	Mid Box cargo weight cap. ⁴ (pounds)	Mid Box volume ⁴ (cubic feet)	Total volume ⁴ (cubic feet)	Mid box door opening (w x h, inches)
Mid Box	26	60	24	500	20	125	24 x 22

AVAILABLE EXTERIOR COLORS¹⁵

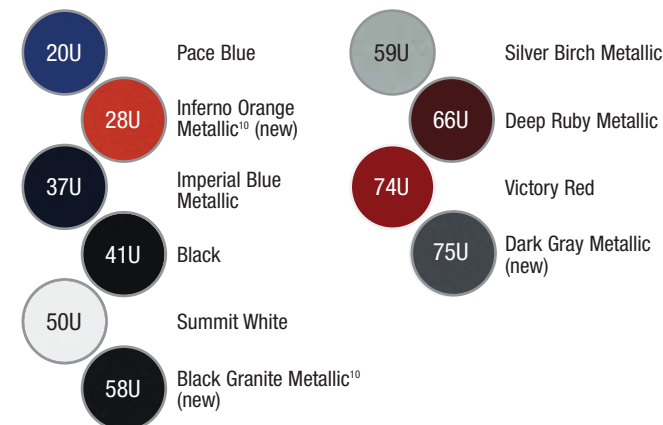



SELECTED STANDARD FEATURES

Safety and Security

- Frontal air bags with passenger-side deactivation switch¹
- Daytime Running Lamps and automatic lamp control
- OnStar 1-year Safe & Sound Plan² (fleet delete available)

Interior

- Reclining front split-bench seat
- Rear bench fold-up seat (Extended Cab)
- Tilt adjustable steering column
- AM/FM stereo with CD/MP3, XM Satellite Radio³ (fleet delete available)
- Driver Information Center
- Overhead console

Mechanical

- 6-speed automatic transmission
- 4-wheel disc antilock brake system
- Independent front and multileaf rear suspension
- Power steering
- Heavy-duty battery

Exterior

- Intermittent windshield wipers
- Smoked amber roof marker lamps
- Foldaway rearview mirrors
- Dual rear wheels with LT225/75R17 all-season tires
- 8-lug steel wheels with center caps

SELECTED OPTIONAL FEATURES

- Seating options: power, buckets, leather seating surfaces, lumbar control
- Cruise control
- Air conditioning
- Power adjustable pedals
- Power rear sliding window
- Audio options: 6-disc CD changer, Bose system
- Allison 1000 6-speed automatic transmission (with Duramax)
- PTO control (with Duramax)
- Electronic shift 4WD
- High idle switch
- Integrated trailer brake controller
- Automatic locking rear differential
- Outside mirror options: camper, power, heated, turn signals
- Remote Vehicle Starter System
- Heated windshield washer fluid
- Skid Plate Package
- Snow Plow Prep Package



OVERVIEW

Chevrolet Silverado 3500HD Chassis Cab offers two- or four-wheel drive, Regular or Extended Cab, gas or diesel engine — all ready to be upfitted with specific vocational bodies.

Engine Availability

- Vortec 6.0L V8 with 312 horsepower
- Duramax 6.6L Turbo Diesel V8 with 365 horsepower, 660 lb.-ft. of torque; Bio-Diesel compatible

NEW FOR 2008

- XM Satellite Radio³ standard (fleet delete available)
- High idle switch available
- 17-in. wheels and tires standard

Vehicles shown have been altered or upfitted with equipment supplied by independent suppliers. See Owner Manual for information on alterations and warranties.

SPECIFICATIONS

Model	Box Length (feet)	Model Number/Drivetrain	Wheelbase (inches)	GVWR ⁵ (pounds)	Payload ⁶ (pounds)	Maximum Trailer Weight ⁷ (pounds)	Seating
Regular Cab	RWD	CC31003	137.0	11400	5655	NA	3
		CK31003	137.0	12000	6001	NA	3
	4WD	CC31403	161.5	11400	5569	NA	3
		CK31403	161.5	12000	5954	NA	3
Extended Cab	RWD	CC31053	161.5	11400	5151	NA	6
	4WD	CK31053	161.5	12000	5475	NA	6

AVAILABLE EXTERIOR COLORS¹⁵





OVERVIEW

GMC Canyon Chassis Cab gives commercial truck buyers a solid platform to meet their vocational needs. Instead of a pickup box, the chassis cab model allows specific boxes or platforms to be installed by a third-party source.

Engine Availability

- 3.7L DOHC L5 with 242 horsepower

NEW FOR 2008

- 4WD is available
- Uplevel trim available

Vehicles shown have been altered or upfitted with equipment supplied by independent suppliers. See Owner Manual for information on alterations and warranties.

SPECIFICATIONS

Model	Box Length (feet)	Model Number/Drivetrain	Wheelbase (inches)	GVWR ⁵ (pounds)	Payload ⁶ (pounds)	Maximum Trailer Weight ⁷ (pounds)	Seating
Regular Cab	RWD	TS15603	126.0	5300	1996	4000	3
	4WD	TT15603	126.0	5300	1855	4000	3

SELECTED STANDARD FEATURES

Safety and Security

- Front air bags with Passenger Sensing System¹
- 3-point safety belts, all positions except front center
- PASSLock theft-deterrent system
- Daytime Running Lamps and automatic lamp control
- Tire Pressure Monitoring System⁹

Interior

- 60/40 split-bench front seat
- Air conditioning
- Driver Information Center
- Tilt adjustable steering column
- 2 auxiliary power outlets
- AM/FM stereo with digital clock
- Cruise control

Mechanical

- 4-speed automatic transmission
- Front disc/rear drum antilock brake system
- Front independent and rear leaf spring suspension
- Z71 Off-Road Suspension
- Power rack-and-pinion steering
- Heavy-duty battery

Exterior

- Intermittent windshield wipers
- Foldaway rearview mirrors
- 2 front frame-mounted recovery hooks
- P235/75R15 all-season tires



SELECTED OPTIONAL FEATURES

- Head curtain side-impact air bags¹
- Audio options: CD and MP3 players
- 5-speed manual transmission
- Automatic locking rear differential
- Traction control
- Fog lamps
- Solar-Ray deep-tinted window glass

AVAILABLE EXTERIOR COLORS¹⁵

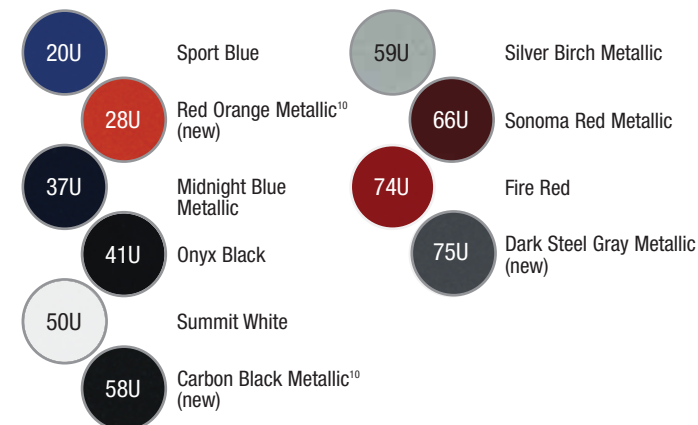



ASTRO BODY

OVERVIEW

GMC Canyon Chassis Cab equipped with an Astro Body, produced by Supreme Corporation, provides utility and interior space in a lightweight package.

Canyon Chassis Cab can also be ordered with a ship-thru to Decoma providing a Mid Box with secure and convenient storage accessible from both sides of the truck.

Both options allow buyers to easily order vehicles to suit their commercial needs.

NEW FOR 2008

- 4WD available on Astro Body
- Uplevel trim available on Astro Body

Vehicles shown have been altered or upfitted with equipment supplied by independent suppliers. See Owner Manual for information on alterations and warranties.

SPECIFICATIONS

Model	Overall height/width (inches)	Overall length (inches)	Interior height (inches)	Interior length (inches)	Interior volume ⁴ (cubic feet)	Step in height (inches)	Rear door opening (w x h, inches)
Astro Body	78/77.5	210.7	47.7	82	173.7	31.3	48.5 x 40.5

Model	Overall height (inches)	Overall width (inches)	Overall depth (inches)	Mid Box cargo weight cap. ⁴ (pounds)	Mid Box volume ⁴ (cubic feet)	Total volume ⁴ (cubic feet)	Mid box door opening (w x h, inches)
Mid Box	26	60	24	500	20	125	24 x 22

SELECTED FEATURES

Astro Body

- Doors on both sides and rear include gas struts for ease of opening and closing
- Molded-in step well on curb side door gives access to front of work area
- Interior safety release latches on each door
- 5/8-inch FRP floor with steel understructure
- Dutch-style rear doors allow ease of access
- OEM door handles with ignition key coded lock cylinders
- Interior camera screen operates in reverse gear for rearward visibility

Mid Box and Topper

- Door locks on both sides for secure storage
- Mounts across the back of the cab and is accessible from both sides of vehicle
- Allows for separation of chemicals between box and bed
- Contoured double-paneled doors for strength and integrated styling
- Door handles and locks match the cab for finished look
- Heavy-duty door seals make the interior weather- and dust-resistant



MID BOX

SELECTED OPTIONAL FEATURES

Astro Body

- Bin packages
- Floor mat
- Custom ladder racks

Mid Box

- Roll-out drawers secure cargo in rough terrain
- Dome lights
- Toppers available with single or double ladder racks and PVC tub
- Bedliner
- Auxiliary power outlet

AVAILABLE EXTERIOR COLORS¹⁵

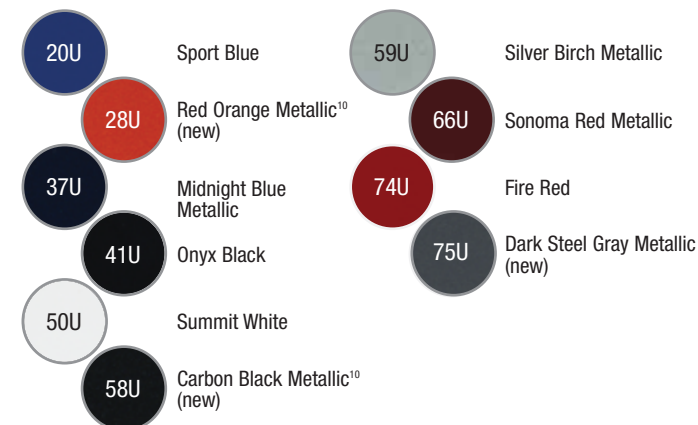



OVERVIEW

GMC Sierra 3500HD Chassis Cab offers two- or four-wheel drive, Regular or Extended Cab, gas or diesel engine — all ready to be upfitted with specific vocational bodies.

Engine Availability

- Vortec 6.0L V8 with 312 horsepower
- Duramax 6.6L Turbo Diesel V8 with 365 horsepower, 660 lb.-ft. of torque; Bio-Diesel compatible

NEW FOR 2008

- XM Satellite Radio³ standard (fleet delete available)
- High idle switch available
- 17-in. wheels and tires standard

Vehicles shown have been altered or upfitted with equipment supplied by independent suppliers. See Owner Manual for information on alterations and warranties.

SPECIFICATIONS

Model	Drivetrain	Model Number/ Drivetrain	Wheelbase (inches)	GVWR ⁵ (pounds)	Payload ⁶ (pounds)	Maximum Trailer Weight ⁷ (pounds)	Seating
Regular Cab	RWD	TC31003	137.0	11400	5655	NA	3
	4WD	TK31003	137.0	12000	6001	NA	3
	RWD	TC31403	161.5	11400	5569	NA	3
	4WD	TK31403	161.5	12000	5954	NA	3
Extended Cab	RWD	TC31053	161.5	11400	5151	NA	6
	4WD	TK31053	161.5	12000	5475	NA	6

SELECTED STANDARD FEATURES

Safety and Security

- Frontal air bags with passenger-side deactivation switch¹
- Daytime Running Lamps and automatic lamp control
- OnStar 1-year Safe & Sound Plan² (fleet delete available)

Interior

- Reclining front split-bench seat
- Rear bench fold-up seat (Extended Cab)
- Tilt adjustable steering column
- AM/FM stereo with CD/MP3, XM Satellite Radio³ (fleet delete available)
- Driver Information Center
- Overhead console

Mechanical

- 6-speed automatic transmission
- 4-wheel disc antilock brake system
- Independent front and multileaf rear suspension
- Power steering
- Heavy-duty battery

Exterior

- Intermittent windshield wipers
- Smoked amber roof marker lamps
- Foldaway rearview mirrors
- Dual rear wheels with LT225/75R17 all-season tires
- 8-lug steel wheels with center caps



Shown with optional equipment

SELECTED OPTIONAL FEATURES

- Seating options: power, buckets, leather seating surfaces, lumbar control
- Cruise control
- Air conditioning
- Power adjustable pedals
- Power rear sliding window
- Audio options: 6-disc CD changer, Bose system
- Allison 1000 6-speed automatic transmission (with Duramax)
- PTO control (with Duramax)
- Electronic shift 4WD
- High idle switch
- Integrated trailer brake controller
- Automatic locking rear differential
- Outside mirror options: camper, power, heated, turn signals
- Remote Vehicle Starter System
- Heated windshield washer fluid
- Skid Plate Package
- Snow Plow Prep Package

AVAILABLE EXTERIOR COLORS¹⁵

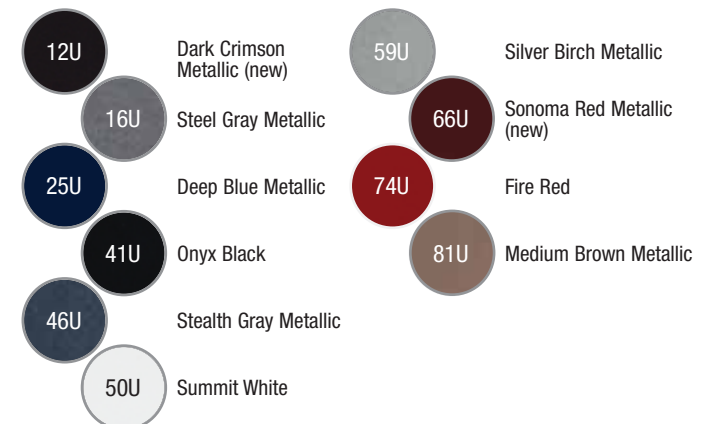



2007 Model Year Shown

SELECTED STANDARD FEATURES

Safety and Security

- Dual-stage front air bags¹
- OnStar 1-year Safe & Sound Plan² (fleet delete available)
- Rear child security door locks
- LATCH (Lower Anchors and Top tethers for CHildren) system
- StabiliTrak[®] stability enhancement system
- PASS-Key III theft-deterrent system
- Daytime Running Lamps and automatic lamp control
- Tire Pressure Monitoring System⁹

Interior

- 7-passenger seating
- Front reclining bucket seats
- 2nd-row reclining, removable bucket seats
- 3rd-row 50/50 split-folding bench seat
- Air conditioning
- Power programmable door locks
- Tilt adjustable steering column
- Power windows

- AM/FM stereo with CD/MP3, auxiliary input jack
- XM Satellite Radio³ (fleet delete available)

Mechanical

- Front-wheel drive
- 3.9L V6 with 240 hp
- 4-speed automatic transmission
- 4-wheel disc antilock brake system
- 4-wheel independent suspension
- Traction control
- Power rack-and-pinion steering
- Stainless steel exhaust system

Exterior

- Intermittent front windshield wipers
- Halogen headlamps
- Folding, power rearview mirrors
- Manual-sliding driver- and passenger-side doors
- P225/60R17 all-season tires
- Rear liftgate

SELECTED OPTIONAL FEATURES

- Side-impact air bags,¹ 1st- and 2nd-row outboard passengers or driver and front passenger
- Seating options: Captain's chairs with leather seating surfaces; 1st-row power adjustment, heated; 2nd-row integral child seat
- Side-folding front and 2nd-row utility tray
- Driver Information Center
- Cruise control
- Overhead Rail System
- Auxiliary rear air conditioning
- Universal Home Remote
- Audio options: 6-disc CD changer, navigation system,¹¹ steering wheel-mounted controls, rear seat DVD entertainment center
- Power rear quarter vent windows
- FlexFuel capability (no charge)
- Power sliding side doors
- Luggage rack side rails
- Remote Keyless Entry
- Remote Vehicle Starter System
- Aluminum wheels
- Ultrasonic Rear Parking Assist

OVERVIEW

Chevrolet Uplander delivers the styling of an SUV, the passenger room and versatility of a van and the smooth ride of a sedan — all with seating up to seven. Numerous cargo configurations make it ideal for personal and commercial use.

NEW FOR 2008

- Tire Pressure Monitoring System⁹ standard
- XM Satellite Radio³ standard (fleet delete available)
- StabiliTrak[®] stability enhancement system standard
- Traction control standard
- OnStar 1-year Safe & Sound Plan² standard (fleet delete available)
- MP3 capability — standard, auxiliary input jack

MODEL AVAILABILITY

	Regular Wheelbase	Extended Wheelbase
Uplander Passenger Van	CU11416	CU12216

SPECIFICATIONS (inches unless otherwise stated)

Wheelbase	113.0	121.1
Length	191.0	204.3
Width	72.0	72.0
Height	70.5	72.0
Seating f/m/r	2/2/3	2/2/3
Head room f/m/r	39.8/38.9/37.5	39.8/38.9/38.2
Shoulder room f/m/r	59.9/62.0/60.1	59.9/61.2/48.6
Leg room f/m/r	39.9/37.5/34.3	39.9/38.9/36.2
Max. cargo vol. ⁴ (cubic feet)	120.1	136.5
Fuel capacity ⁶ (gallons)	20	25
Max. towing capacity ⁷ (pounds)	2000	3500



2007 Model Year Shown



Shown with optional equipment

AVAILABLE EXTERIOR COLORS¹⁵

- 49U Bordeaux Red Metallic
- 50U Summit White
- 51U Gold Mist Metallic
- 67U Silverstone Metallic
- 81U Desert Brown Metallic
- 87U Slate Metallic (new)



OVERVIEW

Chevrolet Express Passenger Vans have many new features — all aimed at keeping this popular people mover at the forefront of the market.

NEW FOR 2008

- 2500 Series available to all customers
- Head curtain side-impact air bags¹ standard
- StabiliTrak[®] stability enhancement system standard on all models
- Tire Pressure Monitoring System⁹ standard
- Completely new dash with Driver Information Center
- Vortec 5.3L V8 (LMF) standard on 1500 model, with FlexFuel capability available
- Vortec 6.0L V8 (LY6) standard on 2500 and 3500 models
- Enhanced Technology Glass on rear-most rows on 12/15 passenger only
- Shoulder belts for center seats

MODEL AVAILABILITY

	Regular Wheelbase	Extended Wheelbase
G1500 RWD	CG13406	—
G1500 AWD	CH13406	—
G2500 RWD	CG23406	—
G3500 RWD	CG33406	CG33706

SPECIFICATIONS (in. unless otherwise stated)

Wheelbase	135.0	155.0
Length	224.1	244.1
Width	79.4	79.4
Height	81.6	82.0
Seating (maximum)	2/3/3/4	2/3/3/4
Head room	40.2/38.5/38.6/38.1	40.2/38.5/38.6/38.1/38.1
Shoulder room	68.8/68.9/63.5/68.3	68.8/68.9/63.5/68.3/62.7
Leg room	41.3/34.8/37.6/39.8	41.3/34.8/37.6/39.8/36.4
Max. cargo vol. ⁴ (cubic feet)	217.3	252.6
Fuel capacity ⁸ (gallons)	31	31
Max. towing capacity ⁷ (pounds)	6500	7700

New radios are available with CD player, CD/MP3 player, 6-disc CD changer and redundant steering wheel controls.





Shown with optional equipment

SELECTED STANDARD FEATURES

Safety and Security

- Frontal air bags with Passenger Sensing System¹ (deactivation switch only on 2500 and 3500 models)
- Head curtain side-impact air bags¹
- StabiliTrak[®] stability enhancement system
- Child seat anchors
- Pass-Key III theft-deterrent system
- Daytime Running Lamps

Interior

- Front high-back, reclining bucket seats
- 8-passenger seating (1500 model)
- 12-passenger seating (2500 and 3500 models)
- Console with storage, 3 cupholders, 2 power outlets
- Front passenger assist handle
- Air conditioning
- Full-length black rubberized-vinyl floor covering
- AM/FM stereo with digital clock

Mechanical

- Vortec 5.3L V8 with 301 hp (1500 model)
- Vortec 6.0L V8 with 323 hp (2500 and 3500 models)
- Oil Life Monitoring System
- 4-speed automatic transmission with Tow/Haul mode on the instrument panel
- Independent front suspension
- 4-wheel disc antilock brake system
- Power steering
- Battery with rundown protection and retained accessory power

Exterior

- Halogen headlamps
- Intermittent front windshield wipers
- Swing-out 60/40 passenger-side door
- Swing-out rear doors
- Manual rearview mirrors
- P245/75R16 all-season tires
- Stainless steel exhaust system

SELECTED OPTIONAL FEATURES

- Seating options: driver and front passenger power adjustment, cloth seats, 15-passenger seating
- Cruise control
- Tilt adjustable steering column
- Compass and outside temperature display
- Power windows, door locks
- Rear air conditioning/heater
- Full floor color-keyed carpeting
- Audio options: CD player, CD/MP3 player, 6-disc CD changer, steering wheel controls
- FlexFuel capability (5.3L V8)
- Trailering equipment
- Sliding passenger-side door
- Remote Keyless Entry
- Outside heated, power, folding mirrors with turn signals
- LT Package

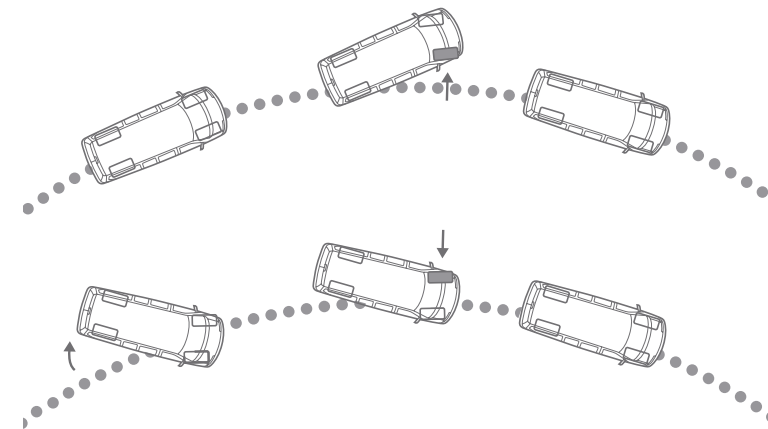

If understeer occurs (top), standard StabiliTrak[®] applies the inside front brake to help correct steering.

If fishtailing occurs (bottom), it applies the outside front brake to help correct steering.

AVAILABLE EXTERIOR COLORS¹⁵

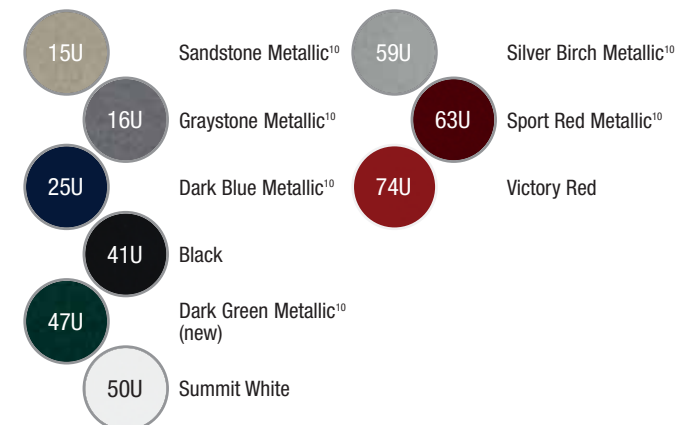



OVERVIEW

GMC Savana Passenger Vans have many new features — all aimed at keeping this popular people mover at the forefront of the market.

NEW FOR 2008

- 2500 Series available to all customers
- Head curtain side-impact air bags¹ standard
- StabiliTrak[®] stability enhancement system standard on all models
- Tire Pressure Monitoring System⁹ standard
- Completely new dash with Driver Information Center
- Vortec 5.3L V8 (LMF) standard on 1500 model, with FlexFuel capability available
- Vortec 6.0L V8 (LY6) standard on 2500 and 3500 models
- Enhanced Technology Glass on rear-most rows on 12/15-passenger only
- Shoulder belts for center seats

MODEL AVAILABILITY

	Regular Wheelbase	Extended Wheelbase
G1500 RWD	TG13406	—
G1500 AWD	TH13406	—
G2500 RWD	TG23406	—
G3500 RWD	TG33406	TG33706

SPECIFICATIONS (inches unless otherwise stated)

Wheelbase	135.0	155.0
Length	224.1	244.1
Width	79.4	79.4
Height	81.6	82.0
Seating (maximum)	2/3/3/4	2/3/3/3/4
Head room	40.2/38.5/38.6/38.1	40.2/38.5/38.6/38.1/38.1
Shoulder room	68.8/68.9/63.5/68.3	68.8/68.9/63.5/68.3/62.7
Leg room	41.3/34.8/37.6/39.8	41.3/34.8/37.6/39.8/36.4
Max. cargo vol. ⁴ (cubic feet)	217.3	252.6
Fuel capacity ⁸ (gallons)	31	31
Max. towing capacity ⁷ (pounds)	6500	7700

New radios are available with CD player, CD/MP3 player, 6-disc CD changer and redundant steering wheel controls.





SELECTED STANDARD FEATURES

Safety and Security

- Frontal air bags with Passenger Sensing System¹ (deactivation switch only on 2500 and 3500 models)
- Head curtain side-impact air bags¹
- StabiliTrak[®] stability enhancement system
- Child seat anchors
- PASS-Key III theft-deterrent system
- Daytime Running Lamps

Interior

- Front high-back, reclining bucket seats
- 8-passenger seating (1500 model)
- 12-passenger seating (2500 and 3500 models)
- Console with storage, 3 cupholders, 2 power outlets
- Front passenger assist handle
- Air conditioning
- Full-length black rubberized-vinyl floor covering
- AM/FM stereo with digital clock

Mechanical

- Vortec 5.3L V8 with 301 hp (1500 model)
- Vortec 6.0L V8 with 323 hp (2500 and 3500 models)
- Oil Life Monitoring System
- 4-speed automatic transmission with Tow/Haul mode on the instrument panel
- Independent front suspension
- 4-wheel disc antilock brake system
- Power steering
- Battery with rundown protection and retained accessory power

Exterior

- Halogen headlamps
- Intermittent front windshield wipers
- Swing-out 60/40 passenger-side door
- Swing-out rear doors
- Manual rearview mirrors
- P245/75R16 all-season tires
- Stainless steel exhaust system

SELECTED OPTIONAL FEATURES

- Seating options: driver and front passenger power adjustment, cloth seats, 15-passenger seating
- Cruise control
- Tilt adjustable steering column
- Compass and outside temperature display
- Power windows, door locks
- Rear air conditioning/heater
- Full floor color-keyed carpeting
- Audio options: CD player, CD/MP3 player, 6-disc CD changer, steering wheel controls
- FlexFuel capability (5.3L V8)
- Trailering equipment
- Sliding passenger-side door
- Remote Keyless Entry
- Outside heated, power, folding mirrors with turn signals
- LT Package

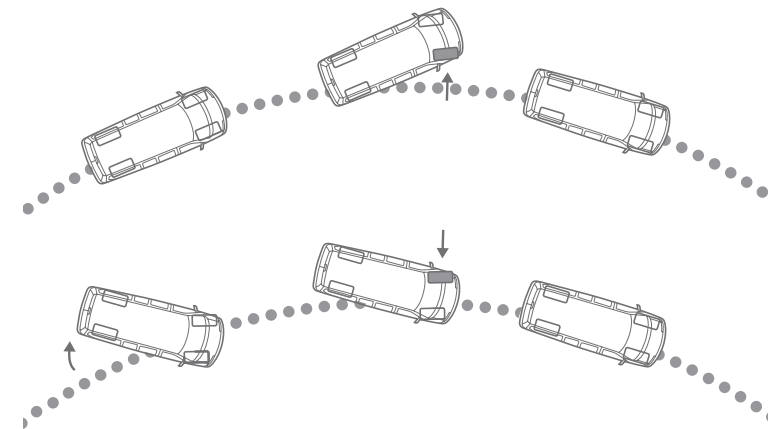

If understeer occurs (top), standard StabiliTrak[®] applies the inside front brake to help correct steering.

If fishtailing occurs (bottom), it applies the outside front brake to help correct steering.

AVAILABLE EXTERIOR COLORS¹⁵

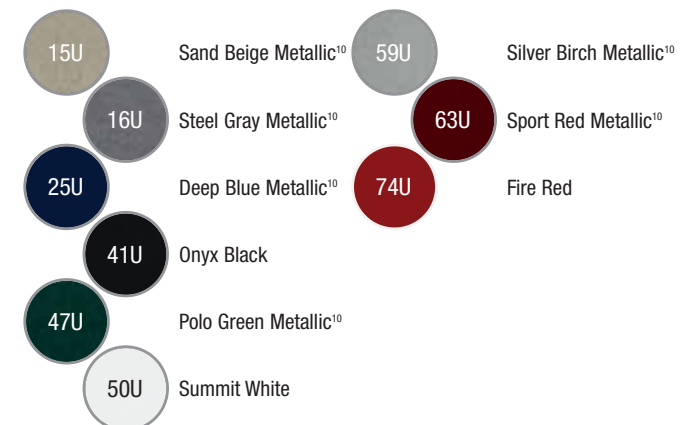

OVERVIEW

Chevrolet Express is the ideal choice for full-size cargo van buyers, delivering a wide variety of engines, rear-wheel or all-wheel drive and a left-hand-side hinged entry/load door for ready access. Remote release side panels and special lighting are available for workload capability.

NEW FOR 2008

- New instrument panel with Driver Information Center
- Head curtain side-impact air bags¹ available
- Vortec 5.3L V8 (LMF) with FlexFuel capability available
- Vortec 4.8L V8 (LY2) standard on 2500 and 3500 models
- Vortec 6.0L V8 (LY6) available on 2500 and 3500 models

MODEL AVAILABILITY

	Regular Wheelbase	Extended Wheelbase
G1500 RWD	CG13405	—
G1500 AWD	CH13405	—
G2500 RWD	CG23405	CG23705
G3500 RWD	CG33405	CG33705

SPECIFICATIONS (inches unless otherwise stated)

Wheelbase	135.0	155.0
Length	224.1	244.1
Width	79.4	79.4
Height	81.6	82.0
Seating	2	2
Head room	40.2	40.2
Shoulder room	68.8	68.8
Leg room	41.3	41.3
Max. cargo vol. ⁴ (cubic feet)	267.3	316.8
Fuel capacity ⁸ (gallons)	31	31
Max. towing capacity ⁷ (pounds)	6500	10000

SELECTED STANDARD FEATURES
Safety and Security

- Frontal air bags with passenger-side deactivation switch¹ (2500 and 3500 models only)
- PASSKey III theft-deterrent system
- Daytime Running Lamps

Interior

- Front high-back, reclining bucket seats
- Console with storage, 3 cupholders, 2 power outlets
- Front passenger assist handle
- Air conditioning
- Full-length black rubberized-vinyl floor covering
- Protective inner door panels

Mechanical

- Vortec 4.3L V6 with 195 hp (1500 RWD model)
- Vortec 4.8L V8 with 246 hp (2500 and 3500 models)

- Vortec 5.3L V8 with 301 hp (1500 AWD model)
- Oil Life Monitoring System
- 4-speed automatic transmission with Tow/Haul mode on the instrument panel
- Independent front suspension
- 4-wheel disc antilock brake system
- Power steering
- Battery with rundown protection and retained accessory power

Exterior

- Halogen headlamps
- Intermittent front windshield wipers
- Swing-out 60/40 passenger-side door
- Swing-out rear doors
- Manual rearview mirrors
- P245/75R16 all-season tires
- Stainless steel exhaust system

SELECTED OPTIONAL FEATURES

- Head curtain side-impact air bags¹
- Seating options: driver power adjustment, cloth seats
- Tilt adjustable steering column with cruise control
- Compass and outside temperature display
- Power windows, door locks
- Rear air conditioning/heater
- Audio options: AM/FM stereo, CD player
- All-wheel drive (1500 models)
- FlexFuel capability (5.3L V8)
- Vortec 6.0L V8 with 323 hp
- Duramax 6.6L Turbo Diesel V8
- Rear locking differential
- High idle switch (diesel only)
- Trailing equipment
- Swing-out 60/40 driver-side door
- Sliding passenger-side door
- Express Access remote release side panels, enhanced lighting
- Remote Keyless Entry
- Outside heated, power, folding mirrors with turn signals
- Ambulance Prep Package

Vehicles shown have been altered or upfitted with equipment supplied by independent suppliers. See Owner Manual for information on alterations and warranties.

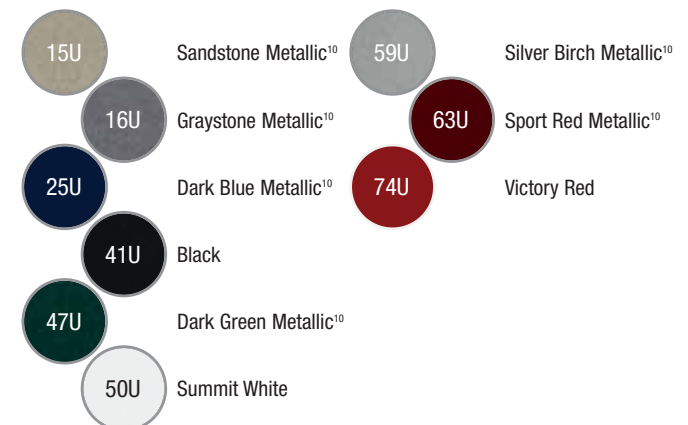
AVAILABLE EXTERIOR COLORS¹⁵



SELECTED STANDARD FEATURES
Safety and Security

- Dual-stage front air bags¹
- OnStar 1-year Safe & Sound Plan² (fleet delete available)
- Rear child security door locks
- StabiliTrak[®] stability enhancement system
- PASS-Key III theft-deterrent system
- Daytime Running Lamps and automatic lamp control
- Tire Pressure Monitoring System⁹

Mechanical

- Front-wheel drive
- 3.9L V6 with 240 hp
- 4-speed automatic transmission
- 4-wheel disc antilock brake system
- 4-wheel independent suspension
- Heavy-duty rear springs
- Traction control
- Power rack-and-pinion steering
- Battery with rundown protection
- Stainless steel exhaust system

Interior

- Front reclining bucket seats
- 2nd-row single crew seat (delete available)
- Air conditioning
- Cruise control
- Power programmable door locks
- Tilt adjustable steering column
- Power windows with rear quarter vent windows
- Remote Keyless Entry
- AM/FM stereo with CD/MP3, auxiliary input jack

Exterior

- Intermittent front windshield wipers
- Halogen headlamps
- Folding, power rearview mirrors
- Manual-sliding driver- and passenger-side doors
- P225/60R17 all-season tires
- Rear liftgate

SELECTED OPTIONAL FEATURES

- Driver 6-way power seat adjustment
- 2-passenger seating
- 4-passenger seating
- Bins and partitions available from independent suppliers
- Climate Package including Solar Ray deep tint glass, rear window defogger, outside heated power adjustable rearview mirrors, rear wiper
- XM Satellite Radio³
- FlexFuel capability (no charge)
- Safe and Secure Package including automatic level control and P225/60R17 all-season tires
- Light duty rear springs
- Luggage rack side rails
- Aluminum wheels

OVERVIEW

Chevrolet Uplander Cargo Van is the ideal choice for commercial use, either as a cargo carrier or upfitted with equipment bins for plumbers, electricians or other trades.

NEW FOR 2008

- Tire Pressure Monitoring System⁹ standard
- MP3 capability, auxiliary input jack
- StabiliTrak[®] stability enhancement system standard
- Traction control standard

Vehicles shown may be altered or upfitted with equipment supplied by independent suppliers. See Owner Manual for information on alterations and warranties.

MODEL AVAILABILITY

	Extended Wheelbase
Uplander Cargo Van	CU12216

SPECIFICATIONS (inches unless otherwise stated)

Wheelbase	121.1
Length	204.3
Width	72.0
Height	72.0
Seating	2 front, 1 rear
Head room	39.8
Shoulder room	59.9
Leg room	39.9
Max. cargo vol. ⁴ (cubic feet)	136.5
Fuel capacity ⁸ (gallons)	25
Max. towing capacity ⁷ (pounds)	3500

AVAILABLE EXTERIOR COLORS¹⁵

- 49U Bordeaux Red Metallic
- 50U Summit White
- 51U Gold Mist Metallic
- 67U Silverstone Metallic
- 81U Desert Brown Metallic
- 87U Slate Metallic (new)



OVERVIEW

GMC Savana is the ideal choice for full-size cargo van buyers, delivering a wide variety of engines, rear-wheel or all-wheel drive and a left-hand-side hinged entry/load door for ready access. Remote release side panels and special lighting are available for workload capability.

NEW FOR 2008

- New instrument panel with Driver Information Center
- Head curtain side-impact air bags¹ available
- Vortec 5.3L V8 (LMF) with FlexFuel capability available
- Vortec 4.8L V8 (LY2) standard on 2500 and 3500 models
- Vortec 6.0L V8 (LY6) available on 2500 and 3500 models

MODEL AVAILABILITY

	Regular Wheelbase	Extended Wheelbase
G1500 RWD	TG13405	–
G1500 AWD	TH13405	–
G2500 RWD	TG23405	TG23705
G3500 RWD	TG33405	TG33705

SPECIFICATIONS (inches unless otherwise stated)

Wheelbase	135.0	155.0
Length	224.1	244.1
Width	79.4	79.4
Height	81.6	82.0
Seating	2	2
Head room	40.2	40.2
Shoulder room	68.8	68.8
Leg room	41.3	41.3
Max. cargo vol. ⁴ (cubic feet)	267.3	316.8
Fuel capacity ⁸ (gallons)	31	31
Max. towing capacity ⁷ (pounds)	6500	10000

SELECTED STANDARD FEATURES

Safety and Security

- Frontal air bags with passenger-side deactivation switch¹ (2500 and 3500 models only)
- PASSKey III theft-deterrent system
- Daytime Running Lamps

Interior

- Front high-back, reclining bucket seats
- Console with storage, 3 cupholders, 2 power outlets
- Front passenger assist handle
- Air conditioning
- Full-length black rubberized-vinyl floor covering (delete available)
- Protective inner door panels

Mechanical

- Vortec 4.3L V6 with 195 hp (1500 RWD model)
- Vortec 4.8L V8 with 246 hp (2500 and 3500 models)
- Vortec 5.3L V8 with 301 hp (1500 AWD model)

Oil Life Monitoring System

- 4-speed automatic transmission with Tow/Haul mode on the instrument panel
- Independent front suspension
- 4-wheel disc antilock brake system
- Power steering
- Battery with rundown protection and retained accessory power

Exterior

- Halogen headlamps
- Intermittent front windshield wipers
- Swing-out 60/40 passenger-side door
- Swing-out rear doors
- Manual rearview mirrors
- P245/75R16 all-season tires
- Stainless steel exhaust system

SELECTED OPTIONAL FEATURES

- Head curtain side-impact air bags¹
- Seating options: driver power adjustment, cloth seats
- Tilt adjustable steering column with cruise control
- Compass and outside temperature display
- Power windows, door locks
- Rear air conditioning/heater
- Audio options: AM/FM stereo, CD player
- All-wheel drive (1500 model)
- FlexFuel capability (5.3L V8)
- Vortec 6.0L V8 with 323 hp
- Duramax 6.6L Turbo Diesel V8
- Rear locking differential
- High idle switch (diesel only)
- Trailing equipment
- Swing-out 60/40 driver-side door
- Sliding passenger-side door
- Savana Pro remote release side panels, enhanced lighting
- Remote Keyless Entry
- Outside heated, power, folding mirrors with turn signals
- Ambulance Prep Package



AVAILABLE EXTERIOR COLORS¹⁵

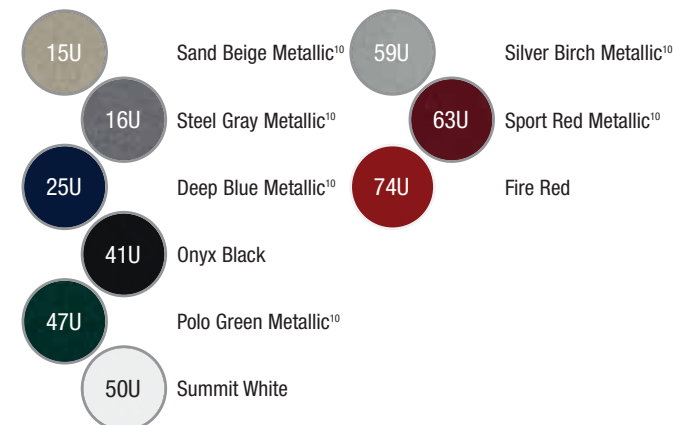

SELECTED STANDARD FEATURES
Safety and Security

- Frontal air bags with passenger-side deactivation switch¹
- PASSKey III theft-deterrent system
- Daytime Running Lamps

Interior

- Front high-back, reclining bucket seats
- Console with storage, 3 cupholders, 2 power outlets
- Front passenger assist handle
- Air conditioning
- Black rubberized-vinyl floor covering

Mechanical

- Vortec 4.8L V8 with 246 hp (10,000 GVWR or under) or 233 hp (over 10,000 GVWR) (139-inch wheelbase)
- Vortec 6.0L V8 with 323 hp (159-inch and 177-inch wheelbase)
- Oil Life Monitoring System
- 4-speed automatic transmission with Tow/Haul mode on the instrument panel
- Independent front suspension
- Ladder-type frame
- 4-wheel disc antilock brake system
- Power steering
- Battery with rundown protection and retained accessory power

Exterior

- Halogen headlamps
- Intermittent front windshield wipers
- Manual rearview mirrors
- LT245/75R16 all-season tires
- Stainless steel exhaust system

SELECTED OPTIONAL FEATURES

- Cloth seats
- Cruise control
- Tilt adjustable steering column
- Power windows, door locks
- Audio options: AM/FM stereo, MP3 player, CD player, 6-disc CD player
- Duramax 6.6L Turbo Diesel V8
- 57-gallon fuel tank (gas only)
- Rear locking differential
- High idle switch (diesel only)
- Packages include Ambulance, RV, School Bus and Shuttle Bus
- Outside heated, power, folding mirrors with turn signals

OVERVIEW

Chevrolet Express Cutaway offers end-users and upfitters flexibility and durability with 3 available wheelbases, single or dual rear wheels and 3 engine choices. And it offers the only diesel in the marketplace.

NEW FOR 2008

- Shuttle Bus, School Bus and Ambulance Packages available
- New instrument panel with Driver Information Center

Vehicles shown have been altered or upfitted with equipment supplied by independent suppliers. See Owner Manual for information on alterations and warranties.

MODEL AVAILABILITY

	139-in. wheelbase	159-in. wheelbase	177-in. wheelbase
139-in. wheelbase	CG33503	—	—
159-in. wheelbase	—	CG33803	—
177-in. wheelbase	—	—	CG33903

SPECIFICATIONS (inches unless otherwise stated)

	139.0	159.0	177.0
Wheelbase	139.0	159.0	177.0
Length	246.7	266.7	284.8
Width	79.1	79.1	79.1
Height	82.9	82.9	82.9
Seating	2	2	2
Head room	40.2	40.2	40.2
Shoulder room	68.8	68.8	68.8
Leg room	41.3	41.3	41.3
Fuel capacity ⁶ (gallons)	33	33	33
GVWR ⁸ (pounds)	9600	10000	12300

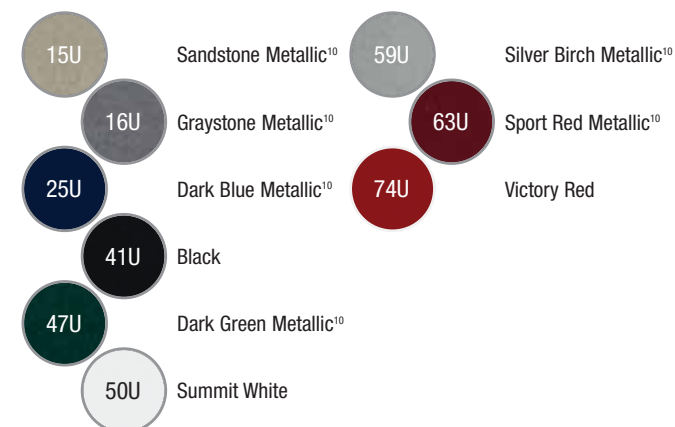
AVAILABLE EXTERIOR COLORS¹⁵



OVERVIEW

GMC Savana Cutaway offers end-users and upfitters flexibility and durability with 3 available wheelbases, single or dual rear wheels and 3 engine choices. And it offers the only diesel in the marketplace.

NEW FOR 2008

- Shuttle Bus, School Bus and Ambulance Packages available
- New instrument panel with Driver Information Center

Vehicles shown have been altered or upfitted with equipment supplied by independent suppliers. See Owner Manual for information on alterations and warranties.

MODEL AVAILABILITY

	139-in. wheelbase	159-in. wheelbase	177-in. wheelbase
139-in. wheelbase	TG33503		–
159-in. wheelbase	–	TG33803	–
177-in. wheelbase	–	–	TG33903

SPECIFICATIONS (inches unless otherwise stated)

	139-in.	159-in.	177-in.
Wheelbase	139.0	159.0	177.0
Length	246.7	266.7	284.8
Width	79.1	79.1	79.1
Height	82.9	82.9	82.9
Seating	2	2	2
Head room	40.2	40.2	40.2
Shoulder room	68.8	68.8	68.8
Leg room	41.3	41.3	41.3
Fuel capacity ⁸ (gallons)	33	33	33
GVWR ⁹ (pounds)	9600	10000	12300

SELECTED STANDARD FEATURES

Safety and Security

- Frontal air bags with passenger-side deactivation switch¹
- PASSKey III theft-deterrent system
- Daytime Running Lamps

Interior

- Front high-back, reclining bucket seats
- Console with storage, 3 cupholders, 2 power outlets
- Front passenger assist handle
- Air conditioning
- Black rubberized-vinyl floor covering

Mechanical

- Vortec 4.8L V8 with 246 hp (10,000 GVWR or under) or 233 hp (over 10,000 GVWR) (139-inch wheelbase)
- Vortec 6.0L V8 with 323 hp (159-inch and 177-inch wheelbase)
- Oil Life Monitoring System
- 4-speed automatic transmission with Tow/Haul mode on the instrument panel
- Independent front suspension
- Ladder-type frame
- 4-wheel disc antilock brake system
- Power steering
- Battery with rundown protection and retained accessory power

Exterior

- Halogen headlamps
- Intermittent front windshield wipers
- Manual rearview mirrors
- LT245/75R16 all-season tires
- Stainless steel exhaust system

SELECTED OPTIONAL FEATURES

- Cloth seats
- Cruise control
- Tilt adjustable steering column
- Power windows, door locks
- Audio options: AM/FM stereo, MP3 player, CD player, 6-disc CD player
- Duramax 6.6L Turbo Diesel V8
- 57-gallon fuel tank (gas only)
- Rear locking differential
- High idle switch (diesel only)
- Packages include Ambulance, RV, School Bus and Shuttle Bus
- Outside heated, power, folding mirrors with turn signals



AVAILABLE EXTERIOR COLORS¹⁵

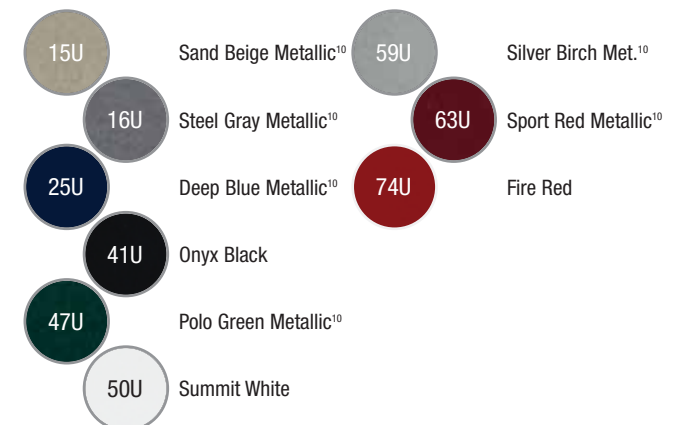



SELECTED FEATURES

Interior

- High-back bucket seats for driver and front passenger standard
- Driver-adjustable lumbar support available
- High-back air suspension seats available
- Common vehicle keys for fleets available
- Hystec™ cab-to-frame mounts to reduce noise and vibration available
- Storage in door, stepwell and under 2-person passenger seat
- Air conditioning available
- Cruise control available
- Tilt adjustable steering column available
- PTO provisions available

Exterior

- Daytime Running Lamps
- Exterior assist handles
- Large cowl-mounted mirrors with fold-away feature
- Electric lighted, heated mirrors available
- Large secure steps
- Excellent driver visibility

Mechanical

- 2-wheel or 4-wheel drive
- Standard Allison 1000 HS 6-speed automatic transmission with Gen IV controls. Other Allison vocational transmissions available
- Front I-beam axle with taper-leaf springs and shock absorbers
- Exhaust brake (diesel engine)
- 8,000-lb. front drive axle on 4x4 models
- 4-wheel disc antilock brake system
- Frame with yield strength up to 80 KSI

Body Styles

- Regular Cab (1–3 occupants)
- Crew Cab (1–6 occupants)
- Cutaway Chassis Cab: Motorhome, Commercial, School and Shuttle Bus

OVERVIEW

Chevrolet Kodiak's C4500 and C5500 medium duty trucks meet the diverse needs of commercial customers with a large selection of wheelbases, Regular or Crew Cab, and gasoline or diesel engines. Allison 6-speed transmissions for all models

Engine Availability

- Vortec 8.1L V8 with 325 horsepower and 450 lb.-ft. of torque
- Duramax 6.6L V8 Turbo Diesel with two versions: 300 horsepower and 520 lb.-ft. of torque or 330 horsepower and 620 lb.-ft. of torque

Available Vocational Packages

- Wrecker
- Snow Plow
- Fire and Rescue
- Ambulance
- Shuttle
- School/School Bus

Vehicles shown have been altered or upfitted with equipment supplied by independent suppliers. See Owner Manual for information on alterations and warranties.

SPECIFICATIONS

Model	Wheelbase (inches)	CA (inches)	CE (inches)	Overall Length (inches)	Body Lengths (feet)
Regular Cab	128	60	100	203	8–9
	152	84	146	248	10–12
	176	108	178	280	10–16
	188	120	204	306	12–18
	194	126	210	312	14–18
	206	138	222	324	16–20
Crew Cab	224	156	240	343	16–22
	169	60	121	265	8–10
	194	84	147	290	10–12
	217	108	192	335	12–16
	229	120	204	347	14–16
	235	126	210	354	14–18



AVAILABLE EXTERIOR COLORS¹⁵

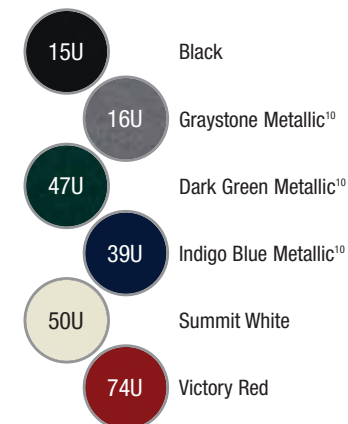



SELECTED FEATURES

Interior

- High back bucket seats for driver and front passenger standard
- 2-passenger seat with/without underseat storage
- Driver and passenger air suspension seats available
- Rear bench seat (Crew Cab)
- Common vehicle keys for fleets available
- Storage in door and stepwell
- Air conditioning available
- Cruise control available
- Tilt adjustable steering column available
- AM/FM stereo/cassette/CD provisions available
- PTO provisions available

Exterior

- Intermittent windshield wipers
- LED roof marker lights
- Wheel-cut to 53 degrees for tight turns
- Electric lighted, heated mirrors, available
- Large windshield and sloped hood for excellent driver visibility

Mechanical

- Allison 2300 HS 6-speed automatic transmission, with a variety of 5- or 6-speed transmissions available
- Eaton-Fuller manual transmissions
- Front parabolic taper-leaf springs and shock absorbers; multi-leaf on heavier applications
- Rear multi-leaf springs with available shock absorbers; taper-leaf and air suspensions available with single rear axle
- 4-wheel disc antilock brake system; air brakes available
- Frame with yield strength up to 120,000 psi

OVERVIEW

Chevrolet Kodiak C6500/C7500/C8500 trucks are the workhorses of the medium duty lineup, offering commercial customers up to 61,000-lb. GVWR⁵. Regular Cab, Crew Cab (with room for up to six occupants) and Chassis Cab configurations are available.

Engine Availability

- Vortec 8.1L MD V8 with 295 horsepower and 440 lb.-ft. of torque
- Isuzu 6H 7.8L Turbo Diesel with 215–300 horsepower and 560–860 lb.-ft. of torque
- Caterpillar C7 7.2L Turbo Diesel with 207–250 horsepower and 520–800 lb.-ft. of torque

NEW FOR 2008

- Tandem Air Suspension (40,000 pounds)
- Tandem Rubber Suspension (46,000 pounds)

MODEL AVAILABILITY

- C6500: GVW Class 6; 22,000–26,000-lb. GVWR⁵
- C7500: GVW Class 7; 25,950–37,600-lb. GVWR⁵
- C8500: GVW Class 8; 33,000–44,000-lb. GVWR⁵
- C8500 Tandem: Class 8; 46,000–63,000-lb. GVWR⁵

SPECIFICATIONS

Model	Wheelbase (inches)	CA (inches)	CE (inches)	Overall Length (inches)	Body Lengths (feet)
C6500 Regular Cab	128–296	60–228	135.3–351.1	240.3-456	8-30
C6500 Cutaway Cab	128–296	62.5–230.5	137–353.6	240.3-456	8-28
Crew Cabs – All Models	194–260	84.9–150	147.8–263.1	293.8-409.2	8-20
C7500, C8500 Regular & Cutaway	140–296	72–228	135.3–351.1	240.3-456	8-30



Vehicles shown have been altered or upfitted with equipment supplied by independent suppliers. See Owner Manual for information on alterations and warranties.

Body Styles

- Regular Cab (1–3 person)
- Crew Cab (1–6 person)
- Cutaway Chassis Cab (1–3 person)

AVAILABLE EXTERIOR COLORS¹⁵

- 41U Black
- 16U Graystone Metallic¹⁰
- 47U Dark Green Metallic¹⁰
- 39U Indigo Blue Metallic¹⁰
- 50U Summit White
- 74U Victory Red



SELECTED FEATURES

Interior

- Large storage area behind seats
- High back bucket seats for driver and front passenger standard
- Air suspension driver's seat available
- Center passenger seat available
- Overhead console
- Instrumentation with tachometer
- Cruise control available
- Air conditioning available
- Tilt/telescoping adjustable steering column
- AM/FM stereo and CD available
- PTO provisions available

Exterior

- Large windshield for excellent visibility
- Easy tilt cab
- Passenger door visibility window
- Large secure steps with anti-slip tread pattern
- Up to 53-degree wheel-cut for tight turns

Mechanical

- Daily service checks without tilting cab
- Frame with yield strength up to 120 KSI. Frame reinforcements available
- Allison 2500 HS 6-speed automatic transmission standard on T6500/7500. Allison 3000 6-speed standard on T8500. Other Allison 5- and 6-speed transmissions available
- Eaton-Fuller 6-, 9- and 10-speed manual transmissions available
- Front taper-leaf springs standard (multi-leaf on heaviest applications)
- Rear multi-leaf springs with available taper-leaf or air suspensions on single rear axle trucks
- Variable-ratio power steering
- 4-wheel disc antilock brake standard on T6500/7500. Air brakes standard on T8500

OVERVIEW

Chevrolet T-Series, with a cab-forward design, offers the ruggedness of a medium duty truck combined with outstanding visibility, maneuverability and engine service access.

Engine Availability

- Isuzu 6H 7.8L I-6 Turbo Diesel with 215–300 horsepower and 560–860 lb.-ft. of torque

NEW FOR 2008

- 2007 emissions compliant engines
- 300 hp/860 lb.-ft. available
- Allison 2200/2500/2550 6-speed transmissions
- AM/FM and CD player
- Vertical diesel particulate filter exhaust provisions

MODEL AVAILABILITY

- T6500 Single Axle: GVW Class 6; 24,350–26,000-lb. GVWR⁵
- T7500 Single Axle: GVW Class 7; 25,950–33,000-lb. GVWR⁵
- T8500 Single Axle: GVW Class 8; 33,001–39,000-lb. GVWR⁵
- T8500 Tandem Axle: GVW Class 8; 52,320–56,000-lb. GVWR⁵



Vehicles shown have been altered or upfitted with equipment supplied by independent suppliers. See Owner Manual for information on alterations and warranties.

Body Styles

- Single Axle Regular Cab (1–3 occupants)
- Tandem Axle Regular Cab (1–3 occupants)

AVAILABLE EXTERIOR COLORS¹⁵



Arc White

Other colors available; see Dealer for details.

SPECIFICATIONS

Model	Wheelbase (inches)	CA (inches)	CE (inches)	Overall Length (inches)	Body Lengths (feet)
Regular Cab					
T6500	140–260	109–229	169–349.1	258–438.5	10–32
T7500	140–260	109–229	169–349.1	258–438.5	10–32
T8500	140–260	109–229	169–349.1	258–438.5	10–32
Tandem Regular Cab					
T8500	170–260	139–229	204.1–349.1	303.4–438.5	14–32



SELECTED FEATURES

Interior

- High-back bucket seats for driver and front passenger standard
- Driver-adjustable lumbar support available
- High-back air suspension seats available
- Common vehicle keys for fleets available
- Hystec™ cab-to-frame mounts to reduce noise and vibration available
- Storage in door, stepwell and under 2-person passenger seat
- Air conditioning available
- Cruise control available
- Tilt adjustable steering column available
- PTO provisions available

Exterior

- Daytime Running Lamps
- Exterior assist handles
- Large cowl-mounted mirrors with fold-away feature
- Electric lighted, heated mirrors available
- Large secure steps
- Excellent driver visibility

Mechanical

- 2-wheel or 4-wheel drive
- Standard Allison 1000 HS 6-speed automatic transmission with Gen IV controls. Other Allison vocational transmissions available
- Front I-beam axle with taper-leaf springs and shock absorbers
- Exhaust brake (diesel engine)
- 8,000-lb. front drive axle on 4x4 models
- 4-wheel disc antilock brake system
- Frame with yield strength up to 80 KSI

Body Styles

- Regular Cab (1–3 occupants)
- Crew Cab (1–6 occupants)
- Cutaway Chassis Cab: Motorhome, Commercial, School and Shuttle Bus

OVERVIEW

GMC TopKick's C4500 and C5500 medium duty trucks meet the diverse needs of commercial customers with a large selection of wheelbases, Regular or Crew Cab, and gasoline or diesel engines. Allison 6-speed transmissions are standard for all models

Engine Availability

- Vortec 8.1L V8 with 325 horsepower and 450 lb.-ft. of torque
- Duramax 6.6L V8 Turbo Diesel with two versions: 300 horsepower and 520 lb.-ft. of torque or 330 horsepower and 620 lb.-ft. of torque

Available Vocational Packages

- Wrecker
- Snow Plow
- Fire and Rescue
- Ambulance
- Shuttle
- School/School Bus

Vehicles shown have been altered or upfitted with equipment supplied by independent suppliers. See Owner Manual for information on alterations and warranties.

SPECIFICATIONS

Model	Wheelbase (inches)	CA (inches)	CE (inches)	Overall Length (inches)	Body Lengths (feet)
Regular Cab	128	60	100	203	8–9
	152	84	146	248	10–12
	176	108	178	280	10–16
	188	120	204	306	12–18
	194	126	210	312	14–18
	206	138	222	324	16–20
Crew Cab	224	156	240	343	16–22
	169	60	121	265	8–10
	194	84	147	290	10–12
	217	108	192	335	12–16
	229	120	204	347	14–16
	235	126	210	354	14–18



AVAILABLE EXTERIOR COLORS¹⁵

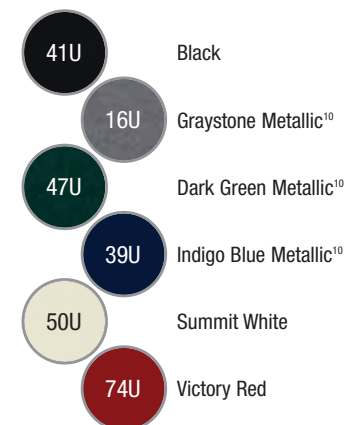



SELECTED FEATURES

Interior

- High back bucket seats for driver and front passenger standard
- 2-passenger seat with/without underseat storage
- Driver and passenger air suspension seats available
- Rear bench seat (Crew Cab)
- Common vehicle keys for fleets available
- Storage in door and stepwell
- Air conditioning available
- Cruise control available
- Tilt adjustable steering column available
- AM/FM stereo/cassette/CD provisions available
- PTO provisions available

Exterior

- Intermittent windshield wipers
- LED roof marker lights
- Wheel-cut to 53 degrees for tight turns
- Electric lighted, heated mirrors, available
- Large windshield and sloped hood for excellent driver visibility

Mechanical

- Allison 2300 HS 6-speed automatic transmission, with a variety of 5- or 6-speed transmissions available
- Eaton-Fuller manual transmissions
- Front parabolic taper-leaf springs and shock absorbers; multi-leaf on heavier applications
- Rear multi-leaf springs with available shock absorbers; taper-leaf and air suspensions available with single rear axle
- 4-wheel disc antilock brake system; air brakes available
- Frame with yield strength up to 120,000 psi

OVERVIEW

GMC TopKick C6500/C7500/C8500 trucks are the workhorses of the medium-duty lineup, offering commercial customers up to 61,000-lb. GVWR⁵. Regular Cab, Crew Cab (with room for up to six occupants) and Chassis Cab configurations are available.

Engine Availability

- Vortec 8.1L MD V8 with 295 horsepower and 440 lb.-ft. of torque
- Isuzu 6H 7.8L Turbo Diesel with 215–300 horsepower and 560–860 lb.-ft. of torque
- Caterpillar C7 7.2L Turbo Diesel with 207-250 horsepower and 520–800 lb.-ft. of torque

NEW FOR 2008

- Tandem Air Suspension (40,000 pounds)
- Tandem Rubber Suspension (46,000 pounds)

MODEL AVAILABILITY

- C6500: GVW Class 6; 22,000–26,000-lb. GVWR⁵
- C7500: GVW Class 7; 25,950–37,600-lb. GVWR⁵
- C8500: GVW Class 8; 33,000–44,000-lb. GVWR⁵
- C8500 Tandem: Class 8; 46,000–63,000-lb. GVWR⁵

SPECIFICATIONS

Model	Wheelbase (inches)	CA (inches)	CE (inches)	Overall Length (inches)	Body Lengths (feet)
C6500 Regular Cab	128–296	60–228	135.3–351.1	240.3–456	8–30
C6500 Cutaway Cab	128–296	62.5–230.5	137–353.6	240.3–456	8–28
Crew Cabs – All Models	194–260	84.9–150	147.8–263.1	293.8–409.2	8–20
C7500, C8500 Regular & Cutaway	140–296	72–228	135.3–351.1	240.3–456	8–30



Vehicles shown have been altered or upfitted with equipment supplied by independent suppliers. See Owner Manual for information on alterations and warranties.

Body Styles

- Regular Cab (1–3 occupants)
- Crew Cab (1–6 occupants)
- Cutaway Chassis Cab (1-3 occupants)

AVAILABLE EXTERIOR COLORS¹⁵

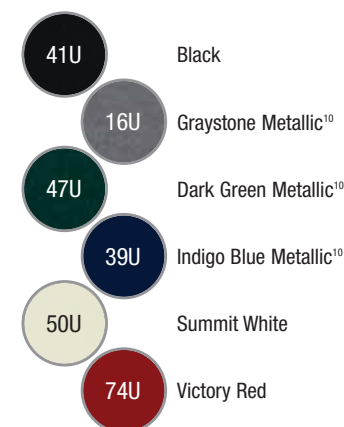



SELECTED FEATURES

Interior

- Large storage area behind seats
- High back bucket seats for driver and front passenger standard
- Air suspension driver's seat available
- Center passenger seat available
- Overhead console
- Instrumentation with tachometer
- Cruise control available
- Air conditioning available
- Tilt/telescoping adjustable steering column
- AM/FM stereo and CD player available
- PTO provisions available

Exterior

- Large windshield for excellent visibility
- Easy tilt cab
- Passenger door visibility window
- Large secure steps with anti-slip tread pattern
- Up to 53-degree wheel-cut for tight turns

Mechanical

- Daily service checks without tilting cab
- Frame with yield strength up to 120 KSI. Frame reinforcements available
- Allison 2500 HS 6-speed automatic transmission standard on T6500/7500. Allison 3000 6-speed standard on T8500. Other Allison 5- and 6-speed transmissions available
- Eaton-Fuller 6-, 9- and 10-speed manual transmissions available
- Front taper-leaf springs standard (multi-leaf on heaviest applications)
- Rear multi-leaf springs with available taper-leaf or air suspensions on single rear axle trucks
- Variable-ratio power steering
- 4-wheel disc antilock brake standard on T6500/7500. Air brakes standard on T8500

OVERVIEW

GMC T-Series, with a cab-forward design, offers the ruggedness of a medium-duty truck combined with outstanding visibility, maneuverability and engine service access.

Engine Availability

- Isuzu 6H 7.8L I-6 Turbo Diesel with 215–300 horsepower and 560–860 lb.-ft. of torque

NEW FOR 2008

- 2007 emissions compliant engines
- 300 hp/860 lb.-ft. available
- Allison 2200/2500/2550 6-speed transmissions
- AM/FM and CD player
- Vertical DPF exhaust provisions

MODEL AVAILABILITY

- T6500 Single Axle: GVW Class 6; 24,350–26,000-lb. GVWR⁵
- T7500 Single Axle: GVW Class 7; 25,950–33,000-lb. GVWR⁵
- T8500 Single Axle: GVW Class 8; 33,001–39,000-lb. GVWR⁵
- T8500 Tandem Axle: GVW Class 8; 52,320–56,000-lb. GVWR⁵

SPECIFICATIONS

Model	Wheelbase (inches)	CA (inches)	CE (inches)	Overall Length (inches)	Body Lengths (feet)
Regular Cab					
T6500	140–260	109–229	169–349.1	258–438.5	10–32
T7500	140–260	109–229	169–349.1	258–438.5	10–32
T8500	140–260	109–229	169–349.1	258–438.5	10–32
Tandem Regular Cab					
T8500	170–260	139–229	204.1–349.1	303.4–438.5	14–32



Vehicles shown have been altered or upfitted with equipment supplied by independent suppliers. See Owner Manual for information on alterations and warranties.

Body Styles

- Single Axle Regular Cab (1–3 occupants)
- Tandem Axle Regular Cab (1–3 occupants)

AVAILABLE EXTERIOR COLORS¹⁵



17U

Arc White



SELECTED STANDARD FEATURES

Safety and Security

- Dual-stage front air bags¹
- 3-point safety belts, all positions (except front center)
- Rear door child security locks
- PASSlock theft-deterrent system
- Daytime Running Lamps and automatic lamp control (delete available)
- Tire Pressure Monitoring System⁹

Interior

- Front bucket seats (9C1)
- Front 40/20/40 split-bench seat (9C3)
- 6-way power driver and front passenger seat
- Air conditioning with filtration
- Cruise control
- Power door locks
- Certified analog instrumentation, including tachometer
- Wiring provisions for headlamp flasher
- Remote Keyless Entry
- Tilt adjustable steering column
- Visors with vanity mirrors
- Radio suppression package

- Power windows include driver Express Down and passenger lockout
- AM/FM stereo with CD and auxiliary input jack

Mechanical

- Front-wheel drive
- 3.9L VVT V6 with 233 hp, FlexFuel capability, Active Fuel Management™
- Oil Life Monitoring System
- 4-speed automatic transmission
- Heavy-duty power 4-wheel disc antilock brake system
- Heavy-duty police suspension
- Power rack-and-pinion steering
- Battery rundown protection and retained accessory power

Exterior

- Intermittent front windshield wipers with flat blades
- Power rearview mirrors
- Auxiliary ground stud located in trunk
- P225/60R16 V-rated tires
- Heavy-duty 16-inch steel wheels

SELECTED OPTIONAL FEATURES

- Head curtain side-impact air bags¹
- Inoperative inside rear door handles
- Inoperative rear-window switches
- Single key locking system
- Flasher system
- Heated outside rearview mirrors
- Roof holes, spotlights, spotlight provisions
- Remote Vehicle Starter System
- Bodyside moldings

OVERVIEW

Chevrolet Impala for Police offers large-car utility with midsize agility. It is offered in marked (9C1) or unmarked (9C3) models.

NEW FOR 2008

- E85 capability standard
- Bodyside moldings are now available
- Key operated lock cylinder for the trunk

Vehicles shown have been altered or upfitted with equipment supplied by independent suppliers. See Owner Manual for information on alteration and warranties.

MODEL AVAILABILITY

	Sedan
Impala Police	1WS19
Police (9C1)	
Unmarked Police (9C3)	

SPECIFICATIONS (inches unless otherwise stated)

Wheelbase	110.5
Length	200.4
Width	72.9
Height	58.7
Seating f/r	2/3
Head room f/r	39.4/37.8
Shoulder room f/r	58.7/58.6
Leg room f/r	42.3/37.6
Max. cargo vol. ⁴ (cubic feet)	18.6
Fuel capacity ⁸ (gallons)	17



AVAILABLE EXTERIOR COLORS¹⁵

- 27U Precision Red
- 37U Imperial Blue Metallic
- 40U White
- 41U Black
- 42U Dark Silver Metallic
- 51U Gold Mist Metallic (new)
- 67U Silverstone Metallic
- 76U Mocha Bronze Metallic (new)

Note: Special paints and paint schemes can be ordered.



SELECTED STANDARD FEATURES

Safety and Security

- Dual-stage front air bags with Passenger Sensing System¹
- Tire Pressure Monitoring System⁹
- PASS-Key III theft-deterrent system
- Daytime Running Lamps (delete available)
- Automatic lamp control

Interior

- Front bucket seats
- Rear split-folding (third seat not available)
- Dual-zone and auxiliary rear climate control
- 140-mph certified speedometer and Driver Information Center
- Cruise control
- 3 auxiliary power outlets
- Remote Keyless Entry
- Compass, outside temperature
- Tilt adjustable steering column
- Power programmable door locks
- AM/FM with CD/MP3

Mechanical

- Vortec 5.3L V8 with 320 hp and FlexFuel capability
- 4-speed automatic transmission
- Heavy-duty 4-wheel disc antilock brake system with power assist
- Heavy-duty police-rated suspension
- Power steering
- Heavy-duty battery with 730 cold-cranking amps

Exterior

- Front intermittent windshield wipers
- Front frame-mounted recovery hooks
- Power, heated mirrors
- Assist steps
- P265/70R17 all-season tires
- Rear liftgate with liftglass, wiper/washer

SELECTED OPTIONAL FEATURES

- Head curtain side-impact air bags¹ with rollover sensor
- Inside rear door handles, windows and locks inoperative
- Cargo shade
- Dual batteries
- Rear locking differential
- Trailing equipment
- Common single key for fleet
- Spotlights
- Remote Vehicle Starter System
- Flasher system

OVERVIEW

Chevrolet Tahoe Police models are available in 2-wheel drive and have been designed for police work up to and including high-speed emergency vehicle operations.

Vehicles shown have been altered or upfitted with equipment supplied by independent suppliers. See Owner Manual for information on alteration and warranties.

MODEL AVAILABILITY

	2WD
Tahoe 2WD Police Vehicle	CC10706

SPECIFICATIONS (inches unless otherwise stated)

Wheelbase	116.0
Length	202.0
Width	79.0
Height	73.9
Seating f/r	2/3
Head room f/r	40.3/39.2
Shoulder room f/r	65.3/65.2
Leg room f/r	41.3/39.0
Max. cargo vol. ⁴ (cubic feet)	108.9
Fuel capacity ⁸ (gallons)	26
Minimum ground clearance	8.0



AVAILABLE EXTERIOR COLORS¹⁵

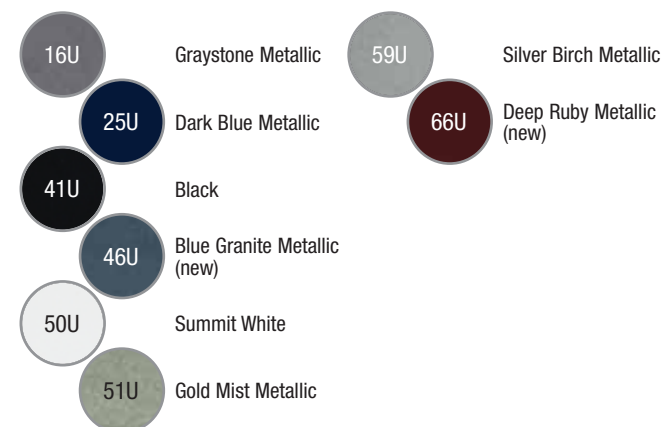



SELECTED STANDARD FEATURES

Safety and Security

- Dual-stage front air bags with Passenger Sensing System¹
- Tire Pressure Monitoring System⁹
- PASS-Key III theft-deterrent system
- StabiliTrak[®] stability enhancement system with Proactive Roll Avoidance
- Daytime Running Lamps and automatic lamp control (delete available)

Mechanical

- Vortec 5.3L V8 with 320 hp and FlexFuel capability
- 4-speed automatic transmission
- 4-wheel disc antilock brake system with power assist
- Power steering
- Heavy-duty battery with 730 cold-cranking amps
- Autotrac transfer case
- Heavy-duty trailering equipment

Exterior

- Front intermittent windshield wipers
- Front frame-mounted recovery hooks
- Power, heated mirrors
- Assist steps
- P265/70R17 all-season tires
- Rear liftgate with liftglass, wiper/washer

Interior

- Front 40/20/40 split-bench seat
- Rear split-folding seat (no third-row seat available)
- Dual-zone and auxiliary rear climate control
- 120-mph speedometer and Driver Information Center
- Cruise control
- 3 auxiliary power outlets
- Remote Keyless Entry
- Compass, outside temperature
- Tilt adjustable steering column
- Power programmable door locks
- AM/FM with CD/MP3

SELECTED OPTIONAL FEATURES

- Head curtain side-impact air bags¹ with rollover sensor
- Inside rear door handles, windows and locks inoperative
- Dual batteries
- Rear locking differential
- Off-road suspension
- Common single key for fleet
- Spotlights
- Remote Vehicle Starter System
- Skid Plate Package
- Aluminum wheels
- Flasher system

OVERVIEW

Chevrolet Tahoe Special Service models are 4-wheel drive models available to accommodate applications such as K9 and special tactics use. They are not intended for use in high-speed emergency operations.

Vehicles shown have been altered or upfitted with equipment supplied by independent suppliers. See Owner Manual for information on alteration and warranties.

MODEL AVAILABILITY

	4WD
Tahoe Special Services Vehicle	CK10706

SPECIFICATIONS (inches unless otherwise stated)

Wheelbase	116.0
Length	202.0
Width	79.0
Height	76.9
Seating f/r	3/3
Head room f/r	40.3/39.2
Shoulder room f/r	65.3/65.2
Leg room f/r	41.3/39.0
Max. cargo vol. ⁴ (cubic feet)	108.9
Fuel capacity ⁸ (gallons)	26
Max. towing capacity ⁷ (pounds)	7200
Minimum ground clearance	9.1



AVAILABLE EXTERIOR COLORS¹⁵

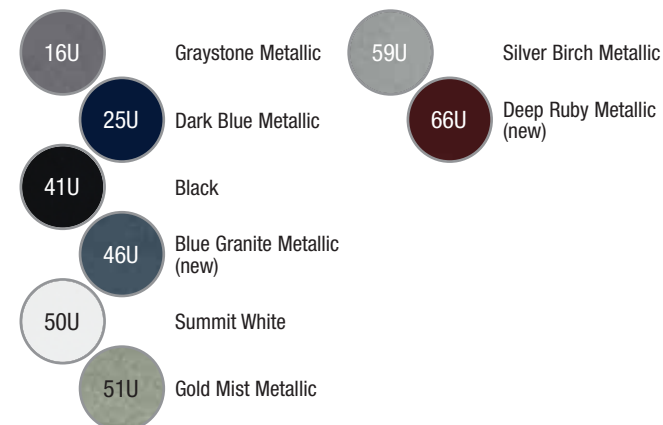



SELECTED STANDARD FEATURES

Safety and Security

- Frontal air bags with passenger-side deactivation switch¹
- StabiliTrak[®] stability enhancement system
- PASSlock theft-deterrent system
- Daytime Running Lamps

Interior

- Front high-back, reclining bucket seats
- 12-passenger seating
- Console with storage, 3 cupholders, 2 power outlets
- Air conditioning, front and rear
- Cruise control
- Tilt adjustable steering column
- AM/FM stereo with digital clock

Mechanical

- Vortec 6.0L V8 with 323 hp
- Oil Life Monitoring System
- 4-speed automatic transmission with Tow/Haul mode
- Independent front suspension
- 4-wheel disc antilock brake system
- Power steering
- Heavy-duty battery with 600 CCA

Exterior

- Halogen headlamps
- Intermittent front windshield wipers
- Swing-out 60/40 passenger-side door
- Swing-out rear doors
- Manual rearview mirrors
- LT245/75R16 all-season tires
- Stainless steel exhaust system

SELECTED OPTIONAL FEATURES

- 15-passenger seating
- Power windows, door locks
- Trailing equipment
- Sliding passenger-side door
- Outside heated, power, folding mirrors with turn signals

OVERVIEW

Chevrolet Express Police Transport Van combines outstanding passenger-carrying capacity with the added safety of GM's StabiliTrak vehicle stability enhancement system. This vehicle is not designed nor intended for high-speed emergency operation.

NEW FOR 2008

- Tire Pressure Monitoring System⁹ standard
- Interior update
- Vortec 6.0L V8 (LY6) standard
- Enhanced Technology Glass on all models
- Shoulder belts for center seats

MODEL AVAILABILITY

	Extended Wheelbase
G3500 RWD	CG33706

SPECIFICATIONS (inches unless otherwise stated)

Wheelbase	155.0
Length	244.1
Width	79.4
Height	82.0
Seating (maximum)	2/3/3/3/4
Head room	40.2/38.5/38.6/38.1/38.1
Shoulder room	68.8/68.9/63.5/68.3/62.7
Leg room	41.3/34.8/37.6/39.8/36.4
Max. cargo vol. ⁴ (cubic feet)	252.6
Fuel capacity ⁸ (gallons)	31
Max. towing capacity ⁷ (pounds)	7700

Vehicles shown have been altered or upfitted with equipment supplied by independent suppliers. See Owner Manual for information on alterations and warranties.



AVAILABLE EXTERIOR COLORS¹⁵

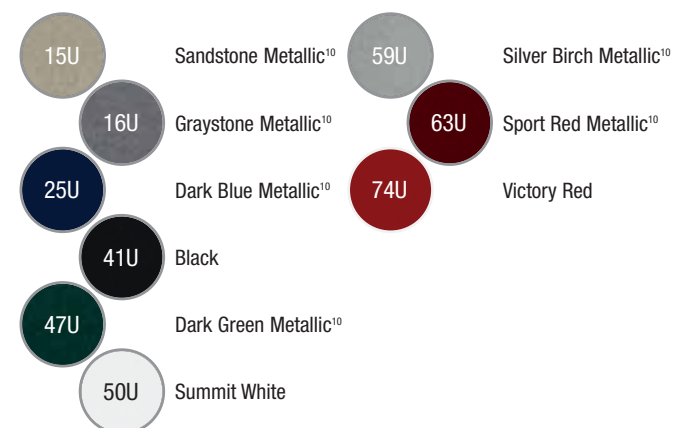



AMBULANCE PACKAGE

The YF2 Ambulance Package is offered on Chevrolet Silverado and GMC Sierra 3500HD Regular Cab Chassis Cab models. When lives are on the line, a robust equipment combination is key — and that's what GM provides.

Features include:

- CC31403 or TC31403 models (2WD) with 11,400-pound GVWR⁵
- CK31403 or TK31403 models (4WD) with 12,000-pound GVWR⁵
- Front bucket seats with 6-way power driver and passenger adjusters, passenger seat recline and manual lumbar control
- Duramax 6.6L Turbo Diesel V8 engine
- Allison 1000 6-speed automatic transmission (no PTO provisions)
- Heavy-duty dual 730 cold-cranking amp batteries
- Dual 125-amp alternators
- Engine block heater
- Requires single-zone manual air conditioning
- Requires Ebony Premium Cloth or Ebony Custom Leather Appointed trim

BOX DELETE WITH BODY

A Box Delete configuration is also available on Silverado and Sierra 3500HD. Regular, Extended or Crew Cabs are offered and provide 55.9-inch cab-to-axle dimension that allows buyers to add almost any of a variety of bodies to meet their specific needs.

APPLICATIONS

Here are some applications perfectly suited for the 3500HD Chassis Cab:

- Van body — if cargo needs weather protection, this is the answer
- Platform/stake body — for carrying anything from livestock to lumber and scrap metal
- Dump body — these durable vehicles can handle the severe service, on- and off-road ability and heavy loads
- Snow plow/spreader applications are easy to configure with the Snow Plow Prep Package available
- Utility/service body — providing for compartment storage and additional duties such as cherry-picker buckets and rescue equipment
- Catering body — perfect for meals-on-wheels applications for visiting factories, construction sites or events

VOCATIONAL BODY APPLICATIONS

Chevrolet Silverado and GMC Sierra offer 3500HD Chassis Cab configurations with either Regular or Extended Cabs. These offer unique qualities for those who need a chassis cab available in two- or four-wheel drive with a choice of gasoline or diesel engine.

Vehicles shown have been altered or upfitted with equipment supplied by independent suppliers. See Owner Manual for information on alteration and warranties.



OVERVIEW

Chevrolet Uplander offers the GM-exclusive Sit-N-Lift™ power seat as well as Mobility Prep options to facilitate a lowered floor conversion for wheelchair accessibility by Braun or EIDorado National. A long list of safety features and versatile interior choices make this vehicle especially accommodating to those with special needs.

NEW FOR 2008

- Tire Pressure Monitoring System⁹ standard
- XM Satellite Radio³ standard (fleet delete available)
- StabiliTrak[®] stability enhancement system standard
- Traction control standard

Vehicles shown have been altered or upfitted with equipment supplied by independent suppliers. See Owner Manual for information on alterations and warranties.

MODEL AVAILABILITY

	Extended Wheelbase
Uplander Passenger Van	CU12216

SPECIFICATIONS (inches unless otherwise stated)

Wheelbase	121.1
Length	204.3
Width	72.0
Height	72.0
Seating f/m/r	2/2/3
Head room f/m/r	39.8/38.9/38.2
Shoulder room f/m/r	59.9/61.2/48.6
Leg room f/m/r	39.9/38.9/36.2
Max. cargo vol. ⁴ (cubic feet)	136.5
Fuel capacity ⁸ (gallons)	25
Max. towing capacity ⁷ (pounds)	3500

SELECTED STANDARD FEATURES

Safety and Security

- Dual-stage front air bags¹
- OnStar 1-year Safe & Sound Plan² (fleet delete available)
- Rear child security door locks
- LATCH (Lower Anchors and Top tethers for CHildren) system
- StabiliTrak[®] stability enhancement system
- PASS-Key III theft-deterrent system
- Daytime Running Lamps and automatic lamp control
- Tire Pressure Monitoring System⁹

Interior

- 7-passenger seating
- Front reclining bucket seats
- 2nd-row reclining, removable bucket seats
- 3rd-row 50/50 split-folding bench seat
- Air conditioning
- Power programmable door locks
- Tilt adjustable steering column
- Power windows with manual rear quarter vent windows

- AM/FM stereo with CD/MP3, auxiliary input jack, XM Satellite Radio³ (fleet delete available)

Mechanical

- Front-wheel drive
- 3.9L V6 with 240 hp
- 4-speed automatic transmission
- 4-wheel disc antilock brake system
- 4-wheel independent suspension
- Traction control
- Power rack-and-pinion steering
- Battery with rundown protection
- Stainless steel exhaust system

Exterior

- Intermittent front windshield wipers
- Halogen headlamps
- Folding, power rearview mirrors
- Manual-sliding driver- and passenger-side doors
- P225/60R17 all-season tires
- Rear liftgate

SELECTED OPTIONAL FEATURES

- Sit-N-Lift™ (AQW) power lift-and-lower seat for 2nd-row right side; includes remote control and slide-out foot rest
- Mobility Prep Packages
 - (Y3H) Paratransit, to lower floor; includes 2nd-row seats removed.
 - (PCH) Paratransit upgrade for Y3H, adds power sliding passenger-side door, Remote Keyless Entry, power rear vent windows, front seat side-impact air bags,¹ cruise control, Climate Package
 - (Y3G) Family use, to lower floor; includes 2nd-row seats removed.
- Seating options: power adjustment, heated, leather seating surfaces
- Auxiliary rear air conditioning
- Power sliding side doors
- Remote Vehicle Starter System
- Ultrasonic Rear Parking Assist



Shown with optional equipment



AVAILABLE EXTERIOR COLORS¹⁵

- 49U Bordeaux Red Metallic
- 50U Summit White
- 51U Gold Mist Metallic
- 67U Silverstone Metallic
- 81U Desert Brown Metallic
- 87U Slate Metallic (new)

SELECTED STANDARD FEATURES
Safety and Security

- Frontal air bags with passenger-side deactivation switch¹ (passenger-side delete on Y3G)
- PASSlock theft-deterrent system
- Daytime Running Lamps

Interior

- Front high-back, reclining bucket seats (temporary driver on Y3G)
- Console with storage, 3 cupholders, 2 power outlets
- Front passenger assist handle
- Air conditioning
- Full-length black rubberized-vinyl floor covering (delete available)

Mechanical

- Vortec 6.0L V8 with 323 hp
- Oil Life Monitoring System
- 4-speed automatic transmission with Tow/Haul mode on the instrument panel
- Independent front suspension
- 4-wheel disc antilock brake system
- Power steering
- Battery with rundown protection and retained accessory power

Exterior

- Halogen headlamps
- Intermittent front windshield wipers
- Swing-out 60/40 passenger-side door
- Swing-out rear doors
- Manual rearview mirrors
- LT245/75R16 all-season tires
- Stainless steel exhaust system

SELECTED OPTIONAL FEATURES

- Mobility Package (Z4G) on Passenger Van for lowered floor conversion includes extended length wiring harness
- Head curtain side-impact air bags¹ (Passenger Van)
- Mobility Prep Package (Y3G) on Cargo Van includes power door locks, power windows, fixed window package, rear door swing-out glass, floor covering delete, 145-amp alternator, gray-painted wheels, console with swing-out storage bin, outside heated power mirrors, visor vanity mirrors, chrome trim, heavy-duty battery, CD player
- Paratransit Package (Y3H) on Cargo Van includes front-only vinyl flooring, fixed window package, rear door swing-out glass, heavy-duty battery, 145-amp alternator
- Rear air conditioning/heater (not available Y3H)
- Trailing equipment
- Swing-out 60/40 driver-side door
- Remote Keyless Entry (not available Y3H)

OVERVIEW

Chevrolet Express is the full-size van of choice for mobility applications. With a raised roof, the Express Cargo Mobility (Y3G) for family use or the Paratransit (Y3H) are offered in 2500 and 3500 models, in regular or extended wheelbases.

For a lowered floor version, Express Passenger with the Mobility Package (Z4G) is ideal.

NEW FOR 2008

- Head curtain side-impact air bags¹ available on passenger van
- Vortec 6.0L V8 (LY6) engine
- StabiliTrak[®] now included in Z4G Package
- Extended harness included in Z4G Package

MODEL AVAILABILITY

	Regular Wheelbase	Extended Wheelbase
G2500 RWD Passenger	CG23406	—
G2500 RWD Cargo	CG23405	CG23705
G3500 RWD Cargo	CG33405	CG33705

SPECIFICATIONS (inches unless otherwise stated)

Wheelbase	135.0	155.0
Length	224.1	244.1
Width	79.4	79.4
Height	81.6	82.0
Seating	2	2
Head room	40.2	40.2
Shoulder room	68.8	68.8
Leg room	41.3	41.3
Max. cargo vol. ⁴ (cubic feet)	267.3	316.8
Fuel capacity ⁸ (gallons)	31	31
Max. towing capacity ⁷ (pounds)	6500	7700

Vehicles shown have been altered or upfitted with equipment supplied by independent suppliers. See Owner Manual for information on alterations and warranties.

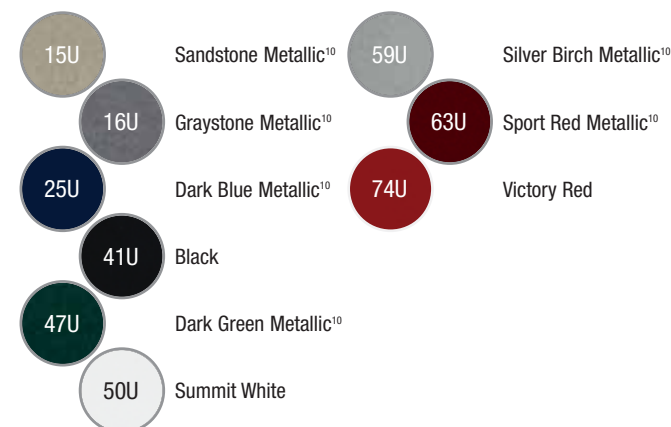
AVAILABLE EXTERIOR COLORS¹⁵



OVERVIEW

GMC Savana is the full-size van of choice for mobility applications. With a raised roof, the Savana Cargo Mobility (Y3G) for family use or the Paratransit (Y3H) are offered in 2500 and 3500 models, in regular or extended wheelbases.

For a lowered floor version, Savana Passenger with the Mobility Package (Z4G) is ideal.

NEW FOR 2008

- Head curtain side-impact air bags¹ available on passenger van
- Vortec 6.0L V8 (LY6) engine
- StabiliTrak[®] now included in Z4G Package
- Extended harness included in Z4G Package

MODEL AVAILABILITY

	Regular Wheelbase	Extended Wheelbase
G2500 RWD Passenger	TG23406	—
G2500 RWD Cargo	TG23405	TG23705
G3500 RWD Cargo	TG33405	TG33705

SPECIFICATIONS (inches unless otherwise stated)

Wheelbase	135.0	155.0
Length	224.1	244.1
Width	79.4	79.4
Height	81.6	82.0
Seating	2	2
Head room	40.2	40.2
Shoulder room	68.8	68.8
Leg room	41.3	41.3
Max. cargo vol. ⁴ (cubic feet)	267.3	316.8
Fuel capacity ⁸ (gallons)	31	31
Max. towing capacity ⁷ (pounds)	6500	7700

SELECTED STANDARD FEATURES

Safety and Security

- Frontal air bags with passenger-side deactivation switch¹ (passenger-side delete on Y3G)
- PASSlock theft-deterrent system
- Daytime Running Lamps

Interior

- Front high-back, reclining bucket seats (temporary driver on Y3G)
- Console with storage, 3 cupholders, 2 power outlets
- Front passenger assist handle
- Air conditioning
- Full-length black rubberized-vinyl floor covering (delete available)

Mechanical

- Vortec 6.0L V8 with 323 hp
- Oil Life Monitoring System
- 4-speed automatic transmission with Tow/Haul mode on the instrument panel
- Independent front suspension
- 4-wheel disc antilock brake system
- Power steering
- Battery with rundown protection and retained accessory power

Exterior

- Halogen headlamps
- Intermittent front windshield wipers
- Swing-out 60/40 passenger-side door
- Swing-out rear doors
- Manual rearview mirrors
- LT245/75R16 all-season tires
- Stainless steel exhaust system

Vehicles shown have been altered or upfitted with equipment supplied by independent suppliers. See Owner Manual for information on alterations and warranties.



SELECTED OPTIONAL FEATURES

- Mobility Package (Z4G) on Passenger Van for lowered floor conversion includes extended length wiring harness
- Head curtain side-impact air bags¹ (Passenger Van)
- Mobility Prep Package (Y3G) on Cargo Van includes power door locks, power windows, fixed window package, rear door swing-out glass, floor covering delete, 145-amp alternator, gray-painted wheels, console with swing-out storage bin, outside heated power mirrors, visor vanity mirrors, chrome trim, heavy-duty battery, CD player
- Paratransit Package (Y3H) on Cargo Van includes front-only vinyl flooring, fixed window package, rear door swing-out glass, heavy-duty battery, 145-amp alternator
- Rear air conditioning/heater (not available Y3H)
- Trailing equipment
- Swing-out 60/40 driver-side door
- Remote Keyless Entry (not available Y3H)

AVAILABLE EXTERIOR COLORS¹⁵

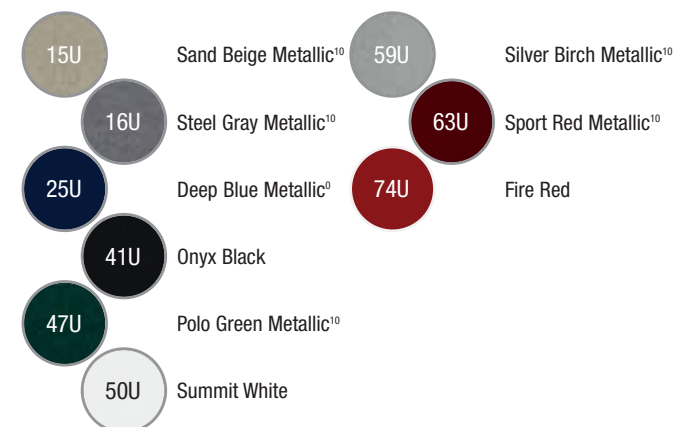

A WORD ABOUT THIS GUIDE

This material is not legally approved for use in any advertising.

We have tried to make this guide comprehensive and factual. We reserve the right, however, to make changes at any time, without notice, in prices, colors, materials, equipment, specifications, models and availability. Specifications, dimensions, measurements, ratings and other numbers in this guide and other printed materials provided at the dealership or affixed to vehicles are approximates based upon design and engineering drawings and prototypes and laboratory tests. Your vehicle may differ due to variations in manufacture and equipment. Since some information may have been updated since the time of release, please check with your GM dealer for complete details. Competitive comparison claims are based on most current competitive information. GM reserves the right to lengthen or shorten the model year for any product for any reason, or to start and end model years at different times.

The vehicles described in this Guide are equipped with engine and components produced and assembled by different operating units of General Motors, its subsidiaries and suppliers, and these engines and components may change or be obtained from different sources from time to time. All such engines and components are approved for use in GM vehicles. Certain equipment ordered may be unavailable at the time of assembly. Some of the equipment shown or described throughout this Guide may be available at extra cost, and/or is supplied by an independent supplier.

See your local General Motors Fleet Account Executive or Dealer Fleet/Commercial Sales Manager for up-to-date information, or see the GM Online Order Guide at gmfleet.com.

Copyright and Trademark

© Copyright 2007 General Motors Corporation. All Rights Reserved. All text, images, graphics and other materials in this Guide are subject to the copyright and other intellectual property rights of General Motors Corporation. These materials may not be reproduced, distributed or modified without the express written permission of General Motors Corporation.

The marks appearing in this Guide including, but not limited to: (i) GM and the GM Logo; (ii) Chevrolet, Pontiac, Buick, Cadillac, GMC, Saturn, Saab and HUMMER and their respective logos, emblems, slogans and vehicle model names and body designs; and (iii) other marks such as GM Fleet and Commercial, GMAC, ACDelco, StabiliTrak, Rainsense and QuietTuning are trademarks and/or service marks of General Motors Corporation, its subsidiaries, affiliates or licensors. The XM name and related logos are registered trademarks of XM Satellite Radio, Inc. OnStar and the OnStar emblems are registered trademarks of the OnStar Corporation. Bose is a registered trademark of the Bose Corp.

An important note about alterations and warranties

Installations or alterations to the original equipment vehicle (or chassis) as distributed by General Motors are not covered by the General Motors New Vehicle Limited Warranty. The special body company, assembler, equipment installer or upfitter is solely responsible for warranties on the body or equipment and any alterations (or any effect of the alterations) to any of the parts, components, systems or assemblies installed by GM. General Motors is not responsible for the safety or quality of design features, materials, or workmanship of any alterations by such suppliers.

Detailed Notes, as applicable to references on individual vehicle pages

1. Head curtain air bags are designed to help reduce the risk of head and neck injuries to front and outboard rear-seat occupants during certain side-impact collisions. Always use safety belts and the correct child restraint for your child's age and size, even in vehicles equipped with air bags. Even in vehicles equipped with Passenger Sensing System, children are safer when properly secured in a rear seat in an appropriate infant, child or booster seat. Never place a rear-facing infant restraint in the front seat of any vehicle equipped with an active frontal air bag. See your vehicle Owner's Manual and child safety seat instructions for more information.

2. Call 1-888-4ONSTAR (1-888-466-7827) or visit OnStar.com for system limitations and details. For Turn-by-Turn Navigation, antilock braking system and Directions & Connections Plan required. Turn-by-Turn Navigation not available in certain areas. Visit OnStar.com for coverage map.
3. XM Satellite Radio is available only in the 48 contiguous United States. Service fees extra. Visit gm.xradio.com for more details.
4. When properly equipped, cargo and load capacity limited by weight and distribution.
5. Gross Vehicle Weight Rating (GVWR). When properly equipped, includes vehicle, passengers, cargo and equipment.
6. Maximum payload capacity includes weight of driver, passengers, optional equipment and cargo. Cargo and load capacity limited by weight and distribution.
7. Maximum Trailer Weight ratings are calculated assuming a base vehicle, except for options necessary to achieve the rating, plus driver. The weight of other optional equipment, passengers and cargo will reduce the maximum trailer weight your vehicle can tow.
8. Fuel capacity is approximate.
9. Tire Pressure Monitoring System does not apply to spare tire.
10. Premium paint — available at extra cost.
11. Navigation Systems — map coverage includes only the 48 contiguous United States and portions of Hawaii and Canada. Not available in Alaska, Puerto Rico and the Virgin Islands.
12. RDS functions only where stations broadcast RDS information.
13. 2007 Frontal Safety Rating — U.S. Government safety rating for both the driver and front seat passenger in the frontal crash test. Side Impact Safety Rating — U.S. Government safety rating for both the front and rear seats in the side impact crash test. Government star ratings are part of the National Highway Traffic Safety Administration (NHTSA) New Car Assessment Program (www.safercar.gov).
14. Use only GM approved wheel/tire combinations. See your GM dealer for more details.
15. Actual colors may vary.

