

# DISCOVERY

2020



ABOVE & BEYOND





BY APPOINTMENT TO  
HM THE QUEEN  
MANUFACTURERS OF  
MOTOR VEHICLES  
JAGUAR LAND ROVER LIMITED  
COVENTRY



BY APPOINTMENT TO  
HRH THE DUKE OF EDINBURGH  
MANUFACTURERS OF  
MOTOR VEHICLES  
JAGUAR LAND ROVER LIMITED  
COVENTRY



BY APPOINTMENT TO  
HRH THE PRINCE OF WALES  
MANUFACTURERS OF  
MOTOR VEHICLES  
JAGUAR LAND ROVER LIMITED  
COVENTRY



**ABOVE & BEYOND**

Ever since the first Land Rover vehicle was conceived in 1947, we have built vehicles that challenge what is possible. These in turn have challenged their owners to explore new territories and conquer difficult terrains. Our vehicles epitomize the values of the designers and engineers who have created them. Each one instilled with iconic British design cues, delivering capability with composure. Which is how we continue to break new ground, defy conventions and encourage each other to go further. Land Rover truly enables you to make more of your world, to go above and beyond.

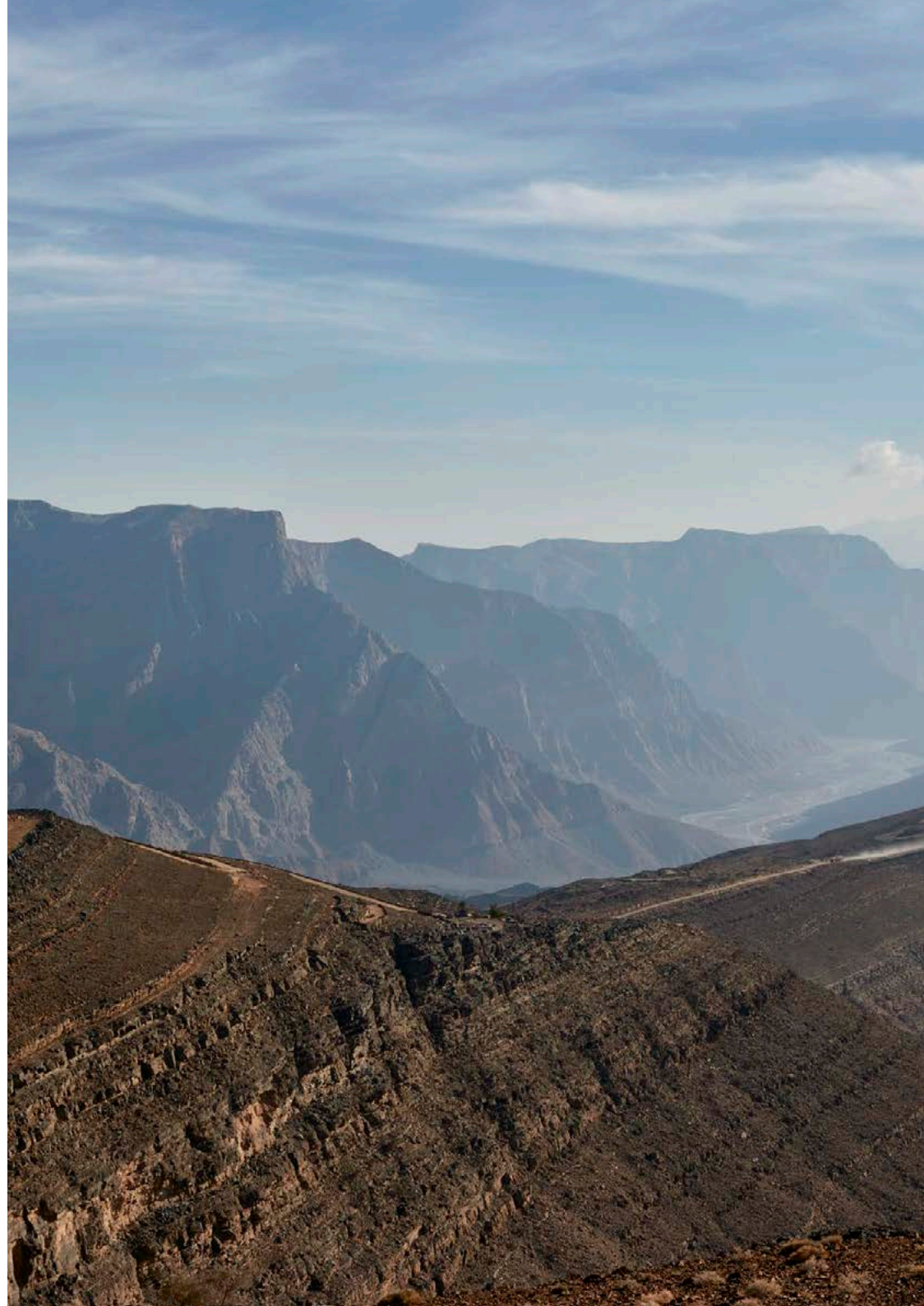







## CONTENTS

### INTRODUCTION

The Concept of the Discovery	6
Discovery – The Facts	8

### DESIGN

Exterior	11
Interior	15
Seven Full-size Seats	19
Remote Intelligent Seat Fold	19
Space and Comfort	20
Storage	21
Powered Inner Tailgate	22
Powered Gesture Tailgate	22
Cargo Space Capacity	24

### DRIVING TECHNOLOGY

Testing	26
All Terrain Technology	29
Terrain Response®	29
All Terrain Progress Control	29
Hill Descent Control (HDC®)	31
Permanent All Wheel Drive Systems	33

Suspension	33
Efficient Technologies	35
On-road Dynamics	36

### TECHNOLOGY

Infotainment	39
Audio	40
Connectivity	42

### DRIVING TECHNOLOGY

Driver Assistance	48
Driving Aids	54
Towing Aids	56

### COMFORT FOR ALL

### ENGINES

8-speed Automatic Transmission	67
--------------------------------	----

### BODY AND CHASSIS

Strength and Stability	68
------------------------	----

### DRIVING AND PARKING AIDS

	70
--	----

### ENVIRONMENTAL

Sustainability	73
----------------	----

### SPECIFICATIONS

Choose Your Land Rover Gear - Accessories	74
---	----

### THE WORLD OF LAND ROVER

	80
--	----

### YOUR PEACE OF MIND

	85
--	----

Vehicle shown: Discovery Landmark Edition in Eiger Grey with optional features fitted.

Vehicles shown are from the Land Rover global range. Specifications, options and availability may vary between markets and should be verified with your local Land Rover Retailer.

## INTRODUCTION

# THE CONCEPT OF THE DISCOVERY

Ever since it first took to the streets, mud tracks and deserts in 1989, the Discovery has blazed its own trail. From Alaska to Zambia, it has become synonymous with capability and versatility, whether off road or in the city. The Discovery takes those characteristics, together with several innovations pioneered by Land Rover, to uncharted territories.

The Discovery is a quantum leap forward in SUV design. A radical and sharply focused approach to embodying Land Rover's vision of the most versatile and capable SUV.

The Discovery combines the flexibility of a beautifully crafted full-size seven seat\* interior, packed full of ingenious design details, with dramatic proportions, clean modern lines and a dynamic silhouette.

## NEW DISCOVERY LANDMARK EDITION

Whether you're in the midst of city life or driving to a secluded Spanish retreat, the Discovery Landmark Edition has been designed to suit every occasion.

\*Available as part of a pack on SE and HSE and standard on HSE Luxury.  
Vehicle shown: Landmark Edition in Eiger Grey with optional features fitted.

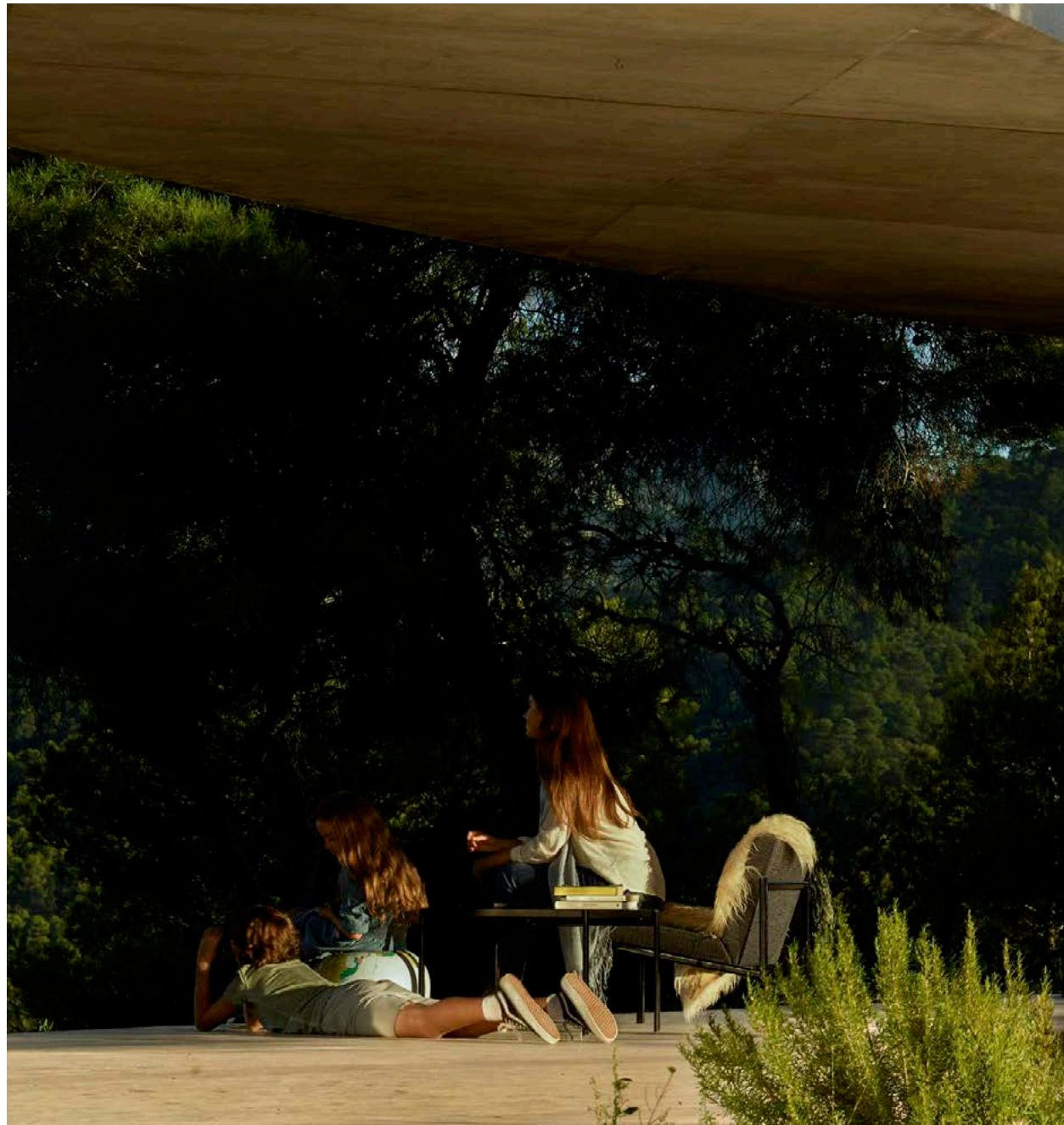



# DISCOVERY – THE FACTS

Form, function and exemplary levels of finesse are brought together to help create one of Land Rover's most compelling vehicles to date. Its inherent strength and off-road capabilities are matched only by its bold contemporary looks and alluring touches of luxury. Inside, astute use of space coupled with high-quality design and use of premium materials enhance the vehicle's bold horizontal and vertical lines.

The versatility of the cabin is highlighted by the easily configurable seven seat<sup>1</sup> layout and plentiful storage, with clever use of space and refined comfort.

## NEW DISCOVERY LANDMARK EDITION

Wherever you go, and whatever you do, the Discovery Landmark Edition has been designed with a distinctive look. This is complemented by key technology enhancements to enrich your driving experience.

\*Do not use Land Rover InControl® features under conditions that will affect your safety or the safety of others. Driving while distracted can result in loss of vehicle control. \*\*These systems are not a substitute for driving safely with due care and attention and will not function under all circumstances, speeds, weather and road conditions etc. Driver should not assume that these systems will correct errors of judgment in driving. Please consult the owner's manual or your local authorized Land Rover Retailer for more details. †Please note that if any action is taken, even minimal steering, the Emergency Braking system will assume the driver resumed control of the vehicle and the system will automatically disengage.

<sup>1</sup>Available as part of a pack on SE and HSE and standard on HSE Luxury and Landmark Edition. <sup>2</sup>Available as part of a pack on HSE and standard on HSE Luxury.

<sup>3</sup>Towing capacity on Si6 engine only. Towing capacity for Td6 engine is 7,716 lbs.

For full feature and option availability please refer to the accompanying Specification Guide or visit your nearest Land Rover Retailer.

Vehicle shown: Discovery HSE Luxury in Namib Orange.

## SEVEN FULL-SIZE SEATS<sup>1</sup> WITH INTELLIGENT SEAT FOLD<sup>2</sup>

The Discovery has the option of three rows of seats with Intelligent Seat Fold, allowing you to configure the second and third row seating using switches located in the cargo space or on the main Touchscreen\*. Furthermore, using technology pioneered by Land Rover, Discovery allows you to remotely configure the seats when you're not in your vehicle, via an app on your smartphone. See page 19 for details.

## ACTIVITY KEY

The optional Activity Key lets you live life to the full. Housed in a robust and fully waterproof wristband, it allows you to pursue a range of activities from sailing to skydiving. See page 65 for details.

## POWERED INNER TAILGATE

This hands-free system provides a seating and loading platform and can also be used as a load retention barrier for when the tailgate is open. See page 22 for details.

## TOWING ABILITY

Over the years, the Land Rover has earned many accolades around the world for its towing capabilities, which is why so many would naturally expect this vehicle to live up to the most demanding expectations. It doesn't disappoint. The Discovery takes it to a new level, delivering an impressive towing capacity of up to 8,201 lbs<sup>3</sup>, ensuring it measures up to the vehicle's proud DNA. See page 56 for details.

## SUPREME CAPABILITY

The vehicle's lineage and DNA are without question. Its all-terrain capability and features such as Terrain Response® 2\*\* help the Discovery to always be ready to get out there and tackle various terrains, no matter where that happens to be. See page 29 for details.



## UNCOMPROMIZED CARGO SPACE CAPACITY

With space ideal for wet or dirty gear, and the flexibility of seven seats<sup>1</sup>, the Discovery is every vehicle you'll ever need. See page 24 for details.

## DRIVER ASSISTANCE FEATURES

Whether you're off-road or in the city, our Driver Assistance technology, available on Discovery, will help to ensure a seamless driving experience. Driver Condition Monitor is designed to detect when you show signs of drowsiness, while Adaptive Cruise Control with Steering Assist automatically moderates the steering, braking and acceleration of your vehicle<sup>\*\*</sup>. Standard driver assistance features include Rear Camera and Emergency Braking<sup>†</sup>. See pages 48-53 for details.



## INTERIOR COMFORT

Passengers enjoy optimum comfort, unparalleled views and benefit from the optional Cabin Air Ionization technology, helping improve the air quality within the vehicle cabin. See page 61 for details.

## THOUGHTFUL STORAGE

From the fold down storage behind the climate controls, to the upper and lower glovebox and a comprehensive space below the center console cup holders, the Discovery has storage in places you simply would not expect. See page 21 for details.

## INTUITIVE CONNECTIVITY

The Discovery features the very latest suite of technologies, including Land Rover InControl<sup>®</sup>, multiple USB ports and the latest in infotainment to keep you and your passengers connected and entertained\*. See page 42 for details.





## DESIGN

# EXTERIOR

The vehicle's exterior design is a revolutionary re-imagining of Land Rover for the next generation.

The Discovery is beautifully proportioned for a full-size SUV, with sleek, wraparound headlights and tail lights combining with short front and rear overhangs to reduce visual length. A pronounced windshield angle, rising belt line and elegant, smoothly contoured shape result in a streamlined and dynamic form, which combines exterior aerodynamics with exceptional interior space. The body-colored c-pillar, stepped roof and asymmetric element on the rear number plate panel all refer to the rich lineage of previous Land Rover model designs.



Clean flush elements, a dynamic rising waistline and wraparound lights convey a strong sense of modernity. Beautifully designed LED lights have been developed to wrap around the side of the vehicle, to enable the indicators to be more visible. LED lights are fitted as standard on SE, HSE, HSE Luxury and Landmark Edition.





The Discovery introduces a new level of refinement, as demonstrated by its beautifully crafted and sculpted surfaces. The distinctive roof and feature lines rising towards the rear of the vehicle give it an assertive, recognizable stance that is further enhanced by the front and rear graphics.

Sophisticated and urbane, the Discovery epitomizes the most compelling, contemporary British design.





## INTERIOR

The highly desirable interior is a re-imagining of the classic Land Rover design elements, with the striking use of strong horizontal and vertical lines connecting through the main dashboard beam. The use of materials such as premium leather, authentic wood and metal trim, coupled with focused craftsmanship and precision, create an air of cultured modern living.

The 10" infotainment Touchscreen\* helps you connect to the outside world and puts a wealth of entertainment and information at your fingertips. The astute use of both seating design and storage space helps deliver exceptional capability for you, your family and friends.

The 12.3" Interactive Driver Display\*<sup>1</sup> ensures you're always entertained, informed and connected. See page 39 for details.

\*Driving while distracted can result in loss of vehicle control. Do not operate, adjust or view the navigation or multimedia systems under conditions that will affect your safety or the safety of others. Only use mobile phones and other devices, even with voice commands, when it is safe to do so.

<sup>1</sup>Standard on HSE and HSE Luxury. Optional on SE and Landmark Edition.

Interior shown: Discovery HSE Luxury in Light Oyster/Espresso.







## UNCOMPROMISING ATTENTION TO DETAIL

An eye for detail. The finest materials. These are the qualities that our designers have carefully considered to help shape the interior. Added to which, sumptuous leather, beautifully finished handcrafted wood veneers, Noble Chrome details, Brushed Aluminum finishers and crafted stitching can be incorporated throughout the interior for added luxury.



Interior shown: Discovery HSE Luxury in Light Oyster/Espresso.





## SEVEN FULL-SIZE SEATS<sup>1</sup>

The seven full-size seats<sup>1</sup> truly exemplify comfort and versatility. Divided across three rows and readily deployable, the Discovery is very well appointed. For instance, the second row enjoys a 60:40 slide and recline configuration, coupled with load through capability. Stadium seating helps ensure everyone can see the road ahead in the greatest comfort, while the stepped roof allows for greater headroom in the second and third rows; such thoughtful use of space ensures everyone travels in comfort. Added to which, there are a number of comfort features available, including heated seats across all three rows and cooled seats on the first and second row.

## REMOTE INTELLIGENT SEAT FOLD<sup>2</sup>

On HSE and HSE Luxury, with third row seats, there's a choice of ways you can easily deploy the seats with our optional Remote Intelligent Seat Fold: from the Touchscreen\*, switches located in the cargo space or via our innovative app from your smartphone. Imagine standing in a grocery line, using your smartphone app to reconfigure the seats in your Discovery to accommodate your shopping bags plus your children.

The powered seat folding mechanism uses an intelligent control system which ensures the seats, including the headrests, fold away seamlessly and conveniently. The system recognizes when seats are occupied or have heavy items on them and, when folding, automatically adjusts their position to prevent interference.

\*Driving while distracted can result in loss of vehicle control. Do not operate, adjust or view the navigation or multimedia systems under conditions that will affect your safety or the safety of others. Only use mobile phones and other devices, even with voice commands, when it is safe to do so.

<sup>1</sup>Available as part of a pack on SE and HSE and standard on HSE Luxury and Landmark Edition. <sup>2</sup>Available as part of a pack on HSE and standard on HSE Luxury.

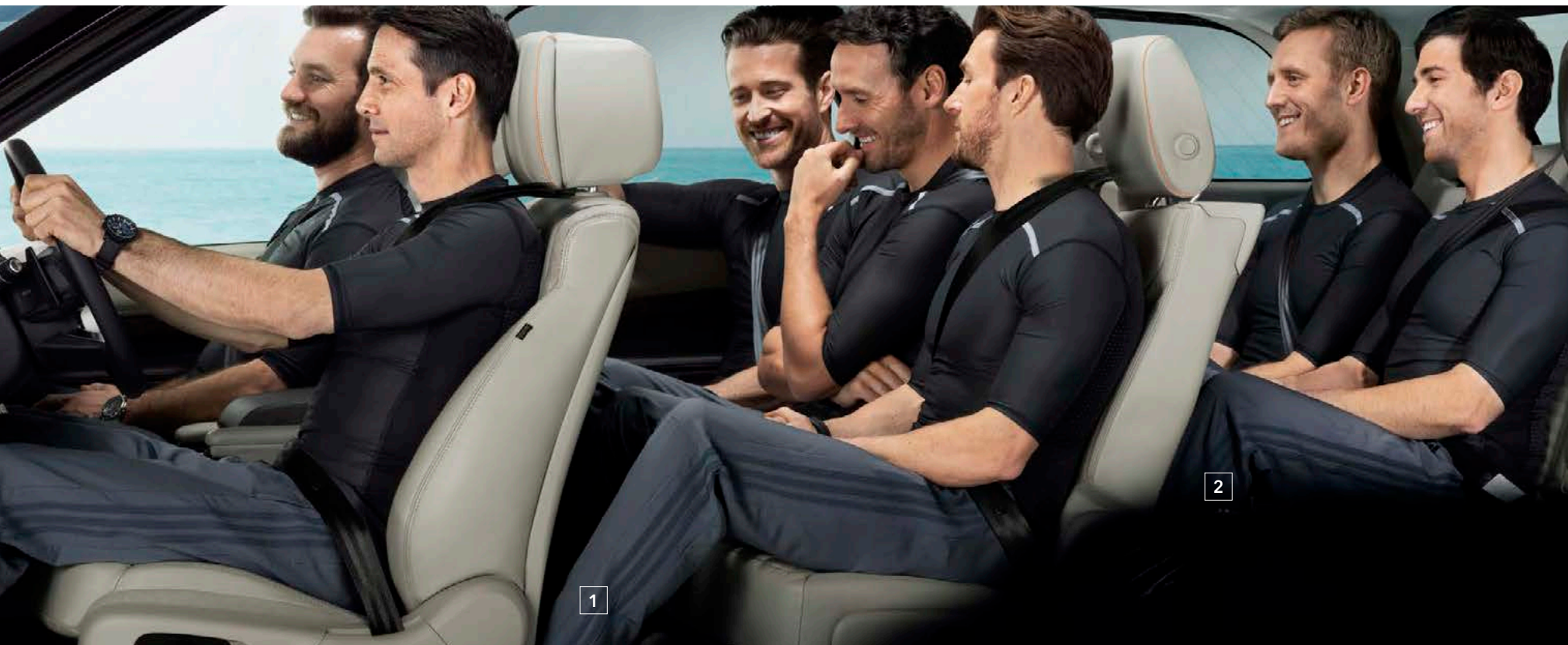

1 Second row legroom 37.6"

2 Third row legroom 33.5"

## SPACE AND COMFORT

Each and every passenger in the Discovery enjoys a truly comfortable ride, with a generous amount of legroom offered. Those in the second row will find they have 37.6", while in the optional third row, a plentiful 33.5" is provided.

Even a team of seven adults can travel in comfort. And with slide and recline specified, you can configure the second row to optimize the available room even further.



Center console storage with an optional cooler compartment



Center console storage behind the climate controls<sup>1</sup>



Cup holders with additional storage beneath<sup>1</sup>



Upper and lower glovebox



Push-operated hook<sup>1</sup>



Third row storage with lid

## STORAGE

The Discovery is brimming with clever spaces in which to store away all those electronic devices and travel guides. From the upper and lower glovebox on SE, HSE, HSE Luxury and Landmark Edition, to central armrest storage with an optional cooler compartment and space for multiple tablets, you'll find space in places you simply wouldn't expect. The central armrest storage box can hinge back 180° to create a flat tray, should second row passengers require more storage, while the door bins can also accommodate 1 liter bottles in the front and 0.5 liter bottles in second row.

Standard on HSE and HSE Luxury, a neatly integrated push-operated hook to hang a small shopping bag sits flush in the front passenger footwell when not in use.

When optional third row seats<sup>2</sup> are selected, third row passengers benefit from individual storage spaces, including one within the side panel. In fact, across all rows there's more than enough space for even the most demanding of families.

<sup>1</sup>Only available on HSE and HSE Luxury. <sup>2</sup>Available as part of pack on SE and HSE and fitted as standard on HSE Luxury and Landmark Edition.



## POWERED INNER TAILGATE

The Discovery features a powered inner tailgate, which when deployed can provide a platform for use at social and sporting events, coupled with greater protection from the elements under the open tailgate. This platform also allows for easier loading and acts as a retainer when the cargo space area is filled. Powered inner tailgate is fitted as standard on all models.



## POWERED GESTURE TAILGATE

Powered gesture tailgate allows you to operate the tailgate (both to open and close) from outside the vehicle without needing to physically touch the vehicle or the smart key.

Provided that the smart key is detected, the tailgate may be operated by foot movement underneath the rear corner of the vehicle.

Two sensors mounted on either side of the tailgate allow curbside operation, rather than needing to be immediately behind the vehicle. And as the system is compatible with towing solutions, you can still open and close the tailgate with the least amount of fuss. Powered gesture tailgate is available as an option on SE and fitted as standard on HSE, HSE Luxury and Landmark Edition.

Additionally, a button located inside the tailgate or on the smart key allows the tailgate to be closed automatically.







## CARGO SPACE CAPACITY

Even when you utilize all seven seats, you can still fit up to three carry-on bags behind the available third row. When it comes to carrying any load, having the option to fold all second and third row seats gives you more options, making life that much easier.

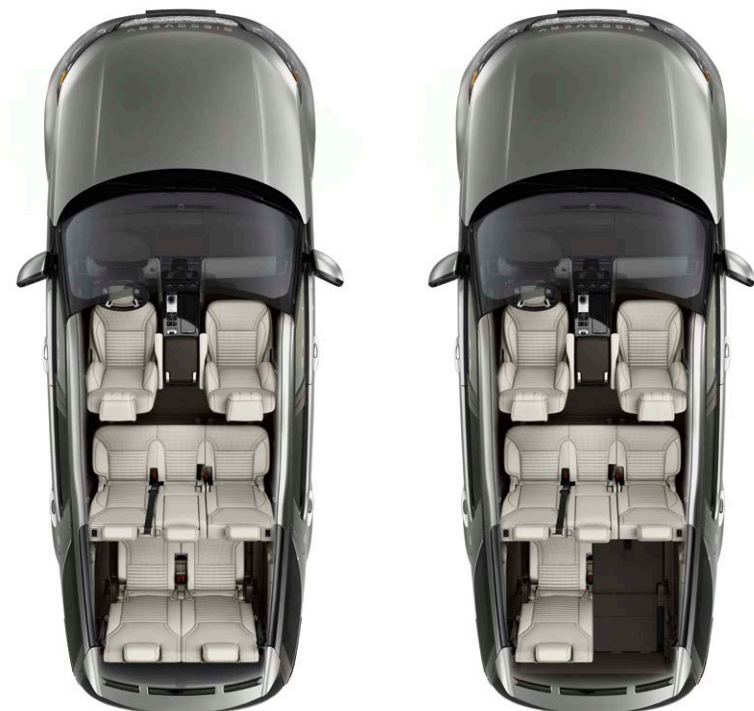

7 SEATS

6 SEATS





5 SEATS



4 SEATS



4 SEATS



3 SEATS



2 SEATS

## DRIVING CAPABILITY

# TESTING

Before any vehicle can carry the Land Rover badge, it must complete a series of rigorous tests to establish the very highest levels of luxury, performance and capability.



### SUSPENSION

You're unlikely to push any Land Rover harder than we have. For an unrivaled breadth of dynamic capability both on and off road, the vehicles have been exposed to the most extreme driving stresses in a fraction of the time using our state-of-the-art test rig.



### WIND SPEED

The Discovery was developed in state-of-the-art wind tunnels and a suite of climatic chambers to recreate some of the most challenging aerodynamic conditions it will face. Only by pushing all systems to their limits do we develop true reliability.



### HOT AND COLD CLIMATE

In real-world environments and our climate chambers, we freeze vehicles to -40°F and bake them to 120°F. Key functions and systems are then scrutinized to our exacting standards. So even in remote locations, comfort is never far away.



### OFF ROAD

From the icy proving grounds of Arjeplog, Sweden, to Dubai's unforgiving desert sands, we ensure our legendary all-terrain performance is innate in every vehicle. Prototypes are developed across approximately 5,300 miles of the most demanding off-road routes.



### SEMI-ANECHOIC CHAMBER

In the 'neutral sound' of our semi-anechoic chamber we precisely expose the cabin to a range of frequencies and vibrations, to help ensure that the Discovery sounds refined at every speed and across every surface.



### MONSOON

Our water testing facilities check that water does not enter the cabin when the vehicle enters and exits a body of water up to the permitted depth. In the monsoon simulator, each one is drenched with some 19,000 gallons of specially dyed water, while tilting it by as much as 45°, checking for even the slightest leak with UV lights.







# ALL TERRAIN TECHNOLOGY

The Discovery not only looks truly at home in its surroundings, but also drives impeccably off-road. Its optimized geometry, coupled with unique Land Rover technologies, ensure it delivers exceptional all-terrain capabilities.

## TERRAIN RESPONSE®

With over 65 years of all-terrain expertise, this vehicle has Land Rover capability at its heart. Our proprietary Terrain Response® systems help the driver to optimize the vehicle's engine, transmission center differential and chassis systems to match the demands of the terrain, by selecting one of the easily identifiable driving modes. It also includes additional Rock Crawl Mode, when your vehicle is equipped with Electronic Air Suspension and two-speed transfer case\*.

## TERRAIN RESPONSE® 2

The optional Terrain Response® 2 system enhances this even further, by monitoring driving conditions and automatically selecting the driving modes to achieve the best possible chassis and powertrain setup for the conditions\*.

 General Driving

 Sand

 Grass, Gravel, Snow

 Rock Crawl

 Mud & Ruts

## ALL TERRAIN PROGRESS CONTROL

All Terrain Progress Control (ATPC)<sup>1</sup> is an optional system that assists you in setting and maintaining a steady speed in challenging conditions.

Operating like a cruise control system, it functions at very low speeds between 1 mph and 18 mph, helping the driver to maintain concentration on steering and finding a path through obstacles.

Developed by Land Rover all-terrain specialists, the system works seamlessly alongside the Terrain Response® 2 and Four Wheel Drive (4WD) traction and braking systems\*.

Once ATPC is activated, the standard steering wheel +/- cruise control buttons are used to set the speed. Brake and accelerator pedals can still override the chosen settings, with gentle braking achieving a reduction in speed.

\*These systems are not a substitute for driving safely with due care and attention and will not function under all circumstances, speeds, weather and road conditions etc. Driver should not assume that these systems will correct errors of judgment in driving. Please consult the owner's manual or your local authorized Land Rover Retailer for more details.

<sup>1</sup>Not available on SE and Landmark Edition.

Vehicle shown: Discovery HSE Luxury in Namib Orange.





## HILL DESCENT CONTROL (HDC®)

Land Rover's patented Hill Descent Control (HDC®) is a standard feature. It assists the driver with controlled descents of difficult slopes by maintaining a constant speed and applying braking separately to each wheel\*.

**Hill Launch Assist** is designed to help prevent the vehicle from rolling backwards as it pulls away on an incline\*.

The vehicle also utilizes **Gradient Release Control (GRC)** which is designed to prevent the vehicle from accelerating too quickly on a steep incline when the driver releases the brake\*.

\*These systems are not a substitute for driving safely with due care and attention and will not function under all circumstances, speeds, weather and road conditions etc. Driver should not assume that these systems will correct errors of judgment in driving. Please consult the owner's manual or your local authorized Land Rover Retailer for more details.

Vehicle shown: Discovery HSE Luxury in Namib Orange.

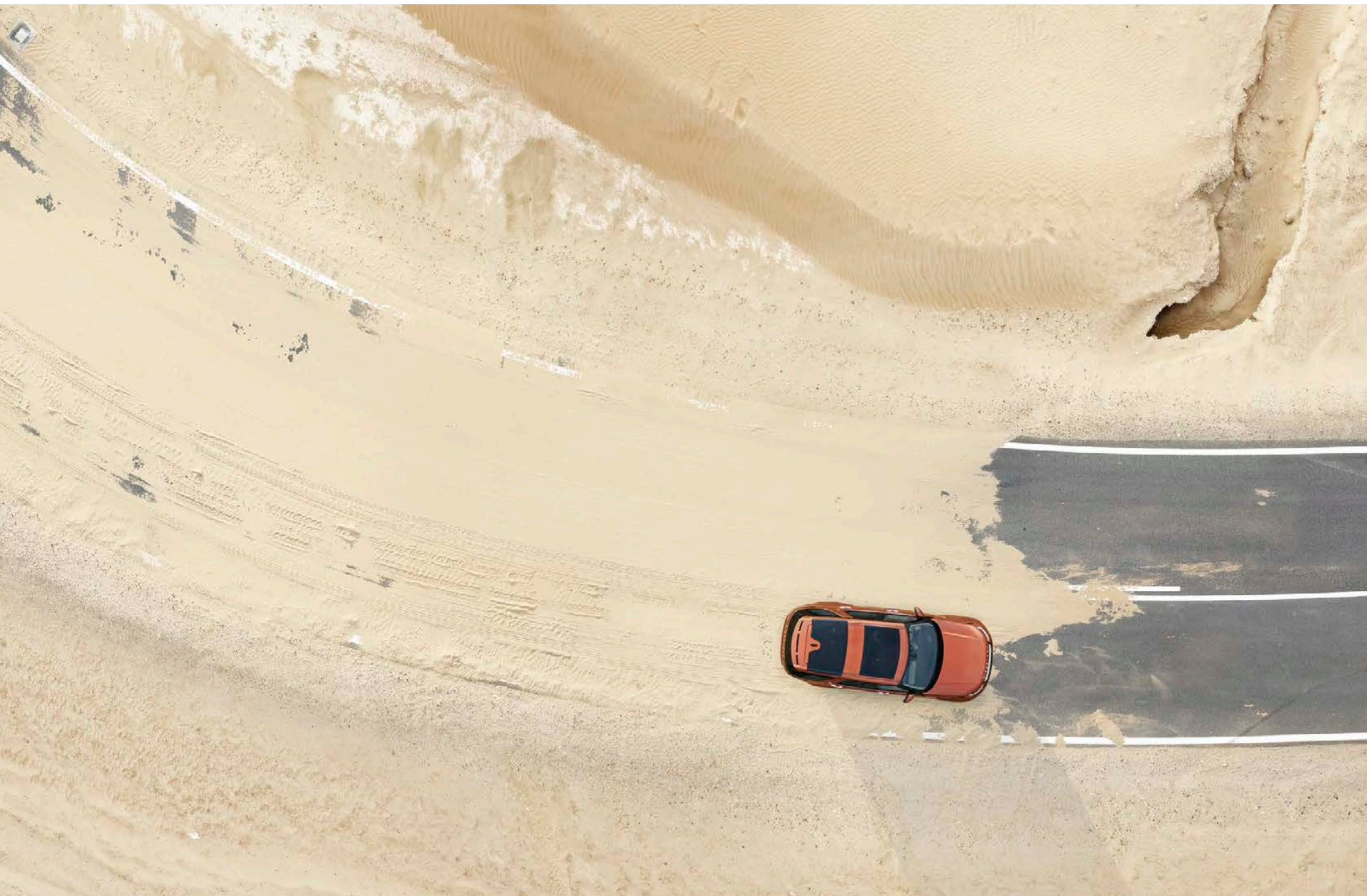



# PERMANENT FOUR WHEEL DRIVE (4WD) SYSTEMS



The Discovery features a choice of intelligent, permanent Land Rover Four Wheel Drive (4WD) systems\* designed to deliver unrivaled capability. You can select from the following systems depending on capability requirements:

## SINGLE-SPEED TRANSFER CASE (HIGH RANGE ONLY)

This system has a single set of high-range, road biased gears with the intelligence to sense wheel slip and move torque to the other axle to provide additional traction. It normally delivers 42 percent drive to the front axle with 58 percent drive biased to the rear axle. The center differential is reactive to wheel slip on one axle and can change the amount of bias to add more torque and traction to the other axle to support. This system is standard on SE and HSE.

## TWO-SPEED TRANSFER CASE (HIGH/LOW RANGE)

A low-range gear set can prove invaluable in challenging conditions such as steep inclines or declines, off-road driving or when towing. This system can help improve control and speed in such instances. The heart of the two-speed system is the electronic center differential that offers a 50:50 torque split between front and rear axles, with the ability to pre-emptively lock the axles before slip commences. Available as a combined option on SE and HSE and standard on HSE Luxury and Landmark Edition.

## ACTIVE REAR LOCKING DIFFERENTIAL

The Active Rear Locking Differential - an option on HSE and HSE Luxury - offers an additional benefit of controlling the slip between the left and right wheels on the rear axle. This can be especially useful in low-grip conditions such as on wet grass, where the vehicle monitors the slip and torque between front and rear axles, and also from one wheel to another on the rear axle to deliver effortless capability.

# SUSPENSION

## COIL SUSPENSION

Standard on SE and HSE, the Discovery has a fully independent coil sprung suspension system that combines double wishbones at the front with an advanced multi-link rear suspension design, to create an agile and responsive chassis.

Ride comfort and stability when heavily laden are optimized through the use of additional secondary springs, incorporated within the rear suspension.

## ELECTRONIC AIR SUSPENSION

A sure-footed, composed drive is completed by the latest four-corner air suspension which provides exceptional wheel articulation and poise.

Capable of taking on tough situations, this system is designed to help keep the Discovery composed even on rough terrain. For unprecedented ride quality, it switches heights seamlessly when necessary.

Air suspension also allows for innovative new access features to enhance versatility and ease of use.

**Automatic Access Height** is a feature which automatically lowers the ride height by 1.6" when the vehicle is parked.

**Rear Height Adjust** allows the use of switches in the cargo space or on the key fob to lower the rear ride height. See page 56 for more information.

Available as a combined option on SE and HSE with two-speed transfer case and standard on HSE Luxury and Landmark Edition.

\*These systems are not a substitute for driving safely with due care and attention and will not function under all circumstances, speeds, weather and road conditions etc. Driver should not assume that these systems will correct errors of judgment in driving. Please consult the owner's manual or your local authorized Land Rover Retailer for more details.

Features and their availability may differ by vehicle specification. Please contact your nearest Land Rover Retailer for more information.

Vehicle shown: Discovery HSE Luxury in Namib Orange.



# EFFICIENT TECHNOLOGIES

## SUSTAINABLE BY DESIGN

Land Rover are committed to producing vehicles that use more sustainable materials, produce less waste and use fewer natural resources as part of our approach to sustainable and responsible business. Land Rover's development process has included a full life-cycle assessment and has been designed to be 85 percent recyclable/reusable and 95 percent recoverable at the end of the vehicle's life.

Our innovative design enables the use of a unique alloy in the vehicle body, made from up to 50 percent recycled aluminum derived from our closed-loop manufacturing process, retaining quality and performance but delivering lower life-cycle CO<sub>2</sub> emissions. Closed-loop manufacturing means taking the scrap from the body pressings process, segregating it and re-melting it back into quality sheet aluminum at our supplier, to be used again to press out body panels, thereby reducing the need to use primary aluminum.

## STOP/START

Discovery engines are all available with Stop/Start. This system shuts down the engine when you come to a complete stop and restarts the engine immediately when required.

## LIGHTWEIGHT MATERIALS

At every stage of the development process, the use of lightweight materials across all the vehicle's elements has optimized the balance between best vehicle performance and weight saving for greater fuel and emissions efficiency. The Discovery adopts an advanced all-aluminum body structure, delivering significantly reduced weight versus traditional materials, improved dynamic performance and enhanced sustainability. Its tailgate is made from a lightweight plastic composite material which is also very stiff and strong, while high-precision lightweight magnesium castings are used for some of the body and chassis components.

## DIESEL EXHAUST FLUID SYSTEM

Diesel models are equipped with a Diesel Exhaust Fluid (DEF) system to help clean exhaust gases. DEF is a non-toxic, non-flammable, biodegradable liquid that cleanses the gases in the vehicle's exhaust system to reduce harmful nitrogen oxide emissions.

## LOW-FRICTION TECHNOLOGIES

The Discovery gas and diesel engine range uses smart coating technologies on pistons, needle roller bearings and other mechanical parts. This helps to reduce friction, especially at low engine temperatures.

## ADVANCED AERODYNAMICS

The modern streamlined design has been carefully optimized using advanced Computational Fluid Dynamics software and a wind tunnel. This has led to an improvement of up to 15 percent drag reduction when compared to its predecessor, while still maintaining stadium seating and two additional seats in the optional third row. An enhanced rear spoiler has been designed with slots to direct airflow over the tailgate, to minimize rear window soiling and produce a reduction in drag.

Vehicles equipped with Electronic Air Suspension benefit from speed lowering, where the vehicle automatically lowers by 0.5" to reduce drag when cruising at highway speeds.



## ON-ROAD DYNAMICS

The Discovery has been designed to deliver a confident, comfortable and engaging driving experience to make the miles go by virtually unnoticed.

With its wide-spaced double-wishbone design at the front and advanced multi-link layout at the rear, the suspension delivers more responsive handling without compromising Land Rover's hallmark all-terrain capability.

Dynamic Stability Control (DSC) monitors the vehicle's dynamic behavior, and it is designed to intervene if the system determines that the vehicle is not responding according to the driver's inputs\*.

The DSC system operates by reducing engine torque and/or applying the brakes on selected wheels to correct the vehicle's cornering attitude, and in addition can counteract understeer or oversteer conditions effectively. This system is standard on all models.

The sublime ride quality is heightened further by such features as Electronic Power Assisted Steering (EPAS), a variable ratio system and speed-sensitive steering. Standard on all models, EPAS is integrated into driver and chassis systems, helping to reduce the engine load to deliver a confident and intuitive drive\*.

The variable ratio system has been tuned to provide ease of control, on or off road, when driving in a straight line or when turning. Different gear ratios within the steering rack help to reduce steering sensitivity when driving straight, but enhances steering input when turning.

Speed-sensitive steering increases the feel of the steering as your speed increases, to give stability and a greater feel of confidence. It also assists you at lower speeds to aid maneuverability by lightening the required steering effort. This system is standard on all models.

\*These systems are not a substitute for driving safely with due care and attention and will not function under all circumstances, speeds, weather and road conditions etc. Driver should not assume that these systems will correct errors of judgment in driving.

Please consult the owner's manual or your local authorized Land Rover Retailer for more details.

Vehicle shown: Discovery HSE Luxury in Silicon Silver.

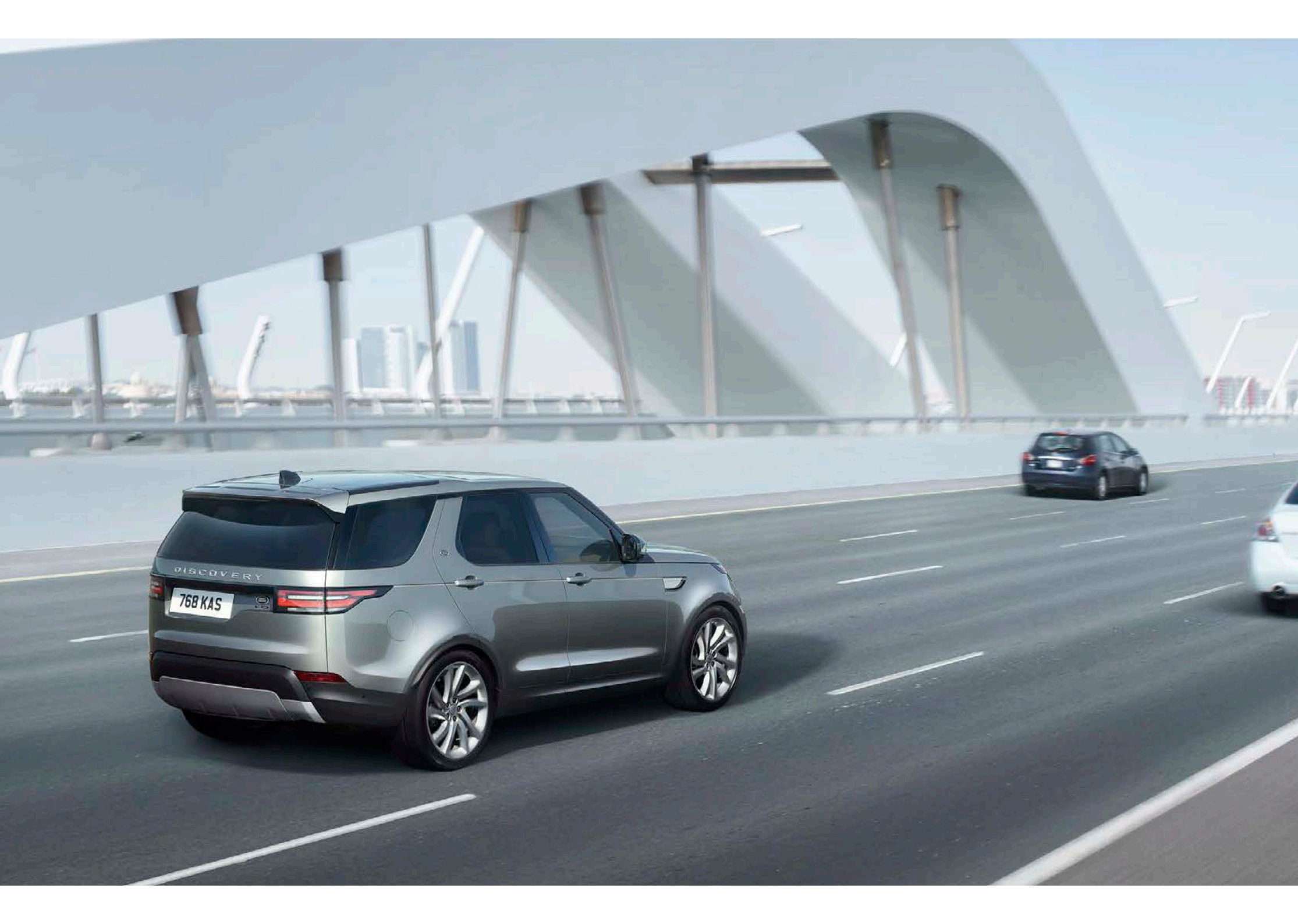



## TECHNOLOGY

# INFOTAINMENT

Unique to Land Rover, the Land Rover InControl® infotainment system Touch Pro not only looks like no other, it performs like no other. Delivering a wealth of information and entertainment, it features intuitive and advanced integrated technologies to ensure everyone can make the most of their trip\*.

Search 'Discovery Infotainment System' for more details.



### TOUCH PRO

Touch Pro is our state-of-the-art infotainment system that connects you to your world, delivers a plethora of entertainment options and puts all the information you need in one place\*.



### INTERACTIVE DRIVER DISPLAY

The Discovery ensures you're always entertained, informed and connected. It features a 12.3" high-definition Interactive Driver Display<sup>1</sup> that can receive and project a vast amount of driving information, entertainment and data including navigation, phone and media. Its high resolution ensures the utmost clarity and its refined processing engine delivers smooth-moving, pin-sharp graphics.



### HEAD-UP DISPLAY

Without distraction or the need for you to take your eyes off the road, our enhanced next generation Head-up Display is an option on HSE and HSE Luxury that presents key vehicle data such as your speed, gear position and navigation directions on the windshield in the most innovative way\*\*. It features crystal-clear, full-color graphics in high resolution, enabling you to see all driver inputs and information with ease. It can display important information from the Touch Pro Touchscreen including phone, as well as information and guidance for off-road driving via the All Terrain Info Center\*. The feature can be turned on and off dependent on driver preference.



### 8" REAR SEAT ENTERTAINMENT

The Rear Seat Entertainment<sup>2</sup> system provides two 8" screens built into the rear of the front headrests. It includes 'Trip Status', a Navigation Summary screen which displays a pop-up for the rear occupant detailing the time and distance to destination. The system comes with a pair of WhiteFire® digital wireless headphones and HDMI, Mobile High-definition Link (MHL) and USB connections.

\*Driving while distracted can result in loss of vehicle control. Do not operate, adjust or view the navigation or multimedia systems under conditions that will affect your safety or the safety of others. Only use mobile phones and other devices, even with voice commands, when it is safe to do so. \*\*These systems are not a substitute for driving safely with due care and attention and will not function under all circumstances, speeds, weather and road conditions etc. Driver should not assume that these systems will correct errors of judgment in driving. Please consult the owner's manual or your local authorized Land Rover Retailer for more details.

<sup>1</sup>Standard on HSE and HSE Luxury. Optional on SE and Landmark Edition. <sup>2</sup>Optional on HSE and HSE Luxury.

WhiteFire® is a registered trademark of Unwired Technology LLC and any use of such marks by Land Rover is under license.

Interior shown: Discovery HSE Luxury in Light Oyster/Espresso.

# AUDIO

A vehicle's cabin is the ideal place within which to experience your personal choice of music, and the Discovery has the option of three different audio systems to bring your music to life:

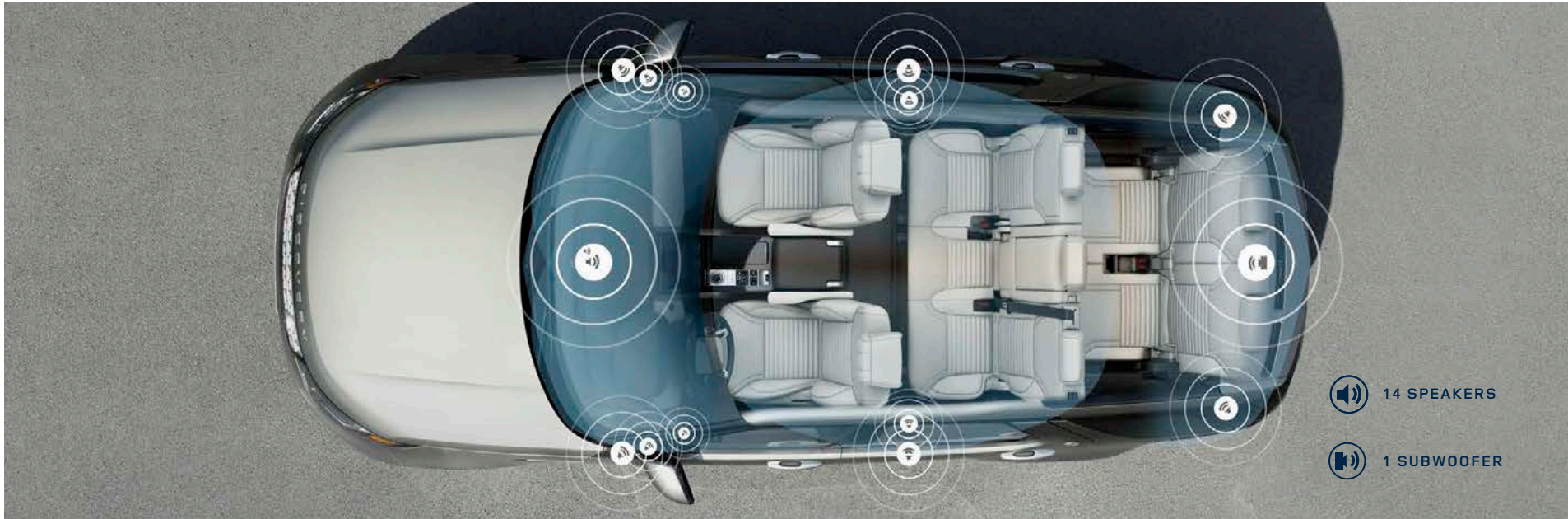

## ENHANCED SOUND SYSTEM

The Land Rover 250W Enhanced Sound System features 10 speakers and is standard on SE models.

## MERIDIAN™ SOUND SYSTEM\*

Great definition, crystal-clear highs and full, deep bass – delivered through this 380W system's careful arrangement of 10 speakers and a dual-channel subwoofer. It is standard on HSE and Landmark Edition and available as an optional upgrade on SE models.

## MERIDIAN SURROUND SOUND SYSTEM

All the fullness and clarity of a live performance delivered through an arrangement of this 825W system's 14 front, side and rear speakers and a dual-channel subwoofer. Seamlessly brought together using Meridian Trifield™ technology and exclusive to Meridian, Trifield perfectly blends the center and surround channels with left and right, ensuring an optimum, consistent sound experience for each passenger. It is standard on HSE Luxury models and available as an optional upgrade on HSE models.

## SIRIUSXM® SATELLITE RADIO AND HD RADIO™

The HD satellite radio technology offers improved sound quality, and a wide choice of stations and entertainment\*. Standard on HSE, HSE Luxury and Landmark Edition and available as an option on SE.

\*A 3-month trial subscription to the SiriusXM All Access pack is included with the vehicle, which gives you access to 150+ channels of premium programming. Plus you can stream SiriusXM on your computer, smartphone or tablet – it's included in your trial. If you decide to continue service after your trial, the subscription plan you choose will automatically renew thereafter and you will be charged according to your chosen payment method at then-current rates. Fees and taxes apply. To cancel you must call SiriusXM at 1-866-635-2349. See the 22 SiriusXM Customer Agreement for complete terms at [siriusxm.com](http://siriusxm.com). All fees and programming are subject to change. SiriusXM satellite radio is not available in Alaska or Hawaii.



## MERIDIAN™

Formed in 1977 in Cambridgeshire, England, Land Rover's audio partner Meridian has pioneered many firsts including active speakers and the world's first digital surround sound processor.

Meridian's audio technology input has helped ensure that the Discovery is one of the most superb spaces within which to experience sound. Meridian Cabin Correction technology was utilized to analyze cabin shape, acoustics and resonance characteristics in order to help remove unwanted sounds.

The advanced algorithm ensures that the rhythm, punch and timing of any piece of music are heard precisely how the artist intended, providing a consistently exceptional quality audio experience for all passengers in the vehicle.



### DIGITAL SIGNAL PROCESSING

Brings all elements of the audio system together as one, for performance that would otherwise require significantly larger speakers.



### MERIDIAN CABIN CORRECTION

The advanced algorithm of Meridian's Cabin Correction tailors the sound experience to the precise acoustics of the Discovery interior.









### MERIDIAN DIGITAL DITHER SHAPING

To maintain the quality of musical recordings, they are converted into a common digital format. Meridian Digital Dither Shaping ensures that digital signal conversions are made smoothly and seamlessly, preserving the finest details of the audio performance. The result is authentic musical conversion, evoking the emotions of the original recording.



### TRIFIELD™

Exclusive to Meridian, Trifield blends the center and surround channels seamlessly with left and right, delivering a consistent, concert-like experience for all occupants.

	UNIQUE MERIDIAN™ TECHNOLOGY	SPEAKERS	DUAL-CHANNEL SUBWOOFER	WATTS
ENHANCED SOUND SYSTEM	N/A	10	N/A	250
MERIDIAN™ SOUND SYSTEM	  	10	1	380
MERIDIAN™ SURROUND SOUND SYSTEM	   	14	1	825



## CONNECTIVITY

Land Rover InControl® is the suite of standard and optional features that connects you to your vehicle and links you seamlessly with the outside world. With a selection of apps, even when you're away from your vehicle some of the InControl features\* stay with you, making sure the Land Rover experience is more enjoyable than ever.

Search 'Discovery Technology' for full details.

\*Do not use Land Rover InControl® features under conditions that will affect your safety or the safety of others. Driving while distracted can result in loss of vehicle control.

## STANDARD FEATURES

### VOICE RECOGNITION SYSTEM

Understands clear spoken instructions, so you can concentrate on the road ahead without distractions\*\*. Voice recognition is a standard feature with Navigation Pro.

### NAVIGATION PRO\*

Fitted as standard on HSE, HSE Luxury and Landmark Edition, Navigation Pro allows you to save your favorite places, use pinch-to-zoom gestures for simple map exploration and can display a choice of either 2D or 3D crystal-clear map graphics. Navigation Pro functionality is further enhanced by Connect Pro.

### CONNECT PRO PACK\*

Connect Pro consists of 4G Wi-Fi Hotspot<sup>1</sup> and Pro Services, and is designed to enhance your in-car and out-of-car experience, ensuring you and your passengers enjoy the journey while remaining connected to the world.

**Pro Services** include:

- **Real Time Traffic Information** - Uses live traffic data feeds to give you the most accurate picture of what the traffic is like on the way to your destination.
- **Online Search** - Wherever you are, you can search the surrounding area for places of interest. The system can access expert destination information, travel tips and inspiration, as well as online travel reviews of the local area.
- **Planning Routes and Door-to-Door Routing** - Before setting off, use the optional Route Planner App or online portal to search, save locations or set your destination. The app uses the Cloud to send your destination automatically to your vehicle's navigation screen. Once you've parked, the Route Planner App will guide you to your destination - a true door-to-door experience which includes public transportation options.
- **Share ETA** - You can share your estimated time of arrival so your selected contact(s) will know exactly when you will arrive, as calculated by the navigation guidance system. If you're running late, Share ETA can then send automatic updates via text messages or email, without any further action from you.
- **Satellite View** - There may be times when you want to get the context of your surroundings from overhead. With Connect Pro you can switch to satellite view with a single tap.

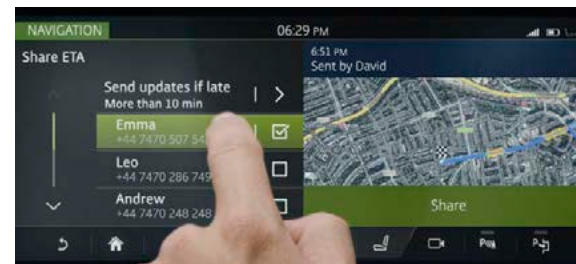
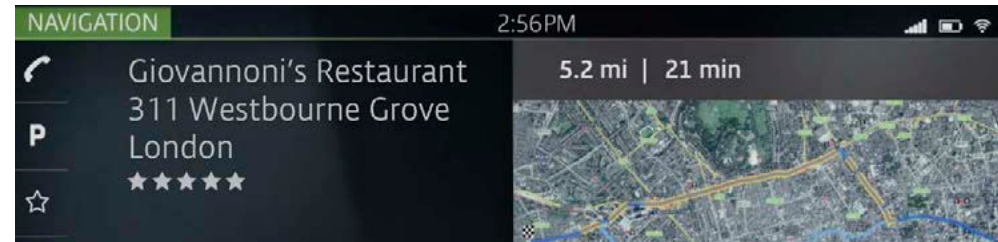

\*\*Driving while distracted can result in loss of vehicle control. Do not operate, adjust or view the navigation or multimedia systems under conditions that will affect your safety or the safety of others. Only use mobile phones and other devices, even with voice commands, when it is safe to do so. <sup>1</sup>Wi-Fi Hotspot is intended for passenger use only. InControl features may require an additional subscription with separate terms and conditions.

## STANDARD FEATURES CONTINUED

### CONNECT PRO PACK\* CONTINUED

- **Commute Mode** - Allows the system to learn your commutes and automatically advises you of the expected travel time based on live and historical traffic movements, without you having to input a destination. The system learns the routes you take for a given destination and then advises which of those is the quickest.
- **Parking Service** - As you approach your destination, you can see where parking is available. Simply tap on your preferred parking and the navigation system updates to direct you to it.
- **Online Media** - Allows for the aggregation of numerous content providers and their personalized content - such as Deezer and TuneIn - that gives access to more than 40 million music tracks and four million on-demand programs and podcasts. For the first time, these can be directly streamed from the vehicle without the need for a smartphone, providing a seamless and integrated experience.

**Remote**<sup>1</sup> app provides upgraded information on your vehicle and enables you to interact with it remotely. Compatible with most smartphones, Android Wear™ or the Apple Watch®, this service includes:

- **Remote Lock/Unlock** - Lock or unlock your doors remotely with the click of a button.
- **Remote Climate** - Prepare your Land Rover in advance by pre-heating or pre-cooling the cabin, so that you and your passengers are comfortable from the moment you step inside.
- **Beep/Flash** - This feature turns on the Land Rover hazard lights, flashes the headlights and sounds an audible alert to help you locate your vehicle.
- **Journey Tracking** - This opt-in feature can automatically record your journey history including your route and mileage statistics. This information can be exported by email to use for expense reporting.
- **Vehicles Status Check** - Check current fuel level and range, and status of door and window position and locks. See the last parked location of the vehicle and find your way back to it with on-foot directions.

### PROTECT

**Land Rover Optimized Assistance**<sup>2</sup> - If you break down you can make a direct call to the Land Rover Assistance team by pressing the button on the overhead console or from the Assistance screen within the InControl Remote smartphone app.

**SOS Emergency Call** - In a more serious incident, SOS Emergency Call will automatically connect you to the emergency response team who will notify the emergency services to your location. For peace of mind, this service is provided for the first 10 years from date of purchase.

### STOLEN VEHICLE LOCATOR<sup>3</sup>

In the event your vehicle is stolen, Stolen Vehicle Locator will assist authorities in recovering your vehicle.

\*Driving while distracted can result in loss of vehicle control. Do not operate, adjust or view the navigation or multimedia systems under conditions that will affect your safety or the safety of others. The Apple CarPlay® and Android Auto user interfaces are products of Apple or Google and their terms and privacy statements apply. The interfaces require compatible iPhone or Android smartphone and message and data usage rates apply. Apple CarPlay® is a registered trademark of Apple Inc. Android and Android Auto are trademarks of Google Inc.

<sup>1</sup>Remote Premium contains subscription services that can be extended after the initial term advised by your Land Rover Retailer. <sup>2</sup>Land Rover Optimized Assistance is a subscription service that can be extended after the initial term advised by your Land Rover Retailer. <sup>3</sup>Stolen Vehicle Locator will require further subscription after the initial term as advised by your Land Rover Retailer. Requires mobile network connectivity.

## SMARTPHONE PACK

By screen sharing with the Land Rover Discovery InControl\*\* infotainment system, the Smartphone Pack helps you stay connected to your smartphone even while in the car. Applications include:

- **Android Auto™** - With a simple and intuitive interface, it is designed to minimize distraction so that you can stay focused on the road. Simply connect your Android smartphone via a USB and control compatible apps on the in-car Touchscreen\*.
- **Apple CarPlay®** - enables the use of apps while allowing the driver to concentrate on the road ahead. Connect your Apple smartphone to your car to use compatible apps such as maps, messages and music through the Touchscreen\*.



\*\*Do not use Land Rover InControl® features under conditions that will affect your safety or the safety of others. Driving while distracted can result in loss of vehicle control. Android Auto is a trademark of Google Inc.



## INTERIOR ELECTRICAL OUTLETS

The Discovery is packed with the latest innovative technologies, and USB charging points are available for all three rows of seats. So no matter where they sit, every single passenger can stay entertained; whether on their tablets, mobile phones or other devices\*.

It includes a 12V port in the upper glovebox, one in the instrument panel, a USB port in the center console, one 12V and two USB ports in the console box, up to two 12V or USB ports in rear center console, two USB ports in the row three storage, one 12V in the luggage compartment, and two additional USB ports when 8" Rear Seat Entertainment is fitted.

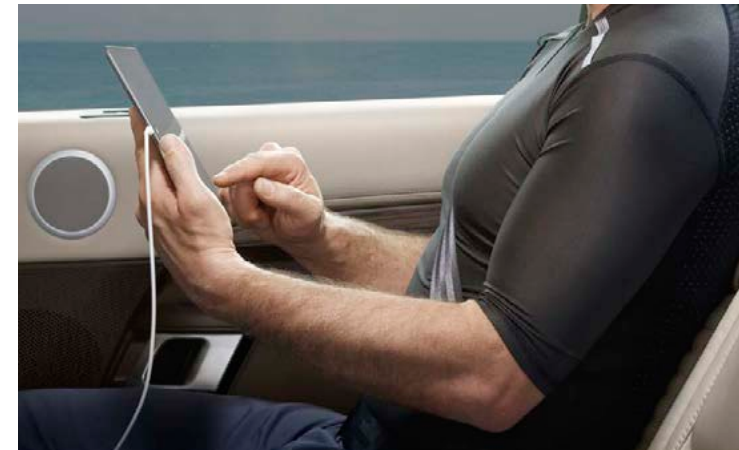

\*Fitment of USB ports and 12V locations varies by trim level.  
Interior shown: Discovery HSE Luxury in Light Oyster/Espresso.

## DRIVING TECHNOLOGY

# DRIVER ASSISTANCE

## EASIER

From negotiating city traffic or the highway to providing additional assistance for you and your passengers, you'll find a range of features designed and engineered to heighten your enjoyment of the vehicle.

Discovery offers some of the most advanced technologies to deliver intuitive and easy parking solutions. Whether reversing, parallel parking or getting into or out of tight spaces, these features make life easier.

Available as standard, optional or as part of an optional pack.

Search 'Discovery Driver Assistance' for more details.

## STANDARD

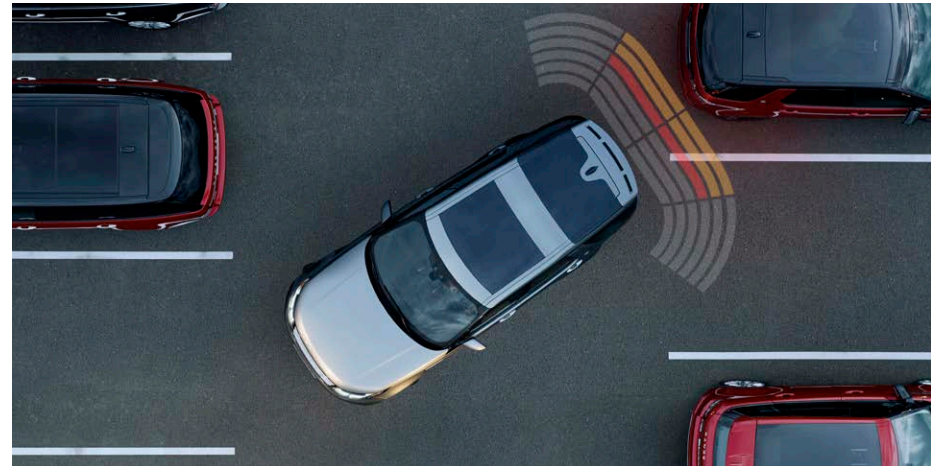

Front and Rear Parking Aid

**Front and Rear Parking Aid** helps make maneuvering even easier. When you select Reverse, or choose to activate them manually, sensors located in the front and rear bumpers are triggered. As you park, the Touchscreen display and audio feedback indicates how close you are to obstacles\*.

**Rear Camera** provides improved visibility when reversing. This valuable parking aid also helps when hitching a trailer. Static lines representing the vehicle's outer perimeter and predicted path are superimposed on the rearward image, designed to make parking in tight spots as easy as possible\*.

**Cruise Control with Speed Limiter<sup>1</sup>** allows the driver to maintain the current speed of the vehicle without the need for continued use of the accelerator pedal, making driving easier and more enjoyable. The Speed Limiter will also allow the driver to preset a maximum specified speed which the vehicle will not exceed. Both functions can be easily turned on or off by the driver as desired\*.

**Driver Condition Monitor** is designed to detect if you're starting to feel drowsy and to give you an early warning when you need to take a break\*.

\*These systems are not a substitute for driving safely with due care and attention and will not function under all circumstances, speeds, weather and road conditions etc. Driver should not assume that these systems will correct errors of judgment in driving. Please consult the owner's manual or your local authorized Land Rover Retailer for more details.

<sup>1</sup>Standard on SE and Landmark Edition.



## STANDARD

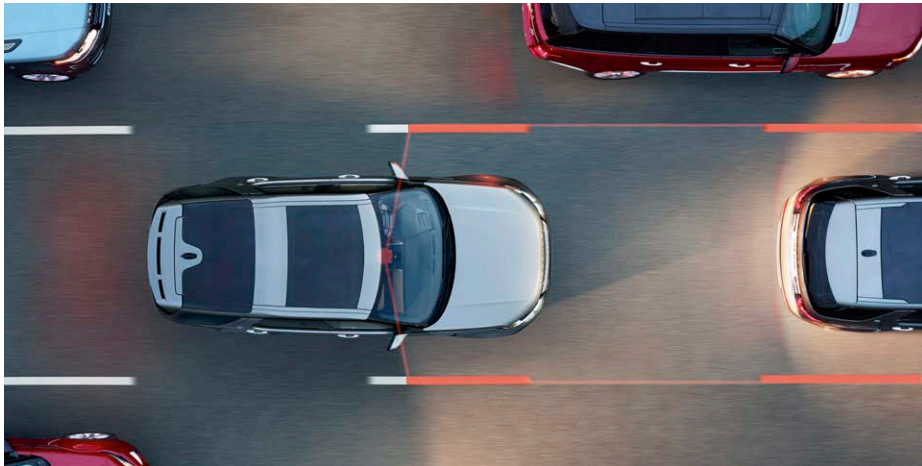

Lane Keep Assist

**Lane Keep Assist** is designed to detect when your vehicle is unintentionally drifting out of your lane, and to help apply a corrective steering torque to the steering wheel encouraging you to gently steer you back\*.

**Adaptive Cruise Control<sup>2</sup>** is designed to keep your vehicle a set distance from the one in front should it slow or stop when you're cruising on the highway or traveling in slow-moving traffic. Should the vehicle in front stop completely, your vehicle will come to a smooth halt. In stop-start traffic, Adaptive Cruise Control will automatically resume following the car in front. The system can be activated from 13 mph and once activated will operate between 0-60 mph\*\*.

**Emergency Braking** can detect an imminent forward collision with other vehicles or pedestrians and can assist to mitigate the potential for a collision, and a warning is displayed to alert you to take action. A camera at the front of the vehicle monitors at speeds from 3 to 50 mph for frontal collisions and 3 to 37 mph\*\* for pedestrians. If a collision is still anticipated and you have taken no action<sup>†</sup>, this system will apply the brakes to help reduce the severity of the possible impact\*.

\*\*Always follow local speed limits. <sup>†</sup>Please note that if any action is taken, even minimal steering, the Emergency Braking system will assume the driver resumed control of the vehicle and the system will automatically disengage.

<sup>2</sup>Standard on HSE and HSE Luxury models. <sup>3</sup>Standard on all models.

## OPTIONAL

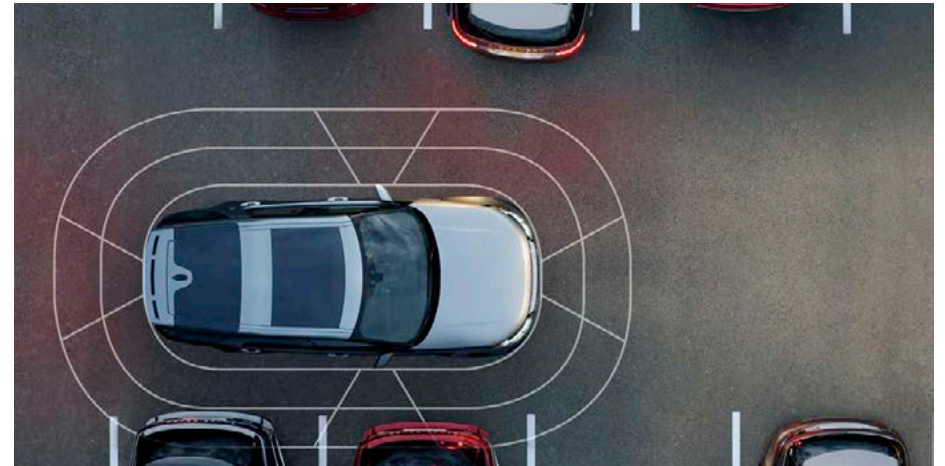

360° Surround Camera

**360° Surround Camera** uses four digital cameras discretely placed around the vehicle, providing a 360° overhead view on the Touchscreen. With the capacity to display several different views at the same time, this helps with various maneuvers from parking by a curb, to getting in and out of tight spaces and intersections\*.

**Blind Spot Assist<sup>3</sup>** can help detect another car in your blind spot when you begin to change lanes, a small warning light illuminates in the corresponding wing mirror. Corrective torque is also applied to the steering wheel, encouraging you to guide your vehicle away from the approaching vehicle.

# PACKS

A range of packs are available featuring technologies to enhance the driving experience. Available as standard, Park Pack is designed to help you park and maneuver more easily in and out of tight spaces, and into traffic that is obscured by buildings or other vehicles. While the optional Drive Pack makes every journey more relaxing. The Drive Assist Pack contains the most comprehensive suite of drive and park technologies.

## PARK PACK

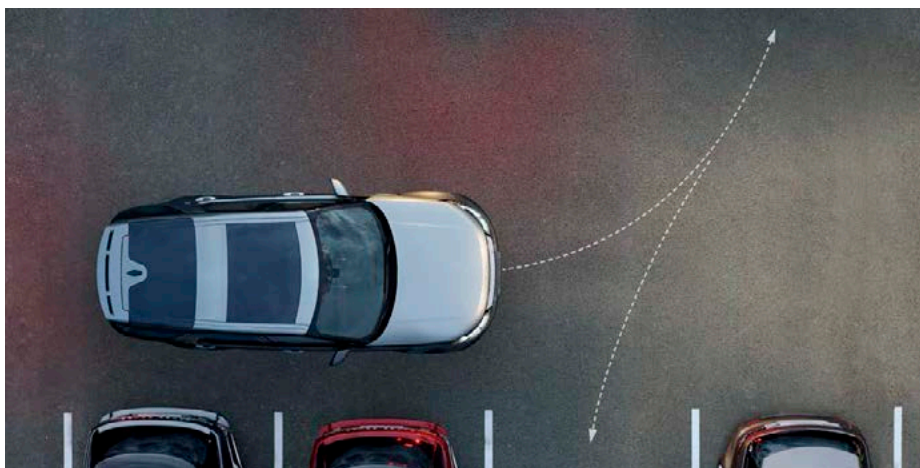

Park Assist

**Park Assist** makes parallel and perpendicular parking easier than ever, by steering your vehicle into a suitable space. You just have to select the appropriate gear and control the vehicle's speed with the brake and accelerator pedals. Graphics and notifications guide you through the maneuvers. Park Assist will also steer you out of a space\*, reducing the stress of parking\*\*.

**Rear Traffic Monitor** is particularly useful when reversing out of a parking space. The system is designed to warn of vehicles, pedestrians or other hazards approaching from either side of your vehicle and will alert you with both audio and visual warnings, so you know what's behind you even when the view is obstructed.

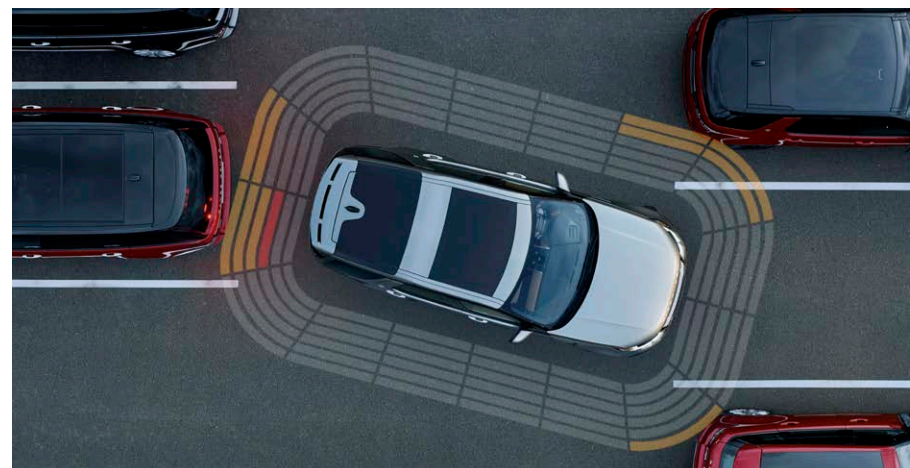

360° Parking Aid

**360° Parking Aid** gives you confidence when maneuvering in tight spaces. Sensors located around the vehicle are automatically triggered when Reverse is selected, or can be manually activated, with a graphic appearing on the Touchscreen showing an overhead view of the vehicle. As you park, the Touchscreen display and audio feedback indicates how close you are to obstacles\*\*.

**Clear Exit Monitor** is designed to alert passengers leaving the vehicle from the rear doors to any approaching cars, cyclists or other hazards. If an incoming obstacle is detected, a warning light will flash on the door.

\*Park Assist is only programmed to steer you out of a parallel parking space.

\*\*These systems are not a substitute for driving safely with due care and attention and will not function under all circumstances, speeds, weather and road conditions etc. Driver should not assume that these systems will correct errors of judgment in driving. Please consult the owner's manual or your local authorized Land Rover Retailer for more details.

## DRIVE PACK<sup>1</sup>

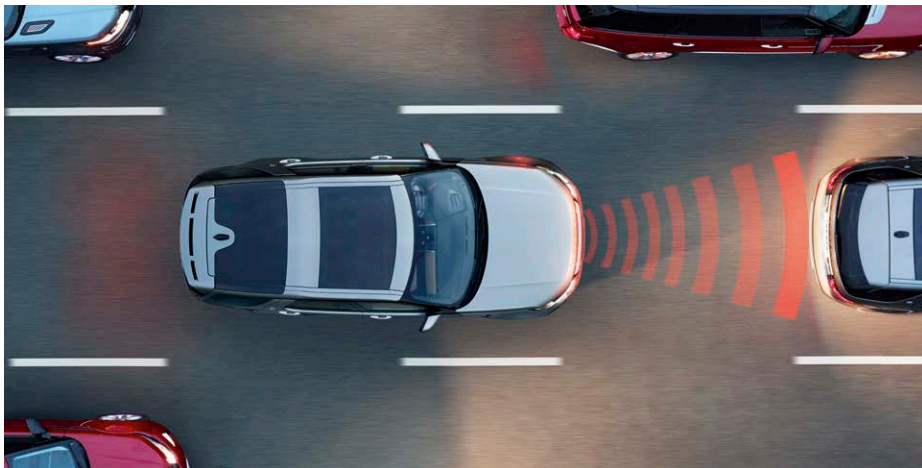

Adaptive Cruise Control

**Adaptive Cruise Control** See page 49 for description.

**High-speed Emergency Braking** is designed to detect when a potential frontal collision with another vehicle may occur, and displays a forward alert to warn the driver to brake. If the driver doesn't react<sup>†</sup>, the vehicle will deploy the brakes in order to help reduce the severity of the possible impact<sup>\*\*</sup>. High-speed Emergency Braking is ready and active from 6 mph to 99 mph<sup>††</sup>.

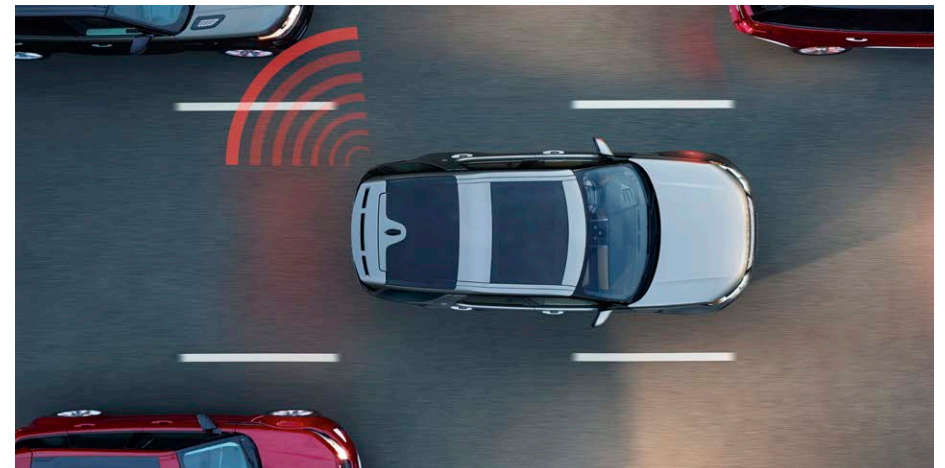

Blind Spot Assist

**Blind Spot Assist** See page 49 for description<sup>\*\*</sup>.

**Traffic Sign Recognition and Adaptive Speed Limiter** keeps you informed and aware on the road, by displaying speed limits and 'no passing' signs in the instrument cluster, where they can easily be seen. When activated, Adaptive Speed Limiter uses Traffic Sign Recognition information to adjust your vehicle's speed accordingly<sup>\*\*</sup>.

<sup>†</sup>Please note that if any action is taken, even minimal steering, the High-speed Emergency Braking system will assume the driver resumed control of the vehicle and the system will automatically disengage. <sup>††</sup>Always follow local speed limits.

<sup>1</sup>Only available on SE and Landmark Edition. Standard on HSE and HSE Luxury models.

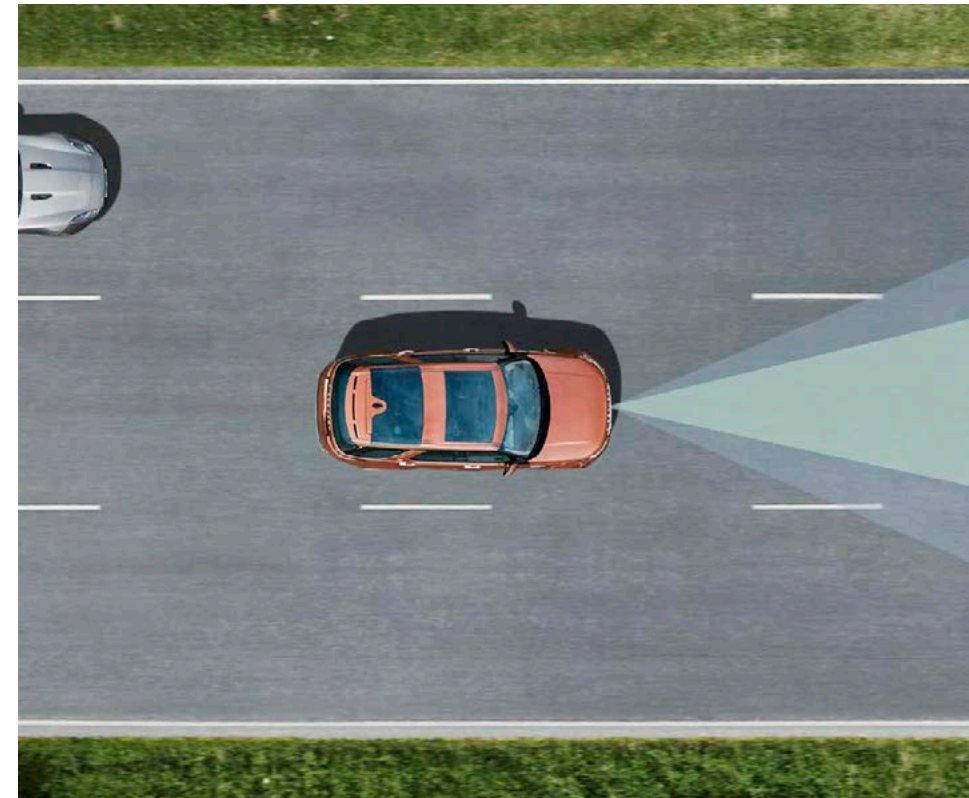

## DRIVER ASSIST PACK

The optional Driver Assist Pack offers a wide range of driver aids, including the features found in both the Park Pack and Drive Pack (see pages 50 and 51) together with 360° Surround Camera, Park Assist, 360° Parking Aid, Rear Traffic Monitor and High-speed Emergency Braking\*. It also includes Adaptive Cruise Control with Steering Assist which centers the vehicle in lane and maintains a set distance from vehicles ahead, making driving even easier and more comfortable\*\*.

 FRONT CAMERA 393 ft

 FRONT RADAR 524 ft

\*Please note that if any action is taken, even minimal steering, the High-speed Emergency Braking system will assume the driver resumed control of the vehicle and the system will automatically disengage.  
 \*\*These systems are not a substitute for driving safely with due care and attention and will not function under all circumstances, speeds, weather and road conditions etc. Driver should not assume that these systems will correct errors of judgment in driving. Please consult the owner's manual or your local authorized Land Rover Retailer for more details.

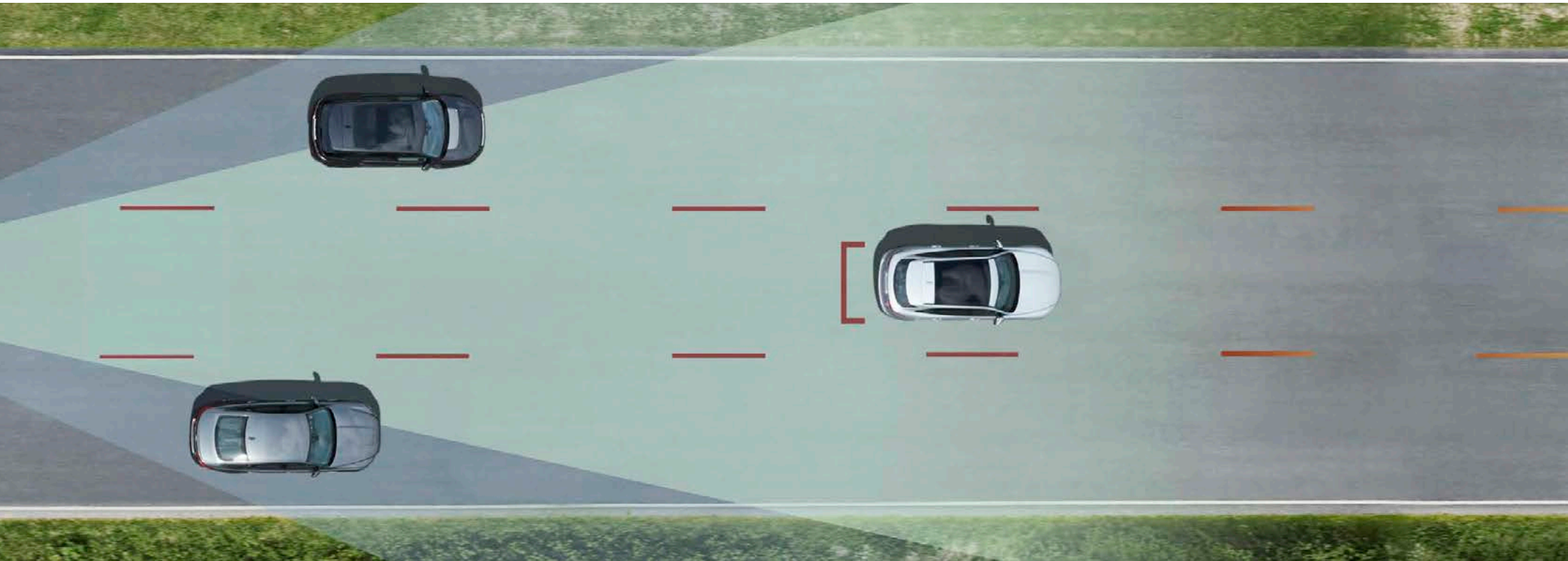

## ADAPTIVE CRUISE CONTROL WITH STEERING ASSIST

Adaptive Cruise Control with Steering Assist works with you, assisting with steering, braking and acceleration as you keep your hands on the wheel and anticipate the road ahead. A camera and radar then work together to track lanes ahead to maintain a central position for your vehicle, and help moderate its speed according to the behavior of the traffic in front of you\*\*.

If the vehicle ahead slows, even to a standstill - the feature automatically slows your vehicle, bringing it to a stop where necessary to maintain a relaxed but attentive, composed drive in busy traffic situations. Should you remove your hands from the wheel, the vehicle will provide a warning. If the warning is not heeded then the Steering Assist is deactivated, but the Adaptive Cruise Control will remain active\*\*.

# DRIVING AIDS



## LOW TRACTION LAUNCH\*

The Discovery features a dedicated launch function, which is designed to assist launching on tricky low-friction surfaces like snow or wet grass. The software adapts the system's behavior according to the current Terrain Response® setting. When you pull away, the system helps you do so with composure and greater ease.

\*These systems are not a substitute for driving safely with due care and attention and will not function under all circumstances, speeds, weather and road conditions etc. Driver should not assume that these systems will correct errors of judgment in driving. Please consult the owner's manual or your local authorized Land Rover Retailer for more details. \*\*Driving while distracted can result in loss of vehicle control. Do not operate, adjust or view the navigation or multimedia systems under conditions that will affect your safety or the safety of others. Only use mobile phones and other devices, even with voice commands, when it is safe to do so.

Vehicle shown: Discovery HSE Luxury in Namib Orange.

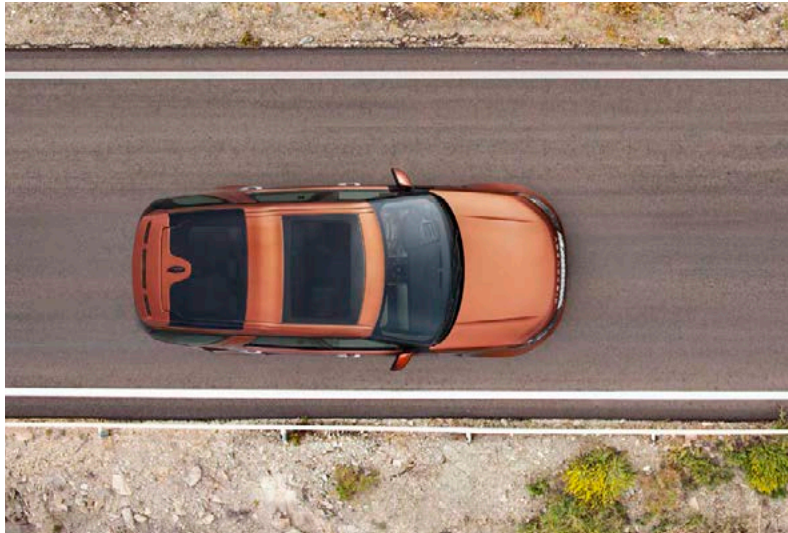

## ALL TERRAIN INFO CENTER



The All Terrain Info Center<sup>1</sup> within your navigation system allows you to view and activate various features, and provides access to All Wheel Drive (AWD) information and guidance features for off-road driving\*.

The Touchscreen\*\* displays information about the vehicle's wheels, suspension, transmission and driveline including suspension movements and articulation for vehicles with Electronic Air Suspension.

The system can show the angle and pitch of the vehicle on slopes and inclines, and includes a useful compass together with current latitude, longitude and altitude details.

The Info Center provides a host of other helpful guidance such as vehicle dimensions – useful for entering tighter spots – and can be used to activate additional capability features, such as low traction launch\*.

Using the optional 360° Surround Camera\*, the Info Center can also show the area directly ahead of the vehicle that may not be visible to the driver, to help reduce the possibility of damaging the vehicle on unseen terrain.

<sup>1</sup>The number of features displayed on the All Terrain Info Center is dependent upon the specification of the vehicle.  
Interior shown: Discovery HSE Luxury in Light Oyster/Espresso.

# TOWING AIDS

The Discovery takes towing capability to a new level, with a capacity of up to 8,201 lbs<sup>1</sup> and a suite of features available to help make towing effortless and assured.

## 1 TOW HITCH ASSIST

Tow Hitch Assist\* makes coupling a trailer to the vehicle much easier, by helping you visualize the hitching process; it displays the predicted path of the vehicle tow ball towards the trailer coupler on the Touchscreen. Standard with 360° Surround Camera.

## 2 REAR HEIGHT ADJUST

Rear Height Adjust allows the use of switches in the cargo space or on the key fob to lower the rear ride height - useful when loading or unloading cumbersome items, or when hitching, unhitching or loading a trailer. This feature is included with Electronic Air Suspension.

## 3 TOW ASSIST

On the road, the Tow Assist feature helps with reversing by predicting the trailer's direction\*. You can even choose your trailer's width for precise guidelines displayed on the Touchscreen. Standard with 360° Surround Camera.

\*These systems are not a substitute for driving safely with due care and attention and will not function under all circumstances, speeds, weather and road conditions etc. Driver should not assume that these systems will correct errors of judgment in driving.

<sup>1</sup>Towing capacity on Si6 engine only. Towing capacity for Td6 engine is 7,716 lbs.

Please ensure you comply with relevant legislation in the USA.

Vehicle shown: Discovery HSE Luxury in Namib Orange.







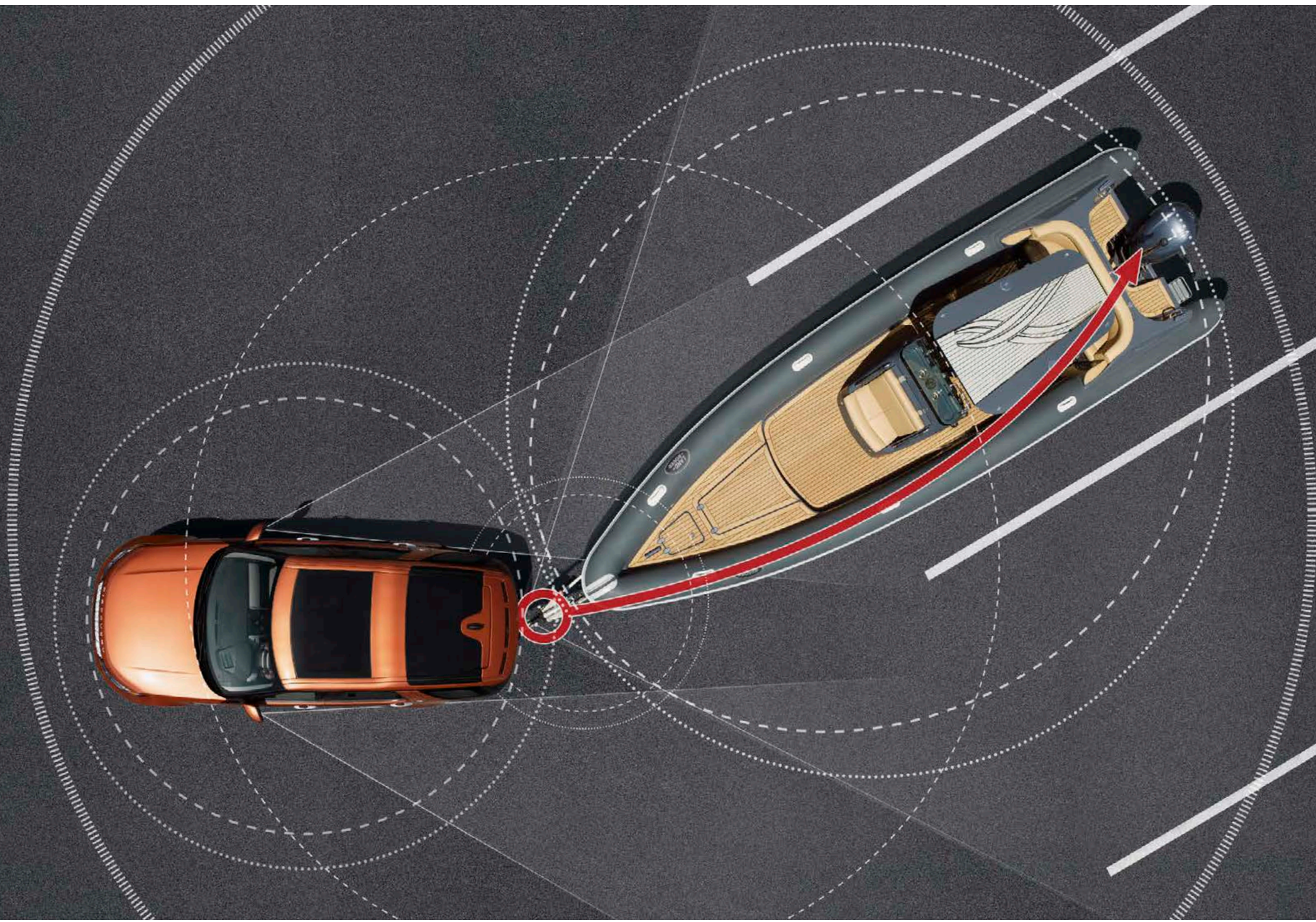



### ADVANCED TOW ASSIST

The Discovery features our most advanced trailer reversing aid. Advanced Tow Assist\* enables the driver to guide a trailer into position by simply following its trajectory on the main Touchscreen, and controlling its path using the rotary knob from the Terrain Response® 2 system on the center console\*. This is much more intuitive than using the steering wheel because within one field of vision, it effectively steers the trailer along the desired path. This is rather than the opposing direction method, which is what happens with conventional steering.

In addition to significantly reducing driver workload, the feature enhances maneuverability when reversing, and will alert the driver when approaching a jackknife situation. Advanced Tow Assist is only available with Surround Camera, Electronic Air Suspension, twin-speed transfer box and Terrain Response®. A Land Rover approved tow hitch receiver is required in order to enable this feature. Not available on SE and Landmark Edition.



### 360° SURROUND CAMERA\*

For a complete, all-round view, the optional 360° Surround Camera\*, incorporating intersection view, helps to see everything clearly on the high-resolution full-color Touchscreen. Using four digital cameras discreetly placed around the vehicle, the system provides an almost complete 360° view, including a bird's-eye overhead view. It is perfect for more complex driving assignments such as towing a sailboat or horse trailer. Along with the ability to display several different views at the same time, this technology can also zoom and pan, ensuring objects and angles normally below the line of sight can be seen\*.

### TRAILER STABILITY ASSIST

Trailer Stability Assist (TSA) monitors the vehicle to detect movements in the trailer, and then uses selective braking to help correct potentially hazardous situations\*.

\*These systems are not a substitute for driving safely with due care and attention and will not function under all circumstances, speeds, weather and road conditions etc. Driver should not assume that these systems will correct errors of judgment in driving. Please consult the owner's manual or your local authorized Land Rover Retailer for more details.

Before towing, please consult the owner's manual or your local Land Rover Retailer for more details.

Vehicle shown: Discovery HSE Luxury in Namib Orange.



## COMFORT FOR ALL

### AUTOMATIC ACCESS HEIGHT

It's always good to arrive in style, so that's why we've introduced Automatic Access Height\*. When you pull up at your chosen destination and the ignition is switched off or the seat belts are unclipped, the vehicle lowers by an initial 0.6". Then, as you open the door, it drops to its full access height of 1.6" lower, making exit - and entry - that much more relaxed and elegant. The ride height automatically returns to its normal height as you pull away.

### GARAGE DOOR OPENER (HOMELINK®)

The HomeLink® system is a universal transmitter fitted to the underside of the interior rear view mirror. This transmitter can be programmed to operate up to three home or office wireless controlled systems, such as garage doors, automatic gates, or security lighting. By replacing the individual remote control units normally required for each system, the driver no longer needs to search the car interior for the correct remote when needed.

### CABIN AIR IONIZATION

This optional nanoe™ technology enhances the wellbeing of both driver and passengers alike. It improves the air quality within the vehicle cabin by ionizing particles in the air, making them attract to surfaces and thus helping cleanse the air. It can be switched on or off.

\*Standard with Electronic Air Suspension.

HomeLink® is the registered trademark of Genex Corporation.

Vehicle shown: Discovery HSE Luxury in Silicon Silver.

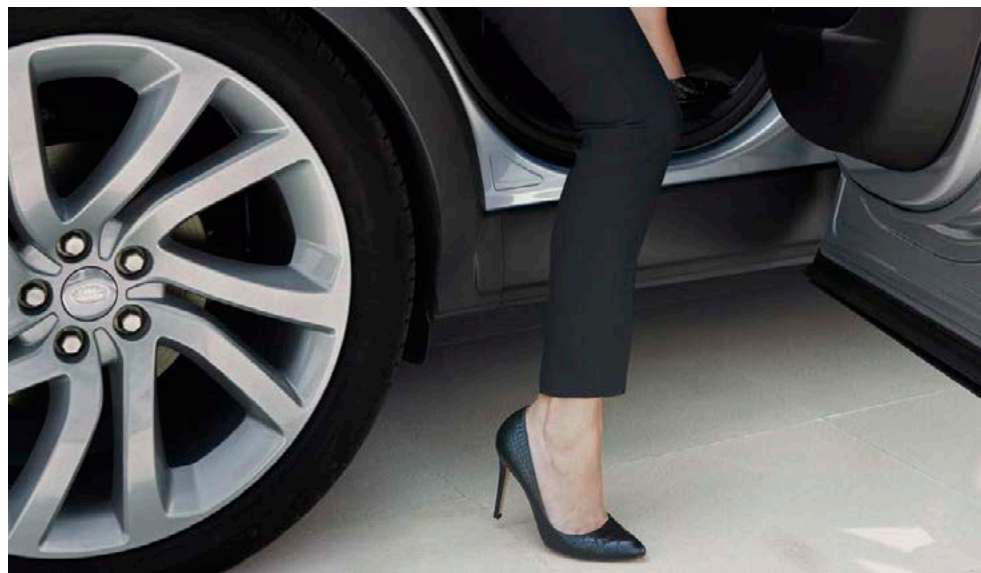
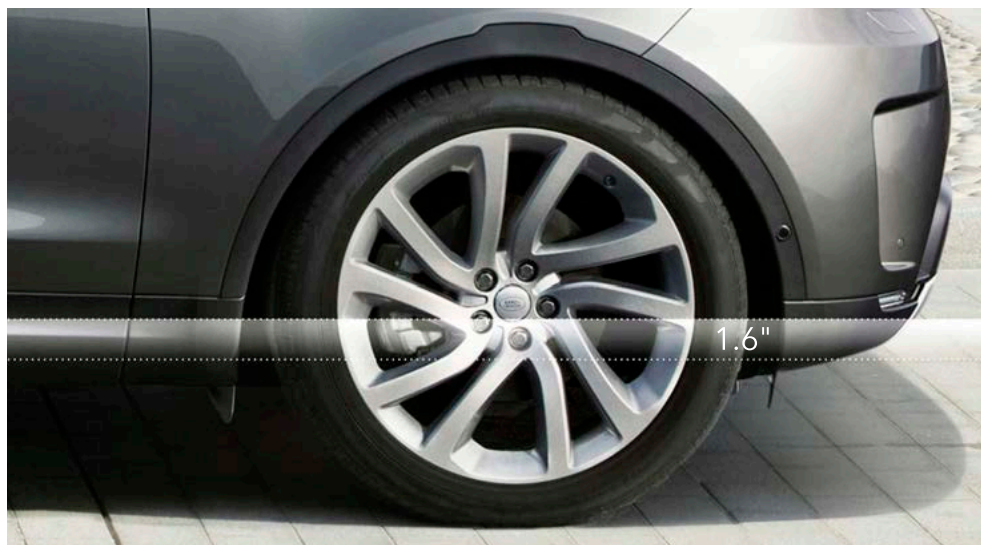



## PANORAMIC ROOF

The fixed front and rear panoramic roof<sup>1</sup>, or sliding front sunroof and fixed rear panoramic roof<sup>2</sup>, enhance the sense of space in the vehicle's interior and flood it with natural light. This benefits all three rows where specified, as well as providing enhanced views of the surrounding environment.

Importantly, the toughened glass has a dark tint to maintain a comfortable temperature inside the cabin, and protect occupants and the interior from the sun's rays. Powered interior blinds are also provided for added comfort.

## CONFIGURABLE AMBIENT INTERIOR LIGHTING

New levels of ambient refinement and personalization have been reached with Configurable Ambient Interior Lighting, standard on HSE Luxury.

This feature allows you to vary the color and brightness, changing the ambience of the cabin to suit your mood. There are five colors in total, ranging from Ice White through to Moonlight and Racing Red.

## CLIMATE CONTROL

To ensure that the interior is maintained at the perfect temperature, whatever the weather outside, the Discovery features a highly efficient climate control system. The result of an incredibly rigorous development program, the system has been tested in real-world conditions in temperatures ranging from -40°F to +120°F.

Three versions are available, ranging from a two-zone automatic system to a four-zone automatic system. A premium four-zone system is available as an option on all models, which has separate climate controls for driver, front passenger and each side of the rear cabin.

With its independent heating and cooling capability, the four-zone system offers a significant improvement in rear seat luxury, with multiple outlets at face and foot level.

## SEATING

Heated front and rear seats are available as part of a pack on SE and HSE and fitted as standard on HSE Luxury and Landmark Edition.

No matter the temperature, heated and cooled front and second row outboard seats are also available as an option HSE and HSE Luxury. This enables both the driver and passenger to set their preferred temperature independently, and is controlled via the Touchscreen.

For the ultimate in comfort, optional massage front seats are available on HSE Luxury, allowing both the driver and front passenger to select individual programs via the Touchscreen. Varying in intensity, there are five settings to choose from; each one delivers a soothing massage to improve both the driver and passenger's comfort.



<sup>1</sup>Standard on SE and Landmark Edition. <sup>2</sup>Standard on HSE and HSE Luxury. Optional on SE and Landmark Edition.

Features and their availability may differ by vehicle specification. Please contact your nearest Land Rover Retailer for more information.

Interior shown: Discovery HSE Luxury in Light Oyster/Espresso with Four-zone Climate Control.







## ACTIVITY KEY

The Activity Key makes living life to the fullest easier. For convenience, you can wear the Activity Key if you prefer not to carry a key fob. The wristband is robust and fully waterproof, allowing you to enjoy a range of activities - from sailing to skydiving - and keep your car key with you. The Activity Key has been tested in a number of extreme environments and is therefore capable in depths of up to 98 ft. of water and in temperatures ranging from -40°F to +185°F.

You can use the Activity Key to lock and unlock your vehicle. When exiting, you can secure the conventional key fob in the vehicle and hold the Activity Key to the tailgate to lock it. The conventional key fob is then automatically deactivated for security. Enjoy the Activity Key as an optional feature with SE, HSE, HSE Luxury and Landmark Edition, or as a Land Rover Retailer-fit accessory.





## ENGINES

# 8-SPEED AUTOMATIC TRANSMISSION

Both gas and diesel engines are paired with the advanced, electronically controlled 8-speed Automatic Transmission, which has been tuned to combine silky-smooth shifting with exceptionally rapid response. With eight closely spaced ratios, gear changes are almost imperceptible, with each shift completed in just 200 milliseconds.

Controls include steering wheel-mounted paddle shifters, enabling the driver to take control of gear shifting manually.

The optimized lightweight 8-speed Automatic Transmission is the perfect partner to the torque-rich engines.

The transmission is tuned to select torque converter lock up as early as possible to reduce slip and energy loss. Transmission idle control disengages 70 percent of the drive when the vehicle is stationary and the engine is idling in Drive.

In cold conditions, the transmission selects a lower gear to promote fast warm up and get the engine up to its efficient operating temperature as soon as possible.

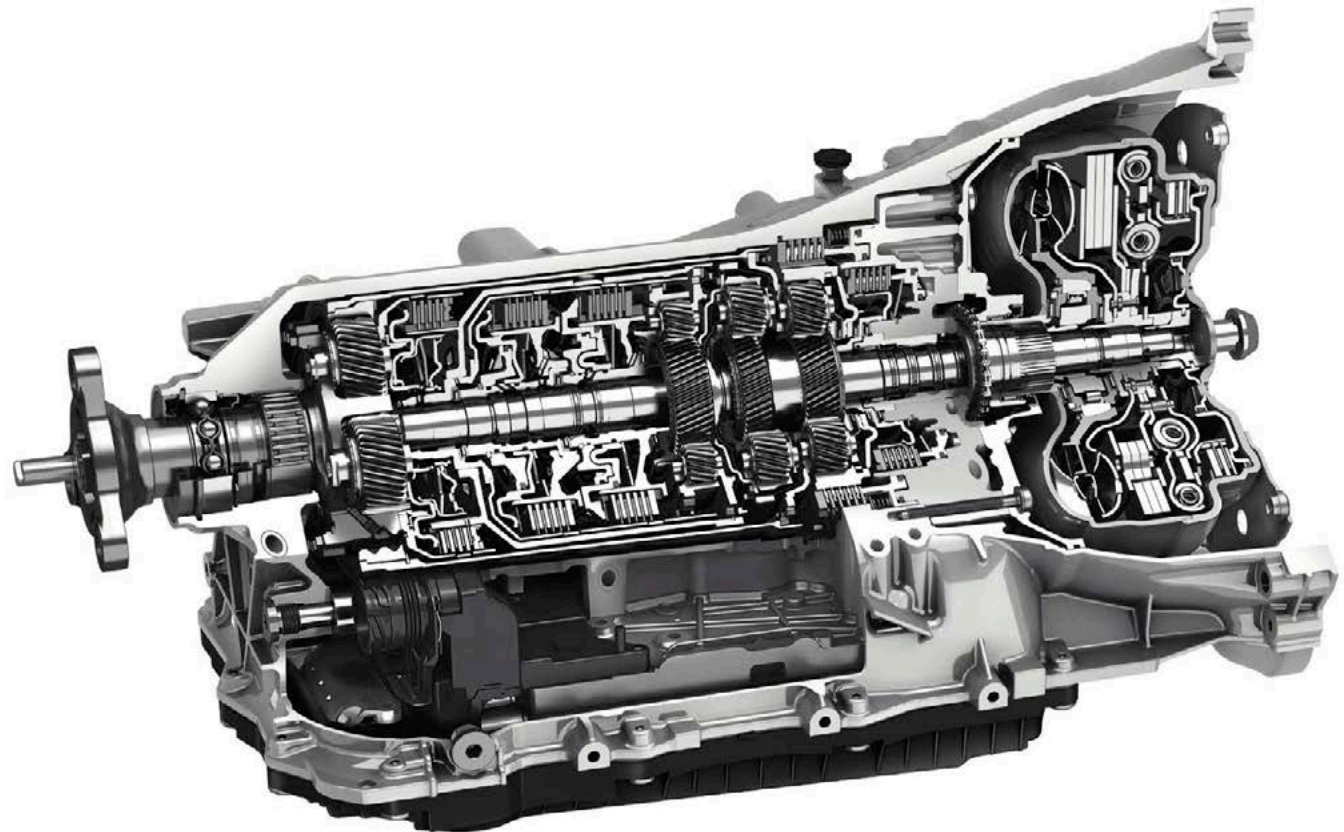

Vehicle shown: Discovery HSE Luxury in Namib Orange.

## BODY AND CHASSIS

# STRENGTH AND STABILITY

### HIGH-STRENGTH ALUMINUM CONSTRUCTION

With an advanced aluminum unibody, the Discovery enjoys greater levels of performance, together with improved strength and sustainability. It is nearly 1,000 lbs lighter than its predecessor\*. Added to which, thanks to utilizing the latest in materials and building technologies, the vehicle can readily take the rugged use associated with off-road driving.

### RUGGED SUSPENSION ARCHITECTURE

Another key factor in the driving capability of the Discovery is the rugged suspension architecture. Primarily constructed from aluminum components, the suspension is fully independent, with a widespaced double-wishbone design at the front and an advanced multi-link layout at the rear.

The suspension concept is specifically developed to maximize the unrivaled breadth of capability, offering responsive and agile handling together with supreme ride quality and refinement.

To see the available suspension options please see page 33.

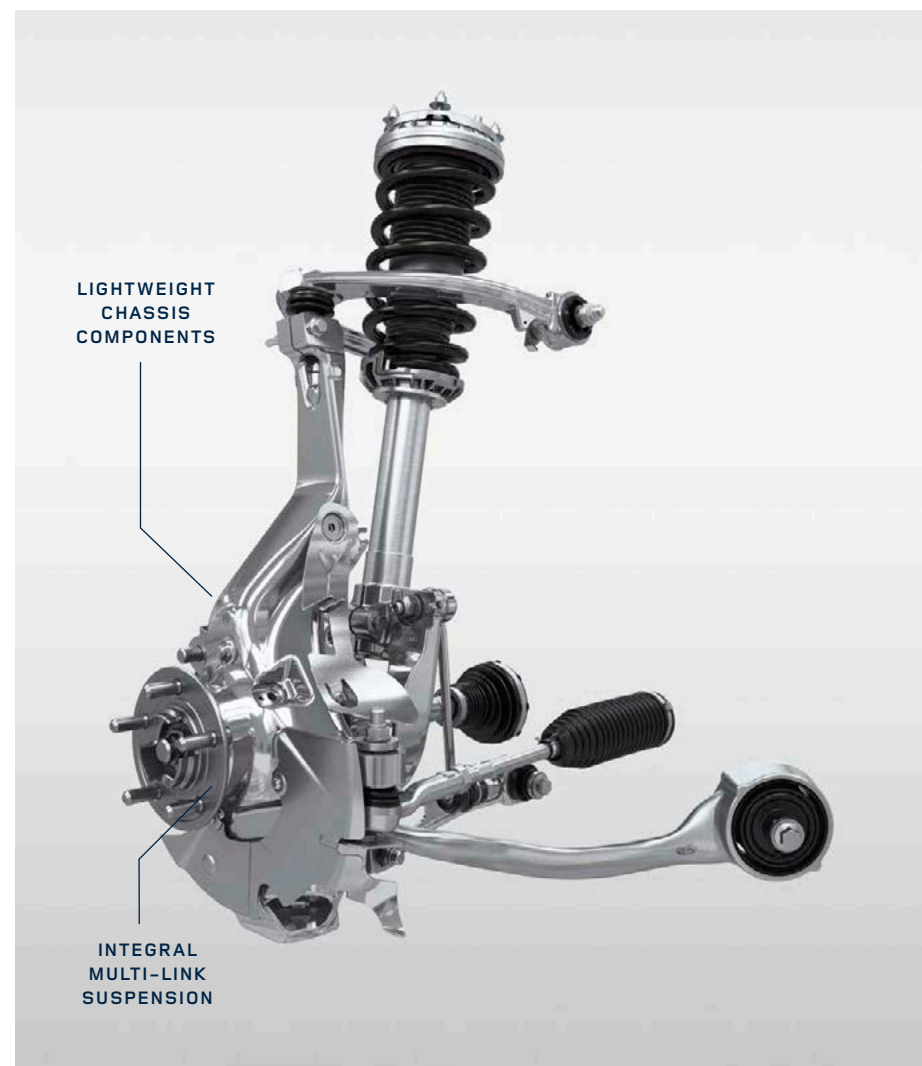



## DRIVING AND PARKING AIDS

### OCCUPANT SAFETY PROTECTION

The body structure helps protect occupants using a strong and stable aluminum cell. The crash structure is optimized using computer simulation tools, which allows engineers to conduct a significant number of 'virtual' crash tests long before physical prototypes are available.

The Occupant Safety Pack includes a comprehensive system of airbags and restraint systems including driver and passenger airbags, side curtain and thorax airbags\*, and seat belt pretensioners<sup>1</sup>.

The Discovery features six standard airbags and eight airbags\* when seven seats<sup>2</sup> are specified.

### SEAT BELT PRETENSIONERS<sup>1</sup>

Acting in conjunction with the Supplementary Restraint System (SRS), they provide additional protection in the event of a severe frontal impact by reducing the forward movement of the occupant.

### LATCH CHILD SEAT RESTRAINT SYSTEM POINTS

Up to four<sup>1</sup> lower LATCH/ISOFIX mountings and associated top tether anchor points are featured on the second and third row seats<sup>2,3</sup>. These provide an easier way of installing child restraints.

### CURTAIN AIRBAGS\* WITH ROLLOVER SENSING

In the event of a side impact or rollover, curtain airbags are deployed.

### DRIVING AND PARKING AIDS

There are extensive driving and parking aids available including Emergency Braking\*\*, Blind Spot Assist, Park Assist and 360° Surround Camera<sup>1</sup>. In addition, LED lights have been cleverly developed to wrap around the side of the vehicle to enable the indicators to be more visible.

To see the range of driving and parking aids available please see pages 48-53.

### PASSENGER SEAT BELT CHECK SYSTEM



\*Please remember that the safety belts in a vehicle constitute the primary protection system for driver and passengers in collisions. Airbags are not designed to deploy in all collisions. The airbag Supplemental Restraint System (SRS) is a supplement to the safety belts and is designed to work as a system with the safety belts. Although airbags provide additional protection, airbags without safety belts do not provide optimal protection in a crash. Always wear your safety belts. Children younger than 13 years old should always be properly restrained in a back seat, away from airbags. Never place an infant seat in the front seat. \*\*Please note that if any action is taken, even minimal steering, the Emergency Braking system will assume the driver resumed control of the vehicle and the system will automatically disengage. <sup>1</sup>These systems are not a substitute for driving safely with due care and attention and will not function under all circumstances, speeds, weather and road conditions etc. Driver should not assume that these systems will correct errors of judgment in driving. Please consult the owner's manual or your local authorized Land Rover Retailer for more details.

<sup>1</sup>Outboard second row and third row seats only. <sup>2</sup>Available as part of a pack on SE and HSE and fitted as standard on HSE Luxury. <sup>3</sup>Where third row seats are specified.

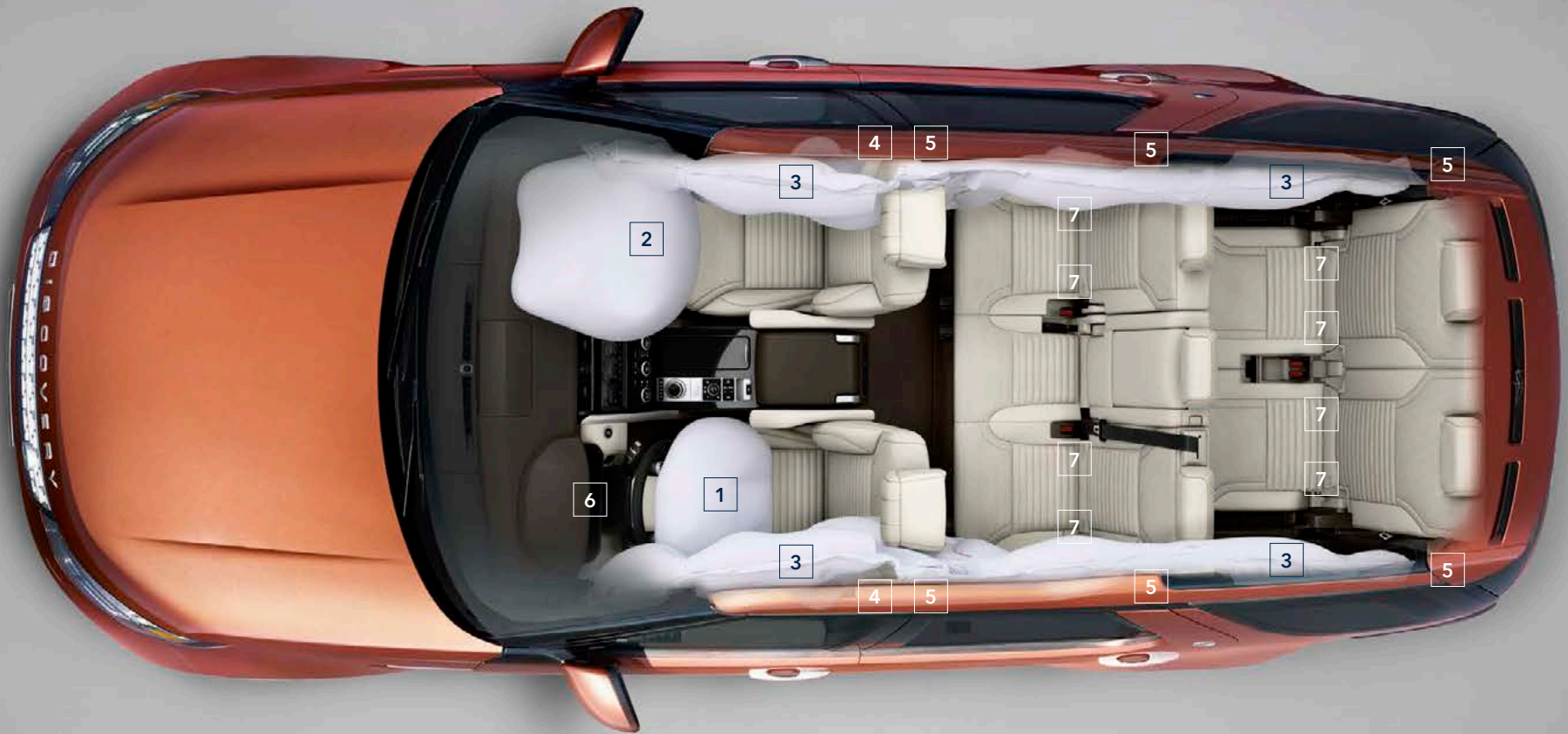

**SAFETY SYSTEMS**

- 1** DRIVER AIRBAG
- 2** PASSENGER AIRBAG
- 3** CURTAIN AIRBAGS

- 4** SIDE THORAX AIRBAGS
- 5** SEAT BELT PRETENSIONERS
- 6** SEAT BELT REMINDER

- 7** LATCH CHILD SEAT RESTRAINT SYSTEM/ISOFIX POINTS

Vehicle shown: Discovery HSE Luxury in Namib Orange with optional third row seats<sup>2</sup>.







## ENVIRONMENTAL

# SUSTAINABILITY

The Discovery demonstrates our continuing commitment to enhancing the sustainable performance of our products and operations, and our determination to deliver vehicles that are both relevant and highly desirable. As part of our commitment to reducing our environmental footprint, our Engine Manufacturing Center in the UK features over 22,000 solar panels - one of the largest roof-mounted solar array in the country.

The Discovery has been designed with a life-cycle approach, aiming to use fewer resources and more environmentally sustainable materials, and minimize the CO<sub>2</sub> emissions over the vehicle's entire life cycle. It's aluminum structure and optimized powertrains have reduced the environmental impact, from material production and development through to customer use.

The Discovery is built in state-of-the-art manufacturing facilities operating to some of the highest environmental standards anywhere in the world. By focusing on innovation and efficiency in every aspect of its processes, the company has achieved a 38 percent reduction in operational CO<sub>2</sub> for each vehicle built, compared to 2007 levels. Water use has also been reduced by 34 percent and zero waste to landfill from manufacturing operations has been achieved. Investment, commitment and focus in these areas continue to drive further efficiencies. Responsible resource management is integral to the company's long-term sustainability strategy, for example all UK operations are powered by 100 percent renewable or zero carbon electricity.

\*JLR Data 2014/15 vs. 2007.

Vehicle shown: Discovery HSE Luxury in Namib Orange.

## SPECIFICATIONS

# LAND ROVER GEAR – ACCESSORIES

The Discovery is so capable and adaptable, it can get straight to work across a huge variety of vastly differing conditions and roles. Owners can tailor their Discovery to their specific needs with a range of stylish, practical accessories that are tough, versatile and personalized.



These accessories can be added by your Land Rover Retailer at any stage during your vehicle's life - not just when it's new. Land Rover Approved Accessories are designed, tested and manufactured to the same exacting standards as the original equipment fitted to your vehicle.

DESIGN



**Cargo space rigid organizer system**

Convenient cargo space organizer provides segregated compartments to store wet, dirty or delicate items, or separate shopping/luggage. The front and rear compartments also have flexible dividers to create smaller compartments within them. Featuring two lockable lids, it is secured via cargo space 'D' loops.



**Stainless steel Undershield<sup>1</sup> - Front/Rear**

The off-road designed Undershield, manufactured from stainless steel, features a premium Bright Polished finish for the front and rear of the vehicle.



**Sports pedal covers<sup>2</sup>**

Stainless steel Bright finish sports pedal covers are easy to fit and feature hidden fixings for a clean finish.



**Bright side tubes<sup>3</sup>**

Highly polished stainless steel side tubes provide an off-road inspired appearance, designed to complement the vehicle's exterior design.



**Deployable side steps<sup>3</sup>**

These smart, practical steps make it easier to get in and out of the vehicle. Neatly stored under the sills, the side steps automatically deploy as soon as the door is opened, or when activated by the key fob. They store automatically when the door is closed.

Please contact your nearest Land Rover Retailer for fitment options.



**Fixed side steps<sup>3</sup>**

The side step aids entry and exit to the vehicle, improves access to the roof and also provides a rugged, off-road style to the vehicle. Features embossed 'Discovery' branding and Bright metallic trim finish to complement the vehicle's exterior design cues.

<sup>1</sup>Not available with Dynamic Design Pack. <sup>2</sup>Standard as part of Complete Dynamic Design Pack with Electronic Air Suspension. <sup>3</sup>Fitting of side tubes and side steps may affect the off-road capability of the vehicle.

## TOURING



### Click and Go System

Click and Go base required for all attachments. Click and Hook is a universal hook that creates extra storage space for items to be hung. Click and Work is a folding table especially useful on long journeys, and offers the rear passengers a practical surface providing some office space and a cup holder.

### Click and Go System

Click and Hang is a removable coat hanger, allowing shirts and jackets to be kept crease-free while transporting. Click and Play is a removable tablet holder attachment which is available for various tablets, and can be easily positioned in multiple angles for in-cabin comfort and rear entertainment.

### Center armrest cooler/warmer box

Food and drinks chiller and warmer that acts as a rear center armrest. With a leather-covered top, it is held in place by the center seat belt and powered from the rear auxiliary socket. Ideal for long journeys with the family.



### Sunshades

Easy to install or remove, these sun blinds provide increased comfort, helping to protect the interior from heat and glare of the sun.



### Roof rails<sup>1</sup>

Roof rails facilitate easy fitment of cross bars for roof carrying. Preset positioning points ensure cross bars are fixed in optimum position for weight distribution and dynamics. Maximum payload 176 lbs<sup>2</sup>.

### Cross bars<sup>1</sup>

Easy to attach and remove lockable cross bars in a durable Bright finish aluminum. Aerodynamic profile minimizes drag and wind noise. Incremental height of roof rails and cross bars when fitted is up to 4.3 inches. Maximum payload capacity 163 lbs<sup>2</sup>.



### Roof box<sup>1</sup>

Available in a range of sizes, all versions can be mounted either side for curbside opening in any country and include integral locks for security and peace of mind. Carrying capacity ranges from 11.3 cu.ft. for the sports box to the 14.5 cu.ft. luggage box or the capacious 15.2 cu.ft. large sports box. Maximum payload 126 lbs<sup>2</sup>.

SPORTING



**Towing receiver**

Additional parts might be required for installation.



**Tow hitch**



**Roof-Mounted Bike Carrier - Wheel Mounted<sup>1</sup>**

Lockable bike carrier designed for holding a single bike, up to 44 lbs.



**Aqua Sports Carrier<sup>1</sup>**

Carries one canoe or kayak (Two Kayak Carrier carries two kayaks or canoes). Includes lockable multi-purpose holder to carry oars or paddles. Tilts to facilitate easy loading/unloading. Features lockable straps and rubber supports to maintain optimum weight distribution, while protecting the kayak and vehicle from scratches/scuffs. Maximum payload capacity 99 lbs.

**Aqua Sports Carrier - Two Kayaks**



**Ski/Snowboard Carrier<sup>1</sup>**

Carries four pairs of skis or two snowboards. Incorporates slider rails for easy loading and is also lockable for security. Maximum payload 79 lbs<sup>2</sup>.



**Protective seat covers**

Helps protect seats from mud, dirt, wear and tear. Easily fitted and wipeable.



**Body side moldings**

Enhances the side of your vehicle and provides protection for your door panels from accidental damage by adjacent vehicles.

## ACTIVE



**Tailgate Event Seating in Ebony leather<sup>1</sup>**

The Tailgate Event Seating is handcrafted from beautiful Ebony Windsor leather with a highly durable aluminum frame. Stored in the cargo space, these seats can be quickly and easily fitted to provide comfortable seating for two adults on the lower tailgate, when the vehicle is stationary. The seats come complete with a luxury storage bag with soft lining, which also acts as a useful protective mat to prevent the users' clothes coming into contact with the exterior vehicle surfaces when in use.



**Cargo space partition and luggage divider<sup>2</sup>**

Designed to prevent luggage from entering the passenger compartment. The design of the luggage partition has been optimized to second row seating featuring tilt functionality. The luggage partition divider can be fitted to the luggage partition to separate the cargo space into two sections. Semi-rigid waterproof cargo space liner tray with a raised lip on three sides to protect cargo space floor and side wall carpets from dirt or wet equipment.



**Cargo Space Rubber Mat**

The Land Rover branded waterproof Rubber Mat helps to protect the rear cargo space carpet from general dirt.



**Passenger footwell net**

The passenger footwell net provides additional storage space within the cabin. It is easily accessible and ideal for everyday small items, such as maps and letters.



**Mudflaps**

Mudflaps are a popular upgrade for reducing spray and ensuring paintwork is protected from debris and dirt. Engineered to complement the vehicle exterior design.



**Rubber floor mats**

Rubber footwell mats help provide protection from general dirt.

OTHER



**iPhone® Connect and Charge Dock**  
VPLRV0119

The iPhone Connect and Charge Dock has been designed to charge utilizing the cup holder space in the central console. When connected, the iPhone media is accessible and has the ability to be controlled via the integrated infotainment/audio system. The 'cut-out' design of the holder is such that home button is also accessible for use when parked. The iPhone USB charger can be easily disconnected if the USB connection is required for other use. For use with iPhone 5, 5c, 5s, 6, 6s, SE and 7. Not suitable for use with 6 Plus or 7 Plus.



**Wireless Phone Charging Cup Holder<sup>3</sup>**  
VPLRV0118

The Wireless Phone Charging Cup Holder has been designed to charge utilizing the cup holder space in the center console. The holder will accommodate varying phone sizes securely in place. The charger displays an LED light to indicate when charging, and turns off when complete. Fits phones up to 2.8 inches wide.



**Pet Pack with Mat**  
Luggage partition - Full height  
VPLRS0374

**Cargo Space Mat**  
VPLRS0375PVJ

Combines the Cargo Space Rubber Mat with the full height partition, to protect both your vehicle and your pet. The Rubber Mat is waterproof, protecting the vehicle's cargo space floor carpet. The full height partition prevents access to the passenger compartment, while containing and protecting your pet.



**Snow traction system**  
VPLGW0081

Snow traction system is designed to give improved steering and braking control on snow and ice, when fitted to front wheels. Easy-fit design, manufactured from high-quality hardened galvanized steel, the chains are supplied in a tough vinyl carry bag for storage when not in use. Suitable for 19-21" wheels.



**Versatile roof rack**  
VPLRR0153

The versatile roof rack has a lightweight and fully integrated design which provides a large volume carrying capacity. When fitted maximum load capacity 132 lbs<sup>4</sup>.



**Wind deflectors - Clear<sup>5</sup>**  
VPLRP0279

Wind deflectors for side windows to help to improve comfort levels in the cabin when driving with windows open, by reducing air turbulence and noise and allowing fresh air to be circulated in the cabin.

<sup>3</sup>The Wireless Phone Charging Cup Holder does not provide a connection to InControl Apps. <sup>4</sup>Maximum payload equals the load capacity of the roof-mounted accessory. <sup>5</sup>Sold as a kit of four wind deflectors, two for the front door windows and two for the rear door windows. iPhone® is a registered trademark of Apple Inc., registered in the US and other countries.

# THE WORLD OF LAND ROVER

Your Land Rover has been designed and engineered to help you make more of your world. It can take you to places other vehicles simply can't reach, in a style that cannot be matched. To celebrate the Land Rover lifestyle, we've put together a range of experiences, publications and the Land Rover Lifestyle Collection. There's a world to explore. Get out there and enjoy it.

## EXPERIENCE DRIVES



Professional driver on closed course. Do not attempt.

Bring out your adventurous side and experience Land Rover's legendary capability for yourself. Under the expert guidance of a world-class instructor, head to the most exciting and challenging off-road terrains and take the vehicle to its limits.

[experience.landroverusa.com](http://experience.landroverusa.com)

## ADVENTURE TRAVEL



Professional driver on closed course. Do not attempt.

From the sheer exhilaration of the Arctic ice to the awe-inspiring dunes of Namibia, Land Rover Adventure Travel offers you once-in-a-lifetime experiences that bring the spirit and emotion of our vehicles to life.

[landroverusa.com/experiences/adventure-travel](http://landroverusa.com/experiences/adventure-travel)



Follow us on:



## MANUFACTURING TOURS



This is a unique opportunity to step inside our state-of-the-art manufacturing facilities and see where the latest vehicles are born. Taking you behind the scenes, our expert tour guides will show you how Land Rover combines unrivaled craftsmanship with cutting-edge robotics.

[landrover.com/tours](http://landrover.com/tours)

## SPECIAL VEHICLE OPERATIONS



Whether it's class-leading luxury, thrilling performance or extreme all-terrain capability, Land Rover excels. Special Vehicle Operations takes this even further. Delivering the absolute pinnacle of Land Rover engineering and design, each vehicle combines peerless refinement with power and cutting-edge technology, which is why the SV badge represents so much.

[landroverusa.com/special-vehicle-operations](http://landroverusa.com/special-vehicle-operations)

## THE LAND ROVER LIFESTYLE COLLECTION

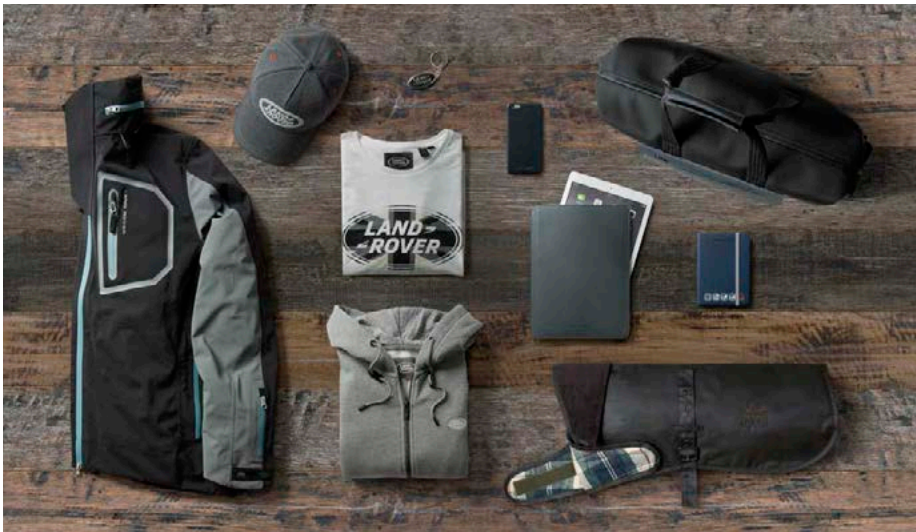

Our latest range of clothing and lifestyle accessories are crafted with the same design excellence and attention to detail as our vehicles. Inspired by our unique heritage, there is something for the whole family.

[shop.landroverusa.com](http://shop.landroverusa.com)

## ONELIFE MAGAZINE



Free twice a year for your first three years as a Land Rover owner, this award-winning magazine features the best in photography, authoritative journalism and expert insights. Onelife takes you right into the heart of exclusive experiences and extraordinary adventures, while keeping you up to date with the latest innovations, design and lifestyle choices.

[magazine.landroverusa.com](http://magazine.landroverusa.com)

Follow us on:



## BRAND PARTNERSHIPS



Integrity. Courage. Pride. These are the values that Land Rover shares with its partners. Whether it's the Invictus Games, Virgin Galactic, Rugby World Cup 2019™ or the British and Irish Lions, each one is driven by exceptional people. Those who push their capabilities to the very limits and champion the determination to go above and beyond.

[landrover.com/partnerships](http://landrover.com/partnerships)

## HUMANITARIAN PARTNERSHIPS



Since 1954, Land Rover is proud to have supported the incredible humanitarian work of the International Federation of Red Cross and Red Crescent Societies (IFRC). Through vehicles, funding and combined expertise, this ambitious global partnership has helped to transform the lives of over one million people, across four continents.

[landrover.com/responsibility](http://landrover.com/responsibility)



# YOUR PEACE OF MIND

## CUSTOMER SERVICE

When you bring your Land Rover vehicle to us, we use proprietary Land Rover diagnostic equipment to assess all your vehicle's mechanical and electronic systems. Our factory-trained Technicians use tools specifically designed for our vehicles and only fit genuine Land Rover parts and Gear accessories. A choice of service plans are available which, together with Roadside Assistance, ensures complete peace of mind.

For further details contact your local Land Rover Retailer or search 'Land Rover Ownership'.

## LAND ROVER ROADSIDE ASSISTANCE

Land Rover Assistance provides assistance in motoring emergencies, from immobilization due to mechanical breakdown, to minor problems such as punctures. You can rely on our roadside assistance, whatever the situation, anywhere in North America during the vehicle's warranty period.

For further details please consult your Warranty Benefits handbook, contact your nearest Land Rover Approved Service Center or search 'Land Rover Roadside Assistance'.

**IMPORTANT NOTICE:** Jaguar Land Rover Limited is constantly seeking ways to improve the specification, design and production of its vehicles, parts and accessories and alterations take place continually. While every effort is made to produce up-to-date literature, this brochure should not be regarded as an infallible guide to current specifications or availability, nor does it constitute an offer for the sale of any particular vehicle, part or accessory. Distributors and Retailers are not agents of Jaguar Land Rover Limited by any express or implied undertaking or representation.

## TECHNICAL SPECIFICATION

If not enclosed, please contact your local Land Rover Retailer.

## LAND ROVER FINANCIAL SERVICES

Getting the keys to your very own Land Rover has never been so simple. And it's more affordable than you might think. New or used, for personal or business use, we have an option that puts you in complete control.

For further details contact your local Land Rover Retailer or search 'Land Rover Finance'.

## FLEET & BUSINESS

Land Rover is dedicated to being the premium manufacturer of choice for fleets and businesses, by providing a highly attractive range of vehicles and exemplary customer service.

We are also committed to providing a totally customer-focused aftersales service, which will ensure every Land Rover vehicle is kept on the road and in top condition, in the easiest and most cost-efficient way for businesses.

Search 'Land Rover Fleet and Business' for full details.

Images are for illustrative purposes only. Colors reproduced on-screen may vary compared to actual finish. The company reserves the right to alter or withdraw any color finish without notice. Some of these colors may not be obtainable in your country. Please check availability of colors and current specifications with your Land Rover Retailer. Distributors and Retailers are not agents of Jaguar Land Rover Limited and have absolutely no authority to bind Jaguar Land Rover Limited to any express or implied undertaking or representation.

Castrol EDGE Professional recommended by Land Rover.

Vehicle shown on front and back cover: Discovery Landmark Edition in Eiger Grey with optional features fitted.

**Jaguar Land Rover North America, LLC**

100 Jaguar Land Rover Way

Mahwah, NJ 07495-1100

[landroverusa.com](http://landroverusa.com)

© 2019 Jaguar Land Rover North America, LLC

1L4622010000BUSEN01P

TO LEARN MORE ABOUT THE DISCOVERY,  
CURRENT OFFERS AND TO BUILD YOUR  
OWN, CLICK BELOW

> [landroverusa.com](http://landroverusa.com)



# DISCOVERY

TECHNICAL SPECIFICATION  
2020



ABOVE & BEYOND



# ENGINES

You can select from a choice of 3.0 litre gas or diesel engines. These engines are designed for clean and efficient combustion and are all equipped with Stop/Start technology.

Configure your Discovery at [landroverusa.com](http://landroverusa.com)

## TECHNICAL SPECIFICATION

	<b>GAS</b>	<b>DIESEL</b>
<b>POWERTRAIN</b>	<b>3.0L Si6</b>	<b>3.0L Td6</b>
Transmission	Automatic	Automatic
Driveline	All Wheel Drive (AWD)	All Wheel Drive (AWD)
Maximum power hp/rpm	335 / 6,500	254 / 3,750
Maximum torque lb-ft/rpm	332 / 4,500-5,000	443 / 1,750-2,250
Capacity (cc)	2,995	2,993
No. of cylinders/Valves per cylinder	6 / 4	6 / 4
Cylinder layout	Longitudinal V6	Longitudinal V6
Bore/stroke (inches)	3.32 / 3.50	3.31 / 3.54
Compression ratio (:1)	10.5	16.1
<b>FUEL ECONOMY</b>		
Fuel tank capacity - US gallons	23.8	22.4
Diesel Particulate Filter (DPF)	-	■

■ Standard - Not Available.



## TECHNICAL SPECIFICATION

	<b>GAS</b>	<b>DIESEL</b>
	<b>3.0L Si6</b>	<b>3.0L Td6</b>
<b>PERFORMANCE</b>		
Acceleration* (secs) 0-60 mph	6.9	7.7
Maximum speed mph	130	130
<b>BRAKES</b>		
Front type	Brembo P4 caliper	2 x 48mm sliding fist caliper
Front diameter (mm)	363	349
Rear type	45mm sliding fist caliper	45mm sliding fist caliper
Rear diameter (mm)	350	325
Park Brake	Integrated motor-on caliper	Integrated motor-on caliper
<b>WEIGHTS (LBS)**</b>		
Seating	5 / 7	5 / 7
Curb weight	4,735	4,900
Gross Vehicle Weight (GVW)	6,592 / 6,900	6,724 / 6,989
<b>TOWING (LBS)</b>		
Seating	5 / 7	5 / 7
Unbraked trailer	1,653	1,653
Maximum towing	8,201	7,716
Maximum coupling point†	771	771
Maximum vehicle and trailer combination	14,790 / 15,100	14,440 / 14,704
<b>ROOF CARRYING (lbs)</b>		
Maximum roof load (including cross bars)	176	176

# DIMENSIONS AND CAPABILITIES

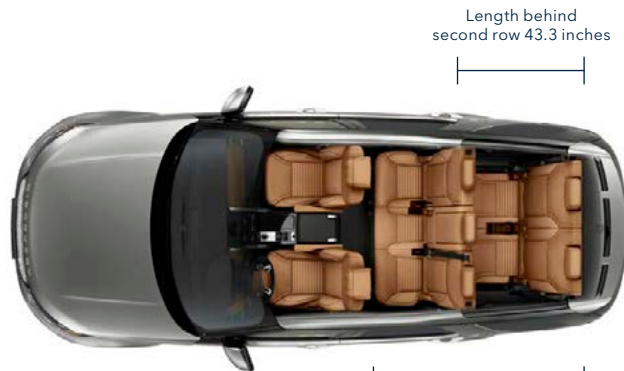

Length behind second row 43.3 inches

Cargo space width 55.5 inches

Length behind first row 76.9 inches

## Standard Ride Height

Air suspension 74.3 inches  
Coil suspension 75.2 inches

## Headroom

Maximum front/rear headroom with standard roof 39.4 inches/39.0 inches  
Maximum front/rear headroom with panoramic roof 40.0 inches/39.0 inches

## Legroom

Maximum front legroom 39.1 inches  
Maximum rear legroom second row 37.6 inches  
Maximum rear legroom third row 33.5 inches

## Obstacle Clearance

Air suspension 8.2 inches.  
Coil suspension 8.5 inches

## Turning Circle

Curb-to-curb 40.7 ft.  
Wall-to-wall 40.7 ft.  
Turns lock-to-lock 2.7

## Wading Depth\* †

Maximum wading depth  
Air suspension 35.4 inches  
Coil suspension 33.5 inches



Overall length 195.1 inches

Width 81.6 inches mirrors folded  
Width 87.4 inches mirrors out



Front wheel track\*\*  
Air suspension 66.6 inches  
Coil suspension 66.5 inches



Rear wheel track\*\*  
Air suspension 66.4 inches  
Coil suspension 66.3 inches

Height Air suspension 74.3 inches  
Coil suspension 75.2 inches



	A	B	C
Ride Height			
Approach Angle	34.0°	Ramp Angle	Departure Angle
Air suspension	34.0°	27.5°	30.0°
Coil suspension	26.3°	22.2°	25.9°



\*Wading depth (25 deg entry and exit) 29.5 inches, deep fording depth (9 deg entry and exit) 35.4 inches. \*\*When fitted with 21 inch wheels. †Driving in floodwaters or moving water should be avoided. Driving through water can be extremely dangerous. The Wade Sensing feature only detects depth of water the vehicle is in at the present time and not of water ahead or around the vehicle. Therefore, Wade Sensing cannot predict whether it is safe to proceed and cannot detect steep drops in grade around the vehicle. The driver is responsible for determining the conditions of the route being driven.