

Ford

THE UNIVERSAL CAR

Price List of Parts
and Accessories

MODEL T

Ford Motor Company
DETROIT, MICHIGAN

May 1st, 1920

Prices subject to change without notice

**These Prices Free of Excise Tax
to Consumer**

IMPORTANT

INSIST on getting **GENUINE** Ford Parts when your Ford car needs repairing. Don't allow "bogus" or imitation Parts to go in your car.

Ford Motor Company

FORD FACTORIES AND BRANCHES

Ford Factory, Detroit—*Parent Plant*
Ford Factory, Ford, Ontario, Canada
Ford Factory, Manchester, England

AMERICAN WHOLESALE BRANCHES

Atlanta	Cleveland	Fargo	Los Angeles	Oklahoma City	Salt Lake City
Buffalo	Columbus	Houston	Louisville	Omaha	San Francisco
Cambridge	Dallas	Indianapolis	Memphis	Philadelphia	Scranton
Charlotte	Denver	Jacksonville	Milwaukee	Pittsburgh	Seattle
Chicago	Des Moines	Kansas City, Mo.	Minneapolis	Portland	Washington
Cincinnati	Detroit	Kearney, N. J.	New Orleans	St. Louis	

FOREIGN BRANCHES AND SERVICE STATIONS

Bordeaux, France	London, Eng.	Montreal, Que.	St. John, N. B.
Buenos Aires, Argentina	London, Ontario	Paris, France	Toronto, Ont.
Cadiz, Spain	Manchester, Eng.	Regina, Sask.	Vancouver, B. C.
Calgary, Alta.	Melbourne, Aus.	San Paulo, Brazil	Winnipeg, Manitoba
Copenhagen, Denmark			

Foreign Department—1710 Broadway, New York
There are Ford Agents in all Principal Cities

Instructions for Ordering Parts

- 1—Order all parts through the nearest Branch or Dealer.
- 2—Always give **Catalog Number** and **Name** of each part ordered.
- 3—Mail and Parcel Post orders must be accompanied by an amount sufficient to **cover Postage**.
- 4—All prices are net f. o. b. Branch, Factory or Dealer.
- 5—Specify how shipments are to be made.
- 6—Orders for parts should be written separately from correspondence pertaining to other matters.

Telegraph Code

To save expense, to expedite ordering and for your convenience, we have arranged a code word for each part of the Ford Model T car. In addition, we list below a brief General Code covering miscellaneous instructions, questions and answers relative to the shipment of parts.

Toperig—Ship to me (us) by express.

Toperkleur—Ship by express to _____

Topersteen—Ship to me (us) by freight.

Toper—Ship to me (us) by parcel post.

Topfton—When and how did you ship parts called for in my (our) telegram of _____

Topflutch—When and how will you ship parts called for in my (our) telegram of _____

Topfwasser—When and how will you ship parts called for in my (our) letter of _____

Parts Price List Index

	Page
Ammeter	30
Axle—Front	7
Axle—Rear	5
Battery Bracket and Parts	31
Bendix Drive	30
Body Parts	19
Carburetor	24
Carburetor Attachments	24
Coil and Parts—Spark	30
Commutator	13
Cotter Pins	33
Cut-outs	30
Fan	23
Fenders	27
Frame	9
Gasoline Tank	9
Generator and Parts	31
Hood	24
Horn	34
Lamps	34
Magneto	13
Motor	9-12-13
Muffler	24
Nuts	33
Radiator—Thermo Syphon	23
Running Board and Shields	27
Springs	21
Starter Parts	30-31
Starting Crank	23
Steering Gear	19
Switch	30
Tools	33
Tops	36
Transmission	16
Transmission Control	17
Transmission Cover	16
Truck Parts	38-40
Wheels	7
Windshields	34
Wiring	30

PRICE LIST OF PARTS

FORD MODEL T 1909-1920

EFFECTIVE MAY 1st, 1920

Part No.	Name of Part	Year	Specifications	Price	Code Word	Fac.No.	Req. No. per Car	Mailing Weight
REAR AXLE								
2500	Rear axle assembly	1909-20	56-inch tread	\$80 00	Aband	95E	1	
2501	Axle housing—right	1915-20		12 00	Absolve	7635C	1	
2502	Axle housing—left	1915-20		12 00	Absume	7636C	1	
2503B	Axle housing bolt and nut		$\frac{1}{4}$ " x $1\frac{1}{8}$ "		05	Ajoy	2854-44	.7
2504	Rear axle case gasket						139	1
2505	Axle shaft—tapered	1912-20	$1\frac{1}{8}$ " x $31\frac{1}{4}$ "	2 50	Abode	2818	2	8 lb.
2506	Axle shaft washer	1909-20	$1\frac{1}{8}$ " dia. fibre		03	Abound	39	1
2508	Axle shaft roller bearing	1909-20	$2\frac{1}{4}$ " x 4"	1 25	Abraise	97	4	1 lb., 3 oz.
2509	Axle shaft roller bearing sleeve—right	1909-20	4" long		30	Abray	170	2
2509B	Axle shaft roller bearing sleeve—left	1909-20			30	Abate	161	2
2510	Axle housing cap	1909-19	$2\frac{1}{2}$ " dia.		05	Abroad	56	2
2510 1/2	Axle housing cap	1919-20			05	Abridge	56B	2
2510A	Axle outer roller bearing steel washer	1909-20	$2\frac{1}{4}$ " dia.		03	Absinthe	199	2
2510B	Axle outer roller bearing felt washer	1909-20	$2\frac{1}{8}$ " dia.		05	Absist	54	2
2512C	Diff. case—left (no bushing used)	1914-20		2 00	Abut	84	1	
2513C	Diff. case—right (no bushing used)	1914-20		1 25	Ache	81	1	
2514	Diff. case stud and nut	1909-15	$\frac{3}{8}$ " x $2\frac{3}{4}$ "		10	Arcadian	52-8	.3
2514B	Diff. case stud and nut	1915-20	$\frac{3}{8}$ " x $2\frac{3}{4}$ "		10	Ale	2865-8	.3
2518	Diff. drive gear	1909-20	40 teeth	5 00	Accost	12B	1	3 lb., 5 oz.
2519	Diff. drive gear screw	1909-20	$\frac{1}{8}$ " x $\frac{1}{2}$ "		05	Accoy	103	10
2519A	Diff. gear lock ring	1909-20			03	Acetic	118	2
2520B	Diff. gear	1909-20	24 teeth	1 75	Acce	13B	2	1 lb., 6 oz.
2521B	Diff. gear key	1911-20	$1\frac{1}{2}$ " long		05	Acrid	137	2
2524C	Diff. pinion	1915-20	12 teeth		60	Admire	14D	.3
2526B	Diff. spider	1909-20		1 00	Adduce	15D	1	15 oz.
2528	Diff. thrust washer	1909-20	$3\frac{3}{4}$ " dia. metal		30	Adieu	30	2
2529	Diff. thrust plate	1909-20	$3\frac{3}{4}$ " dia. steel		15	Adjoin	31	4
2530	Diff. thrust plate pin	1909-16	$\frac{1}{2}$ " long		03	Admix	17	4
2531	Diff. thrust plate pin	1909-16	$\frac{3}{8}$ " long		03	Adgase	37	2
2531B	Diff. thrust plate pin	1917-20			03	Age	7640	.6
2532	Diff. housing oil plug	1909-20	$\frac{3}{4}$ " x 24 thds		05	Agger	817	1
2545	Rear axle grease cup	1909-20			10	Ajar	76	
2547	Rear radius rod	1909-20		3 00	Altar	152	2	4 lb., 9 oz.
2548	Radius rod nut	1909-20	$\frac{1}{2}$ " x 18 thds		05	Amass	77	2
2549	Radius rod lock nut	1909-20	$\frac{1}{2}$ " x 18 thds		05	Amber	78	2
2550	Radius rod lock washer	1909-20			02	Ambush	2823	2
2551	Radius rod bolt and nut	1909-20	$\frac{1}{2}$ " x $1\frac{1}{2}$ "		10	Ampite	83-60	.4
2557	Hub cam shaft—right	1909-20	$3\frac{1}{8}$ " long		20	Amuck	92B	1
2558	Hub cam shaft—left	1909-20	$3\frac{1}{8}$ " long		20	Anchor	61B	1
2559	Hub cam shaft bushing	1909-20	$\frac{1}{2}$ " bore, $\frac{1}{8}$ " dia.		10	Ancient	173	2
2562	Cam shaft lever	1909-20	$\frac{1}{2}$ " bore		20	Arab	62	2
2563	Cam shaft lever pin	1909-20	$\frac{1}{8}$ " x $\frac{1}{2}$ "		03	Arbor	7	4
2564	Lever clevis pin	1909-20	$\frac{1}{8}$ " x 1"		05	Arcade	65	4
2566	Hub brake shoe	1909-20	Cast iron		40	Arctic	2814	2
2567	Brake shoe support bolt and nut	1909-20	$\frac{1}{2}$ " x $1\frac{1}{8}$ "		10	Argus	59-60	2
2568	Brake shoe support nut	1909-20	$\frac{1}{2}$ " x 20 thds		05	Armor	60	2
2570B	Brake shoe coil spring	1913-20	$3\frac{3}{8}$ " long		03	Asmur	2862	4
2571	UNIVERSAL JOINT ASSEMBLY	1909-20		2 50	Ashore	151B	1	2 lb., 12 oz.
2572	Joint knuckle (male)	1909-20		80	Ashust	45B	1	1 lb.
2573	Joint knuckle (female)	1909-20		1 00	Askew	46B	1	1 lb.
2574	Joint knuckle pin	1909-20	$\frac{1}{2}$ " x $1\frac{1}{2}$ "		03	Asleep	6	1
2575	Joint ring, complete	1909-20	$3\frac{1}{8}$ " dia.	1 00	Astert	49B	1	13 oz.
2576	Joint ring rivets (per set)	1909-20	$\frac{1}{4}$ " x $1\frac{1}{8}$ "		05	Atche	50	4
2577	Joint housing	1909-14	$4\frac{1}{8}$ " long	2 00	Atlas	70	1	2 lb.
2577B	Univ. joint housing	1914-20		2 00	Atoll	7609	1	2 oz.
2578	Joint housing plug	1909-20	$\frac{1}{2}$ " x 20 thds		05	Atom	75	2
2579	Ball joint grease cup	1909-20	$\frac{1}{2}$ " pipe thds		15	Attic	195	1
2580	Ball cap gasket	1909-20			05	Auburn	1518	1
2581	Drive shaft housing front bushing	1909-20	(1" bore), babbitt. Old No. 2540		60	Balkish	69	1
2582	D. S. tubing	1911-20	50% long	12 00	Ballad	153D	1	5 oz.
2583	D. S. roller bearing housing	1911-20	$3\frac{1}{2}$ " long	2 00	Ballot	191B	1	2 lb., 12 oz.
2584B	D. S. roller bearing stud and nut	1912-20	$\frac{1}{2}$ " x $4\frac{5}{8}$ "		10	Balneal	183B-184	.6
2586	D. S. roller bearing housing set screw	1911-20	$\frac{1}{8}$ " x 20 thds		05	Banco	101	1
2587	D. S. roller bearing	1911-20	$2\frac{5}{8}$ " long	1 50	Balsam	108	1	1 lb., 3 oz.
2588	D. S. roller bearing distance plate	1911-20	$2\frac{1}{2}$ " dia.		05	Bandlet	106	1

Insist upon genuine Ford parts

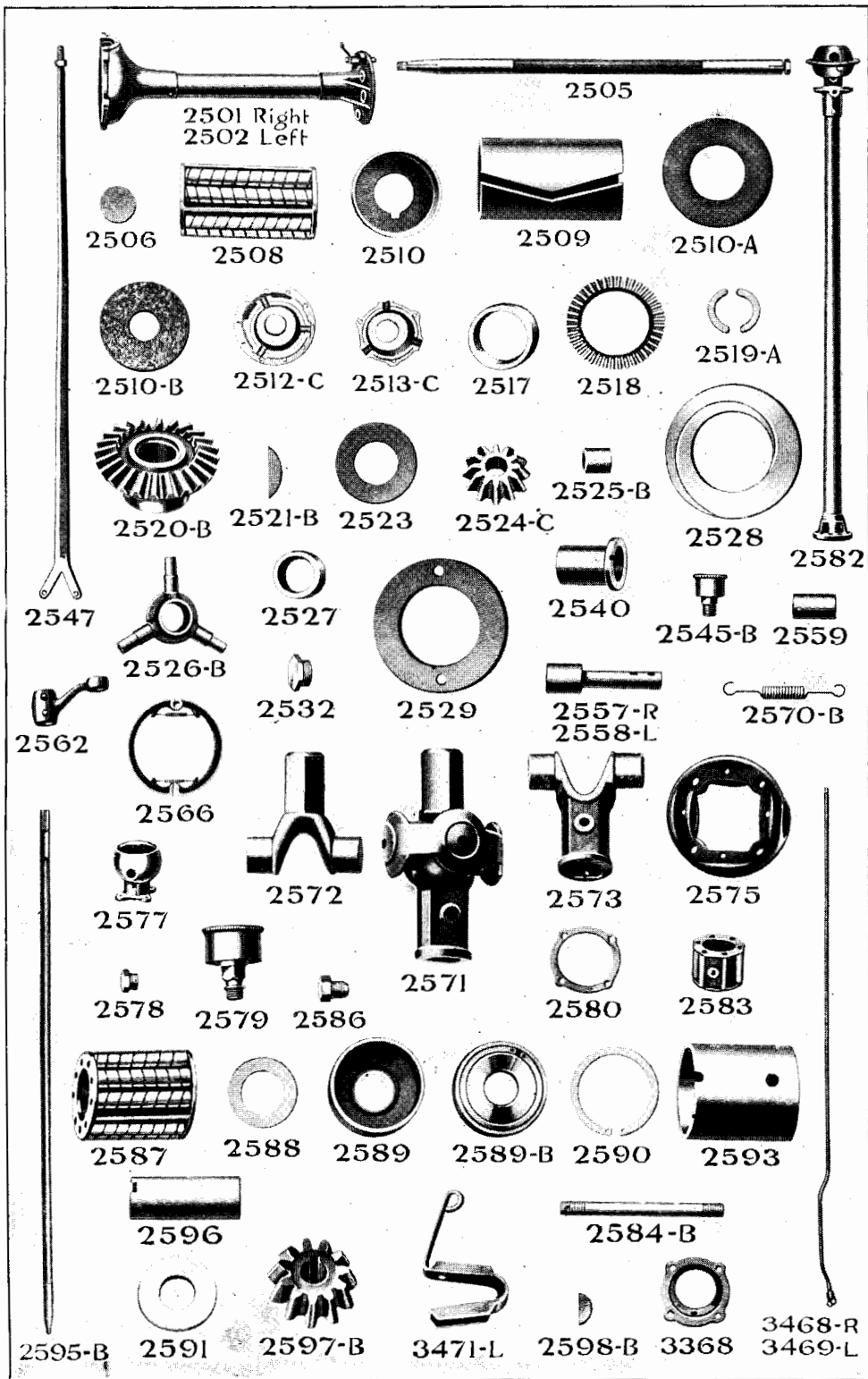

Part No.	Name of Part	Year	Specifications	Price	Code Word	Fac.No. per Car	Req.	Mailing Weight
REAR AXLE—Continued								
2589B..	D. S. ball bearing assembly	1911-20.		\$ 1 00.	Bander	185	1	9 oz.
2589	D. S. ball race	1911-20.	2 5/8" dia.	35.	Bandon	186	1	5 oz.
2590	D. S. ball retainer	1911-20.	2 1/4" dia.	03.	Bandroe	190	1	
2591	D. S. ball thrust collar	1911-20.	2 1/4" dia.	30.	Bandault	188	1	3 oz.
2592	D. S. ball bearings, each	1911-20.	Order 2811					
2593	D. S. roller bearing sleeve	1911-20.	2 5/8" dia., 2 7/8" long.	1 90.	Bangle	107	1	13 oz.
2595B..	D. S. only (tapered)	1911-20.	1 3/8" x 53 1/16"	5 00.	Banjo	87D..	1	13 lb., 8 oz.
2596	D. S. sleeve	1911-20.	1" bore, 3 1/8" long.	1 20.	Bansee	163B.	1	6 oz.
2597B..	D. S. pinion	1911-20.	Taper bore, 11 teeth.	2 00.	Banewort.	16C..	1	11 oz.
2598	D. S. castle nut	1911-20.	5/8" x 18 thds.	10.	Banket	124	1	
2598B..	D. S. pinion key	1911-20.		05.	Banker	57B..	1	

REAR AXLE—60 INCH TREAD

2600C..	Rear axle housing—right	1915-16.	Dia. of bell 9 1/4"	11 00.	Bang	2728C.	1	
2601C..	Rear axle housing—left	1915-16.	Dia. of bell 9 1/4"	11 00.	Bard	2729C.	1	
2602B..	Rear axle shaft—tapered	1911-16.	1 1/4" x 33 3/8"	2 75.	Baptism	2725	2	8 lb., 10 oz.
2604	Rear radius rod	1909-16.	53 5/8" tube only	3 50.	Barbett	1726	2	4 lb., 10 oz.

FRONT AXLE

2690	Front axle assembly	1909-20.	56" tread.	28 00.	Barila	261C..	1	
2691	Front axle only	1909-20.	56" tread.	14 00.	Barber	202B..	1	
2694	Spindle body—right	1911-19.		2 50.	Bardash	276	1	2 lb., 11 oz.
2695	Spindle body—left	1911-19.		2 50.	Bardish	277	1	2 lb., 11 oz.
2696	Spindle arm—right or left	1911-19.		75.	Bardism	7716	2	12 oz.
2696B..	Spindle arm—right	1911-15.	With hole for speedometer support.	75.	Bardo	7715A	1	12 oz.
2696C..	Spindle arm—right	1919.		75.	Barm	7715E	1	
2696D..	Spindle arm—left	1919.		75.	Barry	7716B	1	
2697	Spindle arm nut	1911-20.	Order 2548.					
2702	Spindle assembly—right	1909-10.		5 00.	Barkate	203A.	1	3 lb., 8 oz.
2703	Spindle assembly—left	1909-10.		5 00.	Barker	204A.	1	3 lb., 8 oz.
2704	Stationary cone	1909-19.	1 1/8" bore.	20.	Barless	205	2	4 oz.
2705	Adjusting cone—right thread	1909-19.	3/4" x 16 thds., R. T.	20.	Barley	206	1	2 oz.
2706	Adjusting cone—left thread	1909-19.	3/4" x 16 thds., L. T.	20.	Barrack	207	1	2 oz.
2707	Spindle nut—right thread	1909-20.	3/4" x 16 R. H. thds.	10.	Barrow	209B.	1	2 oz.
2708	Spindle nut—left thread	1909-20.	3/4" x 16 L. H. thds.	10.	Baton	208B.	1	2 oz.
2709	Spindle washer	1909-20.	1/2" hole x 1 3/8"	02.	Barras	210	2	
2710	Spindle bolt with oiler	1910-20.	1/2" x 6 3/4"	25.	Barter	7708	2	7 oz.
2711	Spindle bolt nut	1909-20.	Order 2568.					
2713	Spindle body bush. (pair)	1909-20.	1/2" bore.	30.	Bartram	223	2	2 oz.
2714	Spindle arm bushing	1909-20.	1/2" bore, 1 1/8" dia., 1" L.	05.	Barwood	225	2	
2715	Spindle oiler	1909-16.	Order 3817					
2715C..	Spindle oiler	1917-18.		05.	Bilge	2944		
2717	Spindle con. rod	1909-20.	46 3/4" long.	2 50.	Basalt	264	1	3 lb., 2 oz.
2718	Spindle con. rod bolt with oiler	1909-20.	1/2" x 2 1/4"	20.	Basan	7706	2	3 oz.
2719	Spindle con.rod bolt nut	1909-20.	1/2" x 20 thds.	05.	Bashful	220	2	
2721	Spindle con. rod yoke	1909-18.	2 3/4" long.	40.	Bashule	248	1	5 oz.
2721B..	Spindle con.rod yoke ball	1919-20.		30.	Baroko	226	1	
*2721C..	Spindle con. rod yoke	1919-20.		40.	Barse	248B.	1	
2722	Steering yoke clamp bolt and nut	1909-18.		08.		79 & 8		
2725B	Steering gear con. rod	1909-20.	Includes ball sockets.	1 00.	Baslard	289	1	2 lb., 2 oz.
2728	Ball socket cap	1909-20.		15.	Basent	254B.	2	2 oz.
2729B..	Ball socket bolt and nut	1909-20.	Order 2722					
2733	Front radius rod	1909-19.		3 00.	Beardless	263	1	
2733B	Front radius rod	1919-20.		3 00.	Bedazzle	263B.	1	
2734	Front radius rod nut	1909-20.	Order 2548.					
2736	Front radius rod ball cap	1909-20.		15.	Baufet	217	1	3 oz.
2737	Front radius rod ball socket	1911-20.		20.	Beckon	809B.	1	11 oz.
2741	Radius rod ball cap stud and nut	1911-20.		05.	Berth	4365-8	2	
2742	Radius rod ball cap spr	1911-20.		03.	Bicep	292	2	
2760	FRONT AXLE ONLY	1911-16	60" tread.	14 00.	Bechance	1720B.	1	
2761	Steering spindle con. rod	1909-16.	60" tread.	3 00.	Becket	4199	1	3 lb., 7 oz.
2762	Steering gear con. rod	1909-16.	60" tread, includes ball sockets.	1 25.	Becloud	2739	1	

WHEELS

2800	Front wheel (specify color)	1909-19.	30" x 3"	9 00.	Becomb	291	2	
2801	Front wheel comp. R—Demountable	1919-20.	Timken Bearings included	14 00.	Bereave	7697	1	
2802	Front wheel comp. L—Demountable	1919-20.	Timken Bearings included	14 00.	Behest	7697	1	
2803	Front hub assembly less flange, bolts and nuts	1909-20.		3 03.	Bedew	200	2	4 lb., 9 oz.
2804	Outer race	1909-19.	1 1/4" dia.	15.	Bedere	234	2	2 oz.
2805	Inner race	1909-19.	2 3/8" dia.	20.	Bedight	235	2	5 oz.
2806	Outer ball retainer	1909-19.	1 1/4" dia.	02.	Bedim	236	2	
2807	Inner ball retainer	1909-19.	2 1/4" dia.	03.	Bedside	237	2	

*When substituting 2721C for old style yoke, also order 2721B Ball.

Insist upon genuine Ford parts

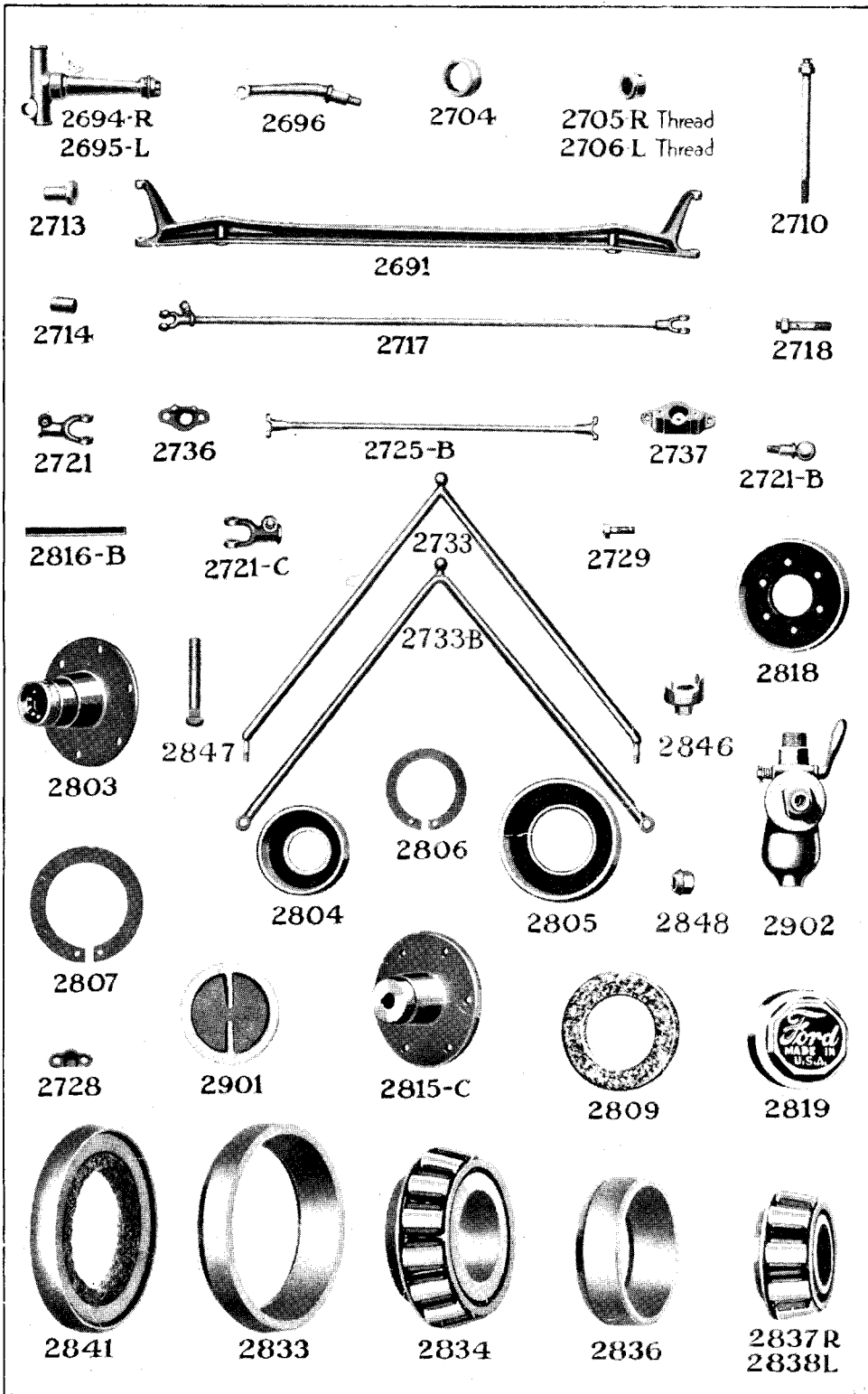

Part No.	Name of Part	Year	Specifications	Price	Code Word	Fac.No. No. per Car	Req. Car	Mailing Weight
WHEELS—Continued								
2808	Dust ring	1909-19	Steel 2 3/4" dia.	\$ 0 10	Bedward	238	2	1 oz.
2809	Front and rear hub felt washer	1909-19	2 1/2" dia.	05	Bedtje	239	4	
2810	Large balls, each	1909-19	1 1/2"	04	Beefing	241	24	
2811	Small balls, each	1909-19	3/8"	03	Beemol	249	22	
2814C	Rear wheel—blue (taper hub)	1912-19	30" x 3 1/2"	9 00	Beggah	2815	2	
2814E	Rear wheel comp.	1919-20	Demountable	12 50	Begin	7698	1	
2815C	REAR HUB (TAPERED) less flange, bolts & nuts	1912-20		2 00	Begol	2819	2	4 lb., 3 oz.
2816B	Rear hub key	1912-20	1/4" x 1 1/4" x 2 1/4"	05	Regloom	2863	2	1 oz.
2818	Rear hub brake drum	1909-20	3" hole, 8" dia.	70	Beguiler	3	2	2 lb., 9 oz.
2819	Hub cap	1909-20	2 1/2" x 2 1/4 thds.	20	Behave	7727	4	3 oz.
2825	Hub bolt and nut	1911-20	3/8" x 2 1/8" x 1 5/8 thds.	05	Belay	28B-29B	24	
2827	Hub flange	1911-20	6" dia.	30	Bellow	233B	4	1 lb., 5 oz.
2828	Rear hub lock nut	1912-20	5/8" x 1 1/8 thds.	10	Bengal	242	2	2 oz.
2831	Timken bearing assembly inner and outer R. including dust ring (in carton)	1919-20		3 50	Bemix	2961	1	
2832	Timken bearing assembly inner and outer L. including dust ring (in carton)	1919-20		3 50	Ben	2962	1	
2833	Front hub bearing cup inner	1919-20		60	Benip	2955	2	
2834	Inside spindle cone and roller assembly	1919-20		1 25	Bent	205B	2	
2835	Front hub bearing assembly inner (less dust ring)	1919-20		1 85	Bemusk	2954	2	
2836	Front hub bearing cup outer	1919-20		45	Bepad	2956	2	
2837	Outside spindle cone and roller assembly R.	1919-20		1 00	Beplay	206B	1	
2838	Outside spindle cone and roller assembly L.	1919-20		1 00	Beplume	207B	1	
2839	Front hub bearing assembly outer R.	1919-20		1 45	Berot	351	1	
2840	Front hub bearing assembly outer L.	1916-20		1 45	Beset	352	1	
2841	Front hub dust cap assembly	1919-20		20	Besunk	350	2	
2845	Demountable rim only	1919-20		3 00	Bethrone	8774	4	
2846	Demountable rim clamp and nut assb.	1919-20		15	Betime	8829	16	
2847	Demountable rim bolt	1919-20		10	Bewax	8832	16	
2848	Demountable rim bolt nut	1919-20		02	Benison	8834	4	
FRAME								
2850	Frame assembly	1909-20		16 00	Belone	2916	1	
2851B	Side member—right	1914-20		5 00	Benign	2914	1	
2852B	Side member—left	1914-20		5 00	Berdash	2915	1	
2853	Front cross member	1909-20	22 3/4" long	1 40	Beluga	303	1	3 lb., 15 oz.
2854B	Rear cross member	1914-20		1 60	Bendlet	2913	1	7 lb., 8 oz.
2855	Front corner bracket—right	1909-20		20	Benumb	305	1	8 oz.
2856	Front corner bracket—left	1909-20		20	Bequest	306	1	8 oz.
2857	Rear corner bracket—right	1909-20		20	Besiege	307	1	9 oz.
2858	Rear corner bracket—left	1909-20		20	Bespawl	308	1	9 oz.
2859	Frame front end spacer—left	1917-20		10	Benzoin	318B		
2860	Frame front end spacer—right	1917-20		10	Bestial	319B		
2863	Body bracket	1909-20	On frame	15	Bestow	344	4	4 oz.
GASOLINE TANK—TOURING CAR								
2900	Gasoline tank	1909-20	10 gallons	4 00	Bibber	1303	1	
2900B	Gas tank	1916-20	Sedan	7 00	Binocle	7950		
2901	Filling plug	1909-20	2 1/2"	10	Biblist	1317	1	1 oz.
2902B	Sediment bulb	1909-20	Less pet cock	1 00	Bickers	2088	1	1 lb., 2 oz.
2908	Pet cock	1909-20	Order 3079					
2909	Feed pipe	1909-20	Touring and Runabout, Also Coupe, 1915-17	50	Billet	1364	1	4 oz.
2910	Feed pipe pack nut	1909-20	1/2" x 1 1/8 thds.	05	Billow	1374	2	
2909B	Feed pipe	1916-20	Sedan	60	Bismuth	7965		
2909C	Feed pipe	1918-19	Coupelet	75	Bisque	9775		
2909D	Feed pipe	1919-20	Coupe	65	Betray	8690	1	
2911	Feed pipe	1915	Sedan 78" long	1 00	Betrap	1394	1	
2912	Sediment plug		Obsolete—Sub. with 3079					
2913	Feed pipe gasket	1909-20		02	Fester	5892		
MOTOR								
*3000C	Cylinder	1919-20	Starter type	35 00	Calcox	400D	1	
3001	Cylinder head	1909-20		8 00	Cabin	401C	1	
3002	Cyl. head gasket	1909-20		50	Caboose	402B	1	5 oz.

*When used on car not equipped with starter also order 3017B, 3017C, 3011, 3008 and 3016.

Insist upon genuine Ford parts



3001

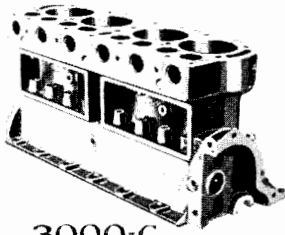

3000-C



3002



3009 B



3009-C



3017-B



3013



3017-D



3017



3084

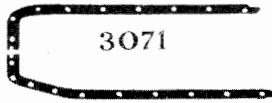

3071



3085



3101 B

3070

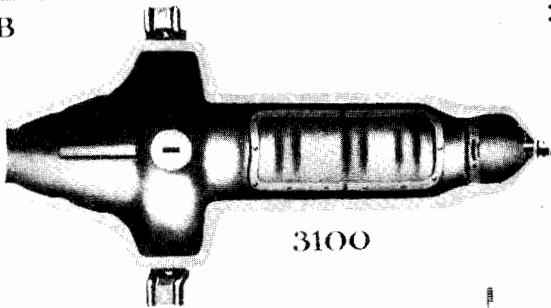

3100



3101



3102



3110



3111



3112



3165



3163



3176

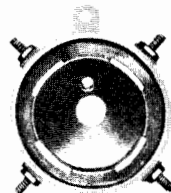

3221



3012

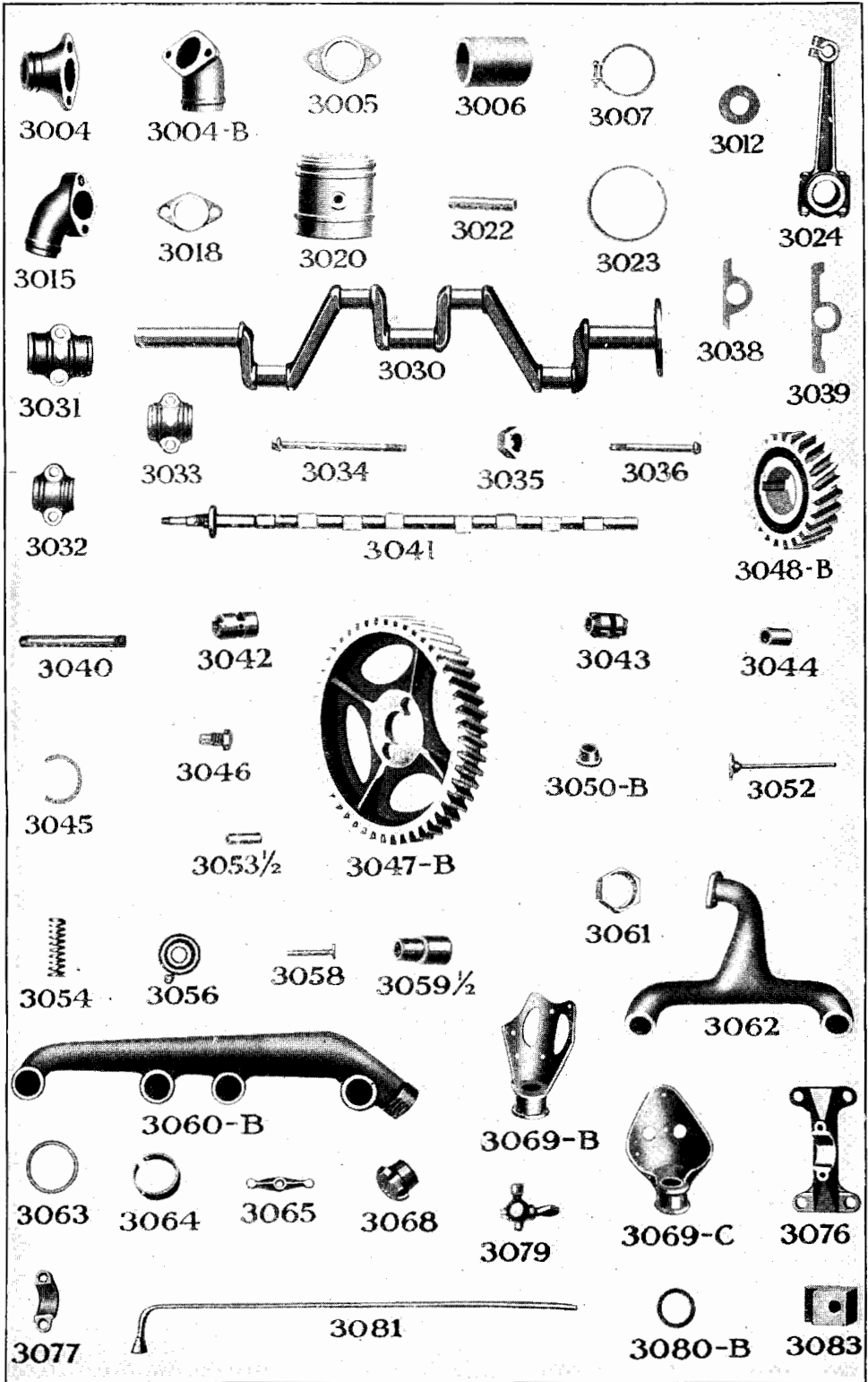

Plate No. 4

Part No.	Name of Part	Year	Specifications	Price	Code Word	Fac.No. per Car	Req.	Mailing Weight
MOTOR—Continued								
3003	Cyl. head cap screw	1909-20	$\frac{1}{16}$ " x $2\frac{1}{2}$ "	\$ 0	05. Cackle	483B	15	2 oz.
3003B	Cyl. head cap screw	1918-20	$\frac{1}{16}$ " x $3\frac{1}{4}$ "		05. Chub	483C		
3004	Cyl. head outlet connect.	1909-16	Cast iron		35. Caddow	446C	1	11 oz.
3004B	Cyl. head outlet connection	1917-20			35. Canis	8719	1	
3005	Cyl. head outlet con. gasket	1909-20			05. Caddy	445B	1	
3006	Cyl. head outlet hose	1909-20	2" x 4"		30. Cadet	448B	1	4 oz.
3007	Cyl. head outlet hose clip	1909-20	2 $\frac{3}{8}$ " dia.		05. Caddger	607B	2	1 oz.
3008	Cyl. head outlet con. screw	1909-20	$\frac{1}{16}$ " x $1\frac{1}{2}$ "		05. Cadmean	550C	2	1 oz.
3009B	Cyl. front cover	1909-19		1	50. Cage	690B	1	2 lb., 1 oz.
3009C	Cyl. front cover	1919-20	Starter type	1	50. Canard	690C	1	
3010	Cyl. cover bolt and nut	1909-20	$\frac{3}{8}$ " x $\frac{1}{2}$ " Order 4808					
3011	Cyl. cover cap screw	1909-20	$\frac{3}{8}$ " x $1\frac{1}{2}$ "		05. Cahoot	432	3	
3012	Cyl. cover felt	1909-20	Felt		05. Catiff	504	1	
3013	Cyl. cover liner	1909-19	Paper		02. Cajole	505B	1	
3013B	Cyl. cover liner	1919-20	Paper—Starter type		03. Cajom	505C	1	
3014	Cyl. cover and crank case bolt and nut	1909-20	$\frac{3}{8}$ " x $1\frac{1}{2}$ " Order 2722					
3015	Cyl. water inlet connection	1909-20	Cast iron	35	Calcine	442B	1	1 lb., 3 oz.
3016	Cyl. inlet con. screw	1909-20	$\frac{1}{16}$ " x $1\frac{1}{2}$ "		05. Caldron	597	2	
3017	Time gear cover	1919-20	Starter type	1	50. Calico	1754	1	
3017B	Time gear cover			1	00. Callix	1769		
3017C	Time gear cover gasket	1919-20	Old No. 4912		02. Candid	1775	1	
3017D	Time gear cover plate	1919-20	Old No. 4922		10. Canine	1773	1	
3018	Cyl. water inlet gasket	1909-19	Copper		05. Caley	596	1	
3019	Cyl. water jacket plug	1909-13	$\frac{1}{2}$ " pipe plug		05. Capin	557	3	1 oz.
3019B	Cyl. water jacket plug	1914-20			02. Canon	5919	3	
3020	PISTON COMPLETE	1909-20	$\frac{3}{8}$ " dia.	2	50. Calliph	586C	4	3 lb., 9 oz.
3020C	PISTON COMPLETE	1909-20	.0025" oversize	2	50. Canopy	683A	4	
3020D	PISTON COMPLETE	1909-20	.03125" oversize	2	50. Capon	683C	4	
3020E	PISTON COMPLETE	1909-20	.033" oversize	2	50. Churn	683B	4	
3021	Piston only	1909-20	$\frac{3}{8}$ " dia.	2	00. Callous	4472	4	
3021B	Piston only	1909-20	.0025" oversize	2	00. Chopin	5999	4	
3021C	Piston only	1909-20	.03125" oversize	2	00. Chord	5918	4	
3021D	Piston only	1909-20	.033" oversize	2	00. Chute	5901	4	
3022	Piston pin	1909-20		35	Callot	419B	4	4 oz.
3022 $\frac{1}{2}$	Piston pin bushing (pair)	1909-20		35	Callow	668	4	3 oz.
3023	Piston ring	1909-20	$\frac{1}{4}$ " x $3\frac{3}{4}$ "	15	Calmy	422	12	2 oz.
3023B	Piston ring	1909-20	.03125" oversize	15	Caif	5917	12	
3024	CONNECTING ROD	1909-20	Includes bearings	2	00. Calvish	641	4	1 lb., 9 oz.
3025	Con. rod cap bolt and nut	1909-20	$\frac{3}{8}$ " x $2\frac{1}{2}$ " x 24 thds.		06. Cambrie	489B-490	8	
3025	Con. rod clamp screw	1909-20	$\frac{3}{8}$ " x $1\frac{1}{2}$ "		06. Cambrie	578	4	
3030	CRANK SHAFT	1909-20	$25\frac{1}{8}$ " long	15	00. Camel	498B	1	
3031	C. S. rear bearing cap	1909-20	$3\frac{1}{8}$ " long, babbitted		90. Cameo	405B	1	1 lb., 1 oz.
3032	C. S. front bearing cap	1909-20	$3\frac{1}{8}$ " long, babbitted		65. Camera	406B	1	10 oz.
3033	C. S. center bearing cap	1909-20	$2\frac{1}{8}$ " long, babbitted		65. Camlet	407B	1	10 oz.
3034	C.S. bearing bolt—center and front	1909-20	$\frac{1}{2}$ " x $6\frac{1}{8}$ " x 20 thds.	20	Camphor	408	4	6 oz.
3035	C. S. bearing bolt nut	1909-20	Order 2568					
3036	C. S. rear bearing bolt	1909-20	$\frac{1}{2}$ " x $4\frac{1}{8}$ "	15	Candle	478	2	4 oz.
3038	C.S. bearing liner—center and front	1909-20	$1\frac{1}{8}$ " long, brass		01. Cannon	502B	8	
3039	C. S. rear bearing liner	1909-20	$3\frac{1}{8}$ " long, brass		01. Canny	503B	4	
3040	C. S. starting pin	1909-20	$\frac{3}{8}$ " x $2\frac{3}{4}$ "		05. Canoe	529B	1	2 oz.
3041	CAM SHAFT	1909-20		6	00. Canteen	410	1	3 lb., 4 oz.
3042	Cam shaft front bearing	1909-20	2" long	60	Canter	411	1	6 oz.
3043	Cam shaft center bearing	1909-20	$2\frac{1}{2}$ " long	35	Canthus	412B	1	6 oz.
3044	Cam shaft rear bearing	1909-20	Bronze, $1\frac{1}{8}$ " long	20	Canto	413	1	3 oz.
3045	Cam shaft bearing ring	1909-20	$\frac{3}{8}$ " x $1\frac{1}{2}$ "		05. Canvas	534	2	
3046	Camshaft bearing gsetscrew	1909-20	$\frac{1}{16}$ " x $\frac{5}{8}$ "		05. Capelin	414	2	
3047	Time gear—large (on cam shaft)	1909-19	42 teeth	1	25. Caper	415	1	1 lb., 10 oz.
3047B	Time gear—large (on cam shaft)	1919-20	Spiral	1	50. Clang	415B	1	
3048	Time gear—small (on crank shaft)	1909-19	21 teeth	1	00. Capat	416	1	11 oz.
3048B	Time gear—small (on crank shaft)	1919-20	Spiral	1	25. Claret	416B	1	
3049	Cam shaft gear dowel pin	1909-20	$\frac{3}{8}$ " x $\frac{1}{16}$ "		05. Capra	417	2	
3050B	Cam shaft gear lock nut	1909-20			20. Captive	4453	1	2 oz.
3051	Small time gear key	1909-20			05. Capsize	477	1	
3052	Valve	1909-20	Exhaust and inlet		20. Capstan	424	8	3 oz.
3052B	Valve	1909-20	$\frac{1}{8}$ " oversize stem		20. Cake	5913	8	
3053 $\frac{1}{2}$	Valve bushing	1909-20	$\frac{5}{8}$ " O. D. x 2" long	30	Captain	428	8	2 oz.
3054	Valve spring	1909-20			05. Capture	431	8	1 oz.
3056	Valve spring seat	1909-20	$1\frac{1}{8}$ " dia. Per Set of 8		05. Carack	425	8	
3057	Valve spring seat pin	1909-20	$\frac{1}{16}$ " x $1\frac{1}{2}$ " Per Set of 8		05. Caranx	429	8	
3058	Push rod	1909-20	$\frac{1}{16}$ " dia. $2\frac{1}{8}$ "		15. Carat	426	8	2 oz.
3058B	Push rod	1909-20	$\frac{1}{16}$ " oversize stem		15. Canine	5914	8	
3059 $\frac{1}{2}$	Push rod bushing	1909-20	Iron	30	Chippy	427B	8	2 oz.
3060B	Exhaust manifold	1913-20	Iron	2	00. Chirp	4483	1	4 lb., 8 oz.
3061	Exhaust pipe pack nut	1909-20	$1\frac{1}{2}$ " x 18 thds.	30	Chitter	518	1	4 oz.

‡Used with 3000C cylinder on cars not equipped with starter.

*Connecting rods requiring new bearings will be exchanged at Branch or Factory for \$1.00 each.

†Substitute spiral gears when replacing old style time gears.

Insist upon genuine Ford parts

Part No.	Name of Part	Year	Specifications	Price	Code Word	Fac.No. per Car	Req. Mailing Weight
MOTOR—Continued							
3062	Inlet pipe	1909-20		\$ 1	75. Chloris	512B..1	2 lb., 8 oz.
3063	Inlet and exh't pipe gasket	1909-20	1½" O. D. copper		03. Choker	513...61 oz.
3064	Inlet and exhaust pipe gland	1909-20	1¼" dia., iron		03. Chopper	514...6
3065	Inlet and exhaust pipe clamp	1909-20	2¾" long		15. Choral	515...43 oz.
3066	Inlet and exhaust clamp stud and nut	1909-20	¾" x 3¼"		10. Chorus	516-517...42 oz.
3068	Breather pipe	1909-20	1½" long		10. Chuck	4468...12 oz.
3069B	Crank case front end support	1911-17		1 00.	Clam	801C..1
3069C	Crank case front end support	1917-20		1 30.	Clack	801D..1
3070B	Cr. case & cyl. gasket—left	1909-20	Cork		10. Cider	886...1
3071B	Cr. c. & cyl. gasket—right	1909-20	Cork		10. Cigar	887...1
3072	Crank case and cyl. cover cap screw	1909-20	¾" x 1"		10. Cinter	1388...2
3073	Crank case arm bolt and nut—side	1909-20	¾" x 2¼"		10. Clippers	479-8...22 oz.
3074	Crank case arm bolt and nut—top	1909-20	¾" x ¾"		10. Circlet	940-8...2
3076	Crank case front frame bearing	1909-20	Iron		60. Circus	320B..1	1 lb., 6 oz.
3077	Crank case front bearing cap	1909-20	Iron		30. Cizar	321...13 oz.
3078	Crank case front bearing screw	1909-20	1½" x ½"		05. Clabber	322...21 oz.
3079	Crank case oil cock	1909-20		25.	Clamber	1515...22 oz.
3080	Crank case drain cup plug	1909-20	Order 2532				
3080B	Crank case drain cup plug gasket	1909-20			03. Cliff	4339...1
3081	Crank case oil tube	1909-20			30. Cleavast	543B..12 oz.
3083	Crank case arm block	1909-20	Wood		05. Clergy	890...23 oz.
3084	Engine pan—right	1909-20			40. Clicket	1330B..1	1 lb., 14 oz.
3085	Engine pan—left	1909-20			40. Clientage	1331B..1	1 lb., 11 oz.
3088B	Engine pan and hood board bolt and nut	1909-20	¼" x 3¼"		05. Clog	4074-1309...2
3088C	Engine pan and hood board bolt and nut	1909-20	¼" x 3½"		05. Clod	4073-1309...2
3100	CRANK CASE WITH LOWER COVER	1912-20		16 00.	Closet	1526E..1
3101	Crank case lower cover	1912-20	6½" x 15½"		50. Closure	1582...1	2 lb., 13 oz.
3101B	Crank case lower cover reinforcement	1912-20			45. Clothes	4378-4379...1	1 lb., 11 oz.
3102B	Cr. c. lower cover gasket	1912-20	Cork		10. Clotting	1586...1
3103	Crank case lower cover screw	1912-20	1½" x 1½"		05. Cloudlet	4328...14
3110	Cylinder valve cover	1912-20	3¼" x 8"		15. Clovate	656...29 oz.
3111B	Cyl. valve cover gasket	1912-20	Cork		05. Cloven	660...2
3112	Cylinder valve cover stud	1912-20	¾" x 2 3/8"		10. Compone	654...22 oz.
3114	Crank case arm with rivets	1909-20			35. Cloth	815...2
COMMUTATOR							
3162	Com. case support bolt	1912-19	¾" x 2¼" x 24 thds		05. Connote	4441...12 oz.
3162B	Com. case support bolt	1919-20	Starter type		07. Constrict	1756...1
3163	Com. case spring	1912-20	3¼" C. to C.		05. Conoid	689...11 oz.
3165	Com. brush only	1912-20			50. Conquest	4481...1
3176	Com. oiler	1912-16	¾" pipe thds.		05. Coomb	2383...1
3176B	Com. oiler	1917-20			05. Coot	480...1
3176C	Com. oiler	1919-20			05. Cookee	480B..1
3177	Com. felt ring	1912-20	Felt		03. Coombox	590...1
3206	Com. brush cap	1909-20	¾" dia.		02. Convert	468...1
3207	Com. brush cap pin	1909-20	¾" x 1 1/8"		02. Convict	466...1
3210	Com. contact point nut	1910-20	1/8" hex.		02. Cooper	472B..8
3212	Com. thumb nut	1909-17	No. 10, 32 thds		05. Copeck	6764...1
3220	Com. lock nut	1909-20	1/8" x 18 thds.		05. Crater	471...1
3221	Com. case with fibre assembled	1912-20		1 20.	Crato	5908...1
3222	Com. shield	1912-20			03. Crash	5923...1
MAGNETO							
3250D	Magneto coil assembly	1915-20	Used with ¾" magnets.	8 00.	Craft	5941B..1
3252	Magneto spool support screw	1909-20	Order 3371				
3254	Magnet bolt	1909-20	¾" x 1 1/2"		05. Corbell	537B..161 oz.
3255B	Magnet bolt washer	1911-20	1/8" hole, 7/8" dia.		02. Corrupt	624...16
3257	Magnet brass support	1909-20	¾" x ¾", brass		05. Cordial	535C..16
3260	Magneto coil assembly	1909-20	On trans. cover		35. Cornus	1545...12 oz.
3261B	Magneto contact nut	1909-20			01. Cornute	1508...2
3261C	Magneto contact screw washer	1909-20			01. Cornel	1565...1
3262	Magneto contact spring	1909-20	Coil spring		05. Cornise	1509...1
3262B	Magneto contact screw and spring assb.	1919-20			10. Corsage	4350...1
3266	Magneto contact fibre screw	1909-20	1/8" long		01. Cortile	1505B..3

Insist upon genuine Ford parts

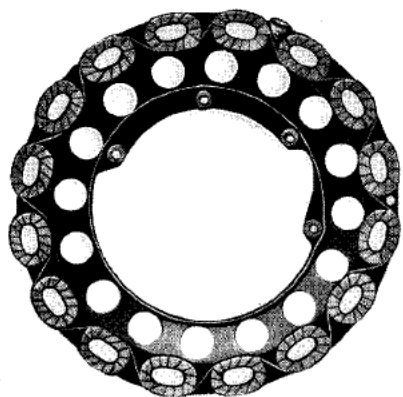

3250-D



3254

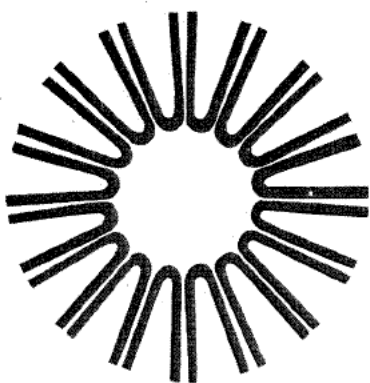

3276-B



3260

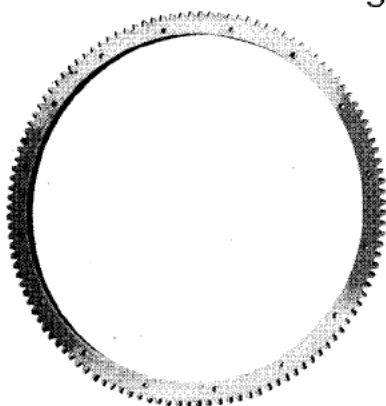

3268



3277



3257



3277-B



3270



3278



3255-B



3272

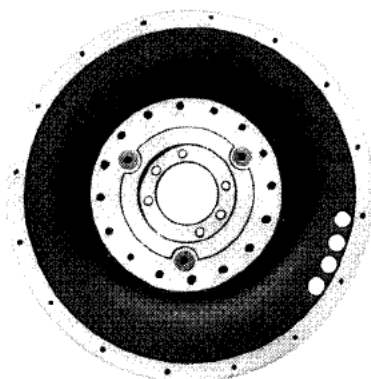

3269-C



3279



3269-E

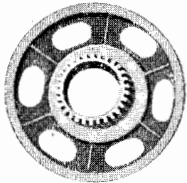

3301



3304



3309

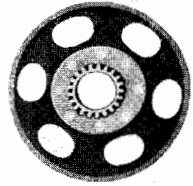

3306

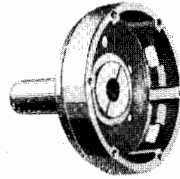

3311



3314



3314 1/2



3320-B



3313



3315



3317



3320-C

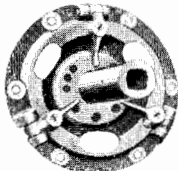

3321

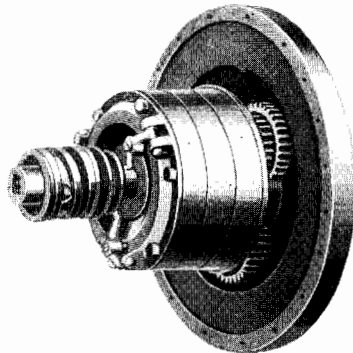

3300



3328



3327-B



3329



3330

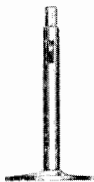

3331

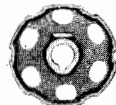

3332

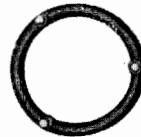

3336



3337



3338



3334



3340



3341



3368



3342



3344



3369

Part No.	Name of Part	Year	Specifications	Price	Code Word	Fac. No. per Car	Req.	Mailing Weight
MAGNETO—Continued								
3267	Magneto primary insulating block	1915-20		\$ 0 05	Crumple	4382		
3267B	Magneto contact insulator	1919-20		10	Crush	1503B		
3267C	Magneto contact insulator shell	1919-20		03	Crutch	8611		
3268	Fly wheel ring gear	1919-20	For starter	3 50	Cousln	1885	1	
3268B	Fly wheel ring gear lug	1919-20		02	Covey	1886	4	
3269C	Fly wheel	1911-19		6 50	Cosmic	701B	1	
3269E	Fly wheel with magnets assembled	1915-19	$\frac{3}{4}$ " magnets	15 00	Cramp	5946	1	
3269G	Fly wheel only	1919-20	Starter type	6 50	Cozy	701C	1	
3270	Fly wheel cap screw	1909-20	$\frac{1}{2}$ " x $1\frac{1}{8}$ "	15	Cossack	721	4	2 oz.
3271	Fly wheel dowel pin	1909-20	$\frac{1}{16}$ " x $1\frac{1}{8}$ "	05	Costard	722	2	
3272	Magneto coil support shim	1909-20	Sheet steel	10	Costrel	584	1	
3276B	Magnet (16) per set	1915-20	$\frac{3}{4}$ "	7 00	Court	5933	16	
3277	Magnet clamp	1911-20		05	Cotland	623	16	
3277B	Magnet clamp	1913-14		10	Cotta	4499	16	
3278	Magnet clamp screw	1911-20	$2\frac{1}{8}$ " x 24 thds., brass	05	Cottage	625	16	
3279	Magneto-contact washer	1909-20	On trans. cover cork	03	Cough	560	1	

TRANSMISSION

3300	Transmission assembly	1909-19	Non-starter type	50 00	Delester	744B	1	
3300B	Transmission assembly	1919-20	Starter type. Does not include gear or magnets	50 00		744C		
3301	Trans. reverse plate assembly	1909-20		4 00	Dacolt	747	1	4 lb., 14 oz.
3304	Trans. reverse gear bushing	1909-20	$2\frac{1}{16}$ " rear	70	Daddy	705	1	9 oz.
3305	Trans. reverse and S. S. rivet	1909-20	$\frac{1}{16}$ " x $\frac{11}{16}$ "	05	Dado	708	8	
3306	TRANS. SLOW SPEED PLATE ASSEMBLY	1909-20		3 50	Dagger	748	1	4 lb., 8 oz.
3309	Trans. slow speed gear bushing	1909-20	$1\frac{11}{16}$ " ream	60	Dairy	745	1	5 oz.
3310	Trans. brake drum rivet	1909-20	$\frac{1}{16}$ " x $\frac{11}{16}$ "	05	Daisy	711	8	
3311	TRANS. BRAKE DRUM ASSEMBLY	1909-20		4 50	Dakir	750	1	6 lb., 2 oz.
3313	TRANS. TRIPLE GEAR ASSEMBLY	1909-20		3 00	Dallop	751B	3	2 lb.
3314 $\frac{1}{2}$	Trans. triple gear flanged bushing	1911-20	$1\frac{1}{16}$ " dia. x $1\frac{11}{16}$ "	40	Dalriad	716B	3	4 oz.
3315	Trans. triple gear shaft	1909-20	$\frac{1}{16}$ " dia. x $2\frac{1}{2}$ "	25	Dalrotz	715	3	4 oz.
3316	Trans. triple gear riveting pin	1909-20	$\frac{3}{16}$ " x $1\frac{1}{8}$ "	05	Damar	720	24	
3317	Trans. driven gear	1909-20	27 teeth	1 25	Damask	713	1	13 oz.
3318	Trans. driven gear key	1909-20		05	Dampen	714	2	4 oz.
3320B	Trans. driven gear sleeve bushing	1909-20	1" ream x flange $2\frac{3}{8}$ "	60	Dankleh	769R	1	4 oz.
3320C	Trans. driven gear sleeve bushing	1909-20	$1\frac{1}{8}$ " long	35	Dark	712	2	3 oz.
3320D	Driven gear sleeve washer			03	Darken	776	3	
3321	TRANS. DRIVING PLATE ASSEMBLY	1909-20		5 00	Dannock	749	1	5 lb.
3323	Trans. driving platescrew	1909-20	Order 3371	05	Darner	736	8	
3325	Trans. driving plate rivet	1909-20	$\frac{1}{8}$ " x $\frac{9}{16}$ "	05	Darsis	772	1	
*3327B	Trans. driving plate bushing	1909-20	$1\frac{1}{8}$ " x $1\frac{1}{4}$ "	30	Darsis	772	1	
3328	Trans. thrust plate—small	1909-20	6" dia.	15	Dauphin	727	12	3 oz.
3329	Trans. thrust plate—large	1909-20	$6\frac{1}{16}$ "	20	Davine	728	13	3 oz.
3330	Trans. distance plate	1909-16	6" O. D.	30	Decry	729	1	7 oz.
3331	Trans. gear shaft	1909-20	1" dia. x $7\frac{1}{2}$ " over all	2 50	Decurt	723B	1	2 lb., 10 oz.
3332	Trans. clutch disc drum	1909-20	$4\frac{1}{8}$ " dia.	2 50	Deeply	725B	1	1 lb., 11 oz.
3333	Trans. clutch disc drum key	1909-20		05	Defalk	726B	1	
3334	Trans. clutch disc drum set screw	1909-20	$\frac{3}{8}$ " x $\frac{3}{4}$ "	05	Defeat	752	1	
3336	Trans. clutch push ring	1909-20	$6\frac{1}{8}$ " O. D.	50	Defle	770	1	1 lb., 1 oz.
3337	Trans. clutch finger	1909-20		25	Define	732	3	3 oz.
3337 $\frac{1}{2}$	Trans. clutch fingerscrew	1909-20	$\frac{3}{16}$ " x $\frac{3}{4}$ " x 24 thds.	05	Defour	756	3	
3338	Trans. clutch finger pin	1909-20	$\frac{3}{16}$ " x $1\frac{1}{8}$ "	02	Deform	735	3	1 oz.
3340	Trans. clutch spring	1909-20	$2\frac{3}{8}$ " dia. x $2\frac{3}{4}$ " long	40	Defoue	737	1	10 oz.
3341	Trans. clutch spring support	1909-20		15	Delator	738	1	4 oz.
3342	Trans. clutch spring thrust ring pin	1909-20	$\frac{1}{16}$ " x $2\frac{3}{8}$ "	05	Delete	739	1	
3344	Trans. clutch shift	1909-20		1 00	Delight	733	1	14 oz.

TRANSMISSION COVER

3362	Trans. cover bolt and nut	1909-20	$\frac{3}{8}$ " x $1\frac{1}{4}$ ". Order 2722					
3363	Trans. cover gasket (front)	1909-20	$\frac{1}{16}$ " x $\frac{1}{2}$ " x $15\frac{1}{2}$ " Felt	05	Defy	872B	1	
3367	Trans. cover door screw	1909-20	$\frac{1}{8}$ " x $\frac{1}{2}$ "	02	Demain	430	6	

*When using short bushing in making repairs remove driving plate key.

Insist upon genuine Ford parts

Part No.	Name of Part	Year	Specifications	Price	Code Word	Fac.No. per Car	Reg. Mailing Weight
TRANSMISSION COVER—Continued							
3368	Universal ball cap (rear)	1909-20	5 3/8"	\$ 0	50. Demarch	818	1 15 oz.
3369	Universal ball cap (front)	1909-20	Bearing included	1	75. Demarga	819D	1 1 lb., 14 oz.
3371	Universal ball cap screw	1909-20	3/8" x 1 1/8"		05. Demise	731	2
3372	Universal ball cap bolt and nut	1909-20	Order 2722				
3375	Trans. cover screw	1909-20	Order 3072				
*3376	TRANS. COVER	1911-19		10	00. Denier	826D	1
3376B	TRANS. COVER	1919-20	Starter type	10	00. Den	826E	1
3377B	Trans. cover gasket (pair)	1909-20	Cork	15	Dennet	885B	1 pr.
3378	Trans. cover sloping door	1911-20	9 1/8" long	15	Dental	1546D	1 1 lb., 5 oz.
3379B	Trans. cover sloping door gasket	1911-20	Cork	10	Denude	1547C	1
3380	Bendix cover	1919-20	Old No. 4906	40	Tendon	1763	1
3381	Bendix cover gasket	1919-20	Old No. 4915	05	Thigh	1764	1
3382	Trans. cover rear plate	1919-20	Old No. 4922	10	Deputy	1761	1
3383	Trans. cover front plate	1919-20	Old No. 4924	15	Descry	1758	1

TRANSMISSION CONTROL

3400	Trans. clutch release ring	1909-20	3 1/8" long	30	Detail	741	1 6 oz.
3402C	Clutch lever and shaft with release forks	1913-20		1	20. Dirk 1553-1548-4345	1	1 lb., 8 oz.
3402D	Clutch lever and shaft	1913-20		60	Disdain	1548	
3403	Clutch lever screw and nut	1909-20	3/8" x 1 1/8"	05	Dervish 1541-517	1	1
3405	Clutch lever pin	1909-20	1/4" x 1 1/8"	02	Detour	1553	1
3406B	Clutch release fork—right or left	1913-20		30	Deuce	4345	2 3 oz.
3406C	Clutch release fork pin	1913-20	Order 3405				
3408	Clutch release fork key	1909-14		05	Dilate	836	2
3409	Clutch release fork clamp screw	1909-14	3/8" x 1 1/8"	10	Dipper	835	2
3411	Clutch lever clevis pin	1909-20	Order 2564				
3413	TRANSMISSION BAND ASSEMBLY	1909-20		75	Disblame	838B	3 1 lb., 2 oz.
(Bands will be exchanged at Branch or Factory at 60c each.)							
3415	Trans. band washer	1909-20	3/4" hole x 7/8" dia.	03	Discure	840	2
3416	Trans. band lining	1909-20		30	Disedge	1562	3 3 oz.
3419	Trans. band adjusting screw	1909-20	3/4" x 3 1/8"	15	Disfriar	1533	1 4 oz.
3420	Trans. band adjusting screw nut	1909-20	3/4" x 16 thds.	05	Dislimb	1532	1
3421B	Trans. band ear iron rivet, per doz	1909-20	3/16" x 3/8"	05	Dismal	843	12
3422B	Trans. band brass rivet, per doz	1909-17	3/4" x 1 1/2"	05	Dismast	844B	6
3423B	Trans. band brass rivet, per doz	1909-20	3/4" x 1 1/8"	05	Dismaw	845B	18
3425	Trans. band spring	1909-20	Coil	05	Dispark	841B	3
3426	Trans. band adjusting nut	1909-20	1 1/8" x 20 thds.	05	Dislat	851	2
3427	Slow speed shaft	1909-20	5/8" x 9 3/4"	25	Disputz	848B	1 11 oz.
3428	Slow speed notch	1909-20	On slow speed shaft	30	Distrand	4327	1 5 oz.
3429	Slow speed notch pin	1909-20	1/4" x 1 1/8"	02	Disrobe	1560	1
3432	Speed lever	1909-20		10	Distaff	862B	1 1 lb., 7 oz.
3434	Reverse pedal	1909-20		80	Disting	4324	1 1 lb.
3435	Brake and rev. pedal shaft	1909-20	5/8" dia. x 7 1/8"	30	Distrite	849B	2 8 oz.
3436	Brake and rev. pedal support	1909-20		25	Distune	4325	2 3 oz.
3437	Brake and rev. support bolt and nut	1909-20	3/8" x 1 1/2"	05	Ditcher	1534-8	2
3439	Brake pedal	1909-20		80	Dittost	4323	1 1 lb., 2 oz.
3440	Clutch pedal	1909-20		80	Ditty	854B	1 1 lb., 2 oz.
3441	Pedal pin	1909-20	Order 3405				
3442	Clutch pedal support	1909-20		20	Dookad	4326	1 3 oz.
3443	Clutch pedal support bolt and nut	1909-20	3/8" x 2"	05	Doorga	1536-8	1
3445	Slow speed connection	1909-20		05	Dorec	1540	1
3446	Slow speed con. lock nut	1909-20	1 1/8" x 24 thds.	03	Doric	44	1
3447	Slow speed con. clevis	1909-20		15	Dormer	802	1 2 oz.
3448	Controller quadrant	1909-20	On frame	25	Dormouse	309B	1 9 oz.
3449	CONTROLLER SHAFT WITH SPEED LEVER	1909-20		1	00. Doron	1557	1 3 lb., 15 oz.
3450	Controller shaft bracket	1909-20	On frame	20	Dorrer	311	2 5 oz.
3451	Controller shaft bracket felt	1909-20		01	Dorsal	314	2
3452	Controller shaft bracket bolt and nut	1909-20		05	Dorture	315-316	4
3455	HAND BRAKE LEVER ASSEMBLY	1909-20		2	00. Dotant	1550	1 2 lb., 2 oz.
3456	Hand brake lever pin	1909-20	Order 3429				
3456B	Hand brake lever pin	1909-20	Order 2574				
3457	Hand brake lever key	1909-17		05	Doublet	874	1
3458	Hand brake lever pawl	1909-20		10	Doucet	875	1
3459	Hand brake lever pawl pin	1909-20	1/8" x 1 1/8"	03	Doura	876	1
3460	Hand brake lever pawl rod	1909-20		10	Dovecote	877	1 3 oz.

*Substitute with 3376B.

†When ordered to replace cover on cars below 2044100 also order 3402B clutch lever shaft.

Insist upon genuine Ford parts

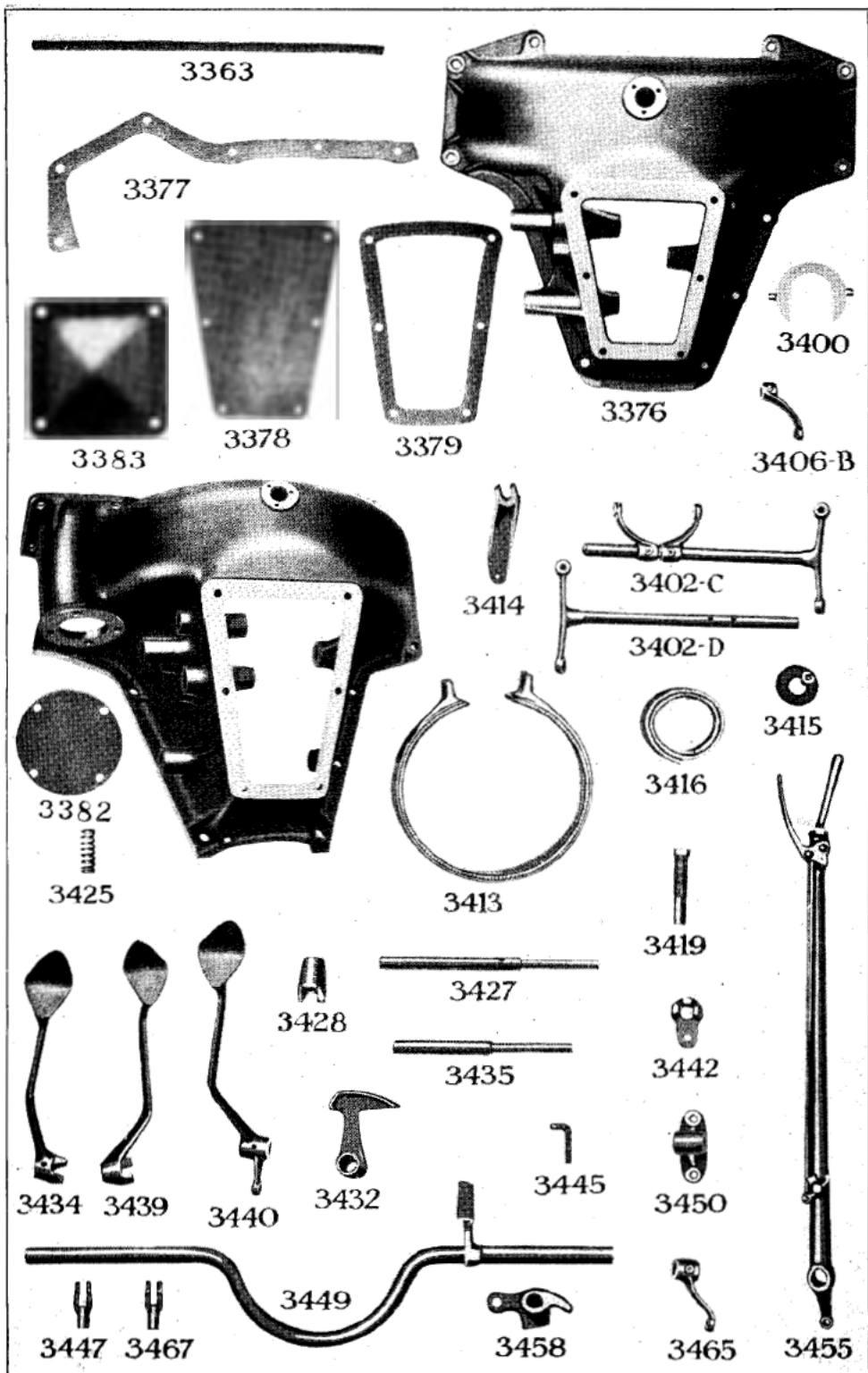

Plate No. 7

Part No.	Name of Part	Year	Specifications	Price	Code Word	Fac.No. Req. No. per Car	Mailing Weight
3462	Hand brake lever pawl lift assembly	1909-20	Handle and spring	\$ 0 10	Dovekie	4363 . . . 1 2 oz
3463	Hand brake lever pawl lift spring	1909-20			02. Dawcet	888 . . . 1	
3465	HUB BRAKE LEVER ON CONTROLLER SHAFT	1909-20			20. Dawdy	864 . . . 1 3 oz.
3466	Hub brake lever pin	1909-20	Order 3405				
3467	Hub brake lever clevis	1909-20	2 $\frac{1}{8}$ " Order 3447				
3468	Hub brake pull rod—right	1909-20	54 $\frac{1}{8}$ " long		75. Drongo	891B . . 1	
3469	Hub brake pull rod—left	1909-20	54 $\frac{1}{8}$ " long		75. Dropax	1513B . . 1	
3470	Hub brake rod support—right	1909-20			10. Dropsy	1367 . . 1 4 oz.
3471	Hub brake rod support—left	1909-20			10. Druggier	1398 . . 1 4 oz.
3472	Hub brake rod support bolt and nut	1909-20	$\frac{1}{4}$ " x $1\frac{1}{8}$ "		05. Duchess	1308-1309 . 2	

STEERING GEAR

3500C	Steering gear assembly	1911-20	51" long	14 00	Estopped	5042 . . . 1	
3501B	Steering gear rim	1909-20	15" dia., wood	2 00	Estrade	901B . . 1	1 lb., 6 oz.
3502	Steering gear rim screw	1909-20	No. 12, $\frac{3}{4}$ "	02	Eblis	919 . . . 4	
3503B	Steering gear spider	1909-20	13 $\frac{3}{8}$ " over all	1 00	Estrepe	902B . . 1	1 lb., 10 oz.
3503C	Steering gear spider and rim	1909-20	15" dia.	3 00	Eudora	995 . . . 1	
3504	Steering gear cover	1909-20	2 $\frac{1}{4}$ " x 18 thds.	40	Ecbale	5039 . . 1	10 oz.
3505	Steering gear cover screw	1909-20	No. 6, 32 x $\frac{1}{2}$ "	02	Eccope	910 . . . 1	
3506	Steering gear cover bushing	1909-20	1" long, steel	10	Echo	914 . . . 1 2 oz.
3506B	Steering gear driving pinion washer	1909-20	Steel	03	Elf	5026 . . 1	
3507	Steering gear internal gear case and bushing	1909-20		2 00	Egg	5036 . . 1	
3509	Steering gear quadrant	1909-20		15	Ectype	906B . . 1 7 oz.
3510	Steering gear quadrant rivet	1909-20	$\frac{3}{8}$ " x $1\frac{1}{4}$ "	01	Eden	5041 . . 2	
3511	Steering gear wheel nut	1909-20	$\frac{3}{8}$ " x 16 thds.	10	Edict	913 . . . 1 2 oz.
3512C	Steering gear tubing assembly	1912-20	Applies to No. 3500C	8 00	Ethicer	5016 . . 1	
3513B	Steering tubing flange screw and nut	1911-20	$\frac{5}{16}$ " x $1\frac{1}{8}$ "	05	Ethule	5019-926 . 1	
3513C	Steering tubing flange screw and nut	1911-20	$\frac{5}{16}$ " x $1\frac{1}{8}$ "	05	Ettle	5018-926 . 3	
3516C	Steering gear post	1912-20	Applies to No. 3500C	3 00	Estricked	5002 . . 1	
3517	Steering gear pinions, each	1909-20	12 teeth	15	Egad	916 . . . 3	
3518	Steering gear pinion pin	1909-20	$\frac{3}{8}$ " x $1\frac{1}{8}$ "	05	Egest	917 . . . 3	
3519	Steering gear drive pinion	1909-20	12 teeth	40	Egger	911 . . . 1 7 oz.
3520	Steering gear drive pinion key	1909-20	$\frac{3}{16}$ " sq. x $\frac{1}{2}$ "	03	Egma	909 . . . 1	
3521	Steering gear pinion shaft bushing	1909-14	$\frac{7}{8}$ " bore x $1\frac{1}{2}$ "	30	Egress	912 . . . 1	
3523	Steering gear post castle nut	1909-20	Order 2568				
3524E	Throttle rod	1912-20	47 $\frac{1}{8}$ " Applies to 3500C	50	Euter	5038 . . 1	1 lb., 3 oz.
3525E	Lead rod	1912-20	51 $\frac{1}{8}$ " Applies to 3500C	50	Evans	5037 . . 1	1 lb., 4 oz.
3527	Lead and throttle rod spring	1909-20		03	Elite	935 . . . 2	
3528	Lead and throttle rod collar	1909-20	$\frac{5}{16}$ " bore x $\frac{1}{16}$ "	02	Elope	936 . . . 2	
3529	Lead and throttle rod pin	1909-20	$\frac{3}{8}$ " x $\frac{1}{16}$ "	01	Elvan	937 . . . 5	
3530	Lead rod lever	1909-20		15	Embank	946 . . 1	
3531	Throttle rod lever	1909-20		15	Ember	947 . . 1	
3532	Throttle rod guide	1909-20	$\frac{3}{4}$ " bore	10	Emblem	938 . . 1	
3534B	Commutator pull rod	1912-20		10	Embrace	2082 . . 1 3 oz.
3535	Carburetor pull rod	1909-20	14 $\frac{1}{8}$ " long	10	Emboss	1329 . . 1 3 oz.
3536	Ball and socket joint	1909-20		10	Embraid	1326 . . 4 1 oz.
3537	Ball and socket joint nut	1909-20	$\frac{1}{2}$ " x 32 thds.	02	Embrute	1327 . . 1	
3539B	Steering post bracket with bushing	1911-20	Touring	1 00	Eupon	996 . . . 1	1 lb., 14 oz.
	Steering post bracket bolt and nut	1909-20	Order 3073 or 3074				
3544	Steering post bracket felt washer	1909-20		03	Endow	943 . . . 1	
3545	Steering post bracket bushing	1909-20	$\frac{3}{4}$ " bore, brass, 2 pieces	30	Envault	944-5027 . 1 2 oz.
3546	Steer. post bracket block	1909-20	Wood	10	Empact	945 . . . 1 3 oz.
3547	Steering gear ball arm	1909-20		60	Eparch	929B . . 1 11 oz.
3548	Steering gear ball arm key	1909-20		05	Ephod	930 . . . 1	

BODY PARTS

3601B	Body bracket on body	1910-20	Center and rear	15	Fabric	1624 . . . 6 8 oz.
3602D	Body bracket con. bolt and nut		$\frac{1}{8}$ " x $\frac{1}{2}$ "	05	Facade	5653-220 . . 6	

Insist upon genuine Ford parts

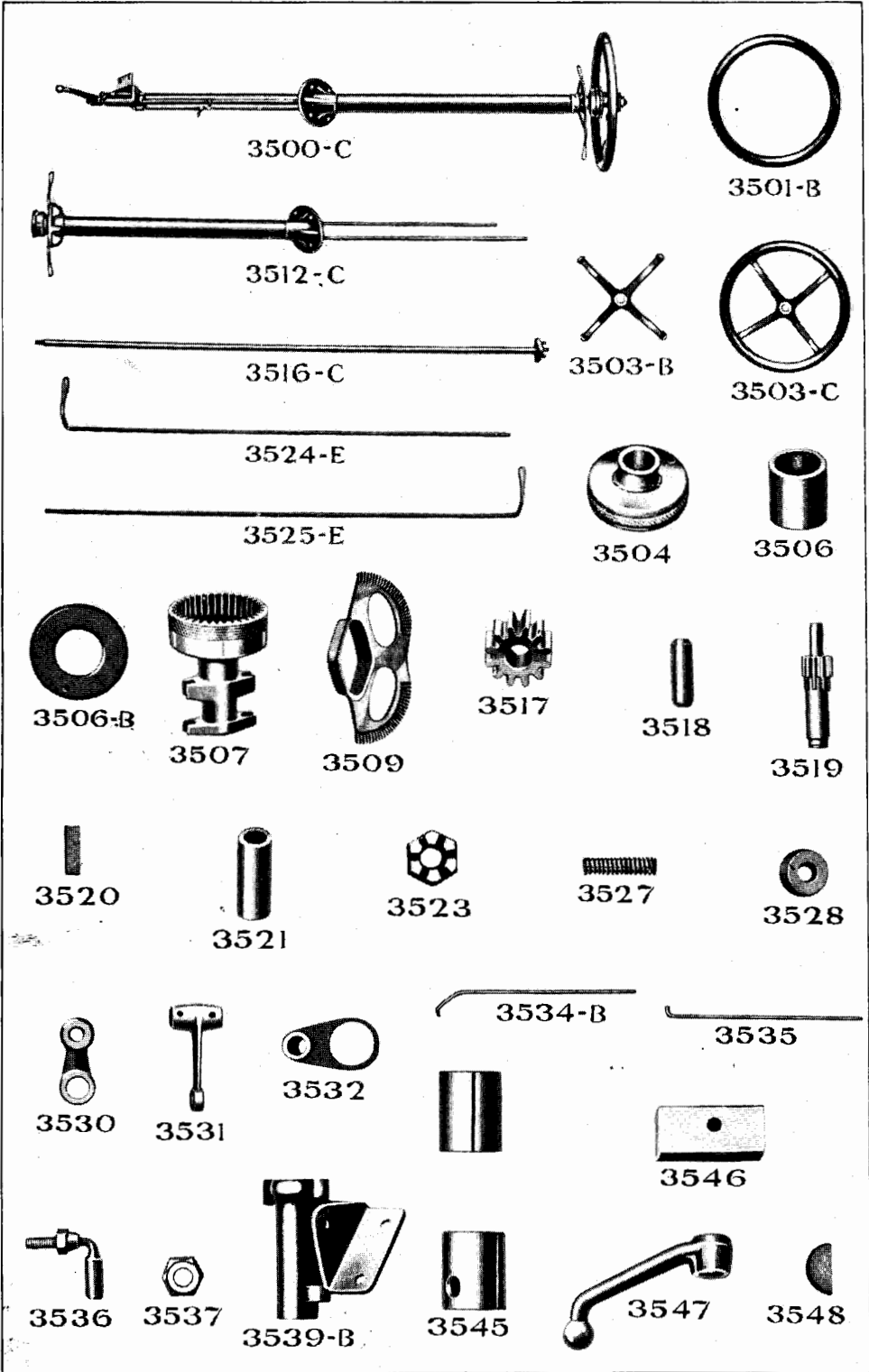

Part No.	Name of Part	Year	Specifications	Price	Code Word	Fac.No. per Car	Req. Weight	Mailing
BODY PARTS—Continued								
3602E	Body bracket con. bolt and nut.		$\frac{1}{8}'' \times 1 \frac{1}{2}''$	\$ 0 05	Fade	2431-220	2	
3624E	Front floor rubber mat.	1915-20	$28 \frac{1}{4}'' \times 29 \frac{1}{8}''$ Tr. & Rb't.	2 00	Faith	7299	1	
3626B	Floor board (first)	1915-20	Tour. R'nab't&Coupelet.	75	Farm	7296	1	
3626C	Floor board with plate (first)	1915-20		85		4200		
3627B	Floor board (second)	1915-20	Tour.,Runab't&Coupelet	75	Faro	7297	1	
3627C	Floor board with plate (second)	1915-20		85		4201		
3628	Floor board (third)		Specify size.	90	Fasces	1404	1	
3628B	Floor board with plate (third)	1915-20		1 00		7104		
3629	Floor board (fourth)		Specify size.	60	Fasti	1403	1	
3630	Floor board forward plate for pedals	1909-20	$2 \frac{1}{8}'' \times 3 \frac{1}{2}''$	10	Fateful	1400C	1	6 oz.
3632	Floor board rear plate for pedals	1909-20	$2 \frac{1}{8}'' \times 4 \frac{1}{2}''$	10	Father	1095C	1	12 oz.
3633	Floor board plate for side lever.	1909-20	$2 \frac{3}{8}'' \times 8 \frac{3}{4}''$	10	Fathom	1094B	1	5 oz.
3634D	Dash	1913-14	$21 \frac{1}{2}'' \times 32 \frac{1}{4}''$	6 25	Flamgo	5336	1	9 lb., 4 oz.
3634E	Dash	1915-16		3 50	Fleet	7462	1	
3634G	Dash	1917-20		3 00	Fringe	8754	1	
3638	Dash shield.	1909-19	$3 \frac{1}{2}'' \times 3 \frac{7}{8}'' \times 13 \frac{3}{4}''$	10	Faubit	5432	1	5 oz.
3638B	Dash shield.	1919-20		10	Faubage	5432B	1	
3639	Dash weatherstrip—side	1917-20		05	Flicker	8747	2	
3639B	Dash weatherstrip—top	1917-20		30	Floren	8752	1	
*3640B	Dash bracket—left	1911-16						
3640C	Dash bracket—left	1917-20		30	Foal	8722	1	
*3641B	Dash bracket—right	1911-16						
3641C	Dash bracket—right	1917-20		30	Fowl	8721	1	
3642B	Dash bracket to dash bolt and nut.	1917-20		05	Fume	8740-926	4	
3645	Dash bracket to dash bolt and nut.	1909-16	$\frac{1}{8}'' \times 1 \frac{1}{4}'' \times 18$ thds.	05	Favos	2427-341	2	
3653B	Dash to body bracket bolt and nut.	1915-20	Touring car	05	Feud	4248-341	2	
3654	Dash to body gasket	1918-19		05	Feaze	8769		
3660C	Tail lamp and license bracket assembly	1915-19	Touring car, Sedan, Town car	40	Flour	7506	1	
3660D	Tail lamp and license bracket assembly	1915-19	Runabout and 1916-17 Coupelet.	40	Flute	7505	1	
3667E	Front seat cushion.	1909-20		10 00	Farce	8076	1	
3670D	Rear seat cushion.	1909-20		10 00	Forum	7032	1	
3676B	Tonneau mat.	1911-20	$30'' \times 28''$ wool.	2 00	Flatus	1606B	1	

SPRINGS

3800	Front spring	1909-20		4 00	Gadan	332	1	16 lb., 11 oz.
3801	First leaf (main leaf)	1909-20		1 00	Golf	2943	1	4 lb., 2 oz.
3802B	Second leaf	1909-20		80	Goose	2935	1	3 lb., 7 oz.
3803	Third leaf	1909-19	Tapered ends.	70	Gaddish	356	1	2 lb., 11 oz.
3803B	Third leaf	1916-20	Square ends.	70	Gopher	2936	1	2 lb., 10 oz.
3804	Fourth leaf	1909-19	Tapered ends.	60	Gadoid	357	1	2 lb., 6 oz.
3804B	Fourth leaf	1916-20	Square ends.	60	Gosling	2937	1	2 lb., 3 oz.
3805	Fifth leaf	1909-19	Tapered ends.	50	Gallic	358	1	1 lb., 13 oz.
3805B	Fifth leaf	1916-20	Square ends.	50	Gossip	2938	1	1 lb., 8 oz.
3806	Sixth leaf	1909-19	Tapered ends.	40	Gafol	359	1	1 lb., 5 oz.
3806B	Sixth leaf	1916-20	Square ends.	40	Gothic	2939	1	1 lb., 1 oz.
3807	Seventh leaf	1909-16	Tapered ends.	25	Gaiter	360	1	15 oz.
3807B	Seventh leaf	1916-20	Square ends.	25	Gaily	2947	1	
3808	Front spring clip	1909-20		30	Galena	325B	2	10 oz.
3809	Front spring clip nut	1909-20	Order 2568.					
3811	Front spring tie bolt and nut.	1909-20	$\frac{5}{16}'' \times 2 \frac{1}{4}''$	06	Galley	1362-1363	1	1 oz.
3813	Front spring hanger	1909-20		30	Gambit	246B	4	4 oz.
3815	Front and rear spring hanger nut	1909-20	Order 2719.					
3817	Front and rear spring hanger oiler	1909-20		05	Gamin	218	8	
3818	Front spring perch—right	1909-19		80	Gamut	274	1	15 oz.
3818B	Front spring perch—right	1919-20		80	Garret	274B		
3819	Front spring perch—left	1909-19		80	Gander	275	1	15 oz.
3819B	Front spring perch—left	1919-20		80	Gastar	275B		
3820	Front spring perch bushing	1909-20	$\frac{11}{16}'' \times 1 \frac{1}{2}''$	05	Gangue	230	4	1 oz.
3821	Front spring perch nut	1909-20	$\frac{3}{8}'' \times 18$ thds. Order 2828.					
3823	Front spring leather	1909-20	$1 \frac{1}{2}'' \times 5 \frac{3}{4}''$	10	Gannet	262	1	2 oz.
3824	REAR SPRING	1909-20	$56''$ tread, 8 leaf.	12 00	Ganoid	333	1	
3825	First leaf (main leaf)	1909-19	Tapered ends.	2 00	Gantlope	361	1	9 lb.
3825B	First leaf (main leaf)	1918-20		2 00	Callop	361B	1	
3826	Second leaf	1909-19	Tapered ends.	1 75	Gantois	362	1	7 lb., 7 oz.
3826B	Second leaf	1918-20	Square ends.	1 75	Galore	362B	1	
3827	Third leaf	1909-19	Tapered ends.	1 65	Ganza	363	1	6 lb., 11 oz.
3827B	Third leaf	1918-20	Square ends.	1 65	Garnish	363B	1	
3828	Fourth leaf	1909-19	Tapered ends.	1 50	Gaphare	364	1	6 lb., 5 oz.
3828B	Fourth leaf	1918-20	Square ends.	1 50	Gender	364B	1	
3829	Fifth leaf	1909-19	Tapered ends.	1 40	Garden	365	1	5 lb., 13 oz.
3829B	Fifth leaf	1918-20	Square ends.	1 40	Genus	365B	1	

*Redrill frame and use new style brackets Nos. 3640C and 3641C.

Insist upon genuine Ford parts

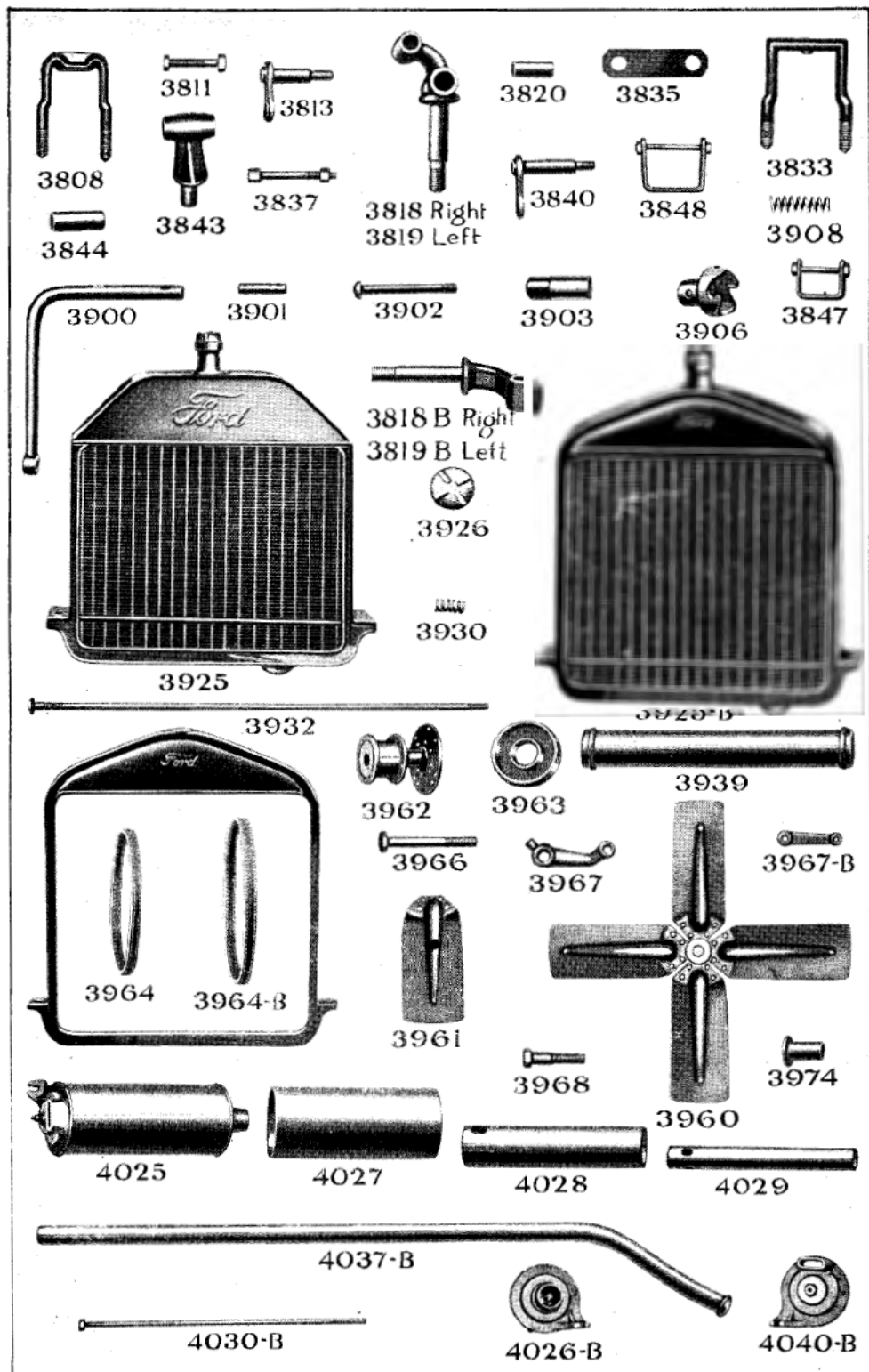

Part No.	Name of Part	Year	Specifications	Price	Code Word	Fac.No. per Car	Req. Weight
SPRINGS—Continued							
3830	Sixth leaf	1909-19	Tapered ends	\$ 1 30	Garland	366	1 5 lb., 11 oz.
3830B	Sixth leaf	1918-20	Square ends	1 30	Ghoul	366B	1 5 oz.
3831	Seventh leaf	1909-19	Tapered ends	1 15	Garlic	367	1 5 lb., 7 oz.
3831B	Seventh leaf	1918-20	Square ends	1 15	Giant	367B	1 5 oz.
3832	Eighth leaf	1909-19	Tapered ends	1 00	Garner	368	1 3 lb., 8 oz.
3832B	Eighth leaf	1918-20	Square ends	1 00	Gimlet	368B	1 1 3 lb., 8 oz.
3833	Rear spring clip	1909-20	4 1/16"	25	Game	326	2 11 oz.
3834	Rear spring clip nut	1909-20	Order 2548				
3835	Rear spring clip bar	1909-20	3/8" x 1 1/8" x 4" x 1/16"	10	Gascon	329	2 7 oz.
3837	Rear spring tie bolt and nut	1909-20	3/8" x 2 1/8"	06	Gastric	1352-1353.1	2 2 oz.
3840	Rear spring hanger	1909-20		30	Gaulus	91 1/2B	4 5 oz.
3842	Rear spring leather pad	1909-20	2" x 10 1/4"	10	Gavel	94	1 2 oz.
3843	Rear spring perch	1909-20		60	Gavot	2804	2 12 oz.
3844	Rear spring perch bushing	1909-20	1/8" bore x 3/4" dia. x 2"	05	Gawky	172	4 2 oz.
3845	Rear spring perch nut	1909-20	1/4" x 16 thds.	10	Gazara	174	2 2 oz.
3847	Front spring clip assembly with bolt and nut	1909-16		10	Gazzam	372	2 3 oz.
3847B	Front spring clip assembly with bolt and nut	1915-20	(for 6 leaf spring)	10	Gown	2953	2 5 oz.
3848	Rear spring clip assembly with bolt and nut	1909-17		10	Gecko	376	2 4 oz.
3848B	Rear spring clip assembly with bolt and nut	1918-20		10	Gemmy	378	2 5 oz.
REAR SPRING—60 INCH TREAD							
3850	Rear spring	1909-16	48 1/2" long, 8 leaf	15 00	Geddur	1704	1 12 oz.
3851	Rear spring clip	1909-16	1/8" x 4 1/16"	25	Gelder	1737	2 12 oz.
3852	Rear spring tie bolt and nut	1909-16	3/8" x 3 3/8"	10	Gemote	1738-1353.1	1 3 oz.
3853	First leaf (main leaf)	1909-16		3 00	Gemsbok	1739	1 10 lb., 10 oz.
3854	Second leaf	1909-16		2 50	Gershon	1740	1 9 lb., 1 oz.
3855	Third leaf	1909-16		2 00	Gerper	1741	1 8 lb., 3 oz.
3856	Fourth leaf	1909-16		1 75	Gherkin	1742	1 6 lb., 1 oz.
3857	Fifth leaf	1909-16		1 60	Gibbet	1743	1 5 lb., 8 oz.
3858	Sixth leaf	1909-16		1 50	Ginger	1744	1 6 lb., 10 oz.
3859	Seventh leaf	1909-16		1 30	Gipsire	1745	1 4 lb., 6 oz.
3860	Eighth leaf	1909-16		1 10	Gisarm	1746	1 3 lb., 9 oz.
STARTING CRANK							
3900	Starting crank only	1909-20		80	Hernia	519B	1 1 lb., 10 oz.
3901	Starting crank handle	1909-20		20	Heron	520	1 2 oz.
3902	Starting crank handle bolt	1909-20	1/2" x 4 5/8"	10	Herpes	521	1 4 oz.
3903	Starting crank sleeve	1909-20	1/2" bore x 1 1/2" x 2 3/4"	10	Hesper	523	1 4 oz.
3905	Starting crank ratchet pin	1909-20	1 3/8"	05	Hestern	4491	1 1 oz.
3906	Starting crank ratchet	1909-20		25	Hetman	528	1 8 oz.
3908	Starting crank spring	1909-20		05	Hilding	626	1 1 oz.
3909	Starting crank handle spring	1915-20		03	Hitter	5911	1 1 oz.
RADIATOR—THERMO-SYPHON							
3925	Radiator	1909-16		30 00	Hominy	1106C	1 1 oz.
3925B	Radiator	1917-20		28 00	Honey	8700	1 1 oz.
3925C	Radiator less shell	1917-20		25 75	Hop	8736	1 1 oz.
3926	Radiator cap	1909-20		20	Hoثير	8714	1 2 oz.
3928	Radiator pad	1909-20	Leather	05	Hovel	1105	2 1 oz.
3929	Radiator stud and nut	1909-19	3/8" x 2 7/16"	10	Hoxy	1162-1154	2 1 oz.
3929B	Radiator stud and nut	1919-20		10	Hunger	1162B-1154.2	2 1 oz.
3930	Radiator stud spring	1909-20	Order No. 2742				
3931 1/2	Radiator stud washernut	1909-20	3/8" x 2+ thds.	03	Huffish	1161	2 2 oz.
3932	Radiator rod	1909-20	20 3/4" long	20	Huller	1111B	1 8 oz.
3934	Radiator rod nut	1909-20	3/8" x 24 thds.	03	Humbler	517	1 1 oz.
3939	Outlet connection pipe	1909-20	1 3/4" x 12"	35	Humic	1121	1 12 oz.
3940	Outlet connection cock	1909-20	Order 3079				
3944	Outlet connection hose	1909-20	1 3/4" x 23 1/2"	15	Hungry	507	2 3 oz.
3945	Outlet connection hose clip	1909-20	2 1/8" dia.	05	Hunter	554	4 1 oz.
3947	Radiator shell	1917-19		2 25	Hymn	8737	1 1 oz.
3947B	Radiator shell	1919-20		2 25	Hymnal	8737B	1 1 oz.
3975	Radiator stud spring upper thimble	1919-20		02	Hump	1115	1 1 oz.
3976	Radiator stud spring lower thimble	1919-20		02	Hurst	1114	1 1 oz.
RADIATOR FAN							
3960	Fan and pulley assembly	1909-20		1 50	Hutten	619	1 1 lb., 8 oz.
3961	Fan blade	1909-20		10	Hyades	611	4 3 oz.
3961B	Fan blade rivets, per dozen	1909-20		05	Hyad	1566	16 1 oz.
3962	Driven fan pulley	1909-20	Brass, upper	80	Hydra	618	1 13 oz.
3963	Fan drive pulley	1909-20	Steel, lower	30	Hydrant	602	1 8 oz.
3964	Fan belt	1909-16		30	Hydrate	609	1 2 oz.
3964B	Fan belt	1917-20		30	Ibis	609B	1 1 oz.
3964C	Fan belt	1917-20	Gilmer branded	40	Impel	609B	1 1 oz.

Insist upon genuine Ford parts

Part No.	Name of Part	Year	Specifications	Price	Code Word	Fac.No. per Car	Req.	Mailing Weight
RADIATOR FAN—Continued								
3966	Fan shaft	1909-20	$\frac{1}{8}$ " x 4 $\frac{1}{8}$ "	\$ 0	Hyper	606	1	4 oz.
3967	Fan bracket	1909-16			Hypo	604	1	7 oz.
3967B	Fan bracket	1917-20			Idyl	604B	1	
3968	Fan bracket bolt	1909-20	$\frac{1}{8}$ " x 2 $\frac{3}{8}$ "		Hyperc	605	1	3 oz.
3970	Fan grease cup	1909-20			Hypphis	601	1	
3973	Fan adjusting screw and nut	1909-20	$\frac{3}{8}$ " x 1 $\frac{1}{2}$ "		Hyssop	645-517	1	1 oz.
3974	Fandriivenpulleybushing	1917-20			Knag	8757	1	
MUFFLER								
4025	Muffler assembly	1909-20		2	Jobal	1200	1	8 lb.
4026B	Muffler head—front	1917-20		45	Julep	1202C	1	
4027	Muffler shell—outer	1909-20	5" dia. x 12"	25	Jabin	1203	1	1 lb., 1 oz.
4028	Muffler shell—middle	1909-20	3 $\frac{1}{2}$ " dia. x 13"	25	Jackal	1204	1	12 oz.
4029	Muffler shell—inner	1909-20	2" dia. x 14"	15	Jaday	1205	1	1 lb., 3 oz.
4030	Muffler rod	1909-17	$\frac{5}{8}$ " x 13 $\frac{3}{8}$ "	10	Jadish	1206	3	4 oz.
4030B	Muffler rod	1917-20		10	Jocose	1206B	1	
4031	Muffler rod nut	1909-20	$\frac{5}{8}$ " x 24 thds. Order 3446					
4037B	Long exhaust pipe	1909-20		2	Jaunty	1214	1	1 lb., 12 oz.
4040B	Muffler head—rear	1917-20		45	Jesuit	1201D	1	
4041	Muffler head to frame bolt and nut	1917-20	Order 4808B					
HOOD								
4050	Hood	1909-16	22" long	7	Jlksam	1300	1	7 lb., 8 oz.
4050B	Hood	1917-20		7	Jilt	8726	1	
4051	Hood handle	1909-20	5 $\frac{1}{2}$ " long	05	Jingal	1314	2	2 oz.
4052	Hood clip	1909-16	3 $\frac{1}{4}$ "	10	Jippo	1310	4	2 oz.
4052B	Hood clip	1917-20		10	Jowl	8731	4	
4053	Hood clip spring	1909-16		03	Jockey	1311	4	
4053B	Hood clip spring	1917-20		03	Juice	8734	4	
4056	Hood board—left	1909-16	22 $\frac{3}{4}$ " long	25	Johim	1339	1	11 oz.
4056B	Hood block—left	1917-20		25	Kilt	8742	1	
4057	Hood board—right	1909-16	22 $\frac{3}{4}$ " long	25	Jorum	1340	1	11 oz.
4057B	Hood block—right	1917-20		25	Kine	8741	1	
4060B	Hood support on dash	1915-16		1	Juror	7464	1	
4060C	Hood pad (on dash)	1917-20		50	Kite	8711	2	
4060D	Hood pad (on radiator shell)	1917-20		26	Kid	8710	1	
4061B	Hood clasp (on dash)	1917-20		05	Kit	8720	1	
4061C	Hoodclasp(on dash)screw	1917-20		02	Knee	8763	2	
4073	Hood block support—front right	1917-20		05	Knot	8743	1	
4074	Hood block support—front left	1917-20		05	Kiln	8744	1	
4075	Hood block support—rear right	1917-20		05	King	8745	1	
4076	Hood block support—rear left	1917-20		05	Kirk	8746	1	
KINGSTON CARBURETOR								
6100	Carburetor complete	1909-20		6	Mason	553E	1	3 lb., 14 oz.
6101A	Carburetor float assb.	1917-20		1	Moslem	6369	1	
6101	Float with lever	1915-16		1	Marsh	6351	1	
6127A	Gasoline valve	1917-20		35	Moral	6377	1	
6115	Spray needle assembly	1910-20		50	Medal	3010	1	
Parts for 1909-16 Carburetors supplied by Bryne Kingston Co., Kokomo, Ind.								
HOLLEY CARBURETOR								
6040	Carburetor complete	1909-20		6	Mire	553D	1	3 lb., 3 oz.
4451A	Float with lever	1914-20		1	Muzzle	6333	1	
4452A	Spray needle assembly	1914-20		20	Myrtle	6335	1	
4453A	Gasoline inlet needle	1914-20		30	Mystic	6324	1	
(Other parts required may be ordered by plate numbers; prices quoted on application.)								
Parts for 1909-13 Carburetors supplied by Holley Kerosene Carburetor Co., Detroit, Mich.								
CARBURETOR ATTACHMENTS								
4127A	Carb. adjusting rod bracket	1909-20	On dash	05	Lastage	1357	1	
4129A	Carb. adjusting rod	1909-20		20	Latten	7920	1	4 oz.
4130	Carb. flange bolt and nut	1909-20		15	Leaper	1388-517	2	1 oz.
4134	Carb. flange gasket	1909-20		05	Lecturn	1380B	1	
4431	Carb. priming rod	1909-20		05	Loach	2000	1	1 oz.
4582	Carb. hot air pipe	1912-20		20	Monkey	686	1	6 oz.
4583	Priming bell crank	1919-20	Starter type (Old No. 4907)	30	Tenet	7691	1	
4584	Priming rod knob	1919-20	Starter type (Old No. 4919)	15	Tigris	8779	1	
4585	Priming rod plate	1919-20	Coupe starter type (Old No. 4926)	15	Thrum	7664	1	
4586	Priming rod plate	1919-20	Sedan starter type (Old No. 4927)	15	Thruse	7665	1	
4587	Priming rod	1919-20	Sedan starter type (Old No. 4928)	10	Thule	8795B	1	
4588	Priming rod	1919-20	Coupe starter type (Old No. 4929)	10	Thumb	8796	1	
4589	Carburetor priming rod	1919-20	Starter type (Old No. 4930)	05	Thunder	8797	1	

Insist upon genuine Ford parts

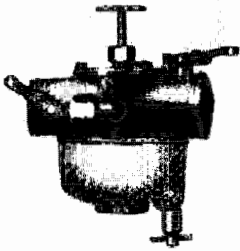

6040



4451A



6101A

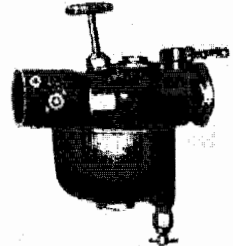

6100



6042



4452 A



6115



6101



6048



4453 A



6104



6124 A



6052



6126A



6041



6055



6126



6107A



6076



6125



6057



6061



6127



6127A



6070



6077



6102



6103A



4431



6046



4582



6106A

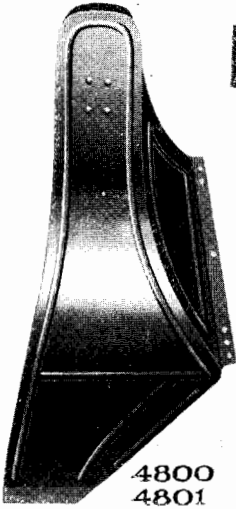

4800
4801

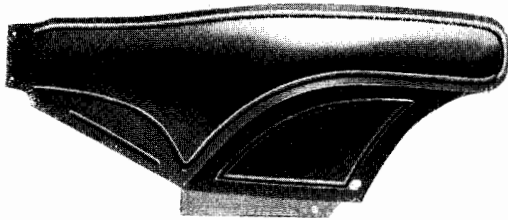

4800B
4801B

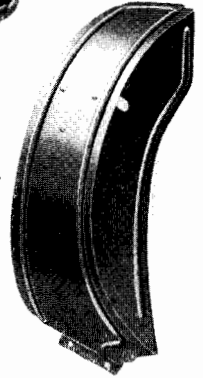

4802D
4803D

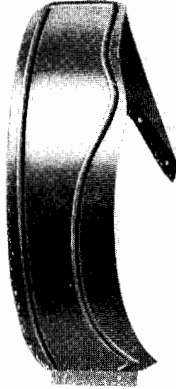

4802E
4803E



4804D



4806

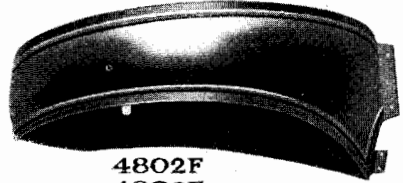

4802F
4803F



4812



4809

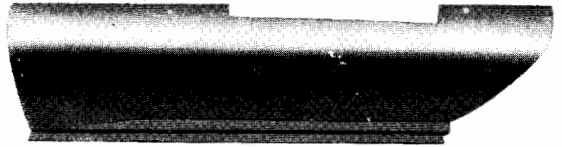

4814
4815



4816



4817

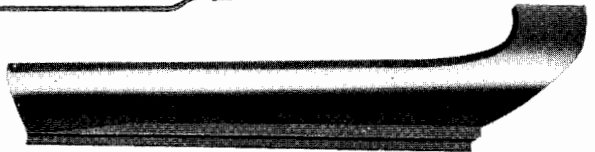

4814B
4815B

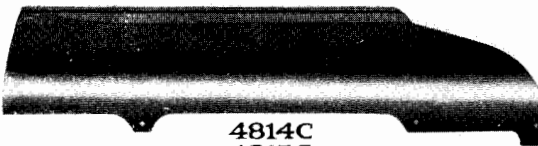

4814C
4815C



4818

Part No.	Name of Part	Year	Specifications	Price	Code Word	Fac.No.	Req. per Car	Mailing Weight
FENDERS—56 INCH TREAD								
4800B.	Front fender—right.	1917-20.	All Cars.	\$6 00	Nook	7976	1	
4801B.	Front fender—left.	1917-20.	All Cars.	6 00	Noose	7977	1	
4802F.	Rear fender—right.	1917-20.	All Cars.	5 00	Norse	8850	1	
4803F.	Rear fender—left.	1917-20.	All Cars.	5 00	Nougat	8851	1	
4804D.	Rear fender iron—right and left.	1913-20.	Touring car.	20	Smile	5405	2	12 oz.
4804E.	Rear fender iron—right.	1913-20.	Torpedo & Coupelet.	60	Shire	5563	1	1 lb., 7 oz.
4804F.	Rear fender iron—left.	1913-20.	Torpedo & Coupelet.	60	Shrub	5390	1	1 lb., 7 oz.
4804G.	Rear fender iron—right or left.	1916-17.	Sedan.	50	Nubble	8154A.	2	
4804K.	Fender iron—right or left.	1918-20.	Sedan.	50	Shoggle	8154B.	2	
4805B.	Rear fender iron bolt and nut.	1915-20.	Touring, $\frac{1}{8}$ " x $\frac{3}{4}$ ".	05	Signet	8161-341.	6	
4806.	Fender eye bolt, nut and washer.	1909-20.	Old No. 2935.	10	Blenny	1945	6	3 oz.
4808.	Front fender iron bolt and nut (side).	1910-20.	$\frac{3}{8}$ " x $\frac{11}{16}$ ".	05	Shovel	1323-8.	2	1 oz.
4808B.	Front fender iron bolt and nut (bottom).	1910-20.	$\frac{3}{8}$ " x $1\frac{1}{16}$ ".	05	Siren	347-8.	2	
4808C.	Front fender apron to frame bolt and nut.	1915-20.	$\frac{1}{4}$ " x $\frac{5}{8}$ ".	05	Sickle	4088-1309.	4	
4809.	Front fender iron—right or left.	1909-20.		90	Sistom	343	2	1 lb., 14 oz.

RUNNING BOARDS AND SHIELDS—56 INCH TREAD

4812.	Running board—right or left.	1909-20.	44 $\frac{7}{8}$ " long.	2 50	Shrew	5418	1	
4814C.	Running board shield—right.	1917-20.	All Cars.	3 00	Shrine	7986	1	
4815C.	Running board shield—left.	1917-20.	All Cars.	3 00	Shroud	7987	1	
4816.	Running board truss rod—front with nuts.	1909-20.		50	Skybird	5804	1	2 lb., 2 oz.
4817.	Running board truss rod—rear with nuts.	1909-20.		50	Skyman	5805	1	2 lb., 2 oz.
4817B.	Truss rod nut.			03		339	4	
4818.	Running board bracket.	1909-20.		1 00	Skyhawk	336	4	1 lb., 13 oz.
4819.	Run. board fender bolt and nut.	1909-20.	$\frac{1}{4}$ " x $1\frac{1}{8}$ ".	55	Boaster	1344B-1309.	8	
4819B.	Run. board bolt and nut.	1909-20.	$\frac{1}{8}$ " x $1\frac{1}{4}$ ".	05	Bolary	8448-341.	8	

FENDERS AND RUNNING BOARDS—60 INCH TREAD—BLUE

4820B.	Front fender—right.	1913-16.	Touring and Torpedo.	7 00	Table	2742	1	
4821B.	Front fender—left.	1913-16.	Touring and Torpedo.	7 00	Tabula	2743	1	
4822C.	Rear fender—right.	1915-16.	Tour., Torpedo, Coupelet.	6 00	Tartar	2758	1	
4823E.	Rear fender—left.	1915-16.	Tour., Torpedo, Coupelet.	6 00	Tavern	2759	1	
4824C.	Rear fender iron—right and left.	1915-16.	Touring Car.	40	Thatch	1723	2	
4825B.	Front fender iron—right and left.	1915-16.	Order No. 4809.					

1916 fenders obsolete—substitute with present type.

Insist upon genuine Ford parts

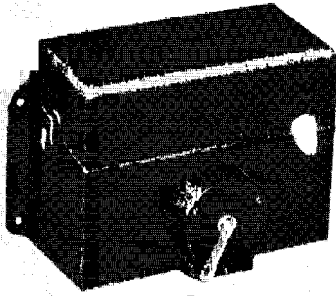

5000

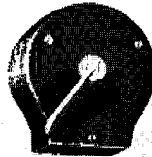

5010

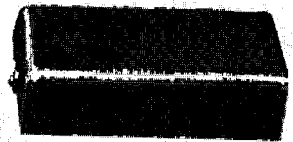

5004



5006



5008

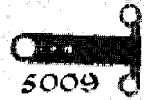

5009



5016



5007

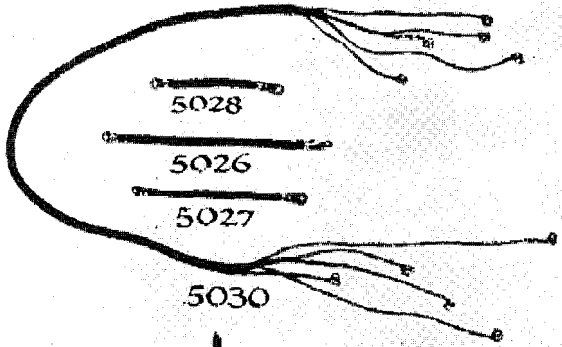

5028

5026

5027

5030

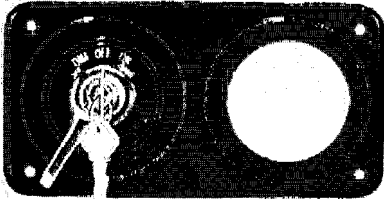

5012



5014



5015



5047



5050



5051



5040



5042

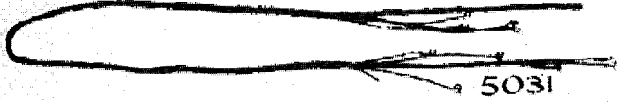

5031



5035

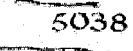

5038



5043



5037

5039



5041

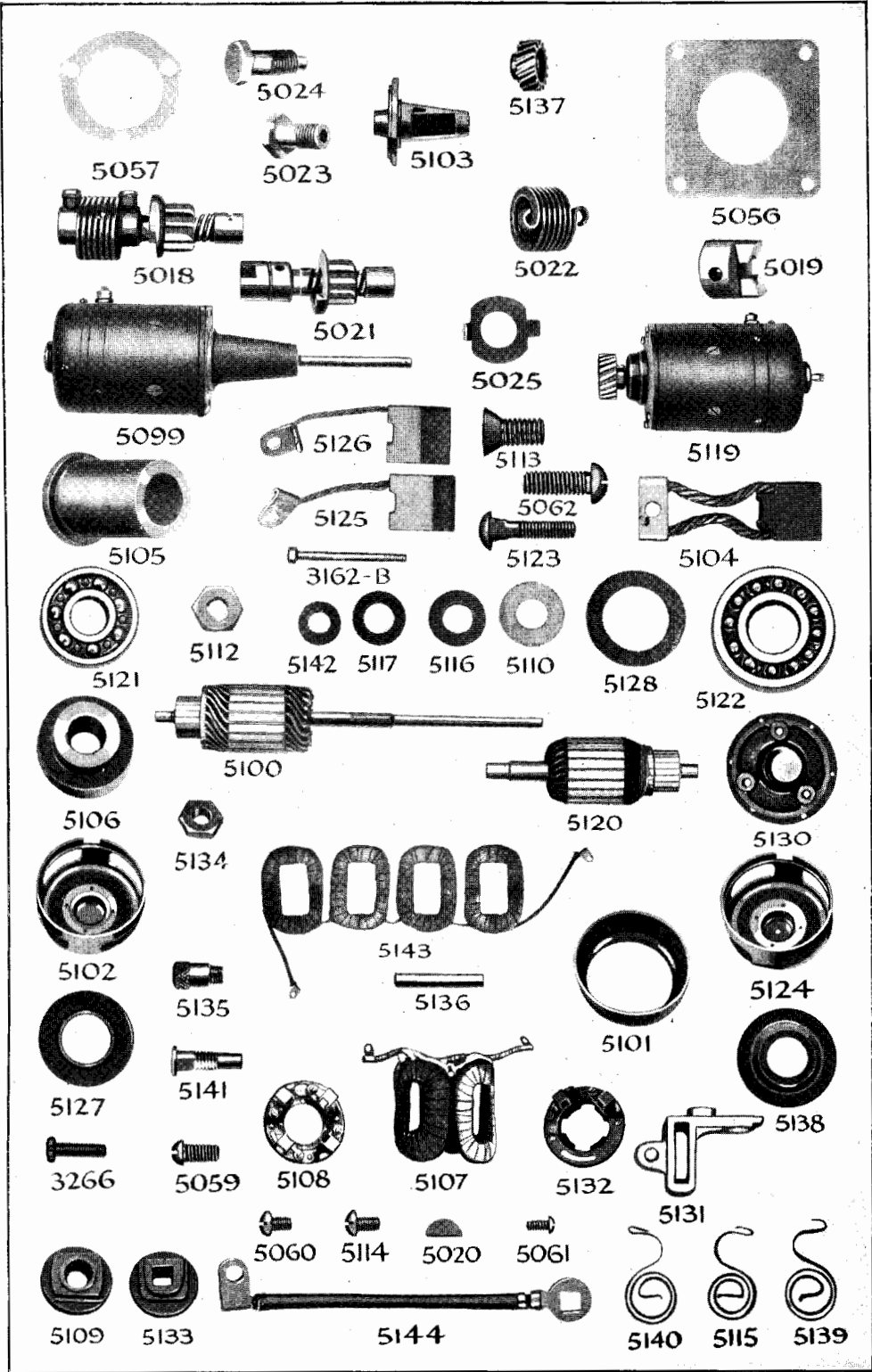

Part No.	Name of Part	Old No.	Price	Code Word	Fac. No.	Req. per Car	Mailing Weight
FORD SPARK COIL							
5000	Coil (includes switch)	4725	\$13 00	Negus	1383	1	
5001	Coil (starter type)—less switch	4725B	12 25	Neil			
5002	Coil box with cover (includes switch)	4726	3 00	Nenia	5858	1	
5003	Coil box with cover (starter type)—less switch	4726B	2 25	Nepeta			
5004	Coil box cover	4727B	30	Neptune	7910	1	
5005	Switch cover	4730	05	Nones	5835	1	
5005B	Switch cover		10	Nonage	5835B	1	
5006	Switch plug	4731	05	Nopal	5815	1	
5007	Coil unit, 3 $\frac{1}{8}$ " x 2 $\frac{3}{8}$ " x 5"	4732	2 50	Noggin	5845	4	
5008	Vibrator with tungsten point	4733	15	Nonce	6797	4	
5009	Vibrator bridge with tungsten point	4734	20	Novia	6702	4	
SWITCH							
5010	Switch assembly (on coil)	4728	75	Nidor	5873	1	
5012	Switch (ignition) (starter type on instru. brd.)	4936B	2 00	Tolad	7675E	1	
5013	Keys (switch)—give serial number	4918	15	Thrall	5815B	1	
5014	Starting switch (on floor board)	4937	1 00	Topaz	8792	1	
5015	Extension (starting switch plunger)	4910 $\frac{1}{2}$	10	Tetric	8793	1	
AMMETER							
5016	Ammeter	4900	2 25	Tassel	7680	1	
5017	Ammeter lens and rim		30	Tensor	8105	1	
BENDIX DRIVE							
5018	Bendix	4901	6 00	Tattler	1883	1	
5019	Head (Bendix)	4916	50	Thine	2007	1	
5020	Key (Bendix)	4917	02	Tholl	1751	1	
5021	Shaft and gear (Bendix)	4931	4 50	Thurl	2026	1	
5022	Spring (Bendix)	4932	75	Tinge	2006	1	
5023	Screw (Bendix shaft spring)	4933	10	Tinsel	1983	1	
5024	Screw (Bendix head spring)	4934	10	Tipple	1781	1	
5025	Washer (Bendix spring screw lock)	4938	05	Toper	1782	2	
WIRING							
5026	Spark plug wire 14 $\frac{1}{8}$ " No. 1 cyl.	4350	15	Nohob	1365	1	
5027	Spark plug wire (also magneto to coil) 10 $\frac{1}{2}$ " No. 2 cyl.	4351	15	Nachor	1366	1	
5028	Spark plug wire, 7" No. 3 and 4 cyls.	4353	10	Nalad	1376	2	
5029	Spark plug wire terminal	4354	03	Nailer	1381	8	
5030	COMMUTATOR WIRE (non starter type)	4355	1 00	Nandu	7502	1	
5031	Commutator wire (starter type)	4949	1 00	Trifle	7502B	1	
5032	Com. wire terminal (coil end)	4357	01	Napher	1385	4	
5033	Com. wire loom support	4359	03	Napple	1390	2	
5034	Wire (ammeter to cut-out) Sedan 33"	4939	15	Topic	7683	1	
5035	Wire (ammeter to cut-out) Sedan 49"	4939B	30	Topmast	7683B	1	
5036	Wire (ammeter to cut-out) Coupe 23"	4940	15	Torch	7684	1	
5037	Wire (ammeter to cut-out) Coupe 41"	4940B	20	Rabid	7684B	1	
5038	Wire (ammeter to ignition switch)	4941	10	Torpid	7681	1	
5039	Wire (generator to cut-out)	4946	15	Trash	7687	1	
5040	Wire (terminal block to switch)	4947	10	Trench	8894B	1	
5041	Wire (lighting)	4950	1 50	Tromp	7682B	1	
5042	Wire (switch) Sedan	4951	80	Troth	7685B	1	
5043	Wire (switch) Coupe	4952	70	Truce	7686B	1	
5044	Block (terminal)	4903	15	Teller	1950	1	
5045	Screw (terminal block to dash)	4935	01	Tocsin	2073	2	
5046	Cable (battery to switch) 28 $\frac{1}{2}$ "	4908	90	Tepor	1889B	1	
5047	Cable (battery to switch) 34"	4908B	1 00	Pantry	1889C	1	
5048	Cable (ground) 20"	4909	70	Terse	1890	1	
5049	Cable (ground) 9 $\frac{1}{16}$ "	4909B	50	Testa	1890B	1	
5050	Cable (ground) 11 $\frac{1}{2}$ "	4909C	50	Parish	1890C	1	
5051	Cable (switch to motor)	4910	75	Tether	1891	1	
5052	Bolt and nut (battery cable terminal)	4904	15	Temple	1937-1938	2	
CUT-OUTS							
5054	Cut-out (electric) (dash type)	4905	1 50	Tenant	7677	1	
5055	Cut-out (electric)	4905B	1 75	Tendril	7677B	1	
STARTER PARTS							
5056	Gasket (motor mounting)	4914	02	Theme	1768		
5057	Gasket (gen. head)	4913	02	Thane	1774		
5058	Screw (gen. mounting, short)		03	Thrack	1755		
5059	Screw (Bendix cover)		01	Thrave	1765		
5060	Screw (term. block to wire)	doz.	05	Thwack	2015		
5061	Screw (ammeter to plate)		01	Thwart	2062		
5062	Screw (motor mounting)		03	Thymet	1760		

Insist upon genuine Ford parts

Part No.	Name of Part	Year	Old No.	Price	Code Word	Fac. No.	No. Req. per Car	Mailing Weight
STARTING MOTOR AND PARTS								
5099	Motor (starting)	1919-20	4920	\$22 00	Tidbit	1877		
5100	Armature	1919-20		9 00	Tabid	1940		
*5101	Band (cover)	1919-20		25	Tallage	1801		
5102	Bracket (brush end)	1919-20		90	Talmen	1868		
5103	Bracket assem. (mounting)	1919-20	4902½	2 50	Tawny	2037		
5104	Brush	1919-20		50	Tavvat	1806		
5105	Bushing (shaft, rear)	1919-20		40	Tapnet	1759		
5106	Bushing (shaft, front)	1919-20		20	Tapster	1789		
5108	Holder assem. (brush)	1919-20		70	Talpa	1864B		
5109	Insulator (terminal, outer)	1919-20		10	Talus	1795		
*5110	Insulator (terminal, inner)	1919-20		02	Tambac	1794		
5112	Nut (terminal)	1919-20		03	Tambour	1791		
*5113	Screw (field)	1919-20		02	Tumis	1788		
*5114	Screw (brush end bracket to yoke)	1919-20		doz.	Tamkin	1808		
5115	Spring (brush tension)	1919-20		05	Tampon	1809		
5116	Washer (terminal)	1919-20		02	Tarras	1792		
5117	Washer (terminal, inner, steel)	1919-20		02	Tarsic	1798		
5118	Yoke (motor) assembly	1919-20		7 00	Tartly	1852		
GENERATOR AND PARTS								
5119	Generator	1919-20	4911	22 00	Tetter	1879		
5120	Armature (less bearings)	1919-20		9 25	Tanling	1925		
5121	Bearing (small)	1919-20		1 50	Tannic	1838		
5122	Bearing (large)	1919-20		1 75	Tantrum	1841		
5123	Bolt (terminal)	1919-20		03	Tegnet	1836		
5124	Bracket (brush end)	1919-20		1 10	Telary	1894		
5125	Brush (large)	1919-20		25	Tempean	1844		
5126	Brush (small)	1919-20		20	Tempter	1845		
5127	Disc (large bearing)	1919-20		03	Tendry	1847		
5128	Felt (small bearing)	1919-20		03	Tenter	2033		
5130	Head	1919-20		1 10	Tercel	2044		
5131	Holder (small brush)	1919-20		20	Termor	1821		
5132	Holder assem. (brush)	1919-20		60	Ternate	1865B		
5133	Insulator (terminal, outer)	1919-20		10	Terras	1827		
5134	Nut (terminal)	1919-20	4921	03	Tiling	1818		
5135	Oiler	1919-20		10	Testern	1837		
5136	Pin (pinion to shaft)	1919-20		05	Throng	1750		
5137	Pinion	1919-20	4925	80	Throng	1752		
5138	Retainer (small bearing felt)	1919-20		02	Theban	1832		
5139	Spring (large brush)	1919-20		05	Theist	1967		
5140	Spring (small brush)	1919-20		05	Themis	1988		
5141	Stud (small brush holder)	1919-20		05	Theon	1823B		
5142	Washer (terminal)	1919-20		02	Thermal	1831		
5144	Wire (brush to terminal)	1919-20		08	Thorp	1851		
5145	Yoke (generator) assembly	1919-20		6 50	Thorite	1887		
BATTERY BRACKET AND PARTS								
5150	Bracket assem.	1919-20	4902	1 25	Tattoo	8841		
5151	Bolt and nut (clamp)	1919-20		10	Tetra	8846-29		
5152	Clamp	1919-20		10	Tetrad	8844		

*Also for generator.

Insist upon genuine Ford parts

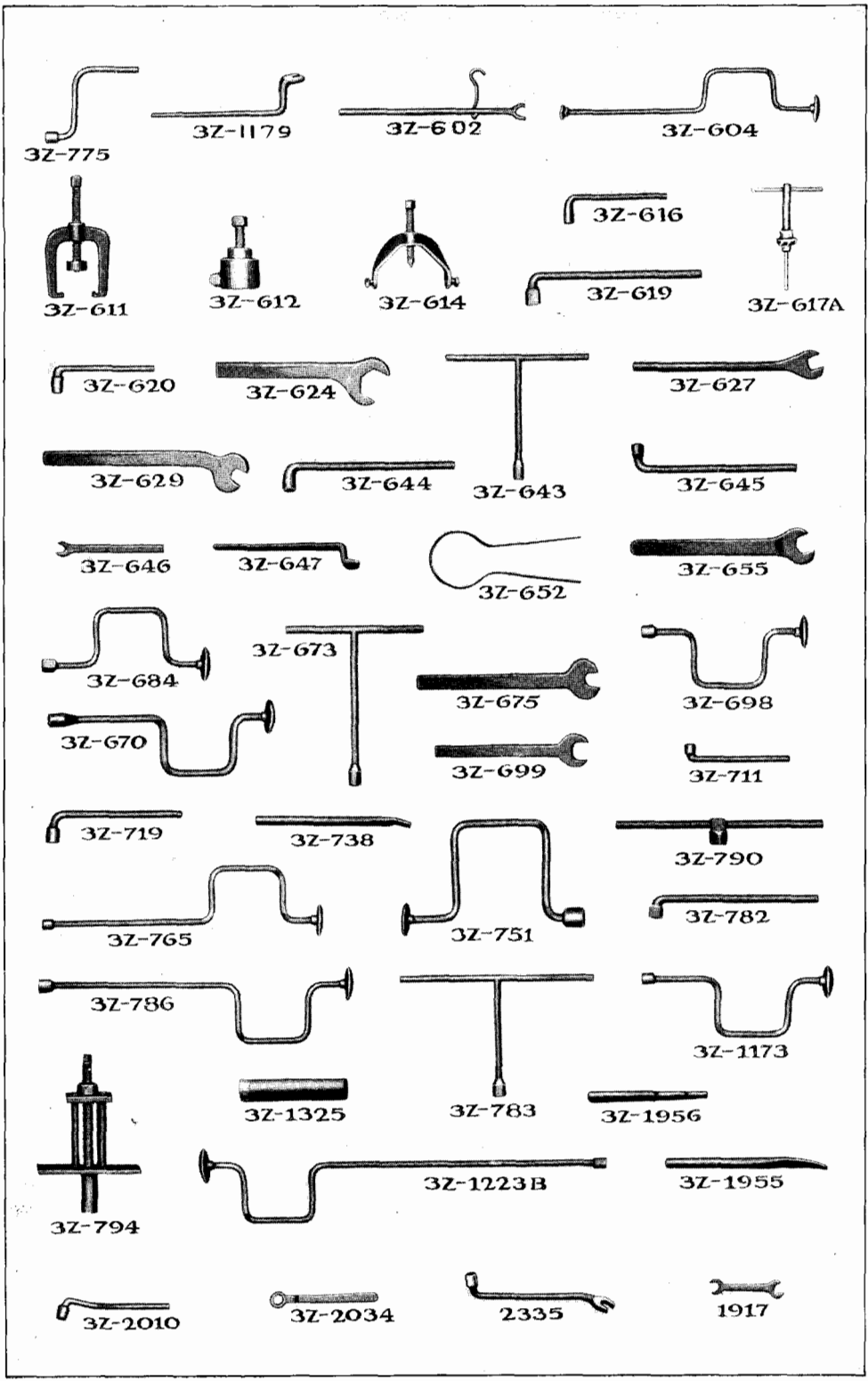

Plate No. 14

Part No.	Name of Part	Year	Specifications	Price	Code Word	Fac.No. Req. No. per Car	Mailing Weight
REPAIR TOOLS							
1349	Hub cap wrench		Regular equipment	\$0 20	Pacal	1349	
1387	Adjustable wrench		Regular equipment	50	Pacos	1387	
1902	Screw driver		Regular equipment	35	Padan	1902	
1903	Pliers		Regular equipment	35	Paddy	1903	
1917	Double end wrench		Regular equipment	25	Pagan	1917	
2335	Spark plug and cyl. head bolt wrench		Regular equipment	50	Pavid	5893	
2336	Tool roll		Regular equipment	30	Pawky	1979	
2337	Oil can		Regular equipment	25	Paxos	1384	
2338	Tire pump		Regular equipment	1 50	Paysar	1368	
2340	Tire irons, each		Regular equipment	15	Pelage	4069	
2343	Jack		Regular equipment	1 50	Poser	389	1
3Z-775	3/8" socket wrench		8 1/2" long	60	Pallah		
3Z-1179	Fly wheel cap screw wrench		13 1/2" long	1 25	Palmy		
3Z-4730	Valve spring lifter		15" long	50	Palpus		
3Z-703	Tire iron (large)			60	Pathos		
3Z-604	Valve grinder			1 00	Palster		
3Z-612	Rear wheel puller assembly			1 50	Panary		
3Z-611	Cam gear puller			2 25	Pantile		
3Z-614	Transmission clutch puller			1 25	Papaw		
3Z-620	Drive shaft housing stud nut wrench for 1 1/8" nut			50	Papaw		
3Z-616	Rear axle housing bolt nut wrench		7 3/4" long	50	Parvis		
3Z-617-1	Valve seat reamer		7 1/2" long	2 75	Papula		
3Z-617-2	Valve seat reamer cutter			1 85	Papur		
3Z-643	3/8" T socket wrench		9 1/4" long	75	Parfit		
3Z-644	Socket wrench for crank shaft bearing bolt nut		12 1/2" long	70	Passim		
3Z-645	3/4" L socket wrench		12" long	60	Pastel		
3Z-646	3/8" open end wrench		7 1/2" long	30	Pastor		
3Z-647	Connecting rod clamp screw wrench		10 1/2" long	75	Parrot		
3Z-1223B	3/8" brace socket wrench		24 3/8" long	1 00	Parsee		
3Z-652	Piston ring squeezer		3 7/8" dia.	30	Patile		
3Z-655	Large cam gear lock nut wrench		14" long	70	Pavan		
3Z-619	Crank shaft bearing bolt wrench		Oval head	60	Pelox		
3Z-782	Crank shaft bearing bolt wrench		Square head	50	Poloy		
3Z-2034	Trans. band ratchet wrench			60	Poplin		
3Z-675	Rear axle nut open end wrench			1 00	Porite		
3Z-624	Exhaust pack nut open end wrench			1 25	Potash		
3Z-627	Rear axle entering wrench			75	Potion		
3Z-673	Body bracket connecting bolt T wrench, front and center			1 00	Prater		
3Z-686	Body bracket connecting bolt holding open end wrench			40	Preen		
3Z-698	{ Brake shoe support bolt brace wrench D/S bearing housing screw brace wrench }			80	Prince		
3Z-699	Spindle cone adjusting open end wrench			50	Profile		
3Z-719	Body bracket connecting bolt R. & L. wrench			65	Proverb		
3Z-738	Riveting bar for starting crank ratchet pin			60	Prude		
3Z-751	Rear axle nut and housing plug brace wrench			1 25	Pulpit		
3Z-1173	Front radius rod ball cap screw brace wrench			1 00	Pumice		
3Z-786	Cylinder head cap screw brace wrench			1 00	Pusil		
3Z-790	Drive shaft pinion T wrench			1 00	Puzzle		
3Z-783	Connecting rod T wrench			90	Pygmy		
3Z-1955	Front wheel ball race drift			50	Quince		
3Z-1956	Spindle arm bushing driver			90	Quinsy		
3Z-2010	Connecting rod cap bolt nut L wrench (Cylinder No. 4)			50	Quack		
3Z-2304	Connecting rod cap bolt nut brace wrench with universal joint for No. 4 connecting rod			2 50	Quadra		

COTTER PINS

	Fac. No.		Fac. No.
3/32" x 1" cotter pins	421	3/32" x 1 1/2" cotter pins	66
3/32" x 3/4" cotter pins	753	1/16" x 1 1/2" cotter pins	544
1/2" x 1" cotter pins	82	3/32" x 5/8" cotter pins	88
Price, per dozen			\$0 05
Price, per gross			25

NUTS

3/8"—24 thds. 03
 This size nut used on following parts: 2514, 2722, 2729B, 3073, 3074, 3362, 3437, 3443, 2514B, 2741, 3010, 4041, 4808, 4808B.

Insist upon genuine Ford parts

Price List of Accessories and Accessory Parts

Part No.	Name of Part	Make	Year	Code	Price
ELECTRIC HORN					
6432X	Electric horn complete			Ulcer	\$ 2 50
7915X	Electric horn terminal wire 9"			Uma	05
7917X	Electric horn to switch wire 35 $\frac{1}{8}$ "			Ultra	15
ELECTRIC HEAD LAMPS (STANDARD 1915-20)					
6511X	Head lamp assembly—8 $\frac{1}{2}$ " lens, per pair			Umpire	7 50
6511BX	Head lamp assembly—per pair (Dimmer type)		1919-20	Unport.	8 00
6594X	Head lamp door assembly			Union	1 00
6589X	Head lamp switch assembly—with screws			Ural	35
8650X	Head lamp and horn switch assembly			Urith	40
8892X	Dimmer resistance coil with wires			Urbox	70
6572X	Head lamp Mazda bulb—8-9 volt used with magneto			Urban	50
6572CX	Head lamp Mazda bulb (6-8 volt single contact used with storage battery)		1919-20	Urcan	50
6520X	Dimmer bulb (for head and tail lamp) 6-8 volt 2 cp. single contact		1919-20	Vamos	28
6578X	Head lamp door lens gasket			Urchin	05
6576X	Head lamp door lens—8 $\frac{1}{2}$ "			Urn	25
6592X	Head lamp plug—with thimble			Urus	20
6585X	Head lamp reflector			Urva	1 20
6585BX	Head lamp reflector (dimmer type)		1919-20	Urbo	1 20
6577X	Head lamp door lens retainer			Usher	05
6580X	Head lamp focusing screw			Utas	05
6591X	Head lamp focusing screw spring			Ute	03
6574X	Head lamp bulb socket			Vagrant	20
6586X	Head lamp reflector spring			Vail	10
7487X	Switch to terminal wire—11 $\frac{3}{4}$ " long			Vallse	05
7489X	Lamp to lamp wire—40" long			Vallum	15
7490X	Lamp to ground wire—10 $\frac{3}{4}$ " long			Vamp	05
SIDE OIL AND TAIL LAMPS—1915-19					
6561X	Side oil lamp, per pair			Van	2 50
6568X	Tail lamp			Vandal	1 75
7669X	Electric tail lamp assembly		1919-20	Vanquish	1 25
6484BX	Electric tail lamp red lens		1919-20	Vales	15
6599X	Side oil and tail lamp fount			Vane	50
6956X	Side oil lamp door			Vanish	50
6957X	Tail lamp door			Vapid	50
6966X	Tail lamp white lens and frame			Vapor	20
6460X	Lamp burner including wick			Varix	30
6958X	Lamp chimney case			Varus	30
6472X	Lamp chimney			Vase	30
6959X	Lamp chimney cover			Vassal	25
6485X	Side oil lamp door lens			Vat	15
6484X	Tail lamp door red lens			Vault	15
6393X	Side oil lamp to bracket bolt nut			Veal	03
6486X	Lamp door hinge pin			Veer	05
6392X	Lamp wick			Vega	05
TOURING CAR AND TORPEDO WINDSHIELDS—1915-20					
*7840X	Windshield assembly, less brackets, bolts, nuts and washers			Vender	18 00
7818BX	Windshield hinge assembly—Right		1917-20	Vent	45
7819BX	Windshield hinge assembly—Left		1917-20	Verb	45
7820AX	Windshield upper frame assembly		1915-16	Verge	1 50
7820BX	Windshield frame assembly—upper		1917-20	Vermiln	1 50
7822AX	Windshield upper half assembly		1915-16	Verse	7 50
7822BX	Windshield upper half assembly		1917-20	Verst	7 50
7823X	Windshield lower half assembly		1915-20	Vertex	8 75
7802X	Windshield lower frame only		1915-20	Venge	1 20
7803X	Windshield lower frame filler block		1915-20	Verve	20
7839X	Windshield frame filler block			Vervet	15
7888X	Windshield block (frame filler)—upper		1917	Vesper	15
7810X	Windshield hinge bolt			Vespid	05
7845X	Windshield bracket—right		1915-19	Vestal	75
7845B	Windshield bracket—right		1919-20	Vestad	75
7846X	Windshield bracket—left		1915-19	Vestro	75
7846B	Windshield bracket—left		1919-20	Vexil	75
7824X	Windshield glass clamp			Veto	05
7801X	Windshield frame—upper		1915-16	Vial	90
7887X	Windshield frame—upper		1917-20	Vicar	90
7890X	Windshield hinge—lower left		1917-20	View	15
7805X	Windshield left hand upper hinge			Viking	15
7889X	Windshield hinge—lower right		1917-20	Vim	20
7807X	Windshield right hand upper hinge			Vina	15
3827X	Windshield top snap loop			Vine	05
1154X	Windshield hinge bolt nuts			Vintage	05
2449BX	Windshield glass clamp screw			Viol	01
2257BX	Windshield hinge to frame screw (Order 3367)				05
6013X	Windshield hinge spring			Virgin	03
7851X	Windshield upper glass stop—nickel		1915-20	Vise	35
7852X	Windshield lower glass stop—nickel		1915-20	Vitals	35
7808X	Windshield hinge thimble			Vitex	05
TOURING CAR TOPS—1915-20					
7940X	Touring car top complete		1915-20	Warm	
6882X	Touring car storm curtain (R. H.)		1915-20	Warp	2 75

*Order 7845X-7846X extra for 1915-16 cars.

Insist upon genuine Ford parts

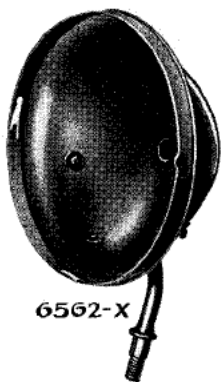

6562-X

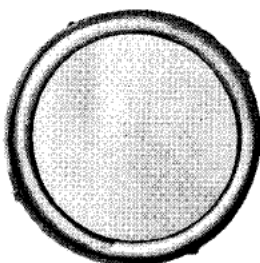

6594-X



6511-X



6585-X

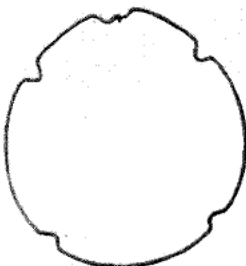

6586-X



6576-X



7490-X

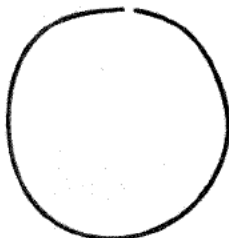

6578-X



7487-A-X



8650-X



7489-X



6572-X



8894-X



6592-X



8892-X



6574-X

Part No.	Name of Part	Make	Year	Code	Price
TOURING CAR TOPS—1915-20—Continued					
6883X	Touring car storm curtain (L. H.)		1915-20	Warren	\$2 75
4966BX	Touring car side curtain (R. H.)		1915-20	Wart	3 50
4967BX	Touring car side curtain (L. H.)		1915-20	Wash	3 50
6894X	Touring car center deck complete		1915-20	Wasp	8 50
6886X	Touring car center deck only 91½" x 50"		1915-20	Waste	5 00
6895X	Touring car side quarter (R. H.)		1915-20	Watch	2 00
6896X	Touring car side quarter (L. H.)		1915-20	Water	2 00
6815X	Touring car side quarter pad		1915-20	Watt	1 50
6940X	Touring car back stay and curtain assembly		1915-20	Wax	3 50
6866X	Touring car wood bow (1st)		1915-17	Weak	1 50
3897X	Touring car wood bow (2nd and 3rd)		1913-17	Weapon	1 50
4957X	Touring car wood bow—rear		1914-17	Web	1 50
8973X	Touring car front and rear extension rib		1918-20	Yawn	30
8974X	Touring car front and rear upright rib		1918-20	Yell	25
4596X	Touring car bow separator—male		1913-17	Wedge	05
4597X	Touring car bow separator—female		1913-17	Weed	05
6832X	Touring car bow separator		1918-20	Whelp	05
6860AX	Touring car front extension bow socket (R. H.)		1915-17	Weep	1 25
6860BX	Touring car front extension bow socket (R. H.)		1918-20	Wealth	1 25
6861AX	Touring car front extension bow socket (L. H.)		1915-17	Weir	1 25
6861BX	Touring car front extension bow socket (L. H.)		1918-20	Weary	1 25
3884AX	Touring car rear extension bow socket (R. H.)		1913-17	Weld	1 25
3884BX	Touring car rear extension bow socket (R. H.)		1918-20	Wedding	1 25
3885AX	Touring car rear extension bow socket (L. H.)		1913-17	Welkin	1 25
3885BX	Touring car rear extension bow socket (L. H.)		1918-20	Welt	1 25
6862AX	Touring car front upright bow socket (R. H.)		1915-17	Well	1 25
6862BX	Touring car front upright bow socket (R. H.)		1918-20	Whig	1 25
6863AX	Touring car front upright bow socket (L. H.)		1915-17	Welsh	1 25
6863BX	Touring car front upright bow socket (L. H.)		1918-20	Whilk	1 25
3882AX	Touring car rear upright bow socket (R. H.)		1913-17	West	1 25
3882BX	Touring car rear upright bow socket (R. H.)		1918-20	Yauk	1 25
3883AX	Touring car rear upright bow socket (L. H.)		1913-17	Wether	1 25
3883BX	Touring car rear upright bow socket (L. H.)		1918-20	Yawl	1 25
7831X	Curtain to windshield hook		1915-20	Whame	03
7832X	Curtain to body hook		1915-20	Whaul	03
6837X	Touring car key strap assembly		1913-18	Whale	05
8992X	Rib socket cotter		1918-20	Wheeze	05
3924X	Touring car top to windshield strap assembly		1915-20	Wharf	30
3629X	Touring car rear stay strap assembly complete		1913-20	Wheat	55
3631X	Touring car rear stay strap—short—lower		1913-20	Whiff	25
3632X	Touring car rear stay strap—long—upper		1913-20	Whim	30
6925X	Touring car curtain to windshield strap assembly		1915-19	Whine	10
6926X	Touring car curtain to lamp bracket strap assembly		1915 19	Whip	10
3754X	Touring car curtain glove fastener assembly		1913-20	Whist	05
6829AX	Touring car duquesne clip—upper		1914-17	Whoop	10
6829BX	Touring car extension support—upper		1918-20	Yellk	10
6830AX	Touring car duquesne clip—lower		1914-17	Wick	10
6830BX	Touring car extension support—lower		1918-20	Yeoman	05
3316X	Touring car top brass fastener—single		1913-16	Widow	05
3549X	Touring car top brass fastener—double		1913-16	Wife	05
8937X	Touring car top snap fastener—single		1917-20	Wig	05
8938X	Touring car top snap fastener—double		1917-20	Willow	06
3314X	Touring car top prop rest with strap		1913-20	Wind	60
3858X	Touring car top prop rest arm		1913-20	Wine	25
3624X	Touring car bow socket to seat iron japanned nut		1913-20	Wing	05
3383X	Curtain celluloid 20" x 36"—.015 thick		1913-20	Wink	2 00
3383X	Curtain celluloid 10" x 18"—.015 thick		1913-20	Winter	50
6881X	Touring car top dust hood		1915-20	Wire	3 50
4981X	Touring car top visor		1920	Wizen	75

TORPEDO TOP PARTS—1915-20

*7941X	Torpedo top complete		1915-20	Wisdom	
4971X	Torpedo top—second and third wood bows		1914-18	Wish	50
6929X	Torpedo top—first bow		1915-18	Wisp	50
6870X	Torpedo top bow socket—upright—(R. H.)		1915-18	Witch	1 25
6871X	Torpedo top bow socket—upright—(L. H.)		1915-18	Withe	1 25
6873X	Torpedo top bow socket—front extension—(L. H.)		1915-18	Witness	1 00
6872	Torpedo top bow socket—front extension—(R. H.)		1915-18	Wizard	1 00
4907X	Torpedo top bow socket—rear extension—(R. H.)		1913-18	Wolf	1 00
4908X	Torpedo top bow socket—rear extension—(L. H.)		1913-18	Woman	1 00
6937X	Torpedo top side curtain—rear—(R. H.)		1915-20	Wood	2 00
6938X	Torpedo top side curtain—rear—(L. H.)		1915-20	Word	2 00
6935X	Torpedo top side curtain—front—(R. H.)		1915-20	Work	2 50
6936X	Torpedo top side curtain—front—(L. H.)		1915-20	World	2 50
6950X	Torpedo top back curtain assembly		1915-20	Worm	3 00
6965X	Torpedo top center deck complete		1915-20	Worry	6 00
6964X	Torpedo top deck only		1915-20	Wrap	2 80
6962X	Torpedo top side quarter—(R. H.)		1915-20	Wreck	1 25
6963X	Torpedo top side quarter—(L. H.)		1915-20	Wren	1 25
6806X	Torpedo top side quarter pad		1914-20	Wrist	1 00
6939X	Torpedo top hood		1915-20	Yak	3 30
3877X	Torpedo top prop rest with strap		1913-20	Yam	60
4955X	Torpedo top visor		1920	Yamper	75

*Inquire of Branch or Dealer for price.

Insist upon genuine Ford parts

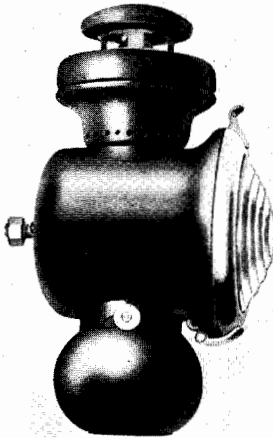

6561

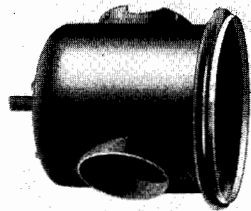

6456

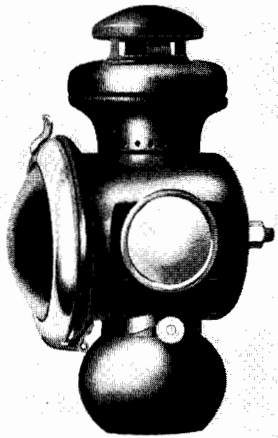

6568

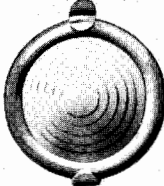

6956

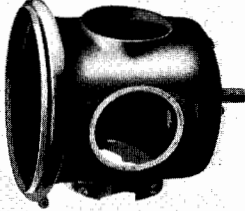

6458

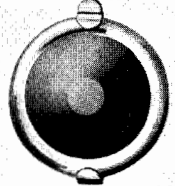

6957



6472

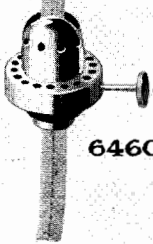

6460



6478



6966

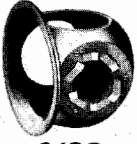

6490



7922



6499



6492



6958



1154



6486



6599

Price List of Parts for Model T One Ton Truck

Part No.	Name of Part	Year	Price	Code Word	Model	Fac. No.	Qty. per Car
REAR AXLE							
1000	Rear axle assembly	1918-20	\$200 00	Abed	TT	95	1
1001	Axle housing—right	1918-20	25 00	Abys	TT	4	1
1002	Axle housing—left	1918-20	25 00	Acme	TT	5	1
1003	Axle housing bolt and nut	1918-20	10	Acorn	TT	52-T220	13
1004	Axle housing cap	1918-20	50	Actor	TT	133	1
1005	Axle housing cap gasket	1918-20	02	Acute	TT	134	1
1006	Axle housing cap screw	1918-20	10	Adder	TT	72	4
1007	Axle housing cap screw lock wire	1918-20	02	Addle	TT	140	1
1008	Axle housing gasket—upper	1918-20	02	Agate	TT	138	1
1009	Axle housing gasket—lower	1918-20	06	Agast	TT	139	1
1010	Axle brake housing plate—right	1918-20	50	Agile	TT	147	1
1011	Axle brake housing plate—left	1918-20	50	Akin	TT	148	1
1012	Axle housing drain plug	1918-20	05	Alacr	TT	136	2
1013	Axle shaft and nut	1918-20	7 15	Alex	TT	48	2
1014	Axle shaft cotter	1918-20	01	Alms	TT	165	2
1015	Axle shaft nut	1918-20	15	Aloe	TT	166	2
1016	Axle shaft washer	1918-20	05	Aloft	TT	135	2
1017	Axle shaft dust cap	1918-20	05	Alpha	TT	56	2
1018	Axle shaft inner ball bearing assembly	1918-20	6 50	Alpine	TT	125	2
1019	Axle shaft outer roller bearing	1918-20	2 00	Archer	TT	171	2
1020	Axle shaft outer roller bearing sleeve	1918-20	60	Arena	TT	170	2
1021	Axle shaft bearing felt	1918-20	15	Argue	TT	143	4
1022	Axle shaft bearing retainer	1918-20	15	Ark	TT	20	2
1023	Axle shaft bearing retainer washer	1918-20	05	Arson	TT	23	2
1024	Axle shaft felt retainer assembly	1918-20	20	Astral	TT	144	2
1025	Axle shaft felt retainer cup	1918-20	05	Atwist	TT	145	2
1026	Axle shaft felt retainer plate	1918-20	03	Atoll	TT	146	2
1027	Diff. gear	1918-20	3 00	Aura	TT	13	2
1028	Diff. gear case R. or L. half	1918-20	3 05	Author	TT	11	2
1029	Diff. gear case bolt	1918-20	05	Avail	TT	52	8
1030	Order T2719						
1031	Diff. gear lock ring	1918-20	05	Avoke	TT	118	2
1032	Diff. pinion	1918-20	1 00	Awake	TT	14	2
1033	Diff. pinion shaft	1918-20	4 40	Awry	TT	15	1
1034	Drive shaft	1918-20	10 00	Bait	TT	87	1
1036	D. S. tube assembly	1918-20	15 00	Balm	TT	153	1
1037	D. S. tube flange gasket	1918-20	02	Bandit	TT	194	1
1038	D. S. tube flange screw	Order 1006					
1039	D. S. felt	1918-20	10	Basil	TT	109	1
1040	D. S. felt container	1918-20	05	Beaver	TT	110	1
1041A	D. S. to worm coupling	1918-19	1 50	Behind	TT	85	1
1041B	D. S. to worm coupling	1920	1 50	Behind	TT	85B	1
1042	D. S. to worm coupling pin	1918-20	03	Behold	TT	86	2
1043	Worm	1918-20	18 00	Berg	TT	16	1
1044	Worm gear	1918-20	20 00	Bible	TT	12	1
1045	Worm cotter	Order 1014					
1046	Worm roller bearing	1918-20	1 50	Bight	TT	108	2
1047	Worm roller bearing retainer	1918-20	10	Bigot	TT	106	1
1048	Worm roller bearing sleeve	1918-20	2 00	Bilge	TT	107	2
1049	Worm roller bearing housing screw	1918-20	10	Birch	TT	101	2
1050	Worm thrust bearing collar	1918-20	1 50	Bird	TT	114	2
1051	Worm thrust ball and separator assembly	1918-20	1 50	Bitter	TT	123	1
1052	Worm thrust bearing plate	1918-20	15	Blaze	TT	22	1
1053	Worm thrust bearing retainer	1918-20	60	Bleach	TT	111	1
1054	Worm thrust bearing retainer nut	Order 1015					
1055	Worm thrust bearing retainer pin	1918-20	03	Blend	TT	112	1
1056	Brake shoe	1918-20	2 50	Blind	TT	2814	2
1057	Brake shoe lining, each	1918-20	40	Blink	TT	58	4
1058	Brake shoe lining rivet	1918-20	03	Blue	TT	68	40
1059	Brake shoe spring	1918-20	10	Blunt	TT	67	2
1060	Brake shoe bolt and nut	1918-20	30	Blush	TT	59-T242	2
1061	Brake expander	1918-20	80	Bodkin	TT	61	2
1062	Brake expander lever	1918-20	20	Booth	TT	62	2
1064	Brake expander adjustment collar	1918-20	30	Brig	TT	175	2
1065	Brake expander bushing	1918-20	15	Bronze	TT	173	2
1066	Brake expander pin	1918-20	03	Brook	TT	7	2
1067	Brake expander link	1918-20	05	Broom	TT	176	4
1068	Brake expander link pin	1918-20	05	Brow	TT	177	8
1069	Brake rod	1918-20	50	Brush	TT	119	2
1070	Brake rod support—right	1918-20	10	Buck	TT	120	1
1071	Brake rod support—left	1918-20	10	Bug	TT	121	1
1072	Brake rod support bolt and nut	1918-20	05	Buoy	TT	1308-T1309	2
1073	Rear radius rod	1918-20	6 00	Burn	TT	152	2
1074	Rear radius rod bolt and nut—front	1918-20	40	Crab	TT	84-T242	1
1075	Rear radius rod bolt and nut—rear	1918-20	30	Crag	TT	83-T242	4
1076	Universal joint bushing	1918-20	75	Crape	TT	69	1
SPRING							
1077	Rear spring—right or left, each	1918-20	6 00	Cream	TT	333	2
1078	Spring leaf No. 1	1918-20	1 20	Creed	TT	361	2
1079	Spring leaf No. 2	1918-20	90	Crew	TT	362	2
1080	Spring leaf No. 3	1918-20	75	Crib	TT	363	2
1081	Spring leaf No. 4	1918-20	70	Crisp	TT	364	2
1082	Spring leaf No. 5	1918-20	65	Croak	TT	365	2
1083	Spring leaf No. 6	1918-20	55	Croup	TT	366	2
1084	Spring leaf No. 7	1918-20	50	Croup	TT	367	2
1085	Spring leaf No. 8	1918-20	40	Crow	TT	368	2
1086	Spring leaf No. 9	1918-20	35	Crowd	TT	331	2

Insist upon genuine Ford parts

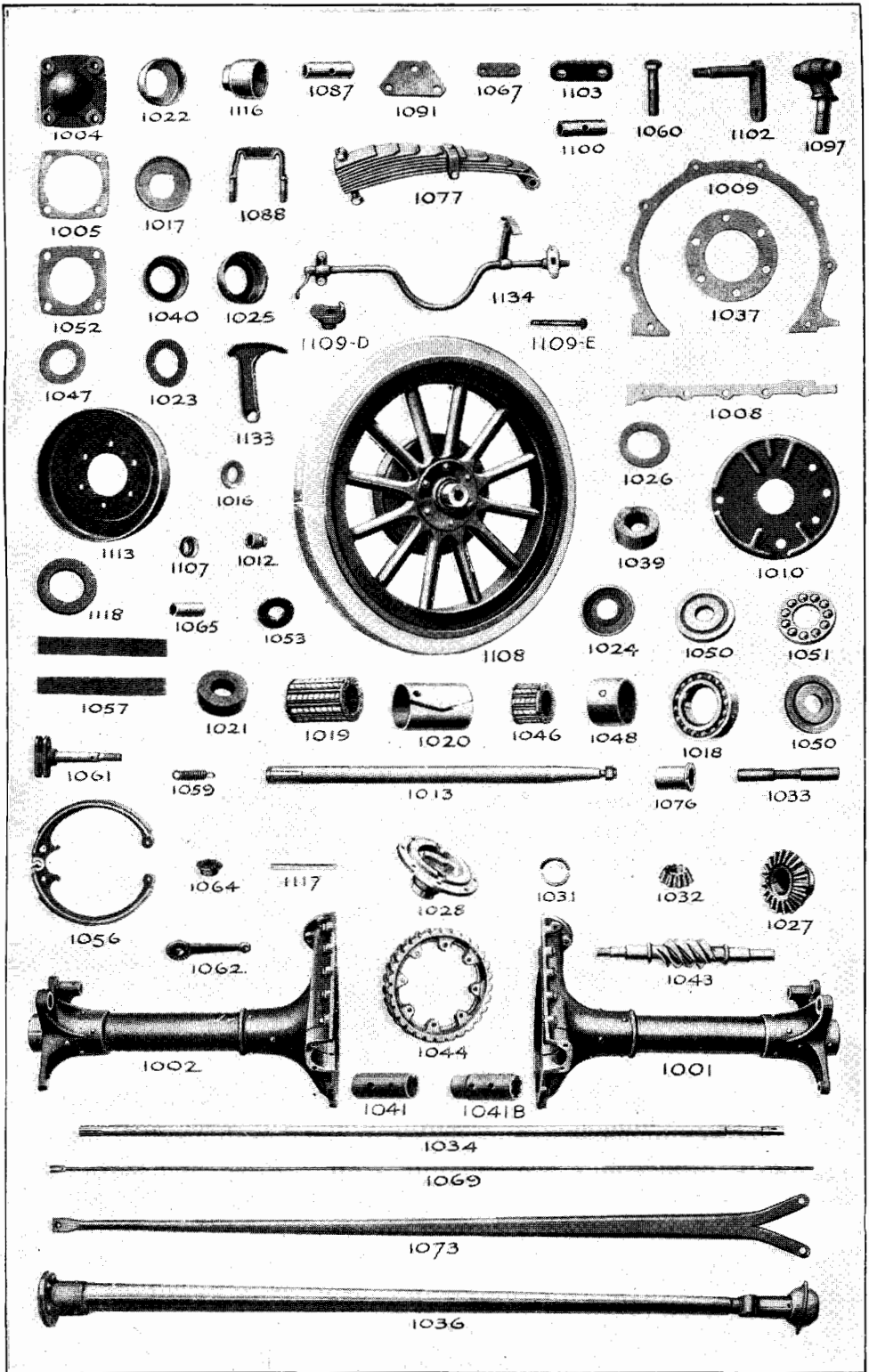

Plate No. 17

Part No.	Name of Part	Year	Price	Code Word	Model	Fac. No.	Req. per Car
SPRING—Continued							
1087	Spring bushing	1918-20	\$ 0 20	Crumb	TT	332	2
1088	Spring clip	1918-20	60	Crusher	TT	326	2
1089	Spring clip nut	1918-20	15	Cry	TT	327	4
1091	Spring clip plate	1918-20	25	Cuff	TT	329	2
1092	Spring tie bolt	1918-20	35	Cult	TT	330	2
1093	Spring tie bolt nut	Order 1089					
1094	Spring tie bolt cotter	1918-20	01	Cure	TT	328	2
1095	Spring clamp	1918-20	10	Curl	TT	375	2
1096	Spring clamp bolt and nut	1918-20	05	Curse	TT	376-1926	2
1097	Spring perch	1918-20	1 20	Dale	TT	2804	2
1098	Spring perch nut	Order 1015					
1099	Spring perch cotter	Order 1014					
1100	Spring perch bushing	1918-20	30	Demon	TT	172	2
1101	Spring perch bushing spacer	1918-20	05	Dean	TT	169	4
1102	Spring hanger assembly	1918-20	45	Dike	TT	91	4
STEERING GEAR							
1105	Steering gear bracket	1918-20	1 00	Dream	TT	996	1
1106	Steering gear bracket block	1918-20	05	Drift	TT	945	1
1107	Steering gear bracket dust cap	1918-20	05	Drum	TT	5044	1
WHEELS							
1109	Rear wheel complete, less tire	1918-19	18 00	Duel	TT	99	2
1109B	Rear wheel complete (less tire) Demountable		25 00	Duellist	TT	7698	
1109C	Demountable rim only		5 50	Duke	TT	8774B	
1109D	Clamp and nut assembly		20	Duledge	TT	8829	
1109E	Clamp bolt		10	Dullish	TT	8832	
1110	Rear wheel complete, with tire	1918-19		Drone		7645	
1111	Rear hub	1918-20	4 50	Dumb	TT	40	2
1112	Rear hub flange	1918-20	60	Dusk	TT	149	2
1113	Rear hub brake drum	1918-20	2 00	Dutch	TT	3	2
1114	Rear hub bolt and nut	1918-20	10	Dwarf	TT	28-29	12
1116	Rear hub cap	1918-20	35	Dyke	TT	150	2
1117	Rear hub key	1918-20	10	Ear	TT	26	2
1118	Rear hub felt	1918-20	10	East	TT	162	2
FRAME							
1119	Frame assembly	1918-20	35 00	Eat	TT	300	1
1120	Side member—right	1918-20	12 00	Ebb	TT	301	1
1121	Side member—left	1918-20	12 00	Fish	TT	302	1
1122	Front cross member	1918-20	1 50	Flirt	TT	303	1
1123	Rear cross member	1918-20	6 00	Flock	TT	304	1
1124	Front corner bracket—right	1918-20	20	Frost	TT	305	1
1125	Front corner bracket—left	1918-20	20	Froth	TT	306	1
1125B	Front end spacer—right	1918-20	15	Fruitage	TT	319	1
1125C	Front end spacer—left	1918-20	15	Fruitful	TT	318	1
1126	Rear cross member gusset plate	1918-20	25	Ghost	TT	307	2
MOTOR							
1127	Crank case arm block	1918-20	05	Grape	TT	890	2
1128	Hood board to frame bolt and nut—long	1918-20	05	Guest	TT	4073-T1309	2
RUNNING BOARD							
1129	Running board	1918-20	75	Gull	TT	5418	2
1130	Board bracket	1918-20	40	Heck	TT	2926	4
1131	Board bracket brace	1918-20	15	Hedge	TT	2927	2
1132	Board bracket rear brace	1918-20	30	Hedging	TT	2929	1
TRANSMISSION CONTROL							
1133	Speed lever	1918-20	20	Hoe	TT	862	1
1134	Controller shaft with speed lever	1918-20	75	Hod	TT	1557	1
TOOLS							
3Z2257	Rear wheel puller assembly	1918-20	1 50	Hock	TT		1
3Z711	Rear axle housing bolt L socket wrench	1918-20	50	Prosy	TT		
3389X	Jack		3 00	Ho	TT		

Insist upon genuine Ford parts