

FORD OWNER *and* DEALER

NOT CONNECTED WITH THE
FORD MOTOR COMPANY

Hasslers Are as Universal as the Ford.

Everywhere motorists demand Hasslers for the greater comfort they give; for the greater speed they make possible on rough roads; for the savings in repair and tire expense. Hasslers cushion the bump; check upthrow; stop sidesway. They keep cars tight and prevent rattles. Test them for 10 days at our risk. Ask your dealer.

Robert H. Hassler, Inc.

INDIANAPOLIS, U. S. A.

Robert H. Hassler, Ltd., Hamilton, Ont.

TRADE MARK REGISTERED
Shock Absorbers
PATENTED

December 1921
15 Cents



The Ford in Switzerland



DEALERS:—If you haven't one of these attractive, 5-color steel display stands for your counter, write us for one. It will sell many Milwaukee Timers for you.



More Power to Buck Mud and Snow

WINTER'S slush, mud and snow give Fords the real power-test. Hard going and chilly weather call for a *hotter spark* than summer driving—

hotter spark to fire the wet mixture in cold cylinders, so your Ford will start more easily;

hotter spark to get full power from every explosion, so your Ford will pull more steadily;

hotter spark to save gas, save battery, and keep down carbon.

To get that hotter spark, you need a new timer, and the best you can get—the **MILWAUKEE!**

In a Milwaukee Timer, the hardened steel roller is as wear-proof as the finest ball bearing. The fibre raceway, with its anchored steel terminals, is satin-smooth and flawless, even after the Ford has run thousands of miles.

RETAIL PRICE

Now Only \$2.00

(\$1.00 Less Than Pre-War Price)

Today, one of every three Fords has a Milwaukee Timer. If yours has not, ask your auto supply dealer for one. It costs but \$2.00 (west of Rocky Mts. \$2.10). Nothing else you can buy will do so much to make your Ford a better running, trouble-free car.

**Milwaukee Motor
Products, Inc.**

(Formerly Milwaukee Auto Engine & Supply Co.)
MILWAUKEE, WISCONSIN

MILWAUKEE TIMER *for* FORDS

When writing advertisers—Just say FORD OWNER AND DEALER

Chattering and Shake are not the fault of the Ford

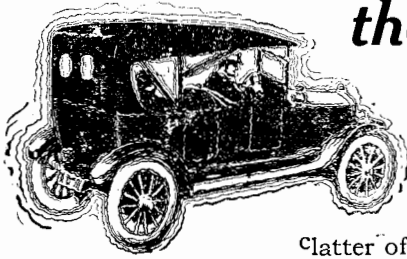

It's due entirely to the brake lining. Ordinary linings get hard, flinty, stick—haven't any grip. Instead of taking hold and stopping the car smoothly, they grab and slip repeatedly causing the car to stop in a clatter of vibration and noise.

Read This Booklet—Story of Cork Insert

Tells how ADVANCE CORK INSERT stops the shivering and shaking when you work the brake. Grips instantly, smoothly. No shivering or chattering. Never gets hard and slick.



WHY SHAKE YOUR FORD TO PIECES WITH HARD, SLICK BRAKE LINING? If it's new, put in Advance Cork Insert and keep it new. If it's a used car, Advance Cork Insert will make it work surprisingly smooth—free from rattle and vibration. Saves repairs to rear end and transmission.

BE SURE YOU GET GENUINE ADVANCE CORK INSERT. Your garage, repair or accessory man has it or can get it; every wholesale house carries the genuine in stock or can get it. It's perfected through years of service.

REMEMBER: Cork Insert will save you relining expense—one set will outlast three sets of ordinary lining.

Advance Automobile Accessories Corp.

Dept. 100, 1721 Prairie Ave., Chicago.

Publishers of "Let's Go."

DEALERS:—Order From Your Jobber or Write Us Direct

\$3.50 per
set of three.



Good as New After
10,000 Miles

Millvale, Pa.
Advance Auto Accessories Corp.,
Chicago.

Have used Advance Cork Insert
Transmission Linings and have had
them in my Ford for 10,000 miles
and they're good as new.

EDWARD P. SCHAFER.

A Boon to Ford Service Men

A HIGH GRADE MAGNETO METER

At a LOW Price at Last



THE STERLING No. 700 MAGNETO METER is intended for just one purpose. Any mechanic can use it. No danger of putting it out of commission. Connections made with patented one hand double contact device. Tests simple. No experience necessary. Results accurate and automatically indicated.

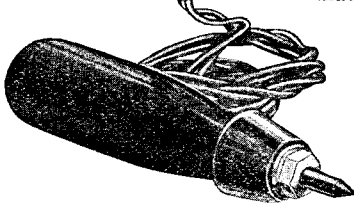

Write for Bulletin 19-4. JUST WHAT YOU HAVE BEEN LOOKING FOR

PRICE \$8.50

BATTERY SERVICE MEN

Get Big Returns From a Very Small Investment When They Use This "Weak Cell" Detector.

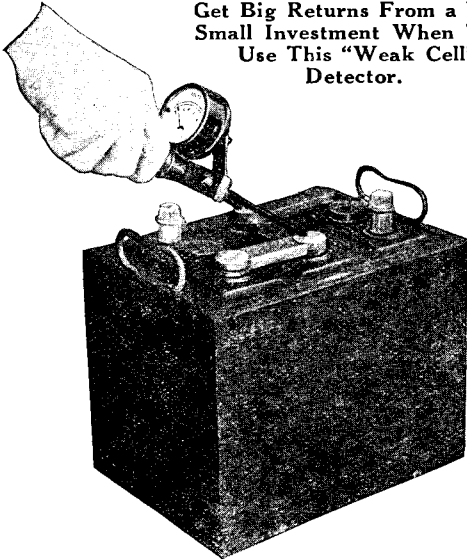

The Sterling No. 600 High Rate Discharge Cell Tester is a real storage battery "trouble shooter." Five minutes instruction will enable any mechanic to get the full benefit of its use.

It provides an accurate, reliable means of testing the performance of a storage battery under discharge, without removing the battery from the car. It instantly locates defective cells which are in need of attention. Write for Bulletin 10-4.

Price \$8.00

Insist on having the STERLING. If your jobber does not handle it, send your order direct to us stating the name of your jobber.

Manufactured by

THE STERLING MANUFACTURING CO.
2851 Prospect Avenue CLEVELAND, OHIO
Largest Producers of Dash Ammeters in the World



Entered as second-class matter, January 29, 1915, at the Post Office at Milwaukee, Wisconsin, under the Act of March 3, 1879.

Contents Copyright 1921

Vol. 16 DECEMBER 1921 No. 3

The FORD OWNER AND DEALER is an independent monthly journal having no connection with the Ford Motor Company. We are trying to serve the best interests of the dealers and owners of Ford Cars and propose to "hew in the line, let the chips fall where they may."

15 cents a copy, \$1.50 a year in U. S., Canada and Mexico. Foreign Countries, \$2.00.

Published Monthly by

THE TRADE PRESS PUBLISHING CO.

Montgomery Building
MILWAUKEE, WISCONSIN.

H. A. Apple, Publisher and Editor
Frederick L. Goulston, Advertising Manager
Paul C. Treviranus, Business Manager
Harry J. Larkin, Managing Editor
Murray Fahnenstock, Technical Editor
J. D. Campbell, Art Editor

BRANCH OFFICES

NEW YORK OFFICE—

CLAIBORNE M. GARRETT,
The Commerce Chambers
48 East 41st St.

CHICAGO OFFICE—

E. J. KEYES,
743 Webster Bldg.
Van Buren and La Salle Sts.

DETROIT OFFICE—

ROY BUELL,
516 Leightner Bldg.,
242 La Fayette Blvd., W.

ST. LOUIS OFFICE—

M. M. SHURMAN,
713 Star Bldg.

WESTERN REPRESENTATIVE—

C. M. MINIER,
510 Title Insurance Bldg.
Los Angeles, Cal.

513 Pacific Bldg.
San Francisco, Cal.

405 Walker Bldg.
Seattle, Wash.

To save delay send all general and subscription communications to the main office at Milwaukee, Wis.

IN THIS ISSUE—

Winter Car Comfort.....	46
Accessories for Easy Starting.....	54
Tractor Department.....	64
Hints	73
Questions	74
Ford News Notes.....	76
Equipment Review.....	80

When writing advertisers—Just say FORD OWNER AND DEALER

Mr. Seller of Fords

AND YOU MR. OWNER TOO—

**Everyone Said
It Couldn't Be Done
and Only a Fool Would Try**

Partridge, Singer & Baldwin Engineers knew it could be done and spent months to prove that the fool was right—they went ahead and did it—

And now you can offer your customers, new and old,—

An Auxiliary Transmission of the Selective Type The Warford “A Six-Speeder”

that combines, in one unit, under-drive for power and over-drive for speed—which is installed directly back of the regular Ford transmission.

It permits “gearing down” with heavy loads, on hills, or in mud,—and “gearing up” when running light, or on the level.

It's so good that you can make an added profit on every car or truck you sell, without added selling expense—

Partridge, Singer & Baldwin
Incorporated
Dept. FO, 44 Whitehall St., NEW YORK

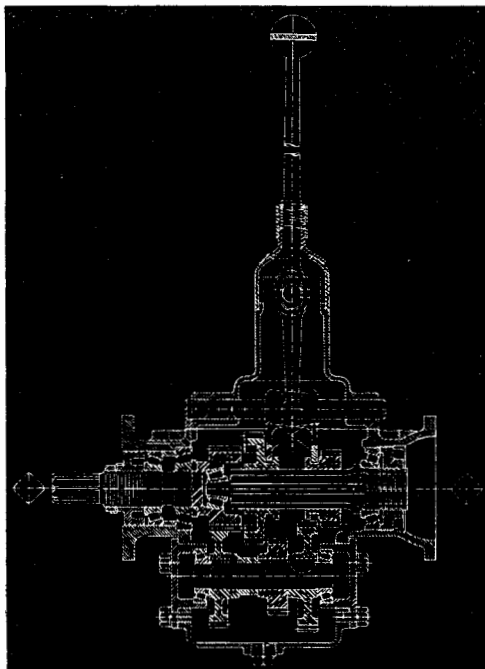

Study this drawing—used because it tells more than a picture—and then



**THE WARFORD
AUXILIARY
TRANSMISSION**
6 Speeds Forward
3 Speeds Reverse
Selective Type
Timken Adjustable
Bearings
3½% Nickel Steel
Gears
Easy to Apply
Will Not Leak Oil
Quiet

Send me your Dealer Proposition covering the Warford Auxiliary Transmission.
Name of Co. _____
Individual Address _____
Partridge, Singer & Baldwin, Inc.
Dept. F. O., 44 Whitehall St., N. Y.

KEYSTONE SIX ADJUSTABLE,
(Patent Applied For)
PILOT PISTON PIN REAMERS
(Critchley Pattern)

The front and rear Pilots produce perfect alignment. Only twelve sizes required for all Piston Pins in cars, trucks and tractors now being made.

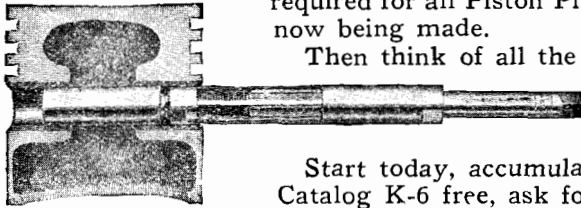

Then think of all the other reaming jobs they will take care of.

Start today, accumulating a Set of these Reamers. Catalog K-6 free, ask for it.

KEYSTONE
REAMER & TOOL CO.
Western Sales Division
180 N. Market St. Chicago
Eastern Sales Division
30 Warren St. New York

BRANCHES

Atlanta
Detroit
St. Louis
Denver
Los Angeles
San Francisco
Portland

Factory: MILLERSBURG, PA.

STARTS THE FORD MOTOR INSTANTLY
Regardless of Temperature

A FEW DROPS OF GASOLINE OR ALCOHOL DO THE WORK
CAN BE USED 100 TIMES AT A COST OF ONE CENT

HOT SPOT GENERATOR

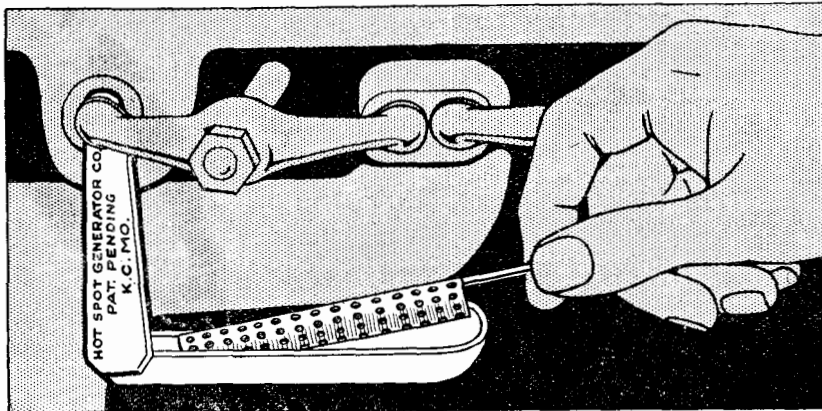

Installed in a minute. Can never wear out. Attached by simply loosening and tightening nut on second manifold clamp. Out of the way and there to stay until you get a new Ford.

Cost
Complete
\$1.00

Postpaid
AGENTS:
Write today for territory for this big seller. Your money back if not satisfied.

HOT SPOT GENERATOR COMPANY
422 Cambridge Ave. Kansas City, Mo.

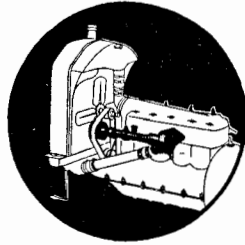

YOUR INSURANCE Against A FROZEN RADIATOR

In real cold weather a FORD radiator is liable to freeze before you have traveled the first mile because with a thermo-siphon water system, the water will not circulate until it is heated to 180 degrees.

The Cataract Pump overcomes this by insuring proper water circulation immediately—with the first few turns of the motor—prevents your anti-freeze solution from evaporating and safeguards your cooling system. *Cataract your Ford* and make winter driving a pleasure instead of a constant fear—Fear of a frozen radiator—laying up the car—and a large repair bill.

Cataract pumps are an all year round necessity on every Ford. In summer driving, Ford cars equipped with the Cataract Pump never overheat.

Cataract Pumps are sold on a money back guarantee. That is why Distributors, Dealers and Ford owners are absolutely secure in buying CATARACTS.

Do Not Wait Until Your Ford Freezes Up

If your dealer is not carrying CATARACT PUMPS in stock pin your check or money order for \$12.00 to the coupon below and mail it to us today. Cataracts are easily installed. You will save many times the purchase price this winter.

CATARACT MFG. CO.

264 FIFTH STREET

MILWAUKEE, WIS.

Dealers, write today for the Cataract proposition. Good territory still to be had.

CATARACT MANUFACTURING COMPANY,
264 Fifth St., Milwaukee, Wis.

Enclosed find.....for \$.....(price per pump \$12.00)
for which send me one Cataract Pump to the address below. My Ford is
.....Model. (Give Year Model so we we can supply right size belt.)

Name

Address

Bright Spots for the Owner of an **ENSIGN** Equipt Ford

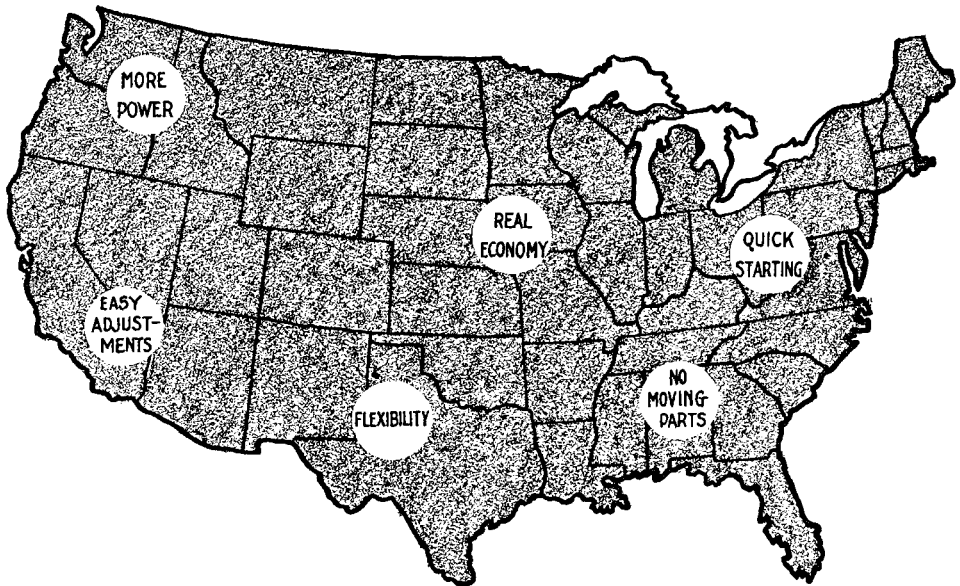

Prove these statements to your own satisfaction. If there is not an **Ensign** Dealer in your territory—we will ship a Type “U” **Ensign** Carburetor with heating equipment, etc., complete, for **\$15.00**. Use it 10 days and if you don’t acknowledge it money well spent say so, and we will refund cheerfully.

ENSIGN CARBURETOR CO
Makers of Carburetors for All Internal Combustion Engines

NEW YORK - - 532 West 58th Street
LOS ANGELES - - 217 East 17th Street
CHICAGO - - 2900 South Michigan Ave.

ATWATER KENT

IGNITION COIL

MORE POWER

GREATER SPEED

FUEL ECONOMY

WATER PROOF

FOOL PROOF

EASILY INSTALLED



Universal Coil with
End Mounting and Condenser

which can be readily installed

On over 200 Different Makes of Cars

using only one of three simple adapters
Small assortment, minimum investment
Rapid turnover, maximum profit

List price, Universal (Type N) Coil 6 or 12 volt—end or side mounting, \$9.00
Condenser for Universal Coil, \$3.00; Adapters, 25 cents

ATWATER KENT MFG. COMPANY

4937 STENTON AVENUE, PHILADELPHIA

On Sale by Foremost Jobbers and Select Dealers

When writing advertisers—Just say FORD OWNER AND DEALER

WIRE WHEEL equipment adds many times its cost to the appearance of any FORD

EACH spoke in a House Wire Wheel is tested to withstand a strain of 3200 pounds, and there are 54 of these spokes arranged in TRIPLE rows to carry the load. Hence, House Wire Wheels are STRONG.

Due to the arrangement of the spokes in TRIPLE ROWS a House Wire Wheel will withstand strains that would demolish ordinary wheels. Hence, Wire Wheels are SAFE.

The quick-detachable feature of House Wire Wheels robs tire trouble of its terrors. Neither rim nor tire is removed. You merely unscrew one nut and replace the entire wheel instantly. Hence, Wire Wheels are CONVENIENT.

Therefore, Wire Wheel equipment is a GOOD INVESTMENT—an investment that pays dividends in convenience, in time saved and in the protection against mishaps that it provides.

TO DEALERS:

We are offering a unique plan by which Ford Dealers can add to their profits by selling Fords equipped with House Wire Wheels. Dealers who are interested should get in touch direct with our Factory Branches.

WIRE WHEEL CORPORATION of AMERICA

(Successors to Houk Manufacturing Co.)

1700 ELMWOOD AVENUE BUFFALO, N. Y.

Direct Factory Branches and Service Stations:

New York, 835 11th Ave., at 57th St.

San Francisco, 1690 Pine St.

Philadelphia, 328 N. Broad St.

Chicago, 2900 S. Michigan Ave.,

Los Angeles, 1216 S. Grand Ave.

Detroit, 433 Leland St.

Canadian Factory:

Ajax Wire Wheel Ltd., 64 Niagara St., St. Catherine, Ont.

HOUSE

QUICK CHANGE

WIRE WHEELS

are furnished for Fords with either plain, clincher, or straight side rim.

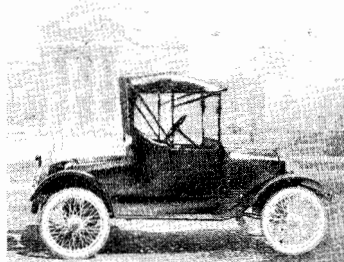

Ford Roadster, equipped with House Wire Wheels

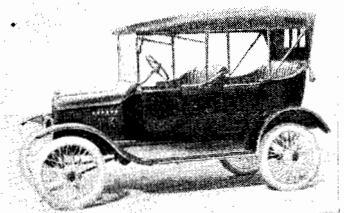

Ford Touring Car, equipped with House Wire Wheels

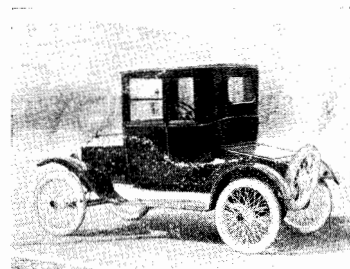

Ford Coupe, equipped with House Wire Wheels

A set of House Wire Wheels consists of five wheels, four inner hubs, four hub caps, hub cap wrench and spoke nipple wrench.

WIRE WHEELS

Five wheels, triple spoke, detachable at hub

Monarch Draft-Break

FOR FORDS

These Illustrations Tell the Whole Story

See how the feet and legs are protected from cold air, dust, mud and grease (lower illustration). A real necessity if you would drive in comfort.

Made of pressed steel, black enamel finished. Strong and rigid—slides smoothly.

**EASILY INSTALLED
REQUIRES NO ATTENTION**

85c at your dealer's—or if he cannot supply you, will be mailed anywhere in U. S. for \$1.00 (which includes postage and war tax). Pin dollar bill to coupon below.



Why You Need a Monarch Draft-Break

DEALERS not now supplied will find it highly profitable to order a stock to retail at 85c. Quick seller—Every Ford Owner wants one.

TWO TYPES

STANDARD TYPE for
Coupes and open cars.
SEDAN TYPE for Sedan.



Completely Closes That Big Slot in the Floor of Your Ford

MONARCH METAL PRODUCTS CO.
5020 Penrose St., ST. LOUIS, U. S. A.
Also Manufacturers of the Lane Auto Visor

Monarch
Metal Products
Company
5020 Penrose St.,
St. Louis, U. S. A.

Gentlemen:
For attached dollar bill
(enclose Money Order if you
prefer) send me one Monarch
Draft-Break of type as checked.
 Standard Sedan

Name
Post Office.....State.....
R F DBox.....Street.....

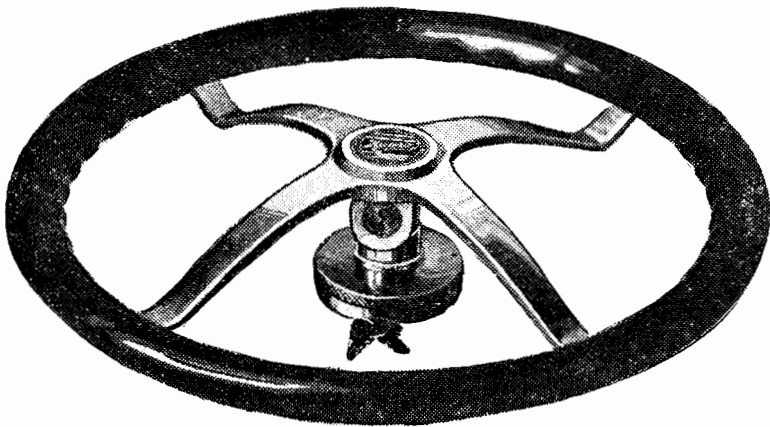

*The Demand Has Increased
Each Month For The
Hugro Steering Wheel
Locks—For Fords*



"THIS PROTECTS YOU"

The Hugro Lock for Fords
Will Give You 100% Service

- IT IS EASY TO INSTALL
- POSITIVE IN OPERATION
- STRONG AND DURABLE
- NEAT IN DESIGN
- THEFT PROOF

SOLD BY FORD
DEALERS EVERY-
WHERE



WRITE FOR DE-
SCRIPTIVE LITERA-
TURE and DISCOUNTS

GENERAL OFFICES AND FACTORY
WARSAW, IND.



No more edging to the side of the road to let larger more expensive cars pass by—

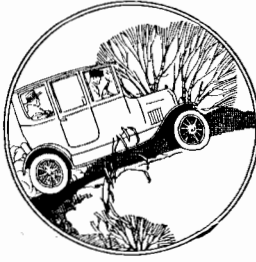

No more grinding along in low gear on many of the hills you come to—

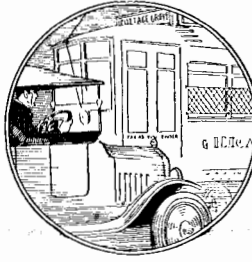

No more lazy pick-up which makes it impossible for you to pass a street car—



No more jerky, uneven pulling or inability to run in high gear when in traffic.

OW, with the RAJO Valve-in-Head, big-car performance is combined with small-car economy for the first time. You feel the thrill of power that flattens hills—the joy of speed that takes you there in record time—the security of a flexible motor action which permits acceleration from 5 to 40 miles an hour in 14 seconds flat!

And to get this wonderful service from your Ford does not mean the sacrifice of economy. Built with a Hot Spot and Cored Intake, RAJO saves enough in gasoline alone to pay for itself in a few thousand miles. With combustion chambers machined to 1/1000 of an accuracy, even explosions are insured in all cylinders—vibration is reduced to such a point that the life of your car is actually prolonged.

RAJO replaces the regular Ford cylinder head. It converts your motor into the overhead valve type—recognized as the most efficient design known to automobile engineering. Installed in 4 to 5 hours. Tungsten steel valves practically unbreakable; push rods of cold-rolled steel with hardened concave heads which retain oil and greatly lessen friction and wear.

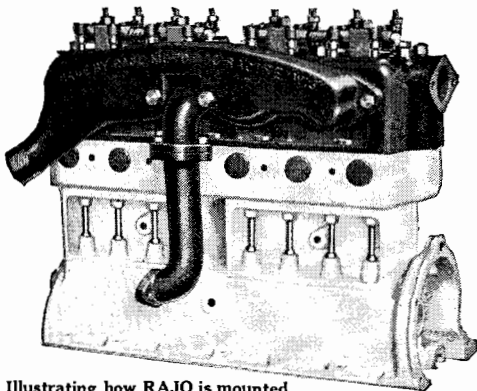

Illustrating how RAJO is mounted on the Ford motor block.

Winner at Pike's Peak

A RAJO-equipped Ford took first place in the small car event at the Pike's Peak Hill Climb last Labor Day, negotiating the steep 14 miles in the remarkable time of 21:34 3/5. When you equip your Ford with RAJO you automatically add 8 to 14 horse power—make your Ford the most powerful car in the world per pound of weight.

FORD OWNERS:—Write today for new RAJO folder—fully illustrated and more complete than ever.

DEALERS:—A postcard will bring you our most interesting proposition on a number of RAJO improvements.

RAJO MOTOR CO.
1355 Racine St., RACINE, WIS.



When writing advertisers—Just say FORD OWNER AND DEALER

D-G Draft and Dust Protectors

*Will Make Your Ford Snug
and Comfortable This Winter*

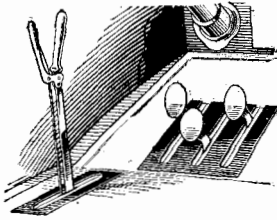

WITH

THE D-G DRAFT AND DUST PROTECTORS completely close the openings around the foot pedals and emergency brake, preventing cold drafts, mud, dirt, and dampness from entering. While the protectors completely close these openings, they do not interfere with the free operation of all levers. With them, winter driving is made a pleasure, and the interior of the car kept clean in summer.

Retail Price (Per Set), \$1.50

THE D-G DRAFT AND DUST PROTECTORS are strongly made out of heavy steel and specially prepared rubber... The protector for the foot levers is of ONE-PIECE construction instead of two... This enables the rubber guard to be of ONE CONTINUOUS PIECE with no corners exposed to wear, as would be the case if it were made in two sections. Although of ONE-PIECE construction, all floor boards can easily be removed.

FORD OWNERS:—Be comfortable this winter. If your dealer cannot supply you, order direct from this ad. A complete set sent prepaid ANYWHERE on receipt of \$1.50.

DISTRIBUTORS!

Write TODAY for our interesting proposition. Be prepared to meet the big demand for the D-G Draft and Dust Protectors that has already started.

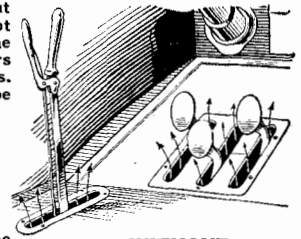

WITHOUT

THE DICKEY-GRABLER WORKS, Cleveland, Ohio

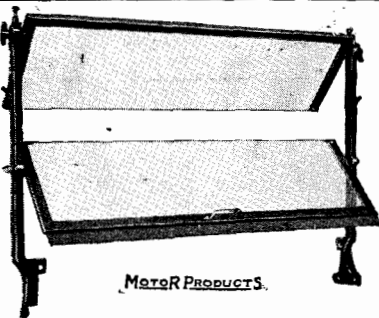

MOTOR PRODUCTS.

MODEL 170

MOTOR PRODUCTS

**Rain Vision and
Ventilating Windshields**

FOR

**Ford Pleasure and
Commercial Cars**

MODEL Z 17—For 1915 to 1921 Ford Pleasure Cars, where side oil lamps are desired. Supplied with plate glass.

MODEL 170—Same as Z 17 Model but without the side oil lamp brackets. Supplied with plate glass. For starter-equipped cars.

MODEL 150—For Re-Framing Glass of Regular Ford windshields; has side oil lamp brackets; everything except glass included.

MODEL 160—Same as Model 150 but without side oil lamp brackets. For starter equipped cars.

MODEL 100—For the Ford Truck. Supplied with plate glass. We can also supply slip dash for use with this shield at \$4.50 each.

MODEL 110—For Heavy Duty Trucks with extra wide dash. Supplied with plate glass.

Booklet 2000 Sent Free Upon Request

MOTOR PRODUCTS CORPORATION, DETROIT, MICH.

NECKTIES FOR FORDS

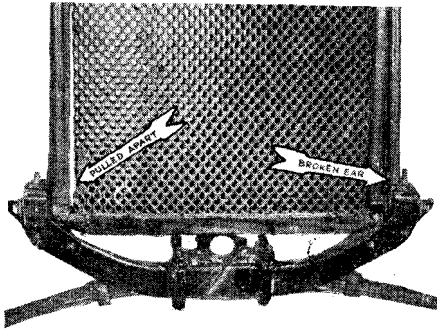

Save the Radiator

Constant pounding the Ford Cross member causes it to sag or break. When the cross member sags the radiator must hold the side rails together, thus the weight of the load is pulling across the radiator which usually breaks the ears of the radiator off, or causes the radiator to split and leak.

DID THIS EVER HAPPEN TO YOU?

MR. RADIATOR REPAIR MAN, did you ever solder a Ford radiator and charge the owner \$6.00 only to have the radiator back on your hands in a week leaking worse than ever, and repair it for nothing?

MR. GARAGE MAN, did you ever sell a Radiator to a Ford owner and guarantee it for a year only to have it come back in six weeks a wreck, the owner blaming you and demanding his money back?

MR. JOBBER, did you ever send your men out full of pep to sell Radiators for Fords get some fine business and then in less than six months have them all back, your profits gone, your salesmen disgusted, and your trade sore?

Thousands of Ford owners wonder why they have radiator trouble—THIS IS THE CHIEF CAUSE. Many mechanics wonder why the radiator is so hard to remove and why it binds. When replacing a radiator they find the bolts seem to have moved away from the holes in the brackets. A favorite stunt is to tilt the bolts toward the center, start the nuts and proceed to pull the frame together with the radiator, it is needless to say this is an expensive practice as it usually pulls the radiator apart.

NECKTIES FOR FORDS HAVE THE SITUATION BY THE NECK

The neckties pull the side rails together, relieving the radiator of all strain.

You can put it on in a minute, no holes to bore, just hook it on.

You can put a necktie on a Cross member that is broken in two, pull it together and drive it indefinitely.

Neckties save the cost of both radiator and Cross member if put on in time.

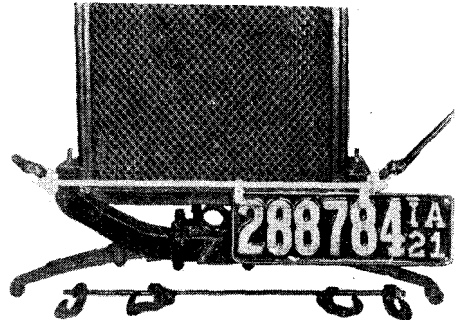

RETAIL PRICE \$2.50

Discount to dealers in dozen lots. If your local jobber does not carry them order a dozen today direct.

Every one put on, means another salesman for you. Don't Delay.

THIS COUPON WORTH 25c

Take this Coupon to your local dealer, together with \$2.25 and get a Necktie. If he does not carry them, mail it direct to us and a Necktie will be prepaid to your door.

Name

Address

Steam Tractor Auto & Mfg. Co.

Manufacturers of CARBON-O and CURB-OYL PISTON RINGS

219-223 W. 7th STREET

Bell Phone 234

SIoux CITY, IOWA

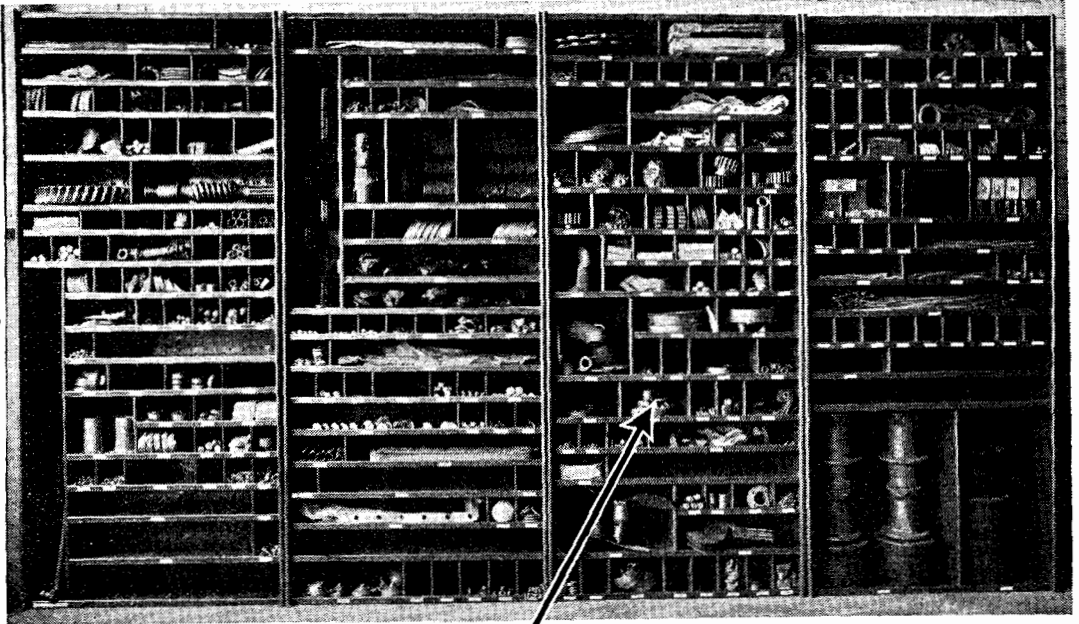

FIND FORDSON

The 4-unit Fordson system here shown carries all demand parts of the Fordson Tractor in the same compact, Parts-Book-order, 100-per-cent-display manner that "L. A. P. S." carries Ford Car and Truck parts. It's efficiency idealized-maximum selling force with minimum selling cost.

PARTS INSTANTLY

By Stocking Them in Lupton Auto Parts Storage

With "L. A. P. S." behind your stockroom counter the clerk can step instantly to the right bins, pick the parts wanted, and note the remaining stock. Wasted time, waiting lines of customers, and shortages disappear. Your "net" on sales is as close as possible to the "gross." "L. A. P. S." is sold by leading jobbers, and shipped from warehouses in Chicago, Cleveland and Philadelphia. It is made in steel, in various-sized system for various stocks. It is shipped completely assembled: there's no erection expense. Bins are adjustable to suit local demand for parts.

Write your name and address in margin and send to nearest office for full information.

David Lupton's Sons Company

Allegheny Avenue and Tulip Street PHILADELPHIA, PA.

SALES OFFICES:

CHICAGO, 1114 Steger Building

CLEVELAND, 896 Swetland Building



*"Bee Lines to
Fordson Parts"*

PARTS STORAGE

Lupton
INVESTMENT VALUE

FOR FORDS

Get the very best from
your Ford motor —
equip it with a

MODEL N. H.
HOLLEY
CARBURETOR

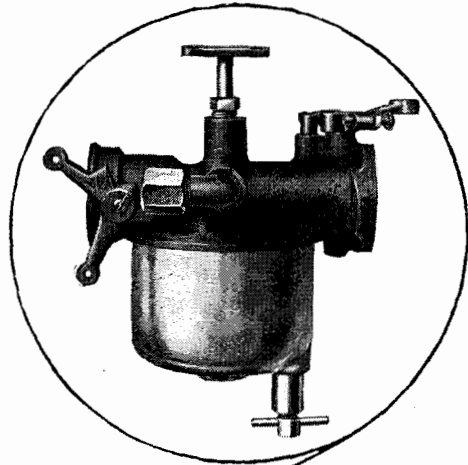

HOLLEY CARBURETOR COMPANY, DETROIT, MICH.

When writing advertisers—Just say FORD OWNER AND DEALER

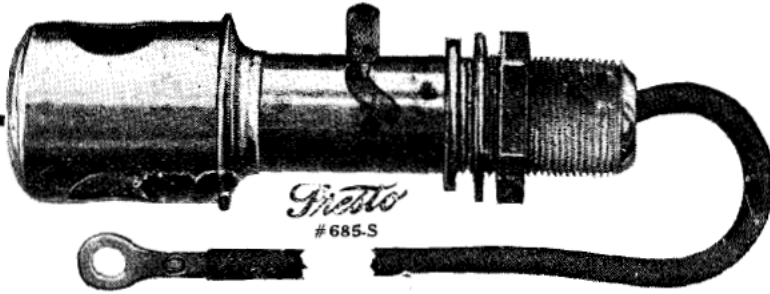

PRESTO Dash Lamp for Fords \$1.00

Complete with Bulb, Self-Contained Switch, Cord and Terminal

Beautifully nickel-plated—PRESTO Quality throughout. Notice the *extra long threaded shank*, to fit either metal dash or metal-covered wood dash. Very easily and quickly attached; no wires to cut or splice. Insist on PRESTO Lamps. Satisfaction guaranteed. If your dealer can't supply you, write us direct, giving his name.

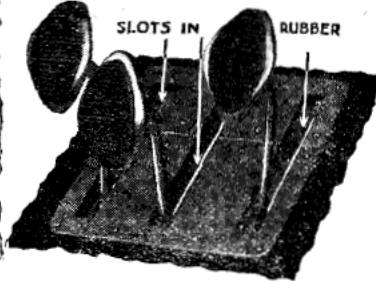

PRESTO Alweather Foot Protector

Every Ford owner should have this winter protection. Keeps cold drafts, mud, wet and dampness from entering around foot pedals and emergency brake slot.

Makes a Ford as snug, warm and comfortable as any car on the coldest days and in any kind of weather. Handsome and durable. Easily attached by anyone.

PRESTO Electric Heater

A necessity in every unheated garage—a time, trouble and money saver in *any* garage, because it does away with need of other forms of heating. The Presto Heater is provided with a swivel hook so it may be hung at any point under hood—where heat is required. Keeps radiator and engine warm in the most severe weather. Prevents freezing of water, hardening of oil and makes starting easy at all times. Saves its cost many times during the winter. Absolutely safe—no danger of fire.

DEALERS—The time to bring these winter specialties to the attention of your customers is now here. Are you ready to increase your winter profits? Write us for full information and our liberal proposition.

Ask 'em to Buy



Metal Specialties Mfg. Co.
338-352 North Kedzie Avenue, Chicago, Ill.

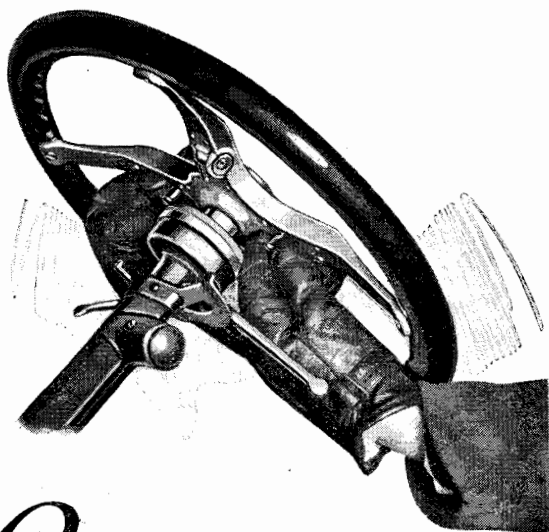
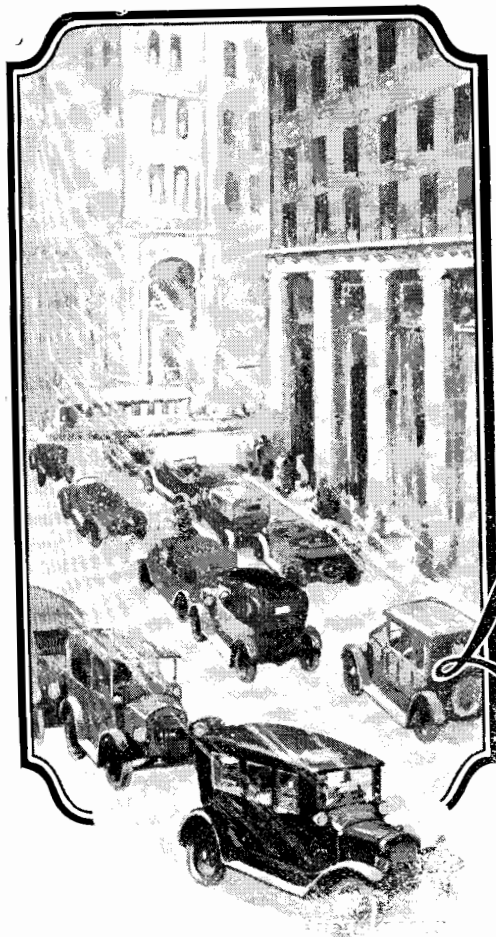

Locks Without Key

You'll Appreciate This When Coats and Gloves Make Keys Inaccessible

You don't have to fuss around with a key to lock the Lazear. Just pull down and push back the two thumb knobs on the underside of the spider and it's locked. The wheel will spin freely on the steering post, making driving impossible, and protecting your car from theft.

Besides the convenience of this keyless locking feature in cold and rainy weather when coats and gloves make it hard to get at your keys, it eliminates the possibility of leaving the key in the lock on parking, or of accidentally locking the wheel while driving. For night driving, too, or when one wishes to loan his car to a friend this keyless locking feature is an unusual convenience. Anyone can lock the car—your key only can unlock it.

Nearly 50,000 Fords are stolen annually. With a Lazear on your car it is safe anywhere. Put one on now—don't wait until your car has been taken to wish you had.

The Lazear more than pays for itself in insurance rate reductions in many states; everywhere it saves at least 15 per cent.

Jobbers' and Dealers' Prices on Request.

LAZEAR PRODUCTS COMPANY

Dept. 103 557 W. Quincy St., CHICAGO, ILL.

NEAT AND SMART LOOKING

This beautiful 17 inch steering wheel with its fine, finger-grip walnut rim and highly polished aluminum spider adds an atmosphere of distinction. It also greatly increases control and comfort in driving.

Lazear

LOCK STEERING WHEEL FOR FORDS

DREDNAUT

SHOCK ABSORBERS FOR FORDS

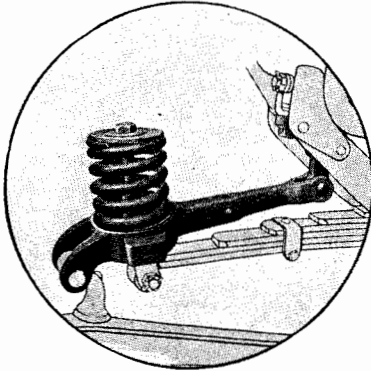

\$18.50
Per Set

Coupe
Sedan
Runabout
Touring Car
Light Delivery
One Ton Truck

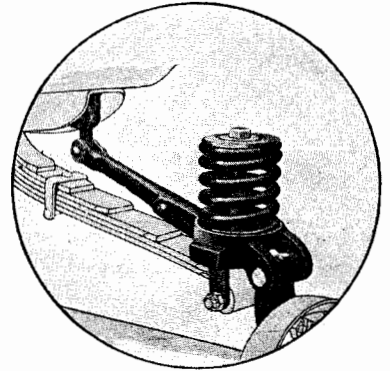

\$18.50
Per Set

Your Ford Is Protected By Them

Are you a believer in rubber heels—that they make your walking easier and increase shoe comfort?

If you are, it will not require a long preachment upon shock absorbers for a motor car. The reasons for both are basically alike. By taking up and absorbing road shock, tire and spring life is prolonged, the motor and finer mechanisms are protected—and the rider's comfort is consequently increased.

Drednaut Shock Absorbers do all that, and do it well. Designed scientifically and made of materials specifically correct for this service, they are the biggest shock absorber value for the money on the market today.

And You Are Protected By The Guarantee

Drednaut Shock Absorbers are unconditionally guaranteed for five years against defective materials and workmanship. Furthermore, we are willing to protect you against buying a "pig in a poke" by allowing you to use a set of Drednauts for ten days—for a thorough trial. If at the end of that time you do not think and believe as we do—that they are the best shock absorbers on the market—drive back to the man who sold them to you. He will remove them at no expense to you and refund the price you paid for them.

Does This Appeal to You as a Business Proposition?

If it does, get in touch with your dealer, or write us direct. Full illustrated literature will be sent upon request.

AUTO SPECIALTIES MANUFACTURING CO.

335-365 Graves St.,
St. Joseph, Mich.

Department 9-C

Tecumseh Road,
Windsor, Ontario

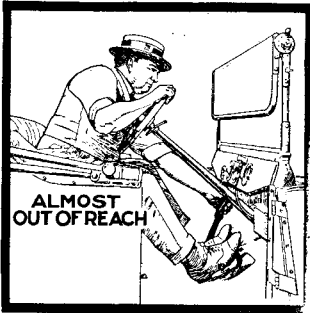

You use your hand brake at least twice whenever you drive your Ford. And every time you use the brake you have to reach way down close to the floor. Wouldn't you like to avoid the exertion of that long reach every time?

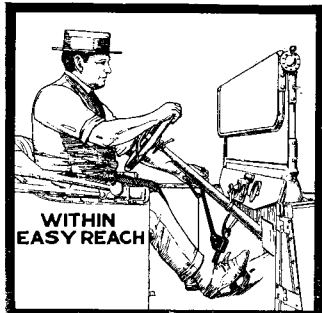
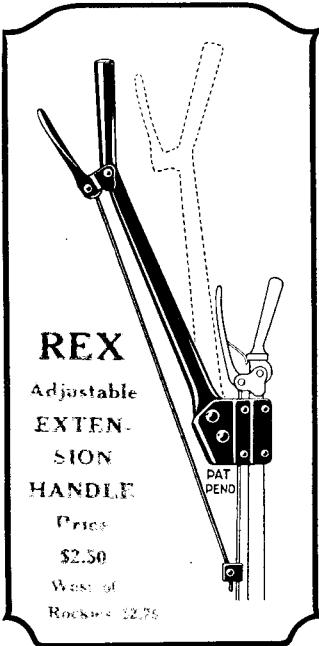

In emergencies when you want to use the hand brake quickly, the Rex Handle adds to your safety and comfort. It can be adjusted to fit any model Ford car or truck, and to compensate for wear on brake lining.

New Ford Drivers will appreciate the Rex Extension Handle because it adds to their comfort and confidence. It saves them from that nervous feeling when crossing railroad tracks and when coming suddenly upon obstructions in the road.

Seasoned Ford Drivers will appreciate the convenience and comfort made possible through the Rex Handle when they are bundled up in heavy clothing and robes.

Surely the comfort, safety and saving which the Rex Extension Handle makes possible is worth more to you than the \$2.50 you invest in it.

Have your dealer install one on your car. If he does not have one in stock when you call, send us the attached coupon and we will arrange to have him supply you.

AJAX AUTO PARTS CO.

Dept. B.

RACINE, WIS.

AJAX AUTO PARTS COMPANY,
Dept. B. Racine, Wis.

Please send me your folder describing the Rex Extension Handle and arrange with my dealer to install one on my car.

Name

Address

Dealer's Name.....

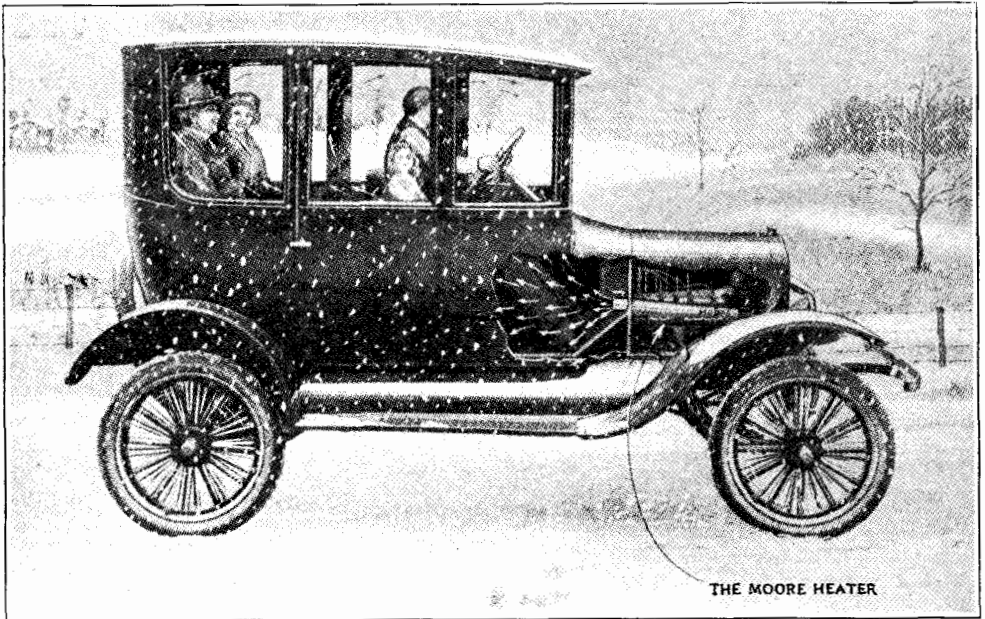

THE MOORE HEATER

BUT IT'S SUMMER IN YOUR CAR

Out of doors it may be wintry; zero weather, snow and wind may prevail, but it is summer in your car if you have followed the example of hundreds of other Ford owners and installed a

Moore Car Warmer

For Ford Coupes, Sedans and Touring Cars

Here is a device, that at very small cost makes your Ford truly an all-year car. It affords real comfort, warmth and protection.

The Moore car warmer is easily attached to the manifold. Fresh air is heated by the manifold and is forced into the car. **Remember this:** It is just fresh, healthy, warm air with no gas or fumes and it is easily regulated according to the amount of heat you wish.

Another point—the Moore Car Warmer acts as a manifold heater promoting easier starting and a better running motor.

There is a world of comfort and economy

in this device. You can install it in a few moments—it requires no attention and costs nothing to operate. The price complete is \$2.50.

The Moore Car Warmer comes ready to put on your car and five minutes after you get it you will have summer weather in your car regardless of the weather out of doors.

If your jobber or dealer cannot supply you write us giving his name.

JOBBER AND DEALERS:

This practical and inexpensive car heater sells everywhere on sight. Ask us what it can mean to you.

MOORE MANUFACTURING CO.

WATERLOO, IOWA

Light car owners want this tire

BACK of this new Republic is fifteen years of experience and development by the Republic Rubber Company. In it we have built a tire with all the best qualities of the famous GRANDE CORD plus the new breaker construction and an improved staggard tread—making it a tire that WILL give wonderful mileage. No wonder light car owners everywhere want this tire.

31x4 GRANDE CORD
STRAIGHT SIDE, STAGGARD TREAD

Fits straight side 30x3½ rims. These rims are now available as replacement for clincher rims on many light cars, without any wheel changes, at extremely reasonable cost. And many important light car builders have adopted the 30x3½ straight side rim as regular equipment.

These facts open up a new sales area that tire dealers will be quick to take advantage of. **DELIVERIES ARE BEING MADE NOW.** ¶So we suggest you order at once from your nearest Republic jobber or branch and get the 1922 sales proposition. Address

THE REPUBLIC RUBBER COMPANY

OF NEW YORK

221-223 WEST 37th STREET, or

Philadelphia - - - - - 2835 North Van Pelt St.
Cincinnati - - - - - 424 West Fourth St.
Pittsburgh - - - - - 953 Liberty Ave.
Cleveland - - - - - 632 Frankfort Ave., N. W.
Detroit - - - - - 323 Ford Building
Minneapolis - - - - - 428 Stinson Blvd.
Chicago - - - - - 1720 So. Michigan Ave.
Atlanta - - - - - Corner Ivy and Harris St.
Kansas City - - - - - 2004 Grand Ave.
Buffalo - - - - - 725 Main St.



A Perfect
Union
The new
breaker con-
struction
makes carcass
and tread in-
separable

Republic STAGGARD TREAD

GRANDE CORDS AND FABRIC TIRES
All Standard Sizes - Factories: Youngstown, O.

If you don't get 26 to 30 miles per gallon from your FORD you do not have the

NEW MODEL L-4

Kingston Carburetor

THE NEW KINGSTON MODEL L-4 CARBURETOR, which is being used as regular equipment by the Ford Motor Company on its new cars, is the biggest step forward in carburetion in the last twenty years. Here is the story in brief:

Tested in all weathers, in all parts of the country, under all conditions, it produced more power than any other carburetor we ever produced. A wonderful hill climber.

Positive and repeated tests insure this mileage:

Touring Cars	26 to 30.6 miles to gallon.
Sedans	21 to 25.4 miles to gallon.

The New Kingston Model L-4 is provided with the improved spray nozzle, involving an entirely new principle in carburetion, and providing a super carburetor. More pep, quicker getaway, economy and power. Fully guaranteed.

Price \$6.00

WITH FUEL STRAINER \$7.50

At Your Nearest Dealer, or Write Manufacturers Direct

Note — This carburetor is not sold on extravagant claims, but upon its proved record of actual performance. It is guaranteed to do exactly what we say it will do.

BYRNE, KINGSTON & COMPANY
KOKOMO, INDIANA, U. S. A.

Branches — New York, Chicago, Detroit, Boston, San Francisco

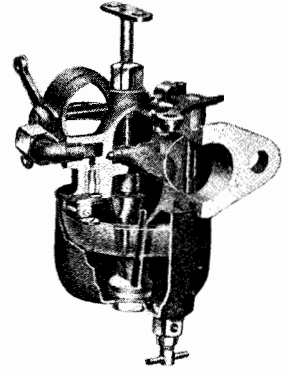

Cut-away view of the famous Kingston Model L-4, the NEW carburetor for Fords—simplest, staunchest and most efficient carburetor made.

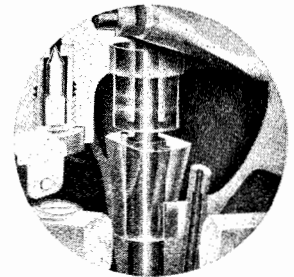

Close-up view of the Kingston Model L-4 Spray Nozzle, the device that has made better carburetion possible. To be had ONLY on the new Kingston carburetor

Kingston Carburetors are Used by 80 per cent. of American Farm Tractor Manufacturers

KINGSTON

CARBURETORS

When writing advertisers—Just say FORD OWNER AND DEALER

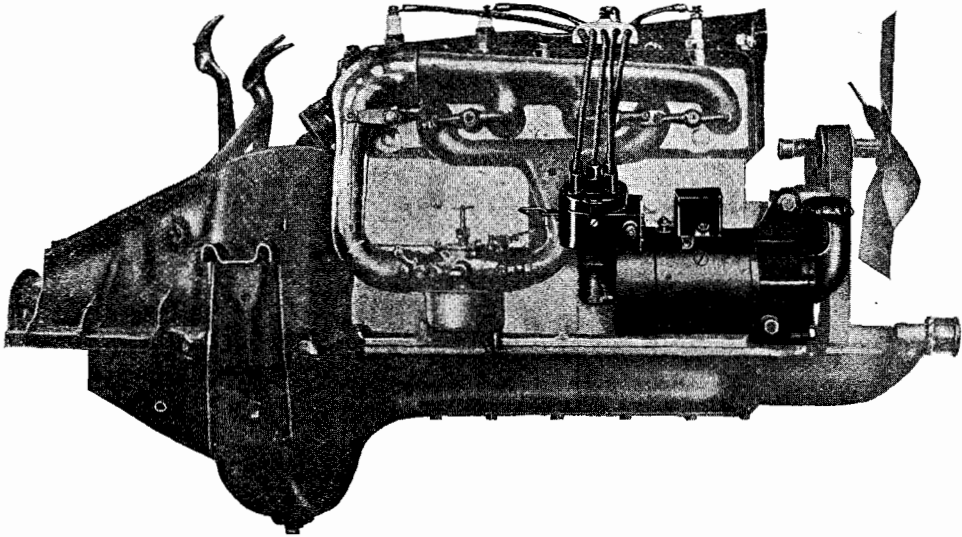

LIBERTY

TYPE FR

GENERATOR-IGNITION UNIT FOR FORD CARS

A high grade electrically perfect generating and ignition system combined for maximum car performance.

Do away with troublesome commutator; fussy vibrator coils and their current supply—the alternator magneto.

Replace the Ford generator with this dual unit or “Central Station” that keeps your battery properly charged, and delivers an exactly timed *ARC like* spark at the plugs.

What the Liberty System Does for You

- | | |
|---|---|
| <ul style="list-style-type: none"> 1—Gives you a single spark of intense heat value exactly timed, equalling the performance of the best high tension magneto, and surpassing it on hard pulls at low engine speeds. 2—Prevents carbon formation on the spark plug electrodes by eliminating intermittent firing. 3—Enables you to make a quicker getaway or to get quicker acceleration. 4—Gives you a smooth running engine. 5—As the result of a smooth running engine cuts | <ul style="list-style-type: none"> 6—Gives you an even powerful pull on hills. 7—Enables you to run at low speeds in high. 8—Gives you more miles per gallon, because the hot spark produces complete combustion of the mixture. 9—Keeps your battery up to maximum efficiency, resulting in snappy starting. 10—Keeps owner out of electrical repair shop and battery charging stations. |
|---|---|
- The Liberty System includes Generator, Ignition Head, Cut-Out, High Tension Coil, Spark Advance Rod and Clamp for Spark Advance Lever, High Tension Cable Terminals, complete and ready for installation. Installed in 30 minutes.

Price Complete \$50

Guaranteed for one year against electrical or mechanical defects

Some Desirable Sales Territory Is Still Open. Write for Distributor's Proposition

CAR OWNERS—Descriptive Circulars on Request



**Algonquin Electric
Manufacturing Corporation**



POUGHKEEPSIE, N. Y.

When writing advertisers—Just say FORD OWNER AND DEALER

You Can Make a Stop Signal Out of Your Parking Light With This

Safety
and
Surety
at
Small
Cost

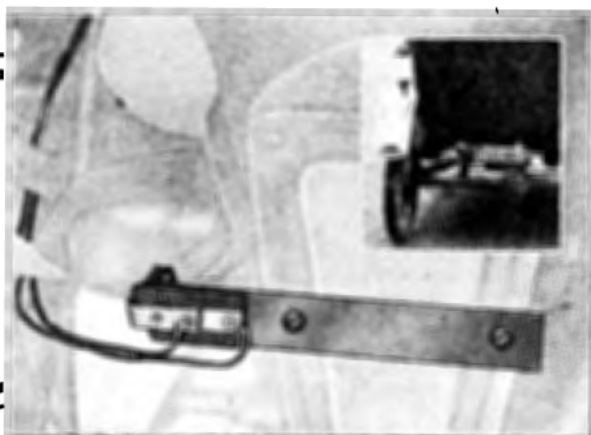

Requires
No
Attention
Operates
Automatically

WESCO Auto-Stop-Park-Signal Switch

—and it takes only a few minutes. The only tools you need are a screw driver and pliers—no holes to drill, no fine adjustments to make and no trouble of any kind. Complete mounting and wiring instructions in each carton. Fits under the floor boards, out of sight, and operates automatically with the action of your foot brake. As the foot brake is depressed the red danger signal flashes automatically, effectively warning autoists behind to be cautious. It requires no attention from the driver.

For parking, all that is necessary is to turn on your dash light switch and your parking light is in operation, independent of your foot brake switch.

The Wesco Auto-Stop-Park-Signal Switch supplies one of the most popular Ford accessories needs on the market today. It is the only device of its kind and is being adopted like wild fire by Ford owners and dealers all over the country.

AGENTS AND DEALERS

Agents and dealers will find in this one of the most remarkable sellers in the Ford accessory field. Sells on sight—no comebacks. Investigate our sales proposition. You can't afford to miss it. Sample for examination to agents and dealers on request. Mail the coupon now.

COST
COMPLETE **\$1.90**

WEST MANUFACTURING COMPANY

MONTGOMERY BUILDING.

MILWAUKEE, WIS.

START THIS COUPON ON THE WAY TODAY

WEST MANUFACTURING CO.,
Montgomery Building,
Milwaukee, Wis.

Send.....sample, prices and dealer's discount.

Name Address.....

City State.....

When writing advertisers—Just say FORD OWNER AND DEALER

It's Safe Now

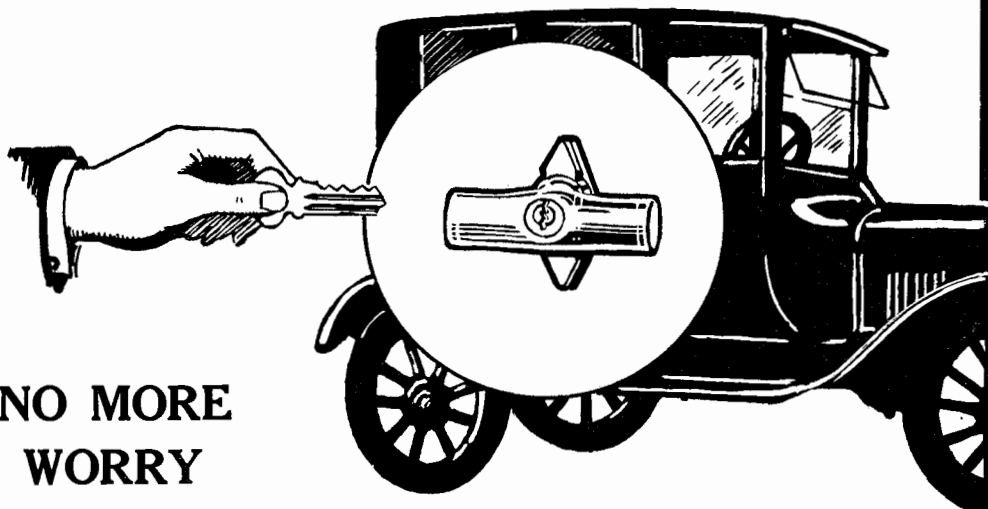

NO MORE WORRY

When you leave your car parked why worry and wonder whether it AND ITS CONTENTS are safe?

YOU WILL KNOW that everything is safe and theft-proof if your car is equipped with

COWLES DOOR LOCKING HANDLES *For Ford Sedans and Coupes*

Equipped with these handles your car is absolutely safe against theft and no one can tamper with tools, baggage or garments left in the car.

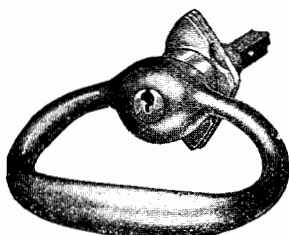

No. 105F

Showing handle in position. When locked, handle cannot be turned or removed. Note how Safety Plate covers heads of attaching screws.



Showing Handle unlocked and turned—ready access to attaching screws.

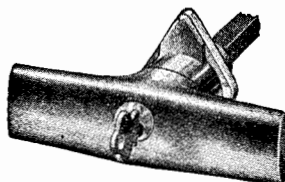

No. 124F

EVERY COWLES DOOR LOCKING HANDLE contains a real pin-tumbler lock. Separate key for each car—no duplicates. No sneak thief can gain entrance by removing the attaching screws—**The Patented Safety-Plate prevents it.**

Easily attached—cost nothing to install—a screw driver the only tool needed.

RETAIL PRICE \$5.00 EACH

LIBERAL DISCOUNTS TO DEALERS—WRITE FOR CIRCULAR

C. COWLES & COMPANY

NEW HAVEN, CONNECTICUT



THIS IS A PICTURE OF A LOT OF YOUR CUSTOMERS

If they don't want to burn out their bearings or have carbon trouble they have to get down like this every once in a while and turn those two pesky petcocks. It's the only way to tell whether they have enough oil. It's a dirty, messy job; hard on clothes and temper and dignity.

We have developed a tool which allows the Ford owner to stand beside his car and turn on both petcocks by simply twisting a little lever above the apron. We call it the

OIL TEST **FOUR-D** FINGER **D** WRENCH

The drawing in the lower corner shows how it works. A twist of the wrist opens both petcocks. If there is no drip he needs oil. If oil drips from the top petcock and runs from the bottom petcock his oil is right. Another twist closes the petcocks again.

The wrench slips on easily and is held in place by a spring clip. Just one hole to be drilled in the apron. A few minutes to put in place and then—no more crawling in the road, no more ruined clothes.

The retail price is 85c—more than saved by the first grease spot saved. Any Ford owner will find it worth more than that just for the added comfort it gives and ease of telling about his oil level. Dealers and jobbers make good profits, too, at this price. Write to us for information.

SOUTH BEND WRENCH & TOOL CO.

South Bend

Indiana

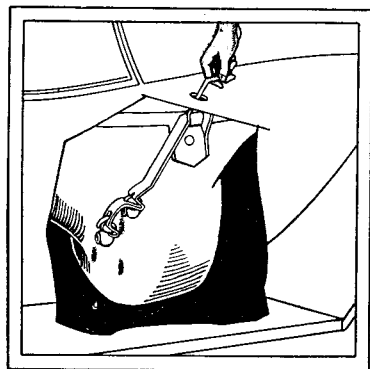

The Turbulator

Puts Power and Zip
in your Ford with
any old gas

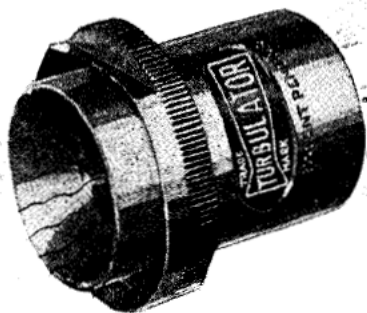

GUARANTEED

to be the first and only scientific device to prevent carbon and to turn into additional horsepower, the gasoline your engine now wastes.

Satisfy Yourself—At Our Expense

Poor gasoline—that's the real cause of practically 90% of all motor troubles today. 17% of it never explodes—and this raw gasoline, which carburetor manufacturers now openly admit cannot be properly handled, is what does all the damage.

KEEPS ANY ENGINE CLEAN INSIDE

Slip a pair of Turbulators into the intake ports—no holes to drill—you can do it in ten minutes with a wrench—and your Ford will run with power and zip it never had before. After 48 hours every bit of carbon will be burned off your spark plugs. You can SEE this. Additional horsepower is actually produced. Mileage is greatly increased. Crank case oil never becomes diluted. Starting is easy in coldest weather.

BUT—ANY OLD GAS WILL WORK NOW

Mr. W. A. Edwards, one of the foremost carburetion engineers, has at last succeeded in trapping and breaking up this waste into highly combustible gas. His marvelous device, the Turbulator, makes any old gas deliver 100% power! You notice the difference the first 500 feet!

MONEY BACK GUARANTEE

If you are not more than satisfied after ten days' trial that the Turbulators are the greatest investment you ever made, your money will be promptly refunded. Send a check or money order for \$5 today, and you will receive immediately, all charges postpaid, a pair of these wonderful money and trouble saving Turbulators. They will pay for themselves in less than a month—we take all the risk.

**EASY
START-
ING**

**EATS
CARBON**

**SAVES
MONEY**

**KEEPS
ENGINE
CLEAN**

**MAKES
ANY
GAS
WORK**

DEALERS:—The entire accessory business is being revolutionized by the Turbulator. It displaces without exception, every other device designed to assist carburetion. Write us today for our special dealers' proposition. Every Ford owner in your district needs a set of Turbulators.

THE TURBULATOR CORPORATION

2635 S. MICHIGAN AVE., CHICAGO, ILL.

When writing advertisers—Just say FORD OWNER AND DEALER

WE HAVE SOLVED THE PROBLEM!

Gasoline Utilized in Your Engine to the Last Drop *The Breeze Visible Fuel Converter*

For Ford Cars

Has been given
three years' test
by a noted car-
buretion ex-
pert.

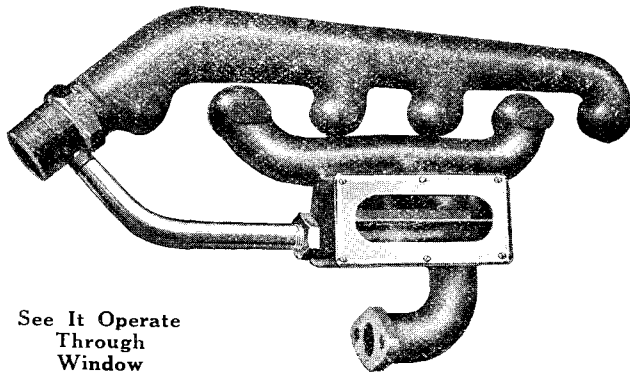

Uses Standard
Carburetor and
Goes on With-
out Machine
Work.

See It Operate
Through
Window

This Is What It Accomplishes

Gives all the advantages of Hot Spot and Hot Jacketed Manifolds without heating the mixture.

Gives large increase in mileage and stops crank case dilution.

Stops Spark Plugs From Fouling and Reduces Carbon.

Runs a hot mixture for idling and a cool mixture under load.

***We Want Live Men to Make Personal Sales and
Business Men to Handle Territories
Would You Like the Agency in Your Locality?***

The man who makes the money is the one who has one on his car and shows it. It sells itself. We find that to show the device to a man is to sell it. He sees the operation thru the window and his common sense shows him its advantages... Those who use it always help sell to their friends.

SPECIAL PRICE ANNOUNCEMENT—Owing to big demand and our ability to quickly get into quantity production we are able to announce new retail price of \$10.00. The Breeze Fuel Converter saves its cost on the first \$20 worth of fuel and several times a year in engine repairs.

Write us today for our excellent proposition. If there is no dealer in your locality we will sell the first one at Dealer's Price.

DETROIT PARTS MFG. CO.

2699 GUOIN STREET

DETROIT, MICH.

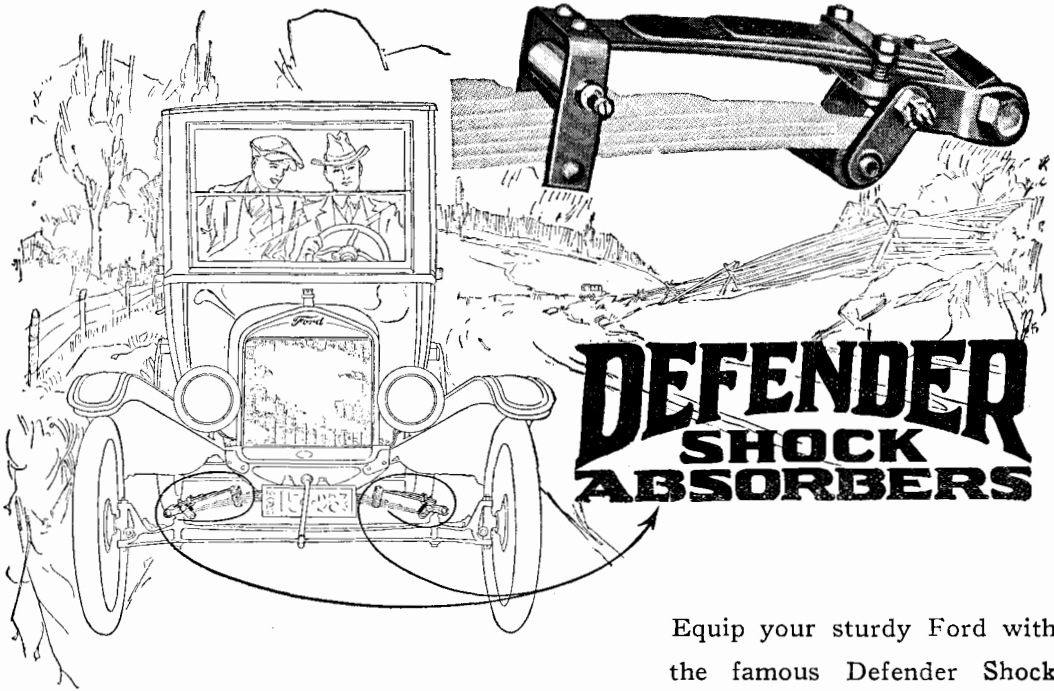

Equip your sturdy Ford with the famous Defender Shock Absorbers and you'll be both astonished and delighted at its luxuriously comfortable riding qualities; at its safer roadability and steering control; at the way dangerous side-sway is eliminated, rebounding action snubbed and shocks, jolts and jars smothered.

Then "Defenders" will withstand the hardest service and last indefinitely. "Defenders" quickly pay for themselves by preventing spring breakage, lowering repair bills and reducing tire, gas and oil expense. Fully guaranteed and sold to you under a 10 day trial test with your money back if you'll take it. See your Ford dealer or write us direct.

**SPECIAL TO
FORD DEALERS**

We are anxious to have every Ford Dealer test the truly remarkable advantages of Defender Shock Absorbers on their own car. Write us for our Special to Dealers 30 day trial proposition.

DEFENDER AUTO-LOCK CO.

ALLEGAN, MICHIGAN

Pioneers in the Ford Lock Field—Makers of the New Defender Thief-Proof Steering Wheel Lock for Fords.

At Last!

A Real Steering Wheel Lock

FOR FORD CARS

IT IS NOT
A LOOSE WHEEL
THAT "SPINS"

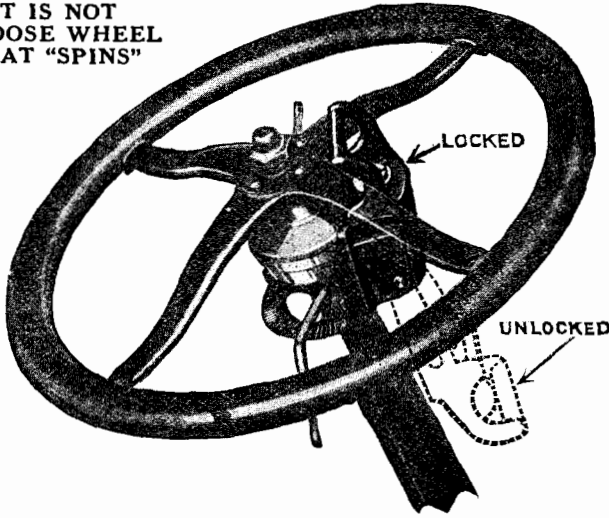

NOT A DEVICE TO
JAM THE STEERING
MECHANISM—OR
WEAKEN VITAL
PARTS

Not a flimsy die cast structure to replace some important part on which your life depends—but a real 100% efficient securing device that locks instantly **WITHOUT** key, with gloves on or off, always in plain view, whether locked or unlocked.

You do not have to buy a new wheel or change a single part to install, which is accomplished **IN LESS THAN FIVE MINUTES WITH A SCREW DRIVER.**

Genuine YALE Non-Pickable Lock

And All Parts Made of Strongest Steel Insures Protection

Dotted lines show unlocked position—when swung upward by hand, wrist or elbow, powerful steel arms go **between** and **over** two spokes, not only preventing turning of wheel, but making removal of wheel impossible.

LOCKS WHEEL IN EITHER STRAIGHT AHEAD, RIGHT OR LEFT HAND POSITION AS DESIRED

IT IS FORGET PROOF, THIEF PROOF AND ACCIDENT PROOF

Pronounced by Automotive Authorities **the Greatest Achievement Ever Accomplished in Locking Devices**—such is the New York Steering Wheel Lock for Ford Cars.

Conditions of sale. Price \$7.50, which will be refunded at the end of thirty days' trial, if you are not convinced that it is the best and most necessary investment you have ever made.

NEW YORK COIL COMPANY

338 PEARL STREET

NEW YORK CITY, N. Y.

When writing advertisers—Just say FORD OWNER AND DEALER

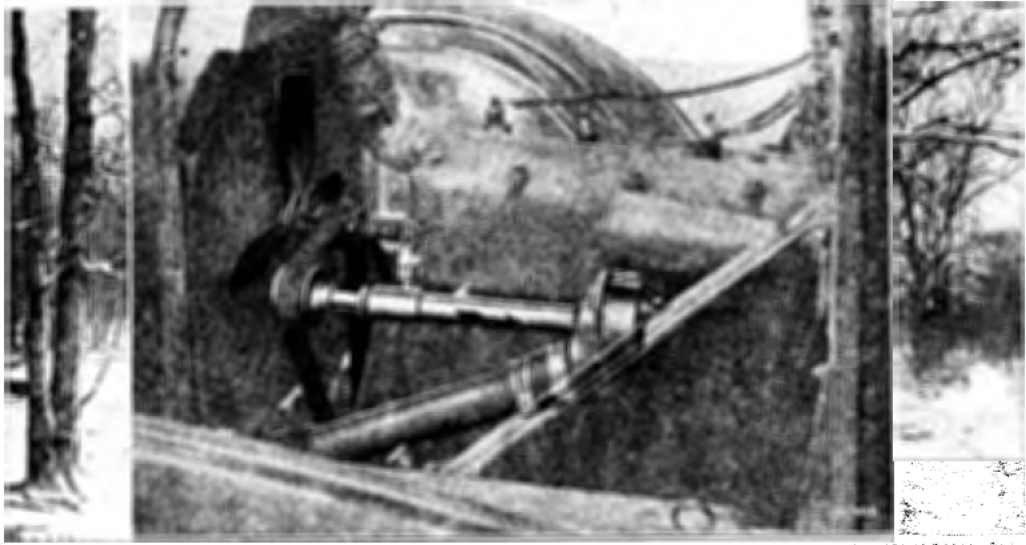

A WINTER NECESSITY

Winter motor troubles cannot be avoided except by means of sure water circulation which maintains the right temperature. There is a way to be sure of this right temperature—to realize perfect motor service and real economy. Equip your car with a

Water Circulating Pump for Fords

It will help prevent the trouble and expense of a frozen water system. It will also prevent overheating resulting from the use of alcohol or other anti-freeze solutions. In warm weather it will prevent overheating no matter how hard the engine is worked. It will provide the RIGHT temperature at all times.

THIS IS WHAT IT MEANS

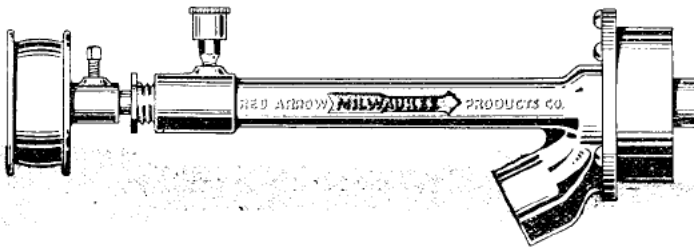

- A saving in fuel.
- A realization of full power and smooth action.
- Savings of bearings and entire circulating system.
- Oil lasts much longer.
- A reduction in carbon.
- A big saving of time, trouble and money.

RED ARROW is simple and strongly built. Shaft has three bearings equipped with substantial bronze bushings—bronze impeller. It always works and you can install it in twenty (20) minutes.

Price, Complete, \$11.00

If you are not satisfied with results—your money will be refunded. If your dealer cannot supply you, we will send direct upon receipt of price and dealer's name.

DEALERS: RED ARROW is the best pump proposition on the market.
Use the coupon

Manufacturers

Red Arrow Products Co.
Milwaukee, Wis.

Sole Sales Representative

THE FULTON CO.
Milwaukee, Wis.

The Fulton Co.,
Milwaukee,
Wis.

Send me parcel post
..... Red Arrow Cir-
culating Water Pumps. If
the pump is not entirely satis-
factory I will return same and
you are to refund the price.

COUPON

Name.....
Address.....
City..... State.....
My jobber or dealer is.....

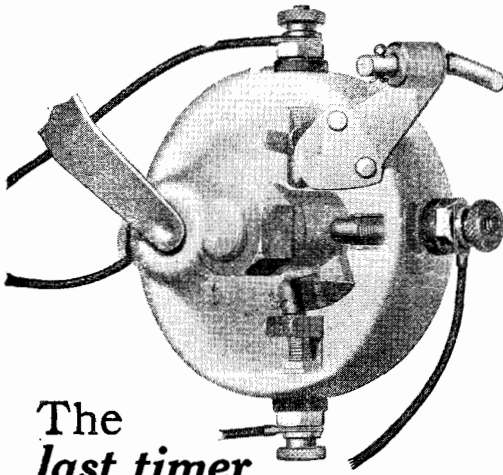

The
last timer
you'll ever need.

This *oil-less* timer.

Never down and out—

—always easily re-
newed with—

—these quick-change
contacts,  **25¢**

Inserted in  per set
2 minutes—no tools.

The *most accurate*
timer made—the

Eclipse ~~Oil~~-Less

The Timer that Outlasts the Ford

Get an Eclipse—on our 2-week trial basis.
Read the liberal trial offer on the coupon.

Eclipse Timer Mfg. Co., 2907 Meisner Ave., Milwaukee, Wis.

GENTLEMEN: Please send me an Eclipse Oil-Less, Life-of-the-Car Timer on your 2-week trial basis. I will pay the postman \$1.50 on delivery with the understanding that if I am not satisfied with the Eclipse in two weeks, I can return it and the full **\$1.50** amount I paid will be refunded.

Name _____

Address _____

City or Town _____ State _____

If you want spare set of contacts write yes here _____, and pay postman 25c additional. Please write the name and address of your dealer on the margin below.

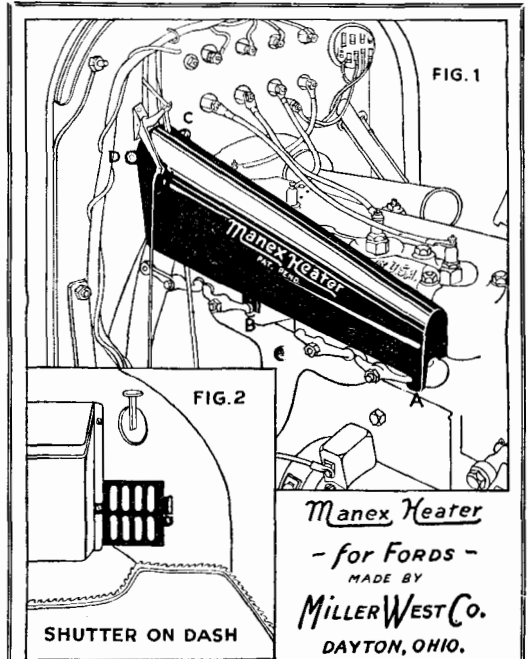

The illustration above shows the method of attaching the Manex Heater to Ford cars. The dome-shaped air chamber completely covers the exhaust manifold so that a large volume of pure warm air flows into the car sixty seconds after the motor is started.

Manex Heater

For Ford Cars

It is the standard by which all others are judged. There is nothing complex; nothing that may be broken. It is as practical as it is simple.

The Manex is easily installed by any Ford owner and may be quickly removed in the summer. Does not cut through and weaken floor boards or damage carpet. Heats only fresh air no dangerous exhaust gases or smoke.

PRICE \$3.00
ONLY

Write for Folder Giving Ten Points of Manex Superiority.

DEALERS—The Manex Heater is sold by several of the largest auto supply jobbers. If your jobber hasn't it in stock, wire us. We will get immediate action.

The Miller-West Co.

222 Dayton Savings Bldg.

DAYTON, OHIO

The Manex Makes Winter Motoring a Pleasure

MENDALL METAL



**Makes More
Clear Dough
Than All Your
Welding Equip-
ment**

Mends Cracked Auto
Parts in Place

Quicker Better, More
Profitable Than Welding

**Thousands of Repair Shops Now
Use Mendall Metal**

The O'Meara-Green Motor Co.

AUTHORIZED *Ford* AGENTS

14TH AND BROADWAY

Denver, Colo June 13th, 1921.

4 A Products Co
Dear Sirs:

We have been using your Mendall Metal for the past two years, and find it unequal for repairing cracks and holes in Auto Castings.

It certainly does all the work claimed for it and you may deliver us three more packages at your earliest convenience. O'MEARA GREEN MOTOR CO.

a. e. ables

NOTE—Sold thru regular trade channels—if your local dealer or jobber cannot supply you, order direct.

THE 4-A PRODUCTS CO., Mfrs.
31st & Downing Street Denver, Colorado
Eastern Office—1416 Broadway
New York City



The 4-A
Products Co.,
31st and
Downing St.,
Denver, Colo.

Gentlemen:—
I wish to try Mendall Metal in my own shop. Attached to this coupon is my check for \$5, payment in full for one trial package (6 bars) of Mendall Metal, which you are to send me immediately by parcel post, prepaid.

Name.....
Address.....



When writing advertisers—Just say FORD OWNER AND DEALER



QUALITY
SNAP RINGS

*More Than
a Million a Month*

Ask your
Dealer for
Quality
Snap Rings.

THE *Piston* RING COMPANY
MUSKEGON, MICH.

When writing advertisers—Just say FORD OWNER AND DEALER



CLEAN SPARK PLUGS

On "Oil Pumpers" GUARANTEED!

SEE COUPON BELOW

DOES your engine keep missing because of dirty spark plugs? It only takes five minutes to overcome the nuisance of continually cleaning or replacing spark plugs on oil pumping cylinders by installing a set of

Gemco
MILWAUKEE
TRADE MARK

BAF-OIL PLUGS

Sold on Money Back Guarantee

A scientific but simple device with no moving parts to get out of order or require adjustment.

Two baffle plates cast into each BAF-OIL PLUG, prevent oil from reaching spark plugs. When the spark occurs, the perfectly vaporized gas in the BAF-OIL PLUG ignites and shoots into the cylinder proper. This causes a clean sharp explosion which increases the power of the motor and reduces carbon deposit.

Ford Size—\$4.00 a Set

DEALERS AND JOBBERS—Most every owner of a Ford pleasure car, truck or tractor is a prospect for Baf-Oil Plugs. Write for attractive sales plan.

GEMCO MFG. CO.
750 So. Pierce Street,
Milwaukee, Wis.

TRIAL ORDER AND GUARANTEE
GEMCO MANUFACTURING CO.,
750 South Pierce Street,
Milwaukee, Wis.

Dear Sirs:—

Enclosed find \$4.00 (check or money order) for one set of 4 BAF-OIL PLUGS for Fords.

I am ordering these Plugs with the understanding that if they do not keep spark plugs clean, lessen carbon deposit, and increase the power of the motor, my money will be refunded.

Very truly yours,

C & M OIL RETAINERS

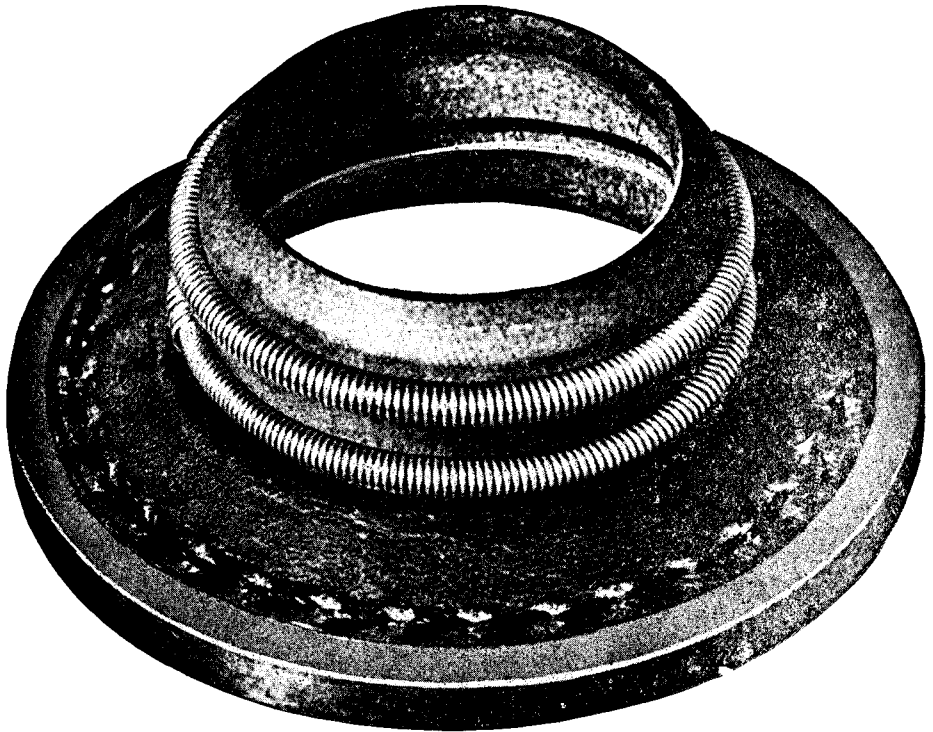

Patented April 1, 1913—Jan. 9, 1917—Jan. 14, 1919
 "MADE OF LEATHER—THEREFORE LEAK-PROOF"

OTHER C & M PRODUCTS

C & M TRADE MARK
 PATENTED

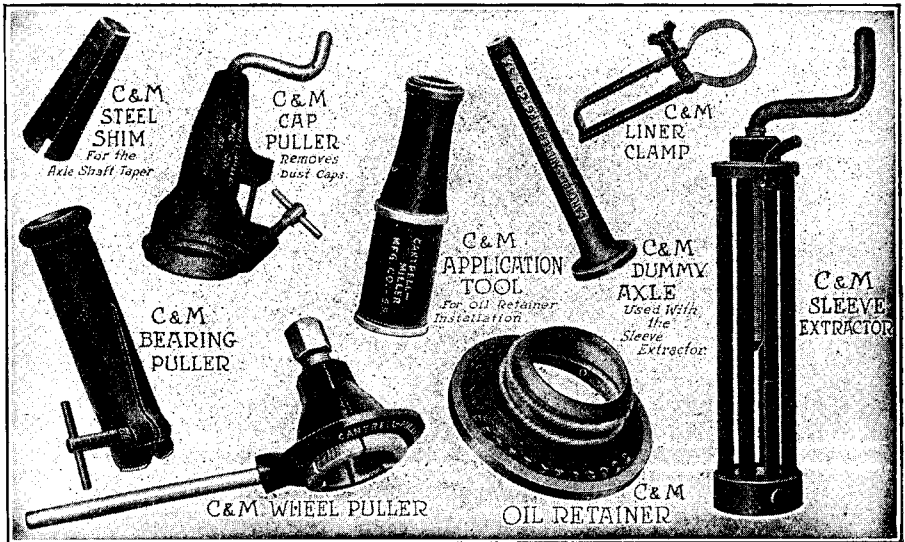

FORD REPAIRMEN AND AGENTS—WRITE TO US OR YOUR JOBBER
Cantrell-Miller Manufacturing Co. Inc., 1246-1254 Larkin Street
 San Francisco, Calif.

When writing advertisers—Just say FORD OWNER AND DEALER

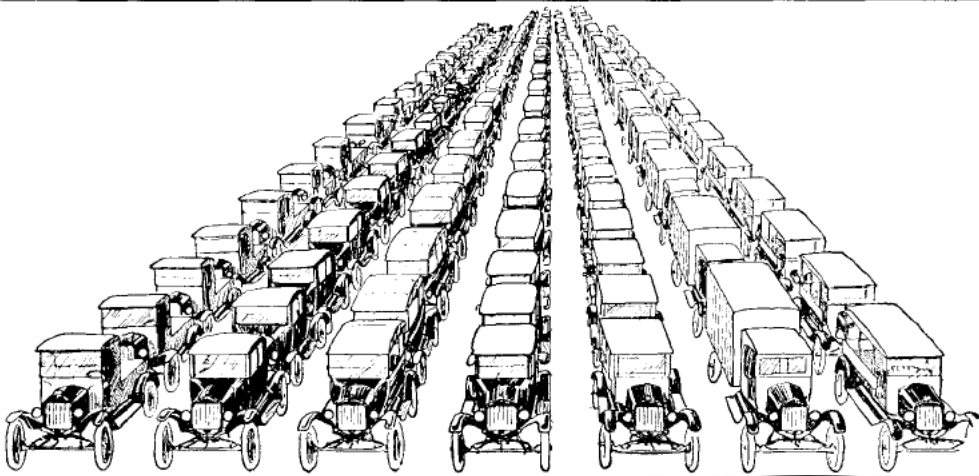

Every Ford Needs An Arvin Heater

Fully covered
by patents of
Dec. 19, 1916,
and patents pending.

Suffering from intense cold or, still worse, storing your car for the winter, is not necessary.

But without a good heater on your Ford you must either let it lie idle or stand the discomfort of the biting cold.

Every Ford needs an Arvin Heater because it keeps the interior of the car warm and comfortable. It is a hot-air furnace for your Ford. Fitting over the exhaust manifold it catches the radiating heat and carries it back into the car. No mechanical changes necessary—anyone can install it in less than 20 minutes by following the instructions packed with each heater in its attractive individual carton.

Drive in and have your dealer install your Arvin Heater while you wait.

Dealers

The Arvin Heater is simple in design and quick to install.

It will mean many satisfied customers for you.

The dealer profit is liberal.

Practically any jobber can furnish you with Arvin Heaters for both Ford and Dodge cars.

Reduced to \$1.50

Your Dealer Has or Can Quickly Get

*Arvin Heaters
Are Built for
Dodge Cars*

Also



THE ARVIN HEATER COMPANY, Indianapolis



A High Grade Radiator Reasonably Priced for Ford Cars

G&O
Radiators

- MODEL "A" RADIATOR**
Black Enameled Steel Shell. (1917-'21)
- MODEL "A" RADIATOR**
Nickel Plated Brass Shell.
- MODEL "C" RADIATOR**
Finished in Polished Brass. (1914-'16)
- MODEL "D" TRUCK RADIATOR**
Cast Tanks, Multi-tube Core. (1917-'21 Ford Trucks)

*Designed
for Ford Service*

JOBBERs: This is the first time a really high grade radiator for Ford cars has been offered to the jobbing trade at a competitive price. Write us today.

The G & O Manufacturing Co.
NEW HAVEN, CONN.

Beware of imitations. **GENUINE APEX INNERINGS** are so marvelously successful that they are widely imitated. But inferior stock makes imitations worthless. *This tag protects you and us. Do not buy any Innering that does not bear our Guarantee Tag!*

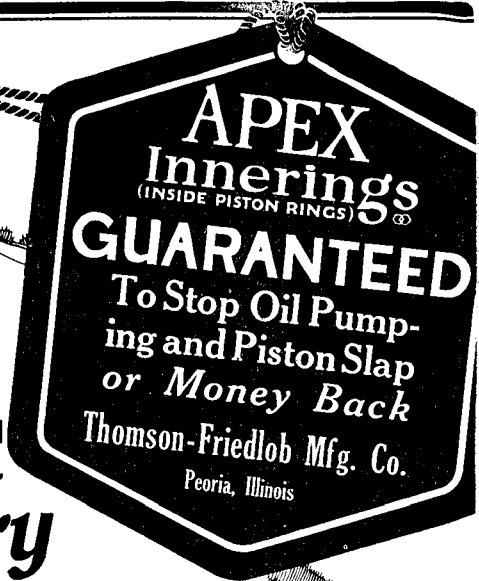

RE-BORING unnecessary

These scientifically engineered devices make used motors run and pull like new, *without re-boring.*

Genuine APEX INNERINGS

save this enormous expense of re-boring cylinders, no matter how bad the condition of the motor may be.

Loose pistons and tapered cylinders make piston rings wear **OVAL** on the face, like this (Oval faced piston rings pump oil, foul spark plugs, lose compression; waste oil, gas.

With Guaranteed Apex Innerings piston rings wear **Straight** on the face, like this | Guaranteed Apex Innerings automatically centralize the piston and give a perfect alignment of the piston ring face with the cylinder wall. *Money back, if, Without Re-Boring, pistons slap or oil pumps through when Genuine Apex Innerings are installed.*

"I was going to have my cylinders re-bored but since installing Genuine Apex Innerings I do not need to do so as the piston slap is gone." S. M. Gearhart, Bolan, Iowa.

"Genuine Apex Innerings have cured a bad case of overheating with which I have been struggling for 2 years." I. Littell, Brg. Gen., U. S. Army, Washington, D. C.

"Certainly find them very fine." Robt. E. McCafferty, Jr., Pittsburg, Pennsylvania.

"They have proven satisfactory in every way." Bland's Garage, Worcester, Penna.

"Just the very thing I have been looking for." F. E. Dodson, Albany, Texas.

Genuine Apex Innerings are guaranteed to **Stop Oil Pumping and Piston Slap**, eliminate fouled spark plugs, increase power, save gasoline and oil. *Order a Complete Set Today!*

THOMSON-FRIEDLOB Mfg. Co.

Dept. A. PEORIA, ILLINOIS

Factory Branch, 58 W. Washington St., Chicago, Ill.

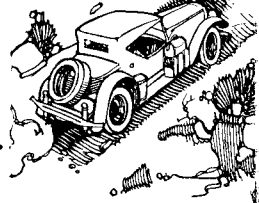

GUARANTEED APEX INNERINGS (INSIDE PISTON RINGS)

Modern Single Coil Distributor Ignition

for the Ford Car at

The New Price of \$14.00 Complete Offers the Ford Owner the Greatest Value in the History of the Ford Car.

The NEW YORK UNI-COIL DISTRIBUTOR IS THE ONE MOST NEEDED, LARGEST SELLING and greatest value giving device yet PRODUCED.

ABOLISHES TIMER
With All Its Accustomed Troubles,
Short Circuits, Oil Soaked Wires
Eliminates Three Coils
and the impossibility of keeping them all uniformly adjusted.

THIS IS THE ONLY SYSTEM that operates from the Ford Magneto or Battery, therefore the car may be driven regardless of batteries' condition which guarantees continuous service—even when battery is removed entirely.

It requires but one-half hour to install on any Ford from 1910 to date and will positively prove a revelation IN SMOOTHNESS, EASY STARTING, extraordinary pulling ability with an entire absence from all the troubles to which you have been accustomed.

Not an experimental unproven device,—the same principles employed in this system are used on America's highest priced cars. In use by thousands of Ford owners for the past eight years.

Furnished complete to
the smallest detail. **\$14⁰⁰**
Price

Made and guaranteed by one of the
oldest Ignition Manufacturers.



NEW YORK COIL COMPANY

338 PEARL STREET

NEW YORK CITY.

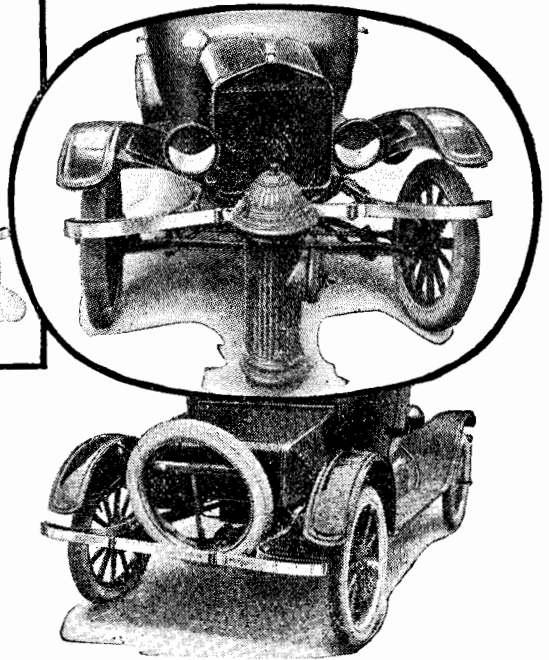
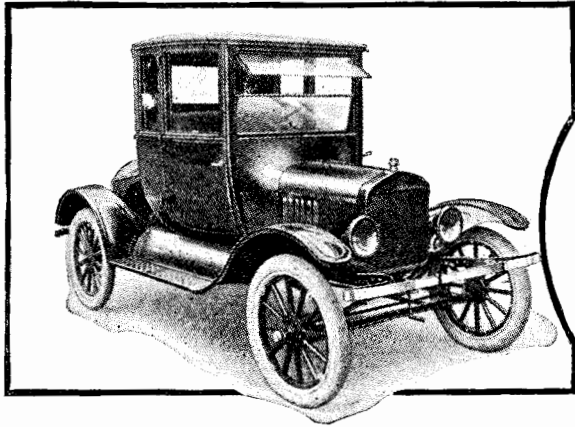

A Genuine Lyon Bumper, specially built for Fords

The Lyon Bumper for Ford cars has all the advantages of the most expensive Lyon Bumpers we make. It is made of the same high grade, oil-tempered spring steel. *No castings.* It is reinforced in front by overlapping leaves. It won't rattle. It won't come loose. *And it has less parts than any other bumper made.*

No other bumper built will take so stiff a blow without having to be replaced. *We guarantee the Lyon Bumper for Fords to withstand a bump at 15 miles an hour without damage to itself or the car.*

Dealers—Tell your jobber today that you want a stock of Lyon Bumpers for Ford cars. If he doesn't carry them, advise us and we will immediately put you in touch with a way to take care of your requirements.

RETAIL PRICES

<i>Front</i>	
Black with Nickel Clips.....	\$10
Nickel with Black Clips.....	\$12
<i>Rear</i>	
Black with Nickel Clips.....	\$11
Nickel with Black Clips.....	\$13

No matter what part of the bumper is struck, *or from what angle*, the famous *Lyon-patented* open looped-ends give like a spring—absorbing the shock instead of passing it along to the car.

You and your Ford ought to have the collision protection that the Lyon Bumper alone can give. Tens of thousands of Ford cars are Lyon-protected.

And remember this: the Lyon Bumper for Fords is built with a new, guaranteed, unbreakable pressed steel bracket that can be attached to any Ford without drilling or alteration—even those equipped with *Hassler Shock Absorbers.*

Jobbers—If you are not already handling Lyon Bumpers for Fords, communicate with us. More Lyon Bumpers are sold than all others put together. Don't overlook this real opportunity to add a real money-maker to your line.

METAL STAMPING COMPANY, Long Island City, New York

LYON RESILIENT BUMPERS

A Ford Deserves a

Willard

Willard does not make a special battery for Fords. On the contrary, every Willard is Willard-quality through and through! Whether you buy a Willard with wood separators such as has given good service on thousands of cars of all makes, or one of the latest-type Willards such as the Threaded Rubber or the All-Rubber Willard, you can be sure it is the

best battery your money can buy.

If you will go to any Willard Service Station or dealer, and inquire the prices of the various types of Standard Willard Batteries made in the Ford size, you will be very pleasantly surprised.

Treat your Ford to a Willard and get "more miles of uninterrupted service per dollar," just as the larger cars do!

Willard Storage Battery Co., Cleveland, Ohio

MADE IN CANADA BY:

Willard Storage Battery Company of Canada, Limited, Toronto, Ontario



Power!

This Lightest-Weight Piston is much lighter than aluminum. One-fourth the weight of cast iron.

For Ford and Dodge Piston Replacement

This sturdy piston, though it weighs less than aluminum, gives more power on hills and more speed on the road.

Taking the place of the sluggish, heavy, power-wasting piston of cast iron, DOWMETAL uses previously wasted power for new speed and economy.

—if you would avoid the hum and buzz of needless vibration—
—if you want a surprising addition to speed—
—if you would make hills on high that you never made before—
—if you care for quicker acceleration at street or railway crossings—
—if you want a wider-driving range with reduced consumption of gas and oil, by all means have DOWMETAL Pistons installed.

Be sure to replace old pistons with this tough, non-scoring, light-weight metal—

DOWMETAL

The Dow Chemical Company
Midland, Mich., U. S. A.

DOW

FORD OWNER and DEALER

MILWAUKEE

WISCONSIN



Vol. 16

DECEMBER, 1921

No. 3

Speaking of Christmas

To many of our keen readers it may appear that, in making use of the winter landscape shown above, we have committed an editorial blunder. On the road is shown a sleigh instead of a Ford car!

This, however, is done with deliberate intent. The picture is shown by way of retrospection and for the particular benefit of those chronic reactionaries who always hark back to some remote past and declare that "those were the days."

Such persons so persist in their views that they cannot catch the true Christmas spirit in modern times. For them, nothing less than a Washington Irving Yuletide rings true. The honking of Ford horns does not take the place of the jingle of sleigh-bells.

The rest of us are more than willing to let the old-time sleigh and cutter pass. We will get far more comfort and lose not a bit of joy in our cozy Fords. By making it better, it makes it no less a real Christmas.

Revel in accounts and memories of the old-time Yuletide, if you will; but bear in mind that in those days they had no Fords. We believe that in it there will be as much sincerity and more warmth as, passing in our comfortable Sedan, we shout forth the old greeting—

"MERRY CHRISTMAS!"

WINTER Car Comfort

HEATERS FOR OPEN AND ENCLOSED FORDS

by Ed. Technical

When the frost is on the pumpkin,
And the fodder's in the shock
Just install a winter heater,
And Jack Frost can't even knock.

Take the chill off frosty winter,
Love your wife with sweet accord.
Turn the damper of the heater,
And it's summer in the Ford!

There is money, as well as romance, for the Ford Agents and dealers in the sale and installation of car heaters. Many car owners would purchase such heaters, if they were advised as to which reasonably priced heaters were suitable for their Fords. And if they could have the installation made by the dealer.

It is suggested that the dealer quote two prices on Ford car heaters—one price for the heater alone. And the other price for the heater installed in the car. After installing one or two heaters the dealer's repairmen become so proficient at the work that they can install a heater with much less trouble and expense than the heater can be installed by the individual car owner. And keeping the repair shop busy in winter, is one of the requirements of good dealership.

And with a winter heater installed, the car owner is far more apt to use his car all winter; thus using more supplies and requiring more repairs. And the greater the number of Fords that are kept on the road during the winter months, the greater is the proven utility of the Ford car in a particular locality. And it is the "proven utility" in a given locality that sells Fords in both winter and spring.

With an exhaust heater fitted in the Ford Sedan or demonstrator, the Ford Agent can make a practice of driving around town in his shirt sleeves while the snow is on the ground. Thus offering convincing proof of Ford enclosed car comfort to the "gentle sex" of whom it has been observed, "winter must be here, the girls are discarding their furs".

Ford Sedans and Coupelets are now being used in increasing numbers, and there are many enclosed top attachments now in use. And all these glass-enclosed cars are logical users of Ford car heaters. After man encloses a house with windows, the next thing that he does is to install a heater. In fact, the history of civilization shows that the heater came before the windows. The glass-enclosed car body is an excellent means of keeping the wind off the passengers—but does

not actually furnish any heat. Though it is an excellent means of retaining the heat furnished by an auto heater.

Since open Fords are so much colder than enclosed Fords, they have an even greater need of automobile heaters. And when a lap robe is used to retain the heat around the passengers, reasonable comfort can be had with a heater installed under the lap robe of an open Ford. Owners of Ford cars are particularly fortunate in that they can obtain heaters to fit under either front or rear seat as required.

KEEPS COLD AIR OUT

While most of these exhaust heaters will warm the car effectively under the proper conditions, no one expects a heater to warm "all outdoors." And so it is almost as important to "keep-the-cold-air-out", as it is to install an effective heater. For this reason, it is necessary to stop some of the air leaks around the floor boards, if the utmost comfort is to be obtained.

This is particularly important in the case of Ford Sedans and Coupelets. But is also important to the driver of the Ford open cars, for if less draft comes in through the floor boards, then the driver can keep fairly comfortable, even though the air may come in through the side curtains of the open car. Improving the wind-proofness of the Ford top will probably be considered in another story.

When cold weather comes, we are soon convinced that there is a powerful rush of cold air through the pedal slot openings and the opening for the emergency brake lever. But there are several good makes of easily attached closures now on the market. Some of these pedal slot closures consist of felt pads, placed over the brake lever and pedal slot openings. These felt pads being tacked down in position, and having slots through which the pedals operate.

Another well made device consists of several strips of thin, elastic rubber, held in place on the floor boards by special metal

plates. This device is called the Presto. Such pedal slot enclosures have the advantage of shutting off engine fumes and noises, from the inside of the car. Thus the engine seems to run more quietly when these pedal slot closures are used.

They also keep the poisonous fumes from the engine from causing the driver sore throat and smarting eyes. And pedal slot closures have the advantage of preventing the loss of small articles dropped on the floor of the car.

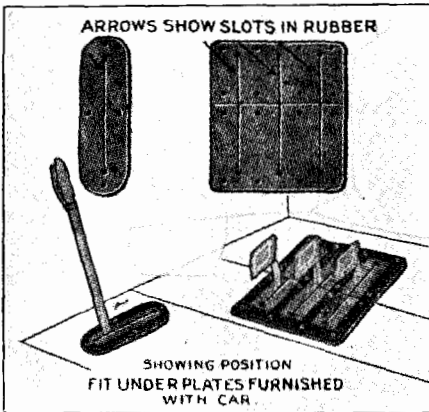

Pedal Slot Closures

If the manufactured pedal slot closures cannot be obtained, then one can make these pedal slot closures by cutting strips of rubber from old inner tubes. If the Ford is one of the older makes, in which the metal plates around the pedal slot openings are fastened in place by wood screws, then these metal plates can be taken off and the strips of rubber placed between the metal plates and the tops of the floor boards.

On account of the thickness of the rubber, it will be necessary to use round head wood screws about a quarter of an inch longer, when this plan is used. After the rubber has been fastened in place, the slits in the rubber can be cut with scissors, or with a sharp knife, and should follow the path that the pedals take when they are pushed forward.

It will be noticed that, while the clutch pedal moves straight forward, the reverse and brake pedals move in a *slanting* direction, so that it is desirable to cut these slits along the lines of this movement so that the pedals can be moved freely and easily, without spreading the rubber flaps too far apart.

In the case of the newer Fords, the metal reinforcements around the pedal slot openings are of sheet steel and pressed down in around the openings. It will not be so easy to fit the rubber over the floor boards, or between the floor boards and the metal plates of these newer Fords, and it may be a better plan to tack the sheet rubber in place on the *under* side of the floor boards. And then use little metal plates, which can be obtained at the local Tiffany's (sometimes called the 5-&10 cent store). By screwing these metal plates to the floor boards, they will hold the rubber

in place much more firmly, so that the rubber will keep the openings closed.

HOT AIR HEATERS

Summer experience has taught us, beyond the possibility of a doubt, that the Ford engine has sometimes a very strong tendency to heat the front seat compartment of the car. And in our summer issues, we have described some of the methods of preventing this overheating of the front seat compartment.

Consequently, the "bright idea" has occurred to some owners to heat the front seat compartment in winter by removing the metal plate under the coil box. But while this plan works well enough in summer, it is of no practical value for winter use.

The trouble with this plan is that there is too much of a rush of cold air, during the first couple of miles while the engine is getting warmed up. And to make a heating device of this sort practical, it is necessary to

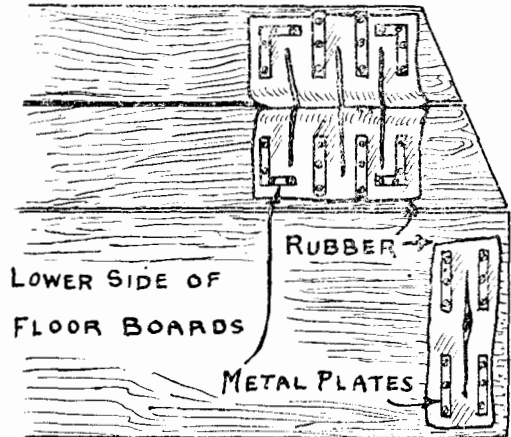

Excludes Cold Air

be able to control the flow of air.

If one keeps the cover over the radiator so that the radiator becomes hot, and then only allows a limited amount of air to flow through the radiator, by just uncovering the upper half of the radiator, it is possible to secure some heating effect.

The value of the Apco heater consists in the fact that this heat register can be used to control the amount of air in the car. Instead of removing the metal plate in the coil box, the Apco heater consists of a metal register fitted into the slanting floor boards. And this register can be opened or closed, at the will of the driver. By keeping this register closed, and the cold air out, until the engine warms up; and then opening the register to admit air from the well-warmed radiator and engine, one can secure much better heat efficiency.

In using any of these heating methods, which take hot air from around the exhaust manifold of the engine, one should make sure that the exhaust pipe packing nut, the gaskets of the exhaust manifold, and the valve chamber covers are tight, so that no unpleasant fumes from the exhaust will vitiate the air entering the car.

Since the exhaust manifold sometimes becomes red-hot, it is evident that this is an effective source of heat. And many heaters have been devised to collect the heat radiated from the manifold and front end of exhaust pipe, and to conduct this heated air into the front seat compartment of the car.

One important advantage, of this "hot-air" method of heating, is that there is no chance of such a heater becoming clogged with carbon, as only clean, fresh air flows through the heater. And the regular flow of the exhaust gases through exhaust pipe and muffler is not changed in any way.

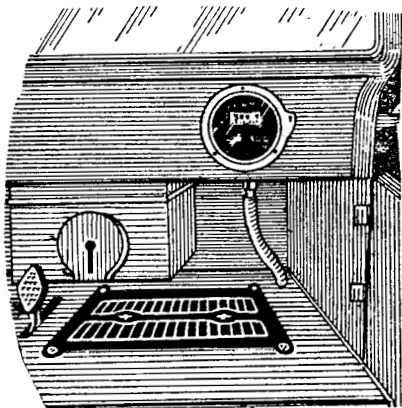

Hot Air Register

But the chief advantage, of these "hot-air" heaters, is that they give ventilation, as well as heating. Which is especially important in the case of Ford Sedans and Coupelets, which have been made practically air tight.

The chief disadvantage is (unless the car is well closed) that this indirect heating method may not give quite as much heating effect as may be desired. But there is nothing to prevent these combination heater-and-ventilators being used in connection with an exhaust heater, if the utmost heating effect is to be obtained.

Another advantage, of heating the interior of the Ford car, is that this tends to eliminate the frost and ice which sometimes collect on the inside of the glass of an unheated Ford, and which make it impossible for the driver to see where he is going.

The Kingston heater consists of the metal shell surrounding the exhaust manifold, and taking in fresh air at the front end of the engine. This fresh air is effectively warmed up by passing over the entire length of the exhaust manifold. From the rear end of this heater, the heated air is conducted to a register located in the slanting foot boards of the front seat compartment. This register can be controlled by a touch of the driver's foot, and kept closed until the engine warms up.

Such heaters have the valuable advantage of admitting fresh air, as well as warm air, to the car. This is especially desirable for winter driving as ventilation is needed, if the enclosed car is to be kept as pleasant and as healthful as it should be. These heaters are easily installed without making any changes on the engine.

Another interesting hot air heater is the S-J, which consists of the metal shell encasing the hottest part of the exhaust manifold, and almost the entire length of the exhaust pipe. In this manner, nearly all of the heat, which would be otherwise wasted, is used to warm the fresh air enters through the front of this heater. And this heated air is led into the rear seat compartment of the touring car, or into the Sedan by the register placed in the floor boards.

Another form of hot air heater is called the Slip-On, which consists of the metal box surrounding the hottest part of the exhaust pipe. The front end of this heater is fastened to the dash. And there is the hot air register which can be opened to control the amount of heat admitted to the front seat compartments of the car. This device is so made that, in summer, the partition at the back end of the box can be removed, so as to provide a certain amount of cooling effect for the car.

One of the new makes of hot air heaters, which obtain heat from the manifold, is the Francisco heater. This heater consists of a metal shell surrounding the exhaust manifold of the Ford car. The hot air comes into the car as soon as the exhaust manifold begins to warm up.

One advantage claimed for these heaters fitting over the exhaust manifold is that they

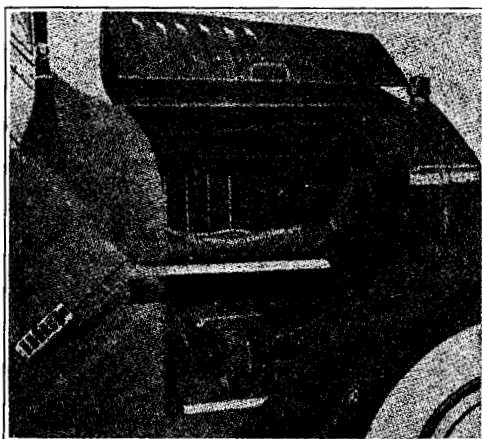

Kingston Heater

make it unnecessary to cut the exhaust pipe, or to fit a valve to divert the gases into the heater.

The heater also acts to a certain extent as a combination manifold, to secure better vaporization of the fuel and make the engines run more smoothly and evenly in cold weather, with the carburetor at summer adjustment during the winter months.

Another interesting type of heater, which takes the heat from the exhaust manifold is the Arvin. This heater is easily installed, being simply clamped in place by metal lugs fitting between the manifold and clamps. The fresh air enters at the front end of this heater and is directed into the front seat compartment of the car, through hole cut out in the slanting floor boards. A damper, at the floor board end of this heater, controls the heat as desired by the driver.

The heat is forcefully driven back into the car by the draft of air of the fan, and by the forward motion of the car. No mechanical changes are necessary, except to cut the upper floor board, according to the pattern furnished with the heater.

The Moore heater consists of a metal shell extending over the exhaust manifold and also extending down and partly covering the inlet manifold. Consequently this heater helps to warm the inlet manifold, as well as the passengers in the car.

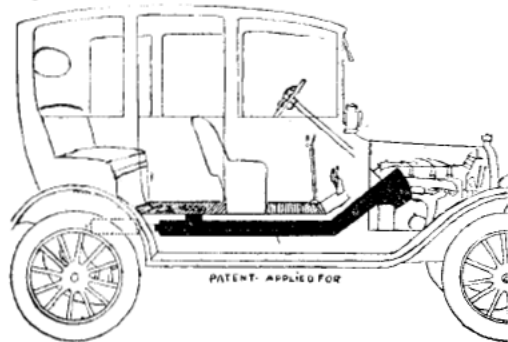

S-J Heater

The opening for this heater extends through the dash board of the car, where a damper is located, which can be easily opened or closed by a touch of the foot on the handle of the lamper.

The Manex heater also fits over the exhaust manifold. As soon as the motor is started, the manifold becomes hot from the exhaust and the heater is ready for use. The warm air rises to the top of the air chamber and is carried back through the car through an opening in the dash, just above the level of the floor.

The Manex is installed by cutting a 2- $\frac{1}{2}$



Arvin Heater

inch hole through the dash with a key-hole saw or extension bit. The air chamber is held over the manifold by two lugs which fit under the standard Ford clamps.

By conducting the air through the dash, this eliminates cutting holes through the floor boards, which might weaken the floor boards or cause trouble in removing the floor boards, or replacing them.

The Ward heater and ventilator is installed without removing or cutting the exhaust pipe. This heater is made of heavy gauge metal and fits around the exhaust pipe, and takes in fresh, outside air, which is heated on the principle of the hot air heater. This heated air is conveyed through flexible metallic tubing to the "flush-with-floor" register.

The bad air in the car is carried out of the car through a ventilator. The heater is controlled by a valve, regulated from the cowl dash of the car, and within convenient reach of the driver.

EXHAUST HEATERS

Exhaust heaters take part of the gases from the exhaust pipe and conduct them to a register located in the floor boards, or within the car. These heaters tend to heat up by direct radiation, as well as by indirectly heating the air. Such exhaust heaters do not require any fuel or attention other than turning them "off" or "on", or cleaning out the carbon which may accumulate during the winter.



Moore Heater

The exhaust heaters do not detract from the power of the engine in any way, but rather tend to add a small amount to the power in that the additional escape for the exhaust gases from the heater tends to act, to a certain extent, as a muffler cut-out and so gives the exhaust gases an easier opportunity to escape.

Exhaust heaters can be roughly divided into three different classes. First, there is the "flush-with-floor" type, in which the heating coils or pipes are placed below the floor, and the grid or register allows the heated air to pass upward into the car. This flush-with-floor heater saves space in such a small car as the Ford, and reduces the possibility of tripping those getting into or out of the car. But of course the carpet usually has to be cut to allow space for the heater. And dirt tends to drop down into these heaters, making it necessary to clean them out often though provision for this purpose is usually made.

The second type of heater is the "vertical" type, which is placed between the floor and the edge of the seat cushion, where the heater takes little space and is up out of the way. Such heaters can also be placed behind the back of the front seat of the Ford touring car and thus used to heat the entire car. But the usual method is to place them under the front edge of the seat cushion, where the hot air will be kept under the lap robe, and thus furnishes the greatest comfort to the passengers. Such heaters are especially convenient for the Ford Coupelet.

The third class of exhaust heaters is the "foot-rest" type in which the heater acts as a foot rest and applies the heat directly to the feet of the passengers. A metal shield or guard covers the heating pipes and keeps the lap robe and one's shoes from burning.

One of the chief advantages of the foot rest type of heater is the ease of installation, it being only necessary to bore two holes through the floor board, one for the pipe to the heater and the other to allow the gases to escape from the heater. Such heaters are usually less costly in the first cost and in the installation, than the flush-with-floor type heater.

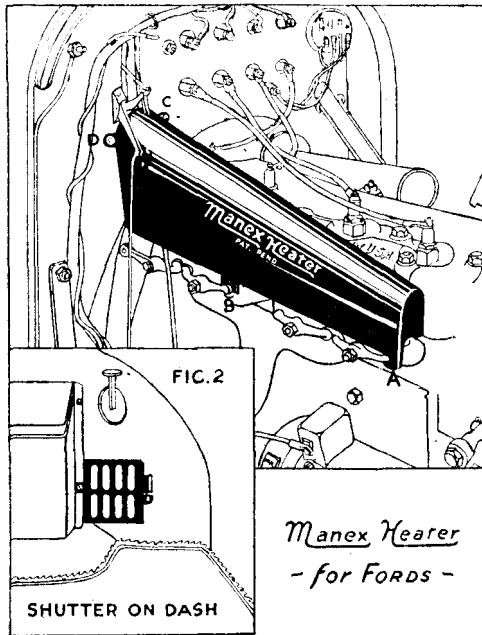

Manex Heater

A well-known make of "flush-with-floor" or "register" type of heater, is the Utility Junior. The Ford size of this heater is twenty-seven inches long. In this heater, the connection to the exhaust pipe is made by means of flexible metallic tubing, which makes installation easy. And the valve is easily controlled by the driver by means of a flexible cable mechanism.

Another interesting "flush-with-floor" heater for Fords is the Superior heater. This comes complete, with extra heavy floor board. The heater is already fitted to the floor board, and this plan of supplying heater and floor

board "complete" makes the installation of the heater comparatively easy.

For summer use, the old floor board can be replaced, thus saving the heater for winter use. The heat is controlled by means of a special pipe, which clamps on the exhaust pipe, and controls the amount of heat that goes into the heater.

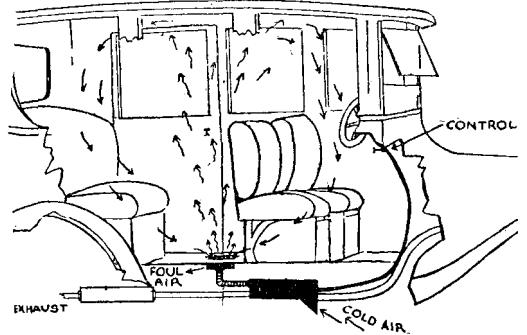

Ward Heater

As Ford cars are used but little for "pleasure" driving in winter, and the majority of winter Fords are used for business purposes, the occupants are usually in the front seat. For this reason, the heating of the front seat compartment is usually the most important. This applies to the roadster, touring car and Coupelets. And the Sedan is really the only model in which the heating of the back seat compartment affords sufficient comfort for the driver.

The Temme "flush-with-floor" heater has three parallel pipes fitted with heat radiating flanges. It will be noticed that the air from the inside of the car enters around the sides of the heater. This air is warmed by the contact with the hot tubes, and then ascends upward from the middle of the register.

The heater housing is 8x18 inches and drops three inches below the floor level. In this heater, the tubes and headers are cast in one. This prevents the possibility of gas fumes leaking into the car from leaky joints. Such

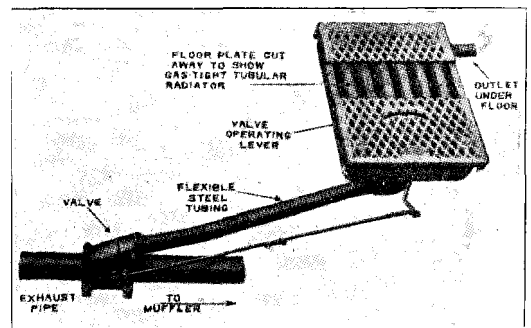

Exhaust Heater Valve

heaters can be washed out with the hose without injury to the heater. And there is a "clean-out" door at the bottom of the heater casing for the removal of such dust and dirt as works down through the register.

For use in Sedans and Coupelets, the FS Perfection heater is made to fit flush with the

floor of the car. And will supply sufficient heat to keep the car comfortably warm. This heater is made by the same company which makes the heaters which are standard equipment on some of the most expensive enclosed cars.

The heater occupies a floor space of $8\frac{1}{2}$ x $12\frac{1}{2}$ inches. And a clearance of $2\frac{1}{2}$ inches at the middle below the car floor is necessary. The connection to the exhaust pipe is made by means of flexible metallic tubing, and the gases circulate through the metal tubes located in the register. The heat control valve is located at the exhaust pipe connection, and is operated by a rod from the heater.

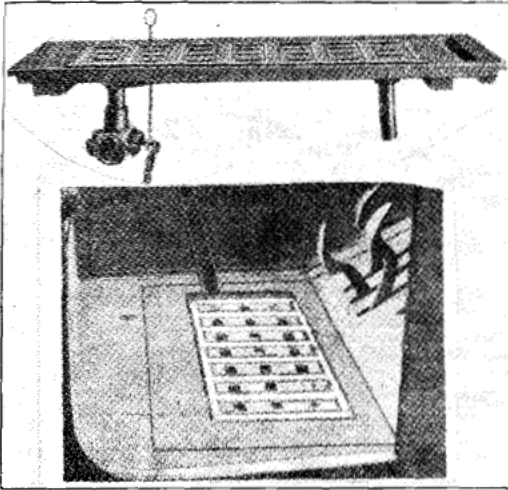

Superior Floor Heater

The Sanitary heater is of the low price type, and is placed flat on the floor. And has a removable sheet metal cover making it easy to install or clean. On account of its low, bevel shape, this heater acts as a convenient foot rest, and can be used in either the front or rear compartment of the Ford car.



Flush-with-Floor Heater

The Utility Junior foot rest heater is one of the most generally used heaters in Ford cars. This heater affords a comfortable foot rest and is properly protected with a metal shield

to allow the heat to circulate, without burning shoes or lap-robe. This heater is finished in black, and made to sell at a low price, and is easily installed.

The vertical type of heater fits between the floor boards and the front edge of the seat cushion. An efficient heater of this type is the Perfection type FT, which is designed for installation in either the rear compartment of the Ford touring car. Or it can be installed in the Ford coupe or roadster, by moving the starter button and bracket forward three inches. This is the same general type of heater which is so extensively used in taxicabs.

CUTTING THE EXHAUST PIPE

Cutting the exhaust pipe may be an easy or difficult undertaking, depending on the manner in which one goes about the work. The method of cutting the exhaust pipe is determined by whether one wishes to cut a "round" or "square" opening in the pipe. Some heaters require a round opening, and others a square or oblong opening, to direct the maximum amount of hot exhaust gases into the heater.

The exhaust pipe is rather long, and is supported only at the front end and at the muffler. The exhaust manifold pipe can be easily weakened by careless cutting so that it will vibrate and rattle against the emergency brake control shaft.

When we wish to break a stick, we cut a sharp-angled notch in it. And we know it is only necessary to cut half-way into the tree, in order to fell the tree. The "nick" concentrates the strain at that point, and causes the wood to break more easily. The same principle applies to a sharp-angled notch in the exhaust pipe. And the pipe is far less apt to crack and break if the corners of the cut are "rounded" off.

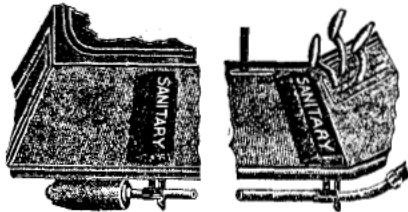

Sanitary Floor Heater

Much of the effectiveness of the exhaust heater depends on the neatness in which the opening is cut in the exhaust pipe. If the edges of the cut are rough and "ragged", this will interfere with the flow of gas. And some of the hot exhaust gases may escape around the fitting, instead of passing through the heater. So smooth off all "wire" edges with a file or sandpaper, before clamping on the heater connection.

A customary method of cutting the opening of the exhaust pipe is to make two slanting cuts with a hack saw, making a broad V-shaped opening. Then the sides of this V-shaped opening are rounded out with a round file, as shown in the "dotted" lines of the sketch. This makes a good form of opening. But, if not filed, then the pipe is apt to break across the bottom of the notch.

To cut a rectangular opening in the exhaust pipe, one can make two vertical cuts at the ends of the proposed opening. And then make

two slanting cuts, overlapping each other. This will leave two small, "triangular" projections, which can be readily filed off.

If we do not wish to do any filing, we can make two vertical cuts at the ends of the opening. And then make one diagonal cut, from the corner of one of the vertical cuts, across to the opposite corner of the other vertical cut. This will leave two triangular metal fins which can be "bent" outwardly from the cut, and then cut off with the hacksaw. In this manner a large, rectangular opening can be quickly cut in the pipe.

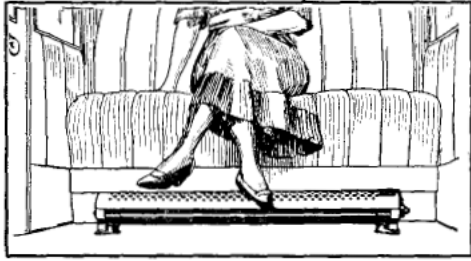

Foot Rest Heater

While these remaining flaps of metal can be cut off with the cold chisel, the use of the chisel is not recommended, as it is too apt to make a "ragged" cut and to bend the pipe out of round. This will make it difficult to make the connection so that it will not leak.

In locating the heater, it is usually advisable to install the heater so that the heater is kept under the lap-robe. For if the feet are kept warm and dry, one can be comfortable in almost any weather conditions. By using the heat this way, sufficient heat will be obtainable for comfort, even on short rides, when the engine is becoming warmed up.



Vertical Type Heater

Doctors tell us to keep our feet warm and our heads cool. And placing the heater under the lap-robe helps us to observe this fundamental rule of health.

In the case of the Sedan, where a single "flush-with-floor" type of heater is used to supply heat for all the occupants of the car, then the heater can be placed midway between the front and rear seats.

ORDERING EXHAUST HEATERS.

It is fortunate for the owners of Ford cars that there are so many Fords in practical use that heater manufacturers have developed special heaters for easy installation on Ford cars. While it is necessary to cut an opening in the exhaust pipe, this does not result in weakening the pipe if the fitting is properly clamped, as the fitting clamps around the pipe, acting as a brace or reinforcement.

When the heater is installed "flush-with-floor", it may be necessary to install the heater at one side if the heater is rather deep. Then the drive shaft housing will not bump against the bottom of the heater, when the rear spring is compressed, as the car is driven over rough roads.

The installation of some of these "flush-with-floor" types of heaters has a tendency to weaken the floor boards, unless the ends of the floor boards are braced with cross strips of wood. Though, the fastening of the heater in place has some tendency to strengthen the floor boards, if the heater is securely fastened to the boards.

When connecting the heater to the exhaust pipe, one should endeavor to place the connection as far "forward" on the exhaust pipe as

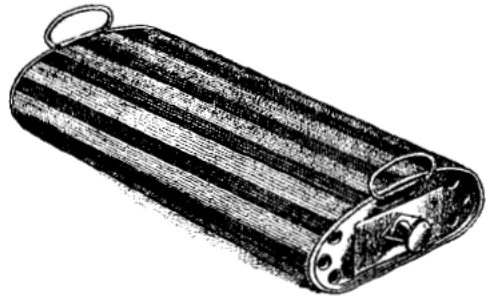

Compressed Fuel Heater

possible. In cold weather, the exhaust pipe is rapidly cooled, by the cold air passing beneath the car, so that the exhaust gases become rapidly cooler as they proceed to the rear towards the muffler. As a result of this, it is necessary, if we wish to get effective heating, to take the hot gases from as near the "engine end" of the exhaust pipe as possible rather than the cooler gases from further to the rear towards the muffler.

In ordering exhaust heaters, it is necessary to consider the type of body in which the heater is being installed. Some heaters will fit only the touring car or roadster, while other heaters, due to the use of flexible metallic tubing for making connections or other features of design, will fit in any of the regular Ford body models.

There is a difference in the height of the floor of the Sedan and Coupelet bodies from the exhaust pipe, as compared with the distance between the floor of the touring car and roadster and the exhaust pipe.

As the Ford enclosed car bodies have been built by different body makers, there is sometimes a slight difference between the different makes of Sedan bodies. The 1915 Ford Sedan, for example, was considerably lower and closer to the exhaust pipe than the present Sedan bodies.

As the result of this, it is desirable to mention both the year and the type of body in which the heater is to be installed, when ordering certain makes of heaters. It is really a wise precaution to specify both body model and year of car when ordering any heater.

When ordering heaters in which the connection between the heater and the exhaust pipe is made by means of flexible metallic tubing, this tubing usually has sufficient flexibility to compensate for any variations in distance between the exhaust pipe and floor of car which may exist. And when ordering heaters of this kind, it is only necessary to mention what type of body the heater is for.

COMPRESSED FUEL HEATERS

In the old carriage days, frequent use was made of foot warmers, using bricks of compressed fuel or charcoal, which gave considerable heat yet burned without flame. Some of these compressed fuel heaters can be ignited with a match, as the fuel is in a soft "pulverized" form that is easily lit. Other compressed fuel heaters use carbon blocks, which must be heated red-hot in a stove, in order to start combustion.

The chief advantage of these compressed fuel heaters is that they furnish heat—even when the engine is stopped. And the heater



Steering Hand Warmers

can be placed in the car, so that the car will be nice and warm when the driver first gets into it. Some owners use these compressed fuel heaters as auxiliaries to the exhaust heaters, and this plan gives a very comfortable combination.

Another use for the compressed fuel heater, when the passengers get out of the car, the heater is placed inside of the hood next the engine. Thus keeps the engine warm and insures easier starting. But as some carburetors leak, this plan involves considerable fire risk; especially if one pulls out the priming wire and attempts to start the engine, without first removing the heater. And while there is no "open" flame in these heaters, still the red-hot fuel will easily ignite the gasoline vapor, if the vapor happens to be present in sufficient quantity.

The chief disadvantage of the compressed fuel heaters is the trouble that it takes to get them started. And few car owners wish to bother putting the coal in the stove fifteen minutes or so before going out, unless they are going to use the car for the entire day.

Another important disadvantage is the cost of the fuel that is used. For if the heater is used all day and in the evenings, a considerable amount of fuel can be burned in the course of the week. But if one only uses the car for important occasions, such as taking

one's best girl to the theatre, then this type of heater may not cost too much to maintain.

Now that so many Ford cars are fitted with electric starting and lighting systems, it is feasible to use steering wheel hand warmers, which use electric current from the storage battery, or Ford magneto.

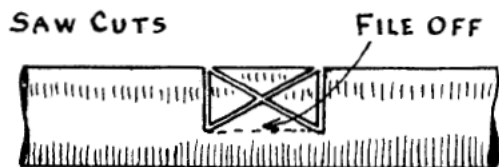
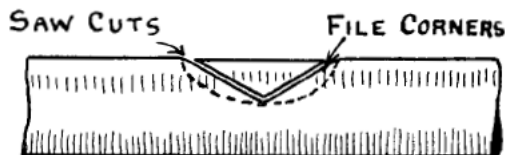

Cutting Exhaust Pipe

On Ford cars fitted with electric starting and lighting systems, no current is taken from the Ford magneto for lighting the headlights, and so this two amperes of headlight current is available for use in the steering wheel hand warmers. Some of these hand warmers are intended to be connected to the Ford magneto and take 2- $\frac{1}{4}$ amperes, which is practically the same amount of current taken by the headlights.

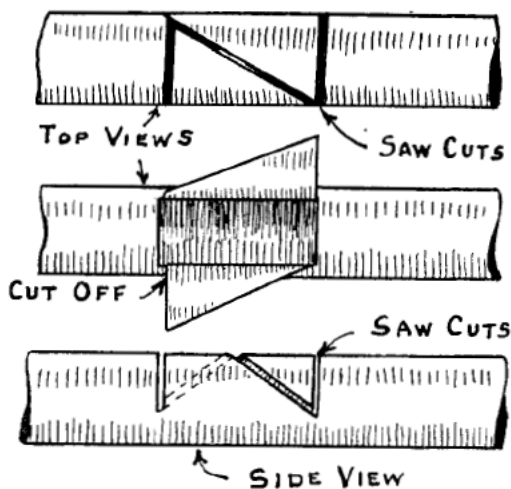

Cuts Large Opening

On Ford cars fitted with electric starting and lighting systems, it is recommended that the magneto type of hand warmers be used, as this eliminates taking current from the storage battery, and thus leaves the full power of the storage battery available for starting and lighting.

Accessories for Easy Starting

THE two fundamental requirements for easier starting are a "hot" spark, and a mixture of fuel-and-air which contains enough gasoline vapor to burn. If the proper fuel and spark are present then the engine will start, even if it is only cranked very slowly. As a matter of fact, a Ford engine will almost start "on the spark" if the spark and vapor are present in the proper proportions.

The third requirement is, of course, that the engine be cranked at a fair rate of speed. For when the engine is cranked very slowly, then there is but little **compression** in the cylinders and the fuel charge does not ignite so easily as when the engine is cranked at a fair rate of speed.

The majority of Fords in everyday use, during the cold weather months, are those used for **business** purposes. And many of these commercial Fords are not fitted with electric starters. When a man buys a car for pleasure, he generally wishes to add to the pleasure of the car by fitting an electric starter and lighting system, as much of the "pleasure" driving of Ford cars is done after dark.

But when the car is used for such "commercial" purposes as delivering meats or groceries, or by salesmen, then the car is most used during the day time, and the lights from the electric starter are not in such demand. And when the car is a "business-proposition," the owner is inclined to figure on a dollars-and-cents basis, and that the electric starter adds to the cost of operating the car.

When the Ford engine is cold, it is very difficult to crank and so we should do all we can to make starting easier, either for hand cranking, or when an electric starter is used. While an electric starter is one of the chief aids to easier starting, it is not always successful in starting the engine promptly. When a good spark and a rich fuel mixture are present, and when an electric starter is used; then the battery of the starter furnishes a hot spark at the spark plugs. Consequently, the chief additional requirement, on the electric starter Fords, is some form of primer for introducing more fuel to the cylinders, or else some kind of a heater for the manifold.

If the Ford car is one of the earlier models, and the cylinder block and the transmission cover are not designed for the fitting of an electric starter; then one may wish to install one of the special electric starting systems, which are designed for easy installation on the older types of Ford engines without the necessity of extensive replacement of parts.

If the Ford engine needs a new cylinder block and extensive overhauling, then this is an opportune time to install a regular Ford electric starting and lighting system.

When the Ford starter is used, it is important that a rich mixture is introduced to the cylinders as otherwise, all the charge may be drawn out of the storage battery, making it necessary to resort to the old-fashioned method of hand cranking. Also, it is detrimental to the storage battery to draw any more current from the battery than is absolutely necessary. For though the Ford starter is usually powerful enough to crank the engine, even in the coldest weather, still simply cranking the motor is not sufficient if the fuel mixture is not rich enough to ignite.

When all the electric lights are turned on, the current taken from the battery is only about five amperes. In summer, the current required for starting the Ford engine is somewhere between 75 and 100 amperes. But in winter when engine is cold and stiff, then the cranking current required will be anywhere from 200 to 400 amperes. And this tremendous flow of current is a severe strain on the reserve strength of even the best storage battery. If we furnish a good fuel mixture to the cylinders, so that the engine fires on the first turn or so, this will do much to reduce the strain on the storage battery, and will lessen the depreciation from this cause.

Another aid to easier starting is to install one of the mechanical starters, which increase the leverage and make it more easy to crank the engine at a good rate of speed.

The installation of one of the multi-speed transmissions, as described in a recent issue of this magazine, is a remarkable aid in making it easier to crank the Ford engine at a good rate of speed for the reason that all of these multi-speed transmissions provide a really "free" neutral which eliminates the "drag" of the high-speed clutch.

It is not so much the friction of the Ford cylinder walls or parts of the engine, as it is the friction between the twenty-five discs of the high-speed clutch, which is the real cause of the difficulty of cranking a Ford engine. The discs of the high-speed clutch only separate a few thousandths of an inch when released, and so the congealed oil tends to gum these clutch discs together. This is proven by the greater ease with which the Ford engine can be cranked when one rear wheel is jacked up, in spite of the additional friction of the drive shaft, differential, and differential gears.

With the "free neutral" provided by a multi-speed transmission, the Ford engine can be as easily cranked as the engines of other cars. And as a good cranking speed is of great assistance for easier starting, these multi-speed transmissions are helpful for use on either the hand cranked or on starter equipped cars.

As we have just decided that the oil between the discs of the high-speed clutch is one of the causes of hard starting, we thus find that the use of a "light" grade of oil, which does not congeal at low temperatures, and flow freely at Zero is of considerable help for easier starting.

GOOD IGNITION.

When the fuel charge is cold and poorly vaporized, that is just the time when an especially good spark is necessary to fire the charge. If a hotter spark can be obtained by the use of a high-tension magneto, or one of the special battery ignition systems; then this special ignition system will prove an effective aid to easier starting in cold weather.

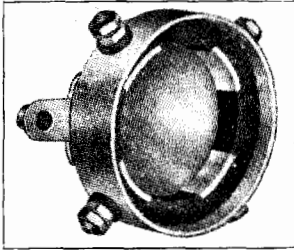

Good Timer

Experienced Ford repairmen know that timer troubles are one of the chief causes of hard starting in cold weather. And if one can not hear the coil units buzzing when the engine is cranked, it is generally safe to assume that the timer is at fault. The installation of a really good timer will do much to reduce this possibility of trouble.

The requirements of a good timer are; it should stay clean and smooth, and the contacts shall be so arranged that the roller or brush will not be separated from the contact segments by a film of oil. Some timers, to eliminate this lubrication trouble, are doing away with the oil on the contact points altogether. While other special timers use an extra heavy spring, or some form of roller which cuts through the film of gummed oil and makes good contact, even when the engine is cold.

As moisture may get into the fiber or other insulating material of a cheap timer, it is advisable to buy a "good" timer, in which moisture-proof insulating materials are used. The timer has such an important effect on the smooth and powerful running of the engine, that there is no economy in buying any but the best timers which can be obtained.

The fitting of the timer elevating attachment brings the timer "up into the light of day" where it will be easy to inspect and clean the timer when hard starting troubles develop. The fitting of the timer elevating attachment holds the timer in such a position

that the oil tends to "run off" the contact segments, and so the action of an elevated timer is less apt to be interfered with by cold, congealed oil on the segments.

COIL BOX TROUBLES.

When snow collects on the cowl dash, or if rain gets between the dash and the body of the car; then this moisture may work down onto the wooden back of the coil box; where it will cause short circuits of the high tension terminals and thus keep the necessary spark from reaching the spark plugs.

FRONT VIEW

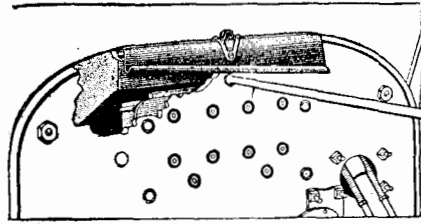

BACK VIEW

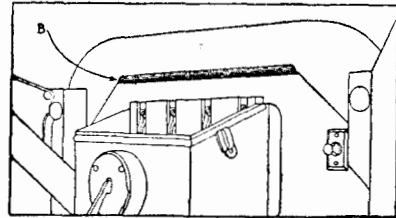

Coil Box Protector

If the back of the coil box becomes water-soaked, it will probably be necessary to remove the coil box from the car; and to dry out the coil box in an oven, before the engine can again be started.

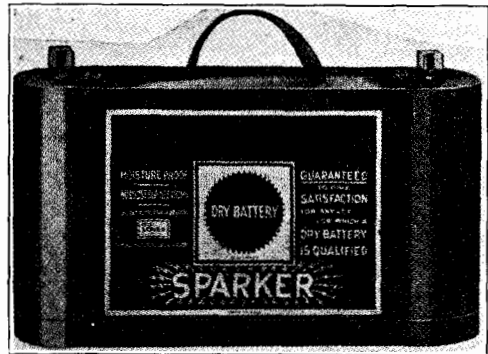

Battery Set

It is much easier to keep the water out of the coil box, than it is to "dry out" the moisture after it once gets in. Special shields are made which fit over the dash and have a little trough, which catches the water under the hood. This trough drains the water off on one side, so that it does not get onto the porcelain insulators of the coil box.

Some of these coil box protectors are also made with another steel strip, extending across the back of the dash, which prevents any moisture getting down between the dash and coil box. Other coil box insulators have rubber bushings, which fit around the porcelain insulators where they project through the dash, and thus prevent the ingress of moisture at this point.

Another method of keeping the moisture away from the coil box consists of a hood apron, or fabric cover, which fits over the joint between the cowl dash and hood, and thus keeps the water from leaking through at this point.

BATTERY IGNITION.

One of the greatest aids to easier starting in the cold weather is the installation of a set of dry cells or a storage battery in the car.

The advantage of a battery is that it gives an equally hot spark—no matter how slowly the engine is cranked. While the Ford mag-

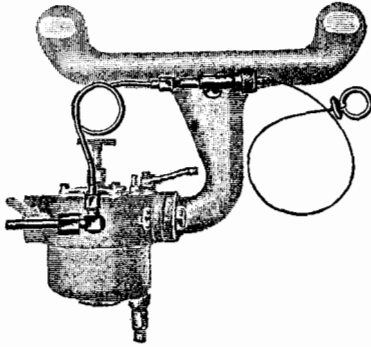

Typical Manifold Primer

neto will only give a good spark, when the engine is cranked at a fairly high rate of speed. And this is not always possible when the engine is cold and stiff. When the Ford is fitted with an electric starter, the current from the electric starter storage battery can be used for furnishing a "hot" battery spark for easier starting.

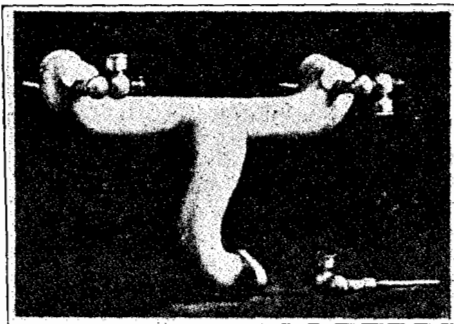

Manifold Priming Cups

As it is not always convenient to get a storage battery recharged, and as the storage battery is very heavy and costly; it is often found more convenient to install a set of dry cells for winter use. If one uses a set of five or

six, "standard" size dry cells for starting, one should not forget to switch over to the magneto after the engine has once been started. Then these batteries will give good service for a year or so of use.

Some of the battery manufacturers are now making dry cell batteries sealed together in a special case, with all the connections between the different cells already made. Such a complete battery probably costs about 40 or 50 cents more than buying the separate cells, but the complete battery has the big advantage of eliminating trouble of loose connections between the separate cells and will be found much more satisfactory for the use of the average car owner. By using batteries of the standard No. 6 size, it is better to buy the

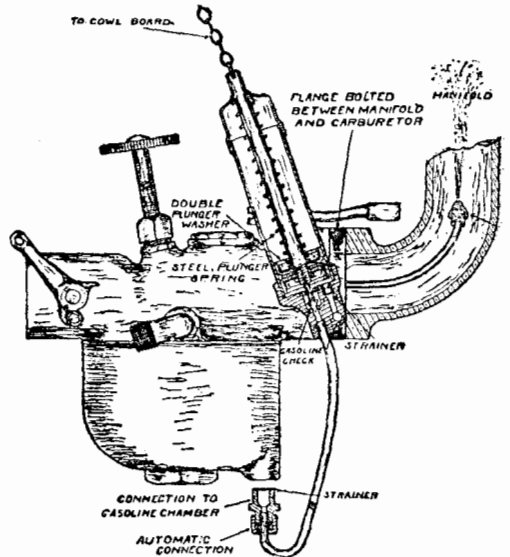

Pump Sprays Fuel

"ignitor" type of batteries, as these give a stronger current. For when the current for ignition is wanted, it is wanted badly, and the ignition type of battery is more powerful than the door-bell type, which give a weaker current but which last a longer number of years.

When using dry cells, the standard size is No. 6 which sell for about 35 cents each. It is advisable to connect about five of these cells in a series to furnish easier starting with the Ford ignition system. If the Ford coil units are "delicately" adjusted, with a rather weak tension then the Ford engine can be started on four of these dry cells. But if the tension of any of these coil units is a little "stiff," then the engine will start more easily on five dry cells, and five is the number which we recommend. When six dry cells are used, this gives an even more energetic spark, but the current from the battery is used up too rapidly, and the extra cell is really not needed.

CAUTION. Be very careful not to touch the "battery" wire to the same terminal of the coil box to which the "magneto" wire is connected. For that would allow the current from the battery to flow through the windings of the magneto coil assembly, and this would weaken or demagnetize the magnets.

One should also be careful that the coil box switch is in good condition and that, when passing from "magneto" to "battery" side, the switch plate does not make contact with both sides at once. As this would connect the battery current to the magneto and weaken the magnets.



Dash Priming Tank

CAUTION. When the battery current is used for ignition, retard the spark lever "all-the-way-up" as a greater retard is needed than when starting on the magneto. When battery ignition is used for starting, the timer should be so adjusted that the center-to-center distance, between the commutator pull rod, and the bolt holding the timer retaining spring is just $2\frac{1}{2}$ inches.

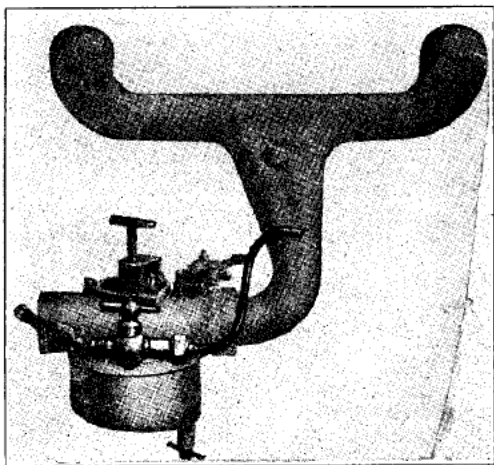

Gasoline for Priming

The reason that the timer must be retarded further for "battery" than for "magneto" ignition is due to the fact that the magneto spark never occurs except when the crank shaft is turning at a fair rate of speed. Consequently, the inertia of the flywheel will carry the engine over a slight advance of magneto spark without causing a back-kick. But as the battery spark can occur at very low speeds, then the flywheel will not have much inertia, and the engine can back fire if the spark is not fully retarded.

RICHER MIXTURE.

Present available fuel contains about 50% of kerosene, and in a cold engine the kero-

sene part of the fuel does not evaporate until heated, consequently it is necessary to inject several times as much "liquid" fuel in the engine when starting, as is needed for running after the engine has once become warmed up. When we speak of a richer mixture; the mixture itself, or vapor charge, is not really "richer." This simply means that it is necessary to inject more "liquid" fuel to get a "vapor" mixture of fuel-and-air that is of "normal" strength.



Priming Spark Plugs

Some of the special carburetors are so designed that they give what is called a "richer" mixture for easier starting. As fuel conditions have changed so much in the past few years, it is necessary to have an up-to-date carburetor, designed for present fuels, if the best results are to be obtained in easier starting. By securing a greater "choking" effect or better "vaporization" of the fuel and a more evenly divided spray, such carburetors can very often give easier starting, and greater fuel economy when the engine is running.

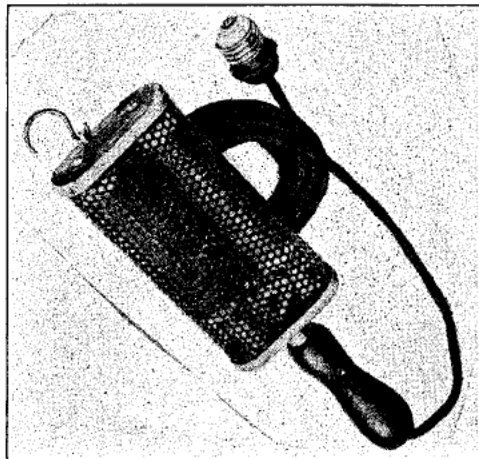

Electric Manifold Heater

A good carburetor also saves the fuel by aiding to start the engine more promptly.

When the regular Ford carburetor is used, then it will be easier to start the engine if some form of carburetor adjuster is used. This will enable the driver to open the carburetor adjusting rod for several full turns

for starting the engine. Some of these carburetor dash adjusters are made which attach to the cowl dash board and so enable the driver to reach and make the adjustments very easy.

Some carburetor dash adjusters have an indicating "dial", by means of which the driver can set the carburetor at the same figure each time, which has been found by experience to give easier starting. If one attempts to both start and run the engine on the same carburetor adjustment, either the starting or running will be done very badly indeed. For starting in cold weather,

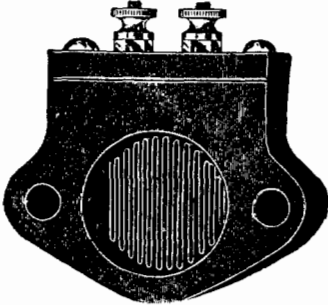

Electric Fuel Gasket

we recommend that the Ford needle valve be opened several full turns, and that the carburetor priming ring should be held out until the engine first begins to fire. As soon as the first explosion occurs in the cylinders, the priming ring should be promptly released. For if the priming ring is held out, after the engine begins to fire, then the cylinders will be flooded with fuel, and it will be impossible to start the engine until this excess fuel is pumped out through the muffler by vigorous cranking.

MANIFOLD PRIMERS

Some of our readers have told us that they have obtained splendid results in below Zero starting by the use of batteries for ignition, and by the manifold primer to give a rich fuel charge. These manifold primers are made in many different forms, but usually consist of small fuel pump attached to the manifold, and drawing fuel from the gasoline pipe leading to the carburetor.

The chief advantage of the manifold type of primer is that these primers usually have a rod of wire running through the dash, so that the engine can be "primed" without lifting the hood. Or else this priming rod is led forward so that the manifold can be primed from the front of the car. Since most drivers fit a hood or radiator cover over the engine during the winter months, it is very convenient to be able to "prime" the engine, without the necessity of lifting the hood and hood cover.

When the Ford is fitted with an electric starter, then the primer is arranged to be operated by a wire or rod extending through the dash. If the old-fashioned hand-cranking method is used, it would be better to fit the primer so that it can be operated by a ring connected to a rod extending through the radiator. These manifold primers are really small fuel "pumps" which delivered a meas-

ured quantity of gasoline to the manifold for each stroke of the pump. Experience will determine just how many strokes of the pump will give best results for easier starting.

There are two types of manifold priming pumps, one which draws fuel from the carburetor or gasoline line. The other type of gasoline primer is connected to the small separate tank. Drawing the fuel from the fuel line obviates the necessity of filling a separate tank, and makes a cheaper outfit.

But the separate tank has a couple of important advantages. One advantage is that the separate tank can be filled with "highest" gasoline, or with gasoline to which a little "ether" has been added, to give a more volatile and explosive mixture. Also as the separate tank is of small size, any leakage through the primer pump into the manifold is easily detected. And there is less chance of fuel loss from this source. As there is a suction in the manifold equal to about 15 inches of mercury when the throttle is almost closed, this suction is sufficient to cause a steady loss of fuel through a leaky manifold primer.

The manner in which the fuel is sprayed into the manifold is an important factor in determining the efficiency of the primer. For small fine sprays will give better vaporization, but are more apt to become clogged, than a single, heavier stream of fuel.

Another form of manifold primer consists of two priming cups, fitted into the arms of the inlet manifold. These priming cups are connected with tubes extending into the valve

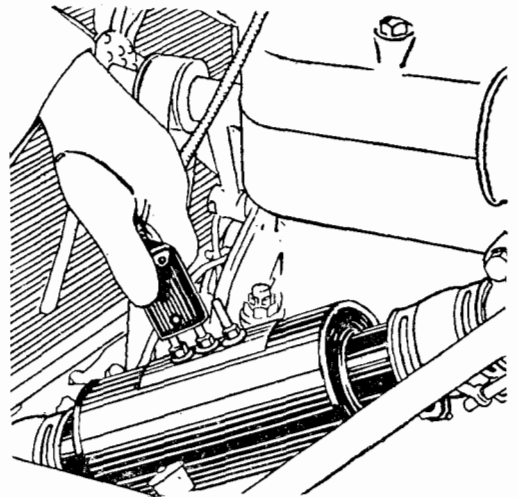

Heats Cylinder Block

chambers, thus delivering the priming fuel to the intake valves. Then when the engine is cranked, the fuel is drawn directly to the spark plugs, thus causing easier starting. One of the advantages claimed for the injection of the liquid fuel to the valve chambers, is that this obviates the spraying of liquid fuel into the cylinders, with the possibility of cutting the film of lubricating oil and thus causing the scoring of the cylinder walls.

DASH PRIMING TANK

In order to prime the manifold more easily, one can install a neat priming tank on the dash. This priming tank is fitted with a glass "sight feed" which enables one to see whether the fuel is being fed to the manifold in the correct amounts.

It will be noticed that there is a small valve under this tank, so that one can open this valve and admit 15 or 20 drops of fuel, as may be required for easier starting. The installation of such a priming tank to the dash does away with the necessity of fitting a priming pump as the fuel is fed by "gravity" to the manifold.

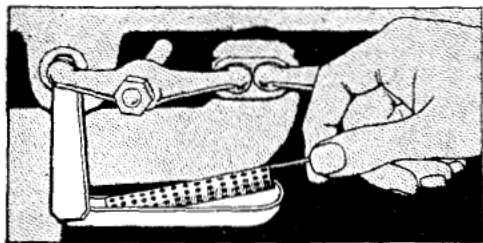

Heats Inlet Manifold

Some of the devices for priming the engine, such as the priming cups on the inlet manifold, require gasoline for priming. And this gasoline can be most easily obtained by fitting the "three-way" valve at the side of the carburetor with the extension pipe, as shown in the illustration. This gasoline connection at the carburetor also affords a convenient means of securing gasoline for cleaning and other purposes, or for getting gasoline to use in a manifold heater using gasoline as fuel.

PRIMING SPARK PLUGS

In order to introduce gasoline directly into the cylinders many engines are fitted with priming cocks to facilitate starting. And these priming cocks are also convenient for testing the compression of the cylinders. When the Ford engine was designed, the gasoline was so good and evaporated so easily that priming cups were unnecessary. But gasoline has decreased in quality and we might as well realize that it is going to grow worse, instead of better.

It is not easy to drill a hole through the water jackets of the cylinder head and fit priming cups, without causing water leaks and other troubles; so inventive genius has worked out different ways to fit priming cups to the Ford engine. One method being by means of special cylinder head bolts, which are fitted with priming cups in the heads of these cylinder head bolts. After the priming cup has been fitted, it is necessary to drill a hole from the inside of the combustion chamber to "register" with the hole drilled in the special cylinder head bolt. And it is necessary to adjust these special cylinder head bolts to the same "position" each time.

In order to eliminate the necessity of this drilling and fitting, and the trouble of "locating" the cylinder head bolt in the exact position each time, priming spark plugs are

made which are easily and quickly installed without any drilling or fitting being necessary. When using these priming spark plugs, the priming cups are intended to be used in a certain manner as follows:

A feast is as bad as a famine. And if the engine is "flooded", then it will be almost as hard to start as if the fuel were not present in sufficient quantity. These priming cups are designed to be used as measuring cups, to supply just the right amount of fuel to the cylinders. Open all four priming cups to allow any compression, which may have remained from the first efforts to crank the engine, to escape. Then close the four priming cups and fill them with gasoline. After filling them with gasoline, open the priming cups and let the gasoline run down into the cylinders. Then close the priming cups. The engine is now ready to be started, with the same measured charge of fuel in all four cylinders.

Some car owners believe that it is easier to crank the engine with the priming cups open. While this is true to a slight extent, but it is the friction in the transmission which is source of the larger part of the drag. So releasing the compression in a Ford does not help much. If the priming cups are kept closed, and the engine once "fires"; the explosion will be more energetic and far more apt to keep the engine running. Also, the "compressed" charge is more easy to ignite.

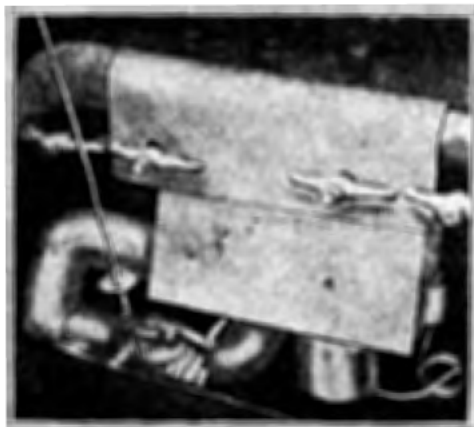

Manifold Shield and Heater

Another advantage, of these priming plugs, is that the gasoline poured through them drips down on the spark plug points, just where the spark occurs. Consequently if there is any spark at all, the charge is apt to fire very promptly. Even the most sluggish evaporation of cold gasoline usually gives enough vapor to start the combustion around the spark plug points, and that is all that is needed to fire the rest of the charge.

The priming cups can also be used to clean the plugs when the engine is running, by opening the priming cups. Then the "rush" of the escaping of gases blows out any oil or loose bits of carbon which may have accumulated around the spark plug points. Also the pouring of gasoline through the spark plugs has the advantage that this gasoline will wash out any oil which may have collected between the spark plug points and fouled the plugs.

ACETYLENE PRIMING

If one can secure one of the acetylene gas tanks, which were used on motor cycles, such a tank will supply acetylene gas for priming. Since acetylene is a true gas, and is very explosive in its action, this gives an "energetic" means of starting the engine. But acetylene gas should be used carefully, for if too much is admitted to the cylinders, the results of such powerful explosions may bend the connecting rods. Consequently, this method is hardly to be recommended for general use.

HEATING THE MANIFOLD

One can't boil water on a cold stove. Neither can one vaporize gasoline in a cold manifold or carburetor. And just as it is necessary to boil water in order to turn the liquid water into the vapor which is called "steam", so too it is necessary to boil the liquid gasoline in order to turn the gasoline into a vapor gas which will burn in the cylinders.

Of course, there is a vast difference in the temperature of 212 degrees at which water boils, and the comparatively low temperature at which gasoline boils. But if we go below the temperature at which gasoline vaporizes, then we cannot change the liquid fuel into the gas either by spraying or by atomizing the fuel, and thus heat is one of the prime requisites of easier starting.

We well know that pouring boiling water over the inlet manifold is one way to supply the necessary heat to make the fuel vaporize more promptly. While this method works, it is a rather sloppy and inconvenient method.

If there is a stove in the garage, then it may be more convenient to use an iron block, which is made to fit around the inlet manifold. Then heat this iron block in the stove, and carry the block to the car by means of a handle attached to the block. If there is no stove in the garage, or when necessary to start the car after it has been standing for a long time on the road, then this iron block can be heated over a gasoline burner, or a stove using compressed alcohol as fuel. Or some gasoline can be poured over a handful of waste and the waste burned at the side of the road and the iron block heated from extemporized stove.

Some car owners place an electric bulb under the inlet manifold, and use the current from the garage lighting system to supply the heat to this bulb. But a glass insulated bulb is a poor radiator of heat, and this method is rather slow and ineffective. A much

better method is to use a special electric heater, which has several coils of heat radiating wire (working on much the same principle as electric heaters used on street cars). Such a heater gives many times the heat supplied by an electric lamp, and is much less apt to break.

A second type of electric heater consists of a special metal plate, fitting across the bottom of the radiator, thus heating the water in the radiator and, eventually, the engine and the manifolds.

Another method of heating the water in the cylinder block, and thus also heating the engine, consists of an electric heater which is fitted around the connection between the bottom of the radiator and the side of the cylinder block. Such an electric heater can be attached to any electric lighting socket in the garage, and quickly heats up the cylinders and the manifold, so as to make starting much easier.

The methods of heating the manifold which we have just mentioned are all designed for use in the garage. But there are other methods which are equally available for use either in the garage or on the road. If the garage is not heated, then the heater may be particularly needed in the garage. As the car is harder to start after having been allowed to remain in a cold garage over night.

If the Ford is provided with an electric starter and lighting system, then it is possible to use an electric heater operated from the storage battery of the electric starter.

Some of these electric heaters are in the form of a gasket, fitting between the carburetor flange and the inlet manifold, and having a heat radiating coil which aids in the vaporization of the fuel charge. By using the current of the 6 volt battery through this heating coil, a much better starting mixture will be secured.

Another method consists in warming the fuel in the carburetor by device consisting of a special plug, replacing the drain plug of the carburetor. By supplying electric heat at this point and thus boiling the gasoline, better vaporization of the fuel is obtained, or the electric heater may surround the float chamber of the carburetor.

Another type of manifold heater consists of little metal troughs, fitting under each arm of the inlet manifold. These metal troughs are fitted with asbestos wicks, which can be soaked with gasoline or alcohol, and ignited with a match. These will soon warm up the ends of the manifold to a temperature which will vaporize the fuel. Or solidified alcohol can be used in these metal troughs.





Christmas Day

'Tis Christmas Day! At early morn
 Upon the frosty air,
 The sound of distant chimes is borne
 In beauty sweet and rare;
 They ring and swing in magic tone;
 They softly rhyme in joy unknown
 To aught but Christmas-tide alone,
 So bright and free from care.

'Tis Christmas Day! The morning hours
 In gladness swiftly fly;
 While 'midst gay snow-flakes' whirling
 showers,
 The Fords go whizzing by
 As happy people they convey
 To places where they'll spend the day—
 It matters not that skys are gray!
 Such things the Fords defy.

'Tis Christmas Day! The afternoon
 Will too, ere long, be done;
 And night will follow all too soon
 The setting of the sun—
 E'en now within the far-off west,
 It trails its clouded way to rest
 With no bright splendor to attest
 Its daily course is run.

'Tis Christmas Day! As shadows fall
 And Yule-logs gleam more bright,
 Old memories the heart enthral
 And fill with golden light—
 They bring back hours of long ago;
 They twine the thoughts of—mistletoe!
 'Tis that kindle on the cheeks a glow
 Defying time's swift flight.

—Ethel Hope.





The Ford-Hound's Hymn

When my Ford runs good I am just as big
 As any that drive a Stutz—
 (When it knocks and pounds—those Ford-like
 sounds,
 I'm the most unhappy of muts;)
 When the camshaft clicks, or a valve stem
 sticks,
 Or a main bearing grumbles or thumps,
 With downcast eyes I apologize—
 For I'm down in the deepest dumps.

When my Ford runs punk—(let them toll the
 bell)—
 Then there is no joy for me,
 For a good Ford purrs in those rhythmic
 "whirrs"
 Or the hum of a busy bee;
 When my Ford runs punk—call the under-
 taker—
 (Get a shutter, or a board),
 Dig a six-foot hole, and, oh, kindly soul,
 Write an epitaph: "Dam that Ford!"

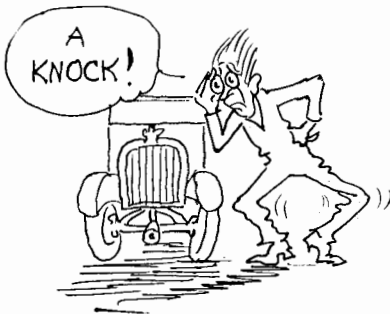

When my Ford runs good!—you should see
 me smile!
 Then I'm everybody's friend,
 Then the world's all right, and the sun shines
 bright,
 And my troubles always end;

When the motor talks like a brook at play,
 Then my heart's beneath the hood.
 On, Flivver, on! Let the poorhouse yawn—
 I am rich, when my Ford runs good!

—W. R. BRADFORD.

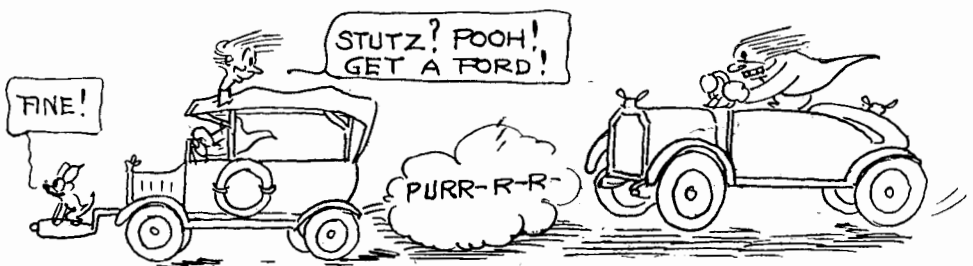

Christmas and New Year's Greetings To You

IT may seem to some readers as though the extending of Christmas and New Year greetings on the part of a Magazine to its Readers is merely a perfunctory duty, observed because the calendar demands it.

But this is not so. A publication only prospers in proportion as it serves, and no one can serve another well without being interested in the problems, obstacles, and victories of that person. Therefore, while the relationship between a magazine and its readers is a subtle and more or less intangible one, yet it is very real, nevertheless. We do not see electricity, nor wind, nor love, but that does not make us deny their existence. The silent forces are the great ones of life.

Throughout the year which is past, month by month this publication has brought to you the best and the most helpful material which could be procured. There has been a continuous study of conditions in the business field from the Crow's Nest—in order that our clientele might be advised early as to affairs touching their interest.

There has been a continuous and earnest purpose of helpfulness in seeking for successful and tested methods which might be reported for your benefit and guidance. Month by month there has been a conscientious effort to give the best obtainable in the way of suggestion, inspiration, and definite assistance.

There have been days we will admit when conditions have been trying in the publication field. But it has been our determination to "carry on" with courage and optimism. There have been periods when we have been marvelously encouraged by the loyalty and faith in us, of our following. And the challenge has made us give our best. The conditions through which we have passed have forged strong and sturdy links between us all—links which will grow stronger we trust, as time goes on, and these blessed seasons of the year when sentiment even in business is given a place, brings us face to face with the Great Fact that your interests are indeed near and dear to us; and that when we wish you a Merry Christmas,—we mean it!

We know the anxiety and the trying channels through which it has taken so much of hope and skill to maneuver, and we feel that at this glad season of the year, you are entitled to that realizing consciousness of PEACE ON EARTH AND GOOD WILL TO MEN.

We feel that your own Christmas will be happy and worth-while, because of what you have done in the way of Service, in order that others might continue to do their part of the world's work. We feel that you are entitled to be happy because of the high purpose which has been yours to raise the profession to which you belong into the plane of loftiest ideals.

Therefore, we say with heart-felt sincerity,—"Here's to wishing you a Merry Christmas—a Happy Christmas—a Soul-Satisfying Christmas!"

This is a period when that spirit pervades the land of unselfishness. It is the time when we look back with tender reflectiveness upon that greatest gift—the Babe of Bethlehem!

Ah, we would indeed be unworthy of our Trust and our Opportunity if at this season we did not send forth to each and every one of you, the season's greetings.

And a New Year is about to turn its fair pages for us to write upon. We have faith that it will be a prosperous and a happy New Year. New Years have a way with them like the Greeks, of coming and bringing gifts with them. Conditions in the business world have been crystalizing into those forms which, we believe will work out in due time for the best good of all concerned. Even as 1921 rewarded the fighters, so will 1922 reward the diligent and the far-sighted.

Rewards are of two kinds. They are financial and important because of their purchasing power. They are spiritual and important because of the courage and satisfaction and joy which they give in work well done,—in benefits well handled.

Therefore, we say to you, a Happy New Year, a New Year rich in the best of Rewards, a New Year which will bring to each and every one of you his heart's most earnest desire!

And when 1922 has told its tale and stands with whitening head ready to give place to the youthful 1923, may we all be conscious that we have carried the Spirit of Christmas in our hearts throughout the twelve months of the year, putting into practice the Golden Rule in business, finishing with integrity this lap in Life's Journey.

And as we view 1921 in retrospect, may a full measure of satisfaction fill all our hearts that it has been happy and prosperous and bright with the best radiance of man's most glorious endeavor!



TRACTOR DIVISION

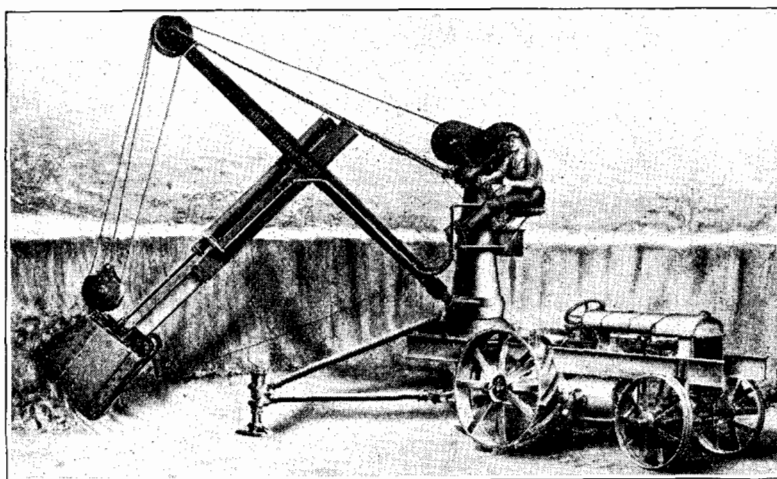

A Fordson Tractor Shovel

LAST year one of the Ford agencies was confronted with the problem of excavating a foundation for their new service station, and removing 2000 cubic yards of earth. Several contractors were interviewed, but as these contractors expected to use horse drawn scoop shovels, their price was considered excessive by those who were familiar with the economical work performed by the Fordson tractor.

The Martin Automotive Company then set about to construct a tractor shovel in their own repair shops, and this Fordson tractor shovel, which was operated entirely by one man, excavated and loaded on wagons as high as 100 cubic yards per day. And dug the material, consisting of clay, slate and fire clay, right out of the solid ground.

The success of this machine proved conclusively the possibility of a light tractor shovel, and Mr. Martin spent the following year in developing a machine which would revolutionize power excavating in many lines of industry. After his plans were worked out, the services of Professor W. Trinks, of the Carnegie School of Technology were secured for working out the improvements in the machine.

The shovel has been designed for easy attachment to the Fordson tractor. The shovel part of the mechanism has been designed to support the greater part of the weight, and to receive all loads and strains, so that the severe strains, encountered when the scoop shovel

is cutting through the ground, may not center on or effect the durability of the Fordson tractor.

After the tractor has once been assembled, it can be attached or removed from the tractor in one hour, thereby making a readily convertible unit. The tractor shovel has all bearings of either the ball or roller type. And the bearings are enclosed and run in oil. The shovel revolves and excavates in a half circle and will discharge in a complete circle. It is especially adapted to road work and ditching, or irrigation work in the fields.

As the weight of the shovel is 3200 pounds and as the weight of the tractor is 2700 pounds, this makes the weight of the complete outfit 5900 pounds or approximately three tons. The apparatus is designed to be operated entirely by one man, with a capacity of the shovel of from 20 to 40 yards per hour, and a fuel consumption of $1\frac{1}{2}$ gallons of kerosene per hour.

In traveling from one location to another a speed of practically seven miles per hour is maintained so this shovel can travel over the roads at a much higher rate of speed than the average steam shovel.

The maximum force exerted by the bucket teeth is 6000 pounds. And the shovel can be swung at the rate of three to four revolutions per minute.

The speed of the motion of the shieve block and the bucket is sixty feet per minute. The maximum pull of the cables (three raps of

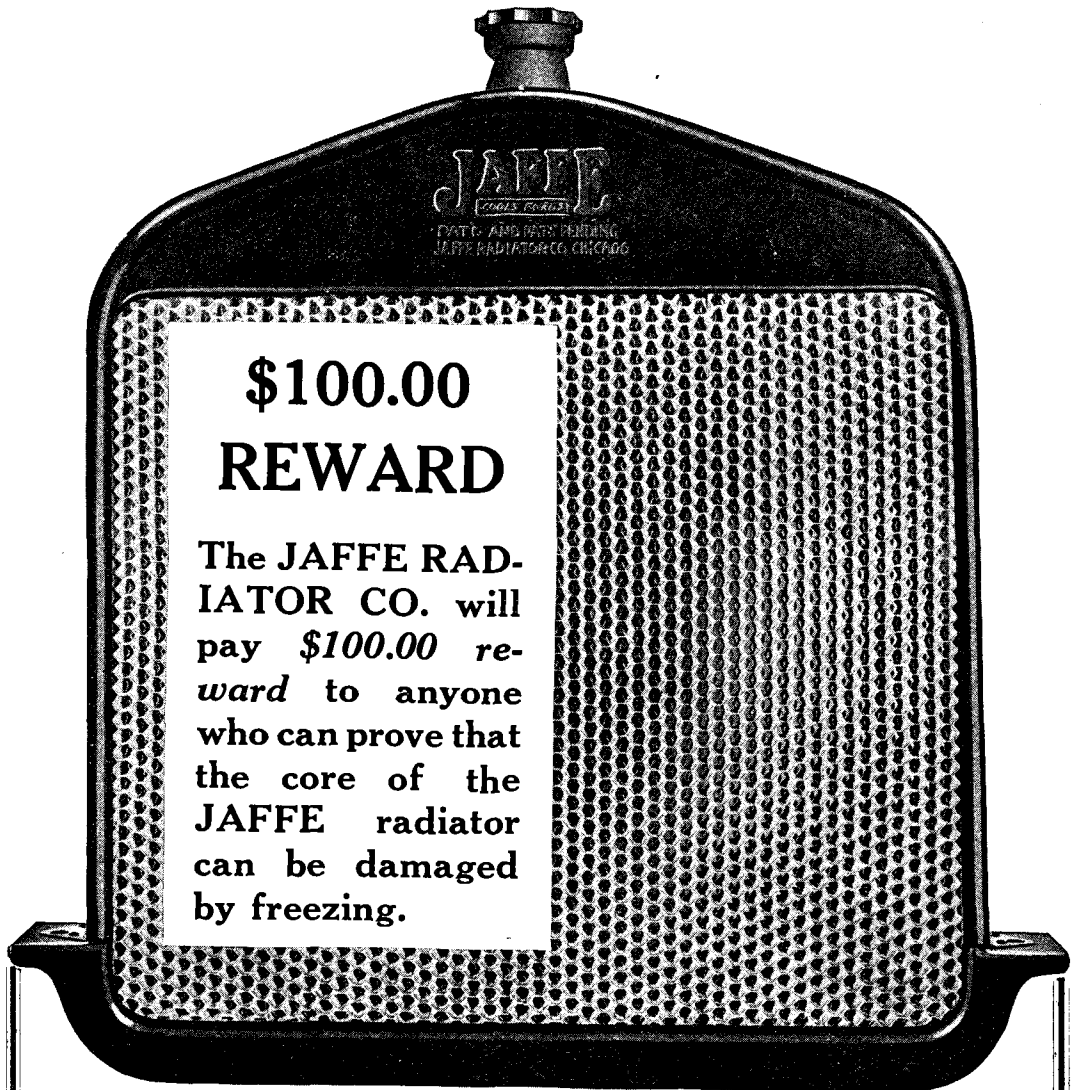

Winter radiator troubles are with us again. Why not definitely eliminate all Ford radiator damage by the use of JAFJE radiators? JAFJE is the only radiator in the world which not only carries an ironclad guarantee against freezing injuries with free replacement in case of such trouble, but also has \$100.00 reward waiting for anyone whose JAFJE core is so damaged.

DEALERS:—The JAFJE \$100.00 Reward Guarantee has a wonderful appeal for your customers. It puts in your hands the greatest selling feature ever offered the trade. It means big JAFJE sales for YOU. Are you equipped to take care of the demand? Your jobber can supply you. Write us for your nearest shipping point.

Also if you will just tear out this page and mail it to us, we will gladly forward to you some of our new three-color display signs, imprinted with your own name and address. **THEY WILL BRING YOU BUSINESS.**

JAFJE—"The Nationally Advertised Radiator With the \$100.00 Reward."

JAFJE RADIATOR CO.

741 W. Van Buren Street, CHICAGO, ILLINOIS

cable) is 7700 pounds. The speed of the drum is sixty-eight revolutions per minute and the speed of the clutch shaft and the planetary gears is 138 revolutions per minute.

When the bucket is raised for dumping the dirt into the wagons, the maximum clearance of the bucket (with the door open) is 10 feet above the ground level. The digging depth, below the surface on which the tractor stands, with the standard handle, is 4½ feet. Though a special handle can be used to allow the tractor shovel to dig to a depth of ten feet. The maximum reach, from the center of the rotation to the center of the bucket, is about seventeen feet. It will be noticed that there are a couple of supporting braces, which take practically all the load and strain. When the bucket is digging there is no special strain thrown on the Ford wheel bearings or other parts of the Fordson tractor.

Owing to the fact that so many men are now familiar with the art of driving the Fordson tractor, it is easy to get operators to handle such a Fordson tractor shovel.

The capacity of the bucket is approximately one-fourth cubic yard. And the bucket is of the "drop-bottom" type, with a lever which can be tripped by either the driver of the wagon, or by means of cord pulled by the operator of the shovel.

The arm, on which the shovel is fitted, is moved up or down by means of a hydraulic cylinder. By careful inspection of the sketch one will notice that there are a couple of small pumps which create the necessary pressure to raise and lower the bucket arm. The reason for using two pumps is that one pump furnishes an "extra-high" pressure to cause the bucket to "bite" into the ground. While the other pump furnishes a greater quantity at

a lower pressure for moving the bucket arm in-and-out, against practically no resistance. As when putting the shovel arm into position, or placing the shovel arm over the wagon to be dumped.

Under the pressure pumps there is a small reservoir which makes up for any loss or leakage of oil, and compensates for the difference in displacement in the two ends of the cylinder, due to the space occupied by the piston rod in the lower part of the cylinder.

From the power take-off at the side of the Fordson tractor engine the shaft operates through beveled gears through an up-right shaft going through the center of the shovel standard. At the top of this standard there is a regular Ford car planetary transmission. This transmission is geared to the standard for rotating the swivel-arm and bucket assembly, either to the right or to the left. The swiveling of the shovel arm is controlled by two foot pedals operated by the shovel man, who pushes on one pedal to turn the shovel arm in one direction, or tramps on the other pedal to swing the shovel arm in the other direction.

From the power shaft, running up through this column, there are bevel gears connected with a Ford "worm" gear, taken from a Ford Ton-Truck, thus giving a 7-¼ gear reduction, still further decreased by the chain drive to the winch of the cable hoist. Thus making a total reduction of about fifteen-to-one, between the cable winch and the Fordson power take-off. This reduction means that there is tremendous power on the steel lifting cable. As this cable has three effective "wraps", this multiplies the power exerted on the steel cable three times, and furnishes the necessary power for pulling the shovel up through the dirt and doing the digging and lifting.

TRACTOR OVERHEATS

Have a Fordson tractor which overheats. Have cleaned radiator and water jackets, tested coils, installed new spark plugs, wiring and timer. Spark is properly timed and the fan is running perfectly.

I bent the fan blades to the limit, and taped the fan pulley, this helped a little. But the water still boils away at the rate of 3 gallons per hour on a hot day, when plowing reasonably pulling land. Could I remove the fan drive pulley on the crank shaft and cover it? Would it be possible to drive the fan so fast that it would just churn the air, and not draw it through the radiator?

Are there any water circulators made for the Fordson?

* * *

..The overheating of your Fordson tractor engine may be due to either a clogged vaporizer tube or to an air leak in this tube, which allows air to be drawn in, thus spoiling the mixture. If the tube is clogged with carbon, it will be necessary to replace it, as it is practically impossible to clean out a clogged tube.

Overheating can easily be caused by not having the proper clearance between the ends of the valve stems and the tappets. Better check up this, as directed in the tractor instruction manual.

We think that you will get best results by having the fan blades bent at the same angle as sent from the factory. A steeper angle only

churns the air, instead of drawing it through the radiator. Lagging the pulleys is a waste of time, as the Ford pulleys and belt are large enough to transmit the power without appreciable slipping, provided that other conditions are correct.

A water circulator for the tractor is made.

CRANK SHAFT END PLAY

Have a Fordson tractor with end-play in the crank shaft. Will it do to put solder on the ends of the crank shaft bearing caps? These bushings are brass, lined with babbitt, but the brass shows at the ends of the bushings, as it was never covered with the babbitt in the first place.

* * *

The Ford Motor Company is now supplying, through its agents, a "special" No. 3 Main Bearing Cap for Fordson tractors. This is part No. 2565, and the list price is the same as for the old style cap No. 8230. This cap is designed to take up end-play in the crank shaft, and to preclude the possibility of the magnets coming in contact with the magneto coil assembly.

Since so much work is required to obtain access to the rear main bearing cap, we advocate doing the job RIGHT the first time, by installing the special cap—rather than by attempting to put solder on the end of the old cap, which may be only a temporary repair, and which is at best a time consuming job in soldering and fitting.

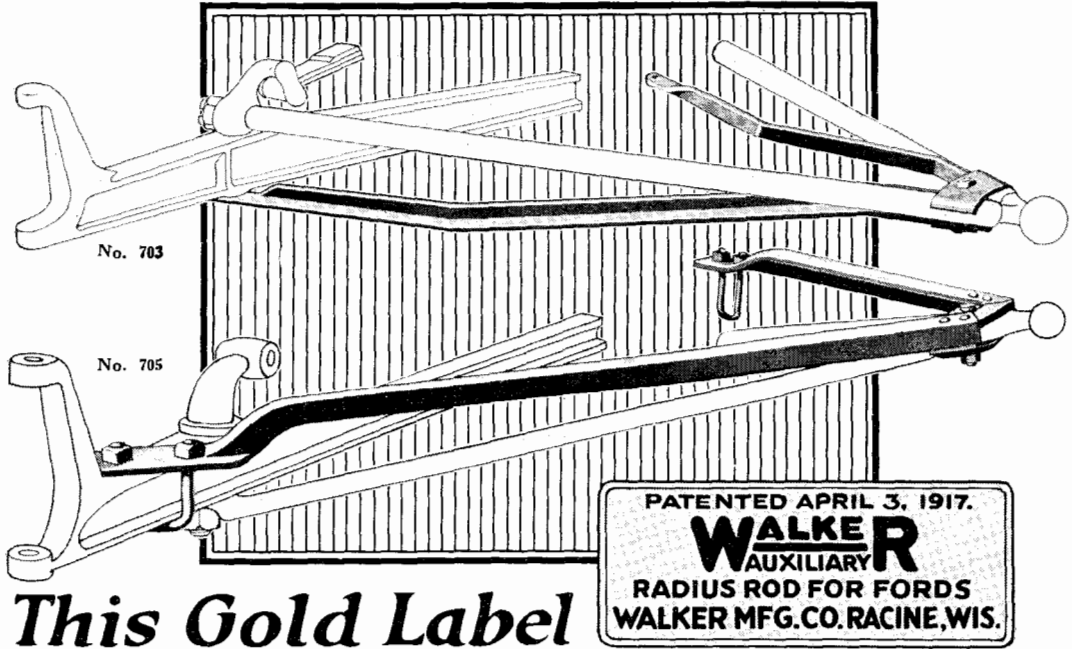

This Gold Label Identifies Walker Radius Rods

If you want radius rods of superior workmanship; of the highest quality materials, look for the brand that bears this Gold Label. It identifies those made by Walker.

Walker Radius Rods are the most perfected type on the market today. They are made to keep the front axle where it belongs—in proper alignment. They won't bend, twist or break and they are ready for instant attachment. There are no holes to bore and they are quickly and easily applied without any machine work.

Rod No. 703, as illustrated above, is made of 1 x 1 x $\frac{1}{8}$ inch angle iron bent to a wishbone shape. It clamps securely to the crotch of the regular rod and fastens to the perch bolts on the under side of the front axle.

Radius Rod No. 705 is made of 1 x 1 x $\frac{1}{8}$ inch steel angles. It is flattened out and fastened to the front axle by means of "U" bolts. The other ends are riveted to a malleable casting which fits into the crotch of the regular Ford rod to which it is fastened by a bolt and plate. This fits only 1920 and later models.

The next time that you need radius rods, step in to your dealer's place of business and ask for those bearing the Walker Gold Label.

WALKER
AUXILIARY
R
RADIUS RODS

WALKER MANUFACTURING CO.

RACINE,

Dept. 1006

WISCONSIN

When writing advertisers—Just say FORD OWNER AND DEALER

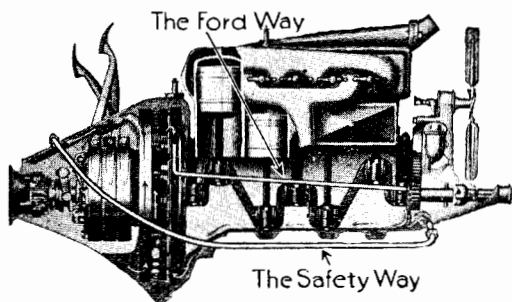

“SAFETY” FIRST

You can prevent the troubles due to improper lubrication in your Ford motor at far less expense than the cost of repairing.

“An ounce of prevention” today is worth far more than the “pound of cure” of tomorrow.

Now is the time to install a

SAFETY OILING SYSTEM

when your motor is in tune and have the assurance of the longer, better and economical service that you have a right to expect.

It gives your motor a new heart, pulsing the oil to the vital parts at each turn of the flywheel.

**A COMPLETE Oiling System;
Efficient, Durable and Dependable.**

\$6.00

*Write today for illustrated booklet on Ford motor lubrication.
It contains the information you want.*

SAFETY OILING SYSTEM, INC.

22nd and Fairmount Ave.,

PHILADELPHIA, PA.

DEALERS:—100,000 Ford owners attest the fact that the S. O. S. is the best article on the market for Ford motors. Ask for proof of how easily you can sell them.



When writing advertisers—Just say FORD OWNER AND DEALER

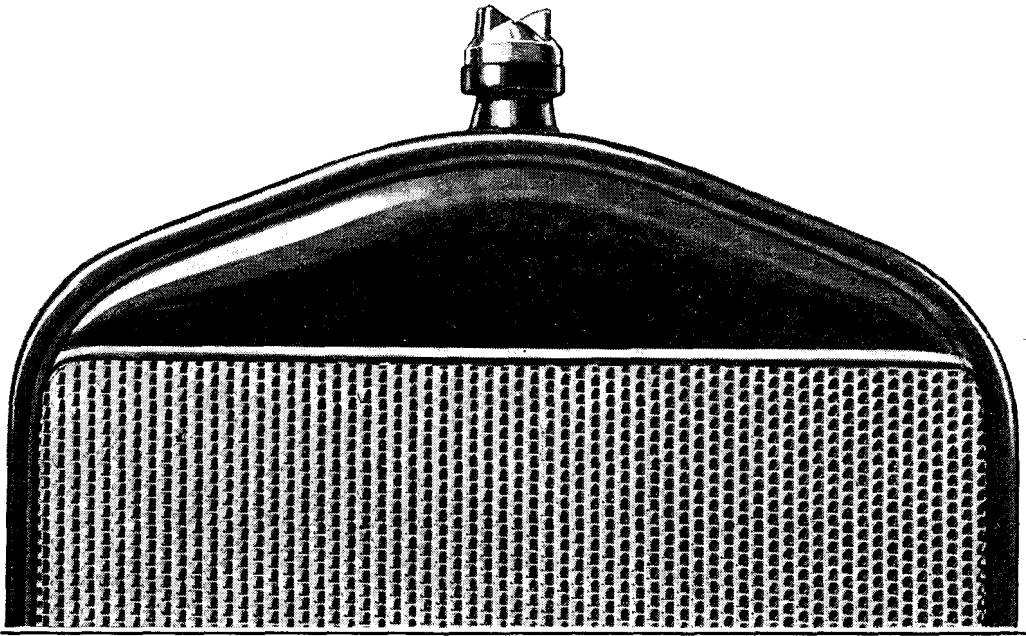

Built To Withstand Freezing

42%
*Greater
Cooling
Capacity*

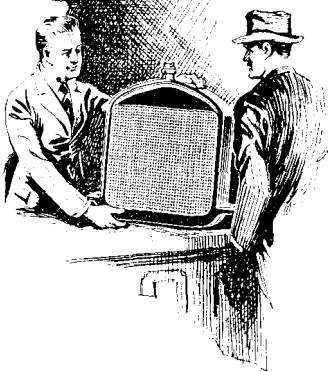

The Modine Spirex is built to withstand freezing. The amply large, one piece, lock seamed water channels together with the close metallic contact made possible by the Spirex construction, assures a radiator core that will not burst or spring a leak even when it is frozen solid.

This one, big, important fact, together with the better cooling—42% more than the regular Ford equipment—afforded by the famous Modine method of core construction—the Spirex spiral—guarantees you a Ford radiator that is doubly strong and highly efficient in ALL seasons—a radiator that gives you more and costs you less than others of decidedly inferior worth.

Step into your dealer's store—today—and look at the Modine Spirex. Leave an order to have one installed on your car and forestall radiator trouble now. Send the coupon.

MODINE MANUFACTURING CO.

100 Sattley Bldg.

RACINE, WIS.

Zinke & Co., Sales Agents

1323 S. Michigan Ave., CHICAGO, ILL.

MODINE
SPIREX
MODINE RADIATORS
SPIREX

COUPON

MODINE MFG. CO.
Racine, Wis.
Gentlemen:
Please send me the full facts about Modine Spirex Radiators for Fords.

Name

Address

City

When writing advertisers—Just say FORD OWNER AND DEALER

Christmas Gift Suggestions

The problem of what to give your friend for Christmas is greatly simplified if he, she, or it owns a Ford. The advertising pages of this magazine offer a rich field of profitable suggestions.

If your friend is a man, then he will probably appreciate gifts of a **practical** or **comfort** giving nature, such as tools, or exhaust heaters to keep him comfortable. While, if your friends happens to be a woman driver, then she is more apt to be interested in such

luxuries as vanity cases. Or in locking door handles for the Ford Sedan, which will enable her to keep packages safely locked in the car, while she does her shopping.

We have arranged a rough schedule of gifts, grouped according to prices. However, these prices are by no means definite, as one company may charge \$17.50 for one kind of exhaust heater, while a different kind of a heater may be obtained for two or three dollars.

\$25 Class.

Shock absorbers
Exhaust heaters
Special ignition system
Special radiator
Rear hub brakes
Spare tire

\$10 Class.

Sedan door locks
Water circulating pump
Special carburetor
Combined inlet-and-exhaust manifold
Steering wheel lock
Speedometer
Clock

\$5 Class

Radiator Shutters
Foot-warmers
Refrigerator basket
Window curtains for sedan
Lap robe
Extra seat
Gloves

\$3 Class.

Primer
Accelerator
Blue Book
Socket wrench set
Steel foot board
Good tire pump
Radiator thermometer

\$2 Class

Transmission Band
Linings
Timers, Improved
Reserve gasoline valve
Muffler cut-out
Robe rail
Carburetor adjuster
Overalls

\$1 Class

Spark plugs
Special wrenches
Extension door handles
First aid kit
Tire guage
Radiator mascot

THE BALLADE OF THE CHANGEABLE SPARK-PLUGS

(Ballade à Double Refrain)

By Lloyd McFarling

When the old bus runs, (as it sometimes will)
With a roar that speaks for the good of it's name;

When she quickly picks up on the side of a hill
I know that the spark-plugs are playing the game.

But whenever the pick-up is tardy and tame,
And I choke in the dust of my fellowmen,
Although I wont give you the language I frame—

I know that the spark-plugs are dirty again.

When her power is a promise, her speed is a thrill,

And her engine is voicing a steady acclaim
That the best of the rest must take the dust still

I know that the spark-plugs are playing the game—

But there's many a day when life isn't the same,
(You could buy a good car at a bargain then),
When the old girl is wheezing and puffing and lame

I know that the spark-plugs are at it again.

When the gas that she uses is just about nil,
When my friends are friendly and loudly exclaim:

"How in the world do you do it, Bill?"

I know that the spark-plugs are playing the game—

But whenever I nearly fracture a hame
In making a gallon of gas do ten,
And the noise that I make increases my fame—

I know that the spark-plugs are dirty again.

L'envoi.

When the Traffic Cops are taking my name

I know that the spark-plugs are playing the game—

When they look at me with a pitying grin

I know that the spark-plugs are dirty again!

K. R. WILSON OF BUFFALO

Originator of
SPECIAL TOOLS
for **AUTOMOBILE REPAIR SHOPS,**
Save 75% on your labor costs

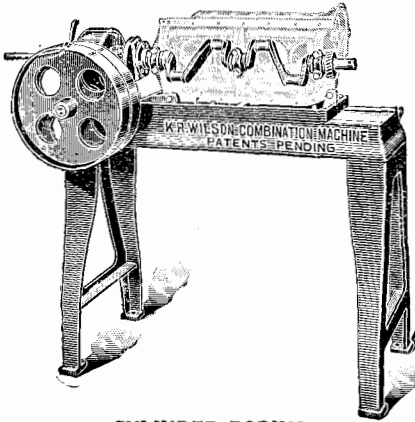

CYLINDER BORING

Other Operations
 Rebabbitts Rebores Cylinders
 Rebores Crankshaft to Fit the Pistons.
 Reams Bearings Two Position Mo-
 Runs-In tor Work Bench.
 One H. P. for Any Operation

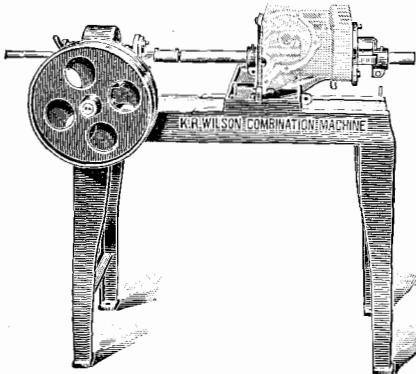

RUNNING-IN

What They Say

MELDRUM MOTOR CORP.,

Buffalo, N. Y.

"We have found your machine superior to any other designed for the purpose. Altogether we are turning out a considerably better overhaul job in much less time."

MILES SHERRINGTON,

Fall River, Mass.

"It is the best investment I ever made. I waited three years while you perfected this machine and my every expectation has been more than fulfilled. I don't hesitate to recommend your machine as doing all that you claim for it."

F. W. NEWMAN,

Hamlin, N. Y.

"The machine we put into use at the Brockport Branch some time ago is giving the best of satisfaction and with three of Branches we expect to draw the Ford Repair business."

It might be of interest to you to know that our customers take a real interest in these machines and often stay to see them work which results in more work being sent in."

COOK MOTOR CO.,
Yoakum, Tex.

"Has given excellent service and work that will compare with that done by machines costing four times as much. We could not be better pleased with our purchase."

JUDGE MOTOR CORP.,
Rochester, N. Y.

"I consider it the most up-to-date and accurate equipment manufactured for a Ford repair shop. We have cut our labor costs considerable."

JOHN N. SNYDER,
Williamstown, Pa.

"It does absolutely everything it claims it will do. Its simplicity and ease of operation are wonderful."

We unqualifiedly recommend it to any one who overhauls Ford Motors."

PENNY BUSICK CO.,
Greenville, S. C.

"Our mechanical department reports that the KRW Combination Machine purchased of you is giving entire satisfaction."

(A Few of the Many on File in This Office)

BETTER WORK IN HALF THE TIME MEANS DOUBLE PROFITS AND SATISFIED CUSTOMERS

Builds Good Will and Reputation

Write today and find out what this machine will do for your Business.

K. R. WILSON

10-16 LOCK STREET

BUFFALO, N. Y.

HINTS

Send us rough sketch and description of any repair hint that would be of assistance to Ford owners. If acceptable, we will pay \$1 for same. Here's a chance for easy money.

TEMPORARY RADIATOR REPAIR

When a radiator becomes damaged through accident, or by freezing, it is often possible to effect a temporary repair which will bring the car home, by prying away the fins from around the damaged tubes, cutting off the ends of the leaking tubes squarely, and then plugging the

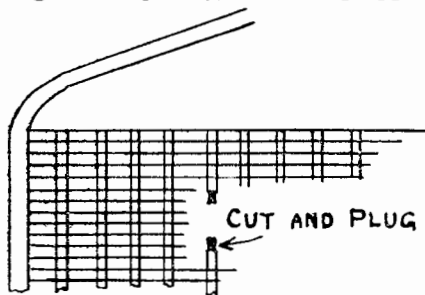

ends of the defective tubes with wooden plugs.

Of course, these tubes will have to be repaired before the car is again used in freezing weather, as the water in the tubes above the plugs cannot be drained out, and will freeze and burst again.

ARTHUR WOODS, Maury City, Tenn.

REPLACING FRONT CROSS MEMBER

Replacing the front cross member of the chassis frame, Part No. 2853, is one of the most difficult of chassis repairs. And as this part receives the impact of many collisions, the repairman is frequently called upon to do this work.

At the factory, this part is attached to the side members of the chassis frame by 14 inaccessible rivets and two bolts. Unless one has the special equipment and replaces the rivets "red hot" as originally installed, the work is apt to be unsatisfactory, due to inability to get as much tension on the "cold" rivets as is secured on the "hot" rivets, after they have cooled and shrunk.

Support engine base with jack or blocks, and remove front spring. Also detach outside of engine pans or remove them entirely. With a rasp or sharp cold chisel, remove heads of rivets, and punch them out. One of the lamp brackets must also be loosened to insert new parts. And the rivet holes in same must be reamed to $\frac{1}{4}$ inch before inserting.

Use only four rivets in replacing new cross member, two in each end, inserted from top in vertical position, attaching ends of cross mem-

ber to the lower flange of side frame. In all other places, use $\frac{1}{4}$ inch machine head bolts, cut to scant $\frac{3}{4}$ inch long.

All nuts should be counter-sunk on outside. And the underside flange of frame, where cross member attaches as well. Draw bolts to an even tension, by gradual tightening of all nuts. And be careful and pack counter-sink of each full and round which, with the compensated head, insures against working loose, as it would against a flat surface.

FRANK E. BROWN, Faxon, Okla.

HOLDS CYLINDER BOLTS

As the two bolts at the rear of the Ford cylinder head must be replaced in the head before the head is shoved back under the dash, these bolts sometimes catch and tear the cylinder head gaskets. To hold these bolts up

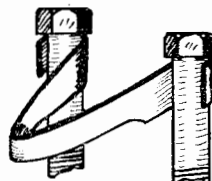

out of the way, and at the right height, a brass clip is made to hold the bolts so that they will clear the gasket. By having this tool in place, the hands of the mechanic are left free to handle the cylinder head.

RAY WEBB, Shreveport, La.

LEAKY RADIATORS

To stop the radiator from leaking,—put one teaspoonful of bran into it. Start the engine to cause water to circulate. Inside of twenty minutes, the radiator will be tight and will stay tight—even if the holes are $\frac{1}{16}$ of an inch in diameter.

Get the bran that is sold in packages to eat, as it is without flour or gluten, and will not clog radiator tubes. Do not use "shorts," as the flour in it will cook in lumps, plug the tubes and cause boiling.

Do not put the bran in and stand around waiting for leaks to stop—they won't. Get in, ride around twenty minutes, and they will.

"POSITIVE JOHN" San Jose, Cal.

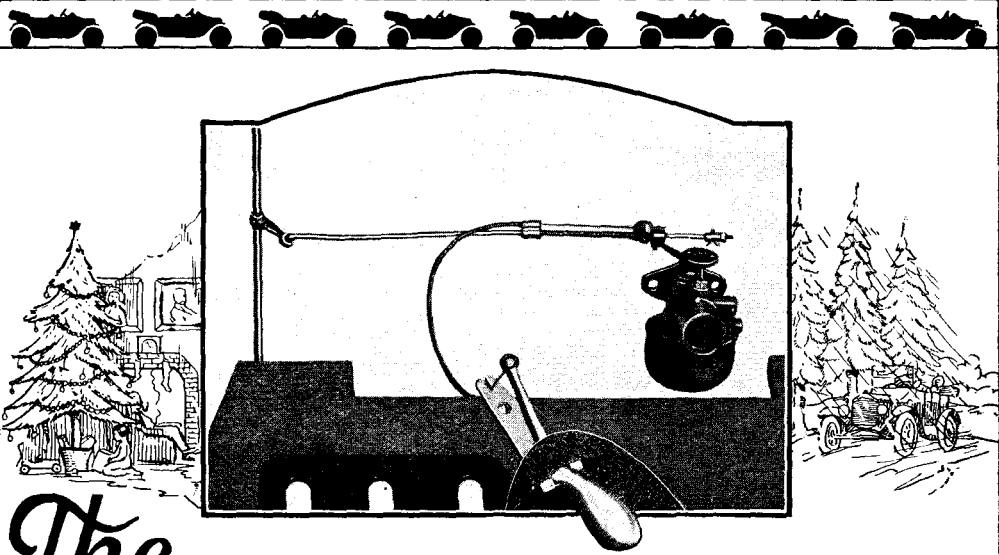

The WILLIAMS ACCELERATOR *a practical Christmas Gift*

For the man or woman who drives a Ford, there is no more acceptable Christmas gift than a Williams Accelerator.

It permits the speed of the car to be regulated by the foot, thus allowing the free use of both hands for driving and signaling. It assures a smooth, quick get-away, and is a big factor of safety when driving in the crowded traffic, or on slippery roads and pavements. It does not interfere with the operation of the hand throttle. There are no complicated springs or levers to get out of order; vibration does not affect it.

PRICE
At Your Dealer's
\$ 3⁰⁰
AND WORTH IT

Anyone can install the Williams Accelerator in seven minutes: Three easy connections—hand throttle, toe board and carburetor lever, as shown in the above photograph. Once installed, it can be removed and replaced in a few seconds. The pedal, which projects through a small slit in the floor carpet, is made of aluminum, and adds to the appearance of the car.

The Williams Accelerator is guaranteed against wear or defects in material. Ask your dealer to show you one. Dealers, write your jobber for complete information.

WILLIAMS BROS. AIRCRAFT CORPORATION
SAN FRANCISCO

WILLIAMS ACCELERATOR *for FORD CARS*

HOLDS VALVE PINS

The valve pins are often lost when removed for valve grinding. But, if a discarded magnet, from a Ford magneto, is hung over the radiator-to-dash rod, then the pins can be held by the magnet where they are always handy, and not in danger of becoming lost.

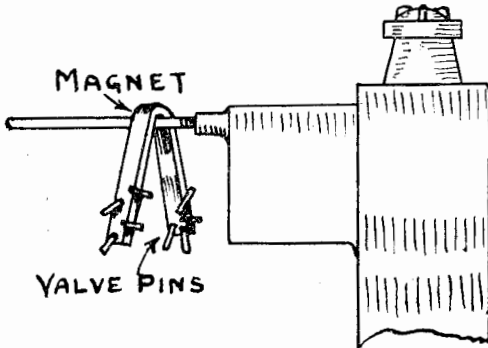

Another magnet can be hung on the rod to take care of the cotter pins, removed from the control connections, so that no time will be lost when assembling the parts of the car.

S. E. GIBBS, Corydon, Iowa.

CLUTCH SPRING COMPRESSOR

The discarded Ford parts, as shown in sketch, are used for replacing the Ford clutch springs. Screw the bottom bolt into the crank case, and put nuts on each end of the bolts which run

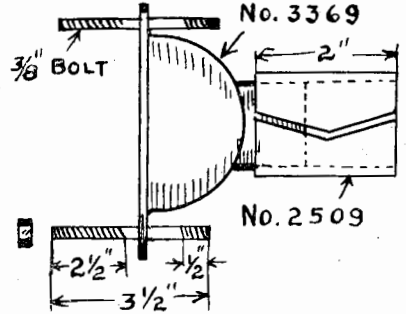

through the opposite corners, and through the transmission cover. Then tighten the both nuts uniformly, thereby compressing the clutch spring, and placing No. 3341 in position for driving out the pin No. 3342.

E. C. CROSS. Underhill, Vermont.

WHAT- WHY- HOW-

Wherein Your Questions
Are Answered

Conducted by
Murray Fahnstock

MISSING OF MOTOR

Have a 1916 Ford, and I have had three mechanics working on it. It will run all right for a few miles—then it will start missing, and continues to misfire for the rest of the day. Next time I take the car out, it may run all right—or it may not. The engine always runs more smoothly, and has more power, when it is raining.

The engine misfires on no particular cylinder. By cleaning spark plugs and timer, I can generally help the miss for a few miles. I have changed timers, wires and carburetor, put in new piston rings. We put in numerous plugs, and had the valves ground four times—but the trouble would always return within a hundred miles.

When the car is running along on three, and then stopped and allowed to idle, it will seem to fire every shot. I have payed out over \$100.—but to no avail. One garage man says it is in the magneto—but he didn't tell me that until he had a bill for \$70.00.

If the valve tappet clearance is not sufficient, then the valves will be held off their seats and the engine will leak, when the valve stem are hot and expanded. We suggest that

you check up the valve tappet clearance, and make sure that this is between .022 and .028 inch for all of the valves. By the time you have cleaned the timer and plugs, the engine has had a chance to cool off, and the valves get back to normal.

It is also possible that some of the valve stems may be bent or dirty, and that they stick in the valve guides, when they become hot and dry and expanded. Or, it is possible that the valve springs may be weak.

Another possibility is that there may be a crack, in the cylinder head or cylinder block, which opens when hot, and allows water to leak into the cylinders and so cause misfiring. But this is not so probable.

Neither is magneto trouble probable, as any intermittent short in the magneto would cause all the cylinders to stop firing momentarily. If the lights are good, you need not worry about the magneto. However, we do suggest that you have the coil units **adjusted**, on a coil unit testing machine to ensure a good spark for all four cylinders.

It is possible that oil fouling of the plugs is the cause of the trouble in your 1916 Ford, and it may be necessary to lap in a set of .0025 inch oversize pistons to keep this oil from working up into the cylinders.

STOPS IN LOW

Have a 1916 Ford in which the engine was recently overhauled. Very soon it developed a serious 'grunt' and would not run in low gear at all. When we put it in low, it would begin to miss, back-fire, and go dead.

I took down the engine and found the magnets rubbing the poles of the magneto coil assembly. I set the magnets back to proper distance, and then put the engine together, but it still will not run in low gear.

* * *

Weak magnets are undoubtedly the cause of the failure of the car to run on low gear. When low gear is used, the clutch spring is compressed and this tends to draw the magnets further away from the coils of the magneto coil assembly, thus weakening the current available for ignition. You can make certain of this by connecting to a set of dry cells to the battery side of the coil box and if the engine runs on low gear, then you can be sure that it is the magneto that is at fault. There also seems to be too much 'end play' in the rear main bearing cap, and you should install a new oversize main bearing cap to take up this play.

ALL PLUGS SPARK AT ONCE

My 1917 Ford has a habit of carrying an electric spark through all the spark plugs at once. When any plug is firing on the battery ignition (it does not matter which one) the other three plugs show a small spark, about the size of a pin-head, when they are short-circuited by touching a screwdriver to the top of the spark plug and cylinder head. The three plugs with the small spark do not shock me when I touch them with my bare hand, as does the plug that is actually firing.

I installed a new set of timer wires, and made sure that none of them were grounded anywhere. The engine cannot be started from the magneto, and I always start on battery and switch over to magneto.

How can I repair the stripped thread holes in the fly-wheel of a 1915 Ford? The hole is one of the four where the fly-wheel cap screws bolt the crank shaft to the fly-wheel. State size of drill, tap, and new bolt to use.

* * *

Almost any automobile will show a tiny spark at the other plugs, when one plug is firing—but no attention need be paid to this and it will not cause overheating. The tiny spark is due to 'inductive' or 'wireless' effect between one coil unit and its wiring, and another.

Drying out the coil units and the coil box in the gentle warmth of an oven may help to reduce this 'static' spark, but will not eliminate it altogether. Simply forget it.

Stripped holes in fly-wheel can be repaired by drilling out oversize with $\frac{1}{8}$ inch drill, then tapping with a $\frac{1}{8}$ " by 18 tap, and plugging, then drilling with $\frac{3}{16}$ inch drill, and tapping with a $\frac{1}{8}$ " by 20 tap. The plug should be peneled on both sides of the fly-wheel. And a $\frac{1}{4}$ inch hole should be drilled, with the edge of the plug as a center, and a piece of $\frac{1}{4}$ inch rod should be hammered into this hole as an anchor.

CAUSES OF VIBRATION

In September 1921 issue, you mention several causes of vibration in answer to the first question on page 68. I have been in a Ford agency for a long time, but have never found vibration caused by an engine bearing.

One of the greatest causes of vibration 'at certain speeds' as your inquirer puts it, is caused, I believe, by the front crank case bearing being loose. We have had several complaints of this nature and, in almost every case, the trouble has been overcome by tightening the front support bearing cap.

We fellows in the Service Department enjoy your WHAT-WHY-HOWS and never fail to discuss them. Us old Southern boys are knocking the top off down here with service. Got more Fords running around here than boll weevils in a cotton patch.

* * *

Nothing pleases us better than to receive letters from our readers amplifying or correcting

statements that have been made in our magazine. For 'in the multitude of counsel there is much wisdom' and we are darned eager to learn.

As our reader did not state what 'certain' speed the vibration occurred, our answer had to be rather general. But we have noticed that some motors, which caused vibration at speeds of 25 miles an hour when the bearings were loose, could be speeded up to 30 miles an hour before the same vibration occurred, after an overhauling in which the bearings were tightened and adjusted.

ADJUSTING CARBURETOR

Wish for help in adjusting a special carburetor, for use at high altitudes. Am getting very little power, at altitudes of 7,000 feet and over.

At high altitudes, the air is rarified or 'spread out,' so that a given volume of air contains fewer units of oxygen than the air at sea level. And the number of units of oxygen that one can get into the cylinders is one of the factors determining the power of the engine—the more oxygen units, the greater the power.

* * *

The carburetor you are now using has a hot air pipe, and a large 'stove' or shell, covering part of the exhaust manifold. This stove heats—and expands the air, that is delivered to the carburetor. Now expanded and rarified air are much the same. At high altitudes, this heating and expanding of the already rarified air, reduces the available number of oxygen units admitted to the cylinders to such an extent that the motor loses power. Remove the hot air pipe and "stove" from the carburetor you are now using, and we think you will get considerably more power. Under no possible conditions can you get as much power at 7,000 feet altitude, as you can get nearer sea level.

With the hot air pipe and stove removed, it will be necessary to adjust the gasoline feeds differently to get the best results.

FORD TRUCK BODY

Have a Ton-Truck, without starter or battery, 1919 model. I do a lot of night work, during the winter months and I wish to install a light in the body of the truck to locate parcels.

* * *

To light the inside of the body of the truck for locating parcels, you will get a nice light if you use one 12-16 volt, 4 candle power bulb, connected to the Ford magneto. You will need a switch, for turning off this light when you are running the car. For if you race the engine in low gear, when this bulb is turned on, you will burn out the bulb, because it is of less than 18 volts. But this lower voltage bulb gives a nice light, without running the engine too fast when idling.

SPEEDSTER QUERY

Have a Ford speedster. If I now go at the rate of 20 or 25 miles an hour the car starts bouncing from side to side. The springs work a little stiff, although I have them well greased. Would you advise me to remove a leaf or two, or would it help to add a leaf?

* * *

For speedster use, it is seldom necessary to make such change in the Ford front spring, as the weight of the engine and transmission remains the same. Though it is possible that, with a very light body and no mudguards, one of the leaves of the front spring could be removed to advantage.

As the Ford rear springs are intended to carry the touring car body and a five-passenger load, it stands to reason that they are entirely too stiff and unyielding for speedster use. Even on the Ford roadster, one leaf can be removed to advantage. For speedsters with a light body, you can remove either two or three leaves, taking care to space the removal of the leaves so as to maintain the same general form of the springs as nearly as may be. Taping the springs, or wrapping with cord, is often done on Ford speedsters, in order to smother the rebound.

Ford News Notes

By ROY BUELL

Detroit, Mich. When Henry Ford first made his offer to the Government sometime ago to purchase the Muscle Shoals enterprise down in Alabama the public gave but little thought as to his intentions other than to manufacture fertilizer.

The farsightedness of Mr. Ford daily becomes more evident and he has just recently been quoted as saying that if the Government will let him have Muscle Shoals he can make the enterprise serve as going a long way toward solving the unemployment problem.

The Muscle Shoals plant was established by the Government during the war for manufacture of nitrates. Mr. Ford has offered to take over the establishment to manufacture fertilizer, but his offer has not been accepted.

The Muscle Shoals enterprise is second only to Niagara Falls as the greatest water power resource of this country. Its possibilities as a competitor of the existing steam power plants, which drive the mills and transportation facilities of the country at large are almost unlimited. Under the daring industrial management of Mr. Ford it might very possibly prove the opening wedge in the development of water power and water transportation which would revolutionize industry.

Reports by experts as to the operation of the Muscle Shoals nitrate plant and dams under the proposal submitted by Mr. Ford have just been placed before Secretary Weeks for study. The reports will show just what the Government could expect to receive from the Ford plant and whether it could be accepted as a good business deal.

Muscle Shoals is a great industry gamble, requiring millions of dollars for development, enormous in its potentialities. Mr. Ford's proposition is to pay \$5,000,000 for the work already done and to assume the total cost of completion of the dams and power plants. The \$5,000,000 is just that much more than any one else has offered for the work done, and no one else thus far has come forward with an offer to defray the expense of completing the project. Recent reports indicate that counter-proposals of the power interests will be offered that the Government complete the work at its own expense, with some degree of assurance from a public utilities company that it will purchase power if it can be offered at a lower price than power now costs.

The following features of the Ford offer serve to balance in some degrees the great investment which the Government still would have in the property if such an offer is accepted.

First—he pledges himself to produce fertilizer for the farmers at a maximum profit of 8 per cent and virtually to turn over the direction of this feature of the plant's operation to a committee of farmers' representatives.

Second—he promises to keep one large nitrate plant in readiness for production of materials for manufacturing of explosives in the event of the war.

Third—the completion of the project would open the Tennessee river, which winds for many miles through Alabama, Tennessee and Kentucky to navigation.

The fertilizer proposal has aroused the keen interest of the farmers, who right now constitute the most powerful group in Washington. It is certain that they will not permit the project to die, but will insist that any other development plan at least shall be as favorable as respects fertilizer production as is that of Mr. Ford.

To sum up the practical situation, the Government is faced with the alternative of making some deal with Mr. Ford, obtaining a better offer from some other private interest or of going ahead with the expenditure of \$30,000,000 or more required to complete the work itself.

The Highland Park Plant of the Ford Motor Company continues to produce at the rate of 90,000 trucks and automobiles each month. The output for September was somewhat above this figure and the schedule for the production department for October calls for an equal number.

The sales demands and production travel hand in hand with the Ford Motor Company. The closeness with which this institution is able to work these two departmental propositions is one of the wonders of present day merchandising and sales.

I have it on very good authority, too, that the assembly plants throughout the country are operating at practically maximum capacity and furthermore that foreign trade conditions are continuing bright—with the Highland Park Plant making big knocked down shipments to Buenos Aires and Copenhagen, usually by the way of the port of New York.

Much to the surprise of most of us it is understood that the Ford Motor Company business in England is excellent—practically as good as it ever has been.

Considerable interest to students of economics is evidenced in one phase of the activities of the employees of the Ford Motor Company—namely that since the first of July more than 1700 employees of the factory plant in Highland Park have started investment accounts. The River Rouge plant and branches have also made substantial gains in investment.

The percentage of employees who are taking advantage of Mr. Ford's investment plan is remarkable. It is reported by those who are identified with the work, and apparently know, that more than 18,000 persons in the employ of Mr. Ford's many interests are finding the Ford investment plan a highly satisfactory means of investing their savings.

French News Notes

TAKE AWAY THAT "FORDY" LOOK!

Some months ago I sent you particulars of the Ford turned out by one of our manufacturers of Automobile Accessories, and incidentally the constructor of an "underslung" Ford Car. Since then I have seen a good many Fords running around with various changes brought to bear upon their noble carcasses, but have never seen more than one or two which really hid that very "Fordy" look which enables one to spot Lizzie among a 1,000 different models. There is not only the "look" but even the "sound" which seems different from other cars. Of course all Fordists are aware of these things. But it is becoming more and more difficult every day to recognize a Ford, even when looking straight at it, it has been in the hands of such clever men as Mr. Harry Crew, of London, and to whom I have previously referred in my February Notes.

Of course I am not the only Philistine who

the Motor Car buyer doesn't at all see why the body of his carriage should be a funny looking thing which everybody jokes about and even Musical Hall Artists make their audiences laugh over.

But we are getting over all that. The buyer of a Ford who has done so because of the real virtues of the Car (see Ford Avet. for full particulars of how 5 millions of them are "running round the Globe") doesn't extend his appreciation to "body". And he just sends the machine round to a fellow who understands how to make a suitable transformation, and there you are. The street gamins who are counting "every third a Ford" misses him out: The deception is complete. And to look at Mr. Harry Crew's Car, photo of which I send you herewith, I think you will have no difficulty in pronouncing that he has jolly well wiped out that "Fordy look". And may his shadow never grow less.

I haven't done more than just "refer" to the

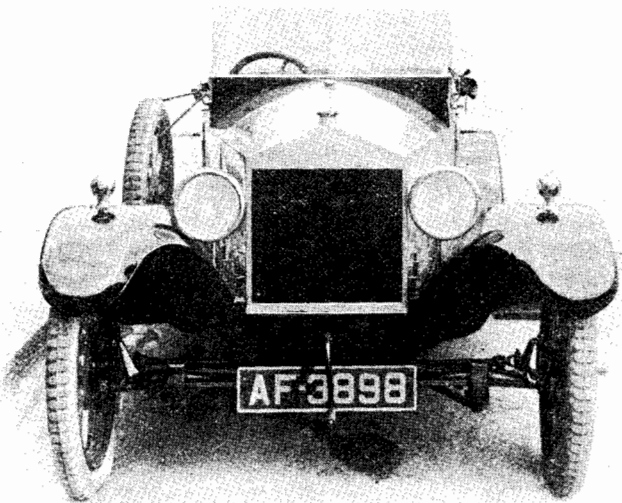

thinks that the Company at Detroit will someday later on give us an "European Ford". Whilst the body part of the Ford has seen very many improvements and electrical devices have been added in obedience to the law of progression, mainly the Ford of today is the Ford of 10 or even 15 years ago—which is spelling old age where motor cars are concerned. But the Car which was made to suit the roadways of America. In the modelling of such a car aesthetic notions had to stand behind utility and practicability, and we haven't those roadways over here. And what is more, the European person hasn't the same eye for form as the American. It doesn't matter a brass cent whether the American idea is better than the European idea. The fact remains that the man who pays the musician wants to chose the tune. And

"noise" of the Ford Car, but it is made a special point of very frequently in the derogatory references by so-called "wits". There was for instance a very clever fellow who could name all cars by their sound on starting. On being challenged he managed to successfully "name" several, and then a pile of Milk-cans happened to be upset and he immediately bawled out "Oh, that's a Ford!" And recently I saw a good Play spoiled at one point. Several people were supposed to be obliged to leave the house and their Motor Cars were waiting at the door. Somehow the stage-hands failed to make the noise usually associated with starting the cars and we had to be content without it. But several in the audience remarked sarcastically that the Cars had departed very quietly; they evidently were NOT FORDS!

Canadian News Notes

CLOSED CARS POPULAR A considerable increase is noted in the number of enclosed passenger automobiles in use in the Province of Ontario and no type seems to be more popular in this respect than the Ford sedan. A very fair proportion of sales by Canadian Ford dealers has been with the sedan model and widely diversified classes of people are buying closed cars.

Last year, there was an increase of 133 per cent in the number of enclosed automobiles in operation in Ontario, according to the official figures of the Ontario Department of Highways for 1920. Statistics covering the ownership of enclosed passenger models of all kinds are especially surprising.

According to the report just issued, the number of closed automobiles in Ontario at the end of 1920 was 9,664, this total being made up of 5,319 sedans and 4,345 coupes. For the year 1919, the total number of enclosed models registered was only 4,508, comprising 2,829 sedans and 2,339 coupes. Incidentally, it is expected that the increase in enclosed cars for 1921 will be proportionately greater than it was last year for several reasons—namely, the growing popularity of the enclosed types of automobile, dropping prices, wide improvement in Ontario's highways and the development of the all-season idea in mechanical and body details.

One Ontario Ford dealer showed recently that his automobile sales during the past year were made up as follows:—14 per cent enclosed models, 25 per cent commercial vehicles and 61 per cent open touring or roadster models. This same dealer expressed the opinion that the sale of closed cars and trucks would predominate this fall in the small car field and he expects a steady business throughout the winter with a fine turnover in closed cars.

FORD PRICES REDUCED Further reductions in the price of Ford cars in Canada have been announced by the Ford Motor Company of Canada, Limited. These reductions vary from \$45 for the runabout to \$100 on the sedan and coupe models. Prices quoted by Ford dealers at Toronto, Ontario, include \$550.75 for the Ford runabout without starting and lighting equipment; \$601.98 for the touring model without the equipment; \$1,042.50 for the sedan; \$940.03 for the coupe and \$740.33 for the electrically-equipped truck. The starting and lighting equipment for the roadster and touring models represents a difference of about \$87 at Toronto.

It is interesting to note that the Ford car as sold in Canada is somewhat different to the Ford which is marketed in the United States. The Canadian Ford touring car has four doors one-man top with glass windows, demountable rims, door flaps, spare tire carrier, sloping ventilating windshield and other differences.

MORE CARS IN WEST When considering automobile matters in Canada, the trade expert or motoring enthusiast is apt to talk about conditions in Ontario and Saskatchewan because these widely separated Provinces represent automobile leadership in two distinct fields. Ontario has many industries and varied geographical conditions. Saskatchewan in Western Canada is largely agricultural and is largely a rolling prairie with dirt roads that are dragged out at intervals improvements.

Special interest is, therefore, shown in the recent announcement of the Saskatchewan Government regarding the growth of the automobiles in that Province. It is shown that there are 60,325 cars registered during 1920 as compared with 55,010 in 1919 and 46,880 in 1918. This is considered remarkable in view of the fact that the total number of motor vehicles in Saskatchewan was only 74 in the year 1908.

The rapid increase in the use of cars is attributed to the rapid settlement of the Province and the prosperity achieved by the settlers in farm homes. Farms are frequently paid for in a single harvest and more than half of the automobiles in Saskatchewan are owned by farmers.

According to the statistics, the Saskatchewan farmers invested \$6,000,000, in 2,000 new tractors in 1920 at an average of \$3,000 per tractor. The average price is high because of the purchase of very large tractors by a considerable number of owners of extensive land.

Approximately half of the passenger automobiles in use in Saskatchewan are Ford cars. This is the same percentage for practically the whole of the Canadian West. Statistics announced by the provincial Government of Manitoba indicate that the number of cars in use in Manitoba at the end of 1920 was 36,455, an increase of about 25 per cent over the preceding 12 months and of this number exactly 18,370 were Fords. The next make included 4,248 cars and the list tapered down to just three English Sunbeams.

AUTO DEALERS MANY No less than twelve Ford automobile dealers are in business in the city of Toronto, Ontario's capital, which has a population of 525,000 people. This figures out at slightly less than 44,000 residents for each of the dozen dealers who are scattered throughout the city. These dealers include:—Bradley & Love, Limited; Wm. Candler & Co., Limited; A. D. Gorrie & Co., Limited; R. Howie, Limited; Keele & Moore, Limited; L. Newman & Co., Limited; Oakwood Garage, Riverdale Garage, Limited; See & Smith Motors, Limited; Toronto Motor Car Company, Limited; Universal Car Company, Limited; and W. C. Warburton & Company, Limited.

"That's enough, Bill. You know I get lots more mileage with these new B. G. Plugs."



The B.G. saves gas

Not theoretically but actually. You notice the difference from the minute B. G. Spark Plugs are put into your car. You get *maximum power yet save gas*. You adjust for a leaner mixture and don't have to choke your carburetor on a cold day.

It's this way. The monel metal Hot-Spark Disk heats up at the first explosions, and, together with the electrodes and porcelain, conditions the fuel entering the firing chamber of the plug so that when the spark occurs, a "shot-gun blast" of flame is fired from the plug into the combustion chamber of the cylinder, compelling complete ignition.

That means *maximum power and maximum gas mileage* right from the start. And the shot-gun blast scours the points at every explosion—the B.G. *cleans itself*. It is *guaranteed* against failure from carbon and fouling by oil. You *always* get a fat, full spark.

Maximum gas mileage—maximum power—guaranteed against carbon and oil—no cleaning necessary—money back if not satisfied—what other plug can give you so much?

Get a set of B.G. Plugs from your auto supply store or garage man. If he hasn't them, give us his name and address and we will supply you direct. Price, \$1.00 per plug. Please be sure to give name of car, year of manufacture, and number of cylinders.

THE B. G. CORPORATION
33E GOLD STREET, NEW YORK

B.G. SPARK PLUG

The Plug that Cleans Itself

When writing advertisers—Just say FORD OWNER AND DEALER

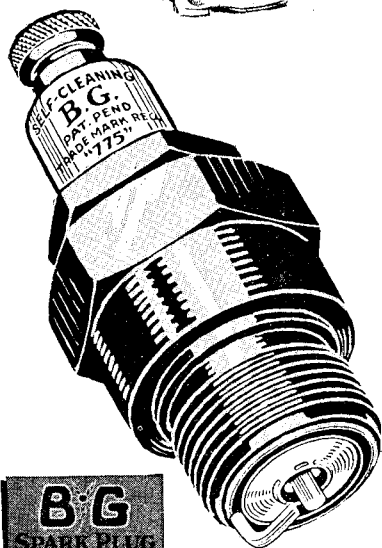

Ask your dealer or us for this B. G. Folder giving full information about the B. G. and its great saving in power, gas, money and trouble.

Equipment Review

A monthly department in which manufacturers are given an opportunity to furnish news and views concerning accessories, equipment and ideas for the Ford car.

STORM MOTOR DRIVEN REBORING MACHINES

CYLINDER REBORING MADE EASY

Conditions have been such during the past season that few new cars have been purchased and the old ones have been doing double duty and driven with little or no repair. This means that there is an unusual amount of overhauling and rebuilding to be done this winter, while the roads are bad, therefore the cylinder Reboring Machine and other equipment for doing this work is of utmost importance, and the shop properly equipped will reap big rewards.

Herewith is shown the new Storm Motor Driven Cylinder Reboring Machine. It is designed especially to meet the requirements of the average size garages when an electric current is available. It possesses a number of unique and important features that should be of interest to your readers.

The Machine is built extra heavy and rigid throughout, using the Storm Patented Power Machine Cutter Heads. Their heads, being supported by a heavy, rigid, hardened steel bar, which is ground to perfect accuracy and exact size. Extra long, heavy machine bearings give

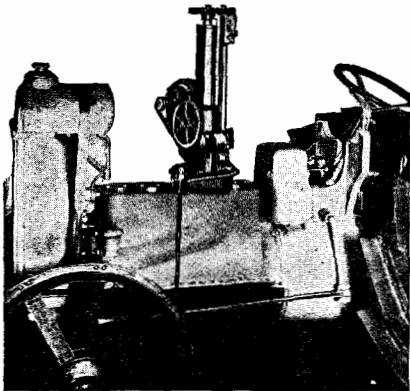

rigid support to the bar. These bearings are adjustable so as to take up any play and can be easily kept in perfect adjustment. Cutter Gears are used throughout a heavy internal feed screw and feed bar. Total capacity is 25-8 to 6 inches sufficient to take care of all sizes in common use. The machine weighs approximately 300 pounds.

A heavy base not shown in the cut is provided for use in connection with the machine for shop work, making it a permanent and convenient shop fixture, and yet it has the big advantage of being capable of use independent of the base as shown for reboring motors of all types without removing them from the chassis.

The Machine is furnished for boring only or for both boring and burnishing. The Burnishing Head consists of a hardened steel arbor having special shank to fit boring bar and is surrounded by a special tool steel roller all ground to exact micrometer size.

DASH LAMP FOR FORDS

Every owner of a Ford car will be delighted to know that now a really good and beautiful dash lamp has been put on the market, which

can be easily and quickly applied by anyone; no mechanic or electrician is necessary, as there are no wires to be cut or spliced.

The reader will please notice the extra long threaded shank with nut and washer, which permits this lamp to be applied perfectly on either an all-metal dash, or on a wood dash—metal covered, by simply boring a $\frac{3}{8}$ -inch hole in the dash, inserting the shank of the lamp, and tightening up the nut at the back. A sufficient length of cord is furnished with clip,

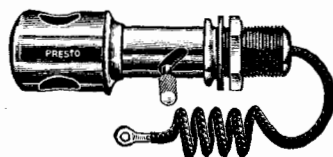

ready to slip over the tail light terminal connection on the back of the lighting switch on the dash, to make one side of the circuit. As the lamp is single contact in construction, the other side of the circuit is, therefore, completed through the rigid metal contact of the lamp flange with the steel dash or metal covering of the wood dash.

The lamp is equipped with individual lever switch—positive in action, durable and easy to operate—and threaded into a solid brass sleeve. The entire lamp is made of heavy brass throughout, beautifully nickel plated and hand polished, which will not rust or become easily scratched or marred; and is furnished complete with two candle power, 6-8 volt bulb. It retails for \$1.00 each.

The PRESTO Lamp is manufactured and marketed by The Metal Specialties Mfg. Co., 338-352 N. Kedzie Avenue, Chicago, Ill.

NEW WHEEL LOCK

The New York Coil Company of 338 Pearl Street, New York City, who for many years have been manufacturing a high grade line of Ignition and Automobile Accessories, have just placed on the market a Steering Wheel Lock, expressly designed for the Ford car, which operates on an entirely new principle and marks a decided change in Steering Wheel Locks.

The device consists of a stationary and movable housing, which is clamped on the outside of steering post by a yoke, the nuts of which are protected when wheel is locked. When thrown in the up position, two strong arms swing between two spokes, as well as **over** the spokes, so that the wheel cannot be turned in either direction, nor can the wheel be removed, a feature claimed to be entirely original.

The manufacturers lay great stress on the following features:—No interference or changing any of the original steering apparatus such as disconnecting wheel from steering mechanism, and the elimination of any plungers to jam or prevent wheel being turned. This feature prevents the possibility of accidents.

No key is employed to lock the device, which makes the securing of the car, with the wheels in the straight ahead or the right or left hand position, but the work of an instant. It is constructed entirely of Malleable Steel, which cannot be broken with the most heavy hammer.

No drilling, taping or machine work is necessary to install, which operation is accomplished, it is stated, in two minutes with a simple screw-driver by anyone. Price is \$7.50.

SHOK AN' SNUB

S an' S is the name of the newest device for smoothing rough roads for the Ford. It is a reliable snubber and dependable recoil check which is said to be highly satisfactory. It is constructed of a pyramid design of spring which absorbs road shocks and are said to result in floating noiseless action characteristic of the air suspended type of shock absorbers. The destruc-



tive return action of the car spring is gradually steadied and checked which results in far less wear on the springs.

S an' S is easily installed and is interchangeable with any model Ford car. It requires no adjustment and is quickly and easily lubricated. It is a product of Shok an' Snub Sales, Peoria, Ill.

FOR THE REPAIR SHOP

Big sales are being reported for the Watervliet Spiral Expansion Reaming Reamers for Ford piston pin bushings.

This is a combined Boring and Reaming Tool, with self cutting pilot which does the rough cutting, leaving the Reamer proper to do the finish reaming only. The Front Pilot guides for the beginning and the Rear Pilot guides for the ending of the reaming. Holes must be reamed in perfect alignment. You cannot do otherwise with this tool.



Left hand SPIRAL flutes insure against chattering or "digging in." Instead of Reamer jumping as with a straight fluted or straight bladed tool, WATERVLIET SPIRAL REAMERS cut easily and smoothly with a shearing motion, leaving a full bearing surface with a mirror-like finish. A slight turn of screw in end affords an even and accurate expansion.

Made of highest grade tool steel, properly machined and specially heat treated in electricity controlled gas furnaces, insuring a uniform permanent quick cutting edge. Cuts smoothly and quickly and will stay sharp. It is a product of Watervliet Tool Co., Inc. Albany, N. Y.

FORD TIRE CARRIER

The Shehan Tool & Machine Company at 502 East Ninth street, Los Angeles, is manufacturing an article that fills a long-felt want. They have developed and are now turning out in large numbers a Ford tire carrier that is serviceable, that adds to the appearance of the car, and is moderate in price. The carrier is finished in high-grade baked enamel with straps to match. It holds either one or two tires, mounted or unmounted, large or small size; fits the regular Ford bolts and may be installed in five minutes with a small wrench. This article deserves the consideration of every thoughtful Ford owner.

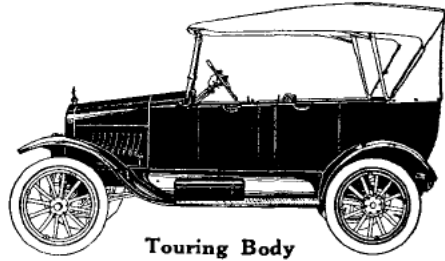

Touring Body

**Changing Your
FORD
FROM A
"DRESS SUIT"
TO
"OVERALLS"**

HERE'S the Inland Convertible Body that enables you to put your FORD to work. Above you see this smart body mounted on a Ford Chassis. A handsome improvement over your "old" Ford, isn't it. Looks like a \$3000 car. Made of the finest materials obtainable. Sweeping, graceful lines, beautiful top, French slanting windshield, distinctively designed cowl, and lustrous finish.

**The New
INLAND
CONVERTIBLE
BODY**

**CAN BE TRANSFORMED INTO A
HANDY TRUCK IN ONE MINUTE**

HOW IT'S DONE!

Without tools, with little effort, one man can shift the touring formation to a truck for light hauling and tourist travel. Back seat moves forward, to position of front seat, which collapses, at the touch of a spring. Rear panel becomes tailboard—and you have a strong truck, as in the illustration below.

Write for Full Particulars and
"Dealer Territory"

**INLAND AUTOMOBILE CO., INC.
INDIANAPOLIS, IND.**

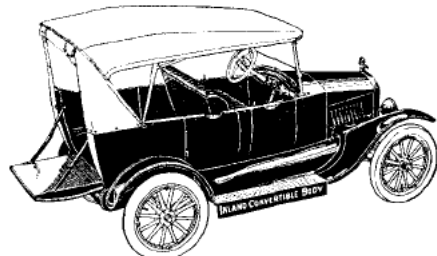

Truck Formation

**MILWAUKEE CONCERN BUILDS
EXTRAORDINARY TIMER**

A timer of most unusual design and operating principle, manufactured by the Eclipse Timer Manufacturing Co., of Milwaukee, has created considerable recognition among many Ford owners and dealers all over the country. This timer, known as the Eclipse Oil-Less, has several feature points in its construction. The rotor has no roller but carries a hardened coppered tool steel brush. This brush makes "wipe" against four radially opposed contact points, also of hardened tool steel, and mounted on a coiled spring.

Exceptional wearing qualities and a long life of timing is claimed by the manufacturer because of this construction. First: the timer is oil-less and has no oil hole for dirt, grit or grease to enter. Therefore, due to the cleanly condition of the contact surfaces, only a light pressure is required to insure perfect contact. Secondly: what little grit may work in around the shell does not obstruct electrical contact because of the self-cleaning and burnishing action of the rotating brush against the contacts.

Probably the most striking feature of the Eclipse is its renewability. For the small sum of 25 c. a complete set of replacements—a new brush and four contact points—can be purchased and a complete renewal made in a very few minutes without even removing the wires from the timer. With the fingers the four contacts

- 1—A timer that is exceptionally accurate.
- 2—A timer that requires no lubrication—no attention whatever.
- 3—A timer whose shell need be purchased but once in the life of a Ford or Fordson tractor.
- 4—A timer that can be quickly renewed any time, right on the road and at a cost of but 25c.
- 5—A timer that is so simple in construction that it can be sold at the low price of \$1.50.

The Eclipse Oil-Less Timer is being sold on a "2-week trial, money back" plan, and may be purchased from dealers or direct from the factory. Address Eclipse Timer Mfg. Co., 2907 Meinecke Ave., Milwaukee, Wis.

DESCRIBING AUTOVAC

Positively stopping oil leaks in the Ford engine is the mission which it is claimed is accomplished by Autovac, manufactured by the Craig Manufacturing company, Ensley, Birmingham, Ala., and which sells for \$3.00 in the United States and \$4.25 in Canada.

Autovac is a self-contained instrument and is not mechanically fastened in any manner to the engine.

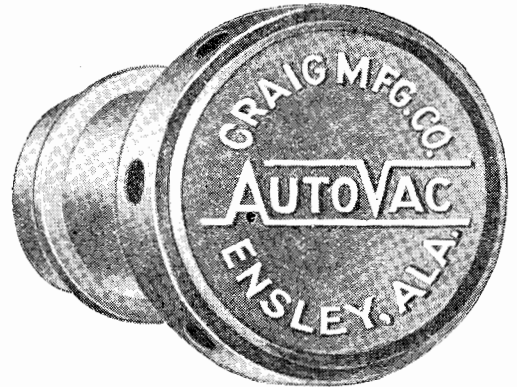
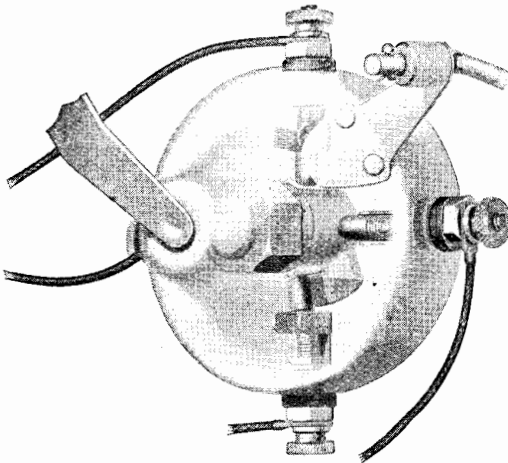

It automatically produces a partial vacuum in the crank case which has the effect of creating a perfect air seal on the engine, thus preventing the oil from leaking out at the various joints and bearings, it being a self-evident fact that where the air is leaking in, oil cannot leak out.

Another feature of Autovac is, that as air moves in an outward direction only through Autovac, no dust and grit can possibly get into the oil and wear out the bearings. This auxiliary feature alone makes it worth many times what it costs.

can be literally yanked out, spring and all, and the four new ones, including a new spring, simply screwed into place. The new brush can then be put on, claims the manufacturer, in no more time than it takes to replace a regular Ford roller.

The manufacturer of the Eclipse Oil-Less Timer claims that the main advantages of the Eclipse can be summed up as follows:

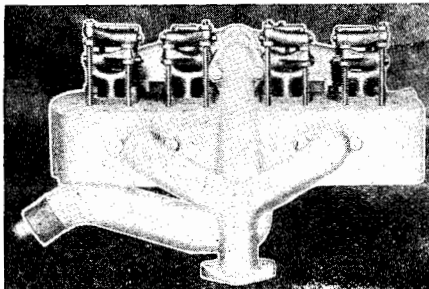

Roof 16 Overhead Valve Equipment for Ford and Dodge Motors. Fastest in the world. Doubles the value of your truck. Hill climbing for touring cars beyond your wildest dreams.

**Laurel Power Specialties
FOR
FORD and DODGE Motors**

SIXTEEN Valve Cylinder Heads; Racing gears; Racing bodies; Racing radiators; Worm and gear steering gears; 4-speed transmissions; Light pistons; Roller bearings; High speed camshafts; Parts for underslinging chassis; Counterbalances; Racing carburetors; Racing magnets; Also, counterbalanced crankshaft—one single forging.

**Largest manufacturers of Power and Speed
Specialties in the World.**

DEALERS: Write for illustrated catalog on the above and other parts for Ford and Dodge Motors. No matter what you want, we have it.

**The Laurel Motors Corpora'n
ANDERSON, INDIANA**

When writing advertisers—Just say FORD OWNER AND DEALER

CHANGES CORPORATE NAME

On November 1st the corporate name of the Milwaukee Auto Engine & Supply Company, Milwaukee, Wisconsin—manufacturer of the well known Milwaukee Timer for Fords—was officially changed to

Milwaukee Motor Products, Inc. The change is one of name only—there has been no change in the personnel or policies of the company. The new name was finally decided upon because it was considered simpler and more appropriate to the business.

THE DALECO TIMER

For several months past the Dale Manufacturing Company have been quietly putting on the market the Daleco Timer thus proving its quality by practical service under all conditions.

The outstanding features of the Daleco are a Bakelite case of evidently strong design, a true circular rotor of specially made fibre with a copper insert contact, and all brass and copper electrical circuit.

The distribution units are radially set in the case and timing is in no way affected by either

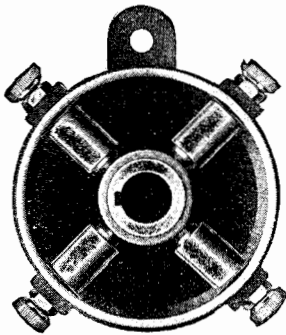

wobble or sidewise movement of the timer shaft. No lubrication is required and should grease or oil, working through the cam shaft bearing cover the rotor, the oil film is instantly broken by the wipe contact and quick starting assured no matter how cold the weather.

The material and construction is the best and the entire product is made to appeal to the requirements of those who want "A better timer."

Distribution to the trade is being made through The Zinke Company of 1317 Michigan Ave., Chicago, who are acting as the sales department for the Dale Manufacturing Co.

THE SPRINGS STAY OILED

The means not only of oiling the springs but of keeping them oiled is furnished by the use of Nifty Spring Lubricators. These little devices are quickly fastened around the thick part of the springs and the reservoirs which they contain are filled with oil. That is all that is necessary for this oil is automatically fed to the spring leaves and keeps them properly lubricated which means a saving of the springs, tires, and in fact the entire car. These sell for \$1.50 per set of four. They are products of the Springcup company, 302 Schmid building, St. Joseph, Mo.

COAST TO COAST WITH A-C BRAKES

The remarkable staying qualities of the Ford equipped with A-C Brakes is demonstrated in the 6000 mile trip recently taken by Mr. Yaeger and family of Chicago, Ill.

Early in August, Mr. Yaeger and family left for Los Angeles, taking the northern route, stopping at Yellowstone Park and other interesting places along the way. The Ford touring car carried 6 people and a dog and a camping outfit; and pulled a trailer.

Up and down the mountains, the Ford, as well as the A-C Brakes, was given the most severe tests; and upon his return to Chicago, Mr. Yaeger reported that all stops up and down the mountains were made without chatter, noise or strain on the mechanical parts of the car. The original set of A-C Brakes and the brake linings were in perfect condition.

Here's Perpetual Accident Insurance

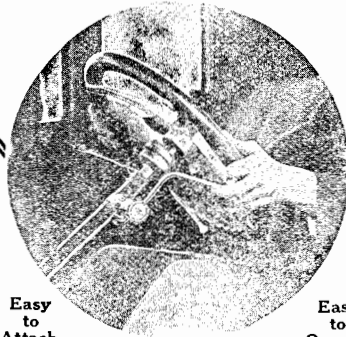

Easy to Attach

Easy to Operate

The Gilbert



ATTACHMENT FOR FORD HORNS

is a simple lever arrangement that can be readily attached to any Ford which has the horn button on the steering post. No boring, no riveting—no change whatsoever—simply slip the cap of the attachment over the horn button and TIGHTEN THE SCREW PROVIDED. The attachment is always at the finger tips—entirely clear of the spark and throttle levers—and can be reached immediately WITHOUT MOVING THE HAND FROM THE WHEEL. Guaranteed for life of car. If your dealer cannot supply you, send his name and \$1.00, and we will send a Gilbert Attachment, postpaid.

DEALERS—JOBBERS

Stock this greatest of all Ford accessories now. A quick turn-over proposition at a low price with a big profit to you. Write today and get in on our national advertising campaign.

Price

\$1.00



Rather Safe

Than Sorry

Manufactured by
A. GILBERT & SONS
BRASS FOUNDRY CO.
4000 Forest Park ST. LOUIS, MO.

RENTZ SPARK INTENSIFYING PLUG

What appears to be a practical item is the Rentz spark intensifying plug. With the device it is claimed that an intensively hot spark is procured and starting thereby facilitated. By lifting the intensifier switch on the plug and giving it a quarter turn. This brakes the contact in the center electrode and allows the cur-



rent to jump the gap and make a hotter spark at contact point.

This device is also recommended for cylinders which pump excessive oil. It is claimed that it will not foul and is guaranteed to increase power, economy and mileage. It is a product of the Rentz Spark Plug company, Atlanta, Ga.

THE NEW D-G DRAFT AND DUST PROTECTOR

A new invention that will greatly assist in making winter driving more comfortable, is represented in the new D-G Draft and Dust Protectors. These protectors completely close the openings around the foot pedals and emergency brake, preventing cold drafts, mud, dirt, and dampness from entering but does not interfere with the easy operation of the levers.

The D-G Draft and Dust Protectors are strongly constructed of heavy steel and especially prepared rubber. It principally differs from other protectors in that the protector for the foot levers is of ONE PIECE construction instead of two. This enables the rubber guard to be of ONE CONTINUOUS PIECE with no corners exposed to wear, as would be the case if it were made in two sections. Although of ONE PIECE construction, all floor boards can easily be removed.

The D-G Draft and Dust Protectors are fastened to the floor board underneath the carpet or mat and are inconspicuous. The retail price for the complete set is \$1.50. They are manufactured by the Dickey-Grabler Works, Madison Avenue and W. 193rd St., Cleveland, Ohio.

INTERESTING PISTON RING

Hundreds of repair men throughout the country today, instead of repairing the motor, if it is only slightly out of round, or slightly scratched, are fitting two 3-A Piston Rings and absolutely stopping the motor from pumping oil. Wayne Brothers of Warren, Ohio, wrote us the other day that customers that were formerly pests are now turning out to be good friends after installing 3-A Piston Rings.

The 3-A Piston Ring is designed not only to seal the cylinder wall, but to seal the top and bottom of the piston groove, giving the oil absolutely no chance to get up into the combustion chamber.

Motors equipped with 3-A Piston Rings show a mileage of anywhere from 150 to 300, depending on the condition of the motor; also give the maximum amount of compression, which means more power and speed.

The 3-A Piston Ring is manufactured by the Steel Spring Piston Ring Company, 147 Metropolitan Avenue, Brooklyn, N. Y. If further information is desired, kindly write for circular 30. The price of this manufacturer's Ford piston rings was recently reduced to \$1.00.

THE JIFFY JUMPER

A really practical item for saving the clothes while working around the Ford car is the Jiffy Jumper which sells for \$2.00 and is distributed by the American Specialty company, 706 Chestnut street, St. Louis, Mo.

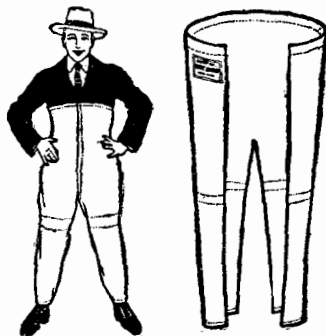

This can be put on or off in four seconds. It does not wrinkle the clothes and is made of the best grade Government Olive Drab Duck. It is kept firmly in place by flexible steel bands, and affords protection for the clothing while being a comfortable garment for work. Another feature is that it can be easily laundered.

CHAMPION TOOLS AND PRESENT CONDITIONS

In these days of judicious buying, products and commodities are preferred on the basis of quality and economy alone. The purchase cost and the upkeep cost together with quality, decide the prospective customer. It is a survival of the fittest.

In the main office of the Champion Manufacturing Company, 2908-10 W. Fletcher St., Philadelphia, Pa., the trend of the sales curve proves conclusively that their tools are meeting the "quality economy test" and forging ahead with increasing momentum.

Since the recent price reduction, made possible by demand, the entire line of Champion Tools, including the newly added wheel puller have found a tremendous market among the country's garage and repair men.

The Champion Reborring Equipment has long been known for its efficiency, reliability, ease and speed of operation, being able to re bore a Model T. Ford Cylinder Block in 30 minutes or a Fordson in 45 minutes, thus resulting in a remarkable saving of time and labor which are items of great importance in this period of conservation.

FOR PROPER CIRCULATION

Most Ford owners are aware that many troubles follow in the wake of faulty water circulation in the Ford motor at any time. In summer or while driving on steep hills or in sand or mud the result is an overheated engine. In winter it means freezing of the radiator. One good way to avoid these troubles is thru the use of the Reliable Centrifugal Pump for Ford cars which sells for \$7.50 and is distributed by the Auto Appliance company, 2845 Chicago Avenue, Minneapolis, Minn.

This is said to be a well made and very practical device for maintaining proper temperature and the result is a decrease in the consumption of gasoline and oil and the elimination of the many circulation systems and motors troubles which result from overheating or freezing.

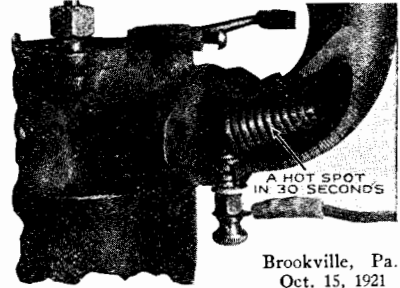

Brookville, Pa.
Oct. 15, 1921

EDWIN L. WIEGAND CO.,
Pittsburgh, Pa.

A "Hot-Spot" That Is
Hot Before Motor Starts

SURE START Type "A" is made in sizes to suit all cars having "detachable" manifolds. The Ford Special and 1-inch size can be operated by 4 to 6 dry cells on cars not battery equipped.

FORD SPECIAL, complete, price \$3.50

Other Sizes for All Cars

FOR SALE BY DEALERS AND GARAGE MEN.

Liberal Discounts and Display Set and Card
With Every Dozen Order.

DISTRIBUTORS WANTED

MOTORISTS—Install "Sure Start." PRIME WITH HEAT. That's usually what is lacking when your motor won't start. Switch off when motor is hot. If your dealer can not supply you send your order direct.

Manufactured by
EDWIN L. WIEGAND COMPANY
422 First Avenue, Pittsburgh, Pa.

Dear Sirs:—Sure Start Electric Hot Spot duly received and installed by my garageman.

Sure Start works perfectly and is surely some improvement. Frequently my car will stand out nearly all night at the hospital, where before I could hardly get it started using high test gasoline, I now start off as easily as if the car had been standing in a warm garage.

I have looked over your advertising and find that you do not mention one of the most important things that the Sure Start really does. I noticed it right away. Soon after the Sure Start was put on my car I drove it on a long trip without turning on the heat as it was fairly warm. I noticed immediately that the car was making hills easily on high that I had not been able to make on high before, after a little figuring I decided what was doing it, the cone of wire in the manifold breaks up the gasoline spray coming from the carburetor and serves the same purpose that several other devices on the market do that cost considerable more yet they have not the method of heating the vapor for starting that your Sure Start has.

You have a very valuable device and I am sure that everyone that sees it work will be a prospective purchaser.

Very truly yours,

H. A. O'NEAL, M. D.

Standard Radiator Cover



Spring Shutter Radiator Cover

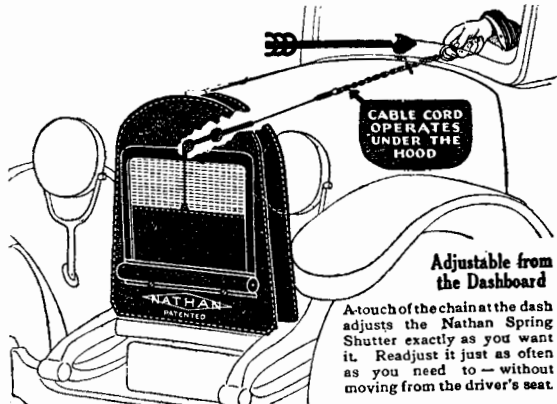
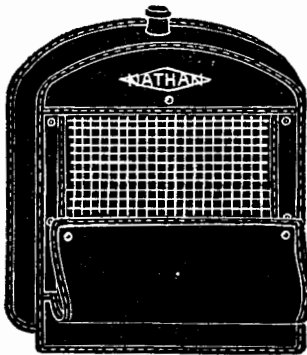

F. O. 477A Ford Rad. Cover only \$1.95
F. O. 477B Ford Hood Cover only 3.00

F. O. 361 Ford Radiator Cover only \$8.00
F. O. 477B Ford Hood Cover only 3.00

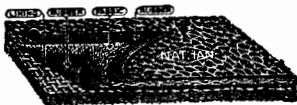

All Nathan Radiator Covers are made of a fabric coated with rubber and rubberized to lining—the best cold resisting and heat retaining fabric (see cut).

Write for catalog and discounts, show card and window display.

Nathan Novelty Mfg. Co.,
Dept. F. O. 55 Fifth Ave.
NEW YORK CITY

SIMON PRIMER

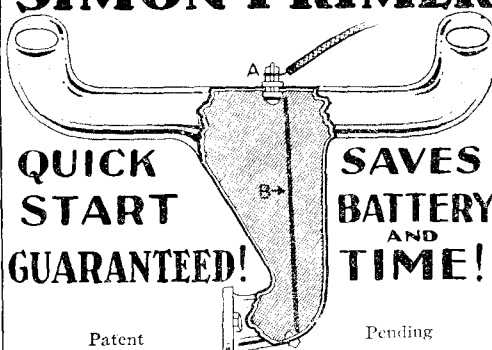

**QUICK
START
GUARANTEED!**

**SAVES
BATTERY
AND
TIME!**

Patent Pending

Complete with Manifold and Switch.
Simple instructions for installing and
operating.

Will Start Any Ford in 10 Seconds
ENTIRE MANIFOLD HEATED

Guaranteed for 2 Years

Order Now! \$5.00 Each

Jobbers and Dealers—Write for
quotations

SIMON SUPPLY CO.

207 N. 7th St.,

ST. LOUIS, MO.

**Eventually
You Will Use a
"Kemp Hotspot" Manifold**



ECONOMY demands that sooner or later you will
place this needed device on your car.

It is scientifically designed to give perfect and
uniform mixture of thoroughly vaporized gas and air
to all cylinders. With even the lowest grade fuel you
secure 100% efficiency.

It eliminates 50% to 75% oil pumping trouble due
to giving each cylinder a mixture of dry gas in which
the combustion is instantaneous and complete. This
keeps each and every cylinder firing regularly.

It increases mileage, eliminates 25% of vibration,
gives a snappy motor almost instantly, and permits
easy starting in all kinds of weather.

GUARANTEE

Use a Kemp for thirty days. If not entirely
satisfactory return it to your dealer who will
refund full cost. We stand back of every
manifold we make. If your dealer is not
stocked give us his name and order direct.

Price \$9.00 F. O. B. Muncie Ind.

DEALERS—Write for a Real Proposition.

KEMP MACHINE WORKS
1217 So. Franklin MUNCIE, IND.

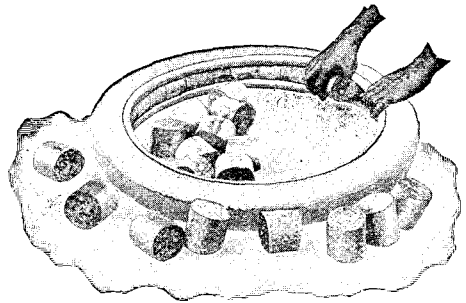

**SELLING BETTER
THAN EVER**

Car owners nowadays are keenly in-
terested in low upkeep—on tire mile-
age especially. That is one reason
why so many of them are adopting

**NATIONAL RUBBER
TIRE FILLER**

It does away with punctures, blow-
outs, vulcanizing, patching, tire-
troubles and repairing of all kinds.
Users get from 10,000 to 20,000
miles out of every tire—and have no
inner tubes to buy.

National Rubber Tirefiller has a
wonderful resiliency—takes the
place of air and rides as easy.

Made in sizes to fit all standard tires.
Can be used on all makes of cars
using pneumatic tires. A big seller
because it has made good

DEALERS—WRITE TODAY FOR
COMPLETE DATA

**National Rubber Filler
Company**

Rear 222 College Street

MIDLOTHIAN, TEXAS

Two Years Perfect Timing Guaranteed

IT'S HERE
The exclusive Herz Press Contact. Two little tool-steel rods. Pressed together by the cam. Firm, positive contact. Lightning fast break. Simple? Yes—and scientifically correct. And here's the case-hardened cam that presses the plungers into contact and releases them—like a trigger.

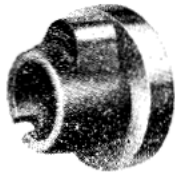
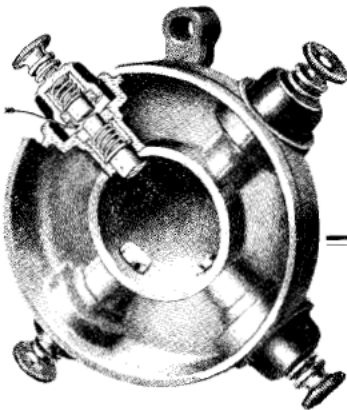

The Pictures Tell the Story

YOU need no expert to tell you why this is the only timer scientifically designed to cope with the Ford ignition problem. The only timer that gives you sparks exactly ninety degrees apart every time, all the time.

To jerk a vigorous spark out of your coil at cranking speed you need a lightning-fast break of the contact in your timer. Ask any repairman about this. In the

HERZ

Hammerblow Timer

The positive Press Contact is broken with lightning speed. The cam presses the plungers into perfect contact—then releases them with a snap. This instant break affects the vibrators like a hammerblow. With the Herz Timer your vibrators will never stick. There's no lagging after-spark, no unreliable roller or brush or raceway to burn and wear out.

Learn the joy of absolute confidence in your car. Put a Herz Hammerblow Timer on your Ford. You can install it in a few minutes. The Herz Timer will not alone start your motor at the first turn on the coldest day, but it will give you 20% more power than any short-lived timer. If you want a hard pulling, clocky idling, responsive engine—order a Herz Timer today.

Special Introductory Offer:

To introduce this unique timer we offer it to you at the special low price of \$4.75. You can buy it direct if your dealer has no stock. Remember—**Two Years Perfect Timing Guaranteed, or Your Money Back.** Two years peace of mind. That's worth \$4.75, isn't it?

Made of manganese bronze and tool-steel, the Herz Timer is finished with a care that limits production. To avoid possible disappointment order at once. Send no money now. Simply write or wire that you want a Herz Timer—and when it reaches you pay the mail man \$4.75.

HERZ INCORPORATED

*Inventor of the first Timers ever used
Maker of famous Bluestone Plugs since 1894*

Dept. A. 182 Locust Ave., New York City

Jobbers, Dealers and Repairmen: There's bigger profit for you in Herz Hammerblow Timers. And each one sold will sell many more. They'll make friends for you. Our progressive sales and advertising plans will move them off your shelves. Write for prices and discounts.



Recharge Your Battery
With This
Valley Charger

Send for this battery charger. Try it for ten days. See how easily and economically it will bring back the old punch to your battery.

If you are not satisfied that the Valley Charger will prolong the life of your battery, eliminate trouble, and enable you to keep your battery fully charged at all times,—then send it back to us. We will refund the purchase price immediately. No apologies on your part; no argument on ours.

The Valley Battery Charger will end your battery troubles. It will give your battery a full charge from your house line. Not necessary to remove your battery from your car, or even to disconnect the battery terminals. No trouble to use—plugs in on a light socket, just like a lamp.

Connects to your battery by strong clamps. Cheaper than a new battery. Makes your battery outlast your car.

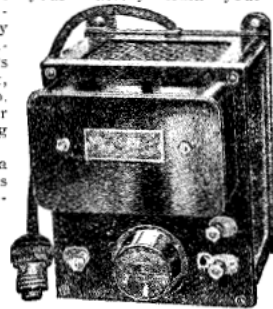

Price
\$16.00

Valley Electric Co.

Dept. F. ST. LOUIS, MO.

Get an Envelope and Mail This Coupon Now

Valley Electric Co.,
Dept. F, St. Louis, Mo.

I am enclosing money order (or check) for \$16.00 for which send me a Valley Battery Charger. If I am not absolutely satisfied, I will return the charger to you within ten days and you are to refund the purchase price.

Name

Address

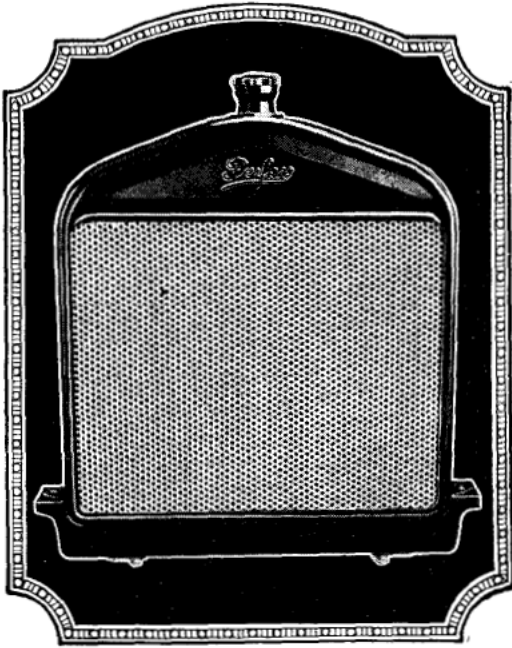

Frozen 10 Times and NEVER BURST

THE PERFEX RADIATOR is freeze-proof. As a guarantee we will replace, free of charge, any Perflex Radiator with core damaged by freezing.

We have reports of Perflex Radiators that were frozen 8 and 10 times without bursting. They will stand repeated freezing because of the unusual construction. Perflex is the original guaranteed freeze-proof radiator.

The flat corrugated water channels are of special, tough bronze, and their shape provides ample expansion possibilities, without damage. There are **no** seams at the front, and instead of the seam at the back being merely flat-lapped, it is lock seamed.

It is a convincing fact that 76 manufacturers use Perflex radiators as standard equipment. The Perflex will outlast and out-cool any other replacement radiator for Fords.

PERFEX

THE PERFECT RADIATOR

for Ford Cars

JOBBERS—Write for our proposition.

DEALERS—If your jobber cannot supply you, write us direct, giving name of jobber. Build a substantial and profitable trade on Perflex for Fords. Reasonably priced—within the reach of all.

Perflex Radiator Co.

Dept. J, RACINE, WIS.



What Do Customers Cost?

A customer is made and kept out of good-will—his good-will and yours. He will deal with you just so long as he gets satisfaction—by which he measures his money's worth. One way to hold a customer is through installing plate glass when accident breaks his window or windshield. That means satisfaction to him and his money's worth in the saving of eye-strain and nerve-rack in driving.

Plate glass is a separator, from dust and draught, that he doesn't see. It's so clear that he doesn't notice it. He doesn't have to squint through waves and curlicues like in common glass. He sees no objects multiplied by bumps and hollows. He just drives and easily judges passage room and short turns. Plate glass pays him, and installing it will pay you.

PLATE GLASS MANUFACTURERS of AMERICA



Nothing Else
is Like it

FORD MODEL

FITS EVERY MODEL T FORD

Simply remove a front hub cap and replace with the Dreadnaught Indestructible Hub Odometer. The Automatic Drive snaps into engagement and from that moment you get a continuous record of all travel forward or backward.

SALES AND SERVICE EVERYWHERE.

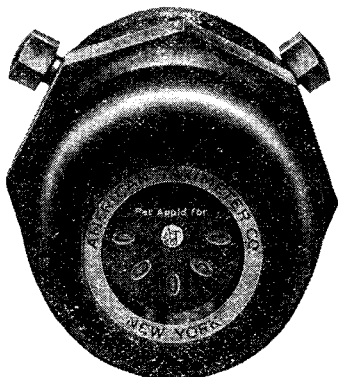

DREADNAUGHT INDESTRUCTIBLE HUB ODOMETER

With Automatic Drive

HOW much does it cost you to operate your Ford? Unless you know the mileage you can give no intelligent answer to this question. The Dreadnaught Indestructible Hub Odometer gives you an accurate record of every mile of travel throughout the life of your Ford. It goes on like a hub cap, no drilling or pinning—the Automatic drive takes care of that.

The Price is Fifteen Dollars.

AMERICAN TAXIMETER CO.

12 West 61st Street,
NEW YORK, N. Y.

Guaranteed for the life of the vehicle against leakage of grease or destruction by collision.

Special Odometer now made for Fordson Tractors—\$20.

HERE IT IS

The Perfect Timer for Fords at a Popular Price

You know the trouble Ford owners have with timers, with coils, and with vibrator points.

And you know that it is almost impossible to remedy these troubles without installing a costly, complicated high tension ignition system.

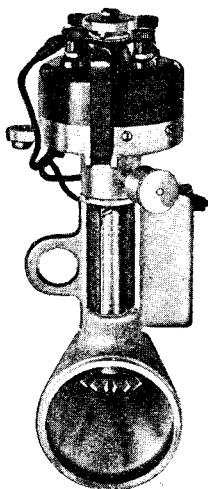

The MALLORY Single Unit TIMER

ends all this. It can be installed in 20 minutes and sells at a price that every Ford owner can and will pay.

The Mallory Timer will enable a Ford to throttle down to 3 miles an hour on high—to "pick up" quickly, smoothly and without vibration—in fact, a Mallory equipped Ford runs and handles as smoothly and satisfactorily as the finest cars.

You can't afford to pass up this wonderful opportunity for big profits. Our dealer's proposition with liberal discounts will interest the service station manager and make profits for him. Just say "we are interested"—we'll do the rest.

Auto Products Co.

1533-1537 S. Michigan Av.
CHICAGO, ILL.

Made by

**MILWAUKEE ENGINEERING
& TOOL CO.**

MILWAUKEE, WIS.

Avoid Needless Expense

There is just one way to avoid the expense and unsightliness of loose, cracked and rattling fenders on your Ford. Before the fenders break or loosen equip them with

I-NE-DA FENDER BRACES

These practical devices keep your car looking trim and neat, prevent breakage from vibration and hold the fenders firm against wobbling and rattling. Inexpensive and easy to install they constitute a thoroughly practical and economical item. I-Ne-Da Braces are supplied in one style which fits all models including the one-ton truck chassis.

RETAIL PRICES: FRONTS—PER PAIR—\$1.25 REARS—PER PAIR—\$1.00

All Prices F. O. B. Kansas City.

DEALERS AND DISTRIBUTORS—Some Good Territory Still Open. Write Today.

Manufactured by I-NE-DA FENDER BRACE MFG. CO., Kansas City, Mo.

Sales Department **Buckley Motor Supply Company** 2005 E. 15th Street
KANSAS CITY, MO.

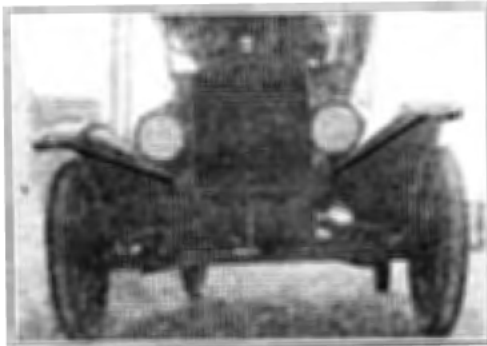

(Patent Applied for)



(Patent Applied for)

Nowury

Timer & Extension

PUT ONE ON YOUR CAR OR TRUCK

100 PER CENT
EFFICIENT

Use it for Ninety Days. If you are dissatisfied return it and get your money back. Every NOWURY Timer is guaranteed for the life of the car. All parts interchangeable and are replaced free of charge.

PRICE IN U. S.

\$6.00 EACH

East of Rocky
Mountains

NOWURY
TIMER

has all of the good features and none of the bad ones. THE ONLY PERFECT TIMER EVER MADE for Ford Cars and Trucks. You can go slower on high and pick up quicker than any high priced car on the market. Saves gasoline, does not require oil or grease and is water and dust-proof.

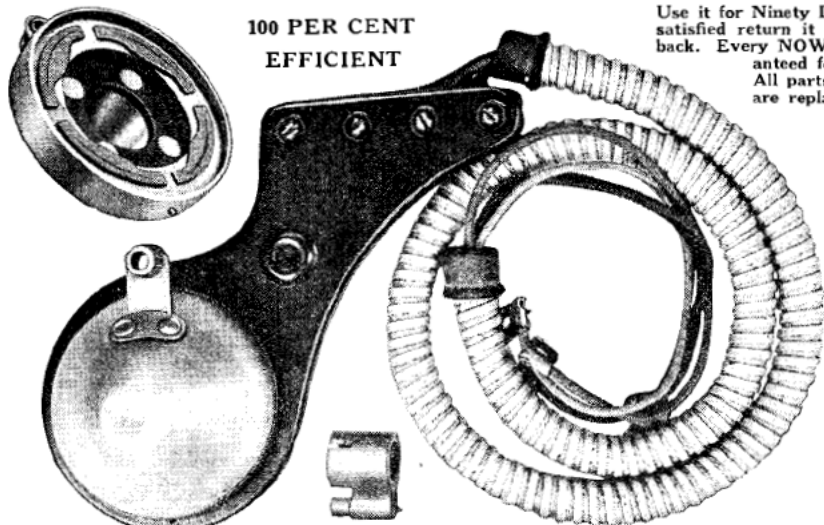

EQUIPPED WITH WIRES IN FLEXIBLE METAL CASING
ORDER NOW!
YOU CAN GET THEM FROM US IF YOUR DEALER CAN'T SUPPLY YOU

WORTHMORE Mfg. Co.

MINNEAPOLIS, MINN.
14-16 Western Avenue

We want a live representative in every county in the United States. Write today for the territory you want. This is a real opportunity for the right man to make good.

REAL BUSINESS BRINGERS —K-D LAMPS

No. 6
Electric
Head Lamp
\$7.50 per pair

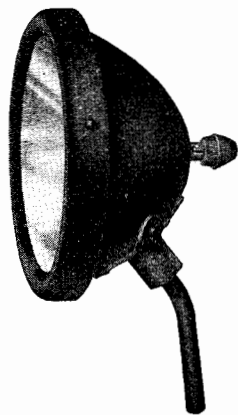

No. 31
Electric
Tail Lamp
\$1.00 each

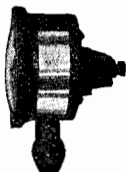

The K-D Line Specializes for Fords

Practically our entire output is devoted to producing lighting equipment for Fords. This concentration and specialization enables us to give you BETTER QUALITY FOR LESS MONEY EVERY TIME.

YOU profit by it. YOU save money.

YOU guarantee yourself satisfaction.

WRITE TODAY FOR
SAMPLES AND DISCOUNTS

THE K-D LAMP CO.
CINCINNATI, O.

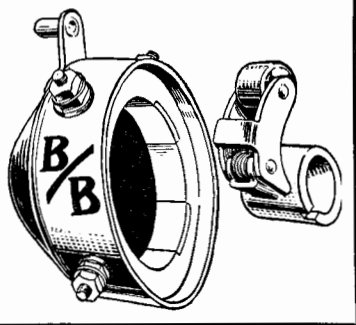

B/B

TIMERS for FORDS

Manufactured by Berg Bros. Mfg. Co.

ON 3 MILLION FORD CARS

The roller and segment type of timer has proven its supremacy.

That is why you get a sure thing when you buy a B/B TIMER. It has no complicated mechanism to get out of order or a fancy case to please the eye but strictly adheres to a simple design of recognized superiority, precisely built with fine materials.

When your present timer has served its time, install a B/B TIMER and see the snap, pep and power added to your motor, as well as an easy start regardless of weather.

The Price of the B/B Is \$1.50

Why Pay More and Get Less?

DEALERS AND JOBBERS—Write Today for Full Details
Sales Dept.

MARK W. HEATH, 920 Michigan Ave., Chicago, Ill.

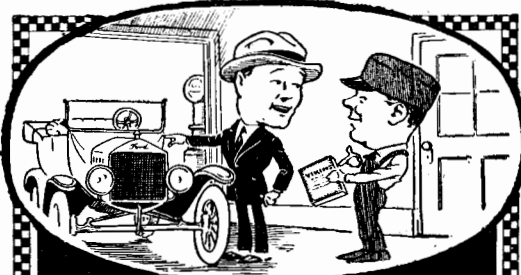

"---What's the cure for
grab, chatter, hesitation
waltz, palsy---?"

"Viking's what she
needs,---Always cures
and keeps 'em cured!"

VIKING

Transmission Lining - Exclusively for Fords

Sales Dept.
THE ZINKE CO., 1323 MICHIGAN BLVD.
CHICAGO, ILL.

Manufacturers
Vogt Mfg. Corp., Rochester, N. Y.
Works for More Than Forty Years

LOCKWOOD TIMER EXTENSION FOR Ford Cars and Trucks

Contact Plates

Contact Shoes

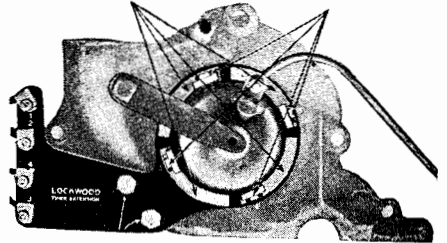

Bolts Holding Extension

LOOSE WIRES ELIMINATED
IGNITION TROUBLE SOLVED
SURE SPARK
EASIER STARTING
SMOOTHER RUNNING

PRICE

\$3.50

IN U. S. A.

DEALERS AND AGENTS WANTED

Lockwood Products Co.

307-9 Met. Bank Bldg.
MINNEAPOLIS, MINN.

A Readymade Stockroom



F-10 Unit Lyon Auto Parts Control for \$10,000
to \$12,000 Stock of Ford Passenger Car Parts

You Furnish the Stock-We do the Rest

AUTO PARTS CONTROL UNITS are shipped to you ready for use. All you need to do is put your parts in the bins.

An AUTO PARTS CONTROL UNIT saves time getting and putting away parts, saves 50 to 60% floor space, is a perpetual inventory of material on hand.

There is a Unit for every quantity of stock of Ford, Fordson, or Ford Tractor Parts.

Complete Information on request.

Lyon Metallic Manufacturing Company, Aurora, Illinois

AURORA
ST. LOUIS
NEW YORK
PITTSBURGH
PHILADELPHIA

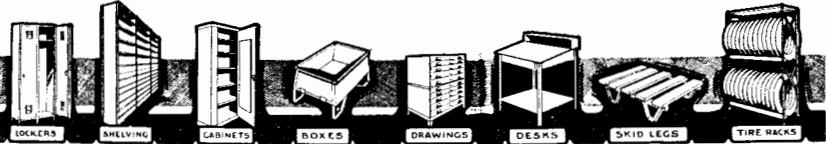

BOSTON
DETROIT
CHICAGO
ROCHESTER
CINCINNATI

When writing advertisers—Just say FORD OWNER AND DEALER

PRICES REDUCED

on

SCHRADER UNIVERSAL PRODUCTS

ON AND AFTER November First, Schrader Products can be bought at the following reduced prices:

- | | |
|------------------|--|
| Schrader | Tire Pressure Gauges, Now \$1.25 Each |
| | Were \$1.50 |
| Universal | Truck Tire Gauges . . . Now \$1.75 Each |
| | Were \$2.00 |
| Universal | Valve Caps Now 25c |
| | Were 40c (Per Box of Five) |
| Universal | Valve Insides Now 30c |
| | Were 40c (Per Box of Five) |

You need Schrader Universal Tire Valve Accessories to get the most mileage out of your tires. If your dealer does not stock them, send us his name.

A. SCHRADER'S SON, Inc.

Makers of the Schrader Universal Tire Valve

BROOKLYN, N. Y.

CHICAGO

TORONTO

LONDON

Marathon "O K" Electric Grinder and Buffer

\$25.00

Complete With Motor

Less than half the usual price for a tool of this size and capacity.

And, we also give you our 1 YEAR GUARANTEE, which entitles you to a new motor, should defects develop within the first 12 months.

Has 6 1/2 in. No. 60 Norton grinding wheel, and 6 x 3/8 in. Hanson & Van Winkle Cotton Buff.

Equipped regularly with the famous MARATHON OK single phase totally enclosed Alternating current motor; for 110 or 220 volt 60 cycle service. If Direct current motor is wanted, add one dollar for 32 or 110 volt; or \$2.00 for 220 volt.

Has convenient and reliable switch in base. Machine is shipped complete with standard plug and 10 ft. cord, ready for use.

SELL TO CAR OWNERS

Buy this handy tool for your own shop, and put it where your customers can see it. Every car-owner who likes to "tinker" will want one in his home garage or workshop for grinding knives and tools; polishing silverware, and countless other uses. Sell the tool at \$45.00 to \$60.00 and still be below the market.

SEND CASH WITH ORDER—Or, if you prefer, we will ship by Express C. O. D. Above prices are net, F. O. B. Wausau, no discount; and subject to change without notice.

MARATHON ELECTRIC MANUFACTURING CO.

25 ISLAND STREET.

WAUSAU, WISCONSIN

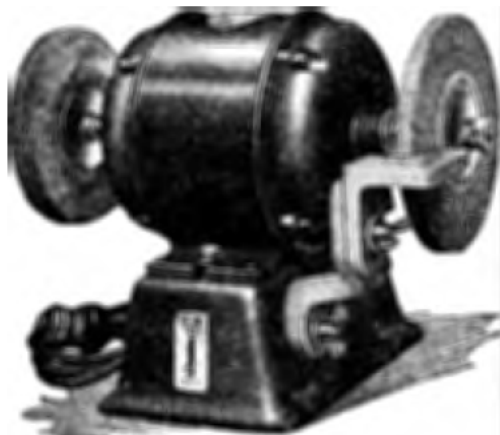

Quick Detachable MAGNETO CONTACT POINT

Insures Perfect Ignition

NO MORE greasy shirt sleeves, dirty hands, or backaches once this quick Detachable Point is installed. A necessity when Re-Lining the transmission of a Ford, as the Contact Point can be removed while removing the transmission cover, thus giving more space, and besides the Contact Point is not liable to be bent or broken, thus giving a rather poor contact after replacing the cover.

**PRICE
\$1.00
POSTPAID**

Dealers and Garagemen—Write for our very interesting proposition on this fast selling article.

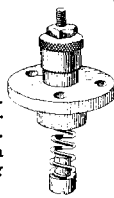

As Contact looks on Transmission Cover 4 Point Contact Instead of one

TO INSTALL

Simply remove old type contact point and replace in the same position the quick detachable assembly.

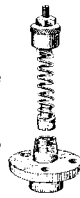

As Contact Point looks removed to clean Can be used as Ignition Lock if so desired

To remove, Clean and Replace this new type Plug requires but a fraction of the time ordinarily required, and WITHOUT THE AID OF A SPECIAL SCREW DRIVER.

MERTON L. BRITT

139 HUGO STREET,

SAN FRANCISCO, CALIF.

There's A Good Steady Demand For Dunn Fender Braces

Dunn Fender Braces are very popular and sell quickly at good profits for you. Every Ford owner wants to protect his rear fenders from damage. Sell him Dunn Fender Braces. They prevent breaking, twisting, rattling, and other troubles that happen to Ford rear fenders. They will give him complete satisfaction and bring you more sales.

Their low price has made them a favorite with Ford owners. Price \$1.00 postpaid. One length fits all models. Write for discounts and information.

This Instructive Book Is Free—Send For It

This valuable book, which you can get absolutely free, tells how to prolong the life and increase the power, speed and endurance of automobile motors. Explains where aeroplane and racing motors get their amazing power and tells how the power of the above motors may be increased tremendously. It's very instructive. Every owner, dealer and garage man should have a copy. Send for it.

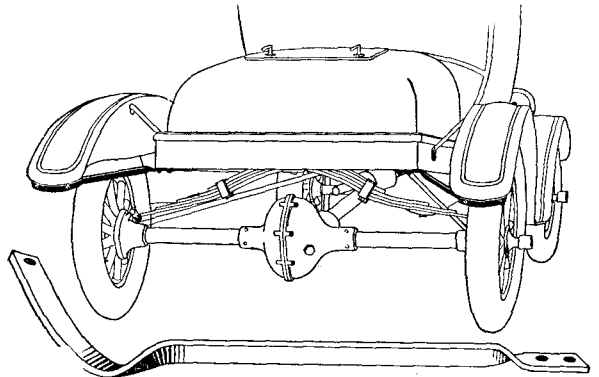

Dunn Manufacturing Co.

(Dunn Sales Co., 250 W. 54th St., N. Y.)
Dept. F. D., Clarinda, Iowa.

When Your Ford Radiator Wears Out Replace It With a McKinnon Radiator

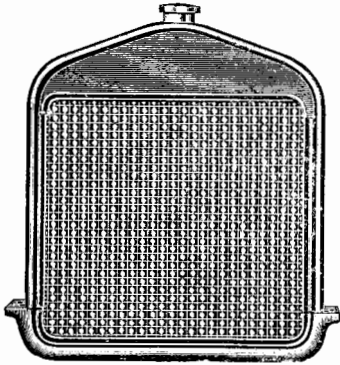

A New McKinnon Core can be put
in your old Ford Radiator shell.

Ask your repairman about the
McKinnon Radiator.

McKINNON DASH CO. (Radiator Division)

250 AMHERST STREET,

BUFFALO, N. Y.

Over one million McKinnon Type Radiators in daily use on Overlands, Buicks,
Willys-Knights and Oldsmobile 8's.

Because their "really cellular" construction is practical—it cools the motor properly.

Because McKinnon Radiators are strong and durable.

Because complete dipping in pure solder prevents pinhole leaks and internal corrosion.

Because expansion takes care of strains from freezing.

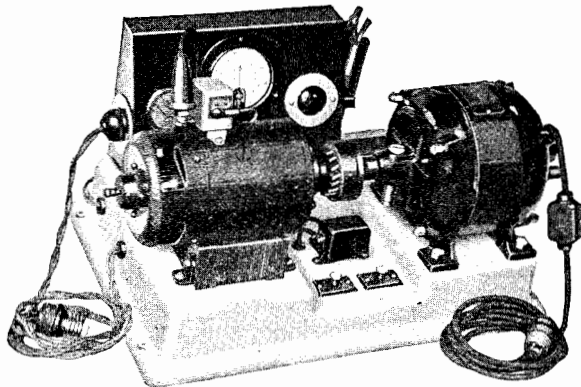

For the Service Station or Garage

Service station men have been looking for a satisfactory test stand for Ford generators and armatures which would do the work quickly and accurately. Here is the New

ELMCO Junior Test Stand

This is as efficient as the Elmco Liberty model used everywhere. Junior is smaller and designed

successfully and which sells for \$260. The Elmco especially for Ford service needs.. It costs only \$120.

The Elmco Junior requires no clamps or holding vise to hold a generator. A growler, which also acts a magnetic clutch, holds a generator without vibration and like a vise of steel.. All that is necessary is to pull the switch and the generator is locked securely in position.

A ¼ H. P. General Electric motor is used to drive the generator and the coupling needs no adjustment to hold the generator gear. A high grade ammeter and a voltmeter are mounted on the instrument board together with a trouble lamp and test prods. The switches which control the motor, cut-out and clutch are in plain sight and within easy reach. The base of the machine is made of aluminum.

Your jobber has a stock. Order from him today.

THE ELECTRIC MACHINE COMPANY
INDIANAPOLIS, INDIANA

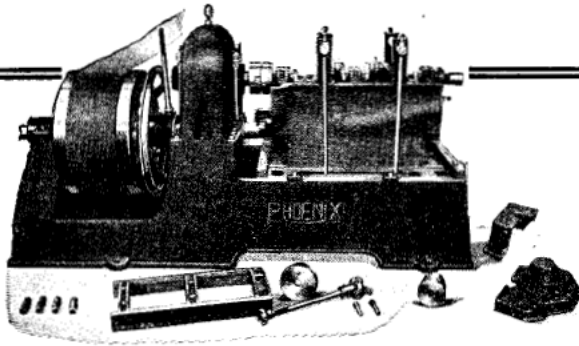

Features such as three-to-one gear reduction; universal couplings; SILENT operation; universal limbering-up attachment; ease of alignment; new and improved running-in fixture; rigidity; perfect balance; make Phoenix the foremost machine of its kind in America.

PHOENIX

Burns-in and Runs-in All Makes of Motors

You need the weight and stability of the Phoenix Burning-in and Running-in Machine. Pound for pound, it is the most inexpensive repair shop investment you can make—and the **most** profitable. The materials and workmanship are Phoenix Quality and Phoenix Standard throughout.

New and improved Phoenix Running-in Fixture saves lifting fixture from machine, saves oil draining and prevents oil waste. Fixture operates on sliding bar arrangement.

Write us today for folders showing this and other Phoenix Garage Machine Tools in action.

PHOENIX MANUFACTURING CO., Eau Claire, Wis.

Johnson Carburetors for Ford Cars

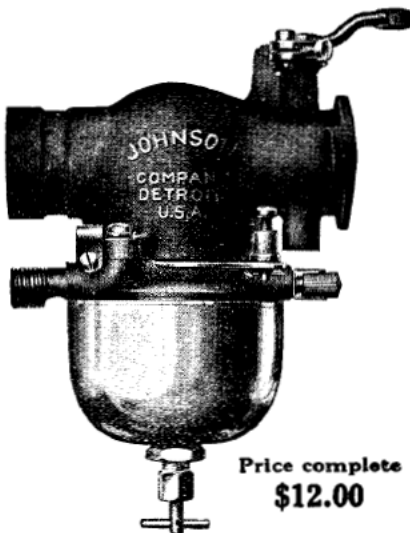

Price complete
\$12.00

**Counts Every Drop of Gasoline.
Makes Every Drop Count.**

Strainers for Ford and Maxwell Cars.



**Traps the Dirt. Fits Any Ford.
Price \$1.25**

JOHNSON COMPANY, 1909 Forest Ave. E., Detroit, Mich.

AUTOVAC Cuts Your Oil Bill 34 to 50% Stops All Oil Leakage Through Gaskets and Bearings

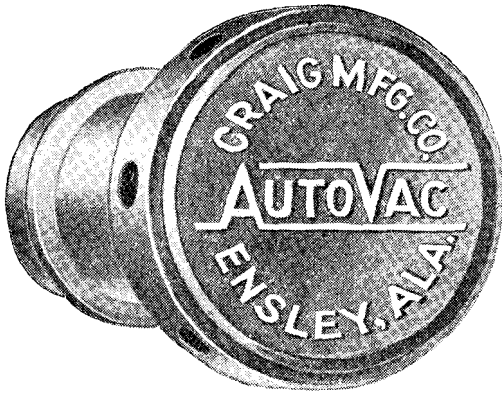

Keeps road dust out of the crankcase, gives better lubrication and lengthens life of your motor.

ENGINEERING TESTS made at ARMOUR INSTITUTE of TECHNOLOGY, Chicago, shows an oil saving of 34.2%.

AUTOVAC is a self contained instrument that takes the place of your regular breather cap. It automatically produces a partial VACUUM in the crank case which creates a perfect air seal on the engine, thus preventing the oil from leaking out at various joints and bearings, it being a self-evident fact that where air is leaking in, oil can not leak out.

RETAIL PRICE \$3.00

SOLD ON A MONEY BACK GUARANTEE. Order one—use it 30 days and if not satisfied, return it and get your money.

MANUFACTURED BY
CRAIG MANUFACTURING CO., INC.

ENSLEY, IN BIRMINGHAM, ALA.

Liberal Discounts to DEALERS AND SALESMEN.

Write for Proposition and Territory Desired.

DISTRIBUTORS

AUTOVAC SALES CO., Ensley, Ala.
AUTOVAC CO., Louisville, Ky.

EWART JOHNSTON, Winchester, Va.
J. C. ARCHER, Sparta, Ga.

DAVIS TIRE AND ACCESS. CO., Nashville, Tenn.

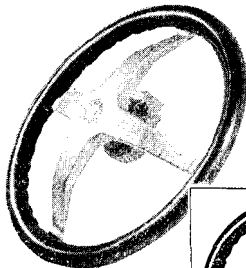

The Security LOOSE WHEEL LOCK FOR FORDS

Four Uniform,
Sturdy Spider
Arms — Safety
—Strength.

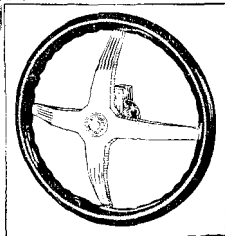

First of all, it's honest-to-goodness thief proof. It has the quality appearance that appeals to every car owner. Easy to install—does not change original design of steering parts—is absolutely safe in driving position. Never gets out of order, as proved by five years of use and universal satisfaction. Four uniform, sturdy spider arms and 17-inch genuine walnut corrugated rim give safety, strength and good looks. Reasonably priced. Easier for dealers to sell—at profits equal to or better than less satisfactory locks.

FORD DEALERS: Write at once for our FREE Demonstration Offer and Prices.

SECURITY AUTO LOCK CO.
410 N. Paulina St., CHICAGO

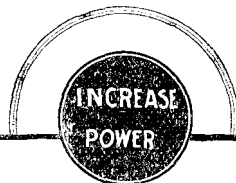

Pressure Proof Piston Rings

Pat. Mar. 2, 1915—Feb. 29, 1916
will restore the original power of the weakest motor. Lost power is usually the result of accumulated carbon or lost compression. Pressure Proof Rings permanently prevent this by making it impossible for either oil or gas to leak by the piston. Recommend and install Pressure Proof Rings—it will pay in good-will as in dollars and cents.

**PRESSURE PROOF
PISTON RING CO.**

107 Massachusetts Av.
BOSTON, MASS.

Canada:

Pressure Proof Rings,
Ltd.
Sun Life Bldg.,
Sherbrooke, Quebec.



Ford Owners Want This Good Looking Efficient Radiator Shutter—Only \$2.00

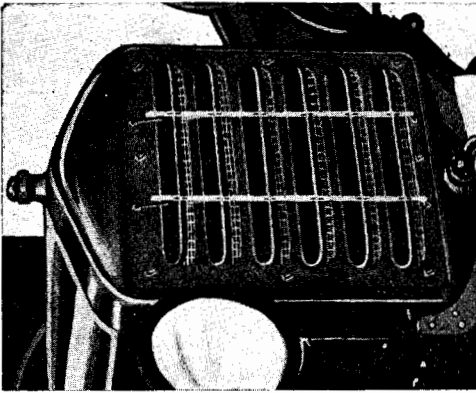

State Distributors, Jobbers and Dealers are building big profits on the

Saves its cost in gas in a few days. Makes Starting easy—saves the battery.
 Constructed of Waterproof leather-like fibrous material.
 Attached Easily and Quickly.

If your dealer can't supply you, we will send yours prepaid on receipt of \$2.00 and your dealer's name.

Essential Automotive Products Co.

507 WEST 42ND STREET, NEW YORK

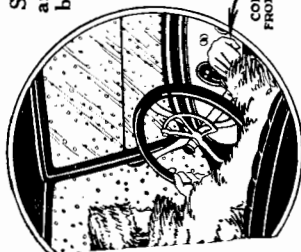

Earn More Money!

\$200 to \$500

A Month for Trained Men

Trained men wanted everywhere. Auto jobs pay big money. 10 million autos, trucks and tractors all need service. In every section garages, tire repair shops, welding shops, electric service stations, are needed. More men wanted. It all means a great future at certain big pay to ambitious, go-getting men. You can do it.



My Money Back Guarantee

I personally guarantee that a course of training in the Michigan State Auto School, will qualify you for a position as repair man, demonstrator, auto electrician, garage man, automobile dealer, tractor mechanic and operator, chauffeur or farm lighting expert; or refund your money. Each course includes Life Membership with privilege of School without charge at any time.

A. G. ZELLER,
 President and General Manager
 MICHIGAN STATE AUTO SCHOOL

No Experience Necessary

Make a start. In a few weeks under guaranteed training you can become a first-class, all-around, practical auto and tractor mechanic, capable of filling any garage-job. Or, become an auto electrician. Go into business for yourself. There are jobs open everywhere and Detroit trained men are preferred.

Learn the Trade at the Auto Center

Factory Endorsed School

Come to Detroit—to the Michigan State Auto School. Train head and hand by factory endorsed methods. Latest equipment supplied M. S. A. S. by famous factories. Detroit is the logical place to learn the auto-trade. Here, a nickel car-fare will take you to the world's great auto plants, or to more than two hundred and fifty auto accessory factories.—Here is the heart of the business. No other place can give you the same opportunity for first-hand knowledge.

Start Any Time

Stay as Long as You Like

Train for the big money jobs on Money-Back Guarantee. You can take a full Automotive Course, or, specialize in any one of its money-making branches. You can take a **Special Electrical Course**—be an Auto Electrician. Learn Tire Repairing. Be a Battery Service Man; a Chauffeur-demonstrator; Repair-man; Welder, Machinist.

FREE Big 188-Page Catalog

Decide Now that you can make more money! Decide now to make a success! You can do it! Learn all the interesting facts about this unlimited opportunity. We will send you FREE without obligation, 188-page book that tells all about it—and what the M. S. A. S. can do for you. Book is positive proof. Don't fail to get it. Send name and address. A post card will do. **Write today.**

MICHIGAN STATE AUTO SCHOOL

"The Detroit Auto School"
 A. G. ZELLER, President
 3052 Auto Building
 3729 Woodward Avenue
 DETROIT, MICHIGAN



Train Head and Hand



HALF-SIZE ILLUSTRATION

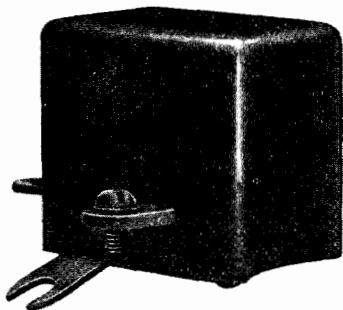

LIBERTY GENERATOR CUT-OUTS

Are Built to Last!

Strong drawn metal cover protects mechanism from dirt and damage.

The heavy metal stamping used throughout prevents Cut-Out from being thrown out of adjustment by vibration or while being assembled on generator.

There is no coiled spring to become displaced, lose its tension, or need adjustment. Heavy, broad contact points of sterling silver insure perfect contact, and ample current carrying capacity.

The main insulating parts, being made of Bakelite material, which is not affected by heat or moisture, prevent shrinkage or warpage that causes damage through misalignment of parts, as is the case with fibre so generally used.

Care is taken in bringing out the ends of the pressure winding by having them made of several braided strands of wire, instead of a single fine wire which is liable to breakage or corrosion.

Like all "Liberty" products it is guaranteed for one year against electrical or mechanical defects.

EXCEPTIONAL PROPOSITION FOR DEALERS AND GARAGE MEN

Price \$2.50

**Algonquin Electric
Manufacturing Corporation
POUGHKEEPSIE, N. Y.**



We Challenge Contradiction of Our Claims GET AN EXPERT'S OPINION

We are asked every day to explain wherein our TWIN SPRING SHOCK ABSORBER differs from the SHOCK ABSORBER in general use today. The answer is easy and clear to you. The great majority of SHOCK ABSORBERS in use today are nothing more or less than a brake applied on the leaf springs, which retards their action and prevents them from doing the work for which they were intended. They REDUCE the spring capacity of your car instead of INCREASING it, as should be the case.

TWIN SPRING

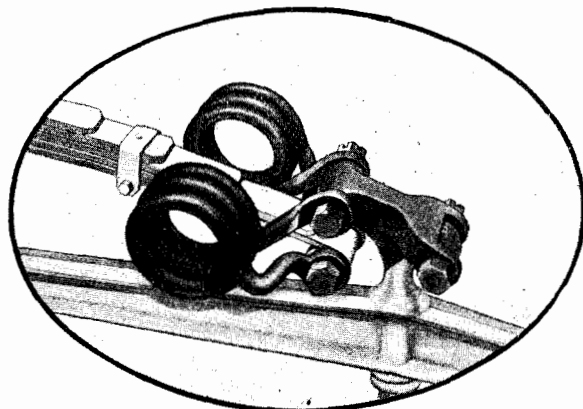

SHOCK ABSORBERS

For Fords

Front and Rear Set Complete \$20.00 List

The TWIN SPRING SHOCK ABSORBER is a SUPPLEMENTARY SPRING, instantaneous in its action. The principle and result obtained therefrom is entirely foreign to the so-called SHOCK ABSORBER. TWIN SPRING SHOCK ABSORBERS are FREE TO ACT in every way in conjunction with the LEAF SPRING. They not only leave the LEAF SPRING free to perform the work for which they were designed, but they assist them to perform that work. Every road shock coming from the wheels passes through the TWIN SPRING SHOCK ABSORBER (see those coils) on its way to the body of your car. The shock is transformed and reduced, the LIFE is taken out of that shock right there, and that without in any way disturbing the action of the leaf springs. Let us prove to you, Mr. Car Owner, that our statements are correct.

TWIN SPRING SHOCK ABSORBERS add to and do not detract from the lines of the car.

Write for Agent's Proposition and Prices

TWIN SPRING SALES CO.

266 Essex St.,

SALEM, MASS.

The Beautiful Kensington Top for Fords

\$112.50—FAST PROFITS AT THIS LOW PRICE

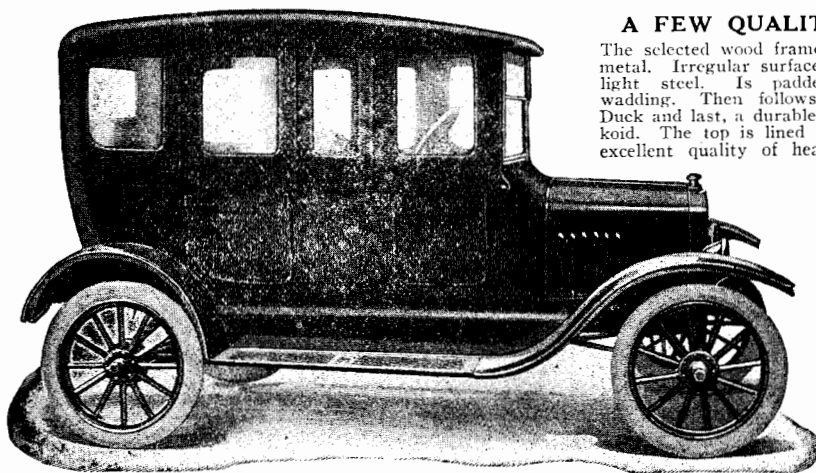

A FEW QUALITY DETAILS

The selected wood frame is reinforced with metal. Irregular surfaces are covered with light steel. Is padded all over with wadding. Then follows a cover of 8-oz. Duck and last, a durable, rich-looking Fabrikoid. The top is lined throughout with an excellent quality of headlining. All glass is set in a wood frame. The three removable sashes on either side, can be easily removed separately.

The thrifty Ford owner will thank you heartily for calling his attention to this outstanding Closed Top opportunity.

A Top that gives a Ford the beauty, style and comfort of a high-priced limousine.

A distinctively designed All-Season Top that transforms the old bus into a trig, smart sedan at only \$112.50. Can't you just SEE the fast profits you'll make at this low price—right at the beginning of cold weather—the biggest selling season for Kensington Closed Tops!

\$85.00—PRICE OF TOP FOR FORD ROADSTER

DEALERS—Competition cannot overcome quality at a price. Get our good proposition now

MONROE BODY COMPANY, Ludington, Mich.

Cronk Simplex Three Speed Selective Type Transmission

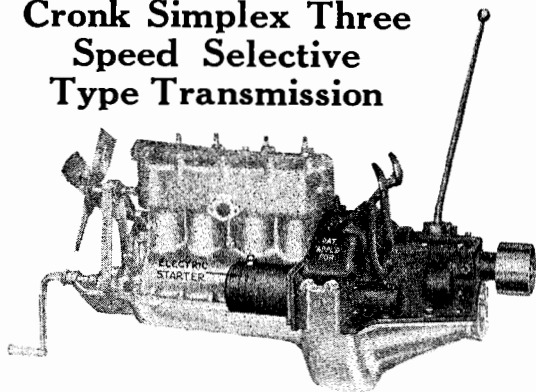

SPEED and POWER



This is the transmission that made possible the winning of the recent Pike's Peak Hill Climb by a Ford car. Its positive second speed and real stamina, due to design and construction will mean just as much for you in every day use.

Every dealer can sell this transmission because its exclusive advantages defy competition. It is reasonably priced and offers a real margin of profit. No mechanical changes, it's just an assembling job. Over 1,200 are making good in all sections of this country.

Every Fordowner a prospect—Write for details

E. D. & A. F. CRONK, Inc., Utica, New York

136 HOTEL STREET

The Locking Wheel of Absolute Security

No Keys
to Lose

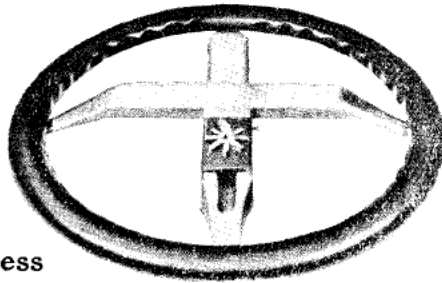

No Numbers
to Remember

The Keeno Keyless

STEERING WHEEL LOCK FOR FORDS

It is operated by position. Cannot be picked, broken or sawed. The lock is surrounded by case hardened steel.

No danger of accident with Keeno. The safety bolt prevents it from becoming disengaged while driving.

Combination operated easily in the dark without removing gloves.

Keeno for Fords is sold to authorized dealers.

GUARANTEE:—Use Keeno for 60 days. If you are not satisfied your dealer is authorized to return your money.

DISTRIBUTORS:—We need a few live men to distribute to Ford dealers. Profitable territory still open. Write.

Approved by National Board of Underwriters. Price \$15.00

KEENO KEYLESS LOCK CO. 2738 WEST RAILROAD AV.
EVANSTON, ILL.

Broken Arms Prevented From Ford Cranking

Non-Kick Device
Makes Cranking Safe



Made of best Malleable Iron.
Guaranteed against breakage.

Former Price \$4.00. \$2.50
NEW REDUCED PRICE Postpaid

Any time the Ford Motor fires back or kicks, the "Non-Kick" Device automatically disengages the clutch, allowing the motor to reverse without injury to yourself or car. Thousands of satisfied users. Better than insurance because it prevents sprained wrists, broken arms, with their pain and suffering, inconvenience and doctor bills. Easy to install—only one nut to remove; slips right on over handle; a child can put it on in three minutes.

Thousands Hurt Each Month
Big Field for Agents

Newspapers and statistics show thousands hurt each month cranking Fords. About 5,000,000 Fords without starters. Only 30% of 1,250,000 cars Ford will make in 1921 will be sold with starters, so Ford People tell us, leaving 875,000 new cars sold without starters.

Agents Make \$150 to \$400 Per Month

"Non-Kicks" sell easily and quickly. Burnett, in S. Carolina, sold 144 in two weeks. Get the facts—let us prove to you what a big money-making proposition this is for you. You can make money fast if you have the territory—write today, or better still, order a sample device now.

Try a "Non-Kick" 10 Days at Our Risk

Don't take any more chances cranking. Order a sample "Non-Kick" Device at our new special low price of \$2.50 (cartons marked at \$4.00 price) and try it on your Ford for 10 days, and if not satisfactory return it and your money will be refunded. Don't wait until you have an accident. Order one now, or SEND NO MONEY, simply your name and address and pay the postman \$2.50 on delivery.

Non-Kick Device Co.

793 Central

KANSAS CITY, MO.

Why Have Cutout Trouble? Use BASCO GENERATOR CUTOUTS

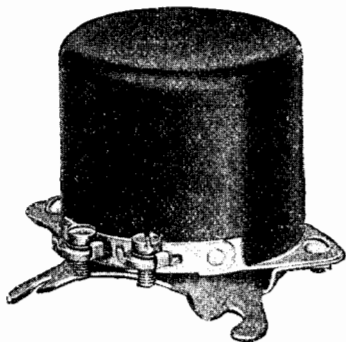

Basco generator cutouts have larger pure silver points, heavier series windings, and higher resistance shunt coils than any other make on the market, and are assembled with rivets, and not with screws which loosen with vibration.

These advantages insure satisfaction with Basco cutouts. They are guaranteed to give satisfactory service.

Basco cutouts are manufactured by pioneers in the cut-out business. You cannot afford to use any other if you want your customer to have real service.

BRIGGS AND STRATTON COMPANY

Milwaukee



Wisconsin

The FORD SPECIAL STORAGE BATTERY

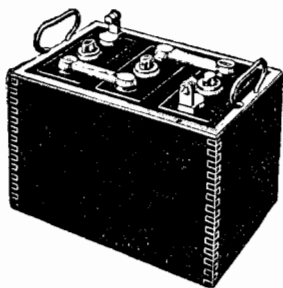

\$16.75

*F O B Kansas City - - Fully Charged
Ready for Installation*

NO MIDDLEMAN'S PROFIT. SHIPPED DIRECT FROM FACTORY.

A SPECIAL

Rugged constructed, long lived storage battery. Designed by expert Battery Engineers to withstand the hard knocks and rough use on Ford Cars.

Guaranteed for One Year

Independent Storage Battery Company

Accompany order with
draft or post office
money order.

Gateway Station
KANSAS CITY, MO.



Seven Successful Years

Stop Your Ford With A-C BRAKES

Eliminate All Chatter and Jar Forever

The past seven years have been successful for everybody concerned with A-C Brakes. Thousands of Ford Car and Truck Owners are satisfied that A-C Brakes are the only brakes in the world that will eliminate all chatter and jar forever.

Every stop as smooth as velvet.

A-C BRAKES are easy to install. They do not interfere with present emergency brakes or shock absorbers.

A-C BRAKES lengthen the life of the Ford Car and make driving a pleasure.

A-C BRAKES are sold by all automobile jobbers and dealers; and are backed up by A-C distributors maintaining Service Stations in all principal cities of the U. S. as well as in foreign countries.

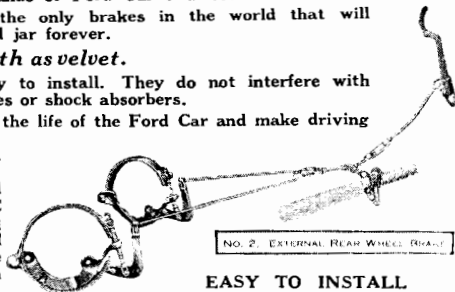

NO. 2. EXTERNAL REAR WHEEL BRAKE

EASY TO INSTALL

A-C MANUFACTURING CO.

2251-2255 W. GRAND AVE.

CHICAGO, ILL.

SEVEN SUCCESSFUL YEARS

Model T
\$16.00

Ton Truck
\$25.00

DEALERS!
We have a money proposition for you.

Write for the story of the A-C Brake.

Stops the Glazing and Chattering

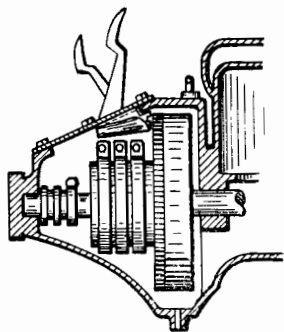

FIG. 1 simple—good things usually are—and easily put on by anybody.

You know the need for this article—put yourself in position to supply that need for your customers. Every user is a booster; every dealer an enthusiast.

PRICE \$1.00

Write for Jobber and Dealer Proposition.

W. J. Miller Company

Third and Main Sts.

COLUMBUS, OHIO

When your customers can entirely eliminate the transmission band chatter in Ford cars, prolong the life of the bands six months, and stop jerking the rear axle and gears to pieces, all for one dollar, will they hesitate?

The Miller Ford Lubricator

forces the oil onto the transmission bands. The flywheel, acting as a propellor, forces the oil into the lubricator funnel, giving a constant flow of oil, preventing glazing, chattering or charring. It's

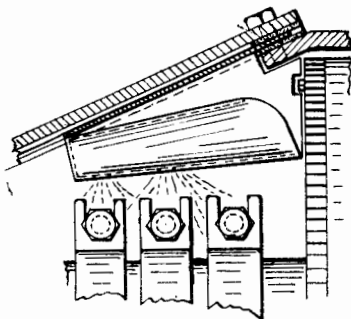

FIG. 2

THIS DOUBLE DUTY ABSORBER ON YOUR FORD WILL POSITIVELY PAY YOU PROFIT AFTER THE FIRST WEEK INSTALLED



SHOK AN' SNUB

Here is the one combined shock absorber that absorbs road shocks and snubs or checks the sudden recoil of your springs. No other shock absorber gives this two performance control. Shok an' Snub Absorbers are sold under 10 days free trial. Your Ford will look better and ride better. Send for descriptive circular.

SHOK AN' SNUB SALES CO.
629 Franklin St., PEORIA, ILL.

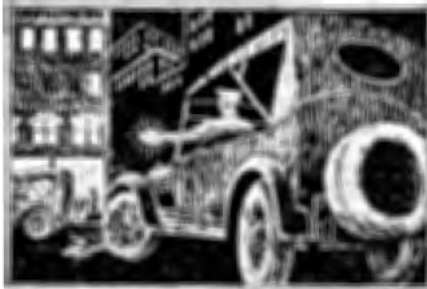

Fits on Hand Like a Glove

ATTENTION! THE AUTO-TRAFF FLASH SIGNAL GLOVE

WARNS IN A JIFFY

Red light on back flashes warning instantly when hand is extended for signal.

SIMPLE—PRACTICAL—DURABLE

Dealers Write for Proposition—Retail for \$2.00

Banner Sales Corporation

Manufacturers

1512-F Locust Street
ST. LOUIS, MISSOURI.

R. B. M. GENERATOR CUT-OUT FOR FORD CARS

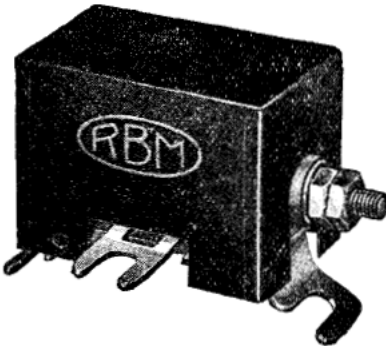

Manufactured by Redinger Ball Morris Mfg. Co.

The efficiency of the entire electrical system is dependent upon the cut-out.

THEN WHY NOT USE THE BEST

The R. B. M. Cut-Out is designed and built by experts, men who know.

The design is simple and the construction Staunch and Durable.

The coils and core are perfectly balanced, contact points 94% pure silver, brackets of pressed steel, all metal parts rust proof.

Every instrument thoroughly tested before shipment and guaranteed to give perfect satisfaction.

Sold Through Regular Channels Only

JOBBER AND DEALERS WRITE FOR PRICES

Sales Department

MARK W. HEATH, 912 S. Michigan Ave., Chicago



IF YOUR ENGINE CAN'T BREATHE Your Car Won't Go

That's the Principle of

The VENN AUTO-LOCK

FOR FORD CARS

Locks the passage of gas in the manifold. The surest and safest way to lock your Ford. Easy too. Just insert your key, give a 1/4 turn to the right and your car will be there when you return. Corbin lock, each one different. Not necessary to raise hood to lock. Easily put on.

TAYLOR-SHANTZ CO.

482 St. Paul St.

ROCHESTER, N. Y.

Money Back If Not Satisfied
Price \$10 Cash With Order
DEALERS AND AGENTS WANTED

When writing advertisers—Just say FORD OWNER AND DEALER

NEW PRICES ON CHAMPION PRODUCTS

So successful has been the performance of Champion Tools that demand has permitted the following price revision.

Champion Ford Model T	Champion Wheel Puller	
Reboring Outfit Complete.....	For Ford Model T.....	\$6.00
\$150.00	Champion Wheel Puller	
Fordson Reboring Outfit	for Ford Ton Trucks.....	\$8.00
Complete	Cutter Heads for Reboring	
\$160.00	Outfits Exchanged for.....	\$2.50
Champion 22 in. Back Geared		
Power Feed Drill Press.....		
\$200.00		

Hand or Drill Press Attachment for Reboring Outfits Optional
ECONOMICAL, FAST AND ABSOLUTELY ACCURATE

CHAMPION MFG. CO.

2908-10 W. FLETCHER ST.

PHILADELPHIA, PA.

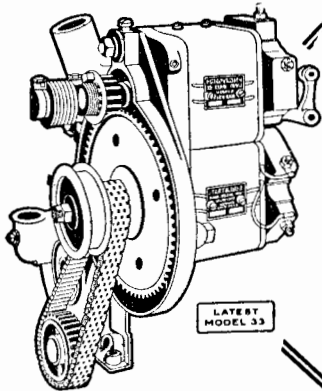

\$49.75 Buys a Genuine HEINZE-SPRINGFIELD Starting and Lighting System.

Price includes Ammeter, Dash and Tail Lights, Lock and high-grade Battery of standard make. A quick sure start and bright steady lights all the time. Light and starter buttons on dash. Installation simple. Everything complete. As efficient in winter as in the summer months. Limited supply at this bed-rock figure. Order today—or write us for further details. Address

The Service Products Co., Dept. C. Springfield, Ohio.
Western Rep.: NORMAN COWAN CO., 451 Rialto Bldg., San Francisco
Texas and Oklahoma Rep.: M. J. LA DUE, 4310 Thomas Ave., Dallas, Tex.

THE LIGHTS O' THE NIGHT

THE SUPREME ELECTRIC PARKING OR SIDE LAMP



Furnished with white light to the front and ruby light to the rear as danger signal. Fits the fender or can be used in pairs as side lamps. Full nickel-plated, each \$3 Black with nickel door, each \$2.75

THE ALADDIN ELECTRIC SIDE LAMP

For all Ford Sedans and Coupes.

Attached in a Jiffy. Will also fit all Ford Touring or roadsters made prior to 1920. Full nickel-plated, pr., \$5 Black with nickel door, per pair \$4.50

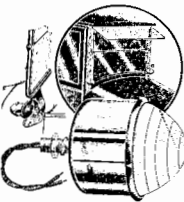

HAWTHORNE BULLET LAMPS FOR ALL FORD CARS

STYLE B BULLET SIDE LAMP

The only lamp made that will fit the 1920 and 1921 Ford Touring and roadsters without any drilling or alterations. Attached in two minutes' time. Full nickel-plated, per pair, \$6.50. Black with nickel door, per pair \$6.00.

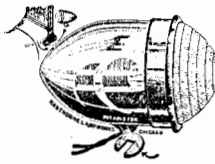

For Sale by Reliable Dealers and Jobbers the World Over. If your Dealer or Jobber Cannot Supply You, Send Us Your Order. We will find your nearest Dealer or Jobber for You.
HAWTHORNE LAMP WORKS, 1410 Michigan Avenue, CHICAGO, U. S. A.

10c Charges Your Storage Battery At Home With An F-F Booster

Which is a Magnetic Rectifier for 105-125 Volt 60 Cycle Alternating Current. Leave Your Battery just as it is, in your car. Snap Charger Clips on battery terminals. Turn Switch and lock garage door, knowing Your Battery will be Charged in the morning. Meters show you just the amount of current flowing. No skill required to operate. Everything Complete in One Compact Portable Charging Unit, Automatic Pool-Proof, Lasts a Life-time. Adjustable. Carbon electrodes rectify current lasting thousands of hours. By starting car quick, thus requiring fewer new batteries. Booster saves more than its cost. Do not think your battery is dead and worn out simply because it will not start your car.

Buy a Booster and Fill It With Life. By Buying a Booster, You Save Money. PRE-WAR PRICES Bantam Type 6 charges 6 volt battery, 6amps. \$15 Bantam Type 12 for 12 volt battery 5amps \$15 Type 166 charges 6 volt battery at 12 amperes \$24 Type 1612 for 12 volt battery, 7 amperes, \$24 Type 1626 Combination Type charges both 6 and 12 volt batteries at 12 and 7 amperes. \$36

The Larger Types are recommended for the heavier batteries or where time is limited. Shipping Weights complete with AMMETER and BATTERY CLIPS, 12 to 15 lb. Order from your Dealer or send check for Prompt Express Shipment; Include Postage and Insurance charges for Parcel Post Shipment or tell us to forward C. O. D. Order Now or Write Immediately for FREE Descriptive BOOSTER Bulletin No. 14.

F-F Rotary Rectifier for Group Charging

Real Economy in First Cost and in Service. Charges up to 36 cells. Full Wave, Automatic Dependable. Write Immediately for FREE Descriptive ROTARY Bulletin No. 14-A. Other F-F charging apparatus operates on Farm Lighting Plants & D. C. Circuits

The France Manufacturing Co. General Offices and Works: CLEVELAND, OHIO, U. S. A.
Canadian Representative: Battery Service and Sales Co., Hamilton, Ontario, Canada

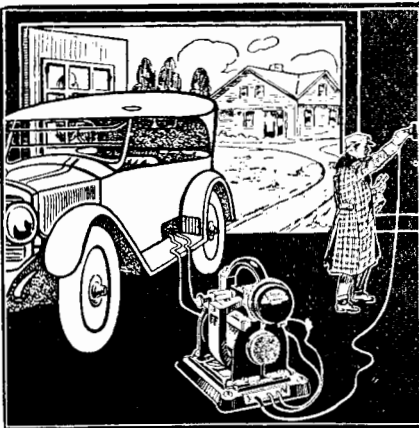



STOP THE GREASE LEAK
PAT. NOV. 16 1920

STOPS THE GREASE LEAK

R & R Automatic Grease Retainers

FOR FORD AND CHEVROLET CARS

Prevents loss of grease and from getting on tires, brake drums or wheels.

No Special Tools Necessary to Install.
Simply Remove Wheel and Roller Bearing, insert

R & R AUTOMATIC GREASE RETAINER

and Your Grease Troubles Are Over

If your garage man or dealer cannot supply you send \$2.50 and a set of two will be sent you, postage paid.

WRITE FOR EXCLUSIVE TERRITORY
Manufactured by
THE MACORVEY COMPANY
Wabash Building PITTSBURGH, PENNA.



THE HANDINO B

An instant change from the old Ford Door Handle to a Neat and Accessible Door Opener. Will not rattle, loosen or tear clothes. Attaches instantly. Prevents bruised fingers from opening the old style Ford door. Will last as long as the car itself. Not a luxury but an absolute necessity—Made of highly polished specially alloyed aluminum.

Price Per Set of Three, 85c. Single, 30c.

THE PERMUTOLOK

The only combination lock on the market having perfect action. It is mechanically correct, neat, strong and easily opened. Always ready for service. Can be used on tool boxes, spare tires, garage doors and for any other use that locks are made for. Full instructions with every lock.

Price Each \$1.00.

If your dealer does not have the above items in stock pin money order or check to this add and forward to us. Articles will then be sent at once.

THE KA-ES MFG. CO., 2049 W. 22nd St., Chicago, Ill.

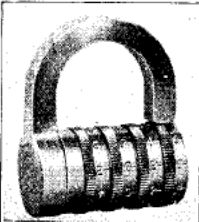

DEALERS:— Write for special proposition. Fast selling and repeat order articles.



E-Z-4-U Filler and Gauge, Model E, Price \$10.00

Let 'er Rain or Snow

With the
E-Z-4-U FILLER AND GAUGE
Attached to Your Ford

SIT STILL—watch the gauge register the gas you buy. **Saves Gas—Time—Money.**

E-Z-4-U Pedal Grip Model 21, Price \$6.00
Holds Low Speed Pedal for hill climbing=PLEASURE. A positive neutral stop for coasting down hill—saves discs and bands=PLEASURE+ECONOMY.

E-Z-4-U Floor Board Lock
holds boards in place. Saves boards and prevents accidents. Price 35c.

E-Z-4-U Products=PLEASURE+Safety+Money Saved
All E-Z-4-U Products covered by Money Back Guarantee.

Good exclusive territory open for State Distributors and County Agents

CUSTER MFG. CO., Dept. E., Stoyestown, Pa.
Patented 10-8-21



THE "OFF" END

THE "ON" END

MARQUETTE MFG. CO. PATENTED

A GRIP LIKE A GIANT HAND

The "quick action" Marquette Tire Tool "takes them off and puts them on again." Removes and puts back on all size clincher tires. We guarantee it to do the work. An attractive dealer proposition. Write at once.

WE WANT DEALERS NOW
DEPT. F.

MARQUETTE MFG. CO., Inc.

ST. PAUL, MINN.

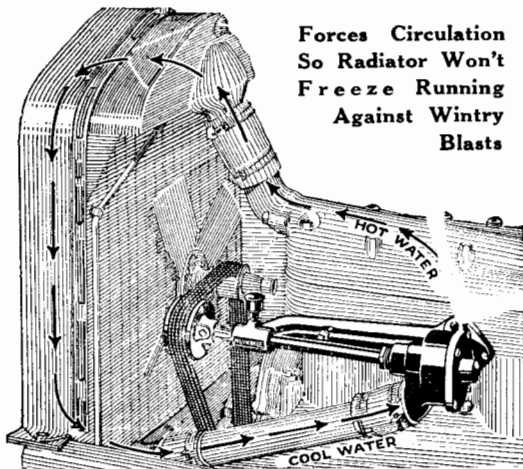

MILWAUKEE
CIRCULATING WATER PUMP
FOR FORD CARS AND TRUCKS

The Standard Water Circulating Pump
FOR FORD CARS AND TRUCKS
PREVENTS QUICK EVAPORAION
OF ALCOHOL

Protects from Freezing in Winter—
Prevents Overheating in Summer
Get Yours Now

CRAMER MFG CO. Dept. B. Milwaukee, Wis.
387-389 Tenth St. C. N. & F. W. Jonas, Sales Rep.

IN
PLAIN
VIEW
ON DASH

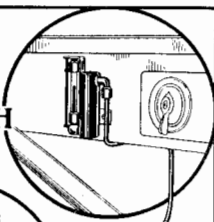

COPPER TUBING
RUNNING
FROM DASH
TO
GAUGE COCKS

HOW MUCH OIL?

This question is answered by a glance at the instrument board before you if your car is equipped with the **SIMPLEX OIL GAUGE**

In plain view of the driver at all times it tells the exact level of oil. Ends the old trouble and inconvenience. The Simplex Oil Gauge is simple in construction and just as simple to install. There are no cork floats or mechanical parts to get out of order, and it is absolutely reliable at all times.

Have this convenience and economy on your car.

Ask your dealer or write us.

REGULAR PRICE \$6.50

Special introductory offer \$4.00 on all orders received by Dec. 20th

DEALERS AND JOBBERS—Show the Simplex Gauge and it sells. Write for complete information.

SIMPLEX GAUGE MFG. COMPANY

907 PINE STREET

ST. LOUIS, MO.

**DEPENDABLE
PROTECTION**

For Every Motorist



COST
COMPLETE
\$3.00
PLUS TAX

As a matter of economy and safety, you owe it to yourself and other motorists to equip your car now with the

**Globe Automatic
Stop Signal**

THE GLOBE Stop Signal flashes a bright red light with the warning word STOP in raised letters on a black background, whenever the driver presses down on the brake pedal. The Signal works automatically, there is no need of hand signalling, no buttons, or levers to push, nothing to remember or to forget. Whenever the driver presses on the brake pedal, the electric current is switched on and the light flashes.

The GLOBE Stop Signal is mounted on the rear left fender of any other place on the rear of the car. Its bright red flash is visible for several city blocks behind. It shows up brightly night or day and is unlike a hand or other signal, in that it can always be seen.

The GLOBE Stop Signal is the cheapest kind of accident and collision insurance you can buy. It will prevent rear end collisions and save expensive repair bills.

DEALERS:—Any Ford owner quickly buys this practical necessary device. Write for interesting proposition.

**The Globe Machine
and Stamping Company**

CLEVELAND, OHIO

SMOOTH-ON
TRADE MARK REG. U.S. PAT. OFF.

IRON CEMENTS



MAKE PERMANENT REPAIRS

For repairs on cars, such as leaky radiators, cracked water-jackets, cracks in pumps, etc., Smooth-On Iron Cement No. 1 will make repairs quickly and easily at a saving of time and expense. Smooth-On has many uses around cars. Send for our Motor and Home Repair Booklet No. 273, illustrating repairs made with Smooth-On. It's

SMOOTH-ON for Leaky Radiators FREE. Write for it.

Dealers: Write for Dealer Proposition.

Smooth-On Mfg. Co.
Jersey City, N. J., U. S. A.



TUBO

WILL INSTANTLY CLOSE ALL TIRE PUNCTURES
From a Tack to a 20d Nail
WHILE THE CAR IS RUNNING

NO LOSS OF AIR
NO FLAT TIRES

Contains no oil, glue, or chemicals. Will not rot rubber or stain or injure your clothes or paint.

Sold on a Money Back Guarantee
Dealers and Agents Write for Prices

Banner Sales Corporation
1512-F. Locust Street
ST. LOUIS, MO.

BRECO
Underslinging Irons
FOR FORDS
FIAT TYPE
RADIATOR SHELLS
RADIUS ROD
EXTENSIONS

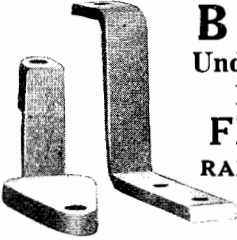

Get our letter of instructions for underslinging cars

BREEDEN & COLE
149 11th Street, SAN FRANCISCO, CAL.

INGRAM LIP-LOCK
ACKNOWLEDGED THE "WORLD'S BEST"



PISTON RINGS
ONCE INSTALLED THE TURN IS CALLED ON EXCESS GAS AND OIL BILLS
POWER GALORE - ELIMINATES CARBON TROUBLES
HEARTY CO-OPERATION WITH DEALERS AND USERS
24,000 square feet in our new plant at Egg Harbor City, New Jersey.

INGRAM MOTOR CO.
EXECUTIVE OFFICES:
2 RECTOR ST., NEW YORK CITY

Raise Big Capital
Write for FREE copy
"Quick Financing"
if you need big capital quickly for oil, mining or industrial business. Learn how one company sold

Over One Million Shares
another company admit they raised two hundred thousand dollars by my easily operated plan. Let me send proof from many satisfied customers that may lead you to quick success. Write for free particulars of this winning plan.

CUNNINGHAM, Financial Specialist
1103 Grant Building, Los Angeles, Cal.

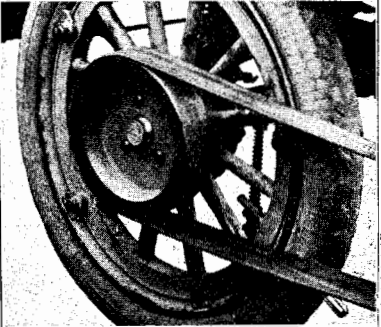

SPEAKS FOR ITSELF BUT PULLS FOR YOU

SUCCESS JIFFY PULLEY

\$3 Prepaid Mail
But one bolt in hub casting to tighten.

SUCCESS SEED GRADER CO., INC.
Spokane, Wash.

ONE BILLION DOLLARS

FOR NEW ROADS IN 1922

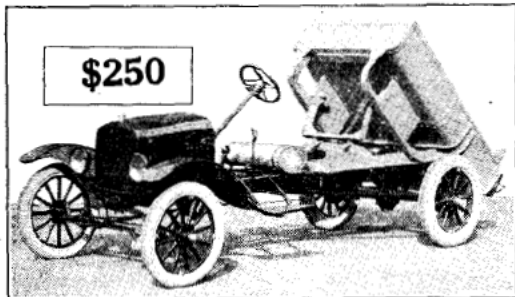

Windsor Gravity Dump

JUST THREE SECONDS

To Dump and Return to Loading Position
DRIVER DOES NOT LEAVE HIS SEAT

Tail-Gate Opens and Closes Automatically with the action of the body. Nothing to assemble, installed in thirty minutes, no mechanism to get out of order, no lay off for repairs.

EXTRA PROFITS

over other dumps will buy a new truck each year because Hand Hoist requires 3 minutes to dump one load. Windsor Gravity requires only 1½ minutes to dump 30 loads.

DISTRIBUTERS WANTED

AUTOMOTIVE UTILITIES CORP.

408 Detroit Savings Bank Building
DETROIT, MICH.

DEALERS!

Here is a
HEATER
that brings
quick profits!

AND this is the time of year to sell it.

It's the Niagara Auto Heater, years ahead of any other on the market, in improvements, in real heating efficiency, in satisfaction it gives car owners.

It radiates clean, odorless heat, and plenty of it. No dirt, no carbon, no smells get into the car—nothing but heat units.

Right now is the right time to become a Niagara Dealer

Castor Distributing Corp.

1436 Falls Street
NIAGARA FALLS, N. Y.

Reasonably Priced
Easily Installed



Instanto Battery Filler

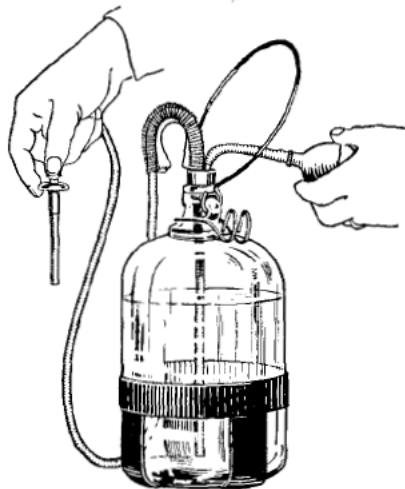

DISTILLED WATER UNDER PRESSURE

One gallon container for distilled water to fill storage batteries in cars.

Set on running board and fill battery anywhere in the car.

Automatic check valve cuts off flow of water. Protected from breakage by rubber base.

Quickest, Cleanest and Easiest Method Yet Devised

Price \$3.50

VEEBERT MFG. CO.

310 So. Canal St., CHICAGO, ILL.

\$1 Will Save \$6.00

Every time you reline the bands in your Ford you are wasting \$6. The "Yale" Band and Transmission Oiler for Fords preserves the bands, keeps them soft and efficient and stops all chattering. Users are getting 12,000 miles on one set of lining.

"Yale" Band and Transmission Oiler

directs a stream of oil over each band in correct proportions, supplying a film of oil between the lining and the drum.

Largest Ford dealers say it is the greatest device ever developed for Fords. Costs but \$1, lasts as long as the car, can be installed in 3 minutes—no threading or fitting, no adjusting.

Get one for Your Ford TODAY. Send \$1. If you are not satisfied with the "Yale," we will refund your money. Use the COUPON. Send for Free copy of Yale-Ford News. Contains helpful advice for Ford owner.

Attractive Proposition for Dealers—Write Today

Yale Corp., 604 I. W. Hellman Bldg., Los Angeles.

Please send me postpaid one "Yale" oiler on your refund offer. Enclosed find \$1.

Name

Address

"MOORE"

Intermediate

FOR FORDS

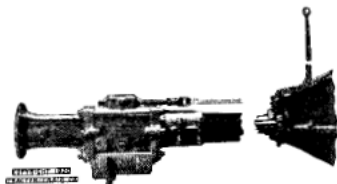

"MOORE" UNDERDRIVE TRANSMISSION

provides an Intermediate Speed twice as powerful as Ford High and faster than Ford Low for pulling through sand, mud, or bad roads, or climbing steep hills.

*For further information write to
the Sales Department*

Tractor-Train Company



MANUFACTURERS
1344 Wall Street
LOS ANGELES, CALIFORNIA

GETTING READY

*To Lay Your Car Up
for the Winter?*

HAVE you considered that, if you leave that "other" lubricant in the gear case all winter, it will go "stale," clog the gears and stiffen them up? Fill your differential now with

Cook's Lubricant



And your car won't be stiff next Spring. Why? Because Cook's Lubricant will not clog or cake—and it will retain its lubricating properties for months, regardless of temperature.

Try a sample and be convinced. Let us send you one now.

Reg. U. S. Pat. Off.

A MARK
known and respected around the world since 1868, for fair dealing, a quality product and an unexcelled service.

Adam Cook's Sons
708-710 Washington St.
New York

C-127

SAVE YOUR CLOTHES



For the hundred and one unexpected jobs about the car there is nothing so practical as the

JIFFY JUMPER

The Jiffy Jumper is not an overall, but a protective garment that can be slipped on or off in four seconds.

It is strongly made of the best grade Government Olive Drab Duck. It will not wrinkle the clothes and is held firmly in place by flexible steel bands. It can be laundered any number of times.

The Jiffy Jumper will quickly pay for itself in saving of clothes. It costs only

\$2.00

If your dealer cannot supply you order direct today.
DEALERS—JOBBER: Here's a practical quick seller. Write at once for proposition.

AMERICAN SPECIALTY CO.
National Distributors

706 CHESTNUT ST..

ST. LOUIS, MO.

LIGHTNING SPARK INTENSIFIERS

Patent Applied For



Makes starting in cold weather a pleasure. Saves your battery, temper and gasoline. Prevents fouling of spark plugs. Reduces carbon trouble. Applied to coil terminals in 5 minutes with a pair of pliers.

Retail Price, Complete for 4 Cylinder Set
POSTPAID 85c

Guaranteed to Be Satisfactory or Money Refunded.

DEALERS AND AGENTS:—ORDER set and ask for circulars and contract for your territory.

LIGHTNING SUPPLY CO.
Manufacturers and Distributors

3103 W. Harrison St.

CHICAGO, ILLINOIS



**Mrs. Fordowner
HERE'S
the Christmas Gift for
HIM!**

And, thru all the years of its use, he'll remember your thoughtfulness every time he snaps on the welcome light.

And an illuminated dashboard is a great measure of safety against accident.

Ask your dealer to order one for you at once, if he doesn't already carry it.

PRICE \$1.25

Beauty Dash Lamp

IS a beauty, with its ebonized barrel and polished nickel fittings. Easy to install. No wires to cut, tape or splice.

FORD AGENTS AND ACCESSORY DEALERS.

This Beauty Dash Lamp for Fords is a YEAR-ROUND SELLER, especially needed in winter. Make it a holiday leader.

Send for Sample, and Discounts
CHICAGO ELECTRIC MFG. CO.
2805 So. Halsted Street
CHICAGO

Mud, Slush and Ice Are Here!

Are you ready for them? When wheels spin around, in snow, mud, sand or soft ground, you will appreciate the ease with which Kant-Slip Chains are applied.



**KANT SLIP
CLAMPS AND CHAINS**

The clamps are securely and permanently fastened to the wheels. When extra traction is needed the chains can be put on in a moment. Simply slip the end link of the chain on the clamp finger, pass the chain around the tire, attach end link and insert a cotter pin. No objectional hooks or fasteners to bother with.

Prepare for winter now. Get a supply of Kant-Slip Chains from your jobber. If he cannot supply you, write us. We also have emergency chains for passenger cars.

Imperial Bit & Snap Co.

Dept. C.

RACINE, WISCONSIN

**BURD
Quick-Seating
PISTON RINGS
One Piece**



**Easy
To
Install**

List Prices (Subject to Trade Discount)
All diameters to 4 in. inclusive, 60c each
All diameters over 4 in. to 5 in. inclusive, 70c each
Burd High Compression Ring Co., Rockford, Illinois

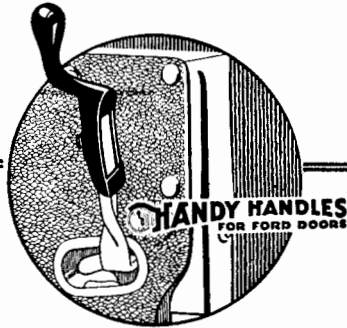

**HANDY HANDLES
FOR FORD DOORS**

**WHY NOT? HAVE DECENT
HANDLES ON
YOUR FORD? Slip Right Over the Reg-
ular Ford Handles**

—a couple turns of a screw driver and they're on. Spick and span, black enameled on solid castings.

THREE FOR A DOLLAR—or 40 cents for one. HANDY HANDLES give just the right "gripping" shape and the increase in leverage length makes opening doors easy.

No more straining, and bruised fingers.

AT YOUR DEALERS—OR PIN A DOLLAR BILL TO A LETTER.

RACINE SCREW WKS.

Dept. F—RACINE, WIS.



NEEDED BY FORD OWNER OR MECHANIC

You could not buy a handier, more practical or more needed item than the

Efficiency 5-in-1 Tool

Several uses are combined in this one Combination Plier and Dual Wrench. Positively the most worth-while tool in the kit. Makes two "S" Wrenches, Openings $\frac{5}{8}$ " and $\frac{3}{4}$ ". Strong, well made. Highly polished, 50 point carbon steel, thoroughly heat treated and guaranteed to stand up under severe service.

PRICE \$1.50

West of Rockies \$1.65
Fully Guaranteed

If your dealer cannot supply you, order direct from us.
AGENTS AND DISTRIBUTORS WANTED
DEALERS:—If you are not yet stocked you will need to be. Send now for samples and discounts.

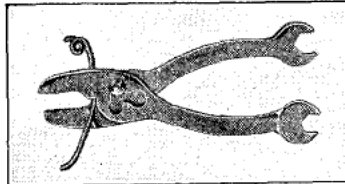
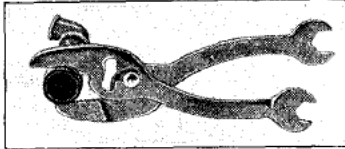
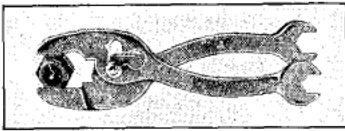

Enclosed find \$.....Check, P. O. or Express
Money Order in payment for.....Combination
Plier and Wrench which forward by Parcel Post Prepaid.

Republic Supply & Rubber Co.

Wholesale Distributors

472 Milwaukee St.

MILWAUKEE, WIS.

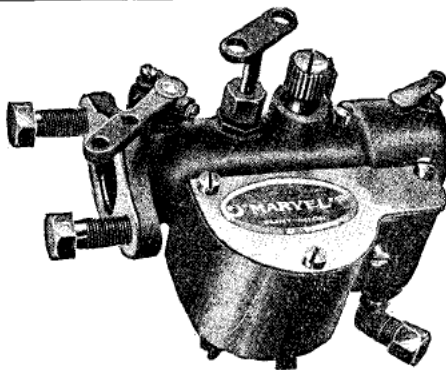

THE MOST POWER AT THE LEAST COST

Real economy consists of getting the most power at the least cost. This is positively accomplished through the use of

THE MARVEL CARBURETOR

The Marvel, Model N Carburetor is a horizontal type, side opening, two jet instrument, designed especially to meet the needs of Ford owners who demand a powerful and economical carburetor. Simple in design—but one moving part, the auxiliary air valve, which proportions the mixture to the demand. No excess amount of gas on the low speed needle in order to have power enough at high speeds, is necessary only sufficient gas to give proper idling and low speed performance and the high speed jet is then only called upon as the motor demand increases. Uniform carburetion at all speeds and maximum economy of fuel.

PRICE \$10.00 F. O. B. Factory. A 30 day trial—money back if not satisfactory—protects you. No extra fittings necessary.

DEALERS—Write today, seeing is believing.

MARVEL CARBURETOR COMPANY
Flint, Michigan, U. S. A.

Auto Owners WANTED!



To introduce the best automobile tires in the world. Made under our new and exclusive **Internal Hydraulic Expansion Process** that eliminates **Blow-Out—Stone-Bruise—Rim-Cut** and enables us to sell our tires under a

10,000 MILE GUARANTEE

We want **an agent** in every community to use and introduce these wonderful tires at our astonishingly

low prices to all motor car owners.

Write for booklet fully describing this new process and explaining our amazing introductory offer to owner agents.

Hydro-United Tire Co.

Dept. 191 Chicago, San Francisco, Pottstown, Pa.

The "Inland" Refacer

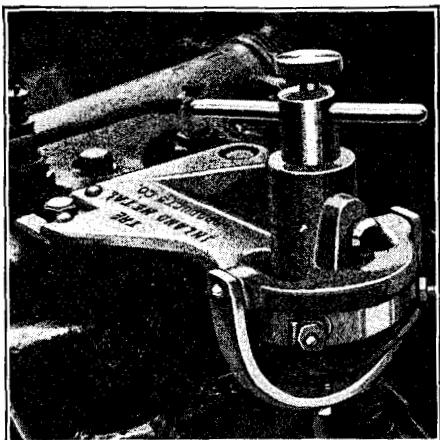

REPAIRMEN:—All you sell a customer in a new case is the smooth race-way. Use an "Inland" and save him money. Make YOUR profits quicker. Ask for Ten Day Trial Offer.

Type A, \$5.25	Type B, \$7.50
West of Rockies and Foreign, \$5.75	West of Rockies and Foreign \$8.00

INLAND METAL PRODUCTS CO.
Columbus, Indiana, U. S. A.
Originators of Practical Timer Refacing

PACO *snappy* RACING BODIES for FORDS



1922 Paco Models surpass in design, manufacture and finish. Paco Bodies make a rakish, classy and COMFORTABLE speedster out of your Ford. And you'll be pleasantly surprised at the

NEW LOW PRICES

for the 1922 line. Our complete descriptive literature shows wide selection to choose between. New Paco "covered" model is ideal for colder season. Installation simple. Write today for literature and facts. Some desirable territory still open.

PACO MFG. CO.
Dept. 205
PEORIA, ILL.

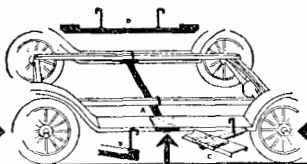
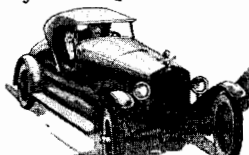

Patented April 13, 1920

DOW BODY BRACE

Strengthens the Running Board; Avoids Side Play; Stops Rattles and Body Squeaks; Prevents Broken Springs; Lengthens the Life of the Car.

The thousands of Dow Body Braces in use in all parts of the country are sufficient evidence of their value in increasing the pleasure and safety of Ford riding. Every Ford Car should be equipped with a Dow Body Brace for the sake of comfort alone.

Have one installed by your Dealer now—today. If he hasn't them write us immediately.

Price \$3.00

THE DOW CO.
Incorporated
LOUISVILLE, KY.



SAVES TIRES



FREE CURTIS AIR FREE FROM OIL

Business Building Service

Drivers of cars appreciate the superior free-air service you can render with the Curtis Air Compressor. They know Curtis Air—clean, pure and free from oil—preserves tubes and increases tire mileage.

Curtis Air—Free from Oil

The number of Curtis Compressors in use today is unquestionable evidence of their distinct superiority. The Curtis, with its exclusive, patented, controlled splash oiling system, is the only compressor so designed to prevent oil from being forced into the air line.

Ask Your Jobber

There is a style Curtis Outfit to meet your particular needs. Ask your jobber for full information, or write us.

Style "V"
Five Sizes

CURTIS PNEUMATIC MACHINERY CO.
1639 Kienlen Ave., St. Louis, Mo.

Branch Office:
532 L Hudson Terminal,
New York City

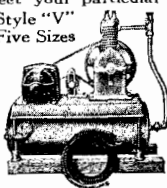

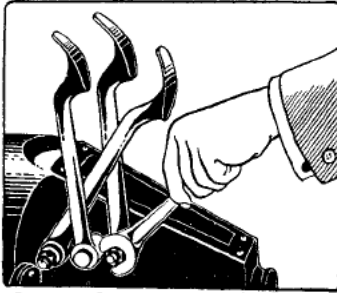

Michon Outside Adjusters

For Ford Transmission Bands

Furnishes the means for quickly adjusting brake bands from the seat. Unnecessary to remove transmission cover. Eliminates over-adjustment. Installed in a few moments. Replaces regular Ford parts. No boring or changes made in transmission casing or cover. Fits all types with or without starter.



Pat. Foreign—Domestic Pat. Pend.

<p>A SET CONSISTS OF</p> <ul style="list-style-type: none"> 2 Adjusting Shafts 2 Bearing Sleeves 2 Special Lock Washers 2 Special Milled Nuts <p>Size packed $8\frac{1}{2}'' \times 1\frac{1}{4}'' \times 1\frac{1}{4}''$ Weight $1\frac{1}{8}$ lbs.</p> <p>Owners write for dealer's name.</p>	<p>PRICE PER SET</p> <p>Complete \$2 Retail</p> <p>\$3.00 Installed</p> <p>Jobbers and Dealers write for proposition.</p>
--	--

MICHON MFG. CO.

92 MICHON BLDG., TOLEDO, OHIO

The Red Cup Lubricator



(A)
Feeds
Brake
Band

(B)
Feeds
Low and
Reverse
Bands

A practical means of stopping "CHATTER" in FORD Transmission Bands. The Red Cup Lubricator feeds a correct proportion of special Lubricant (Red Cup Compound) to the Transmission Bands.

This Compound works into the Bands keeping them from glazing and getting hard (Cause of Chatter) lengthening life of Transmission Bands. Red Cup Compound is **soluble** in oil.

Anyone can install the Red Cup Lubricator quickly, using a screw driver. It is operated from driver's seat. Guaranteed to stop Chatter or Money Refunded.

Dealers Ask for Quantity Prices

RED CUP LUBRICATOR CO.

1603 S. Michigan Ave.

CHICAGO, ILL.

Petry Tuning-Up-Valve FOR FORDS

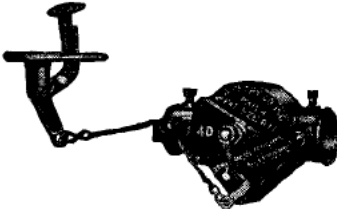

Why do particular motorists demand the Petry Tuning-up-Valve in preference to all others? Motorists find that the Petry Tuning-up-Valve is a carefully designed, well-made product, and not some castings carelessly assembled. It appeals, on sight, as a "good job." Compare it yourself with the ordinary Cut-out and your verdict will be that it is America's Best Tuning-up-Valve and "Scientific Detector" for tuning up and locating trouble.

Expels the full exhaust to the rear, not down. Does not spatter mud and stir up dust. Positive cut-off from the muffler. Spring away from heat. Compound lever makes the strong spring action smooth and easy. Spring adjustable. Valve seat and valve machined to prevent leakage.

Sold complete with Pedal and Chain for \$4.50

N. A. PETRY COMPANY, Inc.

Makers of Petry Pedal, Ventilator and Pump
338 N. Randolph St., Philadelphia
Western Distributor, Norman Cowan Co.,
4 -451 Rialto Bldg., San Francisco, Cal.

ONLY
10 inches
HIGH

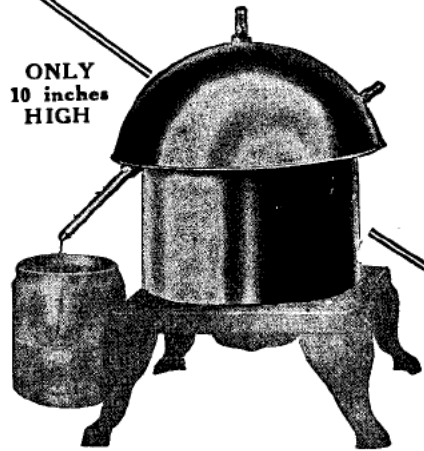

BATTERY SERVICE

Can be right only when the water is right. Equip your service station to supply only

DISTILLED WATER

Distill approximately one gallon an hour—24 hours a day—every day in the year—without attention, trouble or annoyance. Use the new, efficient CLEVELAND AUTOMATIC Water Still Made of heavy solid copper, highly polished—set up anywhere. Price only \$40.00.

Write today for full details and dealer discount.

CLEVELAND WATER STILL CO.

490 Prospect Avenue, CLEVELAND, O.

PENBERTHY PRODUCTS

RE-ATOMIZER

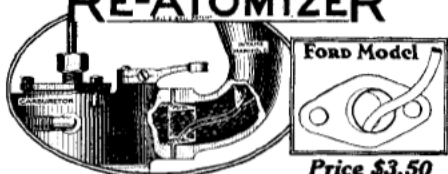

Price \$3.50

STOPS CRANK CASE OIL DILUTION

Dealers everywhere are selling thousands of Re-Atomizers because it actually does away with several of the most serious motoring troubles. The Re-Atomizer prevents liquid gasoline from entering the cylinder and crank case and diluting the oil. It saves gasoline, gives the motor more power and pep, and decreases carbon trouble.

Ford Model \$3.50

Other models \$3.75 to \$4.25 depending on make of car
Five standard models fit every make and model of car

DEALERS—Write for Our Sales Proposition.

Penberthy Injector Co.

DETROIT, U. S. A.
Established 1886. Canadian Factory, Windsor, Ont.



DUAL FRONT SPRING SYSTEM

PATENTED

This system applied to your FORD will give you safety in steering, comfortable riding and economy in upkeep.

NO RADIUS ROD

Two front springs and a pair of shock-absorbers, with everything complete for installation. Looks, steers and rides like a High Priced Car.

ANY ROAD—ANY LOAD

Ask your dealer or write to

EVANS-COOKE MFG. CORP.

2318 FAIRMOUNT AVENUE
PHILADELPHIA, PA.

AT LAST, A SUPER-SERVICE FENDER BRACE

FOR FORDS



A fender brace that rigidly and permanently prevents front fenders rattling or cutting tires. Adds greatly to the car's appearance. Does not touch lamps or radiator. Holds license tag up out of the mud. Easily installed—no holes to bore, or subsequent service required on brace. Like all ARG accessories, made of best materials. Makes fenders outlast life of the car. Price \$2.50. Stops all front fender rattling and troubles.

Sales Department

Jessop & Thompson

1421 S. Michigan Ave., CHICAGO, ILL.
Manufactured by
ARG AUXILIARY SPRING CO., Birmingham, Ala.

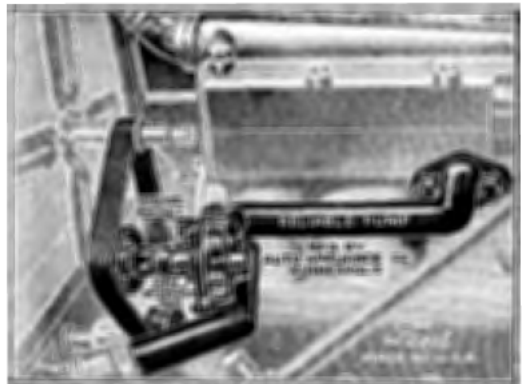

A REAL CIRCULATING PUMP FOR \$7.50

Before you buy any circulating pump get full information on the

RELIABLE PUMP

just coming on the market. It is highly efficient, easily installed, long-lived and fully guaranteed.

INTRODUCTORY OFFER—SAVE \$1.50

Cut out this ad and enclose with check or money order for \$6.00. You will save \$1.50 on the regular price and pump will be shipped to any part of the United States. If not satisfactory after a ten day trial return same at our expense and we will refund your money. Write for circulars.

JOBBER AND IMPORTERS: Get your share of this business.

DOUGLASS AUTO APPLIANCE CO.
2845 Chicago Avenue. MINNEAPOLIS, MINN.

No More Rear Axle Troubles
 After Applying
THE MASTER
DOUBLE TRUSS ROD

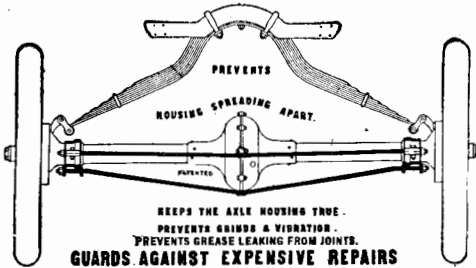

The Most Durable Truss Rod Made
 The Truss Rod Minus Competition

Both rods counteract the effect of the jars and jolts of the road, prevent vibration, breakage, grease leaking from housing joints, etc.

The bottom rod relieves all vertical strains.
 The rear rod relieves all horizontal strains.

The Master Applied Today—Saves Repair Bills Tomorrow.

Insist on the Master Double Truss Rod—thereby avoid inferior rods now flooding the market.

If your dealer cannot supply order direct.
 Price \$4.50

THE MASTER PRODUCTS CO.
 1142-46 Belmont Ave., Chicago.

COMPETITORS ACKNOWLEDGE
 The Superior Qualities of
The Fansteel
Magneto Break Timer

For Trucks and Tractors.
 For Ford Cars,

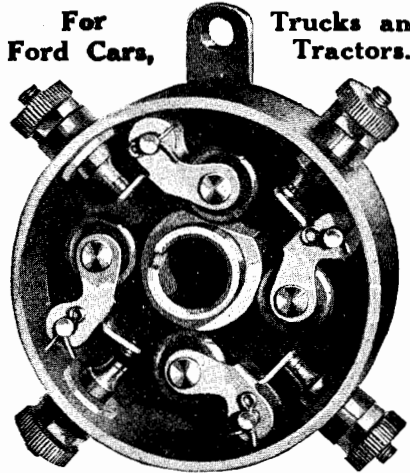

SAVES GAS INCREASES MILEAGE
NO OIL REQUIRED

Licensed Under Patent No. 1,340,857
 PRICE REDUCED TO \$3.95 Formerly \$5.00

W. J. WALSH
 528 MONADNOCK BLDG. CHICAGO

SAFETY CLUTCH
CONTROLLER

For
Ford
Cars

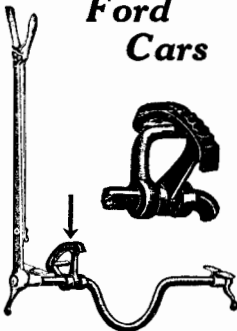

Part indicated by arrow works loose on shaft, and when set in neutral (by applying the brake lever) it will stay in that position until pedal is put in low speed.

This little device, by keeping the clutch in neutral position at all times, insures perfect safety from car moving away while motor is left running.

It detects any trouble in the clutch.

Simplifies the changing of rear tires by relieving the Emergency brake pressure.

It saves tires and brake shoes.
 Simplifies operating car in reverse by throwing the lever down.
 Can be used in coasting.
 Enables one to move car manually with little difficulty.
 Easy to operate.

Standard Model \$5.50
 F. O. B. New York
One Ton Truck Model \$6.00
 F. O. B. New York

If Your Dealer Cannot Supply You Write to Us
DEALERS: Kindly Write for Particulars
C. C. & F. MANUFACTURING CO.
 141 East 23rd Street NEW YORK CITY

FOR A PERFECT JOB
 OF
CYLINDER LAPPING

There is one way to secure an easy, quick and perfect job in lapping cylinders or pistons. Use

CYL-LAP

Cyl-lap is a harmless abrasive which combines the qualities of speed, high surface finish and positive removal of the lapping abrasive when the operation is finished. Does not contain severe abrasives or glass. Not imbedded in metal.

Send today for trial can

4 OZ. CAN, \$1.50

8 OZ. CAN, \$2.50

Cyl-Lap Products Co.

SEATTLE,

WASHINGTON

only **\$1.50**
buys the



BULL DOG
FOOT ACCELERATOR



The very best foot accelerator for Ford cars that you can buy—only costs \$1.50.

Of course you can pay more for an accelerator, but over a million Bull Dog fans will tell you that the simple, reliable Bull Dog Foot Accelerator can't be beat.

The Bull Dog is strongly made. All parts are steel, accurately machined and fitted. There are no wires, cables or flexible joints to break or cause trouble.

The Bull Dog has direct rod drive to the carburetor, and permits of very close adjustment.

All good dealers carry Bull Dog Accelerators in stock. If your dealer should be out, order one direct.

THE W. H. THOMAS MFG. COMPANY
SPENCER, IOWA

Sales Agents, The Fulton Co.
MILWAUKEE, WIS.

NEW INVENTION THAT WORKS
WONDERS ON A FORD
AUTO-COASTER

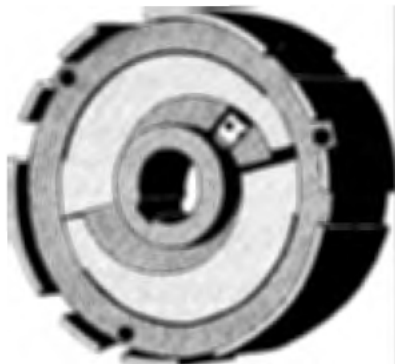

Displaces the Disk Drum. Doubles the Mileage.
Perfect Shock Absorber Effect of Compression
and Back Lashes Eliminated.

TERRITORY DISTRIBUTORS WANTED
PRICE \$15.50

Coasts Like a Bicycle

**Duncombe Overrunning
Clutch Co.**

General Motors Building. Suite 2-138
DETROIT, MICH.

CYCLO

"Modified Vapor" System

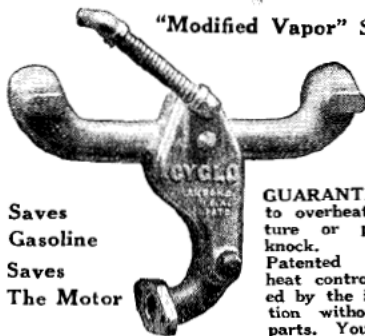

Saves
Gasoline
Saves
The Motor

An exhaust
heated
aluminum
manifold for
FORDS.

GUARANTEED not
to overheat the mixture
or produce a knock.
Patented automatic
heat control, regulated
by the intake suction
without moving parts.
You can run

your Ford on a lean mixture with perfect pick-up.
No more fouled spark plugs. Reduces carbon.
Stops oil dilution. MAKES YOUR FORD RUN
100% SMOOTHER.

25 to 30 MILES PER GALLON
OF GASOLINE

Plenty of power under all conditions with unusual
gasoline economy. The Cyclo insures a quicker
warm-up and get-away on cold mornings. Money
refunded in 10 days if not satisfied.

Price \$12.00 Complete

We want live Ford Owner Agents and Dealers
to demonstrate this remarkable invention.
Write today for special plan.

CYCLO MANIFOLD COMPANY
AKRON, OHIO

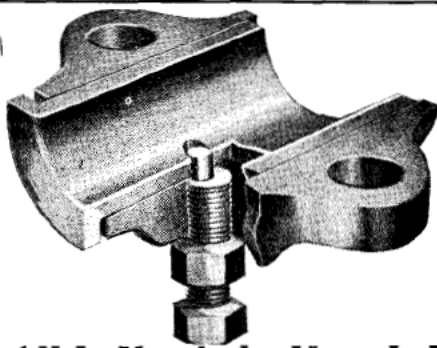

All Is Needed—Here It Is

End play in the Ford crankshaft always
has been a familiar trouble. Now it has
been permanently ended by the

**C-A ADJUSTABLE
BEARING CAP**

(Patent Pending)

This device is simple in design and operation and
has met with universal approval. Quickly installed
it eliminates the hard starting, poor lights, noise
and excess wear which results from crankshaft
end play.

The C-A Adjustable Bearing Cap is strongly
made and machined to fit perfectly. Equip your
car today and end constant trouble and expense.

PRICE COMPLETE, \$5.00

DEALERS AND AGENTS:—Write for
our special proposition.

ADJUSTABLE BEARING CO. INC.
116 S. 4th Street TERRE HAUTE, IND.

THE
OILOMATIK

LUBRICATOR automatically feeds the oil to the motor as needed, holding it at all times at the proper level—midway between the two pet cocks. Gives perfect lubrication to Ford motor; eliminates guess-work.

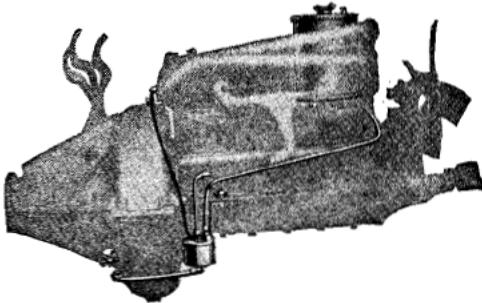

ANOTHER THING—Should you fail to refill the tank the OILOMATIK has a very unique low oil Alarm, which warns you before the level reaches the danger point.

Price \$15.00

Local Distributors order one today.
Exclusive territory.

Auto Products Mfg. Co.

341 East Ohio Street
CHICAGO, ILL.

MAKE YOUR FORD SAFE!

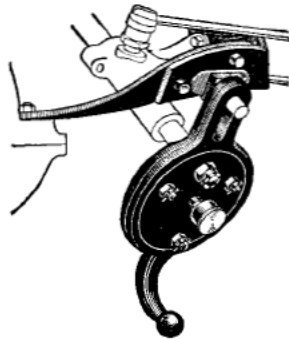

The Detroit Steering Control will give you absolute control of your Ford. It prevents the front wheels from getting locked hard over. Holds the car to the road and prevents road shocks from reaching the hands.

Can be installed in forty minutes. No holes to bore. Safe, simple, practical.

PRICE \$15

DISTRIBUTORS—We want hustlers with Ford cars who will push sales. It's a big profitable business. Write at once.

DETROIT STEERING CONTROL CO.

2739 Atwater E. DETROIT, MICHIGAN



Prices Cut to the Bone!

HASTINGS

GLASS REAR CURTAIN LIGHTS FOR FORDS NOW **\$1.65**

Cool Fall Evenings Here

With the first cold weather you will want protection from cold air, rain and snow. Replace your celluloid lights which have become cracked, torn and discolored, with Hastings Glass Rear Curtain Lights and be comfortable when driving.

ASK YOUR ACCESSORY DEALER

If he can't supply you with Hastings Ford necessities, write to us direct.

HASTINGS MANUFACTURING CO.
25 E. Mill Street HASTINGS, MICH.

DEALERS—Your jobber can supply you. Write to him or to us for sales proposition and catalog of complete Hastings line.

**SAVE
With This
Convenience**

You know the troublesome contortions and clothes-soiling which you experience now in determining the amount of oil in the crankcase.

Now have the convenience of the

PRITTI SLIK

**ELECTRIC OIL
INDICATOR**

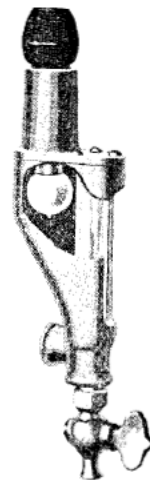

By simply pressing the button on the dash under the hood, flashing the light behind the gauge glass plainly indicates your oil level, through dirt and grease.

The installation of the Pritti Slik Electric Oil Indicator on the crank case, as shown in the accompanying illustration, is self-explanatory. Securely attached in a few minutes of time. Connects with any type of ignition or lighting system. Equipped with regular 6-8 volt tail light bulb, necessary wire fittings and press button switch.

Positively the neatest, most satisfactory oil indicator on the market. Price \$5.00. Everywhere.

DEALERS—DISTRIBUTORS:
Write for exclusive proposition.

AUTOMATIC AUTO LOCKS, LTD.
251-259 Second St., SAN FRANCISCO, CAL.

SNOW AND ICE

WILL NOT STOP YOU IF YOUR CAR IS EQUIPPED WITH THIS 100% POSITIVE DRIVE DIFFERENTIAL

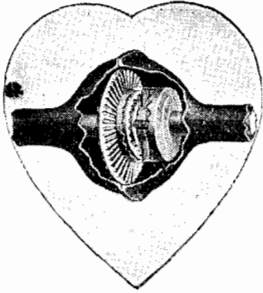

Gives 20% more driving power. Saves gasoline, tires and wear on all working parts. It distributes the driving power equally on both rear wheels.

Dealers and Distributors:—Don't delay. Get In While You Can.

INTERNATIONAL AUTO DRIVE CO.
629 E. Pearl St. CINCINNATI, OHIO

INNER CONTROL SPOT LIGHT



Don't let the question of weather interfere with your spot light sales. Sell the Innercontrol, the spot light that is operated in comfort from within. The reflector is in the regular position—but the control is entirely from the inside. Ask your jobber, and if he can't supply you, write us direct.

The Cincinnati Lamp & Bracket Co.
312 West 4th St.
Cincinnati, O.

Retail Price
Ford Sedan and Coupe Model
\$11.00

Also made in models for every make of car.

"Operate Your Spotlight in Comfort from Within"



DON'T WAIT FOR BURNT OUT BEARINGS AND SCORED CYLINDERS

Install a "TOQUET OILING SYSTEM" on Your Ford

PRICE \$2.50

THE TOQUET CARBURETOR CORPORATION, WESTPORT, CONN., U. S. A.

SAVE SPRINGS AND CARS

Everybody knows that properly oiled springs save the springs, the tires and the car. To oil the springs properly and have them Stay Oiled use

NIFTY SPRING LUBRICATORS

Just fasten Nifty Lubricator around the thick part of the spring. They will oil every part of the springs continuously. A big trouble saver and a big economy.

PRICE PER SET OF 4—\$1.50. ORDER NOW

DEALERS:—Write Today for a Real Offer.

THE SPRINGCUP COMPANY, 302 Schmidt St., St. Joseph, Mo.

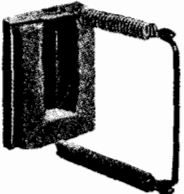

Latest Automobile Accessories-Wholesale

SPECIAL BARGAIN PRICES on Diamond "J-D" Visors Fits Any Size Lamp. Order Now

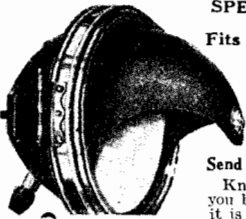

Buy here and save money. On "Fidelity" bodies, repair parts, tops, radiators, fenders and general accessories for Fords and other cars, all guaranteed standard quality.

Send for Big "NEMCO" Catalog FREE

Know what you should pay before you buy. Send for Nemo Price List, it is absolutely free, and be sure you are getting the lowest prices. Every page of this book is filled with bargains. We buy for cash and sell for cash.

For Ford Lamps	Lamps 9 to 10 in.
98 ^c Pair	\$1 ³⁵ Pair

NEMCO BARGAIN SUPPLY HOUSE
Dept. 25, 1015 Jackson Blvd., Chicago

No Free Samples



\$1.50 Worth FREE!

I make this offer to prove to you that I have the most wonderful invention and quick seller ever placed on the market. Every customer is a booster for you, and I will protect you on all resales. Do not confuse this device with so-called intensifiers, etc. Peck's Tester and Transformer will make an old worthless car run like a new car. It will save the cost of new piston rings and rebored cylinders. Fitted with my invention, a Ford runs like a 12-cylinder car. Thousands in use. Every customer satisfied. I furnish you advertising matter that makes an expert of an amateur in tracing and locating engine troubles. You make a dollar for every 10c invested. Quantity lots 100 for \$10. Retail price is 50 cents each. Owner-agents and dealers can get a set of 4 for 50 cents by sending this ad. which is good for \$1.50.

75 MILES ON ONE GALLON OF GASOLINE

This invention fits any car and is sold on a guarantee to at least double your mileage. Installed in one hour.

Price complete \$30.

F. G. GARDEN, 311 F. So. Hicks St., Philadelphia
AGENTS WANTED.

When writing advertisers—Just say FORD OWNER AND DEALER

DRIVE 100 TACKS AND SAVE \$25

TOP COVERING FOR ALL CARS WITH REGULAR BACK CURTAIN WITH BEVELED PLATE GLASS LIGHTS

TOP COVERING FOR ALL CARS WITH GYPSY BACK CURTAIN WITH BEVELED PLATE GLASS LIGHT

\$5⁰⁰ DELIVERED

EASY TO APPLY

We Tailor Top Roof Coverings with Back Curtains to Fit All Models of Cars
 Ford Roadster, \$5.50. Touring, \$6.95
 For Other Cars, \$14 and \$16, With Large Plate Glass Lights. Seat Covers, \$3 Up.
 Ford Daylight Winter and Summer Side Curtains that open with the doors, \$13.50 and \$19.50 per set
 All Prices Are for Goods Delivered at Your Door
CATALOG—SAMPLES FREE
 Auto Equipment Co., 33 Canal, Cincinnati, O.

RED-I-FIT
 FOOT FEED

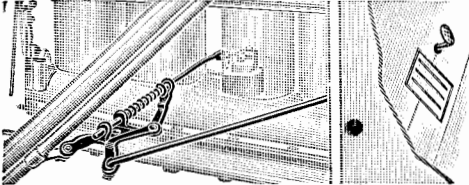

ACCELERATORS WORK ALL THE TIME
 The extremely long life and unfailing service rendered so consistently is entirely due to their simple, but correct mechanical principle.
GIVES THAT EASY AND POSITIVE MOTION
 Installed by Two Cotter Pins
FITS ALL FORD CARS
 HEATON-AULT, 6247 Greenwood Ave., Chicago.

SPEEDWAY BODIES for FORDS

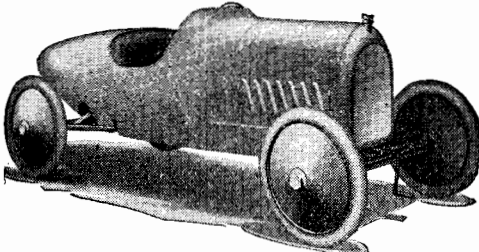

AND UNDERSLUNG PARTS.
MORTON & BRETT INDIANAPOLIS, IND.

STORM
MAIN BEARING TOOL

Puts new bearings in old blocks. A low priced efficient money-making tool. Simple and speedy in operation.
 Two sizes for Ford and Fordson.

Write today for complete descriptive literature on Storm Motor Renewing Equipment.



STORM MFG. CO.
 Minneapolis, Minn.

LAMCO

Trade Mark Reg.



PRICES SLASHED—WRITE IMMEDIATELY FOR THE NEW CATALOG—JUST OFF PRESS
Lehman Mfg. Co., Inc. Cannelton, Ind.

Lyon Bumpers Are Positive Collision Protection

LYON STANDARD BUMPER



Guaranteed to take the full force of a blow at 15 miles an hour without damage to itself or the car. Special Models for Ford Cars. Order from your jobber.
METAL STAMPING COMPANY
 Long Island City, N. Y.

LYON RESILIENT BUMPERS

WE TOP 'EM ALL
 Auto Tops for All Makes and Models of Cars
 Seat Covers—Dust Hoods—Fenders



Save one-half the cost of new Top by using our Slipover Coverings. Write for our Catalog.

BUOB & SCHEU 104-112 Webster Street CINCINNATI, OHIO

MODEL 20 FRONT END TYPE ALL ROLLER BEARINGS POSITIVE LOCK CARS AND TRUCKS

WOODWARD 4 SPEEDS for FORD

No. 1 UNDERDRIVE FOR POWER BUILT THE BEST AND SELLS FOR LESS No. 2 OVERDRIVE FOR SPEED

TRANSMISSIONS ONLY, ANY TYPE, \$80.00. Connections Extra for CARS \$12.50—TRUCKS \$17.50

323 Van Ness Ave. **WOODWARD & ROWE** 2125 Michigan Ave. CHICAGO
 SAN FRANCISCO

Agents and Distributors Wanted to Handle Exclusively Easy Work Good Profit

FEDERAL BODIES WILL MAKE MONEY FOR YOU

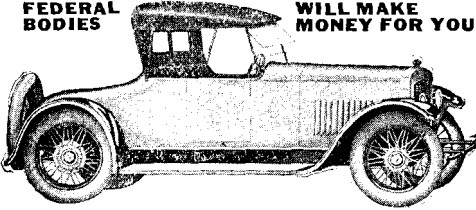

This beautiful "FRATERNITY" Roadster body built for Fords and Chevrolets is the latest and most comfortable body constructed. Choice of colors.

THE ABOVE IS ONE OF OUR TEN DISTINCTIVE DESIGNS DEALERS.—Write us at once for our new catalogue showing greatly reduced prices on FEDERAL Sport, Speed and Touring Bodies. Can make immediate shipments. **FORD BODIES AS LOW AS \$29.50** Don't Pass Up This Opportunity.

FEDERAL MOTOR SUPPLY CO., 2620 Michigan Ave., CHICAGO
Canadian Distributors: Auto Body Co., Toronto, Ont. Federal Auto Body Co., Campbellton, N. B.

Cooling Position Partly Open.

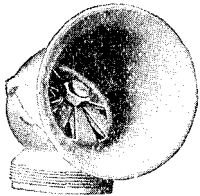

Cast Aluminum Highly Polished
\$2.85 PREPAID

Send for Circulars

RADIATOR FUNNEL CAP CO.
3852 Grand Boulevard, CHICAGO

RADIATOR SAFETY FUNNEL CAP

A stationary Filler Cap. A Radiator Cooler. A Practical Funnel. A Reliable Overheat Meter. Good Looking. Sure.

Funnel Position Open for Filling

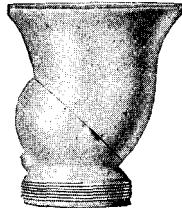

JUST TWO LEVERS
Absolutely Silent in Operation
That's All
BUT THEY INCREASE THE VALVE CAPACITY 100%

The world famous Ansted motor used in the Lexington uses this principle. Your Ford motor should use it.

The MULTI-LIFT

gives more power than any overhead valve equipment for the Ford motor, using the same ignition and carburetor. And the price is only \$26.20, delivered.

GARAGEMEN, these are Facts proven by Performance. Get the agency **GEORGE RILEY & CO.**
2954 W. Pico St., Los Angeles

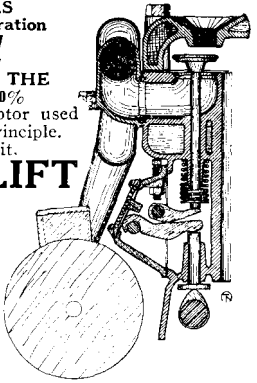

FOR PERFECT RIDING

Ford owners are daily finding real car comfort and saving of cars and tires through the use of the

"LONGSTRONG" SPRING

With this spring more resilience is guaranteed than with any shock absorber. It adds strength to the car and provides complete comfort, service and safety. It adds ten inches to the span of the standard Ford spring. Easily installed; requires no attention, and soon saves its cost.

Price complete with long clips ready to install, \$14.00.

DEALERS—A Splendid Proposition Awaits You.

TERRE HAUTE AUTO SPRING CO.
TERRE HAUTE, INDIANA

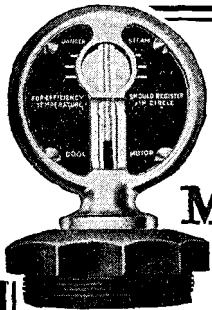

Special Model for the Ford
\$3.50

BOYCE MOTOMETER

"Your car deserves one"

THE MOTO-METER CO., INC.
Long Island City New York, U. S. A.

ROSE TIRE PUMPS

The Rose Tire Pump has more dealers than any other pump. You can't fool the dealers on a good seller. They have sold nearly 3,000,000 Rose pumps.

Write your jobber or us for our proposition. It means money to you.

Frank Rose Mfg. Co., Hastings, Nebr.

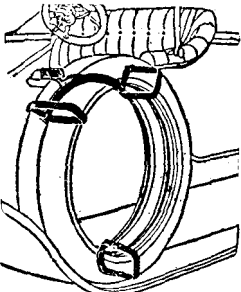

TIRE Carrier
\$1.25

FITS REGULAR FORD BOLTS
Install it yourself in a jiffy

Carries one or two tires, 3 or 3½, mounted or unmounted. Tires can be locked securely to car. Dealers and jobbers write us.

SHEHAN TOOL & MACHINE CO.
502 E. 9th St. Los Angeles, Cal.

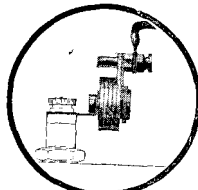

SPARKO-GAP

Now \$1.00 Retail!

Increases Engine Power 37%—Fires Even Fouled Spark Plugs Sparko-Gaps are patented—not to be confused with ordinary intensifiers. Their construction embodies the quench-gap principle used in wireless. Sparko-Gap produces the same remarkable results on all internal combustion engines.

Liberal Discount to Agents

Here is the chance of a lifetime to start an automobile business of your own. Agents are making real money selling Sparko-Gaps.

Write for Agency Proposition

It is the only device to intensify spark approved by the United States Government. Thousands are sold everyday. **Increases Power—Saves Fuel—Prevents Carbon Trouble—Stops Oil Pumping.**

SPARKO-GAP CO.
15 West 37th St., New York, N. Y.

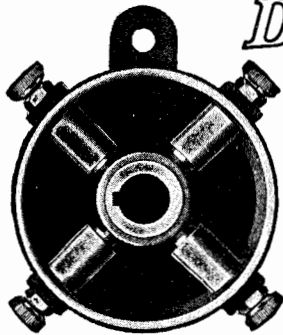

DALECO TIMER

The timer with the written guarantee that insures the buyer perfect timer service for 2 years and at 50 cents per year thereafter.

Write our sales dept. today for full details.

Manufactured by
THE DALE MFG. CO.
1323 Michigan Ave.
Chicago

Sales Dept.
THE ZINKE CO.
1317 Michigan Ave.
Chicago, Illinois

REYNOLDS SPRING CO.

RED DIAMOND CUSHIONS FOR FORD CARS

A Perfected Product for Particular People

Made by the largest exclusive Cushion Spring Factory in America and the most comfortable and durable cushions ever built by anybody.

Sold through regular channels only

MANUFACTURERS
REYNOLDS SPRING
COMPANY
JACKSON, MICH.

SALES DEPT.
THE ZINKE CO
1317 Michigan Ave.
CHICAGO, ILL.

Do Not Raise Ford Body

Telescoping coils of chrome vanadium steel between leaf spring and axle. Absorb vibrations, snub rebounds, prevent sideway. Fit all Fords. No other shock absorbers like them. Retail price, \$21.00, set of four. Fully guaranteed. 10 days' trial; money back if not satisfactory.

PRESSED METAL MFG. CO.

Waukesha, Wis.

DEALERS:—Write for discounts and merchandising plan. A real opportunity.

CUSHION-COIL



FOR FORDS

A Sure Pay Raiser for You—FREE

Here's the point about Drake's Practical Home Study Books; every one of them completely covers its subject. They cover every trade:

Automobile Repairing; Electrical trades; Farm Engineering; Shop practice, Welding, Millwrighting; Steam Engineering; Railroad; Painting; Carpentry; Building; Business; Languages, and many others.

Better than a correspondence course. You don't have to wade through a whole set of books to learn what you need to fit you for that bigger job. The big catalog, listing and describing over two hundred of these books for home study, sent free to you, postage paid. Among these books is the one you want. Send for catalog today.

FREDERICK J. DRAKE & CO.
1079 Michigan Avenue CHICAGO, ILL.

Cooper Special Cut-Out

Attached without cutting exhaust pipe in two. Cannot rattle or chatter. Not affected by dirt, heat or carbon.

Sizes	With Pedal	
	No. 3	No. 4 or 5
1 1/2 inch Ford Size	\$3.00	\$3.50
1 3/4, 1 3/4, 1 7/8	3.50	4.00
2, 2 1/8	4.00	4.50
2 1/4, 2 3/8, 2 1/2, 2 5/8	4.50	5.00
2 3/4, 2 7/8, 3	5.50	6.00

Special for Buick Cars, valve only \$3.00, with pedal 3, \$3.50, with pedal 4 or 5, \$4.00. Above prices subject to 10% increase on Pacific coast. If your dealer cannot supply you, write direct, Dealers, ask your jobber

COOPER MFG.
COMPANY,

Dept. F.
Marshalltown, Ia.
The Fulton Co.,
Sales Mgrs.,
Milwaukee Wis.

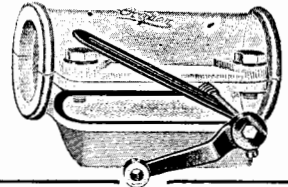

BALANCED LIGHT WEIGHT FERROLYTE PISTONS (Trade Mark Reg.)

DESIGNED FOR EFFICIENCY

FORD AND OTHER MODELS

The Perfection Auto Parts Co.

420 Lakeside Av. N. W., CLEVELAND, O.

SELF-OILING
BOLTLESS

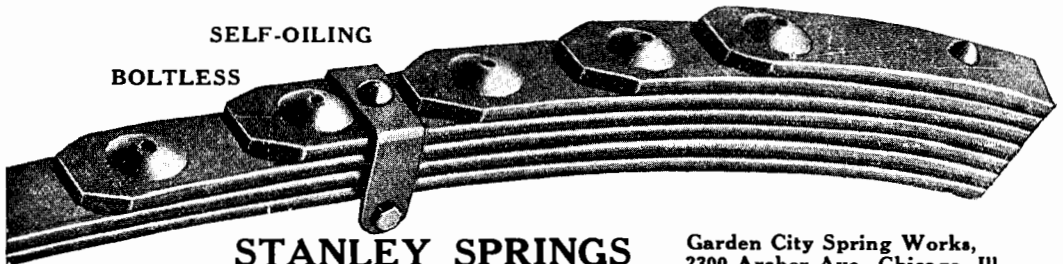

STANLEY SPRINGS

Garden City Spring Works,
2300 Archer Ave., Chicago, Ill.

When writing advertisers—Just say FORD OWNER AND DEALER

— ROMORT —
AIR and WATER STATION

"Pays You A Perpetual Profit"
 Because it continually brings you new customers. Its attractiveness catches the eye of the approaching motorist and its evident cleanliness and efficiency induces them to stop when in need of air and water. And where they stop for convenience they go to buy.
 Built in five styles for all requirements. Write our sales dept. today for full details.

Mfg. by
ROMORT MFG. CO.
 Oakfield, Wis.

Sales Dept.
THE ZINKE CO.
 1317 Michigan Ave.
 Chicago, Ill.



— PERFECT LOCK —
FOR FORD ROADSTER REAR COMPARTMENT LID



Locks Lid on both sides—
 and protects it in the center

WRITE FOR FULL PARTICULARS
THE STANDARD CORPORATION
 Columbus, Ohio.

B-W
COIL TESTER

A Quick, Easy and Infallible Test for the Coils of Ford Cars.

Every garage should be provided with this time-saver. It makes a testing job a matter of a few seconds. Pays for itself in one day's use. Ask for folder and terms.

Ballman-Whitten Mfg. Co.
 7421 Manchester Ave.
 ST. LOUIS, MO.
 Manufacturers of B-W Ammeters.





Sunlight Floods the Road with Light

Increases your light 100%. Dimmer complies with all laws, and can be used on battery equipped Fords. Every Ford owner wanted as our agent.
 Regular price \$3.50—**SPECIAL OFFER TO FORDOWNER READERS \$2.50 complete.**
SUNLIGHT CO., P. O. Box 394, Chicago, Ill.

Big Money in Tire Repairing

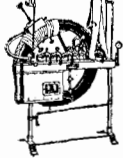
It's easy to make big extra profits doing tire repairing with a **SHALER Vulcanizer**. Many garages are making \$300 to \$500 every month. Requires no experienced operators—your ordinary help can quickly learn to operate it and do perfect work.



SHALER STEAM VULCANIZER

has Automatic Heat Control, and requires no regulating. Uses the Wrapped-Tread Method of repairing casings. Vulcanizes 12 casings and 200 tubes a day. Light, convenient and safe. Complete Outfit, with gas or gasoline burners, repair material, tools and full instructions, costs less than \$100.

Ask Your Jobber. Write us for complete catalog of the SHALER Line of Vulcanizers for tire repair shops and motorists' use.

C. A. SHALER CO., 2610 Fourth St., WAUPUN, WIS.



STAR-K INLAND SPIRAL-CUT PISTON RING
 Highest grade. One piece, spirally cut, special heat treated. They "follow the wear" by uncoiling like a spring against cylinder walls with equal tension all around.

STAR-K OILESS QUICK SEATING PISTON RING
 Stop oil pumping with this great popular priced ring. Has two oil grooves—one in middle for lubrication; one on lower shoulder to scrape down excess oil. Velvet finish makes it "quick seating."
 E148

Stark Inland Machine Works
 St. Louis, Mo.

LONGSAVER
 (Patented)
GASOLINE GAUGE AND GAS SAVER FOR FORD CARS

Absolutely accurate gasoline tank gauge. Easy to inspect day or night; can be carried to light when necessary. No operative parts to stick, get out of order or collect dirt.
 A loss by evaporation through vent hole, particularly during summer months, is prevented by venting through tube.
 A convenient means for getting gasoline for priming cleaning tube for patch when making road repair, or any other purpose where a small quantity of gasoline is required.
 Always read gauge before filling tank to check amount of gasoline required. Sizes to fit all Ford tanks. Price 75c by mail or at your dealers.

BARCY-NICHOLSON COMPANY
 2801 West Fort St., DETROIT, MICH



SURETY PEDAL PADS FOR FORDS
\$1.25 PER SET



Here's a thick molded pad of live rubber and heavy steel extension pedal in one. Gives the driver comfortable easy position with positive control at all times. **The Foot Can't Slip.** Complete satisfaction or your money back—that's our motto. Live representatives wanted.

GRANT AUTO APPLIANCE CO.
 315 S. Clinton Street CHICAGO, ILL.
 Originators of the extension pedal idea. Licensed manufacturers under Grant Patents.

STEEL WINGS



Comfort, Stability, Endurance
TRIPLE PURPOSE SPRING
FOR FORD FRONT

Guaranteed for the Life of Your Ford
Eliminates All Necessity for Other Shock Absorbers

STEEL WINGS CO.
Desk B. 670 Washington Blvd. CHICAGO, ILL.

LAMINUM

Laminated Shims are furnished ready-to-use for Ford crankshaft rear bearing, crankshaft front and center bearing, and connecting rod, in $\frac{3}{8}$ or $\frac{1}{4}$ inch thickness.

Address "Ford Sample Dept."
LAMINATED SHIM CO., Inc.
14th St. & Governor Place, Long Island City, N. Y.

DETROIT: Dime Bank Bldg. ST. LOUIS: Mazura Mfg. Co.
CHICAGO: 1118 So. Michigan Ave.

The Jennings Governor for the Fordson Tractor

The Jennings Engineering Company

504 Butler Building, DETROIT, MICH.



\$45
BUYS THIS
SNAPPY
SPEEDSTER

Just the graceful, racy sport car you want and you save big freight rates and one-half original cost through buying it knocked-down.

All parts cut to exact fit and accompanied by such complete, simple instructions that anyone can assemble it.

Complete with hood, Fiat radiator shell, instrument board, upholstery, metal and wood parts, bolts, screws, etc.

Car owners and dealers: Send today for complete details.

CENTRAL AUTO SUPPLY CO.
Eng. Dept. 123, Louisville, Ky.

New Life for Motors



"Nu-Life" Piston Ring Expanders are placed under piston rings to restore their life. They absolutely stop oil pumping, cure piston slaps, increase compression, reduce noise

and carbon deposits, save oil and gasoline, and give life to the motor, without installing over-size rings or pistons. Made for all types of motors. To obtain best results install one under each piston ring. Price 25c each.

Ford Owners: Send \$3.00 for a Complete Set

American Auto Products Co.
1319 L Street, N. W., WASHINGTON, D. C.

HARVEY WHEELS

BETTER LOOKING—STRONGER

More Ford owners daily are turning to Harvey Steel Wheels and Demountable Rims. Harvey steel wheels add to the appearance of any car and afford the greatest strength for their weight. They permit quick-tire change—add resiliency—easiest kept clean—give more miles per hour and less heat to tires. They are all steel and splendidly made.

Send for Complete Description and Prices Today

DEALERS:—There are real profits in offering this better wheel that car owners want.

HARVEY RIM AND WHEEL CO., INC.
BUFFALO, NEW YORK



Don't Be a Mutt

You don't need to pay a big, fancy price for a good spark plug any longer. Get a

Little Jeff

They sell at Fifty-five Cents retail for . . .

Besides giving you the best plug for a lot less money, we send free with every Little Jeff Plug one Little Jeff Plug Cleaner. This simple and ingenious new invention enables you to clean a set of plugs in two minutes. We will send one Little Jeff Plug Cleaner FREE to anyone upon receipt of a five cent stamp to cover cost of packing and mailing.

Write us today for booklet and prices

GENERAL ACCESSORIES CORPORATION, Chicago



STOP THAT WOBBLING AND RATTLE BY USING THE PRACTICAL LITTLE GIANT STEERING KNUCKLE TAKE-UP SPINDLE BOLT.

This bolt can be put on any Ford or Chevrolet No. 490 axle by any workman. It is made to take up all play that is worn in a Ford or Chevrolet No. 490 axle. By tightening the nut it tightens the head of the bolt as well as the nut. This bolt is made of good steel. There is an oil hole for grease cup, nut to key with a cotter pin.

Price to dealers \$1.50 the pair. Retail at \$2.50. No experience necessary to install these bolts.

All one needs is a reamer, which we furnish for \$2.00. Prices to Jobbers made known on request.

THE LITTLE GIANT MFG. COMPANY
212 N. Elm Street. IOLA, KANSAS.



BOTH COMFORT AND SAFETY

When driving your roadster or touring car in winter, you want comfort and need protection against drafts, snow or rain. You can have it! Your car will be warm and dry with **H. & B. Weather Shields for Fords**

"Keep the Weather Out and the Comfort In"

Patent Applied For

These practical devices can be attached in a few minutes and completely close the drafty leaky spaces between the windshield and side curtains. Made of sheet metal with a sealing flap of rubberized top fabric which fastens over side curtains.

No Wind, Rain, Sleet or Snow Can Possibly Enter

Simple, Strong, No Trouble No Rattle. At Your Dealer's or Sent Direct.

COST COMPLETE \$2.80 PER PAIR

DEALERS—H. & B. Weather Shields are selling as fast as shown.

Get the business NOW. Write.

HOLMES & BOSTROM CO., 367 17th Ave., Milwaukee, Wis.



FOR YOUR FORD Excelsior Breather and Oil Filler Pipe

Prevents oil spraying over motor, fan belts and wires. At your Dealers. If he cannot supply you, we will. Type A for 1915-1918 Fords; Type B for 1919-1921 Fords. Easy to install. Black Enamel Finish.

Manufactured by

**EXCELSIOR AUTO
PARTS & SUPPLY CO.
BRIDGEPORT, CONN.**

Price 85c

Worn-Out Tires worth \$20 a Piece



Wonderful invention. Insyde Tyres—Inner Armor for automobile tires. Old worn-out casings will give 2 to 5,000 miles more service. Positively prevent punctures and blowouts. Guaranteed to give double tire mileage, any tire—old or new. Applied without tools, just slip inside casing before replacing tube.

Car Owners Save \$50 a Year

Will not heat or pinch. Use over and over again. Low priced. Over 100,000 satisfied customers. Write for special terms. Agents wanted.

American Accessories Co., B-1937 Cincinnati, O.

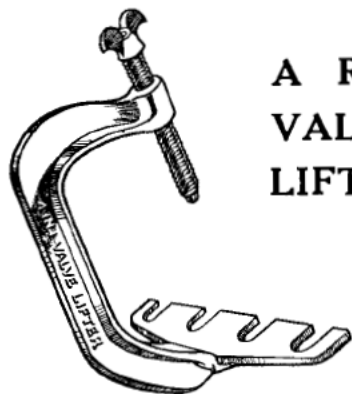

A REAL VALVE LIFTER!

Car owners and repairmen are quickly dropping old methods and turning to the new

4 in 1 FORD VALVE LIFTER

This better VALVE LIFTER is the one you have been waiting for.

It practically eliminates pins. It performs sixteen disagreeable operations in two simple movements. It removes four valves at once.

Simply insert the lifter; compressed springs; remove valves and pins with your two free hands. Grind valves with lifter in place. A quick, easy and satisfactory job.

You will be money ahead by ordering this tool now

Price Complete \$3.00

Write for information regarding our entire line.

LEWIS TOOL COMPANY

612 5th Av. S. MINNEAPOLIS, MINN.

LOOK FORD Nelson Oil Indicator OWNERS!

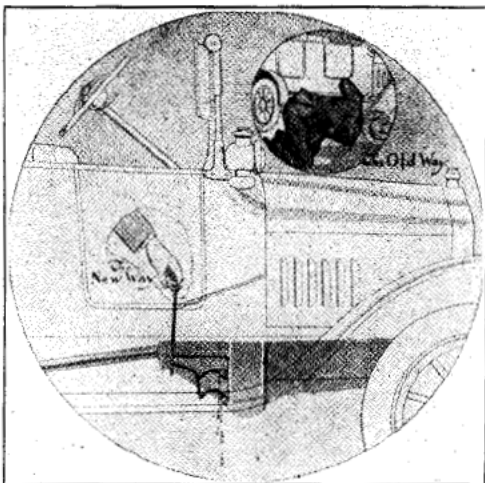

This is not an Oilgauge. It's a lever fastened to the petcocks so you can sit in your car and open them and see the supply of oil in your crankcase. It can be installed in five minutes. Lasts the life of your car. It has been O. K'd by Ford owners and garagemen.

Will be sent to any address in the U. S. upon receipt of \$1.00 postage prepaid. If you are not satisfied, return and your money will be refunded.

Special prices to jobbers, salesmen and garage owners.

Sold by

AUTOMATIC ENGINE LOCK CO., Mfgs.

979 University Ave.

ST. PAUL, MINN.

Ford Speedster Bodies

AND SPEED SPECIALTIES

BIG PRICE REDUCTIONS

SAVE 30 to 60% BUY NOW!

This Month's Specials

	Price	Special
Foot Accelerators.....	\$ 2.75	\$ 1.10
Manifold Hot Spots.....	5.00	2.19
Sight Feed Oilers.....	7.50	2.25
3:1 Bevel Gears.....	16.50	7.75
Underslung Fixtures.....	20.00	11.95
7-Day Waltham Auto Clock.....	25.00	9.50
4 Speed Victor-Ford Transmission.....	100.00	69.50

50% with order; Balance upon delivery. Satisfaction or money back guarantee. **I. H. Ford Speed & Power Equipment Manufacturers, 250 West 54th, New York, Cable Address Fordspeed Telephone Circle 0612.**

Ford Top Recovers

FORD TOP RECOVERS of double texture, long grain, tan and black auto-leather, same as high grade tops are made of, consisting of roof, side quarters and back curtain with 2 oval glass lights nickel rimmed 5x7. Made up ready to slip on your old top for \$9.50. Tacks and binding included. We also make special seat covers for Ford Sedans. Covering, seats, backs, doors and panels from windows down to floor. Made of high grade seat-cover cloth as used in the larger cars. Edges all bound ready to attach in half hour. At a special low price of \$12.50. These top recovers and seat-covers are made of high grade material and will appeal to people wishing a first class article at a low price. Parcel post paid when money accompanies order. Write for samples. **Atlantic Auto Top Co., 3310 Atlantic Ave., Atlantic City, N. J.**

Victor Foot Accelerators Sell!

Ford Owners Want the Victor Foot Accelerator

Permits use of both hands for driving. No alterations to car necessary. Easily installed in ten minutes. Only two connections—hand throttle and carburetor. Spring action entirely independent of hand throttle. Quicker and smoother get-away. No part fastened to floor board to interfere in removing same. Direct connection to carburetor eliminating lost motion and complicated spring devices. No vibration; resists wear, guaranteed. Price \$2.25.

Sales Agents: We Have An Attractive Proposition For You. Write, **VICTOR PRODUCTS COMPANY, Springfield, Ohio.**

Attention—Ford car and tractor owners—Tractor top with back cushion curtains, all round, \$49.50. Ford one man tops complete with curtains, \$42 and up. Topping outfit roof quarters and back curtain, \$7.75 and up. Back curtains, \$2.90 and up. Side curtains, \$10.50. Five piece artificial lace door coverings and panels, \$3.00. Seat covers, \$7.50 and up. Twin front seat cushions, \$10.50. Single front seat cushions, \$8.00; Rear seat cushions, \$8.50. Back upholstery ready to tack in—Front seat back, \$10.00; rear seat back, \$11.00. Our entire line includes all makes of cars. Motor boats and motorcycles. We also re-cover tops sent to factory. Samples, material and prices upon request. **Atlantic Auto & Body Works, 136 Jamaica Ave., Brooklyn, N. Y.**

WANTED—Men with Ford cars to sell STOKES CARBURETORS. Exclusive territory given. Write for particulars. **Stokes Carburetor Co., Inc., Good Ground, Long Island, N. Y.**

REBORE THE CYLINDER—Insert piston. No grinding, no lapping. Our \$20 Ford Cylinder Re-boring Tool leaves the cylinder absolutely smooth all ready for the piston. Simple, easy, rapid, accurate. Request circular. **Goruse Company, Elmira, N. Y.**

Dealers—Agents—Owners

Write for attractive proposition to handle the Harvard Second Spare Tire Carrier for all cars. Attaches to regular spare in one minute without straps, bolts or tools and sell on sight.

Harvard Machine Co. Cambridge, 38 Mass.

100% Efficiency From Any Ford Differential

Dealers and garage owners let us tell you of a practical means by which differential troubles may be overcome in a simple, efficient and inexpensive manner. Send in your name today and be the first to give this service in your territory. **R. G. ROSE, CATESBY, OKLA.**

Salesmen

Wanted in Every State

to call on automobile accessory dealers and garages with high grade line. All the salesman does is get the order and we do the rest. Full commissions on repeat business. A permanent and profitable position for a reliable salesman. Write for proposition.

THE M. S. SALES COMPANY,

118 East Jefferson St., Syracuse, New York.

AND SPEED SPECIALTIES

SAVE 30 to 60% BUY NOW!

AGENTS, JOBBERS AND DEALERS

The new 4-in-1 Band Wrench for Ford Transmission offers you one of the few possibilities of the season. If you are dealing in Ford accessories, get our proposition. A side line that offers you many dollars extra. A sale to every one. Show the wrench, take his order. We fill and forward commission to agents. Literature free. Sample 40c.

WILLIAM & BINNS
West Brownsville, Pa.

Avoid "turning turtle," leaving the road locking over center. You can steer safely and easily out of ruts, through mud, sand, snow and on center-crowned roads, with our Worm Steering Gear. Same type as used on all larger cars. Prevents bumps or other obstacles turning the front wheel aside and throwing car from the road; gives you control of the steering. Also absorbs vibration, shock and strain on arms and shoulders. Makes a far safer and better car. Easily, quickly installed; no holes to bore; outlasts car. Guaranteed to satisfy you. Write for particulars. **Union Sales Co., Dept. 4, Omaha, Neb.**

INVENTORS should write for our book "How to Obtain a Patent," which contains valuable information which every inventor should have. If you will send us a sketch, model or photograph of your invention we will promptly make search of the Patent Office records and advise you whether or not your invention is in our opinion patentable; our charge for the service being \$5.00. With an experience of over twenty years we feel that we are fitted to render you prompt efficient service which will merit your confidence. Moderate charges. Write today. **Talbert & Talbert, 451 Talbert Bldg., Washington, D. C.**

SYSTEMATIZE YOUR AUTO REPAIR SHOP—Bin Label Cards for Ford Auto, Ford Starter, Ford One-Ton Truck and Fordson Tractor Parts, Sheet Metal Card Holders, Auto Stock Forms, Job Repair Tickets, Time sheets, Requisition Blanks, Order Books, Cash Sales Slips, Repair Tags. Send for free samples and free booklets: How to Systematize the Auto Stock Room and Build Bin Racks; Perpetual Stock Inventories, and Book-keeping Hints for the Auto Dealer. **Haddon Bin Label Co., Haddon Heights, N. J.**

Salesmen with established trade among accessory jobbers, we have new profitable side line. **Union Specialties Company, 5871 Glenwood, Chicago.**

When writing advertisers—Just say FORD OWNER AND DEALER

"Worth hundreds of dollars to every car owner; worth thousands to manufacturers and garages—Formulas, 17 different auto necessities for \$1.00: Descriptive circular FREE. Eureka Supply Co., Wheeling, W. Va."

DON'T BREAK YOUR ARM cranking your Ford. Get a Miller Starter for \$5.75, postpaid, try it, then get an agency and sell to your neighbors and make money. **H. A. MILLER, Mfr., Memphis, Missouri.**

SALESMAN—Acquainted with buyers and who can obtain orders for sales check books can make favorable commission arrangements with leading Chicago concern in this line. CHICAGO SALES BOOK CO., Chicago.

Fifteen percent more power a sure start in cold weather by using a R-L TIMER on your Ford. \$3.00, 60 days trial.

K-L MFG. CO., Lincoln, Neb.

PATENT FOR SALE

My U. S. Patent No. 1330672 Ford Coil Guard prevents removal of Coil Cover or theft of Coils. Can be made cheaply and sold for One Dollar. Drawings and Particulars to Responsible Parties write Roy C. Yonge, Multnomah, Oregon.

Distributors & Salesmen for certain states to sell the Ford dealers a Keyless Lock for Ford cars approved by the Insurance Laboratories. We can also use an agent in every town of 10000 or more to sell our Keyless Locks for steel lockers and Gasoline pumps, to Telephone Company, Schools, Department Stores, Factories, Garages, etc. Sample Locker Lock prepaid \$1.35. Keeno Keyless Lock Co., 2738 West Railroad Ave., Evanston, Ill.

Ford cover for carburetor and intake pipe, patented. Adds 25% more mileage and power. Put on any Ford motor in 2 minutes. Price \$1.50. Special price in quantities. Air Friction Carburetor Co., 9131 Madison St., Dayton, Ohio.

For Sale Type B Roof's 16 Overhead Valve. Has been run four months. Have sold my Ford. Highest offer takes it. **Napoleon Lamontagne, Williamantic, Conn.**

\$20 A DAY

Wanted: Agents, dealers and manufacturers representatives, to handle the SPAD TIMER for Fords. Unusual opportunity to make real profits on a fast moving easy selling Ford necessity. The cheapest high grade timer on the market. Only two moving parts, absolutely no oil and built like a magnet. Assures a fat hot spark. Exclusive sales proposition. Guaranteed for one year. List price \$4.00. Very attractive discount. **Omar Tire & Rubber Co. 42 West 39th Street, New York, N. Y.**

Tires, Buy used tires for winter 30 x 3 1/2 \$3.00. Used Car Dealers get our prices. **Dependable Tire Co., 4416 Easton, St. Louis, Mo.**

PATENTS—Write for illustrated Guide Book and Record of Invention Blank. Send model or sketch and description for our free opinion of its patentable nature. Highest references. Prompt service. Reasonable terms. **Victor J. Evans & Co., 627 Ninth, Washington, D. C.**

Agents \$8 a day taking orders for Inside Tyres. Positively prevent punctures and blow-outs. Guaranteed double tire mileage. Old worn out casings will give 3 to 5 thousand miles more service. No tools needed. Just slip inside casing before replacing tube. Will not heat or pinch. Katz made over \$500 first month. Biggest thing on the market. Low priced. Write for territory. **American Accessories Co., B-1031, Cincinnati, Ohio.**

"Ford and Fordson Owners."—Stop that motor from pumping oil. Instructions. Sample of treated piston \$1.00. No extra to buy. Eight years with Ford Motors. The only successful method known. Guaranteed or money refunded. **J. W. Reynolds, Liberal, Kans.**

NEUTRAL Safety Pedal. Makes your Ford car a selective drive, will hold forward speed in neutral independent of emergency lever. A real necessity for a Ford car. County agents wanted. Send \$3.50 for agent's sample. **Auto Safety Supply Co., 3247 W. Van Buren St., Chicago, Ill.**

AGENTS—\$250 worth Self-Selling Auto Devices quickly made from \$10 worth of material. No experience or tools required. Fast seller. Agents or Mail Order. Investigate. **Exchange System, Cullom, Illinois.**

"Protect your Ford Timer Wires for the Winter against short Circuits, water and oil, by sending \$1.25 to **M. J. Ahern, Columbia St., Ansonia, Conn.** for the Ahern Guard. Dealers and Agents wanted.

OIL PUMPING MOTORS are costly. This trouble can be easily overcome. Write today for free advice on a simple and economical means of ending this nuisance. State make, model and year of your motor. **J. A. CHOPA, Auburn, Ind.**

"INVENTORS—Don't lose your right to patent protection. Send for blank form 'Evidence of Conception' to be signed and witnessed and information bulletin 'How to Establish Your Rights.' Both are free and very desirable to proper patent procedure. **LANCASTER and ALLWINE, 238 Ouray Building, Washington, D. C.**

Big Profits Easy—Duplex Transformers needed on every auto. Save gas. Easily sold. Exclusive distributors wanted. **Jubilee Mfg. Co., 118 Sta. C, Omaha, Nebr.**

AGENTS WANTED

Towlines sixteen feet long with hooks. Small enough for tool box. Replaced if broken within year. \$2.50 delivered. Agents price \$15.00 dozen. Sample \$1.50. Order sample today. Will buy back any you don't sell. **The Superior Manufacturing Co. Penn-Lillis Building, Cleveland, Ohio.**

Champion Spark Plug Bargains!—Compare prices, Ford size 59c. For other cars 69c. Sent postpaid anywhere. **Morris Service, Box 524, Omaha, Nebr.**

Wanted—Salesmen who call on Ford Dealers, Service Stations, Garages, Jobbers and Accessory Stores. Can earn a neat sum each month without interfering with their regular work. Write for particulars.—**Ford Owner and Dealer Magazine, Dept. C., Montgomery Bldg., Milwaukee, Wis.**

OIL GAUGE FOR FORDS. Remarkable new invention. Sells on sight. Big profits easy. Exclusive distributors wanted. Address **Sales Mgr., 118 Sta. C, Omaha, Nebr.**

Belt Power Attachment, Price \$6. agents wanted. **George Stirdivant, Sheboygan Falls, Wis.**

"Salesmen with Ford cars! Look at our ad of the Venn Auto-Lock on page 104, and then write us for our liberal selling proposition to users. **Taylor-Shantz Co., 482 St. Paul St., Rochester, N. Y."**

Peejay step-cut piston rings for automobile, tractor, truck and marine engines. Guaranteed to do everything a piston ring can do. Two to four and one-half inch diameter, fifty cents. Special set of twelve for Ford \$4.50. **Phil Jacobs, Distributor, Portsmouth, Ohio.**

Salesmen—To sell our Carbon Remover, Radiator Cement, Polish and other products to automobile owners and accessory dealers. Big commissions and a wonderful opportunity for hustlers. **Bush Chemical Company, St. Louis, Mo.**

Accessory Dealer, 100 Per Cent Profit on Cost. Send name and address. We'll send you proposition, which gives you 100 per cent profit on cost, and our 50c size free, postage prepaid. No obligation to buy. **NoXal Co., 1238 Belmont Ave., Philadelphia, Pa.** Mention Ford Owner.

\$108, weekly, selling our marvelous new Heat-O-Meter. Every automobilist wants one. Wonderful opportunity; write today. **Pegasus Co., 160 E. 31 St., New York.**

Late model genuine "Hot Spot" Wilmo manifold for Ford cars. Check for \$3.75 gets immediate shipment. **United Supply Company, Dallas, Texas.**

HUBBELL GLASS WINDOWS—the highest class, biggest value on the market. for replacing celluloid in rear curtains. Suspended from top bow of car with web straps to prevent sagging and tearing. Black Enamel Frames, set of three, complete, \$2.00. Aluminum, \$2.50. Postpaid. Agents wanted. **The Hubbell Mfg. Co., 1163 Addison Road, Cleveland, O.**

Life time opportunity to represent manufacturer nationally known product. Big repeats, handsome profit. Sample and information free. **Utility Co., 639 W. 44th St., N. Y.**

Ford timers reground, better than new 35c, 3 for \$1.00; try us. **Stephen Mackin Machine Shop, 54 Hermon St., Worcester, Mass.**

INDEX TO ADVERTISERS

A	A. Gilbert & Sons Brass	Perfection Auto Parts Co.122
Ajax Auto Parts Co.....19	Fdry. Co.....83	Perfex Radiator Co.....88
Algonquin Electric Co.....23-99	Globe Stamping & Machine	N. A. Petry Co., Inc.....114
American Accessories Co.....125	Co.....107	Phoenix Mfg. Co.....96
American Auto Products Co.....124	G. & O. Mfg. Co.....38	Piston Ring Co.....34
American Metal Prod Co.....70	Grant Auto Appliance Co.....123	Plate Glass Mfrs. of Amer-
American Specialty Co.....110	H	ica.....88
American Taximeter Co.....89	Hartland Co. Inside Back Cover	Pressed Metal Mfg. Co.....122
A. R. G. Auxiliary Spring	Harvey Rim & Wheel Co.....124	Pressure Proof Piston Ring
Co.....115	Hastings Mfg. Co.....118	Co.....97
Arvin Heater Co.....37	Robert H. Hassler,	R
Atwater Kent Mfg. Co.....7	Inc.....Front Cover	Racine Screw Wks.....111
Auto Equipment Co.....120	Hawthorne Lamp work.s.....105	Radiator Funnel Cap Co.....121
Automatic Auto Locks, Ltd.....118	Mark W. Heath.....91-104	Rajo Motor Co.....11
Auto Products Co.....89	Heaton-Ault.....120	Red Arrow Prod. Co.....31
Auto Products Mfg. Co.....113	Herz, Inc.....87	Red Cup Lubricator Co.....114
Auto Specialties Co.....18	Holley Carburetor Co.....15	Republic Motor Co.....21
Automatic Engine Locks	Holmes & Bostrom.....125	Republic Supply & Rubber
Ptd.....125	Hot Spot Generator Co.....4	Co.....112
Automotive Utilities Corp.....109	Hugro Mfg. Co.....10	Reynolds Spring Co.....122
B	Hydro-United Tire Co.....112	George Riley & Co.....121
Ballman-Whitten Mfg. Co.....123	I	Kingless Piston Ring
Banner Sales Co.....104-108	Imperial Bit & Snap Co.....111	Co.....Back Cover
Barcy-Nicholson Co.....123	Independent Storage Bat-	Romort Mfg. Co.....123
C	tery Co.....102	Frank Rose Mfg. Co.....121
B. G. Corp.....79	I-Ne-Da Fender Brace	S
Breden & Cole.....108	Mfg. Co.....90	Safety Oiling System, Inc.....68
Briggs & Stratton Co.....102	Ingram Motor Co.....108	A. Schrader's Sons.....93
Merton L. Britt.....94	Inland Metal Products Co.....113	Security Auto Lock Co.....97
Buob & Scheu.....120	Inland Auto Co., Inc.....81	Service Products Co.....105
Burd High Compression	International Auto Drive.....119	C. A. Shaler Co.....123
Ring Co.....111	J	Shehan Tool Wks.....121
Bryne-Kingston Co.....22	Jaffe Radiator Co.....65	Shok-an-Snub Sales Co.....104
Cantrell-Miller Mfg. Co.....36	Jennings Eng. Co.....124	Simon Supply Co.....86
Castor Distributing Co.....109	Johnson Co.....96	Simplex Gauge & Tool Co.
Cataract Mfg. Co.....5	K	1.....107
C. C. & F. Mfg. Co.....116	Ka-Es Mfg. Co.....106	Smooth-On-Mfg. Co.....108
Central Auto Supply Co.....124	K. - D. Lamp Co.....91	South Bend Wrench &
Champion Mfg. Co.....105	Keeno Keyless Lock Co.....101	Tool Co.....26
Cincinnati Lamp & Bracket	Keystone Reamer & Tool	Sparko-Gap Co.....121
Co.....119	Co.....4	Springcup Co.....119
Chicago Electric Mfg. Co.....111	Kemp Mch. Wks.....86	Standard Corp.....123
Cleveland Water Still Co.....114	L	Stark-Inland Mch. Wks.....123
Adam Cook's Sons.....110	Laminated Shim Co.....124	Steel Wings Co.....124
Cooper Mfg. Co.....122	Lazear Auto Products Co.....17	Sterling Mfg. Co.....2
C. Cowles & Co.....25	Laurel Motors Corp.....102	Steam Tractor Auto & Mfg.
Cramer Mfg. Co.....107	Lehman Mfg. Co., Inc.....120	Co.....13
Craig Mfg. Co.....97	Lewis Tool Co.....125	Storm Mfg. Co.....120
E. D. & A. F. Cronk, Inc.....100	Lightning Supply Co.....110	Success Seed Grader Co.....108
W. C. Cunningham.....108	Little Giant Mfg. Co.....124	Sunlight Corp.....123
Curtis Pneumatic Mch. Co.....113	Lockwood Products Co.....92	
Custer Mfg. Co.....106	David Lupton's Sons.....14	
Cyclo Mfg. Co.....117	Lyon Metallic Mfg. Co.....92	
Cyl-Lap Products Co.....116	M	
D	Macorvey Co.....106	
Dale Mfg. Co.....122	Marquette Mfg. Co.....106	
Defender Auto Lock Co.....29	Marathon Electric Mfg. Co.....93	
Detroit Parts Mfg. Co.....28	Marvel Carb. Co.....112	
Detroit Steering Control	Master Products Co.....116	
Co.....118	McKinnon Dash Co.....95	
Dickey-Grabler Works.....12	Metal Specialties Mfg. Co.....16	
Douglass Auto Appliance	Metal Stamping Co.....41-120	
Co.....115	Michigan State Auto School	
Dow Chemical Co.....44	Co.....98	
Dow Co.....113	Michon Mfg. Co.....114	
Frederick J. Drake & Co.....122	Miller-West Co.....32	
Duncombe Overrunning	W. J. Miller Co.....103	
Clutch Co.....117	Milwaukee Auto Engine &	
Dunn Mfg. Co.....94	Supply Co.....	
EInside Front Cover	
Eclipse Timer Mfg. Co.....32	Modine Mfg. Co.....69	
Electric Machine Co.....95	Monarch Metal Products Co.....9	
Ensign Carburetor Co.....6	Monroe Body Co.....100	
Essential Automotive Prod.	Moore Mfg. Co.....20	
Co.....98	Morton Mfg. Co.....120	
Evans-Cooke Mfg. Co.....115	Motor Products Cor.....12	
Excelsior Auto Parts &	Moto-Meter Co., Inc.....121	
Supply Co.....125	N	
F	Nathan Novelty Mfg. Co.....85	
Federal Motor Supply Co.....121	National Rubber Filler Co.....86	
Four-A Products Co.....33	New England Mills Co.....119	
France Mfg. Co.....105	New York Coil Co.....40-30	
G	Non-Kick Device Co.....101	
Garden City Spring Wks.....122	P	
F. G. Garden.....119	Paco Mfg. Co.....113	
Gemco Mfg. Co.....35	Partridge, Singer & Bald-	
General Accessories Corp.....124	win.....3	
	Penberry Injector Co.....115	

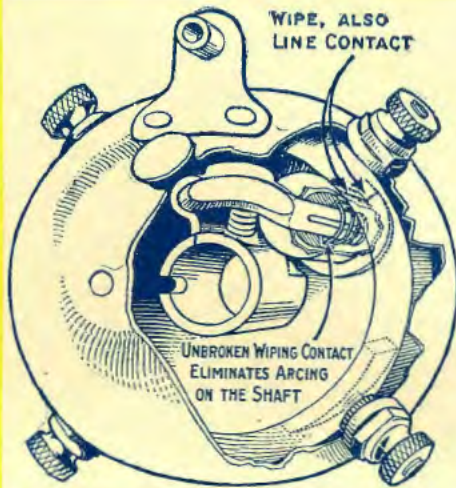

THE RUSH Dual Contact Timer Roller *The Real Test*

Pick out your hardest starting Ford car, one on which you have to use batteries, or you have to tow it around the block, or jack up the rear wheel, put it in high, and then spin it; one which runs all right on magneto after you get started, but which is harder than Hades to start.

Install a **RUSH TIMER ROLLER** on this car and you will start it on magneto with a quarter turn without spinning.

We are the only timer people who invite this test and we have never fallen down on it.

Price \$1.50 Each

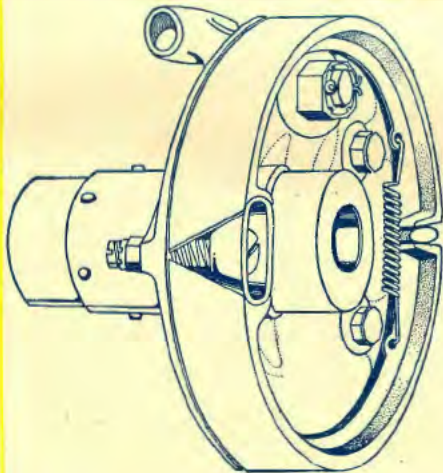

THE RUSH Adjustable Emergency Brake Shoes

Easily and quickly adjusted without removing rear wheels.

No special tools required. A wrench and screw driver are the only tools necessary. Will take up the wear in old brake drums. Positive in action and always dependable. Braking effect the same on both rear wheels. Maximum wearing surface and long life. Will outwear several sets of ordinary brakes.

Price \$2.00 per Set

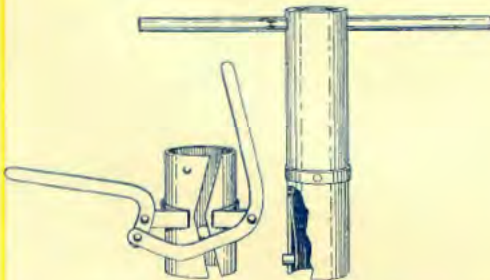

THE RUSH Puller and Compressor FOR Rear Axle Bearing Sleeves

The most convenient tool on the market for removing and inserting the bearing sleeves of Ford rear axles. Quick and easy to operate.

**SAVES TIME SAVES SLEEVES
SAVES MONEY**

Price \$7.50 per Set

ABSOLUTE SATISFACTION GUARANTEED OR MONEY REFUNDED

THE HARTLAND COMPANY

1974 BROADWAY AT 67TH STREET

NEW YORK CITY

NEW YORK SHOW—Space D-189

CHICAGO SHOW—Space 23



TRADE MARK

THE RINGLESS PISTON

An installation of Ringless Pistons in the engine of your car is a simple matter..... But the results in increased motor efficiency are far-reaching and Permanent. For the Ringless Piston, Tismer Patent, is delivering engine service today which was undreamed of when piston rings were considered a necessary evil.

It has not only proved that rings are unnecessary, but are a primary cause of oil-pumping, the formation of oil-carbon, over-heating, pre-ignition, fouled valves and loss of power. In a word, the Ringless Piston "gives the oil a chance"—to lubricate the cylinders and form a gas-tight seal against compression.

Once in place, each piston will outlast the engine, without further attention or adjustment. It will keep the combustion chamber free from oil, eliminate smoke from the exhaust and absolutely prevent damage from over-heating.



The Old Style Piston



The Ringless Piston

Send for descriptive folder

This is accomplished without any structural change in the motor itself.

It can be installed as a piston replacement wherever motors are overhauled. It requires no special machinery or tools for a perfect installation. Its cost is within the reach of every car owner.

This Company or its branches will furnish further information upon request.



THE RINGLESS PISTON REPLACEMENT CORPORATION

103 Park Avenue
NEW YORK

225 North Mich. Blvd.
CHICAGO

126 New Montgomery St.
SAN FRANCISCO

When writing advertisers—Just say FORD OWNER and DEALER