

# FORD OWNER and DEALER

NOT CONNECTED WITH THE  
FORD MOTOR COMPANY

November 1921  
15 Cents

## In Quaint Old Holland—

IN QUIET HOLLAND with its tulip beds and awkward windmills, is an entirely different atmosphere from what we know in America. Yet Ford Cars are running there—and are giving delightful service—giving unusual economy and unusual satisfaction because Hasslers also are used. Wherever there are Ford Cars there are Hasslers—because Hasslers save one-third of upkeep, tire and depreciation costs—in addition to the luxurious comfort.

### Robert H. Hassler, Inc.

1501 Naomi Street  
INDIANAPOLIS, U. S. A.  
Robert H. Hassler, Ltd., Hamilton, Ont.



*The Ford in Holland*

# If this Quits, You Walk!



**Y**OUR Ford's brain is the timer. Failure here leaves the engine an inert mass of metal—powerless. The timer controls the firing of the cylinders. If every explosion is not full-powered, clean and rightly timed, your Ford labors on hills, bucks in sand and mud, and balks at starting on chilly mornings.

Forty perfect sparks per second, for thousands of miles—that's the timer's average job! No wonder experienced Ford owners use the best timer they can get—the MILWAUKEE. Their reward is steadier pulling, easier starting, less carbon.

Better materials, finer workmanship, sturdier design have made the MILWAUKEE TIMER the largest selling Ford replacement. Endorsed by all garage mechanics, and a million users.

Your Ford will run better if you put on a MILWAUKEE TIMER—a 15-minute job with a pair of pliers. Be sure you get the genuine, with the name "MILWAUKEE" on shell and brush assembly. There are many imitations.



**D**EALERS find our new Steel Display Stand a mighty effective "silent salesman." Lithographed in three colors and holds a complete timer. For either window or counter. We have one for you FREE. Write for it today.

## DEALERS:

The MILWAUKEE TIMER is recommended by 89% of all Auto Supply Jobbers. It outsells all other timers on the market. If you are not stocked, ask your jobber.

**Milwaukee Auto Engine  
& Supply Co.**

MILWAUKEE, WIS.

Retail price, \$2.00  
(West of Rocky Mts., \$2.10.)

# MILWAUKEE TIMER *for* FORDS

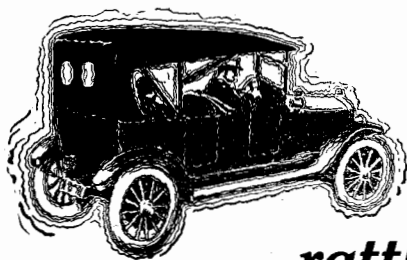

Write for This Booklet  
It Tells How to

## Stop Ford rattle and shake



Why do Fords rattle and chatter? They're better built than most cars and should run smoothly. Faulty brake lining is the trouble maker.

Ordinary brake lining gets hard, flinty, slick—hasn't any grip—grabs and slips every time you press the pedal. This shaking loosens nuts and bolts—makes the whole car rattle.

Advance Cork Insert stops the shivering and shaking when you work the brake. Grips instantly, smoothly. No shaking or chattering. Never gets hard and slick.

Why shake your Ford to pieces with hard, slick brake lining? If it's new, put in Advance Cork Insert and keep it new. If it's a used car, Advance Cork Insert will make it work surprisingly smooth—free from rattle and vibration. Saves repairs to rear end and transmission.

**BE SURE YOU GET GENUINE ADVANCE CORK INSERT.** Your garage, repair or accessory man has it or can get it; every wholesale house carries the genuine in stock or can get it. It's perfected through years of service.

**REMEMBER:** Cork Insert will save you relining expense—one set will outlast three sets of ordinary lining.

### Advance Automobile Accessories Corp.

Dept. 100, 1721 Prairie Ave., Chicago.

Publishers of "Let's Go."

DEALERS:—Order From Your Jobber or Write Us Direct

\$3.50 per  
set of three.

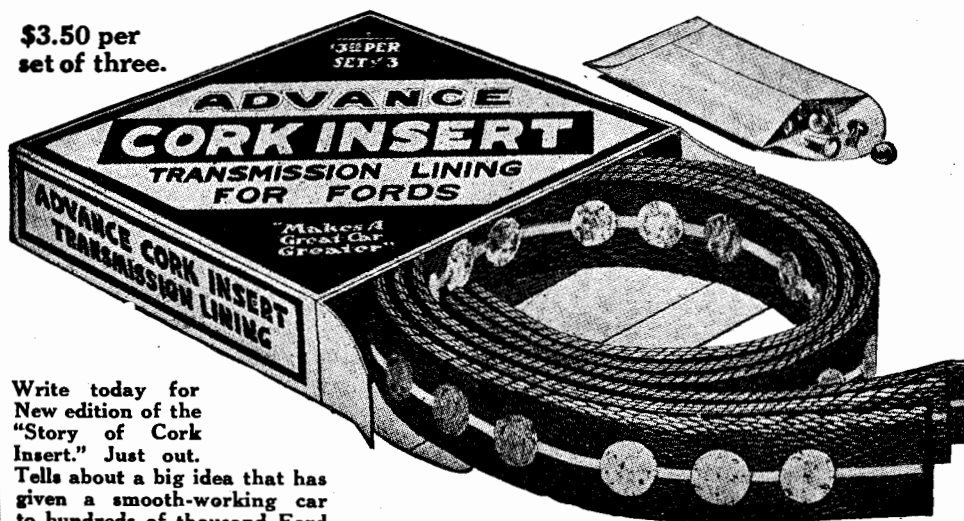

Write today for  
New edition of the  
"Story of Cork  
Insert." Just out.  
Tells about a big idea that has  
given a smooth-working car  
to hundreds of thousand Ford  
owners.

When writing advertisers—Just say FORD OWNER AND DEALER

# Insure Against a Frozen Radiator

Avoid  
Expensive Re-  
pair Bills. Save 50%  
on Alcohol and Oil

**MILWAUKEE**  
**CIRCULATING WATER PUMP**  
FOR FORD CARS AND TRUCKS

For FORD CARS and TRUCKS

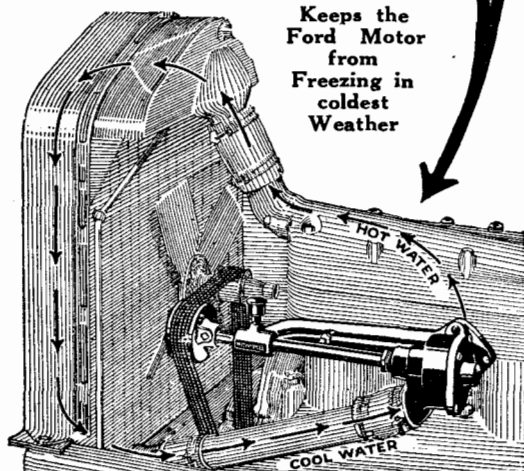

Keeps the  
Ford Motor  
from  
Freezing in  
coldest  
Weather

**T**HE radiator in a Ford Car usually freezes in the first three to five blocks driving after a stop because its "pumpless circulating system" cannot induce circulation until the engine has run long enough to get the water heated to 180 degrees.

The Milwaukee forces circulation immediately Prevents overheating in summer—avoids freezing in winter. Get yours NOW.

**Cramer Mfg. Co., Dept. B, Milwaukee, Wis.**

Sales Representatives

C. N. & F. W. JONAS, 525 Trans. Bldg., Chicago, Ill.

SAN FRANCISCO	LOS ANGELES
111 New Montgomery St.	407 Equitable Bldg.
SEATTLE	ATLANTA
616 Pioneer Building	197½ Edgewood Ave.
DALLAS	JAMAICA, L. I., N. Y.
1403 Grand Ave.	44 Herriman Ave.

**FORD OWNER**  
and  
**DEALER**

Entered as second-class matter, January 29, 1916,  
at the Post Office at Milwaukee, Wisconsin,  
under the Act of March 3, 1879.

Contents Copyright 1921

Vol. 16 NOVEMBER 1921 No. 2

The FORD OWNER AND DEALER is an independent monthly journal having no connection with the Ford Motor Company. We are trying to serve the best interests of the dealers and owners of Ford Cars and propose to "hew in the line, let the chips fall where they may."

15 cents a copy, \$1.50 a year in U. S., Canada and Mexico. Foreign Countries, \$2.00.

Published Monthly by  
**THE TRADE PRESS PUBLISHING CO.**

Montgomery Building  
MILWAUKEE, WISCONSIN

H. A. Apple, Publisher and Editor  
Frederick L. Goulston, Advertising Manager  
Paul C. Treviranus, Business Manager  
Harry J. Larkin, Managing Editor  
Murray Fahnestock, Technical Editor  
J. D. Campbell, Art Editor

#### BRANCH OFFICES

##### NEW YORK OFFICE—

CLAIBORNE M. GARRETT,  
The Commerce Chambers  
48 East 41st St.

##### CHICAGO OFFICE—

E. J. KEYS,  
743 Webster Bldg.  
Van Buren and La Salle Sts.

##### DETROIT OFFICE—

ROY BUELL,  
516 Leightner Bldg.,  
242 La Fayette Blvd., W.

##### ST. LOUIS OFFICE—

M. M. SHURMAN,  
713 Star Bldg.

##### WESTERN REPRESENTATIVE—

C. M. MINIER,  
510 Title Insurance Bldg.,  
Los Angeles, Cal.

513 Pacific Bldg. 405 Walker Bldg.  
San Francisco, Cal. Seattle, Wash.

To save delay send all general and subscription communications to the main office at Milwaukee, Wis.

#### IN THIS ISSUE—

Radiator and Hood Covers.....	46
Storing the Ford for Winter.....	51
Garage Heaters.....	55
Tractor Division.....	72
Hints .....	86
Questions .....	88
Equipment Review.....	90

When writing advertisers—Just say FORD OWNER AND DEALER

## RAJO Prices Recently Reduced 45%!

Now this marvelous attachment is within the reach of practically every Ford owner.

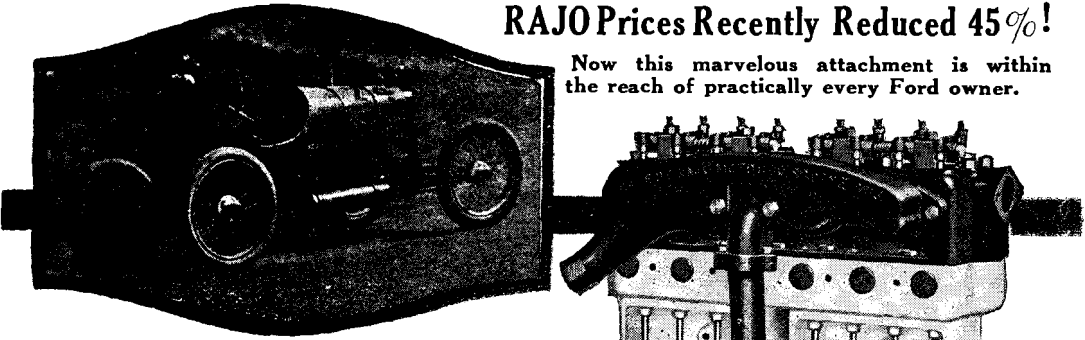

**W**ITH this RAJO-equipped Ford Special, Glen Schultz of Colorado Springs, Colo., took first place at the Pike's Peak Hill Climb on Labor Day, among cars with a maximum piston displacement of not to exceed 183 cubic inches. This race is recognized as one of the most dangerous in the country, and by far the most severe. Schultz covered the 14 mile climb in the remarkable time of 21:34 3/5.

## You Can Make Your Ford a Champion!

**Y**OU can make YOUR Ford a powerful, speedy, smooth-running champion of the road the same as Glen Schultz did! Simply replace the regular Ford cylinder head with RAJO—only a four to five hour job. Automatically you add from 8 to 14 H. P. to your Ford motor and increase speed 50 per cent, without a change in gear ratio. No more edging to the side of the road to let larger, more expensive cars pass by—you get a snappy pick-up that permits acceleration from 5 to 40 miles an hour in 14 seconds flat, and speed that will quickly put the speedometer to between 55 and 60 miles an hour.

Power?—Why, with RAJO practically the only time you use low gear is for starting. The slightest advance of the throttle releases a flood of power that conquers most every hill on high, for RAJO makes the Ford the most powerful pleasure car in the world per pound of weight!

### PROLONGS LIFE OF YOUR FORD— PAYS FOR ITSELF FIRST 2500 MILES

RAJO'S close-seating, double-size Tungsten steel valves, combined with combustion chambers machined to an accuracy of 1/1000 of an inch, result in a more even flow of power. There is less engine vibration and destructive transmission-band "chatter." And besides thus prolonging the life of your Ford, remember this:

A RAJO Valve-in-Head will last through the life of three Ford cars. With its Hot Spot and Cored Intake RAJO saves enough in gasoline alone to pay for itself the first 2500 miles.

No machining required, no fittings to buy—RAJO comes complete for a quick installation on the motor block as is shown above. Cast in one piece of highest grade cylinder iron; push rods of cold-rolled steel with hardened concave heads which retain the oil and give smooth, quiet valve-action.

FORD OWNERS—Write today for the new RAJO folder—fully illustrated and more complete than ever.

DEALERS—A postcard will bring you our most attractive proposition on a number of RAJO improvements.

## RAJO MOTOR CO.

1355 RACINE ST., RACINE, WIS.

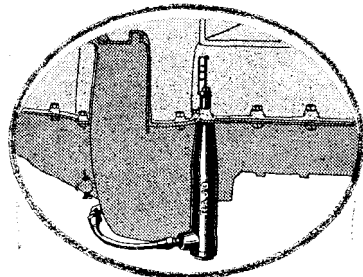

### AT LAST—AN ACCURATE, PRACTICAL OIL GAUGE

No glass tubing to quickly darken up—no rods to unscrew, lift out, read and then put back in place. To know exactly how much oil you have with a RAJO oil gauge it is only necessary to lift the engine hood and look at the measuring wire which works freely on the float within the "barrel" of the gauge itself. Cannot clog because a sediment cup traps the dirt in old oil. Now you can get a Ford oil gauge embodying the same principle as is used on the most expensive cars.

PRICE \$3.25



When writing advertisers—Just say FORD OWNER AND DEALER

# K. R. WILSON OF BUFFALO

Originator of  
**SPECIAL TOOLS**  
for AUTOMOBILE REPAIR SHOPS.  
*Save 75% on your labor costs*



## Who Buys Them?

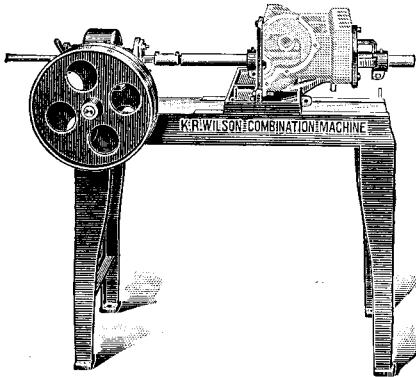

### CYLINDER BORING To Fit the Pistons FITTING BEARINGS

Bearings are cast with fillets. Then bored out by 3 cutter power tool to approximately 1.244. Then reamed (power) to 1.249 or .001 larger than Crankshaft. Running in with oil will then produce perfect bearings.

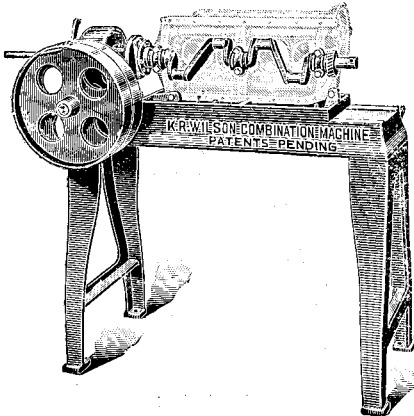

### RUNNING IN

There Is a Demonstrating Machine Near You. Write Today!

The majority of K. R. Wilson Combination Machines have been sold to FORD AGENTS who were equipped with very expensive and elaborate machinery. Here are some of the reasons why:

It does better work, making satisfied customers.

Reduces labor costs at least one-half, doubling the profits.

One H. P. Motor for any operation, does away with big power bills.

**MODERATE INVESTMENT**

(\$365.00)

**SOON PAYS FOR ITSELF**

The only machine that applies the Ford Factory Process of Fitting Bearings. Rebores Cylinders to Fit the Pistons.

The type of Service Stations using the KRW Combination Machine and Process.

Ask Them:

Meldrom Motor Co., Buffalo, N. Y.  
Judge Motor Co., Rochester, N. Y.  
Warman-Pfouts Co., Wilkesbarre, Pa.

## K. R. WILSON

10-16 LOCK STREET

BUFFALO, N. Y.

DISTRIBUTORS

WETMORE SAVAGE CO., Boston, Mass.  
E. A. FEATHERSTONE, Los Angeles.  
L. C. WAY, Houston, Texas.

LANSING BROS., INC., Scranton Pa.  
Thompson Reilly, Newark, N. J.  
WHITTEMORE SIM CO., New York.

H. W. HENDERSON, Commonwealth Ave., Detroit, Mich.

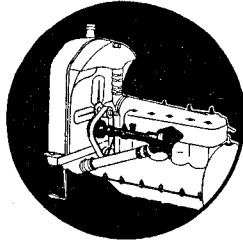

*As Far As Circulating Water Pumps  
for Fords are Concerned, in the*

# Cataract

*You Get Everything*

Mechanically, the Cataract is the best pump made. It looks like quality always looks. Even the name Cataract, is right—, it produces a powerful flow of water. Positively prevents overheating in hottest weather, so rapid in circulation that the water cannot possibly freeze even at a temperature way below zero. That's a fact. The manufacturers behind the Cataract are right—, they are "straight shooters". This is well evidenced in the extraordinary guarantee attached to every Cataract pump. The Cataract has got to stand up. It is

guaranteed in writing for 100,000 miles.

That is why Distributors Dealers and Ford owners are absolutely secure when the pump being considered is a Cataract. It is like buying a liberty bond. Cataracts are always redeemable, whether they are on the dealer's shelf, or in operation on a Ford car or truck.

And the Exclusive Territory Franchise to Distributors, or the Proposition to Dealers, is as much better as the Cataract pump, itself, is better.

***You Could'nt Ask More—  
Where Can You Get as Much?***

*That alone is enough reason why you should write to the Cataract Mfg. Co., Milwaukee, Wis., and ask for full particulars.*

# Make Your Parking Light A Stop-Signal

**I**N A FEW MOMENTS you can convert any style of parking light into a practical stop-signal automatically operated by the foot brake by equipping your car with the

## WESCO Auto-Stop-Park-Signal-Switch

(Patent Applied For)

Safety  
and  
Surety  
at  
Small  
Cost  
  
Requires  
no  
Attention.  
Operates  
Automatically.

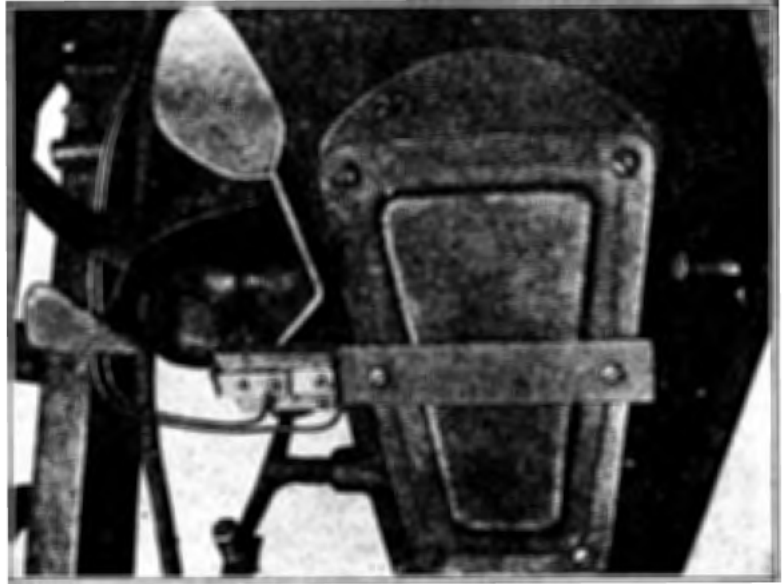

### *Showing the Wesco Switch Installed*

Here is a thoroughly practical need for every Ford.

It is easily installed—a screw driver being the only tool needed and there are no holes to drill. Fits under the floor boards, out of sight and will last indefinitely.

As the foot brake is depressed the stop signal flashes automatically making a safe warning signal that does not require the attention of the driver. For parking a turn of a switch on the dash lights the parking lights independently of Foot Brake Switch.

### Cost Complete \$1.90

The Wesco Auto-Stop-Park-Signal-Switch is supplied complete with wiring and instructions which makes its installation simple and quick for anyone.

**AGENTS AND DEALERS:** Quick sales and no comebacks are being realized wherever this practical device is shown. We have a proposition that you cannot afford to overlook. Send in the coupon today.

**WEST MANUFACTURING COMPANY**  
MONTGOMERY BUILDING. MILWAUKEE, WIS.

**TODAY**

WEST MFG. CO.,  
Montgomery Bldg.,  
Milwaukee, Wis.

Send me..... sample..... prices and dealer's discount.....  
Name .....  
Address .....  
City ..... State.....  
Agent..... Dealer..... Jobber.....

When writing advertisers—Just say FORD OWNER AND DEALER



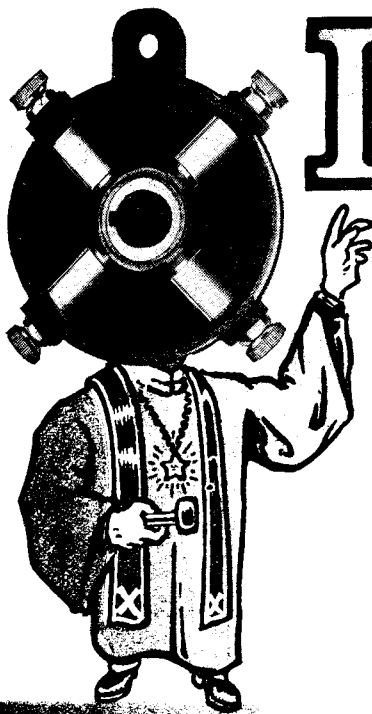

# I am the **DALECO**

By Virtue of the Power Invested in Me  
**I Guarantee** \_\_\_\_\_

To any Ford motor on which I am installed  
**Absolute Freedom**  
**From ALL timer troubles**

By Virtue of Pure Copper Contacts, and an electrical circuit composed entirely of brass and copper, a construction *exclusively Daleco*. I insure an intense white hot spark that causes instant ignition and complete combustion of the gas, resulting in maximum power and economy.

By Virtue of a Positive Wipe Contact, the oil film unavoidable in any timer requiring lubrication is broken on the first turn and easy, quick starting assured regardless of weather or oil in the timer.

By Virtue of a True Circular Rotor, free from humps, bumps or depressions, I insure regular constant ignition and perfect timing of all cylinders.

By Virtue of a Bakelite or Condensite case, (a material used in the highest class electrical apparatus) that is a positive non-conductor of electricity and impervious to oil and water, I eliminate all possibility of short circuits or current leaks.

By Virtue of the elimination of small revolving parts, *I require no oiling*  
Just install me on your motor, then let me alone.

These are some of the outstanding features of the Daleco, the result of correct design, the best material obtainable and thorough workmanship, all backed by a positive Guarantee of perfect timer service at a cost of not in excess of fifty cents per year.

If you can't find me at your Dealers—Write

Manufactured by  
**Dale Manufacturing Co.**

1323 Michigan Ave.  
CHICAGO, ILLINOIS.

Sales Department  
**The Zinke Company**

1317 Michigan Ave.  
CHICAGO, ILLINOIS

# Three Walker Jacks for Fords

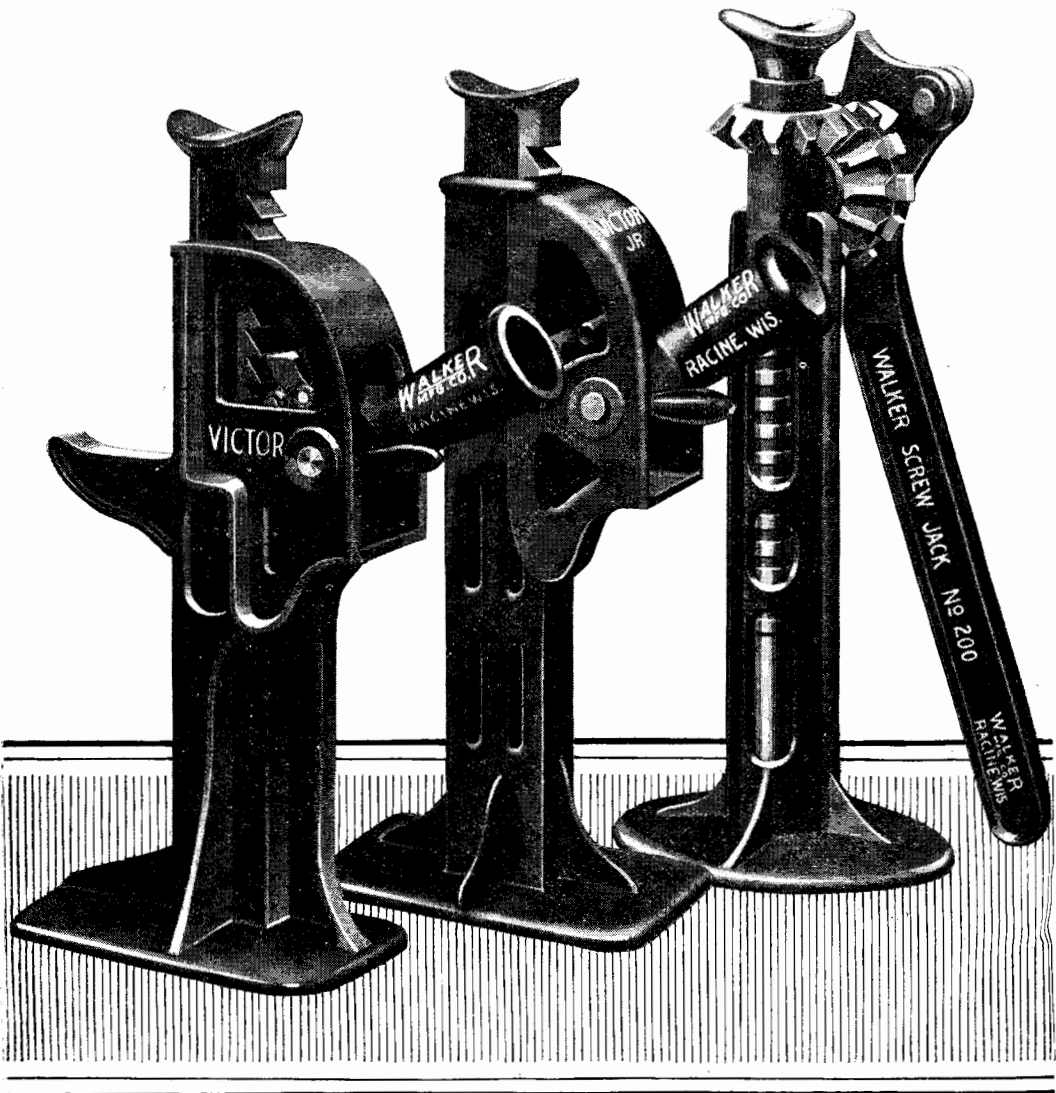

When writing advertisers—Just say FORD OWNER AND DEALER

Some day you are going to be stalled out in the country with a flat tire or a broken spring and a jack that won't work. When this happens you are going to be "out o' luck." Perhaps you have already had this experience with the jack you now own.

***Cheap jacks are not dependable.***

There is only one way to fortify yourself against jack trouble in emergencies; that is, by equipping your car with the best jack you can buy—a **Walker Jack**.

The three models illustrated on the opposite page have been designed and built expressly for Fords. They are accurately machined in jigs and work flawlessly—always. They have a wide, heavy base which keeps them "set" and their unusual leverage makes lifting easy.

Step into your dealer's store—today—and ask for a dependable, easy operating Walker Jack and you'll get the best jack it is possible to buy.

**WALKER MANUFACTURING CO.**

RACINE

DEPT.

WISCONSIN

A large, bold, black serif font logo for "WALKER JACKS". The letters are thick and blocky, with a slightly distressed or textured appearance. The word "WALKER" is on the top line and "JACKS" is on the bottom line. The entire logo is set against a background of fine vertical lines, which is enclosed within a double-line border.

When writing advertisers—Just say FORD OWNER AND DEALER

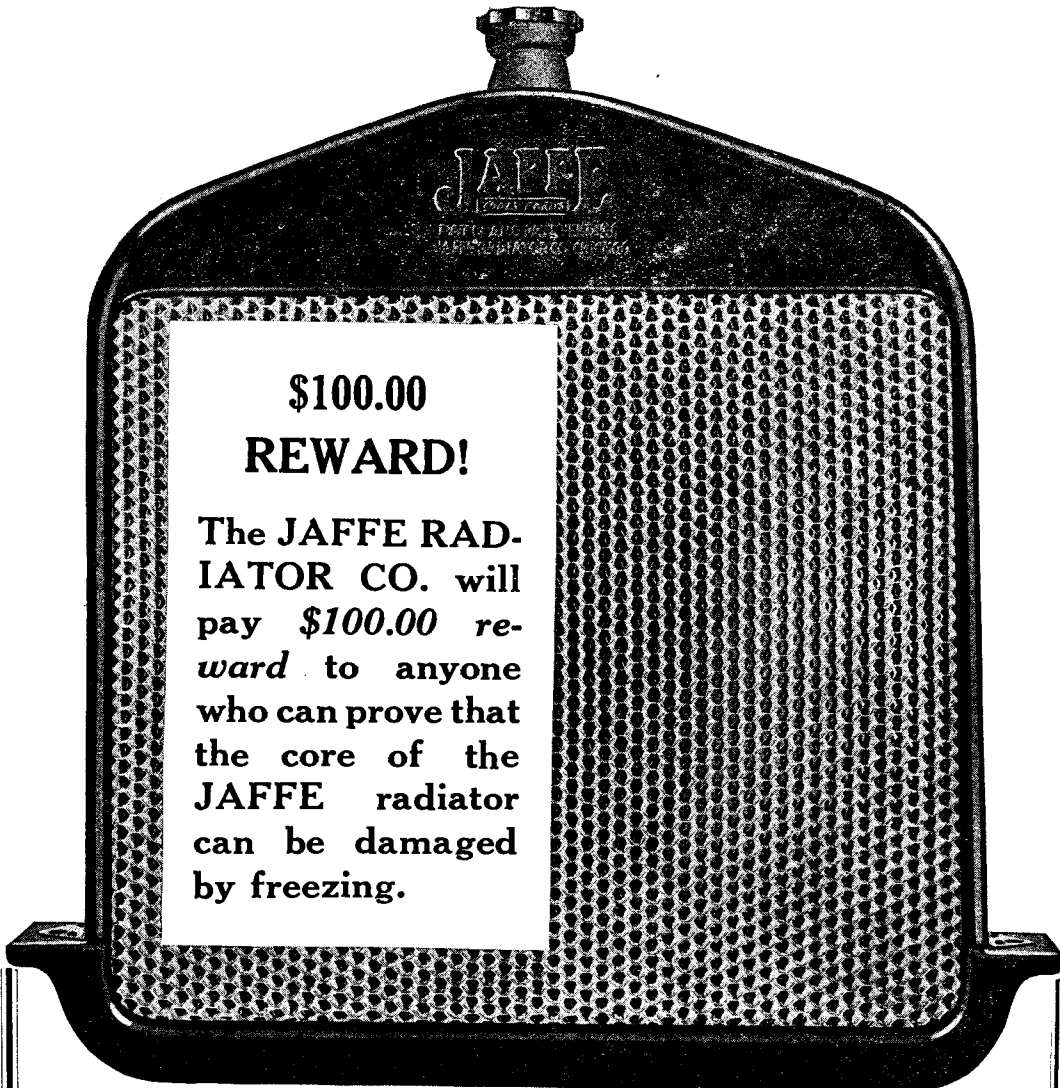

Winter radiator troubles are with us again. Why not definitely eliminate all Ford radiator damage by the use of JAFFE radiators? JAFFE is the only radiator in the world which not only carries an ironclad guarantee against freezing injuries with free replacement in case of such trouble, but also has \$100.00 reward waiting for anyone whose JAFFE core is so damaged.

**DEALERS:**—The JAFFE \$100.00 Reward Guarantee has a wonderful appeal for your customers. It puts in your hands the greatest selling feature ever offered the trade. It means big JAFFE sales for YOU. Are you equipped to take care of the demand? Your jobber can supply you. Write us for your nearest shipping point.

Also if you will just tear out this page and mail it to us, we will gladly forward to you some of our new three-color display signs, imprinted with your own name and address. **THEY WILL BRING YOU BUSINESS.**

JAFFE—"The Nationally Advertised Radiator With the \$100.00 Reward."

## JAFFE RADIATOR CO.

741 W. Van Buren Street, CHICAGO, ILLINOIS

## It Brings You The Business

**T**HERE'S always plenty of business for the garage equipped with a ROMORT AIR AND WATER STATION. Why? Because the ROMORT attracts an endless chain of motorists, brings them right up to your doorway and renders the kind of service that makes them glad to reciprocate by giving you their business.

Car owners actually go out of their way to use ROMORT SERVICE. They appreciate its cleanliness and efficiency—the suspended air hose that never dangles in the mud and dirt to soil the hands and clothing when used—the ease with which it reaches all four wheels without moving the car—the patented governor that automatically returns the hose arm to a vertical position after using and eliminates the bother of putting the hose away—the convenient water hose with the hand grip valve that does away with carrying the clumsy old water bucket.

Like a "Live Wire" salesman the value of the ROMORT increases with age bringing you new customers and increasing the business of the old.

Every day you are without it means you are losing the trade of both.

### HOW LONG CAN YOU AFFORD TO LOSE?

To meet all requirements the ROMORT is built in five styles with and without electric light globes including types for indoor ceiling and outdoor wall installation.

A postal address to our sales department will bring full details by return mail.

### "Beat Your Competitor to It"

Manufactured by

**Romort Mfg. Co.**

OAKFIELD, WIS.

Sales Department

**The Zinke Co.**

1323 Michigan Ave.  
CHICAGO, ILLINOIS

**ROMORT**  
AIR AND WATER  
STATION

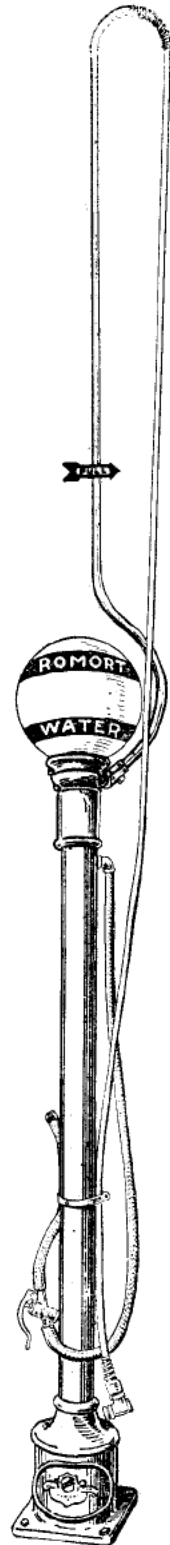

When writing advertisers—Just say FORD OWNER AND DEALER

# FORD DEALERS

*Here's a Display That Will Grip Every Ford Owner*

SET UP THIS DISPLAY STAND IN YOUR FRONT WINDOW OR IN YOUR SHOW ROOM WHERE CUSTOMERS CAN SPIN THE WHEEL, SHOWING HOW THE

*Hugro*

Perfection

Ford

Steering

Wheel

and Lock

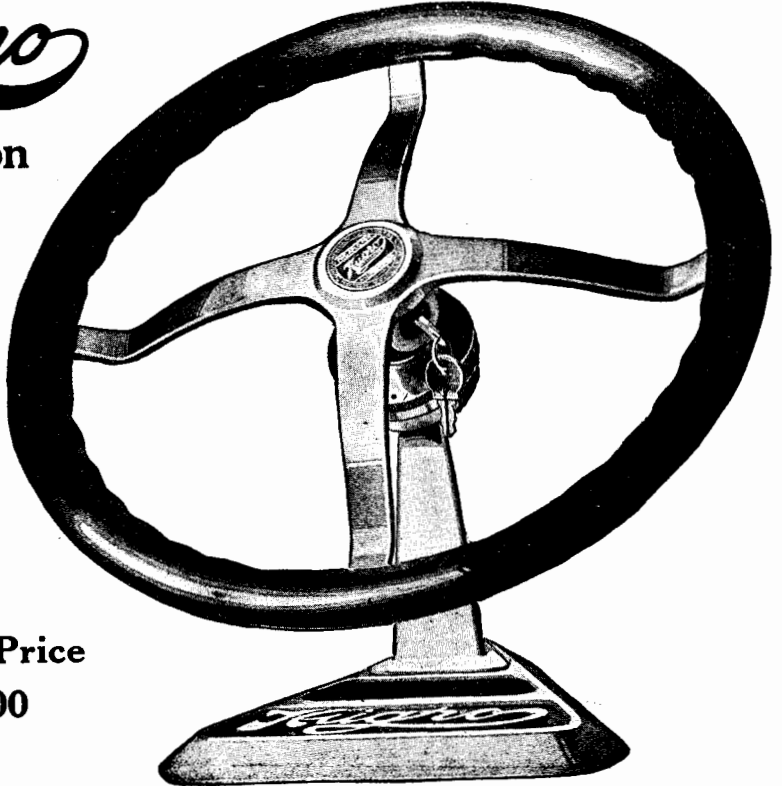

Retail Price  
\$15.00

**MAKES STEERING IMPOSSIBLE WHEN THE KEY IS TURNED.**

Display stand is polished aluminum—very attractive—harmonizing with the polished aluminum spokes of the wheel and contrasting with the rich brown of the Solid Walnut Rim.

This display makes it easy to demonstrate the Hugro Lock and to convince everybody that no other Ford lock approaches it for effective protection against thieves and joy riders.

**Authorized Ford Dealers**

Send for Descriptive Literature and Prices

*Hugro*  
MFG. CO.

General Offices and Factory  
WARSAW, IND.

**\$5 MORE POWER  
MORE SPEED  
NO CARBON \$5**

**THE SIMPLEX HOT PLATE DOES IT**

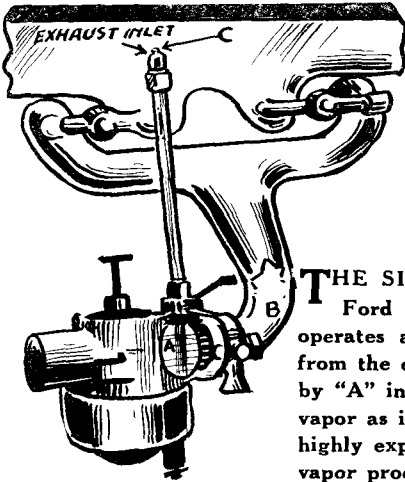

**N**O FORD OWNER can afford to be without this wonderful gasoline saving device which increases the power and mileage of any Ford from 35% to 50%. Thousands of delighted users testify that the Simplex Hot Plate gives them **MORE POWER, MORE SPEED, MORE MILEAGE** and also eliminates practically all **CARBON, VIBRATION and OVERHEATING**. It makes starting easy and permits throttling the engine down to 3 miles an hour on high.

**T**HE SIMPLEX HOT PLATE is easily attached to the Ford motor between the carburetor and the manifold, operates automatically and will last a lifetime. The heat from the exhaust instantly vaporizes the gasoline (as shown by "A" in the illustration) and transforms it into dry, hot vapor as it passes through the manifold (figure "B"). This highly explosive vapor is twice as powerful as the ordinary vapor produced without the Simplex Hot Plate.

**OUR MONEY-BACK GUARANTEE**

**E**VERY SIMPLEX HOT PLATE is sold under our positive guarantee of satisfaction or your money back. You take no chances and we know you will be so pleased with it that you wouldn't take \$25 for it if you couldn't get another.

**S**IGN the coupon below, enclose \$5 (check, draft or money order) and we will send you the Simplex Hot Plate at once. Use it 10 days and if it does not do all that we say it will, simply return it and we will give you your money back.

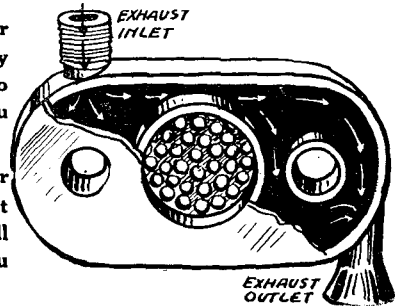

**MAIL THE COUPON NOW**

**COUPON FOR DEALERS**

**SIMPLEX HOT PLATE CO.,**

66 E. Broad St., Columbus, O.

Send me full details of dealer's proposition and sample Simplex Hot Plate. Enclosed find \$5.

Name .....

Street .....

City and State.....

**COUPON FOR FORD OWNERS**

**SIMPLEX HOT PLATE CO.,**

66 E. Broad St., Columbus, O.

Enclosed find \$5. Send me a Simplex Hot Plate at once. If not satisfactory I will return it and you are to send my money back.

Name .....

Street or R. F. D.....

City and State.....

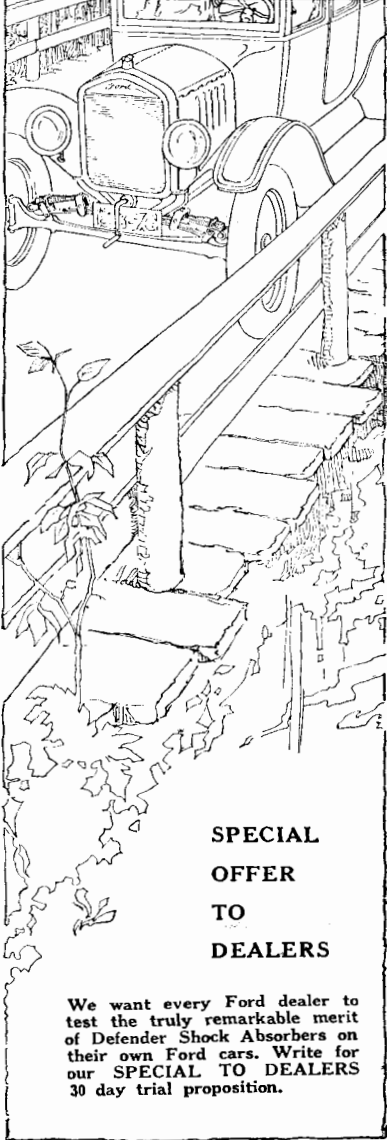
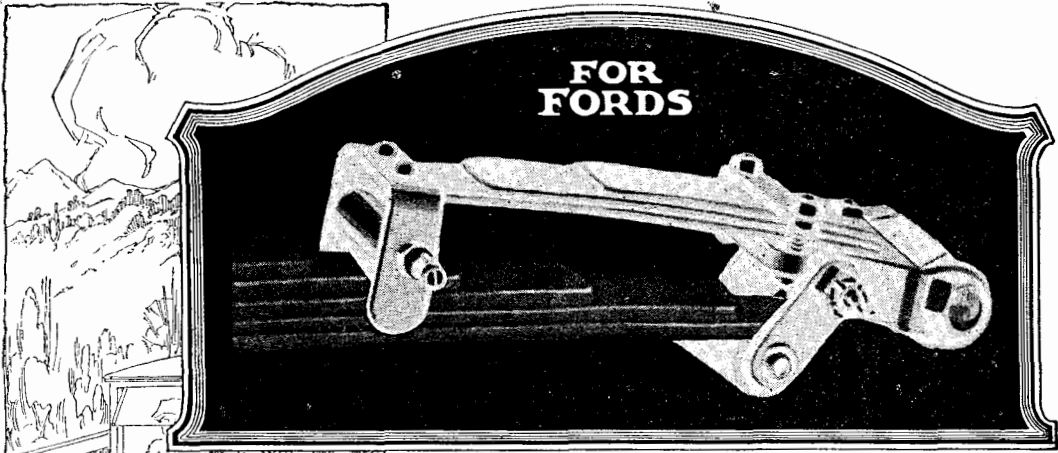

**"Defenders" are more than Shock Absorbers for they not only completely smother road shocks, jolts and jars but snub all rebounding action and eliminate dangerous side-sway.**

*For Your Own Comfort and Safety  
Try "Defenders" at Our Risk*

At our entire risk we want to prove to you that Defender Shock Absorbers will make your sturdy Ford hold the road as easily as the big, heavy expensive cars. That they will protect your car from road impacts, strains and destructive vibration. That they will decrease operating expense, lessen repair bills, prevent spring breakage and greatly increase the mechanical life of your Ford. "Defenders" will positively make a remarkable improvement in the steering control of your Ford, relieve your nerves and make Ford driving easy, comfortable and safe over the roughest roads.

*To demonstrate those facts, your dealer is authorized to install a set of Defender Shock Absorbers on your Ford under a written "Money Back in Ten Days, If You'll Take It, Trial Test Guarantee."*

Ask Your Dealer or, Write Us Direct

**DEFENDER AUTO-LOCK CO.**

ALLEGAN, MICHIGAN

*Pioneers in the Ford Lock Field and Makers of the New Defender Thief-Proof Steering Wheel Lock for Fords*

**SPECIAL  
OFFER  
TO  
DEALERS**

We want every Ford dealer to test the truly remarkable merit of Defender Shock Absorbers on their own Ford cars. Write for our SPECIAL TO DEALERS 30 day trial proposition.

**DEFENDER  
SHOCK  
ABSORBERS**



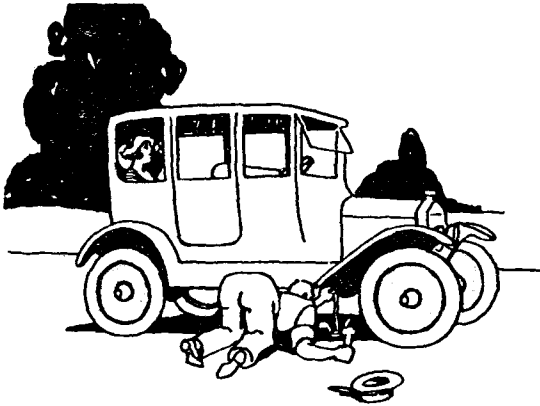

## WHAT IS THE MAN DOING?

Is the man comfortable, cool and clean ?

Is it good for his clothes and temper to do like that ?

Then why does he do it ?

Is there any other way he can see if there is enough oil ?

# OIL TEST **FOUR-D** FINGER WRENCH

What does that do ?

And he does not have to crawl in the  
dirty road ?

Is it expensive ?

Where can he get it ?

Does the dealer make a profit ?

How much profit does the dealer make ?

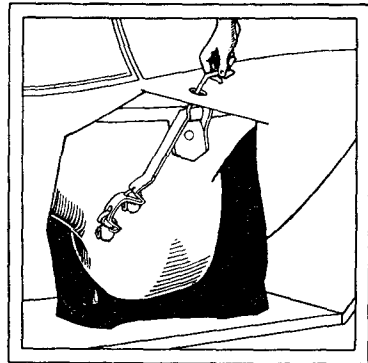

# WE HAVE SOLVED THE PROBLEM!

Gasoline Utilized in Your Engine to the Last Drop

## *The Breeze Visible Fuel Converter*

*For Ford Cars*

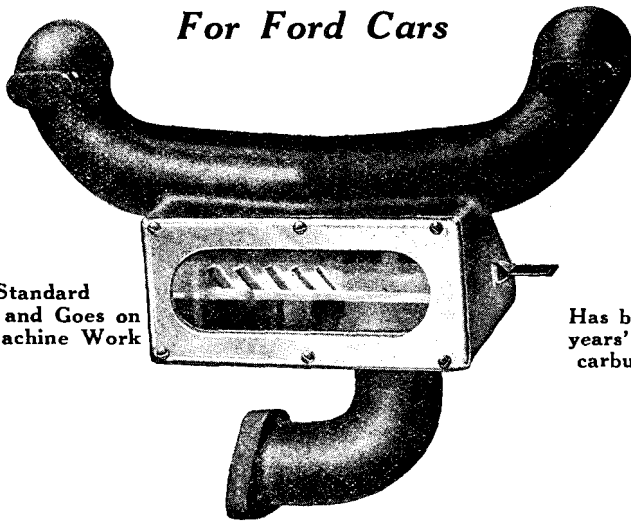

Uses Standard  
Carburetor and Goes on  
Without Machine Work

See It Operate  
Through Window

Has been given three  
years' test by a noted  
carburetion expert.

### **This Is What It Accomplishes**

Gives all the advantages of Hot Spot and Hot Jacketed Manifolds without heating the mixture.

Gives large increase in mileage and stops crank case dilution.

Stops Spark Plugs From Fouling and Reduces Carbon.

Runs a hot mixture for idling and a cool mixture under load.

***We Want Live Men to Make Personal Sales and  
Business Men to Handle Territories***

***Would You Like the Agency in Your Locality?***

The man who makes the money is the one who has one on his car and shows it. It sells itself. We find that to show the device to a man is to sell it. He sees the operation thru the window and his common sense shows him its advantages... Those who use it always help sell to their friends.

Retails for \$15.00 and Saves Its Cost on the First \$30.00 Worth of Fuel and Several Times a Year in Engine Repairs.

Write us today for our excellent proposition. If there is no dealer in your locality we will sell the first one at Dealer's Price.

**DETROIT PARTS MFG. CO.**

2699 GUOIN STREET

DETROIT, MICH.

## Marathon "O K" Electric Grinder and Buffer

# \$25.00

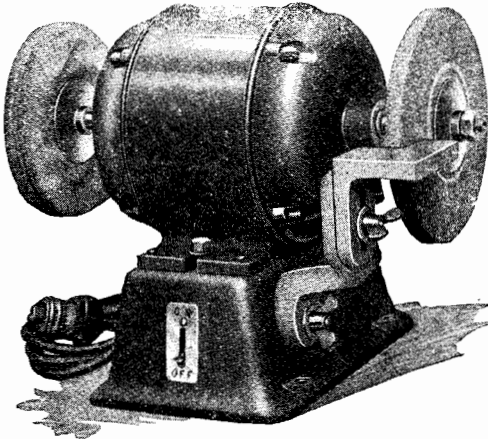

### Complete With Motor

A wonderfully handy tool for every garage or home workshop.

Has 6 inch carborundum wheel on one end of spindle, and 6 inch buffer on the other.

Use it for sharpening tools and miscellaneous grinding work. Buffer is fine for polishing nicked, silver and brass parts.

Driven by  $\frac{1}{4}$  h.p. Marathon OK single phase alternating current motor. Speed 1740 rpm.

**DEALERS:**—Install one or more in your own workshop and offer them for sale to car owners at \$45.00 to \$50.00. A low price for an outfit of this size and capacity.

Send cash with order or have outfits shipped C. O. D. Price \$25.00 f. o. b. Wausau.

**Marathon Electric Manufacturing Company**  
WAUSAU, WISCONSIN.

## PRESTO RIM TOOL

Standard \$4.50  
Special \$6.00

### BOTH PROFITABLE

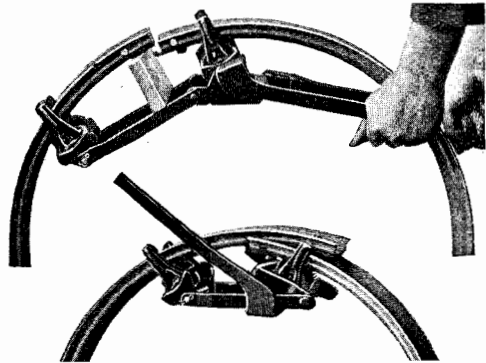

The tool in the upper cut is breaking the joint of a stiff rim; the lower cut shows the rim contracted.

The \$6.00 price is made necessary by the hardening and more rugged design of the tool to fit it for long hard service in your shop. The lower-priced tool is for the customer's infrequent use on the road. You can attach or detach Presto in ten seconds. You can put a ton pressure on a rim with Presto. It folds to  $2\frac{1}{2} \times 7 \times 8$  inches. Fits tool box or kit. No adjustment needed. Order from your regular jobber.

Manufactured by SHELBY TOOL CO., Shelby, Michigan.

DISTRIBUTORS

**STANDARD MOTOR PARTS COMPANY**

1402 S. Michigan Avenue

CHICAGO, ILL.



## To Sell Parts -- Display Them!

**I**S YOUR FORD PARTS Business only a side line? You can make it a leader! Turn your stockroom into a showroom, and apply modern show window methods of merchandising to your Parts business, by using Lupton Auto Parts Storage.

It has a numbered bin for every part—Rear Axle parts first, then Front Axle and Wheels, Frames, then Motor parts, and so on through the car. Nothing is hidden, nothing is mislaid, no excess stock is carried. Lupton Parts says "Quick Service" as plainly as words.

Made of STEEL in sizes for stocks up to \$50,000. Units are 3x7x1 ft. Shipped COMPLETELY ASSEMBLED—no erection cost. Fit any stockroom. Shelves and bins are ADJUSTABLE.

Prices are moderate. In most cases Lupton Auto Parts Storage pays for itself in less than a year in time saved and business gained.

Sold by leading jobbers. Immediate deliveries from stock. Write your name and address on margin, stating size of stock intended and mail to nearest Lupton office for full information. Mention Fordson stock separately.

### DAVID LUPTON'S SONS COMPANY

Allegheny Ave. and Tulip St.  
CHICAGO—1114 Steger Building.  
CLEVELAND—806 Sweetland Building.

PHILADELPHIA  
DETROIT—935 Majestic Building.  
NEW YORK—50 Church Street.

**Lupton**  
PARTS STORAGE INVESTMENT VALUE FOR FORDS

When writing advertisers—Just say FORD OWNER AND DEALER

# ATWATER KENT

## IGNITION OUTFIT FOR FORDS

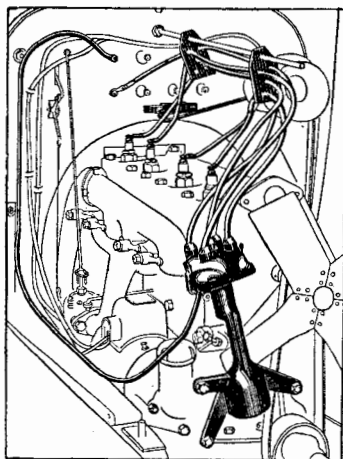

Equipped with electric starting and lighting, 1919 and later models

**A**TWATER KENT ignition outfits for Ford cars are special only in that they are provided with all necessary fittings for mounting and installation. Otherwise they are of the same high quality that distinguishes all Atwater Kent equipment.

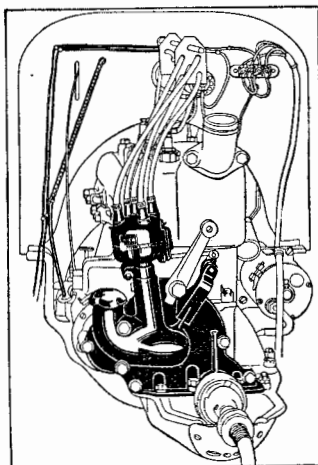

**Non-Automatic Advance (Type CC) \$16<sup>00</sup>**

### SPECIAL ADVANTAGES TYPE CC

Makes use of present coil box and coils—the vibrators are cut by screwing down the adjusting screws.

Gives you 3 spare coils for emergency use.

These modern scientific ignition equipments are easily and quickly applied to any Ford. Complete instructions, wiring and fittings furnished with each outfit.

**Automatic Advance (Type CA) \$24<sup>00</sup>**

### SPECIAL ADVANTAGES TYPE CA

An Atwater Kent heavy duty coil takes the place of the vibrator coils and coil box.

The Automatic Spark Advance produces maximum power at any speed without knocking—unnecessary to constantly shift spark lever while driving. Increases gas economy because spark is automatically timed right for maximum power at any speed.

System mounted on special cover plate which takes the place of the regular Ford cover plate—enclosing the hardened steel special gears, guaranteeing lubrication and quiet operation.

### GENERAL ADVANTAGES OF ATWATER KENT IGNITION on the FORD

- 1—Eliminates inefficient, hard-to-get-at commutator by using same high-grade ignition instrument that is standard equipment on twenty-five of America's best cars.
- 2—Eliminates fussy, buzzy, hard-to-adjust vibrators.
- 3—Gives you a single hot dynamic spark per cylinder.
- 4—Hot spark makes starting easy, and prolongs life of battery.
- 5—Spark, perfectly synchronized, enables you to throttle down and run slower in high gear.
- 6—Smooth, rapid acceleration without knocking. (This is greatly increased when the Type CA automatic advance outfit is used.)
- 7—Utilizes present low-grade fuel to greater advantage, increasing mileage.
- 8—Only one contact point and two moving parts in entire system.

ATWATER KENT MFG. COMPANY, Philadelphia, 4937 Stenton Avenue

When writing advertisers—Just say FORD OWNER AND DEALER

5,000 to 10,000 Miles of Wear on Each Side

Roller-Less Rotor

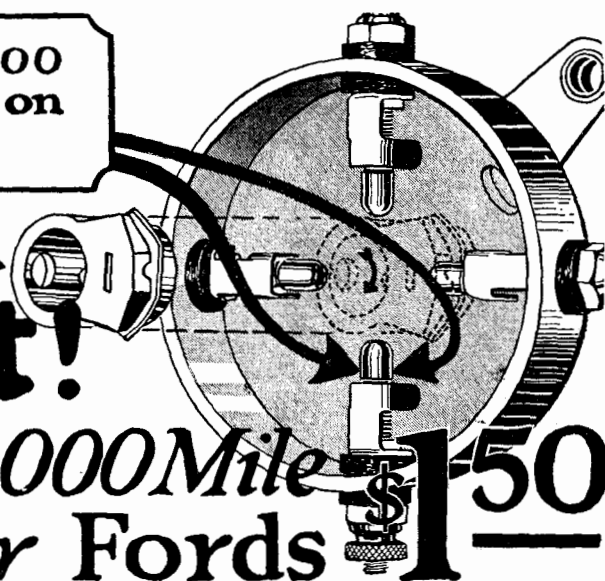

# At Last!

## 10,000 to 20,000 Mile Timer for Fords \$1.50

So constructed that it is super-accurate—mechanically just the reverse of most timers—with no roller and track to wear unevenly and cause faulty timing. Operates on a “wipe” contact principle that insures perfect electrical contact—quicker starting, more power, faster pick-up, easier hill climbing—better timing always.

# Eclipse Oil-Less \$1.50 Double-Life Timer

The 10,000 to 20,000 mile timer for Ford cars, trucks and tractors. The Eclipse performs without oil or grease. Needs no attention whatever. And it's long-lived. Contacts and brush are hardened tool steel, slow to wear—and contacts are also reversible. Each side is good for 5,000 to 10,000 miles—a total of 10,000 to 20,000 miles. And the fifteen thousandth mile of performance is as perfect as the first thousandth, due to a special automatic wear-adjusting feature of the contacts.

### Try an Eclipse Two Weeks at Our Risk

Put it on your car yourself in fifteen minutes with pliers. Immediately you'll notice improved engine performance. If after two weeks of Eclipse timing you're not satisfied it's the greatest timer you've ever known of, your trial hasn't cost you one cent. In ordering,

### Send No Money

The postman will collect your \$1.50 on delivery. Then you try it out for two weeks and if not convinced it's the best, return it and your full \$1.50 will be refunded without quibbling.

Mail the coupon for the best timer, at the lowest cost.

## Eclipse Timer Mfg. Co.

29 Meinecke Avenue, Milwaukee, Wisconsin

**ECLIPSE TIMER MFG. CO.** 29 — Meinecke Avenue Milwaukee, Wisconsin

Gentlemen: Send me an Eclipse Timer in your trial basis. I will pay postman \$1.50 on delivery. I can return it within two weeks and full \$1.50 will be refunded if not satisfactory. It is understood

Name \_\_\_\_\_  
 Address \_\_\_\_\_  
 City \_\_\_\_\_ State \_\_\_\_\_ Dealer's Name \_\_\_\_\_

When writing advertisers—Just say FORD OWNER AND DEALER

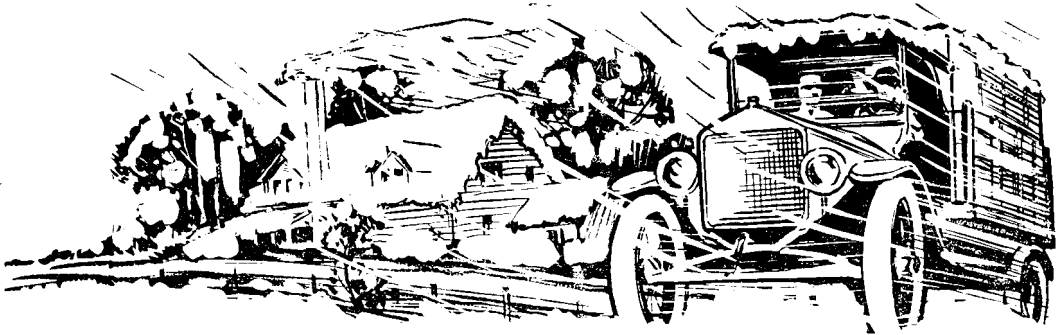

# A Turner Timer

## For a Quick Start in Any Weather

The Turner Two in One Timer is a guaranteed product, time tested and proven, with the stamp of approval from every Ford owner who has used one. It will start the Ford instantly in the coldest weather, an advantage in itself that is more than worth the cost of the device. It stops fouling of two front plugs in most cases, saves gasoline, stops "kicking," is oil, grease and waterproof, requires no oiling and is simply and easily installed. Note the following points of quality construction:

1—Brush container is of cast steel and brass, and will last indefinitely. 2—Contact brush of specially treated phosphor bronze. 3—Contact spring is of high grade piano wire telescoping type. 4—Flexible metal conduit cord packed, which entirely houses all wires. 5—Genuine Bakelite insulated Timing Disc. 6—Timer shell of aluminum. 7—Note the four different lengths of wires, the only wires that you have to connect up. 8—Hardened brass contacts of best quality is used. A machined product throughout.

**TIMER AND WIRE ASSEMBLY COMPLETE \$4.50**

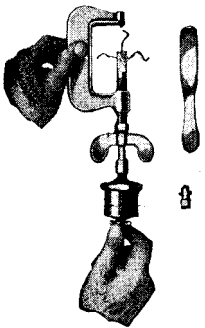
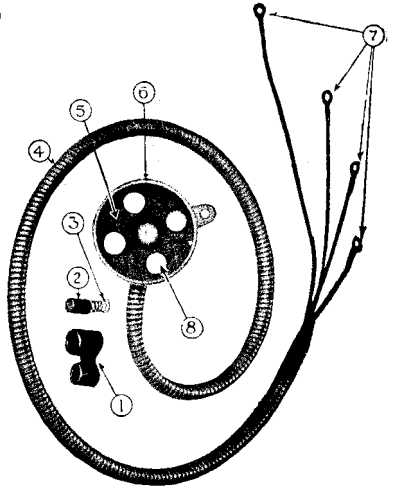

**TURNER SPRING LEAF SPREADER AND LUBRICATOR**—Greatly increases riding qualities of any car, stops squeaks and spring breakage and increases spring wear. Makes steering easier and saves tires. The only device made that spreads spring leaves and lubricates them in one operation without fuss or muss. The grease goes just where it is needed and nowhere else. A product that meets up in every way with the high standard of Turner quality.

**Price \$2.50**

**TURNER LIGHTING WIRE ASSEMBLY**—A boon to every Ford owner. Beautifies the car and protects it from the greatest source of automobile fire loss. All enclosed by flexible metal conduit. Water, grease and oil-proof. Eliminates short circuiting and saves battery. No bare wires to cause expensive road repairs from magneto shortage. The Turner Wiring Assembly for Fords can be installed by anyone in ten minutes.

**For Cars With Starter, \$2.00.**  
**For Cars Without Starter \$1.50.**

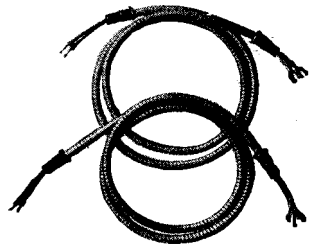

Pat. 8-31-'21

**TURNER MANUFACTURING CO., Kokomo, Ind.**

# TURNER

## MOTOR DEVICES

When writing advertisers—Just say **FORD OWNER AND DEALER**

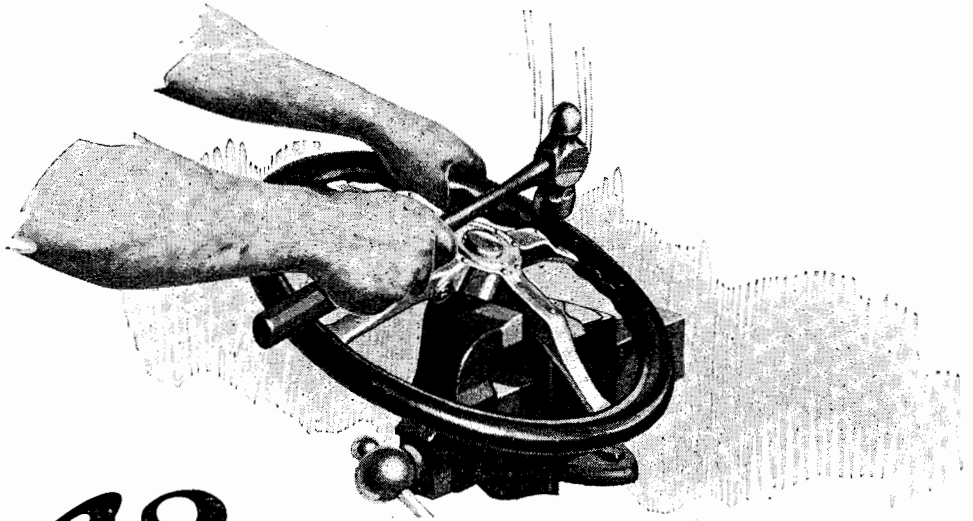

# 42 Hammer Blows Failed to Break its Steel Lining.

## WHY THE LAZEAR!

Locks without key, and can be unlocked only with owner's key. Locking mechanism all made of highest grade hardened steel, accurately machined.

The 17 inch diameter adds greater driving ease and safety by virtue of its increased leverage.

Beautiful finger-grip walnut rim, and neat, highly polished spider add a sense of taste to your Ford.

Approved by Underwriters' Laboratories.

Reduces your insurance cost 15%.

Perfect workmanship and materials throughout.

Installed in a very few minutes.

The biggest value in lock steering wheels on the market.

Here is a lock steering wheel for Fords that is really theft-proof—the Lazear. Its locking mechanism is completely surrounded by a solid lining of hammer-saw-chisel-and-file-proof steel, around which the aluminum spider is die-cast. 42 full, man-sized blows of a heavy hammer failed to break through this impregnable protection.

Left anywhere at any time of day or night and locked with a Lazear your Ford is perfectly safe. It can't be driven, for the Lazear spins freely on the steering post when locked.

Absolute theft protection, driving ease and safety, and beauty are combined in this handsome lock steering wheel.

Nearly 50,000 Fords are stolen annually. Now is the time to take precaution; put on a Lazear.

DEALERS AND JOBBERS—Here's a fast selling accessory with a real profit. It's additional business that is within your reach. Write NOW for prices.

LAZEAR PRODUCTS COMPANY

Dept. 103

557 W. Quincy St. CHICAGO, ILL.

# Lazear

## LOCK STEERING WHEEL FOR FORDS



For smart men with a Ford this is the stupendous money-maker of the decade. \$50.00 a day, \$300.00 a week, \$1300.00 a month, \$7500.00 this season, is conservative. Don't even hesitate. Rush coupon back. Grab this gigantic sensational device and clean up the surrounding territory quick! Even if you don't want the agency, get one anyway for your own car under this SPECIAL OFFER and try it at our expense.

# SENSATIONAL DISCOVERY

## In Water Vapor and Steam Humidifier Effects When Applied to Ford Internal Combustion Gasoline Engines

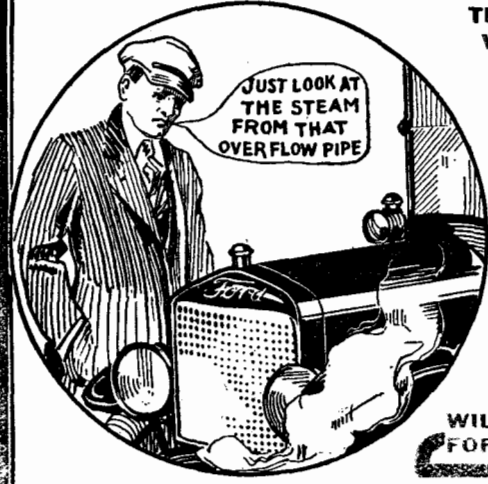

THIS IS WHAT

# VIX

WILL DO FOR YOU

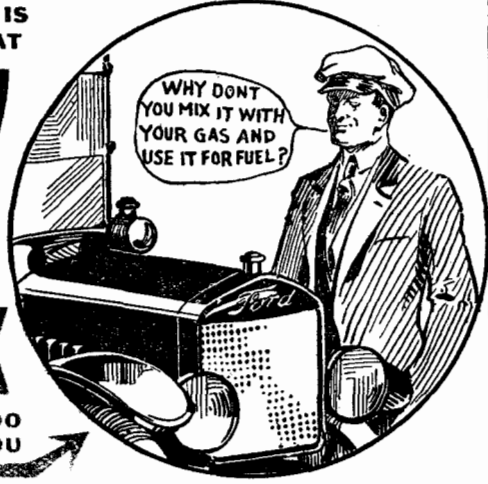

## VIX BURNS WATER IN FORDS

Most Marvelous Discovery of Potential Importance to Ford Owners Since Henry Ford Smashed the Selden Gasoline Engine Licensing Patents

**Tremendous, Sensational Discovery.**  
**Burns Water in Fords.** Separates, mixes and explodes water gases with the gasoline and air; most astounding, unbelievable results; five to fifteen more miles per gallon, absolute prevention of carbon formation; cleans plugs and engine of carbon and keeps them absolutely free from it; motor uses less oil.

**Gives 30 to 40 Miles per Gallon and Often More.** Guaranteed for five years, part replacements free, never wears out; handsome, high grade, splendidly made instrument; adds to the beauty and usefulness of every Ford car; anyone can attach it in about 30 minutes with only a wrench, no holes to bore; nothing to cut; no remodeling necessary. Makes a Ford run like a deer; positively no over-heating; a lot more power; quicker pickup and getaway; more pep and snappiness; rides easy and smooth like a Pullman car, climbs hills like a jack rabbit.

MAKES FORD CARS LOOK SICK AS YOU GO ALONG BY

No competition; nothing else like it; it's a fine investment, not an expense; pays for itself ten times over in money actually saved; agents make from \$7.75 to \$10.75 profit on every sale; \$75 to \$300 per week.

**AGENTS!** Wanted with Ford to sell VIX. Territory is going fast. State what territory you prefer. Rush coupon order below for Big Money chance.

Write Quick for One VIX on 30 Days' FREE TRIAL

CLEAN UP \$2500 TO \$5000 THIS FALL

Get in quick while new and being introduced; every VIX sold on a positive guarantee of absolute satisfaction or money cheerfully refunded; enormous sales in sight in every state and locality.

Manufactured and Sold for Fords by VIX MOTOR ACCESSORIES HOUSE, 716 W. Madison St., Chicago

### DEALERS & GARAGEMEN 30 DAYS' CONSIGNMENT COUPON

SEND NO MONEY FILL OUT AND MAIL THIS TODAY SURE

VIX MOTOR ACCESSORIES HOUSE, 716 W. Madison St., Chicago

Send me VIX Humidifier for Ford car on consignment for 30 days at the dealer's special inside price. I will pay for or return it by insured parcel post within 30 days. I am to pay nothing unless I decide to keep it after examination and trial. You are to pay all delivery charges, you are to pay the War Tax, you are to take all risk. If I return VIX as above you will on receipt and request refund me the return charges and also \$1.00 cash forfeit for my time and trouble. This is to cost me nothing unless delighted after examination and free trial at your expense. 119

Name .....  
Postoffice..... State.....  
R. F. D..... Box..... Street.....  
I am in the..... business  
at.....

### FORD OWNERS 30 DAYS' FREE TRIAL COUPON

SEND NO MONEY FILL THIS OUT AND MAIL TODAY SURE

VIX MOTOR ACCESSORIES HOUSE, 716 W. Madison St., Chicago

Send me VIX Humidifier for Ford car on 30 days' free trial at your expense. Also agents' confidential terms and prices. You are to take all risk. I will pay for VIX or return it by insured parcel post within 30 days. I am to pay nothing unless satisfied after trial. You are to pay all delivery charges to my address, also the War Tax; if I return VIX as above you will on receipt and request refund me the return charges and also \$1.00 cash forfeit for my time and trouble. This is to cost me nothing unless delighted after free trial at your expense. 120

Name .....  
Postoffice..... State.....  
R. F. D..... Box..... Street.....  
My FORD is Model..... Year..... Carburetor.....  
1921 License No..... in State of.....

When writing advertisers—Just say FORD OWNER AND DEALER

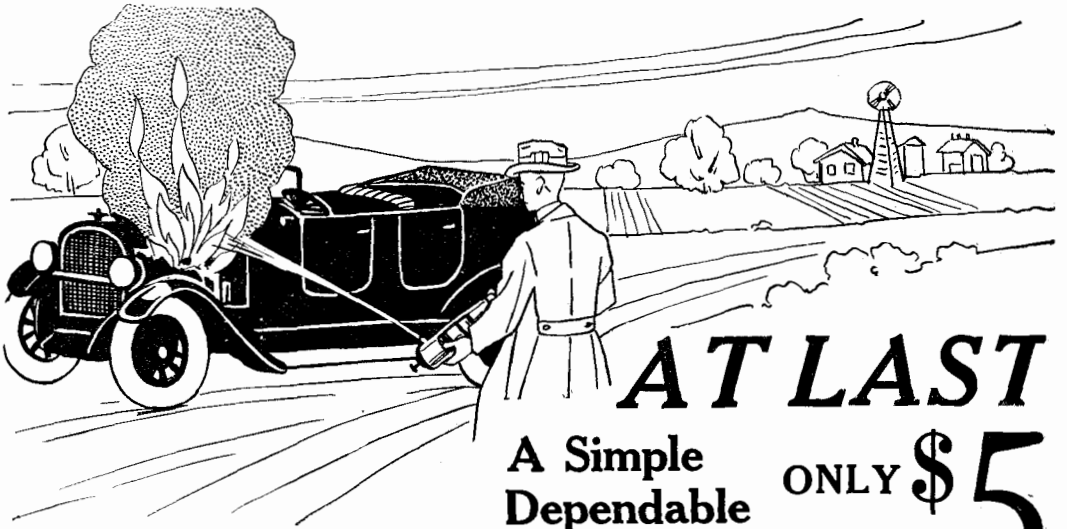

# AT LAST

A Simple Dependable Fire Extinguisher

# ONLY \$5

Don't take chances—you can't afford to gamble with fire. Don't delay until you've lost your garage, your home, your machine. Get this dependable, yet inexpensive protection for your family and your property—TODAY.

The FUGO AUTOMATIC FIRE EXTINGUISHER is the simplest, most efficient, hand fire extinguisher on the market. It does the work of the most expensive fire apparatus—it is constructed of brass throughout—it will last a life-time. You can re-fill it yourself for only 35c—easily and quickly.



## FUGO NEVER FAILS

It Protects Your Home, Garage or Car

The FUGO AUTOMATIC cannot rust, corrode or get out of order—the chemical will not leak or evaporate. Operation is the simplest known—strike plunger once against any hard surface and a continuous stream of the most efficient fire-fighting chemical ever discovered protects you. No pumping—no valves to operate. The chemical will not injure fabrics or woodwork.

Equip your home, your garage, your car with these dependable, inexpensive extinguishers—the most reliable apparatus you can buy at any price. In three finishes—white enamel, brass and nickel—complete with bracket—all ready to put up. Sold with a positive, money-back guarantee.

Price—complete with bracket—postpaid in United States and Canada—only \$5.00

Dealers and Agents—Write for our interesting proposition

### The OHIO INSTRUMENT MFG. CO.

9408 ST. CATHERINE AVE. CLEVELAND, O., U. S. A.



When writing advertisers—Just say FORD OWNER AND DEALER

# MENDALL METAL



## Makes More Clear Dough Than All Your Welding Equipment

Mends Cracked Auto Parts in Place

Quicker Better, More Profitable Than Welding

### Thousands of Repair Shops Now Use Mendall Metal

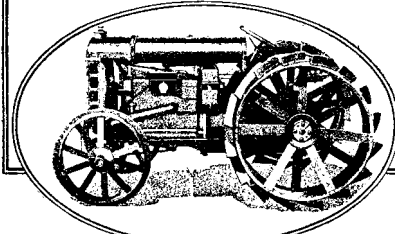

**JONES MOTOR COMPANY**  
 CLAUDE H. JONES  
 PROPRIETOR

**The Fordson TRACTOR**

LEAKSVILLE, N. C.  
 May 16th, 1921.

4A Products Co., Mfrs.,  
Denver, Colorado.

Gentlemen:

Please send us by parcel post one \$5.00 package of Mendall Metal

The other package we received enabled us to save four Fordson cylinder blocks besides a good many small jobs.

Yours very truly,

JONES MOTOR COMPANY

BY: *Claude H Jones*

CJ/GT

NOTE—Sold thru regular trade channels—if your local dealer or jobber cannot supply you, order direct.

**THE 4-A PRODUCTS CO., Mfrs.**  
 31st & Downing Street Denver, Colorado  
 Eastern Office—1416 Broadway  
 New York City

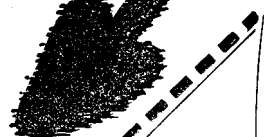

The 4-A Products Co.,  
31st and Downing St.,  
Denver, Colo.

Gentlemen:

I wish to try Mendall Metal in my own shop. Attached to this coupon is my check for \$5, payment in full for one trial package (6 bars) of Mendall Metal, which you are to send me immediately by parcel post, prepaid.

Name.....

Address.....

When writing advertisers—Just say FORD OWNER AND DEALER

# Instant Starting and Smooth

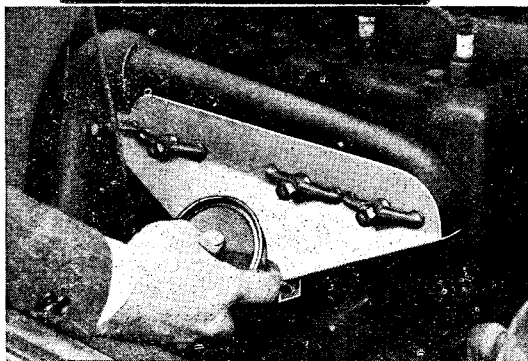

It's easier to fill the heating cup of the Alger than to oil the most accessible part of a Ford.

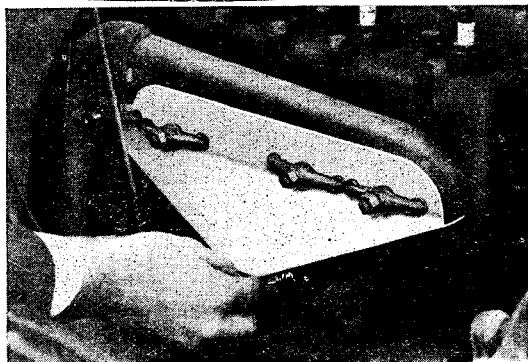

Just pass a lighted match through the cup opening, close the engine hood and Alger does the rest.

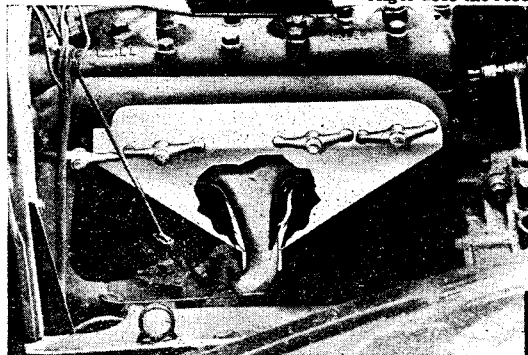

The small charge of fuel in the heating cup produces only a small flame—which clings to the side of the intake manifold and perfectly vaporizes the wet, condensed gasoline inside.

OLD mornings, zero weather and low grade gasoline that even in summer heat is hard to vaporize—no longer need these things make you dread winter driving or sacrifice, for three or four months, the many conveniences that go with a car. There is now a way to avoid engine flooding, jerking, gasoline waste, hard starting and draining of the battery!

What will you do this winter? Let the weather be your master—tell you when you can drive and when you can't?

Absolutely not—that is, providing your Ford is equipped with the simple, practical and most successful ALGER Manifold Heater!

## 500 QUICK STARTS FOR A QUARTER

ALGER provides all the proven advantages of manifold heating, plus the feature of a heating cup into which fuel can be placed, lighted and used for vaporizing the coldest, "wettest" fuel-charge ever fed to an engine.

Simply lift the hood, use a common oil can to reach the hole in the side of the heating cup, fill with about a teaspoon of gasoline or denatured alcohol, touch a match and you're ready. A 30-second job and your motor fires at the first touch of the starter—without choking, flooding, fouling of plugs or waste of gasoline! And, besides, ALGER is economical—using such a small amount of heating fluid that you get 500 quick starts for a quarter.

Send for an ALGER today. Get the manifold heater that is 100% efficient. Built along common-sense principles which recognize that any manifold heater is useless if you cannot first get your engine to start.

# ALGER

When writing advertisers—Just say FORD OWNER AND DEALER.

# Get-Away—in Zero Weather!

**A**LGER gets you started in 30 seconds in the coldest weather—with every cylinder firing and the engine delivering smooth, full-powered efficiency. Then, after the slight charge of fuel in the heating cup is exhausted, the Alger jacket starts functioning:

**VAPORIZES LOW GRADE FUEL THOROUGHLY.** Takes exhaust-manifold heat (formerly wasted) and puts it to work so the engine will not get a raw, liquid-like charge. Shields intake from cold air from the fan.

**REDUCES CARBON.** Resulting mixture explodes instantly and completely, leaving only the barest amount of residue.

**INCREASES MILEAGE.** Each gallon of gasoline goes 2 to 5 miles farther because better vaporization means that the needle valve on your carburetor can be turned down from a quarter to a half-turn.

**PREVENTS FLOODING OF CYLINDERS AND RAPID FOULING OF PLUGS.**

**ELIMINATES ALL JERKING AND "BUCKING," AND THUS REDUCES STRAIN ON THE MECHANISM.** With Alger you get summer-time motor efficiency in zero weather.

## MANIFOLD HEATERS ARE FEATURED ON HIGH-PRICED CARS

Many of the country's foremost engineers—men who have designed some of the most high-priced cars—regard heating of the manifold as a vital factor in the successful operation of their motors. Why should you be satisfied with just fair efficiency and average mileage from your Ford when you can buy—for only \$1.50—a manifold heater that will end your winter driving troubles forever?

You can install Alger yourself in less than 5 minutes. Simply remove clamps that hold the manifolds, slip Alger over the bolts and replace clamps again. Heating cup, which is removed before installation is made, easily slides into place at the lower rear of jacket—occupying a position directly back of lower part of intake.

**FORD OWNERS:**—If your dealer cannot supply you, order direct from this ad. Use Alger for 30 days—see how it puts an end to hard starting, gasoline waste, erky and uneven pulling. If it doesn't meet your expectations simply return it to us C. O. D., adding the cost of postage.

**DEALERS:** Write today for our interesting proposition. Be prepared to meet the demand for Alger Manifold Heaters.

**ALGER MFG. CO.**  
PORT EDWARDS, WIS.

**MANIFOLD  
HEATER for FORDS**  
PATENTS PENDING

## 30 Days' Trial at Our Risk

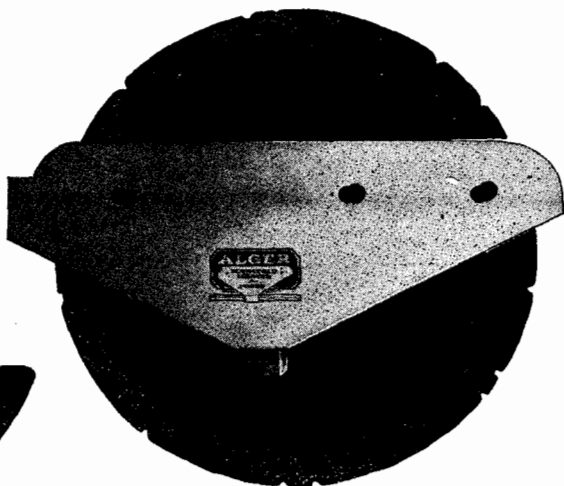

**PRICE \$1.50**  
**COMPLETE**

When writing advertisers—Just say FORD OWNER AND DEALER.

# FOUND:- SATISFACTORY IGNITION

Hundreds of car owners have at last found a Timer which really does end the long list of familiar troubles with coils, vibrator points and other phases of ignition difficulties. They have found complete satisfaction by installing the

## MALLORY Single Unit Timer for Fords

Perfect Timing Action  
Without Attention

### WHAT THE MALLORY DOES

Converts ignition system (without changing the wiring) into one which performs the same as those on the high grade cars.

Allows car owner to screw down vibrating points on all four coils. Acts not only as a timer but also as a high class ignition system.

Provides a normal spark under such conditions as faulty condensers and worn out vibrating points on the coils.

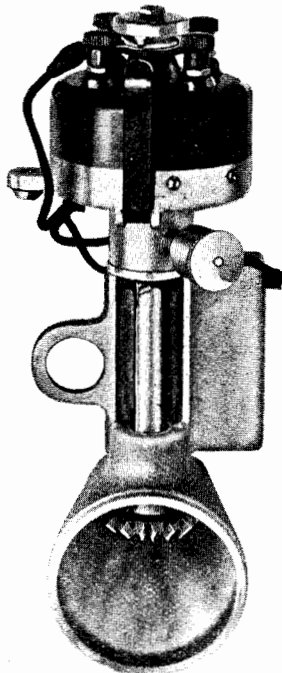

Provides Reliable  
Accurate Ignition

### WHAT THE MALLORY DOES

Enables the driver to run his car as low as three miles an hour in high without slipping clutch and racing motor thus saving gasoline and motor wear.

The Mallory Timer saves its own cost through the elimination of cleaning, adjusting and replacing vibrator points and timers, and by ending timer trouble.

The Mallory ends timer worry. It makes ignition automatically reliable.

Price

**\$14.75**

Patents Pending

The Mallory is the only timer that handles all four coils through one single circuit maker and breaker—that completely eliminates the use of the vibrating points on all four coils—that makes it possible for one condenser to handle all four coils. Shoots a spark with more volume and pressure behind it than any other timer.

DISTRIBUTORS—Ford owners still are seeking ignition perfection. The Mallory fills their needs. Write for proposition.

**Auto Products Co.**

1533-1537 S. Michigan Av.  
CHICAGO, ILL.

Made by  
**MILWAUKEE ENGINEERING  
& TOOL CO.**  
MILWAUKEE, WIS.

**USE THIS**  
AUTO PRODUCTS CO.,  
Chicago, Ill.  
For the enclosed money order—check—for \$14.75 send me one Mallory Timer on special ten day trial. It is understood that if not satisfactory you will refund money.

Name .....

Address .....

City .....

State .....

# Van Atlas

**MAKES THE GOOD OLD FORD A GOOD DEAL BETTER**

## Like a Big-Car Pump—AT A FORD-CAR PRICE

**E**VERYBODY knows that the one big deficiency of the good old Ford engine is the lack of a circulating pump. The water doesn't circulate until at 170° heat. In the winter this means evaporation of anti-freeze solutions; in summer frequent refilling or boiling dry. As a result, there are leaky radiators, excess carbon, faulty lubrication, etc. None of this with a Van

Atlas Pump. Pays for itself in a week's steady driving, and will outlast the car. Built with the same care as the pumps for America's best cars. Easily installed by anyone. A complete guaranteed cooling system that retails for \$10.00. Sold on a 10-Day Trial through the customary trade channels—jobbers and dealers. If they do not supply you, write us.

**No Steaming; No Freezing; More Pep, Pickup and Power.**

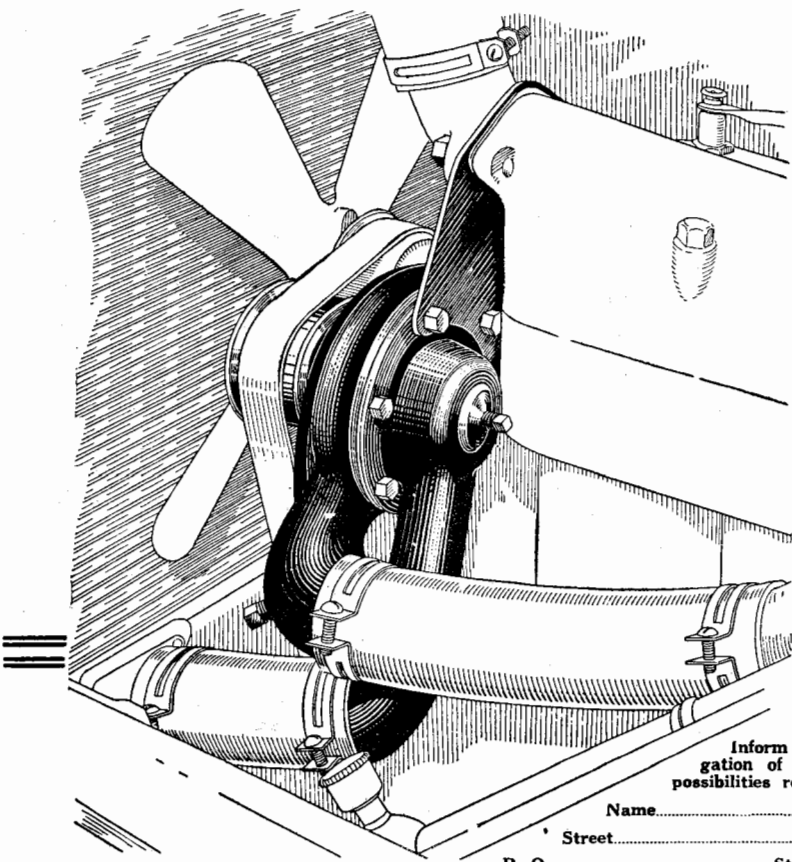

Van Atlas products—this pump and our hydraulic, non-rebound shock absorber, meet a natural demand. They offer **QUICK PROFITS**—the biggest opportunity in the automotive field.

**THOUSANDS  
OF FORDS  
MEAN  
THOUSANDS  
OF SALES**

These accessories will help keep down your "OVERHEAD"

Van Atlas Corporation,  
19 Selden Ave.,  
Detroit, Mich.

Inform me fully and without obligation of the merits, sales helps and possibilities regarding Van Atlas Products.

Name.....

Street.....

P. O. .... State.....

**Write Right-Away—Territory's Going**

When writing advertisers—Just say FORD OWNER AND DEALER

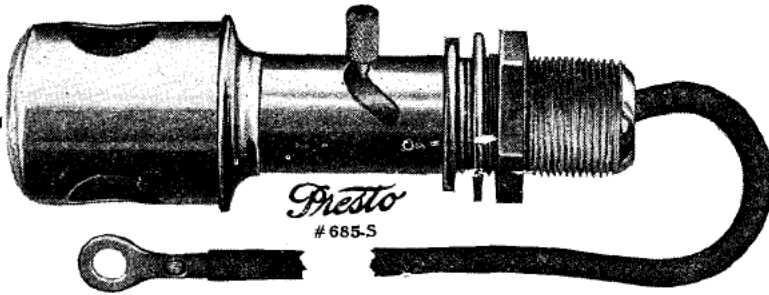

**PRESTO Dash Lamp for Fords \$1.00**

Complete With Bulb, Self-Container, Switch, Cord and Terminal

Beautifully nickel-plated—PRESTO Quality throughout. Notice the *extra long threaded shank*, to fit either metal dash or metal-covered wood dash.

Very easily and quickly attached; no wires to cut or splice. Insist on PRESTO Lamps. Satisfaction guaranteed. If your dealer can't supply you, write us direct, giving his name.

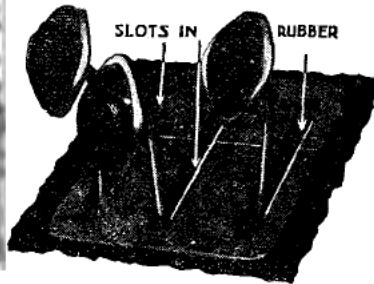

**PRESTO Alweather Foot Protector**

Every Ford owner should have this winter protection. Keeps cold drafts, mud, wet and dampness from entering around foot pedals and emergency brake slot.

Makes a Ford as snug, warm and comfortable as any car on the coldest days and in any kind of weather. Handsome and durable. Easily attached by anyone.

**PRESTO Electric Heater**

A necessity in every unheated garage—a time, trouble and money saver in *any* garage, because it does away with need of other forms of heating.

The Presto Heater is provided with a swivel hook so it may be hung at any point under hood—where heat is required.

Keeps radiator and engine warm in the most severe weather. Prevents freezing of water, hardening of oil and makes starting easy at all times.

Saves its cost many times during the winter. Absolutely safe—no danger of fire.

**DEALERS**—The time to bring these winter specialties to the attention of your customers is now here. Are you ready to increase your winter profits? Write us for full information and our liberal proposition.



**Metal Specialties Mfg. Co.**  
**338-352 North Kedzie Avenue, Chicago, Ill.**





*Cosy Toes*  
and the  
**NIAGARA AUTO  
HEATER**

**Presenting a Real  
Heater Proposition  
to the Dealer**

**D**EALERS, here is a heater that brings quick profits to you and certain car comfort to the car owner.

It is the Niagara Auto Heater, years ahead of any other heater on the market, in improvements, in real heating efficiency.

The Niagara is the one exhaust heater that radiates clean, odorless heat and plenty of it.

No dirt, no carbon, no smells get into the car—The Niagara transmits nothing but heat units.

**RIGHT NOW, TODAY, is the time to  
become a NIAGARA DEALER**

Car owners everywhere are now looking for heaters. Show them the Niagara.

Tell them that it is all aluminum, quick-heating, clean, rustless, compact and good looking enough for any car.

Tell them that a simple shift of a lever brings the heat from the exhaust, instantly, through a flexible metal connection into the patented air-tight heating chambers and thence to the radiating plate or cover. No chance for anything but heat coming through.

Tell them it is easily, cheaply installed. Quickly taken apart and cleaned—and that it makes snug and cozy any open or closed car.

There are dozens of other reasons why you will find the Niagara mighty easy to sell.

Suppose you let us tell you the whole story of this splendid sales opportunity that awaits you.

But don't delay. Write today and say you want to be a Niagara Dealer. Now is the time to sell heaters.

**The Castor Distributing Corporation**

1436 FALLS STREET, NIAGARA FALLS, N. Y.



**Niagara**  
**AUTO-HEATER**

# Bright Spots for the Owner of an **ENSIGN** Equipt Ford

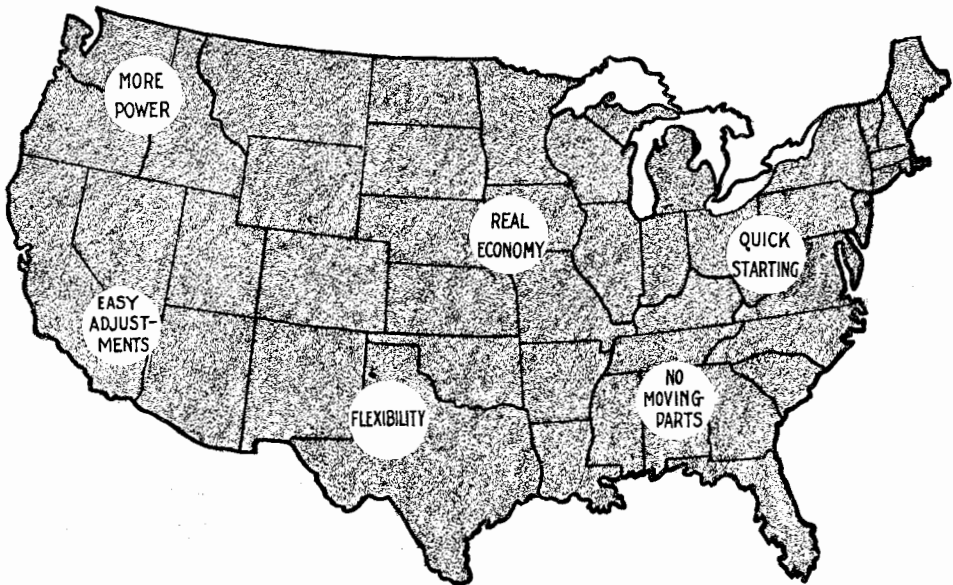

Prove these statements to your own satisfaction. If there is not an **Ensign** Dealer in your territory—we will ship a Type “U” **Ensign** Carburetor with heating equipment, etc., complete, for **\$15.00**. Use it 10 days and if you don’t acknowledge it money well spent say so, and we will refund cheerfully.

## ENSIGN CARBURETOR CO

*Makers of Carburetors for All Internal Combustion Engines*

NEW YORK - - 532 West 58th Street  
 LOS ANGELES - - 217 East 17th Street  
 CHICAGO - - 2900 South Michigan Ave.

# KEYSTONE SIX ADJUSTABLE, PILOT PISTON PIN REAMERS (CRITCHLEY PATTERN)



(Patent Applied for)

These Adjustable, Pilot Reamers are designed for the accurate reaming of two holes in exact alignment in the replacement of Piston Pins in automobile motors.

## The Best Reamer

The experienced mechanic knows that of all styles of Reamers the Straight Fluted type with Staggered Blades and a Starting Pilot is far and away the best tool for all general purposes.

**THE STAGGERED BLADES** eliminate chatter and produce smooth work.

The Straight Flutes give strength, accuracy and long life.

Twelve sizes cover all the sizes of piston pins in the cars, trucks and tractors being manufactured today.

SEND for CATALOG K-6



IN OPERATION

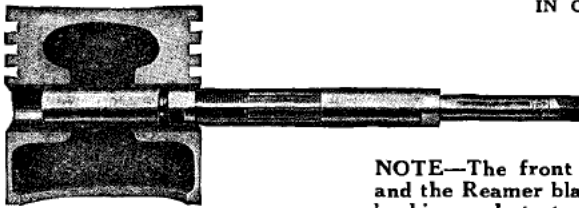

NOTE—The front pilot has entered the far bushing and the Reamer blades are just ready to enter the near bushing and start reaming. The front pilot is starting the Reamer true and in line.

# KEYSTONE REAMER & TOOL CO.

Western Sales Division  
180 N. Market St. Chicago

Eastern Sales Division  
30 Warren St. New York

#### BRANCHES

Atlanta  
Detroit  
St. Louis  
Denver  
Los Angeles  
San Francisco  
Portland

Factory: MILLERSBURG, PA.

When writing advertisers—Just say FORD OWNER AND DEALER

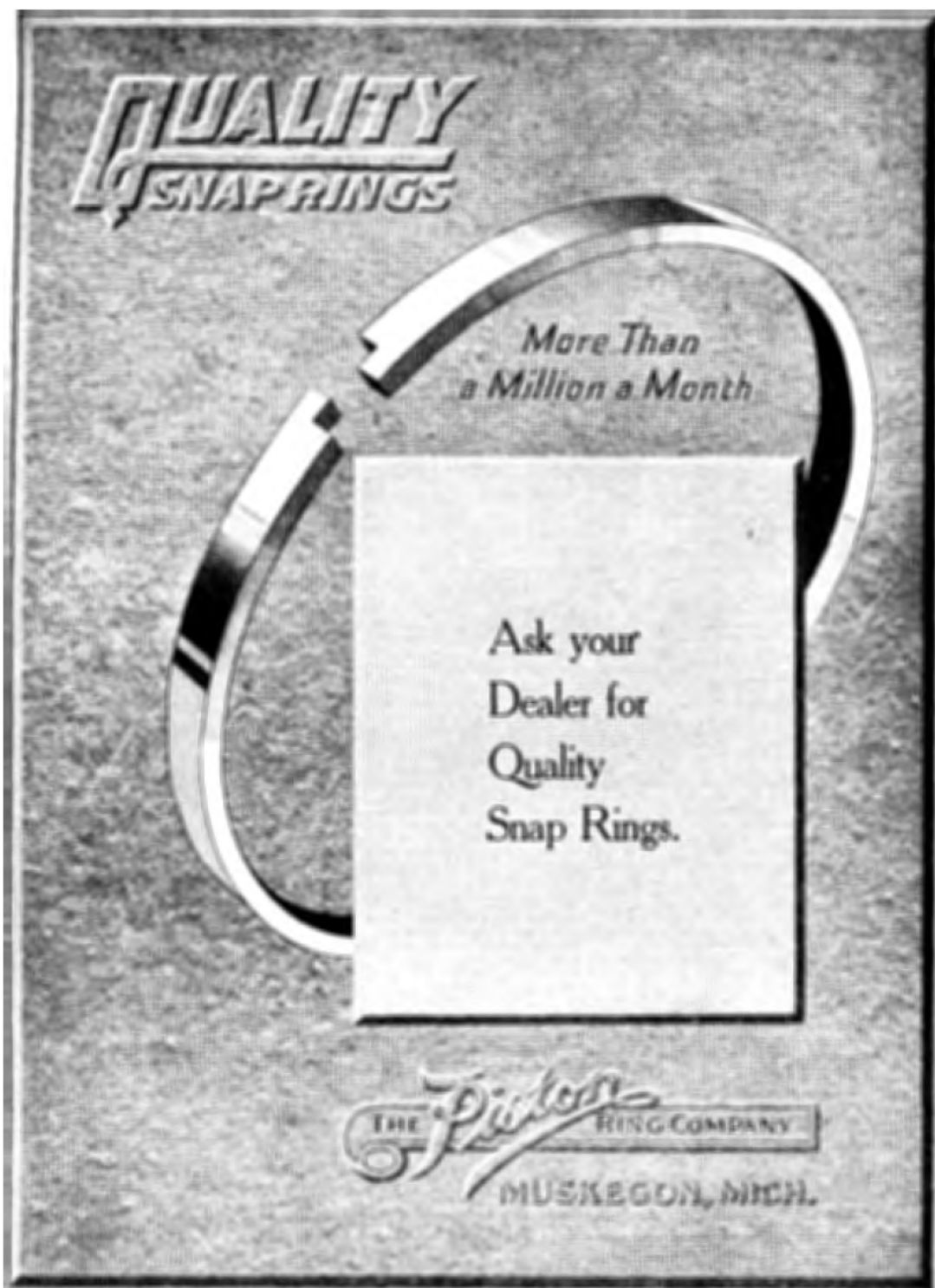

**QUALITY**  
**SNAP RINGS**

*More Than  
a Million a Month*

Ask your  
Dealer for  
Quality  
Snap Rings.

THE *Pistons* RING COMPANY  
MUSKEGON, MICH.

When writing advertisers—Just say FORD OWNER AND DEALER

# C & M OIL RETAINERS

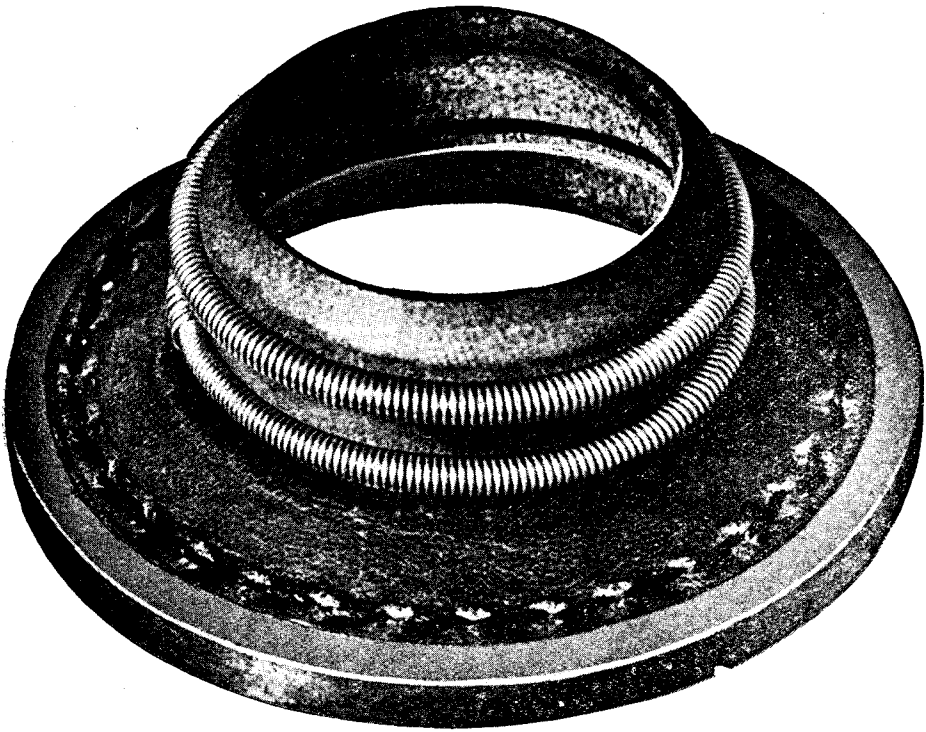

Patented April 1, 1913—Jan. 9, 1917—Jan. 14, 1919  
 "MADE OF LEATHER" THEREFORE LEAK-PROOF"

## OTHER C & M PRODUCTS

C & M TRADE MARK  
 PATENTED

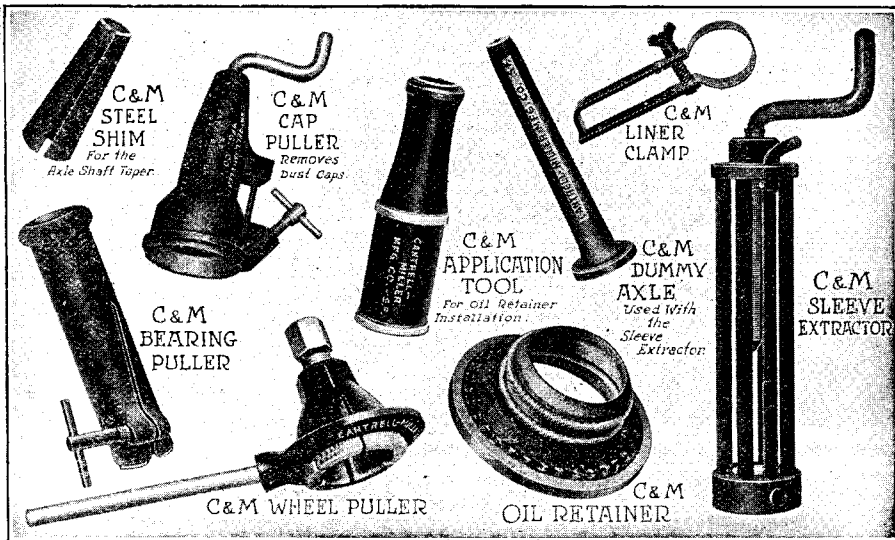

FORD REPAIRMEN AND AGENTS—WRITE TO US OR YOUR JOBBER  
**Cantrell-Miller Manufacturing Co. Inc.,** 1246-1254 Larkin Street  
 San Francisco, Calif.

When writing advertisers—Just say FORD OWNER AND DEALER

# These Firms Have Holley

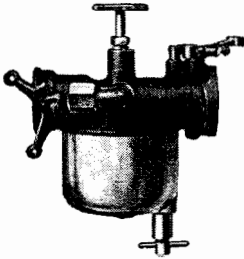

Model N H  
for Fords

The  
Dodge  
Model

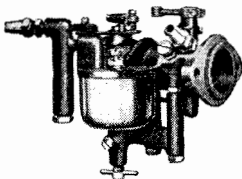

The New

**HOLLEY**  
CARBURETOR

**ALABAMA**

*Birmingham*... Fulenwider Auto Su. Co.  
*Montgomery*... Loeb Hardware Co.

**ARIZONA**

*Phoenix*... Western Auto Supply Co.

**ARKANSAS**

*Fort Smith*... Atkinson Hardware Co.  
*Fort Smith*... Meister Bros., Bracht  
*Little Rock*... Bailey & Co. of Ark.

**CALIFORNIA**

*Fresno*... Western Auto Supply Agy.  
*Los Angeles*... Western Auto Sup. Ag.  
*San Francisco*... Western Auto Sup. Ag.  
*San Jose*... Farnsworth & Callahan

**COLORADO**

*Denver*... Auto Equipment Co.  
*Pueblo*... Arkansas Valley Auto Co.

**CONNECTICUT**

*Hartford*... Alling Rubber Co.  
*Hartford*... L. L. Ensworth & Son  
*Hartford*... Magic Auto Supply Co.  
*Hartford*... Post & Lester Co.  
*New Haven*... C. L. Mersick  
*New Haven*... San Schwartz

**DELAWARE**

*Wilmington*... Automobile Supply Co.  
*Wilmington*... Motor Service, Inc.

**DISTRICT OF COLUMBIA**

*Washington*... Nat. Elec. Supply Co.

**FLORIDA**

*Gainesville*... Baird Hardware Co.  
*Tampa*... D. F. Owen  
*Tampa*... Knight & Wall Co.  
*Tampa*... Tampa Hardware Co.

**GEORGIA**

*Atlanta*... Alexander Seewald  
*Atlanta*... Bailey & Co.  
*Augusta*... Augusta Grocery Co.  
*Dublin*... Brandon Auto Supply Co.  
*Thomasville*... Cooper Auto Supply Co.

**ILLINOIS**

*Aurora*... Auto Supply & Accessories Co.  
*Chicago*... Auto Tire Sales Co.  
*Chicago*... Beckley-Ralston Co.  
*Chicago*... Chicago Auto Equipment Co.  
*Chicago*... Chicago Auto Supply Co.  
*Chicago*... National Auto Supply Co.  
*Chicago*... New England Mills Co.  
*Danville*... E. B. Collins Co.  
*Galesburg*... Mackemer Motor Co.  
*Galesburg*... P. & M. Accessory Co.  
*Joliet*... Barrett Hardware Co.  
*Paris*... A. W. Wolfe  
*Quincy*... Tenk Hardware Co.  
*Sterling*... Hardware Products Co.  
*Washington*... Wash. Auto Supply Co.

**INDIANA**

*Evansville*... Mumford Hardware Co.  
*Evansville*... Orr Iron Company  
*Fort Wayne*... Fort Wayne Iron Store  
*Indianapolis*... W. J. Holliday Co.  
*Lafayette*... Shoe-Bahls Hardware Co.  
*Terre Haute*... John S. Cox  
*Terre Haute*... Loeser & Sons  
*Terre Haute*... T. H. Auto Supply Co.  
*Richmond*... Jones Hardware Co.  
*Wabash*... F. J. Rettig & Co.

**IOWA**

*Cedar Rapids*... Fred J. Barr

**IOWA—Con.**

*Clinton*... Andrew Paysen  
*Creston*... Creston Auto Co.  
*Davenport*... Fred J. Barr  
*Davenport*... Sieg Company  
*Des Moines*... Herring Motor Co.  
*Des Moines*... Hippos-States Co.  
*Dubuque*... Midwest Auto Supply Co.  
*Ottumwa*... Ottumwa Auto Co.  
*Sioux City*... Wm. Warnock  
*Burlington*... Burlington Iron Store

**KANSAS**

*Atchison*... A. J. Harwi Hdwe. Co.  
*Salina*... Lee Hardware Co.

**KENTUCKY**

*Glasgow*... Davidson Brothers  
*Lexington*... L. G. Van Strode  
*Louisville*... Belknap Hdwe. & Mfg. Co.  
*Louisville*... Harbison & Gathright, Inc.  
*Louisville*... Ky. Consumers Oil Co.  
*Paducah*... Foreman Auto Company

**LOUISIANA**

*Alexandria*... Rapides Auto Co.  
*Shreveport*... Cupples-Lonergan Co., Inc.

**MAINE**

*Augusta*... Fifield Bros. Co.  
*Bangor*... Haynes & Chalmers Co.  
*Portland*... W. E. & B. J. Harman

**MARYLAND**

*Baltimore*... American Wholesale Corp.  
*Baltimore*... Balt. Hub Wheel & Mfg. Co.  
*Baltimore*... R. W. Norris & Sons  
*Baltimore*... Piet-Robertson-Rainey  
*Cumberland*... United Accessories Co.

**MASSACHUSETTS**

*Boston*... Decatur & Hopkins  
*Boston*... Joseph E. Greene, Inc.  
*Boston*... S. Simons Hardware Co.  
*Boston*... Malton Specialty Co.  
*Boston*... Bascom's, Inc.  
*Brockton*... Nathan E. Packard  
*Fall River*... Congdon & Carpenter  
*Springfield*... Forer & Forer  
*Springfield*... Imperial Auto Supply Co.

**MICHIGAN**

*Battle Creek*... Boomhower Auto Sy. Co.  
*Detroit*... Automobile Equipment Co.  
*Detroit*... E. A. Bowman, Inc.  
*Escanaba*... Delta Hardware Co.  
*Grand Rapids*... Mich. Tire & Aces Co.  
*Jackson*... Smith-Winchester Co.

**MINNESOTA**

*Albert Lea*... W.K. Supply Co.  
*St. Paul*... Farwell-Ozmun, Kirk Co.  
*St. Paul*... Western Auto Supply Co.  
*Winona*... Winona Automotive Sup. Co.

**MISSISSIPPI**

*Jackson*... Auto Supply Co., Inc.

**MISSOURI**

*Cape Girardeau*... Auto Tire & Parts Co.  
*Kansas City*... Feath Iron Co.  
*Kansas City*... Bonniwell-Calvin Ir. Co.  
*Kansas City*... Harbison Mfg. Co.  
*Kansas City*... Kan. City Auto Sup. Co.  
*Kansas City*... Richards & Conover  
*Kansas City*... Western Auto Sup. Agy.  
*Kirkville*... Central Auto Supply Co.  
*St. Joseph*... Ross-Frazier Iron Co.  
*St. Louis*... Campbell Iron Co.  
*St. Louis*... Simmons Hardware Co.

**Holley Carburetor Co.**

When writing advertisers—Just say FORD OWNER AND DEALER

# Complete Stock of Carburetors

## MISSOURI—Con.

*Sedalia* . . . . . R. J. Hausam Co.  
*Springfield* . . . . . Herman-Sanford Co.  
*Springfield* . . . . . Ozark Motor Supply Co.  
*St. Joseph* . . . . . Robinson Heavy Hdwe. Co.

## MONTANA

*Billings* . . . . . Accessory Sales Co.  
*Helena* . . . . . Helena Hardware Co.

## NEBRASKA

*Omaha* . . . . . Henkle & Joyce Hdwe. Co.  
*Omaha* . . . . . J. & R. Motor Supply Co.  
*Omaha* . . . . . Paxton & Gallagher Co.

## NEW JERSEY

*Long Branch* . . . . . Norwood Tire Co.  
*Newark* . . . . . Newark Auto Specialty Co.  
*Newark* . . . . . Elin Auto Supply Co.

## NEW YORK

*Albany* . . . . . Alling Rubber Co.  
*Brooklyn* . . . . . Bushwick Auto Supply Co.  
*Cato* . . . . . Fay C. Adams  
*Freeport* . . . . . Kessell Auto Supply Co.  
*Jamaica* . . . . . Morris Auto Supply Co.  
*Jamestown* . . . . . Jamestown Hardware Co.  
*Kingston* . . . . . M. H. Herzog  
*Newburgh* . . . . . John G. Wilkinson Co.  
*New York* . . . . . Auto Hdwe. & Equip. Co.  
*New York City* . . . . . Butler Brothers  
*New York City* . . . . . Lehr Auto Supply Co.  
*New York City* . . . . . Lowe Motor Sup. Co.  
*New York City* . . . . . Millers Auto Sup. Co.  
*New York City* . . . . . Sup. Lamp Mfg. Co.  
*New York City* . . . . . Weaver Ebling Au. Co.  
*Rochester* . . . . . Chapin Owen Co.  
*Rochester* . . . . . Thomas J. Northway  
*Rochester* . . . . . W. H. Rowerdink & Sons  
*Syracuse* . . . . . Olmstead Company  
*Syracuse* . . . . . Onondaga Auto Supply Co.  
*White Plains* . . . . . Ernest S. Hessels

## NORTH CAROLINA

*Asheville* . . . . . Brown Hardware Co.  
*Greensboro* . . . . . Greensboro Auto Sup. Co.  
*Greensboro* . . . . . Odell Hardware Co.  
*Charlotte* . . . . . Ko-Mo Supply Co.  
*Raleigh* . . . . . Interstate Mtr. Equip. Co.  
*Rocky Mount* . . . . . Dixie Sales Co.  
*Winston-Salem* . . . . . Brown-Rogers Co.

## OHIO

*Akron* . . . . . Hardware & Supply Co.  
*Ashland* . . . . . Allen Auto Supply Co.  
*Ashland* . . . . . Toppings Fireproof Garage  
*Chillicothe* . . . . . Spetnagel Hardware Co.  
*Cincinnati* . . . . . C. & D. Auto Supply Co.  
*Cincinnati* . . . . . J. J. Bantlin Co.  
*Cincinnati* . . . . . Krause Hardware Co.  
*Cincinnati* . . . . . G. M. Toewater & Co.  
*Greenville* . . . . . York Supply Co.  
*Portsmouth* . . . . . Portsmouth Au. Spy. Co.  
*North Baltimore* . . . . . Hulton & Bosler  
*Springfield* . . . . . H. G. Root Co.  
*Steubenville* . . . . . Steubenville Hdwe. Co.

## OKLAHOMA

*Ardmore* . . . . . Don A. Cochran  
*McAlester* . . . . . Russell Hardware Co.  
*Oklahoma City* . . . . . Sharp Auto Sup. Co.  
*Oklahoma City* . . . . . Richards & Conover  
*Tulsa* . . . . . Tulsa Motor Supply Co.

## PENNSYLVANIA

*Allentown* . . . . . Great Eastern Rubber Co.  
*Allentown* . . . . . F. Hersch Hardware Co.  
*Butler* . . . . . W. E. McClung & Son  
*Harrisburg* . . . . . Square Deal Auto Sup. Co.

## PENNSYLVANIA—Con.

*Hazleton* . . . . . National Auto Supply Co.  
*Johnstown* . . . . . Johnstown Auto Co.  
*Lancaster* . . . . . General Auto Supply Co.  
*New Bethlehem* . . . . . Anderson Hardware  
*Newcastle* . . . . . Elliott & Waddington  
*Philadelphia* . . . . . Automotive Equip. Co.  
*Philadelphia* . . . . . Motor Accessories Co.  
*Philadelphia* . . . . . Simmons Hardware Co.  
*Phila.* . . . . . Supplec-Biddle Hdwe. Co.  
*Pittsburgh* . . . . . Motor Supply Co.  
*Pittsburgh* . . . . . Pittsburgh Auto Eqpt. Co.  
*Pittsburgh* . . . . . Superior Auto Acces. Co.  
*Pittsburgh* . . . . . Union Auto Supply Co.  
*Pottsville* . . . . . Geo. M. Biehl  
*Reading* . . . . . Peoples Auto Supply Co.  
*Scranton* . . . . . American Auto Supply Co.  
*Wilkes-Barre* . . . . . American Auto Sup. Co.

## RHODE ISLAND

*Providence* . . . . . City Hall Hdwe. Co.  
*Providence* . . . . . Economy Auto Supply Co.  
*Providence* . . . . . Franklin Auto Sup. Co.  
*Providence* . . . . . Millers, Inc.  
*Providence* . . . . . Waite Auto Supply Co.

## SOUTH CAROLINA

*Anderson* . . . . . Sullivan Hardware Co.  
*Columbia* . . . . . Carolina Tire & Acces. Co.  
*Florence* . . . . . D. W. Alderman, Jr.  
*Spartanburg* . . . . . Motor Supply Co.

## SOUTH DAKOTA

*Aberdeen* . . . . . Hatfield Motor Supply Co.  
*Sioux Falls* . . . . . L. & L. Motor Supply Co.

## TENNESSEE

*Bristol-Tenn.-Va.* . . . . . Interstate Hdwe. & Sp. Co.  
*Knoxville* . . . . . C. M. McClung  
*Nashville* . . . . . Gray & Dudley

## TEXAS

*Austin* . . . . . W. H. Richardson & Co.  
*Beaumont* . . . . . Geo. H. Leicht  
*Dallas* . . . . . Butler Brothers  
*Dallas* . . . . . Mans Johnsen  
*El Paso* . . . . . Tri-State Accessories Corp.  
*Houston* . . . . . Bering Tire & Repair Co.  
*Houston* . . . . . F. W. Heitmann  
*Waco* . . . . . Archenhold Auto Supply Co.  
*Waco* . . . . . McCauley-Ward Motor Sup. Co.  
*Sherman* . . . . . Hardwicke-Etter Co.

## UTAH

*Salt Lake City* . . . . . Salt Lake Hdwe. Co.

## VERMONT

*Burlington* . . . . . Hagar Hdwe. & Paint Co.

## VIRGINIA

*Bristol* . . . . . Mitchell-Powers Hdwe. Co.  
*Norfolk* . . . . . Wm. H. Grover  
*Norfolk* . . . . . W. M. Whaley & Co.  
*Petersburg* . . . . . C. Leonard Hdwe. Co., Inc.  
*Richmond* . . . . . Benton Bailey  
*Richmond* . . . . . Cottrell Saddlery Co.  
*Richmond* . . . . . W. C. Quarles Co.  
*Richmond* . . . . . Richmond Hdwe. Co.  
*Richmond* . . . . . Roanoke Hdwe. Co.  
*Richmond* . . . . . Virginia-Caro. Hdwe. Co.  
*Roanoke* . . . . . Meadows-Price Co.

## WEST VIRGINIA

*Huntington* . . . . . Van Zandt Leftwich Co.  
*Hun'on* . . . . . Emmons-Hawkins Hdwe. Co.  
*Wheeling* . . . . . T. T. Hutchisson & Co.  
*Wheeling* . . . . . Earle Rogers

## WASHINGTON

*Seattle* . . . . . Western Auto Supply Co.

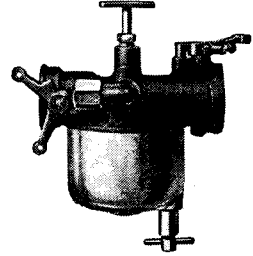

Model N H  
for Fords

## Model for

Chervolet 4-90  
 Reo Speed Wagon  
 Reo the Fifth  
 Hupmobile  
 Maxwell

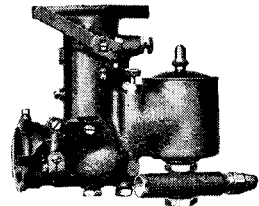

The New  
**HOLLEY**  
CARBURETOR

**Detroit, Michigan**

# \$50.00

## additional profit on every Ford you sell

for  
Ford  
Dealers

We have a special plan by which Ford Dealers are **ADDING** at least \$50 to their profits on every Ford car sold, by delivering it equipped with House Wire Wheels at a price that is very attractive to the car buyer.

Ford dealers in all sections of the country are meeting with wonderful success by following this plan. They not only make \$50 **EXTRA** profit on every Ford sold without incurring any additional selling expense, but—by reason of public interest in Wire Wheel equipment and the particularly attractive figure at which the wheels are supplied—the plan is proving exceptionally effective as a factor in **OVERCOMING** sales resistance.

With other Ford Dealers making an **EXTRA** \$50 on every Ford that they sell, can you afford not to look into this opportunity? Write today for particulars.

---

**WIRE WHEEL CORPORATION of AMERICA**

(Successors to Houk Manufacturing Company)

1700 Elmwood Avenue

Buffalo, N. Y.

# WIRE WHEELS

Five Wheels, triple spoke, detachable at hub



# DOWMETAL

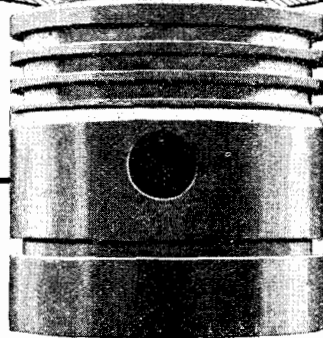

*Lightest  
Weight  
Pistons*

*For Ford  
and Dodge  
Motor Cars*

## THE NEW WONDER PISTONS WILL LIVEN UP YOUR SALESROOM

Times of lagging sales require attention attractors.

Novelty alone will not do the work. You need novelty and romance—plus merit.

Dowmetal Pistons provide just the right combination.

For the Dowmetal Piston is the Automotive Romance of the day.

The metal is a new scientific achievement, manufactured from natural brine pumped from Dow wells. It is made from the same brine out of which the Dow Chemical Company derives elements for the manufacture of chloroform, industrial solvents, dyes, bromides—eighty products of the chemists ingenuity.

Dowmetal has non-scoring properties so unusual that we confidently make the claim—"never scored a cylinder."

Dowmetal has strength and toughness so notable that block tests, championship races and rough track punishment alike fail to show a weakness, yet even aluminum piston alloys are 65% heavier.

Its lightness saves power now wasted in raising and lowering tons of excess weight for every driving hour.

And every ounce of power saved gets right to the connecting rods without waste. It multiplies usable power on hills or in hard driving, it develops astonishing speed—it lessens destructive vibration and makes rapid driving a real pleasure. The first Dowmetal installation will show you smoothness, speed, comfort you never dreamed possible.

Ford and Dodge sizes only at present. Others to follow shortly. The market is big and the selling good. Every set sold is another salesman for you. Write for dealer plan now. Our proposition includes full selling co-operation. Address

Laurel, Montana, July 31st, 1921.

"We made the wonderful drive of nineteen hundred miles, pushed along at forty to forty-five miles per hour by those wonderful DOWMETAL Pistons. Not a miss or a rattle on the whole trip."

MARTIN N. RYAN.

DOWMETAL DIVISION

THE DOW CHEMICAL CO.,



Midland Mich U.S.A.

When writing advertisers—Just say FORD OWNER AND DEALER

# Modern Single Coil Distributor Ignition

for the Ford Car at

The New Price of \$14.00 Complete Offers the Ford Owner the Greatest Value in the History of the Ford Car.

The NEW YORK UNI-COIL DISTRIBUTOR IS THE ONE MOST NEEDED, LARGEST SELLING and greatest value giving device yet PRODUCED.

**ABOLISHES TIMER**

**With All Its Accustomed Troubles,  
Short Circuits, Oil Soaked Wires  
Eliminates Three Coils**

and the impossibility of keeping them all uniformly adjusted.

THIS IS THE ONLY SYSTEM that operates from the Ford Magneto or Battery, therefore the car may be driven regardless of batteries' condition which guarantees continuous service—even when battery is removed entirely.

It requires but one-half hour to install on any Ford from 1910 to date and will positively prove a revelation IN SMOOTHNESS, EASY STARTING, extraordinary pulling ability with an entire absence from all the troubles to which you have been accustomed.

Not an experimental unproven device,—the same principles employed in this system are used on America's highest priced cars. In use by thousands of Ford owners for the past eight years.

Furnished complete to  
the smallest detail. **\$14<sup>00</sup>**  
Price .....

Made and guaranteed by one of the  
oldest Ignition Manufacturers.



## NEW YORK COIL COMPANY

338 PEARL STREET

NEW YORK CITY.

# When Your Ford Oil Line Clogs



Two Days' Delay—and



The Ford oil line will clog, yet you can equip your motor with an oiling system that won't clog; and you won't have to tear down the engine to find out if it is working—it is attached on OUTSIDE of motor.

## SAFETY OILING SYSTEM SAVES \$75 YEARLY ON REPAIRS

Makes a cooler, smoother-running motor and adds years to its life. All oil-sucking parts of motor get constant, sufficient lubrication on the level, up-hill and down-hill.

*because it does pump oil*

**PRICE, \$6.00** YOUR DEALER HAS IT OR CAN GET IT FOR YOU

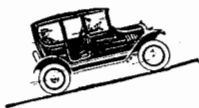

*When the Ford travels up-grade with the splash system, the gravity forces the oil to settle at the lowest point. This leaves the bearings, cylinders and pistons with little lubrication.*

### Safety Oiling System, INC.

2203 Fairmount Avenue  
 PHILADELPHIA, PA.

FREE TRIAL OFFER

We will send an S. O. S. on 30 day free trial at your dealer's request. Ask him to get one for you.



*When the Ford travels down-grade, the splash system allows the oil to rush to the front of motor, leaving transmission and brake bands with little lubrication.*

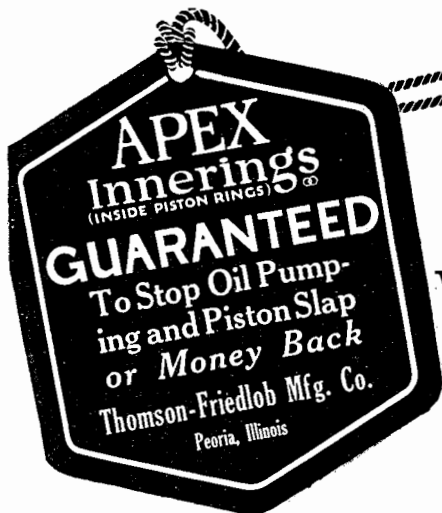

Protect yourself. Buy no innering that does not bear our Guarantee Tag. Others may LOOK like the Apex, but they can not bear this medal of honor. Imitations are made from inferior stock and are worthless. Apex Innerings are Imported Swedish steel, geometrically designed, properly sized, absolutely guaranteed. Insist on the genuine.

**WORTH \$100 per Set**

Dealers tell us that Guaranteed Apex Innerings at a few cents' cost, raise the re-sale price of a used car \$100.00 — *without re-boring the cylinders.*

They fit under the regular piston ring. Without Guaranteed Apex Innerings, piston rings wear OVAL on the face like this ( ). With Guaranteed Apex Innerings, piston rings are held in perfect alignment with the cylinder wall, like this ( ).

**GUARANTEED**  
**APEX INNERINGS**  
 (INSIDE PISTON RINGS)

fit under the regular piston rings. They automatically *centralize* the piston — this absolutely stops piston slap. They instantly stop oil pumping and lost compression. These features we guarantee Apex Innerings will do without re-boring the cylinders.

- “They work fine -- meet all requirements.” Lester & Jones, Kewanee, Ill.
- “Mr. Otis Skipton highly recommends them.” Edwards Street Garage, Springfield, Ill.
- “They stop oil pumping.” Shullsburg Garage, Shullsburg, Wis.
- “They are wonders for stopping piston slapping.” Iola Motor Co., Iola, Texas.
- “Having very good success with Apex Innerings.” Garner Auto Repair Shop, Chicago, Ill.
- “They are giving excellent results.” Elter Sales Co., Rochester, N. Y.

**RETAIL PRICE 30c EA.**  
 up to 3-8" wide or 5" bore. Larger, 50c. ALL SIZES. Give car model, year, size of piston rings, if possible. **ORDER COMPLETE SET—ONE Guaranteed Apex Innering FOR EVERY PISTON RING.**

**Thomson-Friedlob Mfg. Co.**  
 Peoria, Dept. A Illinois  
 Factory Branch, 58 W. Washington St., Chicago, Illinois

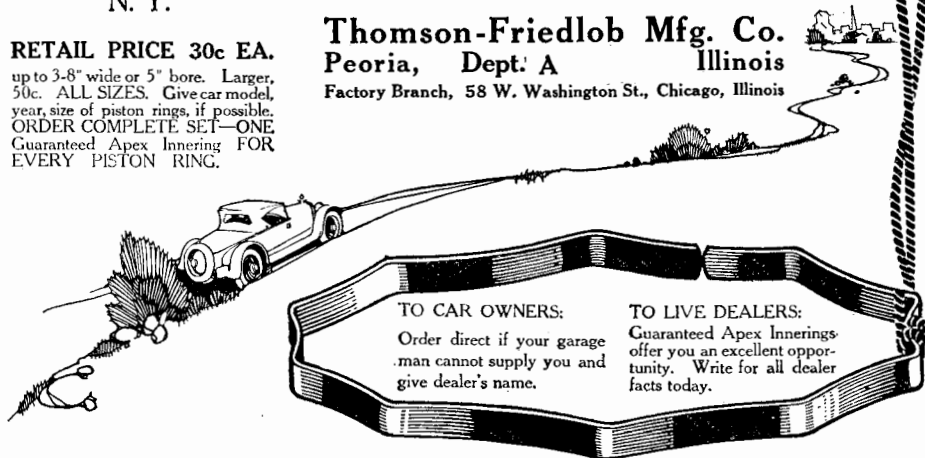

**TO CAR OWNERS:**  
 Order direct if your garage man cannot supply you and give dealer's name.

**TO LIVE DEALERS:**  
 Guaranteed Apex Innerings offer you an excellent opportunity. Write for all dealer facts today.

# A Ford Deserves a Willard

Willard does not make a special battery for Fords. On the contrary, every Willard is Willard-quality through and through! Whether you buy a Willard with wood separators such as has given good service on thousands of cars of all makes, or one of the latest-type Willards such as the Threaded Rubber or the All-Rubber Willard, you can be sure it is the

best battery your money can buy.

If you will go to any Willard Service Station or dealer, and inquire the prices of the various types of Standard Willard Batteries made in the Ford size, you will be very pleasantly surprised.

Treat your Ford to a Willard and get "more miles of uninterrupted service per dollar," just as the larger cars do!

**Willard Storage Battery Co., Cleveland, Ohio**

MADE IN CANADA BY:

Willard Storage Battery Company of Canada, Limited, Toronto, Ontario

*If you don't get 26 to 30 miles per gallon from your FORD you do not have the*

NEW MODEL L-4

# Kingston Carburetor

THE NEW KINGSTON MODEL L-4 CARBURETOR, which is being used as regular equipment by the Ford Motor Company on its new cars, is the biggest step forward in carburetion in the last twenty years. Here is the story in brief:

Tested in all weathers, in all parts of the country, under all conditions, it produced more power than any other carburetor we ever produced. A wonderful hill climber.

Positive and repeated tests insure this mileage:

Touring Cars 26 to 30.6 miles to gallon.  
Sedans 21 to 25.4 miles to gallon.

The New Kingston Model L-4 is provided with the improved spray nozzle, involving an entirely new principle in carburetion, and providing a super carburetor. More pep, quicker getaway, economy and power. Fully guaranteed.

**Price \$6.00**

WITH FUEL STRAINER \$7.50

*At Your Nearest Dealer, or Write Manufacturers Direct*

Note - This carburetor is not sold on extravagant claims, but upon its proved record of actual performance. It is guaranteed to do exactly what we say it will do.

**BYRNE, KINGSTON & COMPANY**  
KOKOMO, INDIANA, U. S. A.

Branches - New York, Chicago, Detroit, Boston, San Francisco

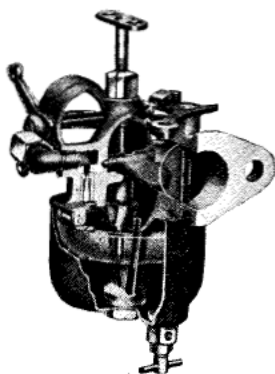

Cut-away view of the famous Kingston Model L-4, the NEW carburetor for Fords—simplest, staunchest and most efficient carburetor made.



Close-up view of the Kingston Model L-4 Spray Nozzle, the device that has made better carburetion possible. To be had ONLY on the new Kingston carburetor

*Kingston Carburetors are Used by 80 per cent. of American Farm Tractor Manufacturers*

# KINGSTON

# CARBURETORS

When writing advertisers—Just say FORD OWNER AND DEALER



---

Vol. 16

NOVEMBER, 1921

No. 2

---

## *About Thanksgiving*

With customary American system and fondness for schedule, each year we consecrate one day upon which to formally express our thanks for the blessings which are ours on the other three hundred and sixty-four days.

It is only the hopeless pessimist or one indeed most destitute who does not realize that his blessings are many.

You would find this to be true were you to compile the list of your reasons for giving thanks. Each person would have many individual blessings to add to those general ones shared by all of us. But we believe that we can mention one common cause for thanks.

If you are an employe of the great Ford plant or office; if you are a man who sells or repairs Ford cars and who therefore has enjoyed good business even in dull periods; if you are the owner of commercial Fords that speed you on towards business success; if you are a Ford car owner or the friend of one, and are able to enjoy healthy and happy trips wherever you will to go; — but why continue the list? — whoever you are, we believe that somewhere on your list of blessings will be the entry:

*I am thankful for the Ford!*

# Radiator and Hood Covers

*For Protecting the Cooling System*

In Boccaccio's story of PATIENT GRIS-ELDA, the stern marquis sent the lady away with only a shift to protect her from the weather. Fortunately, the plot was laid on Italy's summer shores. Had the plot been laid further north, the lady might have sneezed and the story would have been ruined.

Few owners of Ford cars wish to be as cruel as the stern marquis, and we have often seen drivers drape a lap robe artistically over the radiator in order to keep the shivering radiator from being frigidly frozen. But the use of this hap-hazard method of protecting the radiator has several disadvantages.

In the first place, the wintry winds are apt to blow the lap robe off the radiator. Then the radiator is unprotected, and the lap robe gets so messed up with snow and slush that it is not fit to place over the passengers.

Or, if the radiator has been steaming, then this vapor will condense and freeze on the lap robe, and will melt again when the lap robe is placed in the car. Also, a lap robe over the radiator is very apt to be stolen.

All of which suggests that the place for the lap robe is locked up *within* the car, where it will be snug and warm when needed. According to the Greek dictionary, it is foolish to try to use a hat for a shoe.

While the Ford is a mechanical device and so does not appeal to our human sympathies in the same way as a horse, which is usually provided with a cover; still the Ford is a high-strung, warm-blooded bit of mechanism which requires more intelligent care than a wheel barrow. And if the cooling system does not receive a little attention, the repair bill is apt to make a dent in the pocket book of the owner.

## Reasons for Radiator Covers

Among the important reasons why radiator covers should be used are: easier starting, greater engine efficiency, and smaller repair bills.

Even though the Ford car may be fitted with an electric starting and lighting system, still the fact that the starter is used so much more frequently in winter means that the starter may not always work as well as it should, if every reasonable means (such as a radiator cover) is not used to 'conserve' the power of the starter as much as possible.

When the engine is kept fairly warm, by the use of hood and radiator covers, then the manifolds and carburetor will be warm enough to insure better vaporization of the fuel and easier starting, even though the car be left standing for several hours at a time. Even though the *outside* of the engine may not seem to be overly warm, still the radiator cover will help to hold the heat in the water and *inside* of the engine as long as possible. And it is the temperature of the *inside* of the engine that tells the tale of **easier starting.**

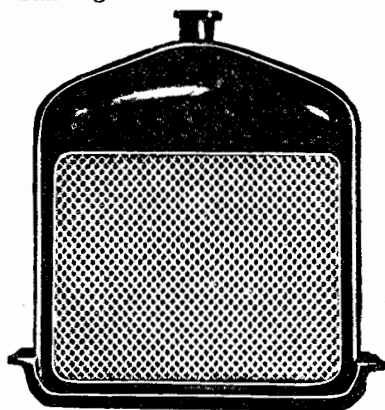

**Special Radiator**

Since the Ford cooling system is of the thermo-syphon type in which the circulation of the water is due to the difference in temperature between the top part of the radiator and the bottom; this means that the circulation of the water continues long after the engine has stopped, and until the water in all parts of the cooling system has reached approximately the **same** temperature.

This shows the futility of using a hood cover **only**—as it is the radiator cover that primarily determines the temperature of the engine. Of course the hood cover is valuable also, as a **secondary** means of protection, after the radiator has been covered up.

The use of hood and radiator covers is conducive to fuel economy. For if the engine is not allowed to become stone-cold, then less heat will be needed to warm up the en-



gine to normal running temperature. And since this heat can only be obtained from the gasoline, a saving of heat means a saving of fuel.

If the engine is allowed to become very cold, then it is necessary to use an extra-rich mixture for the first mile or so of driving. This extra rich mixture not only wastes fuel—but also condenses in the cylinders, runs down past the pistons, fouls the oil in the crank case, and tends to cause carbon deposits. And the fouled oil and carbon tend to cause more rapid wear of the mechanical parts of the engine.

#### Less Anti-Freeze Solution

When the radiator and hood covers are intelligently used, much less anti-freeze solution will be needed. This is particularly important when the anti-freeze solution is one containing alcohol. For if a 10 per cent solution can be used, instead of a 20 per cent solution, then a given amount of alcohol will last several times as long. When a large percentage of alcohol is used, then the boiling point of the cooling fluid becomes so low, and the alcohol evaporates so rapidly, that the alcohol has to be frequently replaced.

Since leakage and evaporation often cause the weakening of an anti-freeze solution below the 'danger line,' unknown to the driver; the wise driver will protect the engine with radiator and hood covers, as well as by means of an anti-freeze solution.



Horizontal Louvres

A frozen radiator often means an expensive repair for, even though only a few of the tubes burst, it is often necessary to take the entire radiator apart to replace the damaged tubes. While sometimes a freeze-up cracks the cylinder block of the engine, meaning an engine overhauled and the expensive replacement of the cylinder block, as well as the cost of repairing the radiator.

#### Special Radiators

The regular Ford radiator was designed for economical production but is not 'freeze-proof' on account of the straight round tubes containing the water. Most of us have noticed how the 'plain' round water conductors, or drain pipes from the eaves of roofs, are apt to freeze and burst if they become clogged up and the water collects in them.

On the other hand, there are the more expensive—but more lasting—water conductors of the 'fluted' or ribbed type; which do

not seem to be so easily damaged by an occasional freezing, until they are rusted through.

The reason for this lies in the fact that the 'flutes' allow a certain amount of 'give' to the pipe and, when the water expands at freezing, the fluted pipe simply 'swells' out to a more nearly 'round' shape. And returns to its original form after the ice melts.

While the plain round pipe or conductor cannot expand at all—save only by stretching the material. And when the 'stretch' has all been used up—then the pipe busts! That's all there is to it.

Other radiators for Fords carry the water in thin 'sheets,' so that the walls can 'bulge' a little in order to allow room for the ice. And these radiators act on the 'flattened' tube principle.

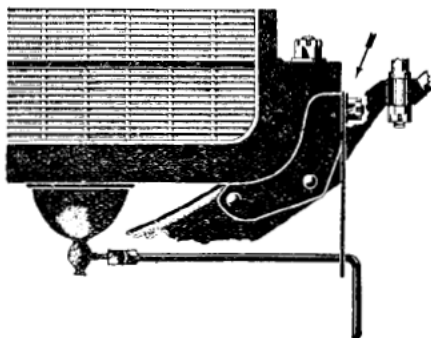

Radiator Drain Handle

We can roll a tube from a piece of paper, glue the tube along one edge, and pinch one end of the tube—and then blow into the end of the tube. Then it will be evident that the tube cannot accommodate more air by changing its form and that all the tube can do is to burst.

But, if we flatten the tube and then blow into it—we shall find that the sides of the 'flattened' tube will bulge out as the air pressure is increased. And that this tube can expand to the circular form of a plain round tube, before the paper is subjected to any real strain. Since the expansion of the water is relatively small (when once frozen, the ice contracts with a further drop of temperature) the expansion of the flattened tubes can be kept well within the 'elastic limits' of the materials of which the tubes are made. And the radiator will be able to stand repeated freezing without damage.

Some of these 'special' radiators are of the 'honeycomb' type, in which the air flows through the tubes and the water is outside of the tubes, and so can press the tubes inwardly without bursting them. And while, in these special radiators, the 'flattened' tubes are often arranged and twisted in a variety of forms, still they are usually freeze proof on the same general principal as the flattened tube.

One of the great advantages, of some of these special radiators, is the increased cooling surface which some of these radiators afford. This might seem to be of doubtful advantage in winter but, on closer consideration, this is found to be of great practical advantage. For the more efficient radiator

keeps such anti-freeze solutions as alcohol well below the boiling point. Then the alcohol does not boil off nearly so rapidly and, since alcohol boils so easily, this is a very important consideration.

The 'special' radiators are also advantageous when using kerosene or some similar anti-freeze solution, which does not have as high heat conductivity as water, and which is apt to cause the engine to overheat, unless a special radiator is used. And in winter, when one is plowing through deep snow on low gear, or through mud, the capacity of the cooling system is sometimes taxed to the utmost.

Winter is the season of extremes—either the Ford engine has to be kept as cool as possible, while working hard; or it has to be kept as warm as possible, while standing idle. To obtain easy starting, it is desirable to



**Inexpensive Fibre Cover**

keep the engine as warm as it can be kept. But soon as the engine is warmed up, then it is desirable to keep the engine at a moderate temperature in order to prevent the boiling away of the cooling fluid too rapidly.

By using a water circulating pump, and a special radiator, it is possible to use kerosene as an anti-freeze solution. But without a water circulating pump, the kerosene tends to cause overheating of the engine.

#### **Draining the Radiator**

Sometimes, when the winter is not too severe, the radiator can be drained each night, instead of using an anti-freeze solution in the radiator. But this method is really only practical in moderately warm climates, and where one has a supply of running water in the garage, so that the radiator may be refilled each morning without too much trouble.

By fitting a special handle to the radiator drain cock, the water may be drained out much more easily. It is our own plan to remove and drill out the drain cock to a larger opening, so that the water will run out much faster and so that the opening will not clog up with dirt so easily. When draining out the radiator each night, one should make sure

that the water supply is not shut off by a clogged drain cock, even though the water has once started running.

When filling up the radiator in the morning, it is preferable to fill up with warm water for easier starting. Also, as the engine and other metal parts get so cold during the night, that there is the possibility of the radiator freezing, before the water has a chance to warm up when the engine is driven outside. The better plan is to run the engine long enough to take the 'chill' off the water before running the car outside of the garage. If the car is driven right out and there is a strong head wind, then the radiator may freeze across the bottom. And this will shut off the circulation of the water so that the entire radiator will soon freeze.

When a well-padded hood and radiator cover are used, the engine can usually be kept warm enough to prevent freezing for an hour or two if the temperature is not below 20 to 25 degrees Fahrenheit, and if there is not too much wind blowing.

#### **Radiator Shutters**

In order to ensure that the radiator shall be covered, it is necessary to make it as easy and convenient to cover the radiator as possible. And to make it feasible to regulate the temperature of the engine, to correspond to weather and operating conditions, radiator shutters have been devised.

Some of these radiator shutters are lightly and inexpensively made of fibre, with horizontal slots which can be closed by means of cords operated from the dash. The shutter is made of weatherproofed fibre, which affords even better protection than metal from changes of temperature. The 17¼ by 18½ inch size fits the Ford radiator.

Another type of radiator cover is made on the principle of a Venetian blind, having horizontal metal strips, hinged at the ends, which can be turned to allow more or less air to pass through.

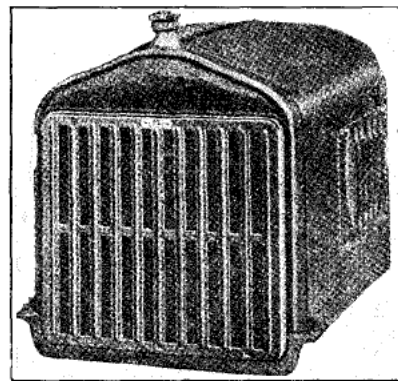

**U. S. with Vertical Slides**

These radiators are divided into upper and lower sections, either of which can be opened or closed from the dash, independently of the other section. This is a desirable feature as, for ordinary driving, it is often best to drive with the lower part of the radiator covered, as that is the part of the radiator that is most apt to freeze.

In the radiator shutter with vertical openings, there is a sliding grid, having vertical openings, which can be slid sideways across the openings in the outer metal covering to regulate the amount of air to be admitted to the radiator. With such shutters of the sliding grid type, it is of course hardly possible to expose more than 50 percent of the normal air surface of the radiator. But this is usually sufficient, as the cold air of winter and the hot tubes, conduct the heat away rapidly.

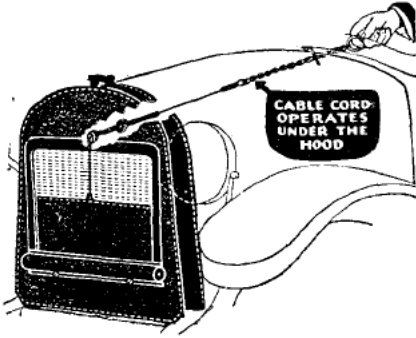

Shade Radiator Cover

It is very convenient to be able to control the amount of shutter opening from the dash, for the radiator can be kept completely covered for the first mile or so, until the engine warms up, and then the opening can be regulated to suit weather conditions and the load that the engine is pulling.

#### Radiator Shades

Instead of saying 'Pull down the blinds Maud, the neighbors are looking,' it may soon be the custom to say 'Pull up the shade, Maude, poor Henry's radiator is shivering.'

Some of these radiator covers operate on the principle of a window shade turned upside down. The covers being made of fabric material mounted on spring rollers, like those used for window shades. Such rollers are usually attached near the bottom of the radiator, so that the lower part of the radiator will receive the most protection—as it



Padded Hood Cover

should. The only difficulty is to mount the roller so that the starting crank handle will not strike the roller, if the car is not provided with an electric starter.

In one make of radiator shade, the cord used for raising and lowering the shade passes through a small tube slipped between the radiator tubes. And this cord ends in a ring at the dash, which can be adjusted to hold the shade at any desired height.

#### Padded Radiator Covers

Perhaps the most generally used form of radiator cover consists of a felt-lined, fabric cover which is slipped over the radiator. Some of these radiator covers are combined, or attached, to hood covers made of the same

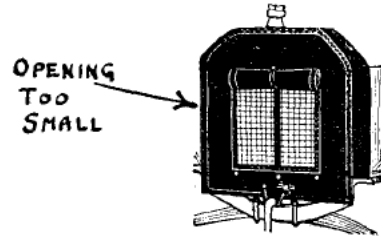

Not Enough Opening

material. But it has been our experience that it is preferable to have the radiator and hood covers so made that they can be used separately.

In moderate weather, only the radiator cover need be used. Then it is easy to obtain access to the hood, without bothering with a hood cover. Of course, for really cold weather, it is much better to use both radiator and hood cover. For if no hood cover is used, then much heat can be lost out through the openings, or louvres, at the sides of the hood.

Such radiator and hood covers are covered with imitation leather or enameled duck. But not so much depends on the material as on the accuracy of the fit, as to whether the cover mars the appearance of the car. Some of these covers are lined with asbestos, while others are lined with heavily padded cotton or wool.

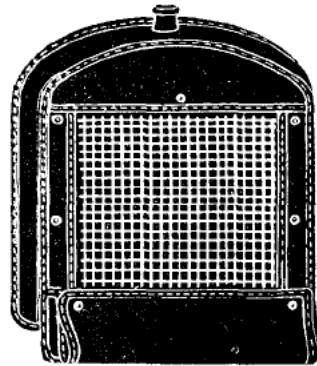

Good Radiator Cover

When selecting hood and radiator covers, see if the radiator cover can be so fastened that it will not blow loose when used alone without the radiator cover in moderately cold weather. Also, it is convenient to have the hood cover so fastened that it will 'stay put,' even though the radiator cover is not in place. For when the radiator gets frozen and begins to boil, the driver often ~~shakes off~~

the radiator cover entirely. And then the hood cover is apt to flap around loose.

Another important consideration in selecting radiator covers is to make sure that the opening in the front of the cover is the 'full size' of the radiator. In our illustration, we have shown an old-style radiator cover in which the opening is obviously inadequate to give proper cooling in moderately cold weather.

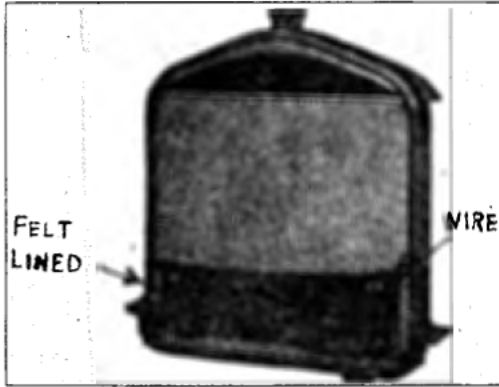

Lower Tank Cover

In order to make it easier to open and close the hood for adjusting the carburetor or changing spark plugs; the hood cover can have its corners attached to the hood by means of Murphy fasteners (such as are used to hold the side curtains to the body).

Or one can drill one-eighth inch holes, through both cover and hood, and slip rivets through both hood and cover, in order to hold the hood cover in place.

#### Inside Hood Covers

No matter how neatly the fabric covers are made, it cannot hardly be said that they add to the appearances of the car and so, for the fastidious Ford owner, inside hood covers have been devised. When these are used, in connection with the enamelled metal radiator shutters, the appearances of the car are really improved. When the cover is placed inside the hood, then it is just as easy to raise the hood to get access to the engine as though no hood cover at all were used. This is important in winter, when heavy gloves are used and the driver's frozen fingers are naturally clumsy.

When using hood covers, it is important to see that the engine pans, extending from the sides of the crank case to the side members of the chassis frame, are in place. For if these pans are bent or missing, then the outside air can easily blow in under the hood. And much of the expected gain, from the use of hood and radiator covers, will be lost.

When purchasing padded hood covers, it is desirable to purchase covers which can be folded up or adjusted from the bottom. For when only part of the radiator is to be used, that should be the top part. And the lower part of the radiator should be protected against freezing until the engine becomes so warmed that even the lower part of the radiator will be kept at a "safe" temperature.

In very cold climates, both an outside and an inside hood cover can be used at the same time. When making inside hood covers, these linings should extend down inside the hood sills for an inch or two, in order to more effectually close the space which usually exists between the bottom of the hood and the hood sills.

#### Home-Made Lining

For those who wish to make a home-made hood lining, this can be done by using a layer of corrugated, or asbestos-cell paper which is held against the inside of the hood by sheets of fibre about  $\frac{1}{16}$  inch thick. The sheet fibre can be obtained from trunk manufacturers,

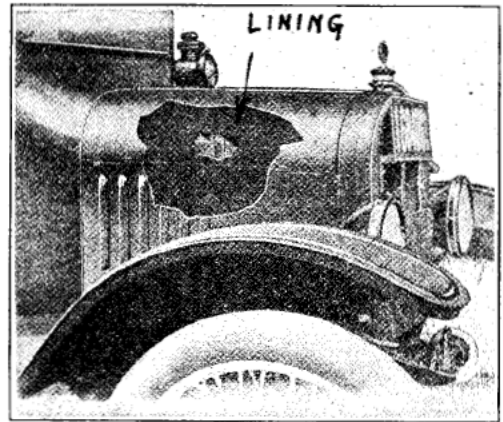

#### Lining Inside Hood

and can be held in place against the inside of the hood by rivets. If the heads of the rivets are placed on the outside of the hood, and the split rivets clinched inside over the fibre, then the rivets will not appreciably mar the appearance and finish of the hood.

#### Lower Tank Cover

As we have mentioned, the lower tank of the radiator is the vital part that is most susceptible to freezing, and so should have the most protection. In our opinion, it is an excellent plan to keep the "lower third" of the radiator permanently covered during the winter months and then, in addition, to use the regular radiator covers over the rest of the radiator.

The "lower third" covering or pad can be made of a piece of side or top curtain material, to which is stitched a piece of heavy felt or padding. This pad can be held in place by means of pieces of No. 18 insulated wire (commonly known as belt wire) looped through the pad, and then bent in between the tubes of the radiator. Care should be used in bending this soft copper wire not to damage the rather fragile tubes of the radiator. As the wire can be bent back in between the tubes, it will not catch on the radiator fan or on the hands of the driver.

# Storing The Ford for Winter

## Chances for Agents in Winter Storage

**I**N cities and towns, where there are street cleaning departments and heavy traffic to keep the roads open, and with hard surface roads beneath, on which the cars will not sink through the mud in rainy weather, the Ford car has a chance to prove its all-year utility.

But in some of the rural sections, where the roads become 'hub-deep' in mud after a few heavy rains, and where the snow collects in drifts, then it may not be worth while to attempt to use the Ford during the winter months. And Ford owners in such districts often prefer to put their cars in cold storage after November.

Even in the larger cities, there are always many 'fair-weather' drivers who dislike the discomforts of driving an open car in cold weather, and who shy at the terrors of skidding on icy roads, or of putting on tires in a snow drift. Consequently there are always plenty of owners who like to put their cars in storage during the winter months.

The alert Ford Agent will see that the car owners store their cars **properly**, for more damage can be done to a carelessly stored car than to one that has been in active use all winter. The key that rests rusts. And the Ford that is stored may rust and rot—if the storing is not properly attended to. Since the advent of the electric starter, the storage battery makes another vital point, requiring consideration in cold storage.

In choosing a place to store the car, it is better if the location is clean and dry, and if the temperature will not be subject to too violent changes which would be apt to cause the condensation of moisture on the metal parts of the car. The carefulness, with which the storing of the car is done this fall, determines the ease with which the car can be put into good condition in the spring.

### Drain Cooling System

After opening the pet cock, and allowing the water to drain out of the radiator, run a wire up through the pet cock to make sure that the water has not stopped flowing, merely because the pet cock has been clogged with mud.

Then run the engine for a minute or two, to dry out the water which may have remained in the water jackets of the cylinder

block. Close the radiator drain cock, and pour about a quart of alcohol in the radiator. Replace the radiator cap.

This alcohol will protect the cooling system in case any water has been trapped in odd nooks or corners of the cooling system. Sometimes the lower ends of some of the radiator tubes become clogged with mud or dirt. Then the water in these tubes may freeze and burst the tube, in spite of the fact that the water has been drained from the bottom of the radiator.

We do not believe in leaving an anti-freeze solution containing water in the car all winter. If it is a chemical solution, the chemicals may collect near the bottom of the radiator, making the solution too strong at that point and causing corrosion, and leaving the top of the radiator without adequate protection. If it is an alcohol solution, the alcohol will gradually exaporate during the long winter months and, when a really cold snap does come, the radiator may freeze and burst.

If one has been using anti-freeze solution in the radiator before putting the car into cold storage, then this anti freeze solution should be drained out and kept in glass bottles, until again needed. Then if the anti-freeze solution does freeze, only the bottles will break, and the corrosion cannot effect the expensive radiator and cylinder block.

### Drain The Old Oil

As crank case oil is now so copiously diluted with gasoline from the low grades of available motor fuels, the old, kerosene-thinned oil should be drained from the engine. After removing the drain plug from the bottom of the crank case, run the engine for a couple of revolutions to allow the oil in the connecting rod troughs to be splashed out.

It will hardly be either necessary or advisable to wash out the crank case with kerosene, as the old oil is thoroughly diluted with kerosene so that the engine is usually washed out very well by the old oil. And if kerosene is used, the amount remaining in the engine is detrimental to the new oil.

After replacing the drain plug, and pouring about a gallon of clean, fresh oil in the engine; run the engine a few turns to distribute an oil film of clean, fresh oil over all the working parts of the engine. If

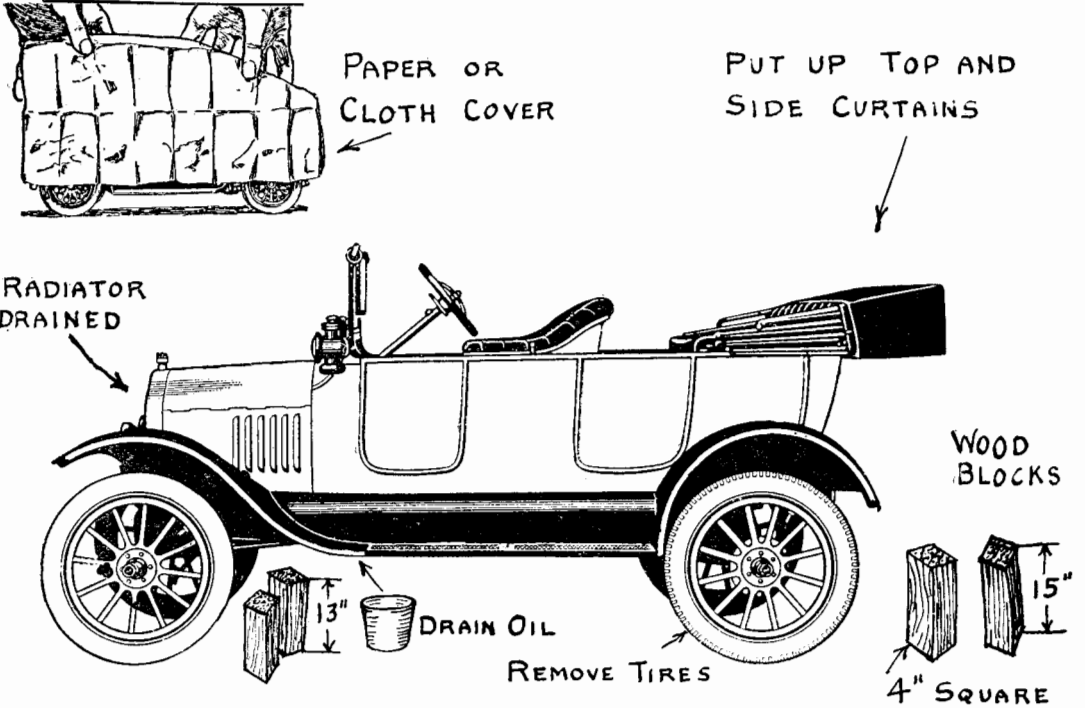

Storing Ford Safely

desired, one can remove the spark plugs and squirt a little clean oil into each cylinder, to aid in protecting the cylinder walls from rust. But this is hardly necessary if the engine has been run for a few seconds after the clean, fresh oil has been poured in.

To prevent rust on the engine or control rods and steering gear, it is a good plan to oil or grease these parts thoroughly, before putting the car away for its long winter nap. By smearing grease over the carburetor and other bright metal parts, they will be protected against corrosion. And it will be easy to wipe off the grease and put the car in commission again in the spring.

**The Fuel System**

It is better to close the gasoline shut off valve under the gasoline tank. Then if any leaks occur in the fuel line or carburetor, the gasoline will not escape and cause a fire risk in the garage. After shutting off this valve, remove the drain plug from the sediment bulb under the gasoline tank, and drain out the water which might possibly freeze and burst the sediment bulb.

Then remove the drain plug from the bottom of the carburetor and drain out the carburetor. As present available fuel is about 50 per cent kerosene and, as we all know, kerosene can cause rust; it is better to remove the kerosene from the delicate 'works' of the carburetor.

Whether or not the gasoline should be drained from the fuel tank is an open question which is answered by most car owners in the negative. If the old gasoline is drained out, there will be less fire risk in the stored car. And the tank can be filled with clean, fresh gasoline for easier starting in the spring.

On the other hand, draining the gasoline tank often means wasting a lot of good fuel—unless one can use this fuel in some other car or tractor. Also, changes in atmospheric conditions may mean that air and dust will be drawn into the empty tank, and that moisture will collect in the tank, possibly causing some corrosion and rust. And perhaps more trouble than if the tank were left full of fuel. If it is much trouble to drain out the fuel, it may be better to leave it in. But be sure the tank does not leak.

**Electric Starter Systems**

Those whose Ford engines are still started by the Armstrong starter can skip lightly over this section. But those who have an electric starter system had better take care of the battery—unless they wish to pay \$25.00 for a new battery next spring. A little grease, smeared over the outside of the starting motor and generator, will help to prevent the ingress of moisture into these parts—which is the only enemy these electrical parts need fear.

No matter if the storage battery is left in a fully charged condition, leakage of the electric current will occur, even inside of the batteries themselves. Consequently the storage battery will not be more than half-charged or so, after standing a month or less inactive. By disconnecting the 'ground' wire from the storage battery, some leakage of current through the wires may be prevented—but this will not prevent that leakage of current which occurs inside the lids of the cells.

If the battery is to be left in the car, the engine will have to be started and run for several hours every month to charge

the battery. And this means filling the radiator, turning on the gasoline and other troubles, and considerable use of fuel. Often, it is better to remove the battery entirely from the car, and to leave the battery at some reliable charging station, where they will give the battery a "booster" charge every month or so.

acid that the battery will be practically immune against freezing.

While taking the battery into one's home may protect the battery from freezing, still the battery will soon suffer from 'sulphation' if allowed to stand in a discharged condition. If kept at home, the battery should be given an occasional charge with a rectifier operated from the house electric lighting current. If the battery is allowed to stand discharged for any length of time, a hard coating of lead sulphate will form on the plates, which may make the installation of new plates necessary, in order to restore the former capacity of the battery.

**Tire Troubles**

We all know that the first glad days of spring show a terrific amount of tire trouble—mostly blow-outs due to rotted tires on cars that have been carelessly stored during the winter. When the car is only to be stored for a few weeks, or even for a month, it is seldom worth while to remove the tires from the rims—though the tire wheels should be jacked up, thus relieving the tires from the strain that occurs when the car is allowed to rest on deflated tires.

As few of us have four jacks, the jacking up of the car can be most conveniently done by keeping a set of wooden blocks for just this purpose. These blocks can be cut from 4 by 4 inch lumber. And the front pair should be 13 inches long. For the rear axle, these blocks should be 15 inches long. They can be cut from two pieces of 2 by 4 inch lumber, nailed together, if the solid 4 inch square lumber is not available. Or they can be cut from logs of from 5 to 6 inches diameter.

With the car jacked up, the amount of air left in the tires is not of such vital importance, as the surplus air soon leaks out, leaving enough air in the casings to hold the tires in normal shape.

If there is much chance of moisture or freezing in the barn where the car is stored for two months or more, then it may be advisable to remove the tires from the rims, and to store the tires and tubes in some protected location where the temperature will average around 60 degrees, and where the air will not be too moist. The tires should be wrapped in cloth or paper, to protect them from light and oil—both of which have a very detrimental effect upon rubber.

Instead of removing the tires, some owners simply remove the rims and all. This is certainly the easiest method when the tires are mounted on demountable rims. Where clincher rims are used, it may even be easier to remove the complete wheels, rather than to remove the tires from the rims and take chances of pinching the tubes when placing the tires back on the rims.

While it will do no harm to allow the rims to rest on the garage floor, after the tires have been removed, still water sometimes collects on a garage floor, and this may cause rusting of the rims. And since rusty rims are very hard on tires, it may be better to keep the rims up in the air, where there is less chance of rust. A little grease-and-graphite, or old paint, applied to the rims will protect them from rusting during the winter months.

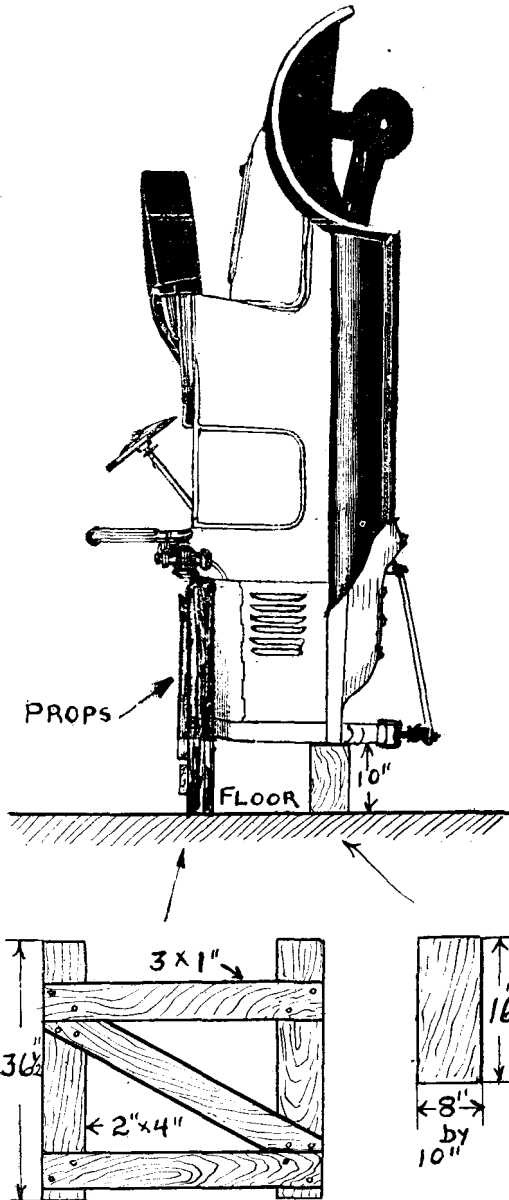

**Ford Stands on Head**

When the battery is discharged, the specific gravity or density of the acid becomes less—much of the acid being absorbed in the plates. Consequently, the remaining, almost pure water can freeze more readily—and if the water freezes, it will burst the battery jars, bend the plates, and make expensive repairs necessary. If the battery is kept fully charged, the solution will contain so much

### Protects Car Finish

If the car is allowed to remain for a long time with the top folded down, the top fabric is apt to become creased and damaged—so the top and windshield should be left up when the car is stored, and the top fabric material stretched out smoothly.

Clean the top and side curtains with warm water and soap. And put up the side curtains, after the seats and upholstery have been cleaned. The upholstery can be sponged off with a solution containing 10 per cent of ammonia in water.

A thin coating of vaseline, over the nickle and other bright metal surfaces, will protect them from tarnishing and rusting. And then the complete car can be covered with a cloth or paper cover. The paper covers can be bought ready-made from some of the accessory stores, and serve to keep off the dust.

Where space is at a premium, the Ford can be stood on its head. Remove the front and rear wheels, fold down the top, and rest

the frame on blocks about 10 inches high, in order to clear the head lights. On 1917 and later Fords, it is necessary to remove the hood in order that the props may support the weight of the car at the dash.

As the dash is braced by the body behind it, the dash is amply able to support part of the weight of the car in this manner, as the larger part of the weight rests on the chassis frame. No strain is placed on the radiator or other delicate parts, though the radiator should be drained before the car is stood up in the air. This manner of storing gets the car in one-third of the space occupied by the usual method.

After storing the car, we can remove the coil units or other vital parts, in order that some thief may not be able to make away with the car. And then we can pull down the blinds of the garage to keep out the sunlight, and feel secure in the knowledge that the good Ford will still be a 'good' Ford when next spring arrives.

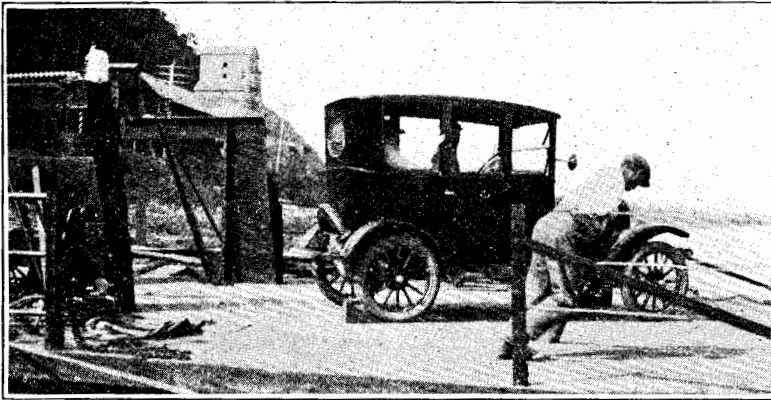

### A Merry Go Round For The Ford

ONE of the great features about motor touring are the queer things which turn up during a day's journey. There is no lack of the unexpected, the novel. Most any moment something may be encountered which makes the party of tourists all sit up and take notice. It may be a garage built in the rock as one is in southern Wisconsin. Again it may be a little merry go around for the Ford. Wouldn't you find it an interesting experience to find yourself suddenly going around while the car was not in motion? That is what is happening to the Ford tourist and his family in the picture.

Motor touring has produced a demand for a special type of ferries to transfer cars at river crossings where there are no bridges. One of the late models, if not the very latest, is built

with a turn table on the deck to minimize danger of accident. The car drives up the gangway and as it gets on the boat, the ferryman gives signal to stop. The Ford is on a turn table. The boatman pushes on a lever and around goes the Ford. Instead of having back to the front of the ferry the car is now headed front. With the aid of the ferryman the driver then backs toward the stern of the boat, giving room for other cars to take their turn on the table. Reaching the opposite shore, cars all drive off quickly.

The table has ball bearings, and swings around noiselessly and easily. A seven ton truckload has been turned by hand on the little Merry Go Round on the Mississippi ferry in the picture.



# Garage Heaters

## Aid All Season Use of Ford

The north wind doth blow,  
And we shall have snow.  
And what will the old Ford do then?  
Poor thing!  
"from Motor Goose."

**T**HERE are two important considerations in the selection of a garage heater, first the kind of fuel that is to be used. And second, the size of the heater. In this article we shall describe heaters for the three available fuels—oil or kerosene, natural gas, and coal. And heaters ranging in size from those for the smallest one-car private garage, up to heaters for large garages and repair shops holding five cars or more.

The kerosene-burning heaters are naturally limited to small private garages. The gas-burning heaters are quite generally used in private one and two-car garages. And, as there are many repair shops of about the two-car size, these same heaters, that are so efficient for the private garage, will be found equally effective in the small repair shop.

For the larger repair shops, of the 5-car or larger size, then some form of coal-burning heater will probably be found the most economical and satisfactory type of heater to use. As a temperature of about 40 degrees or so is usually considered sufficient to take the c"hill" off and prevent freezing in a private garage. While a temperature of 60 degrees or a little higher is the best working temperature in a regular repair shop, it may be necessary to use greater heating capacity for the repair shop, than in a private garage of equivalent size.

Most of these heaters have been designed for safety from fire risk, and so that they will not vitiate the air, and to burn for long periods without attention—and these same qualities are equally valuable for a good repair shop heater as in the heater for a private garage. As the up-to-date repair shop encourages car owners to have their cars repaired during the winter months, then some form of effective heater will be needed if the most efficient work is to be done.

### The Home Garage

Of course garage heaters will only be installed where the Ford car is kept in all-season use. And if the Ford is driven all winter, it is a dead cinch that it will need occasional tinkering and adjusting. Consequently, every private garage is more or less of a repair shop as well.

If the garage is too cold for the owner to

make the necessary repairs and adjustments, then the garage is not **complete**; and the garage is not the money saver for the car owner that it should be. If "stone walls do not a prison make," then four walls do not make a complete garage, unless the necessary heat for comfortable repairing is available.

While the average car owner has such large repairs, as transmission and rear axle overhauls, done at a regular repair shop; still there are many small repairs and adjustments, such as cleaning the timer, which can be more

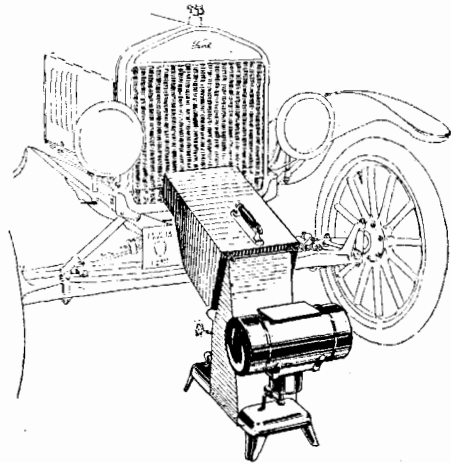

Portable Kerosene Heater

conveniently done in one's own garage at a considerable saving of time and expense. And these stitch-in-time adjustments often prevent more expensive repair bills later on.

Then there is the lubrication of the car and, owing to the severe conditions of winter use, this lubrication requires more frequent attention than in summer. If the garage floor is covered with ice or snow, the owner is far less apt to crawl under the car to drain out the old oil than if the garage is comfortably warm and dry. The way to make sure that this work will be done, is to make it comfortable and easy to do.

Some of the heaters have a "hot-water" arrangement which makes hot water available

for washing one's hands or washing the car, or even as an aid in starting the engine. And while few car owners wash their Fords much during the winter months, they would do so more often if the facilities were available.

Washing the car is really a necessary part of the care of the good Ford for, if the car is never washed, how can the different parts be inspected? Cleaning the car is the best time to watch out for loose bolts and nuts

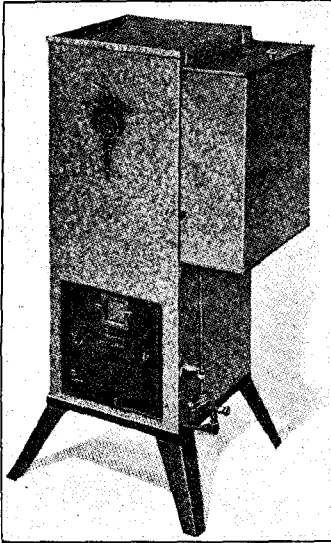

**Fuel Oil Heater**

which, if tightened, prevent the loss or breakage of parts when the car is in actual service.

Such parts, as front and rear radius rods, are far more apt to break and cause accidents, if the nuts are not kept tightly adjusted. And if these parts are covered with mud all winter long, how is one to tell what the adjustment really is? All of us have seen Fords which were so dirty that it was impossible to tell whether some of the bolts were in place or missing.

#### Protects Car Finish

Snow and ice collect on the winter-used Ford and, if this ice is allowed to remain on the car indefinitely, the acids and alkalies in the ice will dull even the finest finish. And the same applies to mud, which often contains much alkali which will eat off the finish in a short time if the mud is allowed to remain in spots.

A car that is never washed may require a new coat of paint in six months or less, while the well-cared for Ford may retain its glossy glow for a year or more of real use, even in wintry weather. And car owners are beginning to take pride in keeping their cars looking nice, even under adverse weather conditions—just as men take pride in dressing cleanly and neatly, even under difficulties.

#### Storing Up Repairs

In those parts of the country where MUD roads make winter driving impossible, many car owners store their cars and 'forget' them during the winter months. But winter

is the time when those living in the country have most leisure so, why not install a heater in the garage and use this leisure time for "storing-up" repairs?

Since one cannot use the car on the roads, that gives just that much more time for making repairs. And if the car is tuned up and adjusted during the winter, then no time will be lost from actual driving and touring when the roads open up in the spring.

The instinctive wisdom of the bee teaches it to store up honey during the summer for the winter months that is sure to come. And while we haven't enjoyed Fords long enough to possess any Ford instincts, still our ability to reason tells us that we can store up repairs for future driving next summer.

#### Protects Car Owner

With the increasing use of such all-season bodies as the Sedan, the Coupelet, and enclosed top attachments; Ford cars are being used much more during the winter months than ever before. And winter use means winter adjusting and repairing. And if one has gone to the trouble and expense of purchasing an enclosed car body, it is only natural that this one should complete the protection by installing a garage heater.

One of the most important reasons why one should heat the garage is the protection that

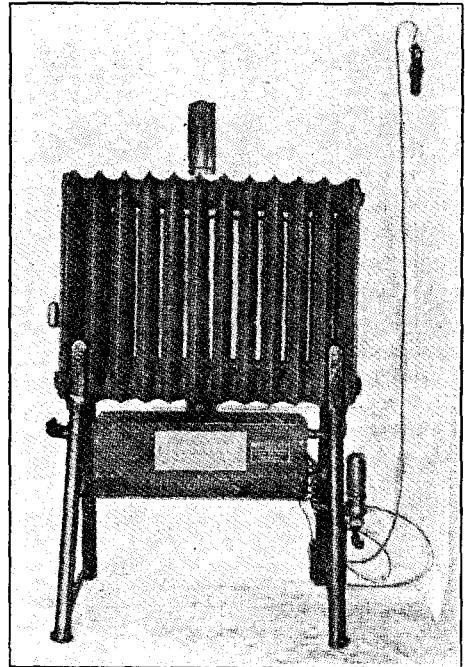

**Kerosene Steam Heater**

this affords to the health of the car owner. Winter is the season of sickness—why risk rheumatism or pneumonia in cleaning or starting the car, when the installation of a heater in the garage will do much to reduce this risk. The entire cost of a heater is usually less than the actual cost of a single sick spell. Sickness is probably our greatest extravagance.

Another important protection to the car

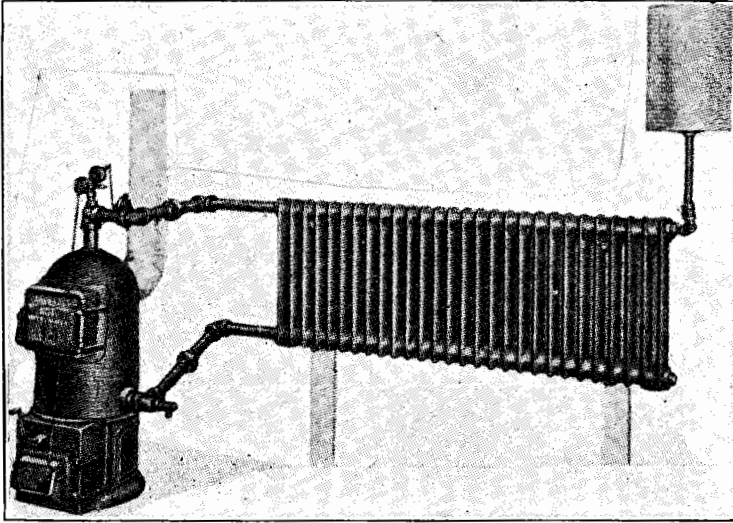

Coal Burning Heater

owner is when attempting to start the engine. If the engine is cold and stiff and refuses to start, then the owner is apt to get desperate and advance the spark—and many a broken wrist or dislocated shoulder blade has resulted from attempts to start a Ford engine in a stone-cold garage.

Or, the driver may become overheated in trying to get the engine to start. And then may become chilled and contract a cold while driving the car as soon, as the engine has been started. And there is also the chance of strain and injury to the owner from the attempt to crank a stiff Ford engine when the discs of the high speed clutch are gummed together by cold, congealed oil.

#### Easier Starting

One of the hardest questions to answer, that we receive during the winter months, is "how to start a cold Ford engine more easily?" And one of the logical answers is to install a garage heater, and so have "summer weather" in the garage all year round.

When the Ford car has remained all night in a cold, unheated garage; it is usually about as "dead as a door nail." As the lowest temperature occurs in the wee, small hours of the morning, just before dawn; the Ford gives a large per cent of its starting troubles in the "morning" start.

After the Ford car has once been started in the morning, and driven for some little distance; then the "insides" of the Ford engine become warmed, and the engine usually retains enough heat to make all other 'starts' during the day comparatively easy. If the Ford is provided with radiator and hood covers (as every winter Ford should be), then these covers will retain enough heat in the engine to make other starts during the day much easier. But even the best hood covers are practically useless for retaining the heat when the Ford is allowed to stand all night in an unheated garage.

When the Ford is kept in a heated garage, then the liquid gasoline is more readily chang-

ed into a gaseous fuel, on which the engine can start and run. One cannot boil water on a cold stove, neither can one vaporize gasoline in an absolutely cold carburetor.

Another important factor, in the winter starting of Ford engines, is the **lubrication**. For if the engine is not too cold, then the lubricating oil will be kept in a free-flowing condition, so that the engine can be cranked or spun at a sufficiently high rate of speed to insure better vaporization of the gasoline, and a better spark from the Ford magneto. And the faster the engine can be spun, the greater the chances are of starting the engine promptly and easily.

Spinning the engine gives that 'hot' spark that is necessary to ignite a cold, lean mixture. And the faster the engine is spun, the greater the **compression** in the cylinders, and the better the chances will be that the engine will fire and keep on running when once started.

When the engine is allowed to become too cold, then the discs of the high-speed clutch become gummed together by cold congealed oil—and this is one of the chief reasons why it is so very difficult to crank the Ford engine at all when it becomes very cold.

#### Electric Starter Fords

While there are several million Ford cars now in use still using the "Armstrong" or hand-cranking; still even the owners of Ford cars equipped with electric starting and lighting systems will find it advisable to consider ease of starting, in order to reduce wear and tear on the electric starter system.

When the car is kept in a cold garage and the battery becomes chilled, then the chemical activity is less; and there is much more strain on the battery when it tries to furnish the heavy rush of current that it required to "break loose" a cold, stiff Ford engine, in which the lubricating oil has congealed.

Since trips are comparatively short in winter, the engine is started much more frequent-

ly. Also each "start" is harder and requires a much greater drain of current from the battery. And as the lights are used much more during the long winter nights; the result is that the Ford storage battery is apt to be in a more or less "run-down" condition during the winter, unless the wise driver uses every possible means to conserve its energy.

When the battery is not kept fully charged, the storage battery is more apt to freeze. For when the battery is partially discharged, then the density of the solution in the battery is less. And if the battery is allowed to freeze, then this will probably burst the battery jars and ruin the battery. Since the cost of a storage battery is about that of a garage heater, it pays to invest in a heater to save the battery.

When the battery energy is conserved by easier starting in the garage, and the battery thus kept fully charged at all times; no trouble with freezing is apt to occur, as a fully charged battery does not freeze until temperatures far below Zero are reached.

#### Reducing Wear

If the engine is kept fairly warm in a heated garage, then it is not necessary to open the carburetor adjusting rod so many full turns when starting the engine. For starting an engine in an unheated garage, we recommend from three to four full turns of the carburetor dash adjustment rod. But, as many Fords run with less than one full turn, after the engine is once warmed up, this shows what an excessively rich mixture of liquid fuel has to be poured into the engine for easier starting.

In addition to wasting fuel, this use of several times the normal amount of gasoline has a tendency to form carbon very rapidly, while the engine is spluttering and misfiring in an attempt to warm up, and is one of the chief reasons why the carbon has to be removed so much more frequently in winter than in summer, for a given number of miles of driving.

But the most pathetic part of the use of this excess fuel is that much of the raw gasoline slips down past the pistons and contam-

inates and thins the oil in the crank case. While the actual gasoline tends to boil away from the crank case oil as soon as the engine warms up, still the average motor gasoline contains at least 50 per cent of kerosene. And this kerosene remains in, the oil and spoils the lubricating qualities of the good engine oil.

This means that the engine oil will either have to be replaced every hundred miles or so, at considerable bother and expense or else the contaminated oil will have little lubricating value and rapid wear of the pistons, cylinder walls, bearings and other parts will occur. If the garage is heated, and the car kept at a more even temperature; then the carburetor adjusting rod will not have to be opened more than a half turn or so, and much less fuel will be drawn into the cylinders to spoil the crank case oil or form carbon.

Most of us are familiar with the behavior of "molasses in January," and cold engine oil is often about as sluggish and reluctant to flow to the bearings and different parts of the engine. One of the advantages of the heated garage is that it does much to protect the bearings and cylinders from unnecessary wear, due to lack of lubrication, while the engine oil is getting warmed up and ready to flow.

By keeping the oil in the crank case in a liquid, free-flowing condition; the oil is on-the-job and ready to lubricate the engine parts at the instant the engine starts and not five or ten minutes later, after the congealed oil has thawed out enough to splash around in the crank case and run through the oil feed pipe. In these few minutes, without sufficient lubrication, the bearings and cylinder walls may receive as much wear and tear as would occur in several hundred miles of useful driving.

When the garage is not heated, then some car owners run the engine for several minutes before taking the car out of the garage. While this is good for the engine, this may be bad for the owner. The over-rich mixture, together with the cold engine, tends to produce carbon monoxide gas. And the fumes of this gas are particularly dangerous to the

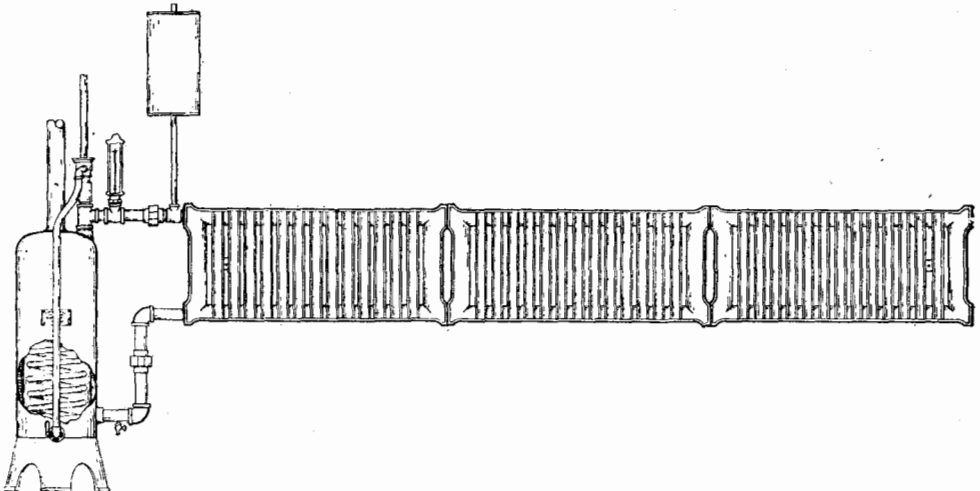

Gas Burning Hot Water System

health of the driver, because they are invisible and almost odorless.

If you **must** run the engine, then leave the garage doors wide open, or take the car outside. Carbon monoxide gases have been responsible for killing quite a number of people in garages and, even when not fatal, exposure to this gas often results in mysterious head-aches a day or so later.

When the garage is heated, then the ice and snow remaining in cuts in the tires will be dried out, and there is less chance of rotting the tire fabric—with blow-outs and tire troubles to follow.

And in the warm garage, it is not necessary to **strain** the engine running on one or two cylinders, or to loosen the bearings by **racing** the engine while warming up.

#### Anti-Freeze Solutions

When the garage is heated, there is less danger of frozen radiators or cracked cylinder blocks. Even though an anti-freeze solution may be used, this solution tends to become weaker through leakage and evaporation, and the heater in the garage may prevent the freezing during the long winter nights.

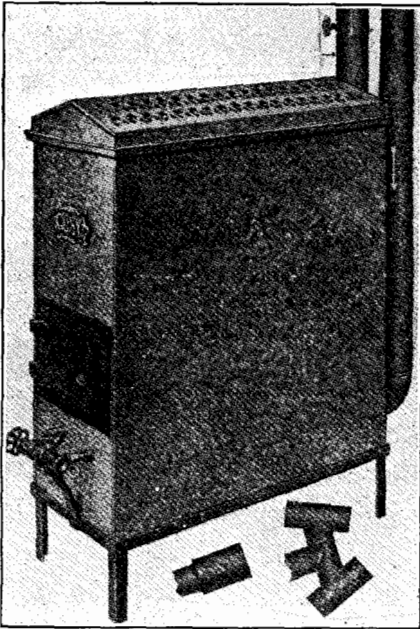

Superior Gas Heater

As the temperature during the day is usually many degrees warmer than at night, and as the car is seldom left standing for many hours at a time during the day without running the engine, it is possible to use a much weaker anti-freeze solution, when the car is kept in a heated garage. This weaker cooling solution means much less corrosion of the radiator and other parts if a calcium chloride or other chemical solution is used. And it means much less waste of alcohol, if this good but expensive anti-freeze is used.

#### Ordinary Stoves

The little red school house usually contains

an old-style, round cast iron stove, which has the advantage of being low in first cost. But such a stove is not suitable for a garage, because it is too dangerous from the point of fire risk. In any garage or repair shop, there is always the risk of a leaky fuel line or a dripping carburetor, and **one fire** is more expensive than **many heaters**.

And an ordinary stove radiates the heat "straight out," so that if the car is placed near the stove—as it usually is in a garage—then the varnish and tires on the side of the car nearest the stove may be blistered by the excessive heat, while the other side of the car may be insufficiently warmed. Good **distribution** of heat is essential for good garage or repair shop heating.

#### Kerosene Heaters

Kerosene is one of the most easily obtainable fuels but, owing to its cost, its use is limited to taking the chill off the radiator and engine to protect the cooling system to make starting easier, and for heating very small-and-compact garages. Kerosene is most suitable for moderately warm climates, and where the heater is only occasionally used to warm up the garage when the actual repairs are to be made.

The Neverout kerosene heater can be placed "close-up" to the Ford radiator, and a cowl directs the heat directly against the radiator. When the water in the lower part of the radiator is warmed, then the circulation of the water in the Ford cooling system begins, and the cylinder block is kept nicely warmed and all ready for an easy start, and the oil kept fluid and the gasoline ready to vaporize.

The Scientific oil heater burns either fuel or kerosene, and the burner is wickless and sootless. The heater is so designed that all the heat escapes from the **top** of the heater and none from the sides. Consequently the heater can be used where there is but little room between the car and the garage walls, without danger of blistering the finish of the car. The heater is built on the principle of a miner's safety lamp, to reduce the fire risk.

The use of a kerosene-burning steam heating radiator is a new idea in private garage heating, with the burner and fuel reservoir under the radiator coils. The radiator is carried on cast iron standards, with a solid iron box containing the burner. The openings into this burner box are protected by a couple of layers of brass wire screen. The burner is of the wickless, blue-flame type; and is supplied with a thermostat to maintain a uniform temperature, irrespective of weather conditions.

Among the advantages of the use of kerosene are no coal or ashes to be bothered with. And such a heater eliminates the need for a chimney, or fire-proof out house. While such a small self-contained heater is of value for a one-car garage, or as an **auxiliary** heater in repair shops still when greater heating capacity is needed, it will probably be more economical to install a larger steam heater, with a separate coal burning boiler.

#### Advantages of Steam

Steam expands to over seventeen hundred times the volume of the water from which it is generated. And owing to its lightness

and velocity the steam flows quickly to the most remote parts of the radiators which it heats. Steam also has the advantage of its flexibility, the ease with which it may be controlled, and the quickness with which it may be generated.

One of the interesting properties of steam is that, when it touches a surface that is cooler than 212 degrees, the steam instantly condenses and, in so doing, gives up the heat units contained in the latent heat of vaporization. Since the surface of the radiator is always cooler than this, the steam is constantly condensing and giving off heat. This makes available the supply of water that is returned to the boiler for reheating.

When a garage is located in a cold climate, or is of a fairly large size, then the use of coal is suggested, with either a steam or hot-water heating system. Such heaters are well adapted to the use of repair shops, as the heating radiators can be distributed around the walls of the shop, to distribute the heat near where the men are working.

#### Coal-Burning Heaters

When coal or wood are used for fuel, it is desirable to place the heater in a small out-house, or separate compartment, entered by a door from outside. Thus eliminating danger of fire risk in the heater compartment, from gasoline fumes arising in the garage. This plan is particularly easy when either steam or hot water are used for the heating system.

In hot-water heating systems, such as the Wasco, any number of wall radiators—from one to ten—can be connected to a single boiler, which supplies the hot water to all of them. By placing these iron radiator grids on the walls, space is saved in the garage, and an even distribution of heat is secured.

In the Richardson garage heater, there is a fire box of sufficient depth to hold an ample supply of fuel, thus ensuring sufficient heat without the necessity of frequent attention to the heater. The grates can be used for burning different kinds of fuel, but the "chestnut" size of anthracite coal is recommended as usually giving the best results.

All parts are fitted together, before being shipped from the factory; so the installation only requires the setting up of the heater, the fastening of the radiators to the walls, and the making of the necessary connections.

An approximate idea as to the cost of such a heater installation, including everything ready to set up, but not the actual work of making the installation, varies from less than \$100.00 for the one-car garage size, to about \$250.00 for a heater of suitable size for a five-car garage. In garages where space is rented, the extra rental for a heated garage soon pays for the entire cost of the installation of the heater.

#### Gas-Burning Heaters

In those parts of the country where natural gas is available for fuel, this forms the most convenient of all available fuels, as the heater can be adjusted to burn all winter long, without attention or care. The gas heaters are made in a variety of forms, some being flat and narrow, to fit between the side walls of the garage and the car. While others

are square or round, and are more conveniently placed in a corner.

In the Eureka heater, the automatic boiler uses gas as fuel and is fitted with thermostatic fuel control so that the amount of gas used is varied to meet the conditions of the weather. The heater consumes from 20 to 100 cubic feet of gas per hour, and will supply heat to about 100 square feet of hot water radiator heating area.

Another type of gas-burning garage heater is of the "hot air" type, such as the Superior, in which heated air flows from the top of the heater, and is circulated throughout the garage on the thermo-syphon principle. This heater is of the "flat-and-narrow" type and the sides of the heater are padded with asbestos, so that the car can be placed right beside the heater, without danger of damaging the car's finish or injuring the tires.

In this Superior heater there is an air-tight combustion chamber, which draws in air from outside of the garage through an intake pipe. And the combustion chamber has



Sterling Gas Heater

no connection whatever with the air in the garage itself. Consequently, there is no possibility of fire, even though leaks should occur in the fuel system of the Ford. Another pipe conducts the burned gases outside of the garage. This method has the advantage that there are no carbon monoxide fumes to vitiate the air in the garage; thus making this type of heater valuable for use in garages and repair shops, where men are actively at work.

There is a tiny pilot flame, which is left burning all winter. This makes it unnecessary to open the heater door while lighting the heater, and so reduces the fire risk. The door is pad-locked, to prevent accidental opening. And the flame is visible through a mica-covered opening in the heater door.

Inside of the heater there is a tubular radiator, where the air is heated while passing through tubes placed in the combustion chamber. The smaller size heater, which is 30 inches long and 36 inches high, is made

for garages of up to 2,000 cubic feet in size. While the larger heater is of the same height, but is 48 inches long, and is intended for garages of 3,000 cubic feet or over.

The Scientific is another natural gas-burning heater, in which the gas is ignited by a friction lighting device consisting of a flint and steel arrangement, somewhat similar to that used on flint-lock muskets. The heating drum, which contains the burner, is of air-tight construction, except for the outlet to the stove pipe, and the intake under the burner which

admits the air required for combustion. This air intake is protected by several layers of heavy copper wire mesh, which prevents the passage of the flame, on the same principle as the Davy safety lamp, as used by coal miners.

A still smaller type of gas heater resembles a small gas stove, and in this Sterling garage heater the flame is completely enclosed, with wire mesh protecting the air inlets and outlets, to reduce the fire risk.

#### AH, HA!

When Caesar came unto the Rhine  
He had a nervous fidget,  
He hunted round for many a day  
To get the stuff to bridge it;  
But if he saw that river now,  
Though angrily he roared it,  
He'd take the Car and shout, "Ah, ha."  
And just go in and FORD it.

Chas. N. Sinnett.



### *Ford Is Present as Usual*

If you have an inquisitive disposition no doubt you have often yearned to see the under side of a car, a sight which perhaps has been denied you, except at such times when, prone upon your back under the bus, you try some combined contortions and mechanical stunts; but such a view was not satisfactory because of a faulty perspective.

Here, however, you can see the Ford vir-

tually standing on its head, and looking altogether undignified, at a street intersection at San Antonio, Texas. It is reported that this car, because of a series of successes in overcoming obstacles, believed that it could combat the recent disastrous floods and appears to have come out second best for once. As in all other events of interest or importance it seems that the Ford is in the foreground.

## Some Winter Patents For The Ford

Some magazines advocate tours to the South-land for the winter—because most people think of 'ordinary' automobiles as 'fair-weather' vehicles. But with the unusual Ford, the case is different; and some of the devices here illustrated are designed to facilitate the 'all-winter' use of the Ford car through snow and over ice.

In Patent No. 1 the rear wheels have been removed and sprockets fitted to the ends of the axle shafts. These sprockets drive, by means of chains, other sprockets actuate the 'creeper' tread, which is built in the form of a 'baby tank'—made so famous during war times. Such a tread should get a splendid grip, without sinking into the snow, and should propel the runners (fitted to the front axle) very nicely. As all the features of this device have been tried out, such as the caterpillar tread and the front runners; and as so few changes have to be made in the car itself, this device may prove a good booster for winter sales of Ford cars.

Patent No. 2 shows another form of drive which does not appear to be quite so practical. It would probably be necessary to fit an almost entirely new rear axle and drive gears for the 'star' wheel. And it is doubtful if the 'star' wheel could meet all the requirements of both snow and ice, with equal success. It would probably work better over ice than through the snow.

Cutting 'lake ice' for storage is a hard job by hand, but here is Patent No. 3 we have an old-reliable Ford engine mounted on a sled and geared to an ice saw which should certainly send the ice chips flying. Notice the rudder or guide, at the end of the device, which fits in the saw cut and makes it easier to guide the plow-like outfit in a straight line.

A combination of caterpillar tread and sled, to replace the rear wheels of a Ford, to give the tank-like, creeper drive, is shown in Patent No. 4, with adjustments to keep the tread in even contact with the ground.

Observe the husky snow plow at the front of the motor-sleigh shown in patent No. 5, and figure out, if you can, how the star-shaped spur wheel at the back of the contraption is going to shove the snow plow through the drifts. If you can't figure it out—neither can we!

In this device, the Ford rear axle system is removed entirely, and a special shaft drive, with universal joints, is fitted to allow the spur wheel, or 'kicker,' to be lifted or lowered for rough and rutty roads.

Another flight-of-fancy is shown in patent No. 6. But anyone who knows how easy it is

to pull the filler spout off a radiator, and how hard it is to replace, would certainly hesitate a long time before hanging on the husky spring, and attaching the front end of the snow plow to the radiator. But this snow plow is of interest because it would be convenient to have a light and easily attached snow plow to enable the Ford car to clear its own pathway from the garage to the street. Also, there is the possibility of such use with the Fordson tractor.

In Patent No. 7 we find a device for attaching the runners to the front wheels of a Ford car, these runners being attached to metal semi-circles which fit around the tires of the front wheels. One of the greatest advantages, to our way of thinking, is that this device is so easily taken off. Probably it would remove itself in the first snow drift.

Another device for removeable skids or runners, for the front wheels, is shown in patent No. 8, in which the runners are attached only to the wheels. Probably some provision is made for keeping the wheels from revolving, as otherwise they would tend to turn very easily on any but ice or perfectly smooth, packed snow. And to fix the wheels so that they would not revolve, and yet could be swayed for from side-to-side for steering, is one of those mean and nasty practical problems that inventors often overlook.

Several years ago, one of our readers made a couple of skids to replace the front wheels of his Ford, put big chains on the rear tires, and sallied forth. But he didn't sally far, for the device steered like a blind mule—and skidded right into a ditch.

Once in the ditch, the natural thing to do was to back out. And then the thrills began! For the rear ends of the skid runners caught in the snow, and the front skids reared right up on end—and then let the front of the car down again with a terrific bang! And then the owner wrote and offered the runners to us, gratis. But we firmly and politely declined. His experiences were good enough for us.

Patent No. 9 shows a motor sleigh for jingling over the snow the next time you go to the North Pole. Why hoof it, and drive a bunch of 'huskies' when you can ride in state in this gee-willikins contraption. Observe the Ford roadster top and body in the middle, together with the Ford engine, which drives the two 'wind mills' at the ends of the what-is-it. The drive is by fans or propellers, similar to those used on aeroplanes, and these fans are mounted on turnable columns, so that the propellers can be used at the proper angles for steering or counteracting the effects of side winds.



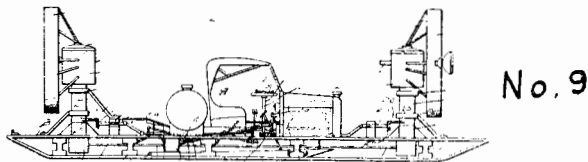
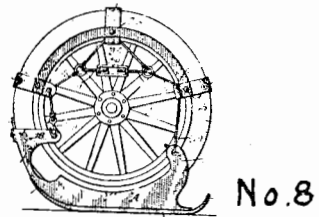
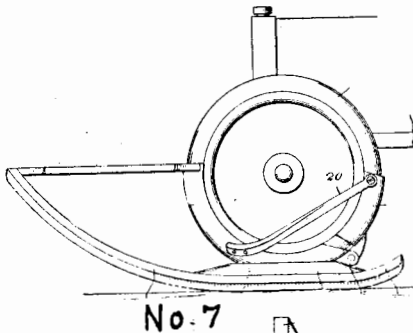
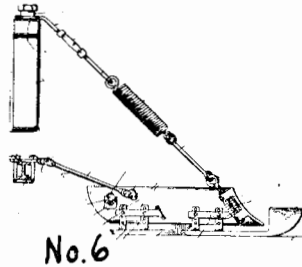
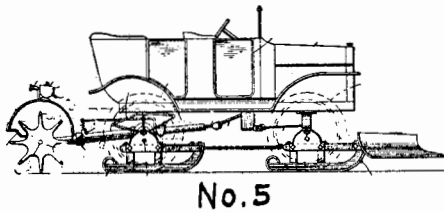
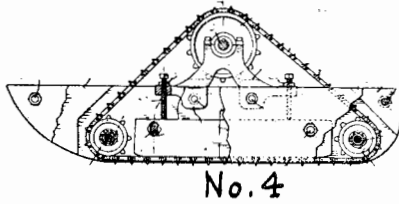
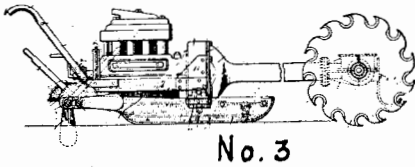
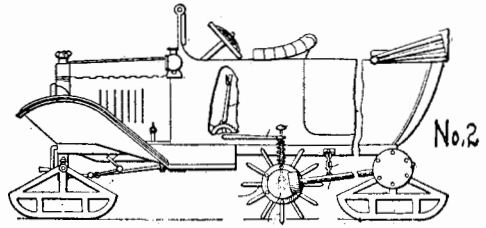
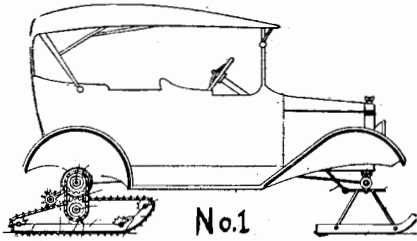

Drawings Of New Patents

### Another Wise Man

There was a man in our town—  
 But was he wise? Gosh, No!  
 He went and bought a Bigcar,  
 And squandered all his dough!

But when he saw his cash was gone—  
 His wisdom triumphed then;  
 He traded for a Flivver  
 And saved it back again!

L. M.

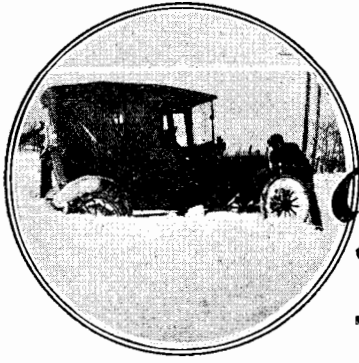

# Starting Difficulties

## The Reason and Remedy

By Glen F. Stillwell

Crank a while, smile a while  
Spin her 'til you're bored,  
Glide a mile, start to smile,  
At your stubborn Ford.

**Y**ES, some of us can still remember those balmy days when straight hoods were in flower. But now, since the days of the electric starter, Ford owners do not seem to experience the starting difficulties, which were the cause of so many lamenting in the days of 'shiny' crank handles

All those who have grasped old Armstrong's patent, and have rotated it with the patience of Job—arise and be classified for seats of honor.

And speaking of cranking, there are the owners of Fordson tractors. In outfitting these, Henry provided each and every one with a sturdy crank. One that would stand considerable torque and end thrust. You are not asked to spin it more times than would take it around a thirty acre field. But, here we pause. Experiments show that ample provisions are made for a tremendous twisting strain.

But, getting down to business, a motor that is hard to 'commence' should not be tolerated. In the first place, it is a strain on the starter, electric or otherwise. And in the second place, it is drain on the battery. Any one who has experienced battery trouble knows that it is costly and extremely annoying. Last, but not least, an engine that is difficult to commence is not generally found in a Ford that we enjoy driving. While an easy starting Ford will, as a rule, do more than take you there and bring you back. For there will be the added pleasure of going and returning in a smooth running machine.

"There's a reason" (apologies to Grape Nuts) for a hard starting motor. Why not find it and derive the resulting satisfaction?

Probably a good percentage of starting difficulties can be traced to the commutator; the thing-a-ma-jigg that W R Bradford so aptly called the toad-in-a-hole (undoubtedly because it makes so many Fords hop).

Examine this, and if the segments are not rough and grooved, and the roller is in good shape, oil and replace.

Assured that the timer is not at fault, you may next examine, and adjust the spark plugs. Don't take it for granted that they are not broken. Take them apart and know they are all right.

The spark coils should be next examined. And I cannot too strongly emphasise the importance of properly adjusted points. Time and again the writer has taken the stubbornness out of Fords that were supposed to have a weak magneto, merely by decreasing the tension on the trembler point.

There are a good many mechanics who believe, that if a Ford coil is tuned to shoot a big spark across a wide gap, on a coil-testing stand, it will work better in the engine. However, this is not the case, because too much tension on the trembler points will cause them to pit and burn easily, the motor will not idle properly, and will be hard to start. That is, there is not enough magnetism induced in the core of the coil to break the points. On a test stand, a properly adjusted coil should just jump a quarter-inch gap with a bluish spark.

After you have assured yourself that the coils are in good working order, the carburetor may be examined and adjusted. However, it is best not to bother it until you have made sure by tests that it is out of order. This can be ascertained by the following test. If the motor fails to start, remove the plugs, and prime each cylinder with a little gasoline. If the motor starts, you can be sure that the fault is in the carburetor. The cork float may be low (it should be just below a horizontal position, i. e. the movable side, when closed. If yours is a Kingston carburetor, the lead air valve may not be seating properly.

If, after making the above tests, everything is found to be O. K., you may test for a weak magneto. Any garage will make this test for a small sum. But see that they test it with both ammeter and voltmeter. It should register 8-10 on the former, and 16-20 on the latter, at a moderate engine speed, while operating on dry cells, or a storage battery.

\$2.00

KEEPS THE HEAT IN SHUTS THE COLD OUT  
**Thermo Shutter**  
AN OVERCOAT FOR RADIATORS

\$2.00

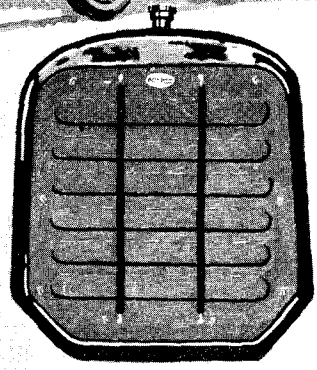
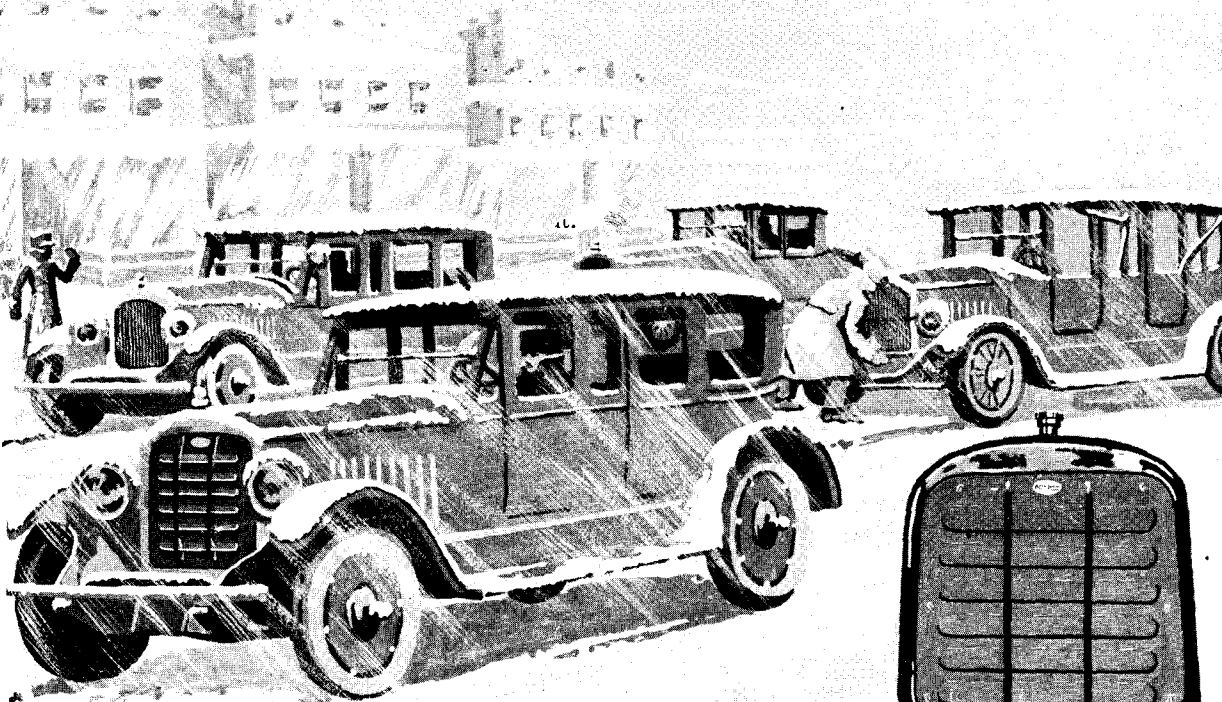

## Don't Hesitate—Order NOW

1. Brings a Summer Song from a Winter Motor.
2. Protects the Radiator from Freezing.
3. Controlled from the Driver's Seat.
4. Keeps the Raw Gas out of the Lubricating Oil.
5. Saves the Bearings by Improved Flow of Oil.
6. Insures Easy Starting of the Motor.
7. SAVES the STORAGE BATTERY.
8. SAVES 20% to 30% of the GASOLINE.

### FORD DEALERS:

Every man in your town needs a THERMO SHUTTER. You don't have to sell it - it has so many 'doggone' good points that ALL YOU DO IS SHOW IT. Your initial order should be for a carton of 12 and prompt delivery will put you in the running for a good early Fall and Winter business.

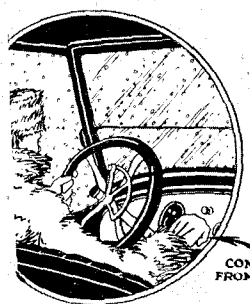

Order NOW and Give Us the Name of Your Jobber.

ESSENTIAL AUTOMOTIVE PRODUCTS CO., Inc.

507-511 West 42d Street

New York City

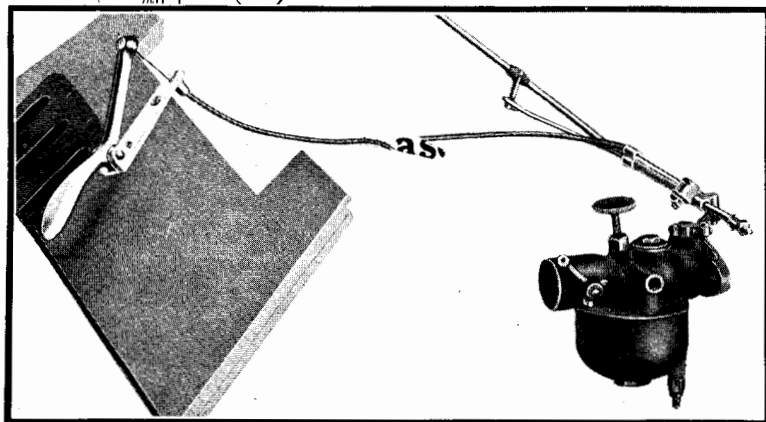
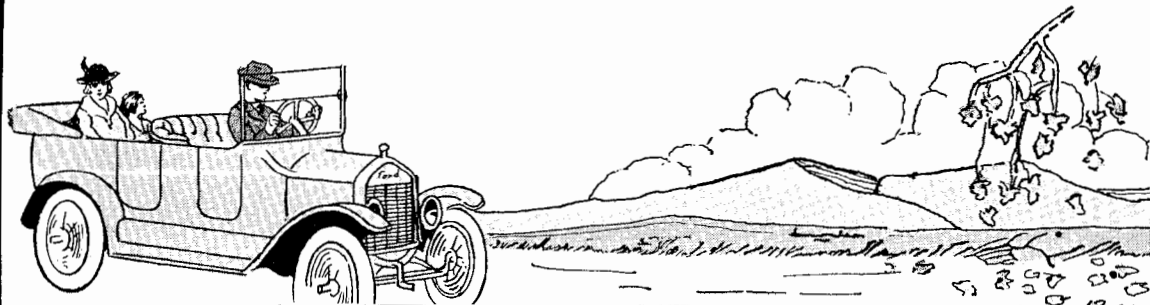

# Price and Performance

The Williams Accelerator is made to give year after year of uninterrupted service. Every ounce of material in it is tested. Every adjustment is made with mathematical precision. Every finished accelerator is as mechanically perfect as an airplane part.

Consequently, the price of the Williams Accelerator is somewhat higher than that of an ordinary Ford foot throttle. If we made it to meet the average price, it would be only an average accelerator.

Yet the difference in price between the average foot throttle and the Williams Accelerator is not great. You pay only a little more. But you get an accelerator that is absolutely dependable — guaranteed so.

RETAIL PRICE  
**\$3<sup>00</sup>**  
 AND WORTH IT

The Williams Accelerator can be installed in seven minutes; removed and replaced in a few seconds without readjustment. There are no complicated ball

socket joints, no intricate levers. Built like a spring, it is proof against vibration, a prolific source of trouble among foot throttles whose parts are rigid. Nothing can work loose. The flexible cable permits such smooth, even acceleration that a foot rest is not necessary.

A Ford foot throttle is not an expensive accessory. You can afford to buy the best.

Ask your dealer to show you a Williams Accelerator. Jobbers, write us for complete information and samples of dealers' help. A post card, mailed today, will bring them promptly.

WILLIAMS BROS. AIRCRAFT CORPORATION  
 SAN FRANCISCO



## WILLIAMS ACCELERATOR

*for FORD CARS*



If your magneto is weak, a set of six dry cells will last you a long while for starting purposes. However, it is advisable to get it repaired at once, especially if your engine has not been overhauled for several months, and the bearings are in need of adjustment.

A low ampere reading indicates a shortened, or ground magneto coil, while a low voltage reading shows that the permanent magnets are demagnetized.

Hard starting in cold weather is often caused from the motor being too stiff to spin. If your bus is equipped with an electric starter and, on cold mornings, it is sluggish in action, look out. If you insist on using it, this means battery trouble.

This stiffness, or drag, is caused by oil congealing in the clutch. Or it may be that the latter does not throw out properly. The use of very light engine oil, and correct adjustment of the clutch throw out, will overcome the biggest part of this difficulty.

There are a number of other things that cause hard starting such as, poor seating valves, and stems worn so that they permit extra air to enter the cylinder, making correct adjustment of the carburetor impossible.

Extra air may be getting into the cylinders from other sources, defective gaskets and the like. The pistons rings may be faulty. There may be loose connections in the wiring, and so forth. But keep this in mind, "There's a reason".

Your Ford should start easily and patience, plus persistence, will bring about the miracle. Those holding the seats of honor will now please rise, and repeat,

Crank a while, smile a while  
Spin her 'til you're bored  
Glide a mile, start to smile,  
At your stubborn Ford.



### *Ford Heads Relief Work*

Here we see workers of the American Relief Administration entering Soviet Russia at the Latvian frontier. These relief workers found many difficulties in attempting to aid famine stricken Russia and were required to do some real thinking to overcome their difficulties. We believe that they were quite cap-

able of proper thinking, however, for you will note that they have called to their aid the one reliable ally whose very appearance has come to suggest not only a willingness but an anxiety to aid. Will someone kindly tell us how the world ever progressed before there were Ford cars?



## *Ford Prominent At Elks Convention*

We are told that the familiar initials B. P. O. E. stand for the phrase "best people on earth."

Judging from impressions of the members of the order of Elks whom we have met, we would not be inclined to dispute the propriety of this phrase. At least we are ready to state that the Elks constitute a very sensible group of persons, and we base this entirely upon the

choice of cars which they made to aid them in their recent convention at Los Angeles. The pictures above show that the parade which the Elks held at the convention was made sure of success by the fact that they selected the B. V. O. E. which letters stand for the words "best vehicles on earth," and this requires no further translation for you know that we refer to the Ford and Fordson.

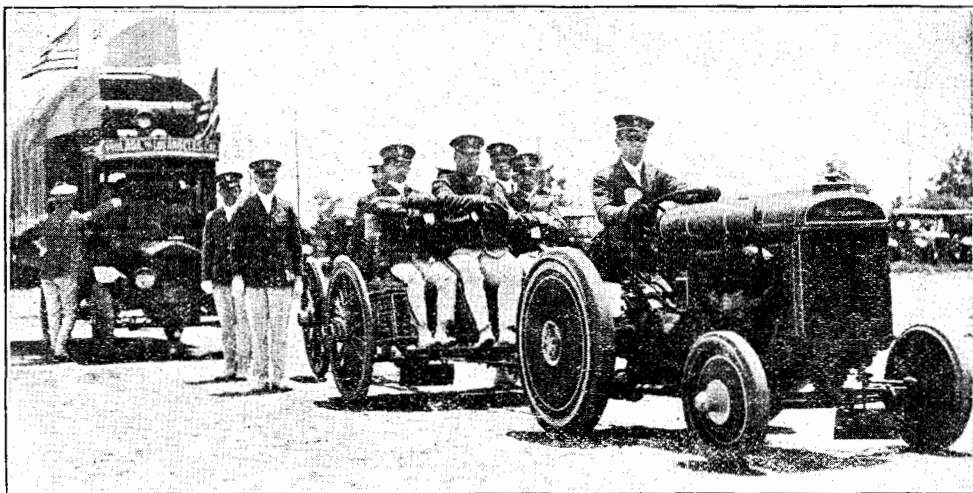

## *Neither Does A Mule*

By Walter Swetnam

The Ford's a homely little car,  
No other quite its place can fill.  
It stays at home or travels far  
But ne'er "takes second" on a hill.

The Ford makes no pretense to art;  
It's not decked out in flounce or frill.  
It never fails to do its part;  
It won't "take second" on a hill.

Some cars may pass it on the road  
With warning signals loud and shrill;  
But still remember that the Ford  
Will not "take second" on a hill.

The Ford can many cares erase,  
And many a heart with rapture thrill.  
No other car can take its place;  
It can't "take second" on a hill.

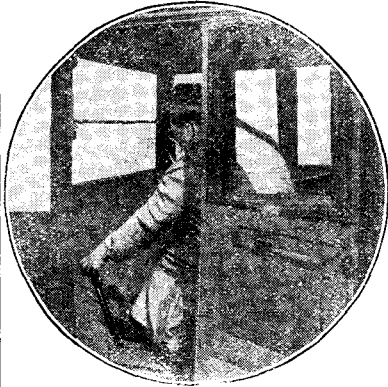

LONG REACH



WITHIN REACH



THE REASON

# REX EXTENSION HANDLES

for  
**FORDS**

**PRICE**  
**\$2.00**

*“Once Used  
Never Discarded”*



**T**HIS is a Safety First Device. It places the brake lever within easy reach of the operator. Also makes Ford driving a pleasure, especially during Winter months when the cold weather necessitates heavy bulky clothing and the use of a robe.

Write for our illustrated folder which describes the comfort and safety of the Rex Extension Handle.

If your local dealer cannot supply you, we will ship by parcel post insured, to your address anywhere in the U. S. A. for \$2.00 and will refund you the price if not satisfied.

**AJAX AUTO PARTS CO.**

RACINE,

Dept. B111

WISCONSIN



### VACATION DAYS ARE OVER

What have we here? Nothing less than a portrait of our mutual friend, Murray Fahnestock, technical editor of FORD OWNER AND DEALER, and the man who answers all of your queries. By this we mean all of your questions as to the Ford car, though we do not doubt that he, being a bachelor who frequents social circles, could answer vexing problems and give advice to the lovelorn, if he had the time.

However, you readers keep him so busy responding to your letters and writing his well-known articles that he has but little time to do anything else. In spite of this he managed to take a vacation at a summer resort during the past summer and spent most of his time surf bathing as well as engaging in that always pleasant task of teaching the art of swimming to young ladies, who have been successful pupils each consecutive summer. The smile which Mr. Fahnestock wears is due to one of two reasons: Either some ladies were just tripping into the surf to join him in a swim, or he is possessed of a contented feeling to think that he is able to be of assistance to our many good friends, the readers of this magazine.

## To A Ford

Derned old Lizzie, standin' out  
By the gate, jes seems to shout:  
"Welcome" to the whole cahoot  
O' our folks, dog to boot.

★  
An' old Maje, jest layin' sprawled  
Waitin'; we ain't never called  
Him yet when we're a-goin'  
'Tain't no need; he's jest a-knowin'.

★  
Lizzie, she jest puffs an' snorts.  
All the kids yells an' cavorts;  
Maje, he barks, Ma, she chuckles;  
Me, I'm cranikin'. Then we buckles.

★  
Derned old Lizzie! Settin' out  
By the gate. Jest seems to shout  
"Welcome" to the whole cahoot  
O' our folks, dog to boot.

Down to goin'. Lord, old Lizzie  
Travels till she makes us dizzy.  
We ain't carin'. We jest revels  
In passin' folks. Poor slow devils.

★  
Settin' up in sech grand style;  
We can hit a couple o' mile  
While they're turnin'. Let 'em take  
Our dust. We'll make

★  
Miles o' real, downright joyridin'  
While we're out. They hain't no hidin'  
The fact that Lizzie's some hot skeeter,  
On the goin'; you can't beat her.

I. W. M.



Fully covered by  
Patents of Dec. 19, 1916  
and patents pending.

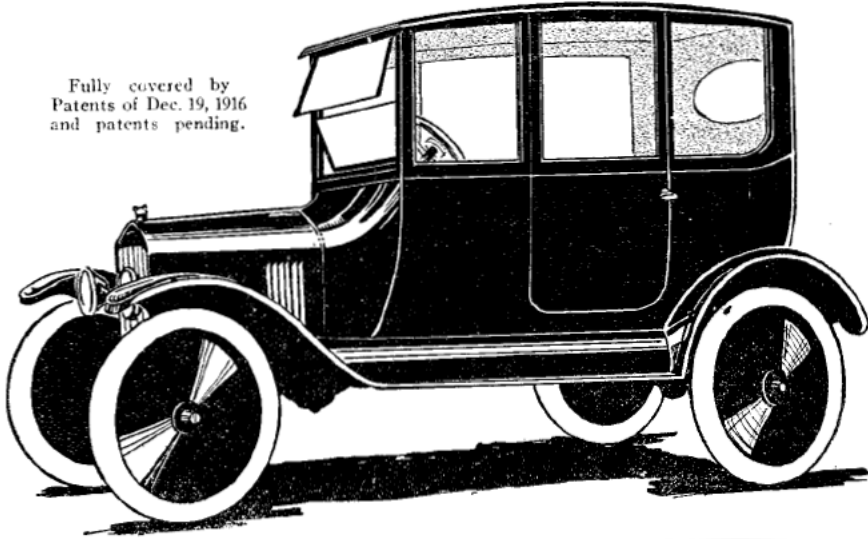

# Turn Winter Into Summer In All FORDS



### Dealers

The Arvin Heater is simple and quick to install. It will mean many satisfied customers for you. The dealer profit is liberal. Practically any jobber can furnish you with Arvin Heaters for both Ford and Dodge cars.

Make driving a year 'round pleasure. Use the Ford in the coldest weather with the warmth of a June Day inside.

Every Ford, the style of body matters not, should be equipped with an Arvin Heater for real warmth and comfort.

The Arvin is a hot-air furnace for your Ford. It catches the radiating heat from the exhaust and carries it back into the car. No mechanical change is necessary to install it. Anyone can attach it in less than 20 minutes by following the instructions packed with each heater in its individual carton.

An Arvin Heater would be comfortable even during these fall days. Better drive in and get yours today.

## \$3.50 Complete

Your Dealer Has or Can Quickly Get

Arvin Heaters  
Are Built for  
Dodge Cars,  
Also

# The ARVIN HEATER



THE ARVIN HEATER COMPANY, Indianapolis

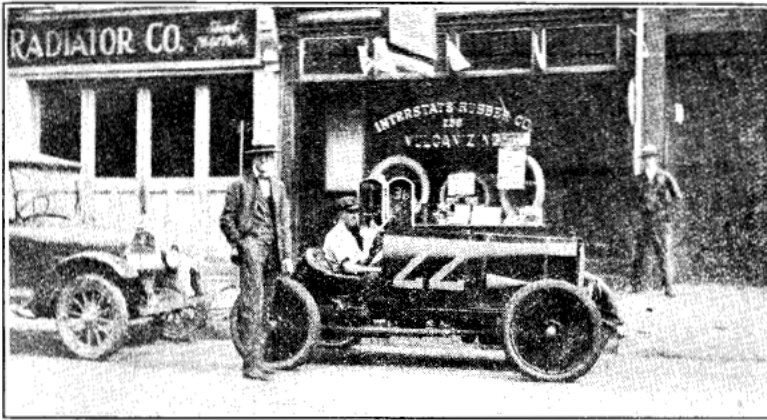

## Ever Heard of Ray Hazen?

### He Runs a "Circus" to Advertise Sale of Ford Cars and Other Stocks in His Business

NOBODY who sells Ford cars in Philadelphia, or elsewhere, so far as is known, does it in the odd manner of Ray Hazen, racing man and shop owner. He and his assistant build racing cars and race Ford cars at fairs throughout Pennsylvania, New Jersey and other States.

To advertise his stock, Hazen keeps about his place of business all sorts of animals—

wild and domestic, only not too many at the same time. One may occasionally find a bear or so in his shop; a herd of dwarf pigs; a ring-tailed monkey or two; now and then a couple of alligators; a few Shetland ponies and almost invariably a family of waddling bulldogs.

"It pays to advertise," quotes Ray. And he does it in his own way.



### The Choice Of A Solon

Most of us are inclined to visualize the United States senator as a dignified silk-tiled personage who would consider it beneath him to ride forth in anything less than the most expensive limousine. However, we find that democracy, which is another word for

common sense, prevails among our highest law makers. Here we see Senator Seldon P. Spencer of Missouri ready to go motoring in his favorite car. You will note that his choice of conveyance is identical with your own.

# Release the STRANGLED POWER

With

## "Pyromite" All-Steel ADJUSTABLE Intake and Exhaust Valves

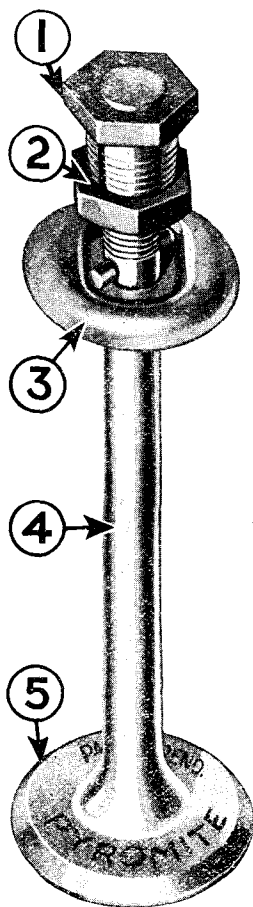

1. Slotted Adjusting Nut.
2. Clamping Nut.
3. Special washer which holds valve rigid when adjusting.
4. Highly Finished Stem.
5. Ground Seat.

We also make Pyromite Valves for Fords in standard and 1-64" over-size stems without adjustable features. These valves are highly finished, unbreakable and resist pitting. Prices on request.

**N**O ENGINE will develop its full power unless the intake and exhaust valves are snugly seated and properly adjusted. The Ford engine is a good engine. But there is no provision for adjusting the intake and exhaust valves. There is no way to take up the unavoidable play caused by wear of cam shaft, bearings, tappets, and mush-rooming of valve stems—unless equipped with Pyromite All-Steel Adjustable Intake and Exhaust Valves.

Ford valves should have a lift of exactly  $\frac{1}{4}$  inch. A matter of  $\frac{1}{16}$  inch excess play between your valve stems and tappets (common in much-used Fords) reduces the effective lift one-fourth, resulting in a power loss of from 25 to 60%—power that is strangled by delayed closing and opening of the valves. Pyromite adjustable valves will enable you to release this power—give your Ford its full power.

This all-steel valve, made of special alloy heat-treated steel, is easily adjusted, insuring proper timing of valves at all times, resulting in 100% power efficiency from the motor.

Price per valve, standard sized stems, 75c.

Complete set of eight, \$5.00. Price per valve,  $\frac{1}{64}$ " over-size stem, 90c. Complete set of eight, \$6.00. Packed in cartons.

### DEALERS AND JOBBERS

Every Ford owner is a logical prospective purchaser of Pyromite Valves. Order your initial stock NOW and be prepared to meet the demand.

WRITE FOR DESCRIPTIVE PAMPHLET

ADDRESS: DEPT. E,

## Steel Products Mfg. Co.

RACINE, WISCONSIN.



# TRACTOR DIVISION



## *Another Job For The Fordson*

Putting a Fordson to unusual uses is not an unusual thing for Boulware H. Jameson of this city, dealer in Fords and Fordsons and his most recent stunt was to drive a Fordson into the main floor of the Fulton Laundry and run the plant while repairs were being made to the operative end of the plant.

The concrete base that held the engine of the plant broke down and it appeared as if the company would be compelled to tell the Fulton folks that they would have to run around in their dirty clothes for a week or so. Jameson heard of the breakdown and decided that as cleanliness was next to Godliness it was his religious duty to see that something be done about the wash day morals of the Fulton people.

He offered to send a Fordson down and run the plant. The Laundry management said it

could not be done. Jameson offered to give her a whirl and was told to bring along the Fordson. It took hold of the load and handled it with ease for more than a week while the necessary repairs were being made.

Only recently Jameson sent some Fordsons to the north end of the county in the wheat belt of the Kingdom where they helped thresh the largest acreage ever put in in that section of the county.

Still on another occasion the city streets of Fulton were filled with snow more than a foot deep. The city department was unable to move it with the aid of teams and a specially provided snow grader. Jameson brought out his Fordson, hitched it onto the snow grader and it took the snow off the street with neatness and dispatch.

### SETTING CUT-OUT

The cut-out on the generator will not allow it to charge at a greater rate than 7 or 8 amperes—regardless of engine speed. Could this cut-out be set to allow ammeter to register 10 to 12 amperes, in accordance to instruction book on starting and lighting system.

The cut-out does not have anything to do with controlling the RATE of flow of the current from the generator. If you clean the commutator and brushes of the generator, and set the THIRD brush of the generator; this will enable you to secure the correct 10 to 12 amperes, without touching the cut-out. Better check up with another ammeter, to make sure the ammeter registers correctly—before changing the generator.

*Here's what you've been asking for*

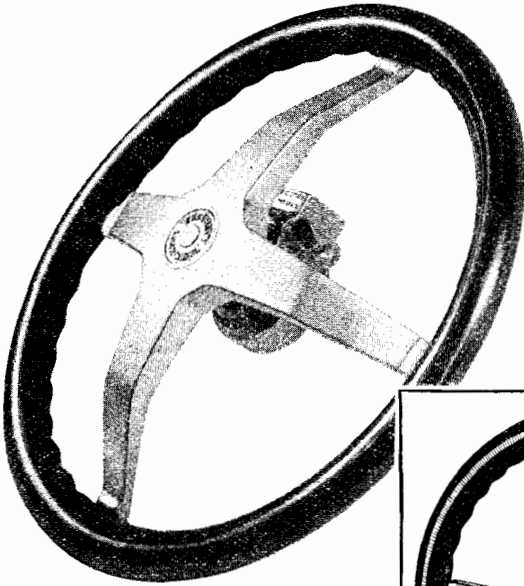

*Notice the four uniform sturdy spider arms, graceful and strong*

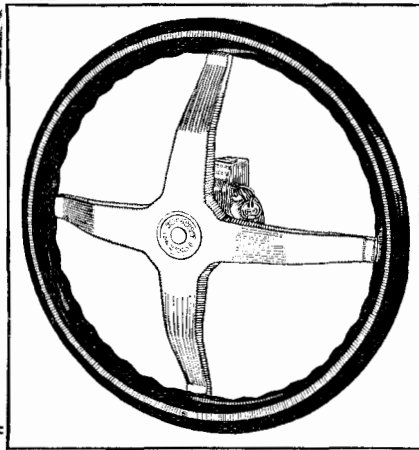

*The New Security Auto Lock Complete with 17 inch Corrugated Walnut Rim!*

Ford dealers and owners who have seen and installed this NEW Security Lock say that it is the best lock, most positive, fool-proof and thief-proof, yet the easiest to install and best looking lock they have ever seen.

**A REAL MONEY-MAKER**

By comparison, this lock appeals to the car owners. When they see it in your show-rooms, side by side with any other lock wheel, they'll say, "Give me the Security." And you'll make as much or more money selling the Security. It is easily installed in five minutes—no cutting, drilling or tapping.

**THE NEVER-FAILING LOCK**

If you have ever used the Security "cap" lock, you know it never gets out of order or fails in its duty. Your experience with this new complete Security lock, with beautiful polished, corrugated 17-inch walnut rim, will be even more pleasant and more profitable.

**TO FORD DEALERS**

We want you to examine this superior equipment. We will ship you a complete Security lock (as pictured) on approval, charges prepaid. Examine its construction—install it—show it to your customers. Then you will understand the preference of both dealers and owners for the Security Lock. List price \$15.00. SEND FOR YOURS TODAY.

**SECURITY AUTO LOCK COMPANY**

410 N. PAULINA ST., CHICAGO  
APPROVED BY UNDERWRITER'S LABORATORIES

*The Original Loose Wheel Lock for Fords*

When writing advertisers—Just say FORD OWNER AND DEALER

# Home Made Tractor Improvements

By F. N. Siegfried.

**T**HE standardized Fordson tractor does not seem like one's very own—unless some changes and additions are made to it. And there are many fittings that can be made at home which will add to the comfort and utility of the Fordson tractor.

One of the first things that one discovers is the small size of the tool box furnished with the tractor, and this box is only about large enough to carry a hoboe's money. Evidently,

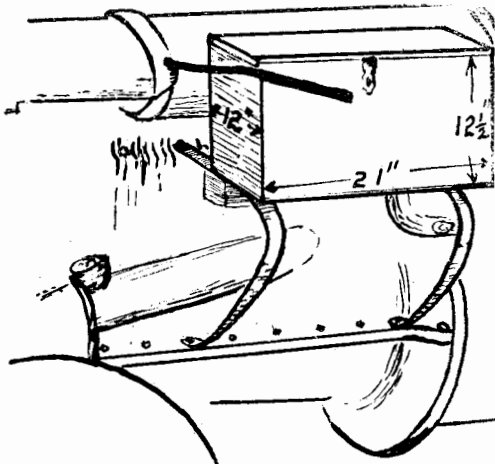

Equipment Box

the manufacturers do not expect one to have much trouble with the tractor in the field, and think that a tiny tool box is large enough. But how about the other implements drawn by the tractor—which often require the use of tools and equipment to make the necessary adjustments and repairs?

In order to increase the luggage carrying ability, I have made a tool box of hard-wood, 12 inches wide, by 12½ inches high, and 21 inches long. This box is supported by two brackets made of flat wagon tire steel, about 1¼ inches wide. These brackets are attached to the cylinder head bolts at the top, and to the crank case bolts at the bottom. There is also a brace, fastening to one of the fuel tank bolts.

In addition to a set of dry batteries (for easier starting), the box contains three one-gallon cans for gasoline, cylinder oil, and water for the air washer—thus eliminating many useless trips for these sometimes needed supplies.

The second sketch shows the manner in which I have fitted a spot-light to the tractor. The bracket should be made of either ¾ inch or ½

inch pipe, about two feet long. This pipe is supported by two brackets, bent from flat steel and fastened to the dash. The upper bracket has an adjusting screw with a knurled head, which can be turned by hand so the spot-light and its bracket can be lowered down out of the way when the tractor is driven under the trees in an orchard.

In order to hold the starting crank up out of the way, when driving through brushwood, a wire can be fastened to the nut that holds the right-hand front corner of the fuel tank, and this wire attached to a hook made of ⅜ inch steel rod.

This hook should be looped over the starting crank as shown in the sketch, so that if the tractor is driven into the brush, and the starting crank handle forced inward and caused to turn around; the handle will slip out of the steel hook, and not cause injury to any of the parts.

If one places a three-way cock on the carburetor and connects this to the gasoline tank, then one can start on gasoline. And if one only intends to run the tractor for a few minutes, it can be run on gasoline and there is no danger of burning out the vapor tube. A priming cup can be placed where the gasoline pipe is connected to the intake manifold. In cold weather,

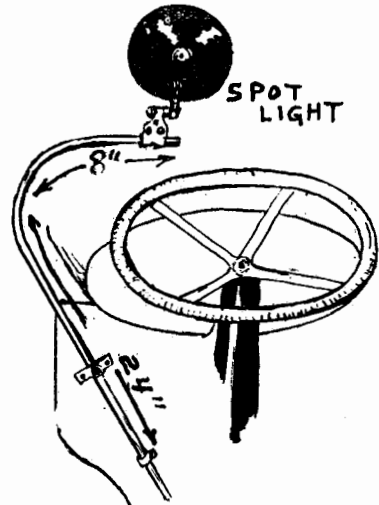

Spot Light Bracket

the engine can be primed with one part motor-ether, and four parts gasoline. Then, with the clutch out, it will start the second or third time the engine is cranked.

In order to hold an umbrella over the driver, a support can be made from a piece of 1¼ inch wagon tire, one end of which supports the lower end of the umbrella handle. The upper end of

# A High Grade Radiator

Reasonably  
Priced For  
Ford Cars

Genuine G & O diagonal honey-comb core; tanks and core of brass throughout; seamless one piece bottom tank; side piece and support for top tank extension all one piece. As "freeze-proof" as can be made.

The price is right.

Ask your jobber.



**G&O**  
Radiators

*Designed  
for Ford Service*

**JOBBER:** This is the first time a really high grade radiator for Ford cars has been offered to the jobbing trade at a competitive price. Write us today.

- Model "A" Radiator  
Black Enameled Steel Shell
- Model "A" Radiator  
Nickel Plated Brass Shell
- Model "C" Radiator  
Finished in Polished Brass
- Model "D" Truck Radiator  
Cast Tanks, Multi-tube core

**THE G. & O. MANUFACTURING CO.**

NEW HAVEN, CONN.

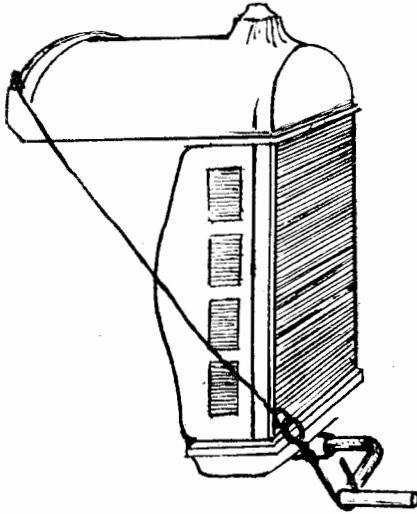

Starting Crank Holder

the wagon tire is fastened under the seat spring. The other support for the umbrella is

made from a piece of 2 by 4 inch lumber, with a hole bored for the handle of the umbrella to pass through. By having the umbrella fastened entirely to the seat in this manner, the umbrella moves up and down with the driver. And I have found this to be more satisfactory than fastening the lower end of the umbrella to the rear axle housing.

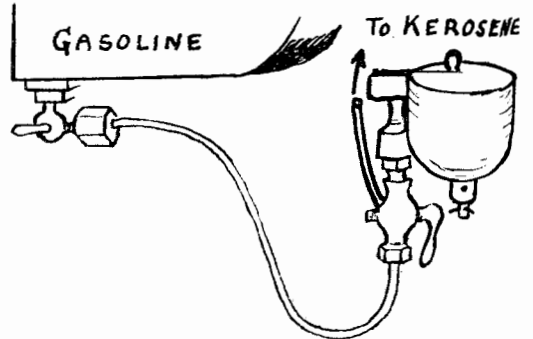

Easier Starting

## A Fordson Tractor Operated With New Fuel Process

**V**EGETABLE charcoal and water are to substitute gasoline and kerosene as a motor fuel. An Australian has invented a "suction gas producer" which after improvement by an American firm in Manila has proven practicable for tractors.

The kerosene equipment was removed from a Fordson tractor and the new invention substituted in the nature of a fire-box in which ordinary charcoal was burned, the resultant gas being drawn into the engine in the same way as a mixture of kerosene and air. The small amount of dust present in the gas was removed by moistened surfaces in the "scrubber".

The demonstrators were able to start the tractor within five minutes without other fuel than the gas itself. To do this it was only necessary to place a little waste and charcoal

in the charcoal cup at the bottom of the producer and fan it until the charcoal was glowing. Sixteen kilos of charcoal were then placed in the producer, and a few minutes later the engine was started. The inventor claims that eighty kilos of charcoal will furnish gas for a tractor pulling two disk plows, for ten hours, and replenishing the charcoal at the end of each two hours run requires five minutes. When one considers the cheapness of this motor fuel, the importance of the invention is at once apparent.

Private advices from Manila state that the demonstration was a complete success and should the practicability of the invention be proven by time, a better day may be dawning for those faraway places without a gasoline and kerosene supply.

A responsible Manila firm has purchased the manufacturing and selling rights for the Philippines, a fact that appears to remove the "suction gas producer" from the realm of doubt.

### EXPERIENCE TEACHES

"Why didn't Morton marry the widow he used to go 'round with? I thought he was crazy about her."

"He was. But that was before he bought a second-hand car!"—L. M.

### THE MODERN WAY

"There's a fellow outside looking for trouble."

"Strutting around the street with a chip on his shoulder, is he?"

"No—he's crawling under a car with a monkey-wrench in his hand!"—L. M.





# CLEAN SPARK PLUGS

## On "Oil Pumpers" GUARANTEED!

SEE COUPON BELOW

**D**OES your engine keep missing because of dirty spark plugs? It only takes five minutes to overcome the nuisance of continually cleaning or replacing spark plugs on oil pumping cylinders by installing a set of

**Gemco**  
MILWAUKEE  
TRADE MARK

## BAF-OIL PLUGS

### *Sold on Money Back Guarantee*

A scientific but simple device with no moving parts to get out of order or require adjustment.

Two baffle plates cast into each BAF-OIL PLUG, prevent oil from reaching spark plugs. When the spark occurs, the perfectly vaporized gas in the BAF-OIL PLUG ignites and shoots into the cylinder proper. This causes a clean sharp explosion which increases the power of the motor and reduces carbon deposit.

**Ford Size—\$4.00 a Set**

DEALERS AND JOBBERS—Most every owner of a Ford pleasure car, truck or tractor is a prospect for Baf-Oil Plugs. Write for attractive sales plan.

**GEMCO MFG. CO.**  
750 So. Pierce Street,  
Milwaukee, Wis.

TRIAL ORDER AND GUARANTEE  
GEMCO MANUFACTURING CO.,  
750 South Pierce Street,  
Milwaukee, Wis.

Dear Sirs:—

Enclosed find \$4.00 (check or money order) for one set of 4 BAF-OIL PLUGS for Fords.

I am ordering these Plugs with the understanding that if they do not keep spark plugs clean, lessen carbon deposit, and increase the power of the motor, my money will be refunded.

Very truly yours,

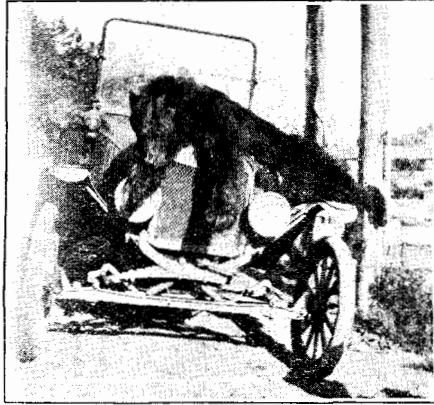

## Henry And The Three Bears

By S. Omar Barker

**T**HE first bear was the one whose picture appeared some time ago in Ford Owner as the travelling companion of Col. Idaho Bill. This one is number two—the middle sized bear that wept for more cows to kill and wound it all up by going to his own funeral in a flivver. The third of the Bruin Trio hereinbefore appearing in the title is the one Henry and I plan to get next time we go out.

Those who saw the picture of Col. Idaho Bil.'s life size live one riding on the poop deck of a prairie Ford may erroneously suspect this one of being the same animal after three months travel in a flivver. Not so, friends—Romans-and-country-fellers. Bears aren't as easily shaken to death as us humans. The last I heard from Idaho was that this Bruin had lost his teeth from the vibration but was otherwise in good health and eatin' on all four cylinders.

This one is just a nice fat old cattle thief that Henry and I trapped and hauled in from the mountains one Sunday. How did we kill him? Well, believe it or not, as you please: Driving along the road I happened to notice fresh bear tracks heading into a thicket. I turned my headlights that way and turned the lights on. The time was broad daylight but when my Ford lights into action Mr. Bruin thought the moon had come up and immediately got out and started foraging. Taking a piece of fat dry salt pork from my hip pocket I placed it on the end of my muffler and started the

engine to idling. Now bears like to eat hornets and yellow jackets and bees and are especially fond of honey, so when my friend heard the engine he thought he'd found a bee tree and came ambling up. As he drew closer I speeded her up a bit until the noise was like the quiet contented grunting of a three months old pig with his nose in buttermilk and his back in the hands of a first rate scratcher. This fit in better with the smell of pork and bruin came on like the charge of the light brigade. Then by carefully timing myself to keep just ahead of him I managed to start a race the like of which you never saw, even in a Mack-Sennett comedy, where bare races are the principal amusement. In the course of a few miles my follower grew so weary that he dropped in his tracks with a sigh that made me get out and examine my tires.

Poor old duffer! There he was all winded and panting on the ground. As rapidly and as humanely as I could I backed up until my carburetor was just over his head. Then I drained it and drowned him with gasoline!

I have hunted bears in many ways, but this method has 'em all skinned ---- er ---- I don't mean it skins the bears, yonnerstan; that is another story.

P. S. — If you don't believe this, here is the picture, and I can even show you the blood on my flivver!

### THE STENOG'S VACATION

My tYpust is on her vacatoin,  
My trpist's awau fpr a week,  
My typudt us in hwr vscaion  
Wgile thse danm weys plys hyde  
and seej.

### CJORAS:

Oy, breng boxk, bting bxck,  
Brung becj mu tyPust ti my, tp mr;  
B/&ng b\$Xj, b6ng bicx,  
Bjing bozk m% trpust t—oh helk?&!!!



### *Shirley Shines Up The Car*

Perhaps you think you know how to clean the family Ford, in preparation for rubbing fenders with its more aristocratic cousins, the Packard and others on the Sunday tour of the boulevards. Furthermore, your method may be fairly good, but Shirley Mason, the little "movie queen" has her own system of cleaning the car. We believe that Shirley must have had the benefit of some good, old fashioned domestic training, for you will note that she employs the familiar household broom and makes a clean sweep of the job.

Shirley is very fond of her Ford Sedan and

would employ only the best methods in caring for it. The moral, therefore, may be that the broom is the proper implement for thorough cleaning, although we imagine that the average Ford owner is hardly enough of an acrobat to be able to hop up on the car hood with the ease which is said to characterize Miss Shirley's car cleaning operations. It is our guess that the Ford Sedan does not in the least mind being walked upon by such a charming little person. Funny, isn't it—how a pleasing little feminine personality can get away with most anything with a car or the average man?

# Motorist, Repair Thyself

By Alfred Cadwalleder

"I believe," said John H. Divining, "in motorizing the city and also the farm, but I don't believe in motorizing women folks."

"How come women are not included? We men have uplifted them from the cavewoman stage; why not take 'em a little further while we're about it?"

"They don't know anything about the finer qualities of an automobile; don't know that a car is a delicate piece of mechanism like a clock or a watch. They think it is a tin boat on wheels, a lifeless thing of iron, designed to uphold the weight of fine clothes and furs and children."

"Well, a car ain't exactly alive, is it?"

"No; but I treat mine like it was. It pays in the long run."

John H. Divining was in the heyday of his life; his comely wife would have been in hers only he was selfish with the car; and his Ford was just entering upon its heyday. While mentioning it, this heyday business reached to our old Earth, a fact that must have had something to do with what happened. No planet that we know of, other than our Earth, has life upon it. Some of our stars are too hot for life, several thousand degrees Fahrenheit and a few hundred legs Centipede. Think of a Ford on that kind of Earth. The car would overheat in ascending an ant-hill three quarters of a foot high and before going a yard the radiator would be screeching at every joint like a steam calliope. The molten pavement would vulcanize the tires to a beautiful cinder with one full turn of the wheels. Within half a block the driver would be crawling up the exhaust manifold for the cooling breeze. But let us not dwell long on such a planet; it is too much like the place many reckless Fordists will skid into some day. A cold planet should be a welcome change. For instance there are some too cold for comfort, frozen down to absolute zero, all liquids congealed. Think of it, melting ice every morning for the radiator, all the atmosphere liquid air. And there it is again, gasifying enough for the fan, besides the problem of carburetion.

This brief exploration of the orbs of heaven brings us back to our good old Mother Earth, the only place science recognizes as being fit for the existence of living beings and Fords. But science does not know how life got here. It presupposes it started spontaneously, that is, something up and came to life. And science usually is right. And if life started spontaneously once, it could do so again.

Among the comfortable earthly things we find John H again. The capacity of John H's garage was 20 by 24 feet and it contained one Ford; the capacity of his cranium on homebrewless days was still above the mediocre and

contained enough gray vulcanizing stock to patch a blowout if it were not too big. The capacity of his—every Fordist has a third capacity, whether it embraces anything or not—emotions was illimitable and gyrated around the desire to make his Ford the one perfect car. Pride? He was as jealous of that car as a hen is of a brood of one chick. He polished it by sunlight and marveled at the changing colors as he rubbed its glossy sides by an electric "glim." For fear it would develop gallstones he gave it rainwater to drink; and in constant dread of fibroiditis or mumblemonia he strained out all germs the size of tadpoles. And Ford books and magazines! Why, the man had a whole library of literature designed, innocent of conflicts and contradictions, to prolong the life of a car indefinitely and make it a thing of perpetual beauty. If a man would study the health of the human body with half the persistence John H Divining did that of his car he would either die within a month or live until a Methuselah would not seem cradle wise.

In operation the car glided miraculously somehow like a swallow remaining close to the earth. It could not be termed a Flivver or a tin Lizzie. You could not hear a rattle, not even the chirping of the coil boxes. That is, it did all this and you could not hear all this and—oh, well, the car was human after all. One day it developed a disposition to knock. Adjuration, threats, and pleas did no good. Even a trip to church where it stood parked outside an open window did not bring about a repentance. It knocked going home.

John H saw now that he had concentrated too much on the original Ford; he would go in for accessories. He tried all the practical things, shock absorbers, counter-balanced crank shaft, double wish bone, disc wheels, no-chatter brakebands, and dozens of others and experienced so much satisfaction from their use and the improved car that he advanced from the practical line of accessories to the mysterious, the things that are extensively advertised but not understood by the Fordist. The appeal these little understood things made grew upon him. His Ford improved with the magneto transfusion with a Rolls Royce, the use of counter glance headlights, and the installation of spontaneous combustion chambers. Not content John H now entered upon the occult. Right here he went a step too far. His study and explorations brought him to introduce what is now known among motorists as wind-shield crystal-gazing. He had not thought of the millions of primitive life cells, amoeba or the like, and how somewhere sometime past they had gathered together in a conglomerate mass and produced the first of the race of

mankind. He had not thought of the millions of Fords and of the tens of millions of Ford accessories and how the chances were good that somewhere sometime a bunch of the accessories applied just right on a car would produce, under the incubation of wind-shield crystal-gazing, the Ford come to life. And that that would happen with his pet car was past his investigations in the occult.

The first John H knew of it was when he was motoring down Twinex Avenue and having all kinds of worry over his car's firing order. He had set the dial on the spontaneous combustion chambers to fire the cylinders one, two, four, three; and the order had promptly changed and followed all the other possible variations. He could not understand it. Except for an occasional one-step the car ran very well; but the trick weighed upon him. He tried wind-shield crystal-gazing until his brain, functioning like a siphon cooling system, guided him towards a friend in the country who kept home brew. Turning in at the gate he stopped before a small creek the bridge of which had been washed away. The house was back in the fields; he got out, jumped the creek, and started to make the rest of the distance on foot. He had gone perhaps a hundred yards when, happening to glance back, he beheld that which caused his hair to stand on end and vulcanized him in his tracks. To his horror, there was his Ford approaching in an uncanny manner; it also had jumped the creek gully; it was creeping upon him stealthily like a giant tarantula upon its prey. Its headlights glistened, its gait was a running walk; its tires pulsated snakily with life. It was a fearful thing but hardly surprising that one Ford had come to life. Creeping close it demanded,

"Why are you going in here?"

"Eh-er-uh, to see Billy Bluey." John H's words were imbued with a guilty tone.

"And what do you want of him?"

But John H, with a loud cry, bolted. In a flash, however, the car had sprung upon him. He begged for mercy.

"What do you want of Billy Bluey?" the Ford repeated. The demand was a growl through the radiator.

"Going to get some home brew of him."

"No you don't. Wind-shield crystal-gazing is all you can stand up under at one time. Hop onto the running board."

John H started to get into the car. But he no more than touched the door lock when the near fender grabbed him by the scruff of the neck and set him down hard upon the running board as a forward dog might be treated. John H, a bit dazed, sat there, while the car gathered headway.

"You are a stingy sort of driver, aren't you?" the car asked scornfully of the man. "Never let your wife or kids go out."

"Wife can't drive and the kids muss things up."

"And you perfume things with cigars and home brew. I'd much prefer them. Then once you growled a month because your wife broke a twenty cent headlight glass."

John H's courage seemed to rally. "If I had you by the throat-throttle," he half whimpered, "I'd choke the mag out of you."

"Oh, ho!"

John H now became really angry that his pet car should treat him so. He started over the side for the seat. The door flew open and pinched his foot; the steering wheel reached out and sent him sprawling into the dusty road. The car stopped and immediately straddled him with all four wheels hissing and throwing dirt. When he crawled out he slunk to the running board like an obedient dog.

"Pep up; we're going back to town," sang out the Ford.

The car jolted the tortured man, swayed about, leaped gullies, forced him to hug the side like a Scotch collie for dear life. It miserably rided him in town at a mile a minute ahead of motor-cycle police. It skidded to the gutter, put two side wheels on the edge of the curb for a purchase, and leaped sidewise back into the street, to the astonishment of passers-by. How John H ever clung on he did not know. In fact he failed to do so once. The car stamped a flock of pedestrians, plunged through a fence, spilled him into a mud puddle, then calmly waited until he crawled back upon the running board in the nick of time to escape excited traffic cops.

Eventually the car eluded the frantic police, droned merrily down a boulevard, reversed its license number, and stopped before John H's home, where it lifted him off by the scruff of the neck.

"Send the wife out," it ordered as it released him.

When she had gone John H laughed long and loud; the joke was on her. A neighbor called over and asked whether he had discovered a new accessory for his car or swallowed a lucky bug. John H quieted down, lit a cigar, stretched himself out on the shaded porch hammock, and chuckled once a minute for two hours, while he imaged his wife handled by the scruff of the neck and ridden all over town on the running board. Finally he heard the car return. Filled with exultation he wondered if he should go out and carry wife in. Then, surprised, he distinguished her light step on the porch.

"John," she said, presenting a radiant face to him. "I can drive a car as well as anybody. I made our Ford start like a quail and run like a humming bird."

"It didn't jump a ditch or a fence with you?"

"What a simple question! I claim all the qualities of a good driver. I did ever so much better than if I had tried to drive with you along ding-donging the car's operation."

"Did you—er—wind—shield crystal-gaze?"

"Did I what?" On her superior height she froze astonished at the question that seemed to have the ring of occultism.

"Did you wind-shield crystal-gaze?" The car gets to acting funny sometimes when one does that."

"Oh, the wind shield!" She gave up the enigma to the question and interpreted it to suit the practicable. "I busted the wind shield out on the clothes line pole as I started. I expected you to growl about it."

"Darling you do me injustice; I wouldn't speak of such a trifling thing. I'm really glad it's gone. I can easily put in a tin one. Hereafter our car shall be just a common Ford and you may drive it whenever you like."

# The Golden Rule For Garagemen

By Glen F. Stillwell

SINCE El. Haynes constructed the first benzine buggy, the air has never been entirely freed of vile profanity. Nowadays an auto is about as uncommon a sight as an Ouiji board, or a bootlegger, and the number of expert auto repairmen in this, our country, has arisen to the almost unbelievable total of four hundred.

Now for the novice who aspires to win fame, and fortune in this line of endeavor, I have herewith, and viz, submitted the following rules.

Presuming that the reader has tacked out his shingle, "Autos repaired at small cost—to us," and your first customer has asked for an estimate on the cost of overhauling his motor. We would advise you never to give this information until you have scattered the in'ards of the towit motor about the floor as though it were passing the crisis of a slight attack of nitro glycerine. Explain, that the engine is suffering from a, gas attack, acute indigestion, and blind staggers.

After viewing the remains your customer may still retain sufficient courage to mumble, "How much?"

This is the psychological moment; give him both barrels.

If there is a slight, but persistent knock, or rattle in the motor after you have overmauled it, explain to the worried owner that the noise is due to end play in the cam shaft.

If the noise sounds like a gang of boiler-makers doing piece work with-in the engine place the blame on the cam shaft. In fact no matter what the knock sounds like blame the cam shaft, and tell the owner that for another forty plunks you will silence the "jazz" effect.

A simple method of removing a knock is to open cutout and retard spark. The knock will then immediately disappear.

In doing small maintenance work on motor cars with a high gloss finish, I, or rather we have found it fashionable among the best of regulated repairmen, to sprawl, or recline on the fenders, spit in the oil holes, drip shellac, and oil, on the cowl running boards, and hood.

In working on sedans, coupes, and all enclosed models, it is the custom to mark your initials in gear grease on the cretonne cushion.

## Cautious

By Lloyd Lenore

Elizabeth came into my life,  
 (Just at a time when I needed a wife!)  
 Elizabeth was a beautiful girl  
 With an innocent mouth and a hint of a curl  
 In her golden hair, and eyes of blue  
 That never revealed how much they KNEW;  
 With hands as soft as a Fairy's breath—  
 But I did not marry Elizabeth—  
 I KNEW HER PAST.

Another Elizabeth caught my eye,  
 This time a car that I went to try.  
 Elizabeth was a (much) used-car,  
 With a motor as smooth as a good cigar,  
 With a polished body and goodly top,  
 With the tires to go and the brakes to stop,  
 And the Salesman talked 'till he lost his breath,  
 But I did not purchase Elizabeth—  
 I DIDN'T KNOW HER PAST!

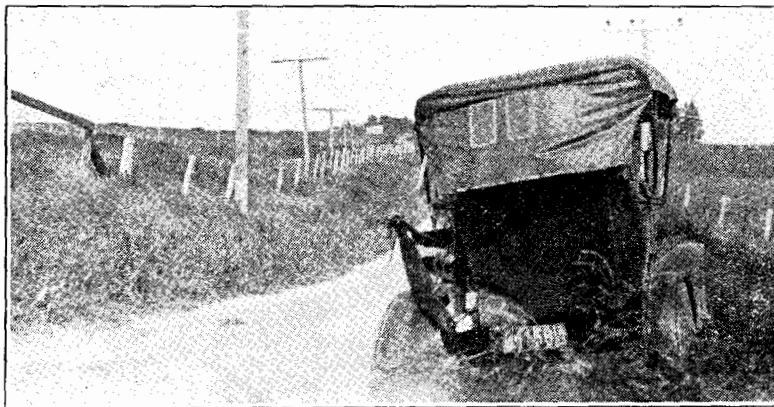

## Life Saving With Good Roads

By Florence L. Clark.

Why isn't the safety side emphasized more in the efforts to educate the public up to good roads?

The question came to me as we stopped the other day near the town of Postville, Iowa, to view the wreck of a Ford touring car. It lay close to the railroad crossing where it had been struck by a way freight the day before. A woman had been driving, and two other women and four children had been in the car. The pilot of the engine had struck the rear wheel of the car, pitching it and turning it completely over. Miraculously none of the seven occupants had been hurt except for a few scratches, though the car had been crumpled up to the extent shown in the photograph which I took as we looked at it.

People discussing the matter were trying to fix the blame on either the woman driver or the railroad for not protecting its crossing, but the fact of the matter is the accident was due purely and simply to bad road building.

The road from Monona, Iowa, to Postville is a part of the military trail built by soldiers

through northeastern Iowa in 1840. It follows a ridge, as early-day trains always did when possible, to avoid crossing streams. When the railroad was built 30 years later, the same line was followed. The road winds, while the railroad naturally was built as straight as possible. As a consequence, it crosses the highway seven times in seven miles. The road and railroad are so nearly parallel that it is extremely difficult for a driver to see very far in either direction, and even with more than ordinary caution an accident could happen; several have already, one resulting in the death of two. The road makes any driver nervous.

Turn such a road over to road engineers and make a real road of it, and the crossings would be for the most part eliminated and those that were left would have such approaches to the crossings that no driver using ordinary precaution would be in danger.

When we let scientific folks build the roads, instead of laying them out any way that is the easiest, there won't be so many accidents at country road crossings.

### WHAT'S A FORD?

By S. A. Chandler

What's a Ford, anyway?  
 A pile of rusty junk,  
 An imitation of a car  
 That's come in from a drunk;  
 The joke of every age and clime,  
 The butt of all the wags,  
 A bunch of rattling nuts and bolts  
 For making daily gags;  
 But say, you guys  
 Who think you're wise,  
 Did you ever see a mate  
 For taking hills or crossing bogs  
 Or skating on a lake?  
 And many's the time  
 You "cars" decline  
 To take a little hill,  
 Until they've caught  
 A length of rope  
 Behind a Fordy pill!

# News Notes From France

## SALES INCREASING AGAIN

One of the Ford Agents was good enough to invite me to go with him for a jaunt out Normandy way. It was remarkable what a quantity of FORDS we met! Sometimes we passed them going the same direction as ourselves. The reason apparently for our superior speed being that the other car was laden with fruit and vegetables, or sometimes butter or other eatable matter.

It appears that farmers have at last roused themselves and found that in spite of many disadvantages in taxation and the price of the fuel it comes cheaper and better and quicker than a gee-gee. And it was a novel sight to see an agent with a Car in the Market Place which had been sold several times over! As fast as one car was sold the Agent telegraphed for another to be brought along and delivered at a given address.

It was amusing too that a burly farmer would come up to the Agent and ask for the car to be sent to his farm and a man to teach him how to run it! And whereas he had haggled the whole forenoon over a few francs difference in the price of a cow he would pay then and there the price asked by the Agent for the Motor Car! And once the Car gets to the farm all sorts of uses are found for it which never entered into the daily routine of a horse. It will in fact, as a farmer told us in explanation of his preference and enthusiasm, "go anywhere at any time; it will start and stop just when and where you want it, and never boggles or shies at anything!"

Of course Americans have arrived at this stage of appreciation of the Ford years ago, but it is something new for the Frenchman, and it has taken a good many hard knocks and the severe rigour of a big war to get him to reconsider his old-fashioned ways.

## THE HARD TIMES

I was told of a really "hard case" the other day. It was about a man in Paris. He is a Theatre manager. He had been obliged literally and actually to "sell it and buy a Ford". The IT which was sold to raise the wind for the \$1,000 Ford was a Motor Car with a high sounding name. And it was one which needed a Chauffeur. Monsieur, the Theatre Manager, could drive all right—when the car was a long way out of Paris, on the highway to somewhere and no other cars in sight,—but for the intricate traffic of our "Ville Lumiere" he wasn't running any risks. So he lolled back in the gunwale of the car. In winter time, when he had a big fur coat on him this position suited him down to the ground. But the COST of it! Anyhow he had been obliged to cut down his expenses and that was one of the details,—to sell the big Bowls-Rooster "and buy a Ford".

But his brethren of the profession, who luckily had not yet "come to that" proposed to get up a benefit,—a "round robin,"—we sometimes call it, in order to pull their confrere out of the terrible hole which the indignity of riding in a Ford had put him into. But our Manager was obliged to point out that it was not entirely and merely on account of the value of the Car that he had been obliged to go into Misery Street. It was the cost of upkeep. And moreover he had gloomy recollections of a former "benefit" after some slight inconvenience which he had with the leading actress of his theatre, when he found himself out of pocket to a considerable extent by having to entertain the gentlemen who came to present him with the "cadeau". But it is rather funny to see him arrive NEAR the Theatre and dismount about 100 yards away, leaving the Ford in a convenient Garage!

## FORDS IN THE FRENCH COLONIES

A traveller from the far East and French Colonies has given me some interesting information regarding the sale of Fords out there. It appears that the American made Cars are generally favoured on account of being much lower in price and the pushfulness of the agents. Whilst French and other cars are simply expected to sell themselves "on their merits" because, coming from France for instance they must be the very best of all cars in the world! This little weakness,—or is it a big one,—on the part of the Frenchman is ineradicable. It seems to run in the blood like wooden legs, as somebody has said. The Frenchman cannot for the life of him get out of that idea that because a thing is produced in France it MUST be the best in the world!

It appears that in the Province of Fowchow (or Foo-Choo) the transport facilities are entirely in the hands of a concern which runs seven Fords. Altogether there are only 15 Automobiles running, of which, besides the foregoing seven three are Ford Touring Cars, 4 are other makes of American cars and one make English. They have plenty of catalogues and other literature from America printed in the Chinese language as well as English. But none of the French firms have yet made a translation. Selling organizations however are mainly located in Shanghai and the kind of car favoured is one to carry at least five persons and be of light weight and easily handled. The Ford has been selling at 1350 dollars.

In the Province of HU-PE (or Hoo-Pel) far inland communication is by the river Yang-tse-Kiang, on which there are several important loading and discharging points. The country generally speaking is fairly flat and consequently not particularly trying for Autos, and roads are fairly good in the neighborhood of the principal town of Hankow. In other parts



however my informant describes them as excrable, badly kept up, all hills and hollows, but in odd places paved with flags. They are usually about 5 yards wide. Still, owing to climatic conditions being favourable, especially during the dry season from September to February, travelling is pretty good, all things considered.

The price of Spirit was 90 cents the gallon. Oil 2 doll 25 the gallon. The Customs Duty is a 5% ad valorem. The number of Cars of all makes imported during recent years are as follows, —

In 1914.....	7 cars
1915.....	5
1916.....	20
1917.....	39
1918.....	30
1919.....	32
1920.....	41

### News Notes of Our Competitors

Cadillac has brought out a new model—with new side lamps and other radical features. The minor detail of price is unchanged, and to mention the weight would be a dead give-a-weigh.

Packard salesmen are telling a new Ford joke. The Packard has many points of similarity to the Ford, such as demountable cylinder heads, roller bearings in the front wheels, etc.; which make competition between the Packard and Ford largely a difference of price.

The FORD Car is in a considerable preference, mainly for the reason of its lower price perhaps, but still for its advantages of being well up above the ground and having its easily fitted or unfitted hood. The number of cars registered as "running" in 1920 was just 149 plus a Lorry. And the proportion of Fords was just 50 per cent of the lot. There are only eight French Cars. All the rest are American. Consumption of Spirit is not so much a consideration as the weight of the car and ease of driving and the resistability to difficulties which the Ford possesses in such a marked degree when in the hands of the Oriental character. And my informant regretted that he could not take back with him the agency for a French Car. He was going across to Detroit to arrange for a certain make which gets "mentioned in dispatches" so often that I can't afford to tell you its name here.

England's premier car, the Rolls-Royce, finding itself outsold by Fords in England, has come over here to give us a battle on our home grounds. The Rolls-Royce may pass the Rolls-Rough on the hills, but the Rolls-Rough will surely pass all others on the bills.

The new Moon Brougham has individual chair seats for the driver and front seat passenger—and the right-hand front seat slides over against the driver's seat. The Moon car with the sliding front seat will prove the park bench's only rival. Oh, girlie! Who do we hug next?



#### FAIR TOURISTS NEAR END OF LONG TRIP

These fair tourists are on the last lap of a coast to coast "Ford" tour. All are from New York. They have just returned from California and have been on the road fourteen weeks.

They thought a visit to the President would make a grand climax to their trip. They were snapped in front of the Capitol Bldg. in Washington D. C. Left to right: Pansy Stone, Emily Gibson, Alice Gracy, Vivian Merill, and are all residents of Jamaica, N. Y.

# HINTS



Send us rough sketch and description of any repair hint that would be of assistance to Ford owners. If acceptable, we will pay \$1 for same. Here's a chance for easy money.



## REMOVING TRANSMISSION COVER

Removing transmission cover to reline the bands, has been an awful job to take off the electric starter motor. I have heard of cases where the starter has not worked well, after having been tampered with.

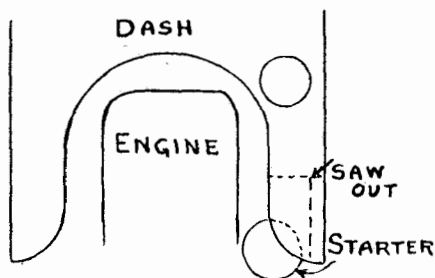

By sawing out the dash, as illustrated by the dotted lines, the cover may be removed without detaching the starter motor, leaving everything but the wires attached and in good order.

W EDWARD WHITE, Nashua, N. H.

## OIL TIGHT JOINTS

Do not throw away old coil units, which have been damaged, or burnt out. Remove the box from the coil, and then cut the wax filler from the coils and the condenser. Put the wax in a perfectly clean tin can, which has a lip formed on one side to permit easy pouring.

When joining two metal surfaces, clean one of them thoroughly of all dirt and oil. Melt the wax, and pour a thin stream along the cleaned surface. Put the two together, and draw up the bolts. The joint is now absolutely oil and water tight.

The wax melts readily on the stove, or with a blow torch, and will stick to clean metal. When cool, it has the consistency of live rubber, and will 'give' with the movement of the parts. No gaskets are necessary when the wax is properly applied.

H. M. Scherer, Rush Hill, Mo.

## THICKNESS GAUGE

A thickness or 'feeler' gauge, for setting the Ford valves and other measurements, can be easily made by fastening one or more Gillett razor blades to a block of wood. Each blade is practically .006 inch thick, or slightly less, and three blades together give the correct clearance for valve stems and tappets of between .017 and .018 inch.

H. N. LOEB, Indianapolis, Ind.

## HOOK LIFTS ENGINE

A bolt for lifting Ford engines out of the car, instead of using a cumbersome rope 'sling', can be made from a discarded spindle body bolt, and the base of a Champion spark plug.

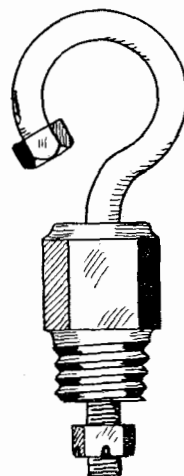

Bend the spindle bolt to form the hook, and place the bolt through the spark plug base. Grind off the corners of the nut, and cotter pin the nut so that the nut can pass through the spark plug opening in the cylinder head. Insert this hook in place of No. 3 spark plug, and the engine can be lifted out easily.

R. A. MILLER, Highland Park, Mich

## BEARING SCRAPERS

In many repair shops, bearing scrapers are abused by keeping them with other tools. And the scraping surface is soon scratched, or chattered.

A good tool, which will scrape the bearings easily and correctly, and where one looks, is made from a discarded piston ring. When one becomes dull, another can be used.

The ring may be used whole, or broken in halves. Use both hands, and cut with either edge of the ring. With no practice on the part of the mechanic, it will be readily seen that this makes a good scraper.

J. W. Reynolds, Liberal, Kans.

### HORN ADJUSTING TOOLS

Adjusting the Ford horn is not so easy, unless one has the following efficient tools for doing the work. Take a piece of steering connecting rod tubing, and cut a piece ten inches long. Heat with a torch, and shape the end to fit the lock nut on the screw inside of the horn. Solder a strip about half inch wide to the other end to form the tee handle.

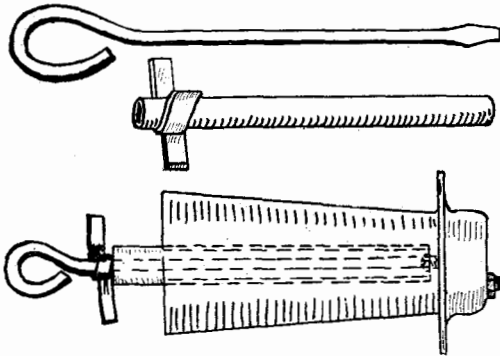

To make the screwdriver, use a piece of old radiator-to-dash rod. Cut a piece 14 inches long, and then shape to a handle at one end, and to a screwdriver at the other. By using the screwdriver inside of the tubing, the horn adjustment can be changed and locked very quickly and easily.  
Edw. Mundt, Bronx, N. Y.

### QUIETS STEERING GEAR

As the spindle arm bushings and ball sockets caps become worn and loose, an annoying rattle and back-lash develop, which are disturbing to the peace of mind of the driver. While the installation of new bushings is the more permanent repair, the use of the spring tension fixtures, as made by some of the accessory makers, give good results.

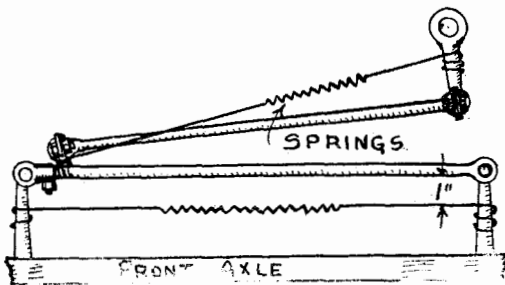

Temporary steering gear tighteners can be made by using the springs removed from old emergency brake shoes, using baling wire to attach the ends of the springs to the steering gear parts. As there is only a small fraction of an inch of 'play' to be taken up, the short brake springs can take this up without undue stretch.  
GEO. D. PETERSON, Provo, Utah.

### GASOLINE SHUT-OFF

It is often convenient to be able to shut off the fuel supply under the gasoline tank, without the necessity of crawling under the car. Sometimes the carburetor leaks, and then an accident may be avoided by the fuel being shut off.

A piece of sheet metal should be soldered to the handle of the shut-off valve, and a quarter-inch hole should be drilled through this plate. A piece of quarter-inch round iron rod, should be bent into a quadrand, extending up through a hole in the floor boards. The curve of the rod makes it operate through the floor board, without the necessity of cutting a slotted opening.

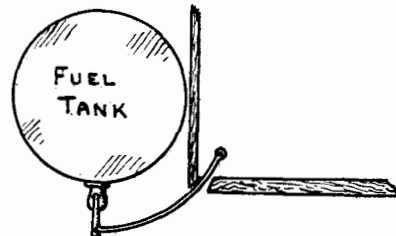

Each end of the iron rod is bent sharply at right angles. This keeps it from dropping through the floor board at the top, and serves as a handle. Where the rod goes through the plate (attached to the handle of the shut-off valve) the rod is drilled, and cotter pinned, to hold it in position.

If the exhaust pipe packing nut is tightened, after the engine has been running, and the nut is hot and expanded; then it will not work loose so easily.

JOHN J. CROISANT Menlo, Iowa.

### TIGHTENS BRAKE ROD YOKE

Vibration often causes the yokes of the hub brake pull rods to loosen on the threads, thus causing a rattle at this point. Or the threads may wear so that the rod will pull out of the yoke, thus rendering the brake inoperative.

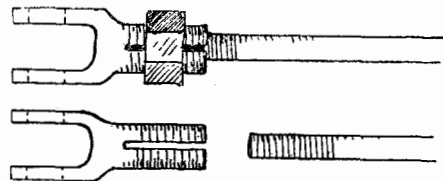

However, the outside of the yoke can be threaded with a die, set to cut the thread a little large, and a nut made to fit. A slot is cut through the yoke with a hack saw. By tightening the nut, the yoke is clamped down firmly on the rod, making a substantial repair. This repair avoids replacing Ford Parts No 3467, 3468, or 3469.

G. A. LUERS, Washington, D. C.

# WHAT- WHY- HOW-



Wherein Your Questions  
Are Answered

Conducted by  
Murray Fahnestock

## BATTERY CHARGE

A new battery was installed this spring, as part of the standard Ford starting and lighting system, and is still in good working order. But lately, I put a spot light on the car and, with this on, it seems to show too great a discharge, to my way of thinking, at the present charge rate.

As I have no speedometer on the car, these figures will be largely guess work. At 15 miles 8 amperes. At 20-25 miles an hour, 10 amperes. The discharge is 6 amperes, with head lights and tail lights burning. There are no side lights. Dimmer is 2 amperes. With head lights, spot lights and tail light burning, the discharge is 8 amperes. The head light bulbs are 6-8 volt, 21 candle power.

Do you think the charge rate is sufficient to take care of the car on short runs? I live about 2 miles from town and, in the future, will do most of my driving at night, over a somewhat rough road. I thought of having the generator fixed to charge at 15 amperes—or would this be too much. I wish to keep the battery three-quarters charged all of the time, as I shall leave it in the car all winter, driving the car when weather permits.

I read of ampere minutes and minutes, what is the difference?

The charging rate of the Ford generator should be from 10 to 12 amperes, when the car is running at 20 miles an hour. Ford ammeters are not usually correct to within closer limits than 10 per cent. And your ammeter seems to be indicating a greater rate of DISCHARGE than is actually present—and consequently, a lesser rate of CHARGE than is truly existing. With head lights burning, the actual discharge rate should be 5.4 amperes, while your ammeter says 6. Also, an 8 ampere rate is rather high for all lights and spot-light.

Assuming that the storage battery stays fully charged, and that the battery spins the engine briskly, even when cold; one need not worry too much about the infallible ammeter, and can take for granted that the battery is keeping well charged. Performance counts, and when the battery is not fully charged, it will show up in sluggish starting, and not so bright lights.

You can have a competent repairman move the third-brush of the generator, so as to secure a higher charge rate for winter use and spot light, but the regular rate will probably prove sufficient.

Amperes denote the RATE of flow. Ampere minutes mean a certain rate for a given time, thus giving a definite QUANTITY.

## FOR BETTER LIGHTING

My 1919 Ford lights are apparently dimmed at all times, and more so, when I turn the current through the dimmer, by turning the switch. If I bare wire above dimmer, and wire around, I get an entirely different, and better, lights. I would like to use dimmer but, of course, the better lights are preferable.

Do you recommend the plugs, to insert in right-hand head light, to give better lights at low engine speeds?

The plugs, for insertion in the righthand head lamps, usually connect the two head light bulbs in parallel. With this method of connection, FOUR

times as much current will be drawn from the Ford magneto as when the usual series connection is used. Some Ford magnetos will stand this without weakening—others will not. Many Ford magnetos will not give enough current for ignition, when so much is drawn to the head lights.

The choke coil on the dash has two functions. It is intended to act as a regulating coil, to cut down the current from the magneto at high speeds, and protect the head lamp bulbs from burning out. If you wish to risk the danger of burning out the bulbs—which may be remote if the magneto has become a little weak. But you can still use the choke coil on the dash as a DIMMER, and without weakening the lights, by so connecting the wires that the current does not flow through the coil for bright lights; but does, for the dimmer.

## OIL LEAKS INTO GENERATOR

Have 1920 Ford Sedan, and have been having trouble with oil in leaking into generator, and keeping it from generating sufficient current to recharge the battery. And I have to clean the commutator, after every hundred miles.

I have noticed that the commutator is perfectly dry. Am using the regular Ford brushes. Have noticed a small amount of oil on the bottom of the generator, also, that there is a small hole in same. What harm would there be in enlarging that hole?

As you have noticed that the commutator is dry, this suggests the probability that the dirt you find on the commutator is not due to oil, but rather to carbon from the brushes, due to sparking and burning of the brushes. Sometimes the brushes are not accurately FITTED to the commutator, so that they make good contact over at least 75 per cent of the area of the brush as they should.

Again, the commutator itself may be a little rough or scored. Or the mica insulation, between the copper bars, may be projecting up above the copper segments, and so causing the brushes to jump and spark.

No harm will result from enlarging the hole in the bottom of the generator, if you use care not to cut the insulation or wiring of the field windings. But we hardly think that this should be necessary.

## CLANKING NOISE IN ENGINE

When going up hill, my 1917 Ford touring makes a 'clanking' noise, regardless of spark lever position, or if the throttle lever is opened quickly on level roads. That is, whenever the engine has to labor a little hard.

Have cleaned out carbon, new spark coils, new timer, wiring. Otherwise, the car runs like a sewing machine.

The noise in your Ford engine may be due to a 'sprung' connecting rod, or to piston slop; caused by piston that is too 'sloppy' a fit in the cylinder. Main bearing knocks show up more clearly when the throttle is suddenly opened, and the strain is more directly on the bearing, than when the crank shaft has more of a chance to run away from the impact of the explosions. None of these defects will inter-

fers with the smooth running of the engine, when it is running lightly loaded.

By holding down the vibrator points, one at a time, you can determine in which cylinder the knock occurs, or if it is due to one of the main bearings being loose. The rear main bearing nearly always gives trouble much sooner than the other two, due to the extra load that it carries.

#### KNOCK IN ENGINE

Have a 1918 Ford touring, driven 9,300 miles. Motor has never been touched, and still runs smoothly except when going down grades at 25 miles an hour, with the car turning the engine over. Then there is a metallic knock, not very loud, as though a connecting rod bearing were a little loose. It comes about every stroke of the engine.

Knocks due to loose big end bearings in the connecting rods, are most evident when the car is running about 25 miles an hour or so on a slight down grade. And we think that this is the trouble with your engine.

To tighten these connecting rod bearings, it is not necessary to take the engine out of the car, as you can tighten the bearings through the crank case cover lower door, if you have the proper off-set connecting rod wrench, which you can buy for about 50 cents.

In nearly 10,000 miles of wear, it is possible that the rear main bearing cap may be sufficiently worn to permit end-play of the crank shaft. This would tend to make the engine a little harder to start on the magneto.

#### WEIGHT OF CAR—TIRE SIZE

Am having a Ford roadster body made, with a disappearing seat. This body will weigh about 30 pounds more than the regular Sedan body. Am also having the wheel base lengthened, to 112 inches. Will this be too heavy, if I install 4.2-to-one gears in the rear axle?

Can 31 by 4 inch tires be used as oversize, on the regular Ford demountable rims? The wheels will be wire wheels, and the chassis will be a new one, with electric starter.

We think that the installation of a set of 4.2-to-one gears, will enable the Ford engine to handle the 80 pounds heavier-than-Sedan body, with electric starter, very nicely. We recommend its installation for this use. It is possible that, in and around well-paved New York City, you could obtain satisfactory results with a 4-to-one set of gears. This would give you slightly more speed, but less power for hills and reserve. Probably, the 4.2-to-one gears would be the better.

The 31 by 4 inch tires have been specially designed to fit on the rims for 30 by 3½ inch wire wheels. And so you can use these tires very nicely as oversize. The writer is now using some in this manner.

The use of the 31 by 4, instead of the standard 30 by 3½ inch tires, will increase the speed of the car by about 3 per cent—and cut down its power accordingly. If you use these larger tires, then we certainly recommend the use of the 4.2-to-one gears

#### STARTER TROUBLE

The electric starter, of my 1920 Sedan, has been giving trouble. I did not have a hydrometer, and so did not keep tab on the battery. But, as the ammeter was registering, I thought that the battery was getting the benefit.

When the battery refused to crank the motor, I got a hydrometer and tested the battery, which registered slightly under 1.250. The car has been run 300 miles since then, but the battery shows no increase in gravity. Also, the cut-out does not close automatically—so I close the points by hand.

We suggest that you add distilled water, to each cell battery, to bring the solution up to the proper level and then—take the hydrometer readings. A reading of 1.250 indicates that battery is at least half charged, and this should easily be enough to crank the engine.

However, if you have not been adding water to replace that lost by evaporation and electrical action, then the remaining solution will be strongly acid,

and so give a misleading reading on the hydrometer.

The second part of your work is now to replace the cut-out with a new one—as adjusting a cut-out is the work of an expert, and a new cut-out only costs about \$1.50. If the cut-out works as it should, it is certain that the battery will be ON CHARGE a much larger portion of the time than when you have to close the points by hand. And this extra charge will probably be enough to keep the battery charged as it should be.

#### FINDING DEFECTIVE COILS

What is the proper way to cull out, or test, the defective coils on a broken down, or shorted Ford magneto coil assembly?

Connect a group, of about 6 incandescent bulbs, each of the 32 candle power, carbon filament type, in parallel; and then connect these 6 bulbs in series with a pair of test points, for testing out the Ford magneto coil assembly. Thus, a current of about 6 amperes will pass, and the bulbs will light, when the circuit is closed by touching the test points together, using a 110-volt house lighting current.

Unsolder the grounded end of the magneto coil windings, where it is soldered to the frame of the magneto coil assembly. Touch one of the test points to the magneto contact point, and touch the other point to the unsoldered end of the magneto windings. If the bulbs light, then the circuit is complete.

Holding one test point on the magneto contact point, touch the bare metal of the magneto frame with the other contact point. If the bulbs light, then the coils are grounded. If grounded, the ground can sometimes be burned out, by the electric current. If not, it will be necessary to unsolder the connections between the individual coils, until the trouble is run down and located.

#### BROKEN SPRING LEAVES

About every year, we have to replace the front spring on our Ford. Either all the leaves are broken at the bolt hole, or maybe just one or more leaves.

Please don't just say that it is our own fault, for not keeping the bolt and the clips tight. We did, and they were always tight, and we do not do any overloading, either. This is a 1917 touring.

Do you think that it would help, to keep the front spring from breaking, if we used a leaf from a six leaf spring (No. 5), and put this leaf between No. 5 and No. 6 of the spring which we now have. This No. 5 leaf is about 3 inches shorter than No. 5.

Titanic springs are guaranteed FOREVER against breakage at the middle, and for one year against breakage elsewhere. The hole, punched through the middle, of the ordinary Ford spring, weakens the spring greatly—just as a notched stick will break twice as easily as one not cut or injured.

As you already know, failure to keep the spring clips tight is one of the frequent causes of breakage in the middle of springs. But, it is possible that the leather pad, No. 2823, may have been omitted; and the lack of this pad would tend to cause spring breakage.

#### VIBRATOR SPARKING

What makes the vibrators on the coils spark? What is the right distance to set the coil points—or is there any standard distance? I use a "feeler" or thickness gauge, set them at .031 inch, and get good results most of the time. But some of the coil units spark too much at times. I know that the vibrators always spark a little, but these spark too much.

I drive a 1918 Ford, with a 16-valve head, and if you don't think that this car will run fast, just ask some of the owners of big cars in Washington, Pa. what has passed them going up the hills.

Excessive sparking, between the contact points of the coil units, may be due to the use of too much or too little tension in the adjustment of the points. It is as necessary to have the correct TENSION, as it is to set the points at the correct DISTANCE.

Also, it is not easy to file the points so that they will be perfectly FLAT and TRUE, and so that they will make contact over a wide, broad SURFACE. Instead of just at one edge or corner. Best results in setting the coil points are obtained by the use of a coil unit testing machine at your local Ford Agency.

# Equipment Review

*A monthly department in which manufacturers are given an opportunity to furnish news and views concerning accessories, equipment and ideas for the Ford car.*

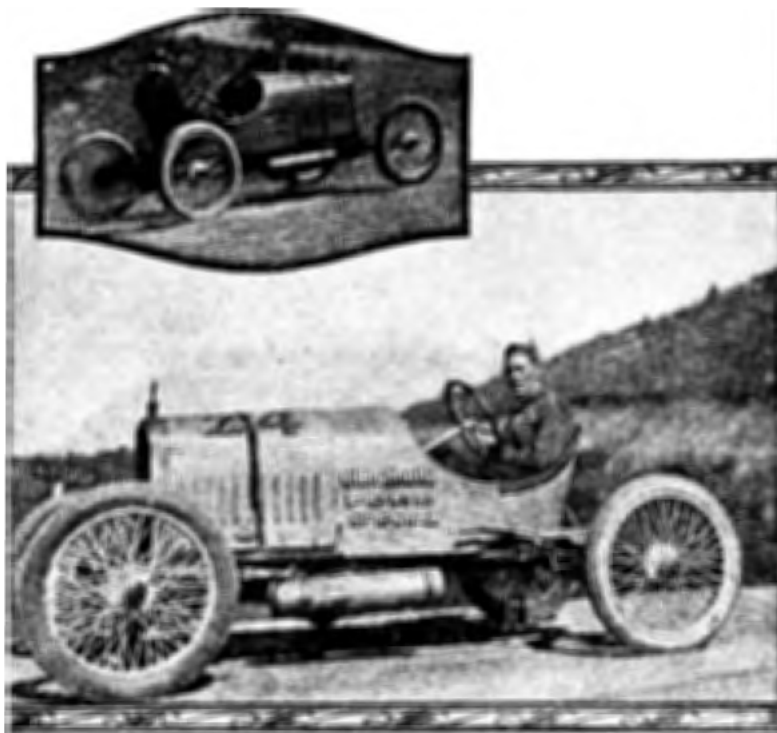

## CLIMBS PEAK WITH RAJO

The Ford—a Pikes Peak champion! Sounds like fiction—another Aladdin's lamp story perhaps, except that the redoubtable Genii of fairy tale fame must have rubbed the magic lamp with greater gusto than ever before.

It all happened on last Labor Day, when 7,000 people—the largest crowd ever assembled at the annual Pikes Peak Hill climb—witnessed the most thrilling and fastest races ever staged in the history of that popular road classic. Eighteen cars completed the entrants in the three classes. Among these was a Ford Special, piloted by Glen Schultz of Colorado Springs, Colorado, and equipped with a Rajo Valve-in Head.

When Schultz took off at the drop of the starter's flag, no one even suspected that 21 minutes 34- $\frac{3}{4}$  seconds later he would touch the top of the world—winner among the cars with a maximum piston displacement of not to exceed 183 cubic inches. But with the added power and speed the Valve-in-Head gave him, he tore up the 14 miles of treacherous mountain-side at a terrific pace—faster by a minute than the time made by Loesche in a high powered Lexington when he won the cup in 1920!

Considering the fact that Schultz's time placed him fifth among all the cars entered—regardless of their piston displacement and power—his driving was nothing short of sensational. For on

this basis he was competing against such high powered cars as the Lexington, Haynes, Hudson, Paige and Packard.

Though it happened there were no casualties, the race was not without its thrills. As soon as Al Cline, driver of the Lexingtons, left the starting line, news was flashed to the top of the Peak where hundreds waited to see him go by. One by one, comments began to be made as to whether it were not time for him to be approaching. And still he did not come.

Finally, the whirr of a motor was heard and far below a car dashed into sight. "Come on Cline!", the crowd shouted. "Why have you been so long? Come on—you're making up."

Then dashed by them—like a thing on wings—not Cline's car, but the winning Hudson in Class 3, with King Rhiley at the wheel. The crowd was so surprised that it could not rally in time to give Rhiley a cheer. For there was not a doubt in anyone's mind but that Cline's car had skidded over the edge of a cliff to be dashed to pieces hundreds of feet below.

It was not until all the other racers had passed that word was brought up that Cline, though out of the race, was safe and unharmed.

Following is given the official time of the three Pikes Peak events in which Glen Schultz and his Rajo-equipped Ford Special took first place in the small car class:

### A NEW FORD STEERING WHEEL

A new steering wheel manufactured by Spurgeon Brothers Company, Muncie, Ind., appears to be meeting with decided success. The Muncie has a 17 inch walnut finished corrugated rim; polished aluminum spider, and is exceptionally well built throughout. Its easy operating tilting

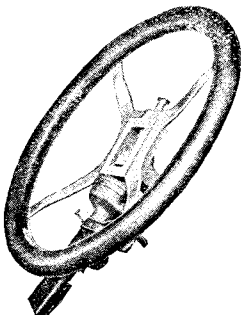

feature makes it specially convenient and practical. Its large size relieves driving strain. It cannot rattle; can be put on quickly by anyone, and greatly improves the appearance of the car. The complete cost is \$6.20.

### NEW ERA HAS NEW PRICES

New prices and discounts on springs, tire carriers, spring bumpers and visors recently announced by the New Era Spring and Specialty Company of Grand Rapids, Michigan, shows a downward trend in price revision and an upward trend in discounts.

The New Era organization is announcing its new prices a month in advance of the usual time, November 1st, and the new prices and discounts are effective October 1st.

New Era has reduced its list prices on New Era "BETTER" 1 3/4" double-bar spring bumpers, tire carriers and all-metal visors, and has increased the discount on spring to 70% and on tire carriers 50-5%.

Another step forward is New Era's innovation in listing Fords, Chevrolet "490" and Overland "Four" in the same price classification in both the double-bar and Duplex or double-face type of bumper. Heretofore Ford bumpers, like other Ford accessories, have been listed at a lower price than all other cars. New Era double-bar bumpers for these three models now list at \$10.00 for black and all \$11.50 for black and nickel or full nickel.

### THE LONGSTRONG SPRING

What appears to be a thoroughly practical device is the Longstrong Spring which is claimed to add greater strength and remarkable resiliency to any Ford car. It is a nine-leaf spring and forty-two inches in length and is easily attached to the front axle. Being well made and correct in principle it reduces road shocks and stays the car and tires while resulting in more comfortable driving. It is supplied ready to install. More complete particulars may be had from the manufacturers Terre Haute Auto Spring company, Terre Haute, Ind.

### CAMCO COOLER

Most Ford owners know the costly results of allowing the motor to overheat. Often it may mean the early sending of the car to the junk pile. Many car owners have found an efficient way to avoid this expense by equipping their car with the Camco cooler.

The Camco Cooler is a steel non-rusting, double-seamed 2 gallon reservoir containing an aluminum Turbine Pump, driven by a flange pulley on 1/2 inch cold rolled steel shaft through bronze, self-lubricated bearings with brass non-leak stuffing box.

The Camco is so constructed that the water will continue to circulate even if the pump should stop. If this does occur you still have the advantage of two-thirds greater water supply.

The Camco can be installed in fifteen minutes, without the aid of a mechanic, no machine work to do, no holes to drill. It is a product of the Consolidated Accessories Manufacturers Company, Frederick, Maryland.

### NEEDED BY CAR OWNERS

The proximity of cold weather demands that a careful car owner give some attention to winter needs and among these certainly can be classified the products of the Nathan Novelty Mfg. Company, 55 Fifth Avenue, New York City. A thoroughly practical item is the radiator cover fabric manufactured by this company. This



consists of a fabric which is coated with rubber and rubberized to the lining. This process assures the best cold resistance and heat retaining qualities as well as an absolutely smooth fitting cover. This material is sold by the yard and is also used in Nathan radiator cover all ready tailored for the radiator. These covers are easily

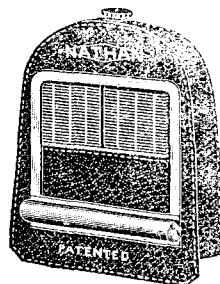

attached and permit regulating the temperature of the motor as it is operated from the driver's seat. It is well for both car owner and dealer to give some consideration to these products and write to the manufacturers for complete information.

### PRACTICAL GASOLINE GAUGE

Healthy sales are being recorded for the Gwen Gasoline Gauge manufactured by Esse Products company, 102 South Brady street, Davenport, Iowa. For use with the Ford coupe the gauge is installed on the right hand side of the body while with the sedan it is mounted on the right hand

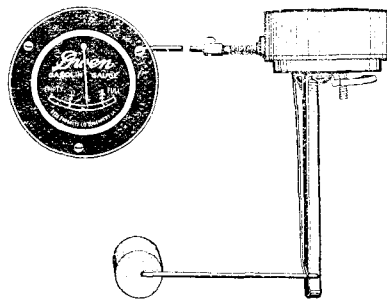

side of the driver's seat. With other models the gauge is mounted on the heel board. By use of this practical gauge the amount of fuel on hand is known at all times. This device is easily installed and is well worth the price—\$3.75.

### ACME BATTERY CHARGER

The Acme Electric and Manufacturing company, Cleveland, Ohio, is having growing success with their product the Acme Battery Charger.

The Acme is of the vertical motor generator type. It consists of direct current, interpoled motor generator mounted above a squirrel cage motor. Alternating current taken into the Acme at line voltage and which produces a non-pulsating direct current, and gives the greatest charging efficiency.

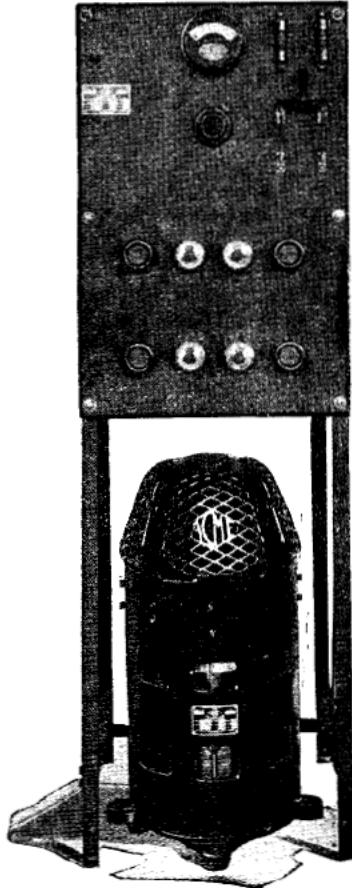

Acme Motor Generators are practically noiseless—they do their good work quietly and with ease. They are vibrationless—hence they have a longer life of dependable service; they are cool in operation—hence they operate with the highest measure of efficiency; they are sparkless—a perfect contact and a steady even flow of current is always given.

### DEFENDER SAFETY MEASURES PUNCH PRESS IS USED TO TEST SHOCK ABSORBERS

A typical example of the safety measures which present day manufacturers have adopted to guarantee uniform quality in their product and the dependability of its claimed strength is found in the manufacturing precaution of Defender Shock Absorbers.

In recent conversation with Mr. G. H. Tripp, of the Defender Auto-Lock Co., Allegan, Michigan, the fact was brought out that Defender goes further than simply purchasing the best spring steel it is possible to buy. Every set of Defender Shock Absorbers are now individually tested under conditions that are several times as severe as any that could ever be encountered in actual road use.

The Defender Shock Absorbers are placed on in a position identical to the way they are installed on a car. A punch press is then released. The impact depresses the absorbers to a concave position which of course, is a point below center and where they might logically be expected to break. This operation is repeated three times and only when the absorbers have satisfactorily withstood these extreme shocks, are they deemed fit for release to the trade. An interesting thing about this test is that the percentage of breakage, due to defective material, is marvelously small. So small in fact that it averages but a slight fraction of one percent of Defenders total yearly output.

### SUSPENSION RADIATOR CORE

One of the latest developments in Ford truck radiator design and construction is the Modine suspension core, manufactured by the Modine Radiator Co., of Racine, Wis. Owners and operators of truck fleets will, no doubt, welcome it as a great boon because of the time-saving effected in radiator replacement work. It is claimed that one of these cores can be replaced on a truck in ten minute's time, due to the great simplicity of assembling and attaching.

Instead of removing from sixty to eighty bolts and a couple of large gaskets, which is the usual radiator replacement procedure, this suspension core radiator requires only the removal of four bolts and two small gaskets. The radiator is so designed as to permit fitting either the Modine tubular or spirex core.

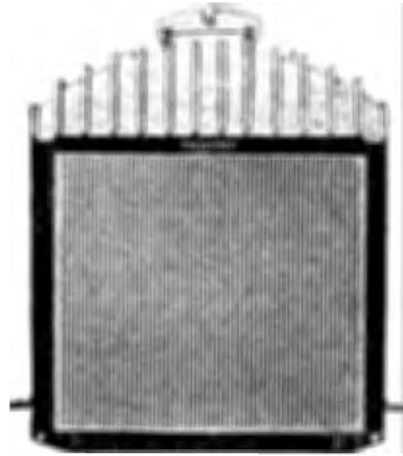

The construction is unique in that it requires only a three-piece frame. The cast iron bottom tank is entirely eliminated. This results in a very considerable saving in weight. The core is equipped with a shallow, reinforced header tank, and is drawn against the radiator upper tank by two cap screws, slidably attached in such a way as to allow sufficient flexibility to take up any strain resulting from expansion or contraction. The weight of the iron used in this core is from 25 to 40 percent less than that of the ordinary truck or tractor radiator core.

The suspension core radiator is adapted to both truck and tractor service. According to the engineers who designed it, this radiator in addition to permitting quick, easy replacement, possesses greater cooling capacity per pound of material than any other make and, in addition, has the advantage of greater strength, structurally.

### HELPS TIMER SALES

Meeting the demand of the auto supply dealer trade for display units which effectively show and sell goods for the manufacturers of the Milwaukee Timer for Fords have produced a new steel display stand which is proving so popular that the original supply has had to be multiplied.

This display stand is not merely a sign picturing the goods advertised, but is really an effective "silent salesman." It holds an actual



Milwaukee Timer and brush assembly in such a position that the customer can see the main selling points of this fine instrument—the satin-smooth raceway and anchored steel contact points, the patented oil-cup, the glass-hard roller and the two bronze castings of the standard-type brush assembly.

The Milwaukee Timer display stand is handsomely lithographed in three colors and is substantial enough to make a permanent counter stand or worth-while addition to a window display of well-known, nationally advertised items. The stand is being sent without cost to dealers upon request.



Auto supply and hardware dealers are selling nearly 4,000 Milwaukee Timers daily, according to recent reports from the trade. Milwaukee Timer production is said to equal that of any other two replacement timer manufacturers combined. The Milwaukee Auto engine & Supply Company backs its products with aggressive national advertising on a scale unapproached by any other timer manufacturer. This advertising is one of the reasons why the Milwaukee is a standard item that is effectively pushed by 96% of all auto supply jobbers and by 45,000 dealers.

**POPULAR TIRE PUMP**

A tire pump which is meeting with great favor is the Multiple Cant-Leak Tire Pump. This is built on a new principle which makes it unusually strong and durable. The piston is built on the principle of that of an automobile engine having three piston rings which prevent air leakage. The pump barrel is made of special high carbon seamless steel tubing.

The piston goes flush to the bottom of the barrel, thereby forcing all the air beyond the ball check valve you notice in pump base casting. This ball check valve prevents the air or compression in the hose from leaking back up through the pump on upward stroke of piston, therefore, on each downward stroke, it steps up this much more air into the tire and fills it quickly.

This is a product of the Multiple Boring Machine company, Inc., 2212 Washington Av., St. Louis, Mo.

**THE TURNER TWO-IN-ONE TIMER**

The Turner Timer, manufactured by the Turner Manufacturing Company of Kokomo, Indiana, is a product that has been undergoing the most rigid tests for the past four years. It has stood those tests and its success with Ford owners in every part of the country has been remarkable.

The manufacturers have tried from the start to be conservative in their claims and have always avoided glittering generalities in putting forth the merits of their product. They have always preferred to tell what it will do and why it will do it.

The Turner Timer is designed to eliminate starting troubles in cold weather. In most instances it stops the fouling of the two front plugs. The hot spark, a result of Turner Construction, results in a great saving of fuel. It

eliminates "kicking" by the motor because it gets entirely away from oil and water soaked wires. The wiring system, which is a part of the timer is oil, grease and water-proof. The Turner Timer can be installed by anyone in ten minutes. It has but two moving and wearing parts and requires no oiling.

It is a genuine quality product throughout, carefully made of the best procurable materials and fully guaranteed by the manufacturers.

**NEW ROSE BUSHING REMOVER**

The Frank Rose Manufacturing Company of Hastings Nebraska are continually adding to their already large line of Automotive Necessities. Just now they are placing on the market a Bushing Remover of novel design. It consists of a steel drift split to give it tension. On the end are two small pilots serving to keep the remover in correct alignment on the bushing when

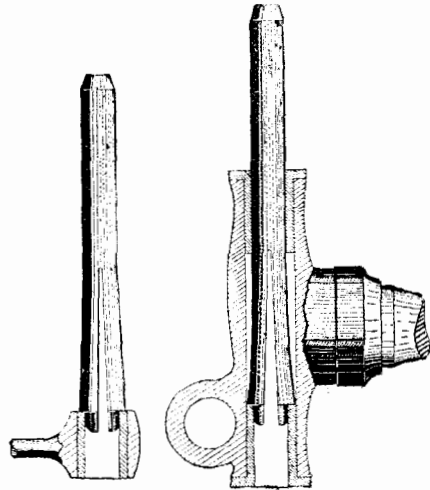

the remover is used for drifting bushings where the casting itself does not serve as a guide.

Particularly desirable for removing spindle bushings, tie rod bushings, and spring perch bushings, etc. At present it is made in two sizes one for Ford, and one for Dodge. Each of which will fit many other makes and models of cars.

**PREVENTS BURNER TROUBLES**

It is a well known fact that Gasoline Fire Pots and Blow Torches, such as are commonly used by the mechanic, can be put out of service within a very short time and the Burner ruined if the sharp pointed Needle that controls the Generator is screwed up too tight, or if by any other means, the small orifice or fuel opening in the Burner is made larger. The reason for this is that the enlarged orifice in the Generator allows a larger amount of Gas to pass through into the Combustion Chamber which produces an imperfect mixture with the air, thus reducing the generating and heat producing qualities of the Burner.

In fact, it is claimed by the Clayton & Lambert Mfg. Co., Detroit, Mich., who are well known makers of Gasoline and Kerosene Fire Pots and Torches, that over 60% of all Burner troubles are caused by the Needles that control the Generator being made with sharp points and to overcome these troubles they have designed and secured patents for their new improved double blunt Needle Burner, a section view of which is shown below and clearly indicates the construction and improvements.

Both the Needles used in the improved Burner have blunt points which makes it impossible for the user to enlarge Burner the orifice. The lower Needle "B" regulates the supply of Gas and the upper Needle "A" has a small wire tip "E" that cleans the orifice in the Jet Block "D." The Safety Stop "C" prevents the upper needle from

being unscrewed too far. All Double Needle Burners are supplied with two Jet Blocks, one for burning Gasoline, the other for Kerosene. They are interchangeable and the Jet Block in the Burner can be quickly removed and the other Jet Block screwed quickly into place.

The makers claim that these Double Needle Burners have wonderful generating power, producing from 100 to 300 degrees more heat than any other make of Burner and that the consumption of fuel is reduced to the minimum. This being due to the improved construction of the Burner and the extra long Vaporizing Chamber "G" and Vein Tube "H" through which the gas passes, causing it to become superheated before entering the Combustion Chamber.

Complete information can be obtained by writing to the makers, The Clayton & Lambert Mfg. Co., Detroit, Michigan, and a catalogue showing their full line will be mailed upon request.

#### NEW FORD SHOCK ABSORBER

"Grey Goose" is the name selected by the Indiana Parts Co. of Richmond, Indiana, for their new Ford Shock Absorber. The name is suggested by the gooseneck design of the accessory.

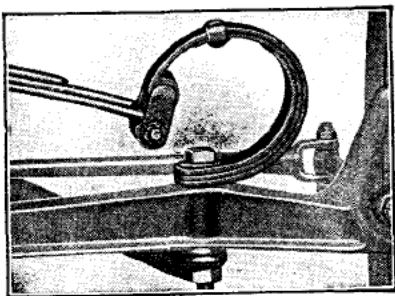

The Grey Goose shock absorber is made in two types, one for the front Ford spring and one for the rear. The action is the same; the difference of design is for the purpose of fitting.

Leaf-spring construction is used, the material being chrome vanadium steel, and the design allows free action of the springs while damping and checking the rebound. The eyes are bushed, reamed and drilled for oil cups.



The set of four Grey Goose Shock Absorbers can be applied by anyone in forty-five minutes to an hour, the necessary tool being a monkey wrench. The retail price is \$10.00 per set. Salesmen and distributors are now being appointed for territory not already covered.

#### THE AUTOLOG

Every car owner should know that his car is delivering its highest efficiency per gallon of gas and oil at all times. It is just as natural to keep a record of all the gas and oil you use as it is to keep a record of your bank checks.

But an accurate gas and oil record is too often troublesome when you have to keep it in a book. You have to search your pockets to find it. It may be somewhere else. It's a vexation.

That is why the AUTOLOG appeals to motorists. It is a handsomely nickel-plated instrument only two and a half inches in diameter, that fits on the spoke of any steering wheel where the entries are as easy to make as if you were sitting at a writing desk. It serves as a constant reminder, every time you take on gas or oil, to simply jot down the amount thru the pencil opening in the nickel disc.

At the end of the month, every AUTOLOG user has a complete record. You can see how valuable such records are. They serve to measure your car's efficiency month by month—point out motor troubles—indicate any improper lubrication, for instance, and enable you to test for the best gas and oil for your particular car.

The cost is \$2 complete, with a year's supply of record cards. It is a product of the Autolog Company, 1932 S. Grand avenue, Los Angeles, Calif.

#### TURNER LIGHTING WIRE ASSEMBLY

A new product being manufactured by the Turner Manufacturing Company of Kokomo, Indiana, which has attracted widespread attention both among Ford owners and Ford dealers, is the Turner Wiring Assembly designed for Ford cars.

To begin with, the manufacturers say, it greatly beautifies the car. It eliminates the troubles and dangers resulting from exposed and worn wires. Chaffing of wires and short circuiting are not possible with the Turner Wiring Assembly. And it is water-proof, oil proof and grease proof. Its installation is simple and quick.

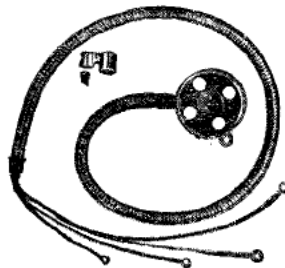

This product prevents burning out of light bulbs from uninsulated wires. It does away finally with dim lights resulting from water soaked wires, expensive road repairs from bare wires shorting magneto and stopping motor, dead or weak battery from shorted light wires.

But probably the one thing that appeals most to every car owner is the feeling of safety afforded by the use of the Turner Wiring Assembly. Fires that destroy hundreds of cars are traced to oil and grease soaked wires and the resulting short circuit. This danger is eliminated entirely.

#### SAVES STORAGE BATTERY

The life of a storage battery and the operation of the entire starting and lighting system is dependent upon the operation of the Generator Cutout. It would seem wise therefore to have a dependable cutout and the New York Cutout for Ford cars seems to come under this classification if bulk of sales may be considered as a criterion. The New York Cutout requires no attention but keeps the battery fully charged and prevents wasteful discharge, resulting in saving the cost of frequent battery replacing.

This cutout is made of the finest material and represents careful instruction and workmanship. It can be attached in two minutes and sells for \$2.50. It is a product of New York Coil Co., 338 Pearl street, New York City.

### THE THERMO SHUTTER

Most Ford owners have ceased to use make-shift appliances in order to keep the proper temperature in the radiator and motor during the winter. Further, it is a fact that many hundreds of them have declared for the Thermo Shutter. The Thermo shutter is easily applied to the radiator and is controlled from the driver's seat. It effectively keeps the heat in and the cold out in just the proportion desired. The benefits of this device are many. It prevents the radiator from freezing; insures easy starting of the motor and saves unnecessary wear on

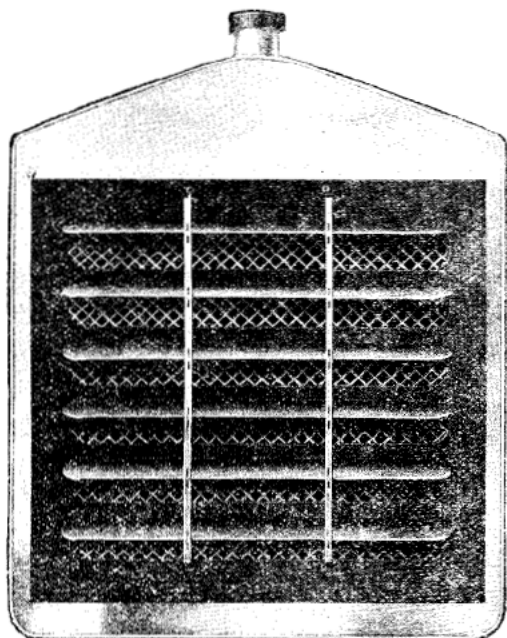

the storage battery. It also keeps raw gas out of the lubricating oil and promotes an improved flow of oil. In fact, it removes all of the many harmful effects of winter weather. There is no question but that every Ford owner needs such a device and considering that the cost is only \$2 there is but little reason why all cars should not be equipped. The manufacturers are Essential Automotive Products Co. Inc., 507-511 West 42nd street, New York City.

### ANNOUNCE A NEW MODEL

The Inland Metal Products Co., of Columbus, Ind., have placed another model of their Timer Refacers on the market a cut of which appears on another page of this issue.

This model which is known as Type B permits the refacing of the case without disconnecting any wires and will enable the garage man to smooth up the raceway without delaying the service of the car or truck but a few minutes.

While the tool is designed to be held on the cylinder head by the second cylinder head cap screw, it may also be clamped to a bench and used to reface any spare cases.

The operation of this type is the same as the other model but is provided with more convenient screws for adjusting the cutter and operating the feed nut.

Owing to the fact that it saves taking the timer case from the car, this tool is expected to make a special appeal to the repair men and those in charge of a fleet of Ford trucks.

The occasional use of the Inland Refacers is advised as they keep the raceway smooth, gives several times the original service of the case and the hot spark resulting from the constantly smooth raceway brings economy in gas and oil.

### THE STRONG PUMP

Simplicity of installation, certainty of operation and low price feature the Strong pump which is both a force and a sight feed oiler for Ford cars.

The device is easily installed on Ford cars of any model without the aid of special tools.

A rocker arm connected directly with the valve stem operates a pump, which provides positive circulation of oil to motor parts. A glass gauge on the dash provides visible evidence at all times that the pump is working and also gives a check on the condition and amount of the oil supply.

Connection is made with the crank case at the oil pet cocks and the return flow connects at the breather pipe.

In the installation of the Strong Sight Feed Oiler, it is not necessary to bore any holes or make any alteration to motor.

The oiler is the product of the Auto Accessories Mfg. Company, 509-511 Mulberry Street, Des Moines, Iowa. Until recently the oiler sold at \$7.50. Changed selling plans have made possible a big reduction and the oiler now sells for \$3.45 postpaid.

### NEW AUTO LOCK

A novel automobile lock for Ford cars is about to be placed on the market by the Taylor-Shantz Company of Rochester, N. Y. This lock consists of a manifold which is interchangeable with the regular Ford manifold and can be put on to a car in a few minutes. This manifold contains a Corbin 4 tumbler lock which operates a butterfly valve.



The valve locks in two positions, open and closed. This precludes any possibility of the valve jarring shut from vibration, when the car is running. By turning the key a 1/4 turn to the right, the valve is closed and the key then withdrawn, cutting off the passage of gas from the carburetor to the cylinders. 1/4

The construction is so simple that it cannot get out of order, and the lock appears to have many marked advantages.

### NEW FENDER BRACE

The ARG Auxiliary Spring Company, of Birmingham, Alabama, which specializes in the manufacture of accessories for Ford commercial and passenger cars, has started making deliveries to the trade of a new front fender brace which is said to rigidly and permanently prevent the front fender's rattling or cutting tires.

The brace, which consists of a stout steel tube, is finished in glossy, black enamel and extends across from fender to fender, without touching lamps or radiator.

The flanges at each end of the brace fit the bolt holes already made in fenders and irons, and take-up nuts are provided at each end to

draw up any play. This construction provides for unusually easy and quick installation of the brace, as there are no holes to bore.

Two clips in the middle of the brace are provided, to hold the licence tag steady and up out of themud. License tag is held far enough away from the radiator so that it does not cut off any air or in any way interfere with the performance of the radiator. In addition to holding both fenders tight, true and quiet, the new ARG front fender brace adds to the appearance of the car. Like the other ARG accessories, the fender brace is made of the best quality materials, and after once installed there is no subsequent service required on the brace.

The ARG front fender brace retails at \$2.50 and is sold only through the regular trade channels.

The manufacturer of the ARG fender brace also makes the ARG Auxillary Spring, a combination front spring protector and shock absorber for Ford commercial and passenger cars, which has met with a wide sale to Ford owners throughout the entire country.

#### A NEW CYLINDER HEAD

The large army of Ford owners who are interested in speedsters and Fords of added power will note with interest the arrival of the Fontenac cylinder head. This has been designed and perfected by Louis and Arthur Chevrolet the world famous automotive engineers and racing drivers. It will be remembered that Louis Chevrolet designed and built the Fontenac

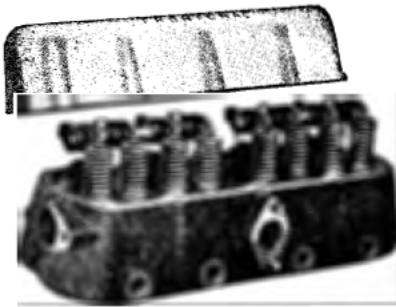

racing car which were winners of the five hundred mile race in 1920 and 1921 at Indianapolis. The new Fontenac cylinder head is of the eight valve over-head type and has several points of design which are new and interesting. This cylinder head will soon be on the market from Manufacturing Company, Indianapolis, Ind.

#### A NEW SHOCK ABSORBER

The Mousley Shock Absorber and Snubber is so graduated and constructed, that it picks up the light load—off the Ford springs—at the center of a long flexible, loose end leaf spring, (the leaf with the box eye, bottom leaf of the Mousley) and with a capacity load, or overload it gives just the degree of cushion necessary to relieve the car and passengers of shocks, even on the roughest roads. The result is easy riding, with a one or two passenger load, as well as a capacity load.

The up-ward action of the spring, or up-throw is controlled and retarded by a long flexible leaf spring, (the top leaf of the Mousley) so graduated that the counter action or tension increases with the up-ward travel of the spring, smoothly checking such recoil, so as to absolutely prevent the passengers from being thrown from the seats of the car.

Like the spring itself, the Mousley is placed between the body and the axle. Its traverse-three point suspension-construction—front and rear—extends wholly across the car. **This holds the car in perfect balance and eliminates all side-sway.** No danger of tipping on sharp curves, or quick turns—even at a high rate of speed. This safety—a distinct Mousley feature—is worth more than the price of the set.

It is a product of the Mousley Steel Products Co., 1824 Locust St., Kansas City, Mo.

#### A WORTHWHILE PRODUCT

A practical means of converting any parking light into a stop-signal and thus securing double duty is provided in the Wesco Auto-Stop-Park Signal switch. This consists of a simple device which is easily installed under the floor boards without the need of drilling any holes for altering the car construction. A handy switch on the dash permits the parking light to be operated independently of the lighting system. While driving, the switch is automatically connected with the foot brake so that pressure on the brake flashes the parking light acting as a safety signal to traffic.

This switch is so simple that anyone can install it but at the same time is thoroughly practical and requires no attention. A driver is aware at all times that the signal is operating since the flash is given on the parking light. The device is furnished complete with instructions for installing and sells for one dollar and ninety cents. A liberal discount is offered to dealers. The manufacturers are: West Mfg. Co., Montgomery Bldg., Milwaukee, Wis.

#### WINDOW DEMONSTRATOR SHOWS ACTION OF WATER PUMP

The Cramer Mfg. Co., Milwaukee, Wis., manufacturers of the "Milwaukee" Circulating Water Pump for Ford Cars and Trucks are putting out an ingeniously contrived demonstrator for the dealer's window.

It consists of a background representing a Ford Motor Block and Radiator to which a "Milwaukee" Circulating Water Pump is actually attached and operated as if on a real engine.



A clever arrangement of piping at the back of the demonstrator permits the water to be circulated by the pump; a glass section in the piping showing through an opening in the picture of the radiator giving the illusion of actually seeing the water circulate through a hole as it were in a real radiator.

This is a practical advertisement in that it enables the car owner to see just how the Milwaukee Circulating Water Pump is attached to his engine, just how it is operated by the fan belt and speed with which the water is circulated through the radiator and motor.

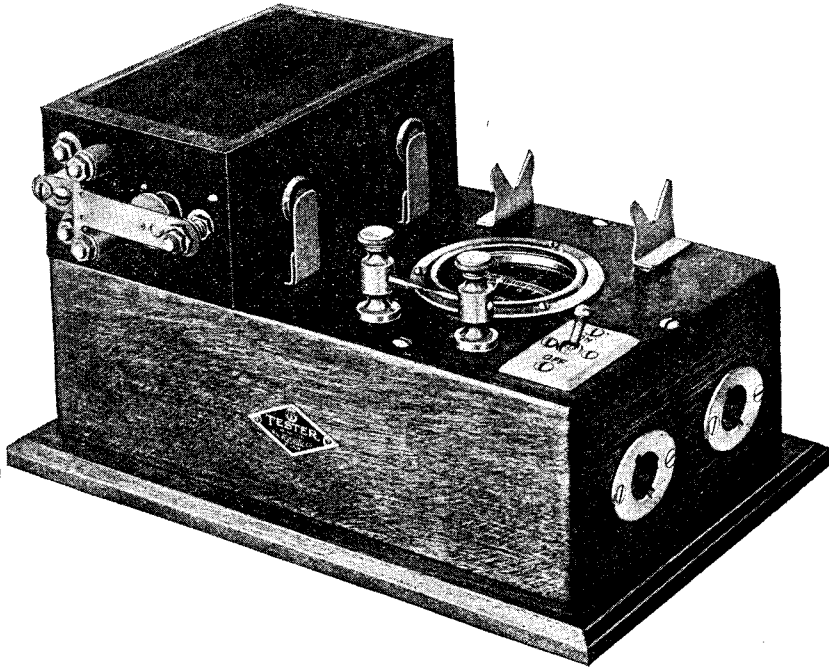

# Test This Three-in-One Tester

*A FREE TRIAL Offer Which Is Hard to Beat.*  
**Will You Accept It?**

Here is a bona-fide FREE TRIAL Offer which cannot be surpassed. We know what the B-W Tester will do, and we want you to know, too. Hence, we are offering to send you a B-W Tester and let you try it out for ten days without paying a cent in advance and without incurring the slightest obligation to buy.

**WHAT THE B-W TESTER IS**

The B-W Tester is a reliable three-in-one Tester for Ford coils, spark plugs, and single and double contact lamps. It is equipped with a low-reading ammeter which shows the current drawn by a coil. With it, you can adjust coils so that they give a continuous hot spark with a current draw of 1 to 1½ amperes each—the generating capacity of the Ford magneto. It enables you to adjust faulty ignition so that cars will run smoothly. You cannot make accurate coil adjustments without knowing the current draw.

The B-W Tester will also test single and double contact lamps and spark plugs. It is accurate, quick, simple. You don't have to have a knowledge of electricity to use it.

Case is hardwood, dark walnut, satin wax finish. Equipped with polished nickel contact points, coil guides, and spark gap. Has high-grade indicating toggle switch. Comes with cord for connecting to source of current. Type D (for direct current) has clips for fastening to standard six-volt battery. Type A (for alternating current) is provided with a special transformer and a standard plug for use within alternating current house line socket.

**SEND FOR IT TODAY**

Tear off the coupon at the bottom of this advertisement, write your name and address in the margin below, and mail it to us. We will send you a B-W Tester. Try it for ten days. If you don't think it worth the price in time saved and added service to your customers, send it back to us, and the whole matter will be closed. No apologies, no explanations will be expected. Just return the tester and that's all there is to it.

Fair, isn't it? We put it up to you just as if one of our salesman tried the tester in your shop or garage. And because we are selling direct by mail, you get the advantage of middlemen's profits.

**Type D (for direct current) complete with coil and clips for connecting, prepaid.....\$11.65**

**Type A (for alternating current) complete with transformer, cord and plug, prepaid..... 14.35**

**B-W ELECTRIC COMPANY**

7421 MANCHESTER AVENUE

ST. LOUIS, MO.

..... C O U P O N .....

**B-W ELECTRIC COMPANY**

7421 Manchester Ave., St. Louis, Mo.

Gentlemen:—Please send me one B-W Tester, Type D (or A) on ten days' free trial. If satisfied I agree to pay you \$11.65 for Type D or \$14.35 for Type A. If not satisfied, you are to take back the tester and I am to be under no obligation whatsoever.

(Write your name and address on the margin)

When writing advertisers—Just say FORD OWNER AND DEALER

---



---

# DREDNAUT

---



---

SHOCK



ABSORBERS

For

Coupe Sedan  
Runabout  
Touring Car  
Delivery Car

---



---

## FORDS



### Study These Illustrations They Show Why "Drednauts" Are Better

Take either view—in your mind follow the effect of a shock on the tires from a rut or rock in the road. The axle is forced up with the wheel—the leaf spring flattens—yet not all the shock has been absorbed. There is further absorption in the action of the arm that runs from the body to the heavy Vanadium steel coil spring—it acts as a lever in forcing the spring to its duty and neutralizing the shock to the limit. No unusual curves to the spring—none are necessary—a straight up-and-down action, with provision against side-sway in the connecting arm.

**\$18<sup>50</sup>**

**Per Set**

Backed up by a guarantee so liberal that you take no chance in fitting your car with Drednauts.

This guarantee is our expression of confidence in your satisfaction with the biggest value in shock absorbers ever offered the Ford driving public.

### DREDNAUT

#### SHOCK ABSORBER FEATURES

Vanadium Steel Coil Springs. Attachment is direct to chassis and body; leaf springs are not interfered with.

Coil spring reduces recoil of leaf spring and neutralizes shock.

Rebound Check is positive and a supplementary rubber bumper prevents metal-to-metal contact and absorbs minor vibration.

Side-sway and body roll is eliminated through radius link of small diameter. All castings and drop forgings are made according to S. A. E. specification.

No fittings or connections touch the leaf springs—therefore the leaf spring action is not hindered.

*Dealers*—There is an unusual opportunity in Drednaut Shock Absorbers, and some desirable territory available. Ask us about it—it will pay you.

**AUTO SPECIALTIES MANUFACTURING COMPANY**

330 Graves St., St. Joseph, Mich.

Tecumseh Road, Windsor, Ontario

## Showing Detail of

**SURE START**

Electric "Hot-Spot"

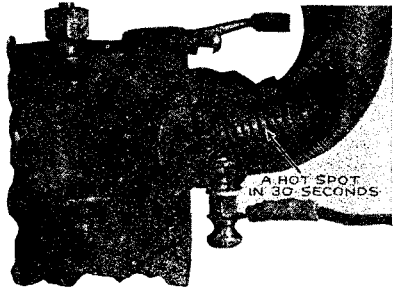
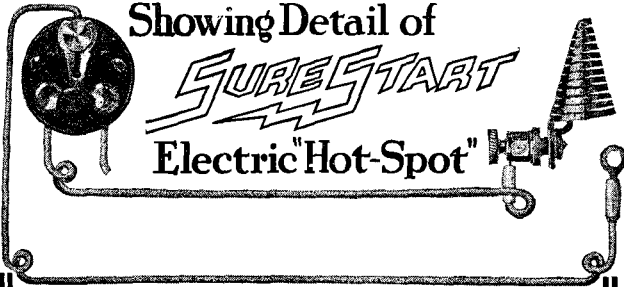

A "Hot-Spot" That Is  
**Hot Before Motor Starts**

**S**URE START Type "A" is made in sizes to suit all cars having "detachable" manifolds. The Ford Special and 1-inch size can be operated by 4 to 6 dry cells on cars not battery equipped.

**FORD SPECIAL, complete, price \$3.50**

**Other Sizes for All Cars**

**FOR SALE BY DEALERS AND GARAGE MEN.**

**Liberal Discounts and Display Set and Card  
 With Every Dozen Order.**

**DISTRIBUTORS WANTED**

**MOTORISTS—Install "Sure Start." PRIME WITH HEAT.** That's usually what is lacking when your motor won't start. Switch off when motor is hot.

**Manufactured by**

**EDWIN L. WIEGAND COMPANY**

**422 First Avenue, Pittsburgh, Pa.**

**SPRAYED GASOLINE STRIKES  
 HEATED CONE  
 "SURE START"  
 SWITCH ON A MINUTE**

1. **STARTS YOUR CAR INSTANTLY—** Summer or Winter; any kind of gas.
2. **RELIEVES STRAIN ON BATTERY—** Reduces use of starting motor.
3. **INCREASES MILEAGE—** You can start and run on leaner mixture.
4. **REDUCES OIL DILUTION—** It feeds motor with real vapor, instead of sprayed gasoline.
5. **CONSTRUCTION IS SIMPLE—** No moving parts, easy to install, requires no adjustment; can't wear out.
6. **MADE IN SIX SIZES—** Ford special and 5 others.
7. **THIS DEVICE REALLY COSTS MOTORISTS NOTHING—** Pays for itself by saving in battery repairs, time, gas, oil and work.
8. **CAN BE INSTALLED IN 30 MINUTES** without the use of special tools.

If your dealer or garage does not stock, send us the amount and we will see you are supplied.

**AN INTERESTING TIMER**

The Mallory Single Unit Timer is claimed by its manufacturers and by ignition experts to be the greatest ignition device ever developed for Ford cars. This new Timer offers many unique and novel advantages. Ford owners with battery equipped cars can entirely eliminate the vibrating points on all four coils. This is done by screwing down the points to a locked connection. Such conditions as faulty condensers, worn out coils or burned vibrating points do not interfere with the perfect functioning of the Mallory Timer in the least—the same normal spark is generated in spite of these adverse conditions which when associated with other timers would be serious obstacles to efficient ignition. Since the vibrating points are eliminated entirely, there is no necessity of having the coils equipped with any points at all.

When Fords are not supplied with batteries the vibrating points are left open. Either with or without a battery, however, all arcing is eliminated and since arcing is the cause of timers wearing out, the Mallory timer is claimed to last the life of the car.

No high tension distributor is used and the original plan of wiring is maintained; that is the secondary coil wires lead directly to the spark plugs and the wires which are attached to the timer are the low tension wires from the coils "primary" circuits.

This device is manufactured by the Milwaukee Engineering & Tool Company and it is being distributed by the Auto Products Company of Chicago which latter concern are the national sales representatives.

**BROWNIE OIL FILTER**

It has been the custom with automobile owners to throw away the lubricating oil, as soon as it became too dirty for further use. This was due to belief that it was of no further value, or else because they had no means for removing the dirt. As a matter of fact, the oil is not ruined, but is as good as new, after the dirt has been removed. Any unburned gasoline in the oil does not harm it, but simply lowers its viscosity

and this may be brought back to any desired value, by simply mixing with it, a higher viscosity oil.

The Brownie Oil Filter, is a simple and efficient filter which removes the dirt from any kind of oil and makes it as clear as new oil. The filter is composed of a strong, durable tank which is provided with a drain cock. A neat, snugly fitting cover fits over the top, thus preventing any dust or other foreign matter from getting into the clean oil compartment. A special fibre filtering tray fits into an opening in the cover, into which the dirty oil is poured. This tray is left uncovered, so that any unburned gasoline will evaporate.

The filter is finished in brown enamel and makes a very neat appearance.

Since the oil companies have started their oil changing stations, automobile owners are beginning to realize that the dirty oil does have some value and that they may as well reclaim it themselves.

In addition to the saving of the oil, the life of the engine is greatly increased by keeping the oil clean, therefore it has been found to be very advantageous to remove the oil from the engine frequently and filter it, thus not allowing it to become as dirty as has been the practice heretofore.

The filter sells for \$2.50 prepaid and is made by A. J. Brown, 376-31st St., Milwaukee, Wis.

**MAKE ASKE ELECTRIC VAPORIZER**

In the October issue of this magazine we spoke of the Aske electric vaporizer as being manufactured by Horgan-MacDonell company of Chicago. This was an error as that company acts as sales representative. The manufacturers are Kase Electric Company, Sherwood building, Duluth, Minn. The Aske Electric Vaporizer consists of four metal screens, electrically heated and mounted in a durable case. The current is supplied by the storage battery and controlled by a switch on the dash board. Current is applied to the vaporizer about ten seconds before starting the motor. After the motor is started the current is turned off.

**Here's Perpetual  
Accident Insurance**

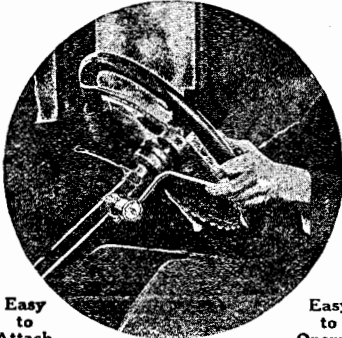

Easy  
to  
Attach

Easy  
to  
Operate

**The Gilbert**



**ATTACHMENT FOR  
FORD HORNS**

is a simple lever arrangement that can be readily attached to any Ford which has the horn button on the steering post. No boring, no riveting—no change whatsoever—simply slip the cap of the attachment over the horn button and **TIGHTEN THE SCREW PROVIDED**. The attachment is always at the finger tips—entirely clear of the spark and throttle levers—and can be reached immediately **WITHOUT MOVING THE HAND FROM THE WHEEL**. Guaranteed for life of car. If your dealer cannot supply you, send his name and \$1.00, and we will send a Gilbert Attachment, postpaid.

**DEALERS—JOBBERS**

Stock this greatest of all Ford accessories now. A quick turn-over proposition at a low price with a big profit to you. Write today and get in on our national advertising campaign.



Rather  
Safe

Than  
Sorry

Manufactured by  
**A. GILBERT & SONS**  
**BRASS FOUNDRY CO.**  
4000 Forest Park ST. LOUIS, MO.

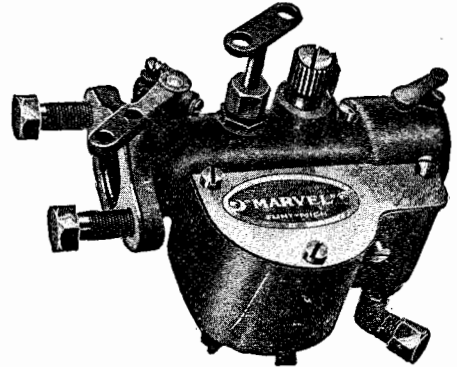

**THE MOST POWER AT THE LEAST COST**

Real economy consists of getting the most power at the least cost. This is positively accomplished through the use of

**THE MARVEL CARBURETOR**

The Marvel, Model N Carburetor is a horizontal type, side opening, two jet instrument, designed especially to meet the needs of Ford owners who demand a powerful and economical carburetor. Simple in design—but one moving part, the auxiliary air valve, which proportions the mixture to the demand. No excess amount of gas on the low speed needle in order to have power enough at high speeds, is necessary only sufficient gas to give proper idling and low speed performance and the high speed jet is then only called upon as the motor demand increases. Uniform carburetion at all speeds and maximum economy of fuel. PRICE \$10.00 F. O. B. Factory. A 30 day trial—money back if not satisfactory—protects you. No extra fittings necessary.

DEALERS—Write today, seeing is believing.

**MARVEL CARBURETOR COMPANY**  
Flint, Michigan, U. S. A.



Lap Score Marks Out of  
Cylinders with

**Clover Cylinder Lapping Tool**  
and  
**Clover Valve Grinding and  
Lapping Compound**

Free bulletins No. 75 and 80 tell you all about it.

WRITE FOR THEM

**CLOVER MFG. COMPANY**

512 Main Street Norwalk, Conn.  
Branches: Chicago, San Francisco.

**SPEEDWAY BODIES for FORDS**

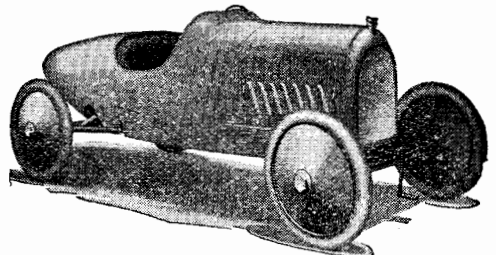

AND UNDERSLUNG PARTS.  
**MORTON & BRETT** INDIANAPOLIS, IND.



# PHOENIX BURNING-IN MACHINE

*For Every Make Motor - Car - Truck - Tractor*

Features such as three-to-one gear reduction, screwstatic type fibroid cone clutch, universal couplings, silent operation, ease of alignment, universal limbering-up attachment, strength, simplicity, rigidity, etc., have made the Phoenix machine the foremost burning-in and running-in machine of America.

Every part is of Phoenix quality and Phoenix standard throughout. You need its weight, stability and capacity.

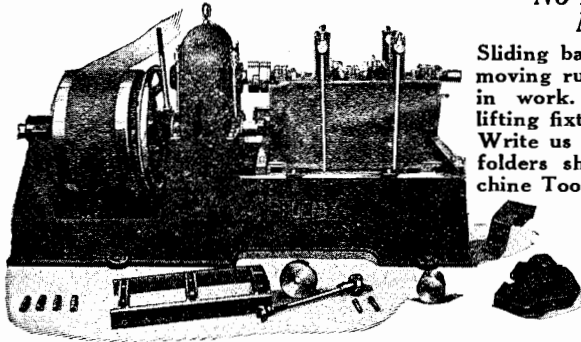

Burning-In Fordson Motor

*No Lifting of Fixtures  
No Oil Draining*

Sliding bar arrangement eliminates removing running-in fixture for burning-in work. Saves oil draining—Saves lifting fixture half full of oil—Saves oil. Write us today for full particulars and folders showing Phoenix Garage Machine Tools in action.

**Phoenix Mfg. Co.**

Dept. 00

EAU CLAIRE, WIS.



**HANDY HANDLES**  
FOR FORD DOORS

**HANDY HANDLES**  
FOR FORD DOORS

**WHY NOT? HAVE DECENT HANDLES ON YOUR FORD?** Slip Right Over the Regular Ford Handles

—a couple turns of a screw driver and they're on. Spick and span, black enameled on solid castings.

**THREE FOR A DOLLAR**—or 40 cents for one. **HANDY HANDLES** give just the right "gripping" shape and the increase in leverage length makes opening doors easy.

No more straining, and bruised fingers.

**AT YOUR DEALERS—OR PIN A DOLLAR BILL TO A LETTER.**

**RACINE SCREW WKS.**

Dept. F—RACINE, WIS.

**ONLY  
10 inches  
HIGH**

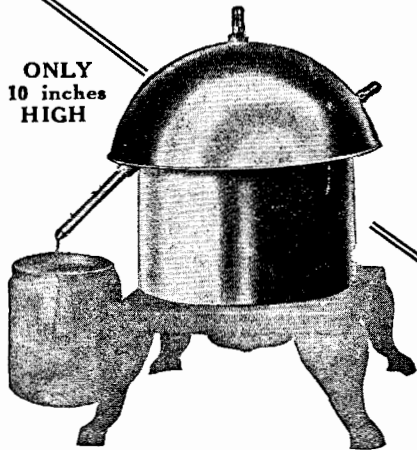

**BATTERY SERVICE**

Can be right only when the water is right. Equip your service station to supply only

**DISTILLED WATER**

Distill approximately one gallon an hour—24 hours a day—every day in the year—without attention, trouble or annoyance. Use the new, efficient

**CLEVELAND AUTOMATIC Water Still** Made of heavy solid copper, highly polished—set up anywhere. Price only \$40.00.

Write today for full details and dealer discount.

**CLEVELAND WATER STILL CO.**

490 Prospect Avenue, CLEVELAND, O.

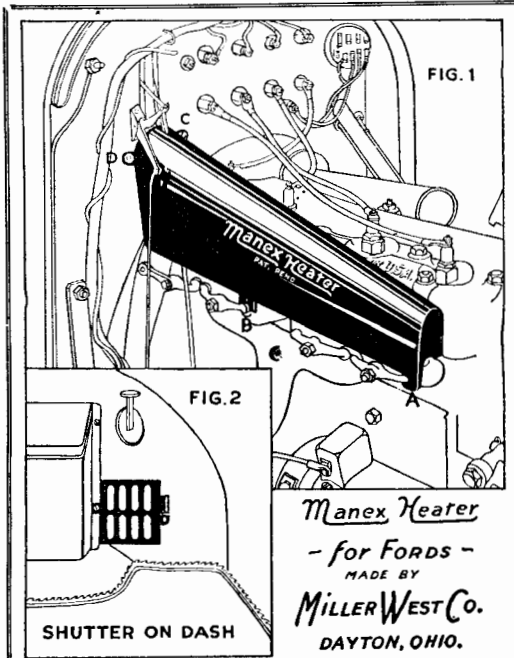

The illustration above shows the method of attaching the Manex Heater to Ford cars. The dome-shaped air chamber completely covers the exhaust manifold so that a large volume of pure warm air flows into the car sixty seconds after the motor is started.

## Manex Heater For Ford Cars

It is the standard by which all others are judged. There is nothing complex; nothing that may be broken. It is as practical as it is simple.

The Manex is easily installed by any Ford owner and may be quickly removed in the summer. Does not cut through and weaken floor boards or damage carpet. Heats only fresh air no dangerous exhaust gases or smoke.

**PRICE \$3.00  
ONLY**

Write for Folder Giving Ten Points of Manex Superiority.

DEALERS—The Manex Heater is sold by several of the largest auto supply jobbers. If your jobber hasn't it in stock, wire us. We will get immediate action.

### The Miller-West Co.

222 Dayton Savings Bldg. DAYTON, OHIO

The Manex Makes Winter Motoring a Pleasure

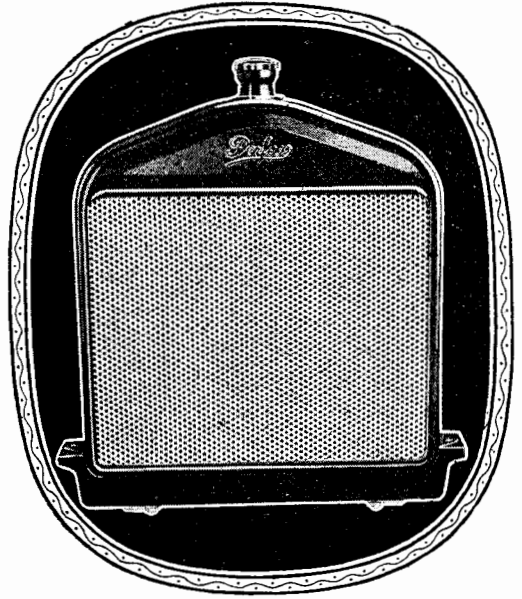

## for Ford Cars

The New Perfix is considered the most substantial of Ford radiators. And why not? It was originally built for gruelling tractor service.

Its bronze core, patented spring bracket suspension and reinforcing plate sturdily withstand the weaving and spreading of the Ford frame. Its bronze core yields generously to expansion and contraction caused by heating and freezing. Its bronze core resists tenaciously the chemical action of lime and alkaline water.

Years of specialization are back of Perfix Ford Radiators. Their special .005 bronze is formed—not drawn and thinned. The cellular air passages have no fins to catch dirt. The big water channels don't clog.

Authorities agree that Perfix Radiators outlast and outcool all others. They are priced on a competitive basis. Write for details.

### Perfix Radiator Co.

Dept. J, RACINE, WIS.

# PERFEX

THE PERFECT RADIATOR

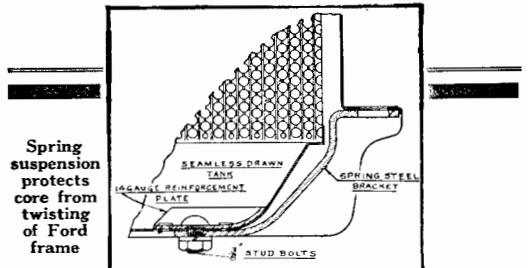

#### Direct Factory Representatives

- Chicago—Standard Motor Parts Co., 1420 South Michigan Ave.
- Minneapolis—Beson-Doxey Company, 600 Wilmac Bldg.
- Nashville, Tenn.—Hirsig Sales Co., 908 Broadway
- Boston—The Brown Supply Co., 51 Chardon St.

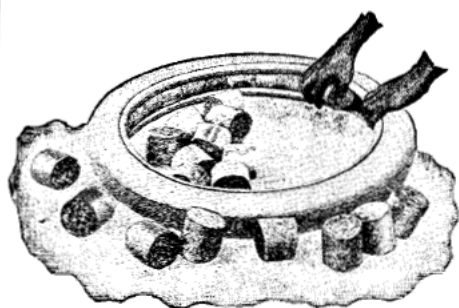

## SELLING BETTER THAN EVER

Car owners nowadays are keenly interested in low upkeep—on tire mileage especially. That is one reason why so many of them are adopting

### **NATIONAL RUBBER TIRE FILLER**

It does away with punctures, blow-outs, vulcanizing, patching, tire-troubles and repairing of all kinds. Users get from 10,000 to 20,000 miles out of every tire—and have no inner tubes to buy.

National Rubber Tirefiller has a wonderful resiliency—takes the place of air and rides as easy.

Made in sizes to fit all standard tires. Can be used on all makes of cars using pneumatic tires. A big seller because it has made good

DEALERS—WRITE TODAY FOR  
COMPLETE DATA

### **National Rubber Filler Company**

210 College Street,  
MIDLOTHIAN, TEXAS

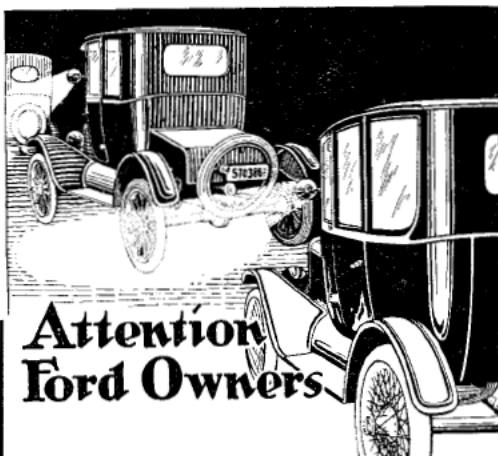

## **Attention Ford Owners**

**I**NTRODUCING to you the Innercontrol Spot-lite for Ford Cars—the greatest Ford accessory ever! It's the only spot light operated entirely from within your car—it eliminates entirely the necessity of lowering and raising windows or unfastening curtains—there's no stretching your arm into the cold, damp air while a chilly wind whistles down your coat collar.

This new Ford model has all the quality construction and exclusive features that are found in the Innercontrol models for higher priced cars—but it sells for less.

Wise Ford owners will avoid spot light discomfort this winter by installing an Innercontrol—live dealers will get their share of this business by stocking the Innercontrol now. If your jobber is out of them—wire or write us.

# **INNER CONTROL**

## **SPOT LITE**

FOR FORD CARS

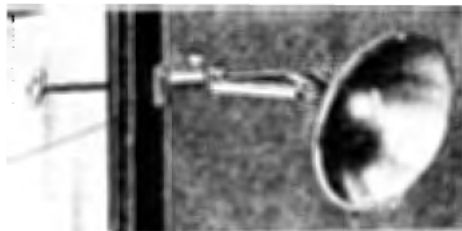

PRICE \$11.00

### **The Cincinnati Lamp and Bracket Co.**

316 W. 4th St. CINCINNATI, O.



## Fine Car Builders Use Plate Glass

The builders of good cars use plate glass. They wouldn't think of common glass—for they are fussy about every feature, to the last touch of the upholsterer to leather or velour. They aim at performance and appearance all through, so they use plate glass for both, in windshields and windows.

Plate glass is, then, the only kind for replacements when accident shatters any auto-glass. Through it the driver will see as if there were no glass there at all. His eye will be unhampered by humps and bumps, prisms and waves. Install plate glass. It goes easily into place. It doesn't sag. You don't lose money through breakage. You don't have to force it into place.

PLATE GLASS MANUFACTURERS of AMERICA



Nothing Else  
is Like it

## FORD MODEL

FITS EVERY MODEL T FORD

Simply remove a front hub cap and replace with the Dreadnaught Indestructible Hub Odometer. The Automatic Drive snaps into engagement and from that moment you get a continuous record of all travel forward or backward.

SALES AND SERVICE EVERYWHERE.

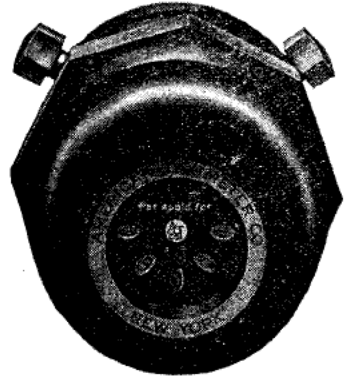

## DREADNAUGHT INDESTRUCTIBLE HUB ODOMETER

With Automatic Drive

**H**OW much does it cost you to operate your Ford? Unless you know the mileage you can give no intelligent answer to this question. The Dreadnaught Indestructible Hub Odometer gives you an accurate record of every mile of travel throughout the life of your Ford. It goes on like a hub cap, no drilling or pinning—the Automatic drive takes care of that.

The Price is Fifteen Dollars.

**AMERICAN TAXIMETER CO.**  
12 West 61st Street,  
NEW YORK, N. Y.

Guaranteed for the life of the vehicle against leakage of grease or destruction by collision.

Special Odometer now made for Fordson Tractors—\$20.

# SMOOTH-ON

TRADE MARK REG. U.S. PAT. OFF.



## IRON CEMENTS

For  
**Repairs on Your Car**

Carry Smooth-On in your tool chest or in your garage—it will save you expensive repair bills.

Use Smooth-on Iron Cement for repairing cracks in waterjackets, setting loose hub caps, repairing leaky radiators, screw-thread joints, etc.

### SMOOTH-ON for Leaky Radiators



Know more about this sure repair cost-cutter, send for our Motor and Home Repair Booklet No. 263 illustrating many repairs—it's FREE.

Sold by Supply Houses.  
**SMOOTH-ON  
MFG. CO.,**  
Jersey City, N. J.,  
U. S. A.

### COMPETITORS ACKNOWLEDGE

## The Superior Qualities of The Fansteel Magneto Break Timer

For  
Ford Cars, Trucks and Tractors.

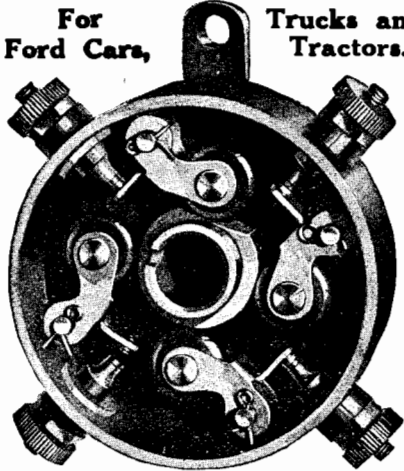

**SAVES GAS INCREASES MILEAGE  
NO OIL REQUIRED**

Licensed Under Patent No. 1,340,857

**WRITE TODAY TO  
W. J. WALSH  
526 MONADNOCK BLDG. CHICAGO**

### No More Rear Axle Troubles After Applying THE MASTER DOUBLE TRUSS ROD

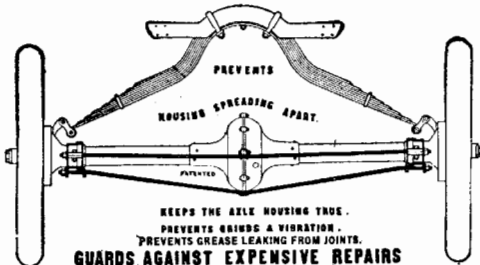

The Most Durable Truss Rod Made  
The Truss Rod Minus Competition

Both rods counteract the effect of the jars and jolts of the road, prevent vibration, breakage, grease leaking from housing joints, etc.

The bottom rod relieves all vertical strains.  
The rear rod relieves all horizontal strains.

**The Master Applied Today—Saves Repair Bills Tomorrow.**

Insist on the Master Double Truss Rod—thereby avoid inferior rods now flooding the market.

If your dealer cannot supply order direct.  
Price \$4.50

**THE MASTER PRODUCTS CO.**  
1142-46 Belmont Ave., Chicago.

## DORR MILLER DIFFERENTIAL

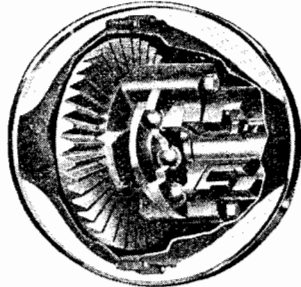

### You Don't Need Chains

HIS positive drive differential for Ford and Chevrolet 490 cars does away with the necessity for chains. It is interchangeable with the present differential, and is guaranteed to overcome spinning, skidding and getting stuck in mud or snow, by keeping power applied to both wheels. This is something you absolutely need on your car.

Write today for our 30 Day Free Trial Offer.

Unusually attractive business opportunity for representatives  
**THE TOLEDO AUTOMOTIVE  
PRODUCTS CO.**  
TOLEDO, OHIO.

# WITHOUT A SHUDDER OR CHATTER I Shift From High to Low and Run 7000 Miles Without Touching My Hands

No More Hot Feet Driving My Ford!

Read what men who rebuild, repair, own and operate Fords say of

Gentlemen:

No Accessory that has ever been put on the market to date, commands as much attention as your "Yale Transmission Band Oiler.", because it is really an added asset to the Ford car. It lubricates the Transmission Bands at all times, irrespective of conditions. The PERMANENT FILAMENT OF OIL BETWEEN ANY TWO RECIPROCATING SURFACES stops wear in anything of a mechanical nature.

The Yale Oiler provides a sufficient flow of oil over the Transmission Band and will always keep them soft and pliable, doing away with the hardened conditions that usually exist after a short time and which means unnecessary replacement.

Sincerely Yours,  
**JOSEPH HAAS**  
Manager.

This Man Uses Hundreds of Yale Oilers

## The Yale Transmission Band Oiler

One of the most widely known Ford Dealers in all the Greater New York territory, who has handled daily for years as many Fords as some handle in a month, is the firm of Couch & Haas. The BIG Ford Firm of Brooklyn.

**They Know.** A Real First National Guarantee  
**SOUTHERN COUNTIES GAS CO., Los Angeles,**  
wrote: "Send us to Santa Ana 100 Yale Oilers for our fleet of 100 Fords."

If we could see you personally, take off the crankcase cover of your Ford, start or crank the engine and let you SEE what becomes of the oil, then slip a YALE in position and let you see how completely the bands are oiled—some call it lubricated, you would not hesitate a moment. You would SEE FOR YOURSELF how and why the YALE OILER improves the FORD as nothing else has done since the first Ford was made.

**Order a Yale for Your Ford Today. Price \$1.00**  
Or send for "The History of a Great Invention" FREE.  
Money back if you return oiler.

**THE YALE CORPORATION, Manufacturers**  
602 I. W. Hellman Bldg., LOS ANGELES, CALIF.  
600 West 186th St., New York City  
**DEALERS—A postal will bring a copy of the Yale-Ford News.**

### COUPON

Send me more information regarding Yale Oilers, with "History of a Great Invention." I enclose \$1.00 for a guaranteed Yale Oiler.

Name \_\_\_\_\_  
Address \_\_\_\_\_

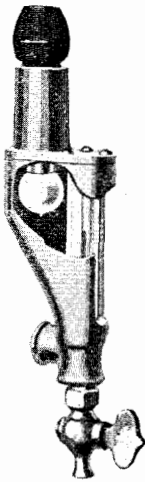

## SAVE With This Convenience

You know the troublesome con-tortions and clothes-soiling which you experience now in de-termining the amount of oil in the crankcase.

Now have the convenience of the

## PRITTI SLIK ELECTRIC OIL INDICATOR

By simply pressing the button on the dash under the hood, flashing the light behind the gauge glass plainly indicates your oil level, through dirt and grease.

The installation of the Pritti Slik Electric Oil Indicator on the crank case, as shown in the accompanying illustration, is self-explanatory. Securely attached in a few minutes of time. Connects with any type of ignition or lighting system. Equipped with regular 6-8 volt tail light bulb, necessary wire fittings and press button switch.

Positively the neatest, most satisfactory oil indi-cator on the market. Price \$5.00. Everywhere.

**DEALERS—DISTRIBUTORS:**  
Write for exclusive proposition.

**AUTOMATIC AUTO LOCKS, LTD.**  
251-259 Second St., SAN FRANCISCO, CAL.

# BURD Quick-Seating PISTON RINGS One Piece



**Easy  
To  
Install**

**List Prices (Subject to Trade Discount)**  
All diameters to 4 in. inclusive.....60c each  
All diameters over 4 in. to 5 in. inclusive, 70c each  
**Burd High Compression Ring Co., Rockford, Illinois**

## Door Locking Handles For Ford Sedans and Coupes

### "THE LOCKING HANDLE WITH THE SAFETY PLATE"

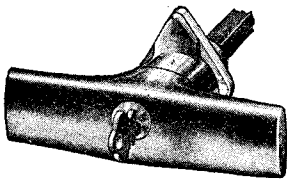

No. 124 F LOCKED  
Safety Plate Covers the Screws



All Cowles Locking Handles are operated by this style key. Different Key for Each Car.

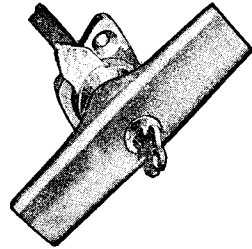

UNLOCKED  
Easy access to screws when handle is turned.

The Safety Plate (patented) prevents removal of escutcheon screws when handle is locked. No real security without it.

Made in a wide variety of patterns. Liberal discounts to dealers  
Send for folder

# C. COWLES & CO., NEW HAVEN, CONN.

### Standard Radiator Cover



### Spring Shutter Radiator Cover



Half Open

F. O. 477A Ford Rad. Cover only \$1.95  
F. O. 477B Ford Hood Cover only 3.00

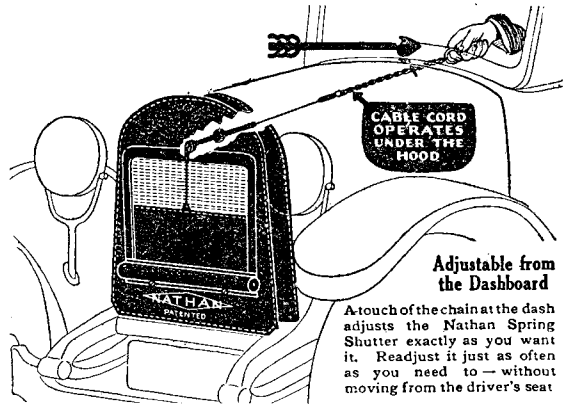

Adjustable from the Dashboard

A touch of the chain at the dash adjusts the Nathan Spring Shutter exactly as you want it. Readjust it just as often as you need to — without moving from the driver's seat

F. O. 361 Ford Radiator Cover only \$8.00  
F. O. 477B Ford Hood Cover only 3.00



All Nathan Radiator Covers are made of a fabric coated with rubber and rubberized to lining — the best cold resisting and heat retaining fabric (see cut).

Write for catalog and discounts, show card and window display.

Nathan Novelty Mfg. Co.,  
Dept. F. O. 55 Fifth Ave.  
NEW YORK CITY



# Champion

## Dependable Primers

### Make Speedy Work of Starting Cold Engines

A necessity for motorists who keep their cars in unheated quarters and for those whose business requires everyday use.

Save time and battery, for your motor fires instantly with these plugs that introduce the priming gas into the cylinders at the one most effective spot.

All Dealers Sell Champion Primers—Cost Only \$1.25 Each  
Now Is the Time to Install Them for Your Winter's Driving.

**CHAMPION SPARK PLUG CO.**

TOLEDO, OHIO

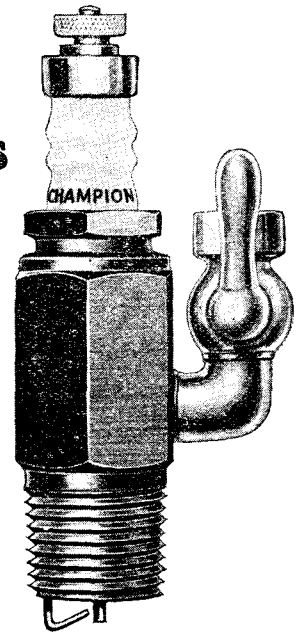

# The FORD SPECIAL STORAGE BATTERY

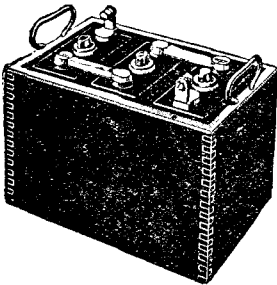

# \$16.75

*F O B Kansas City - - Fully Charged  
Ready for Installation*

NO MIDDLEMAN'S PROFIT. SHIPPED DIRECT FROM FACTORY.

**A SPECIAL**

Rugged constructed, long lived storage battery. Designed by expert Battery Engineers to withstand the hard knocks and rough use on Ford Cars.

*Guaranteed for One Year*

**Independent Storage Battery Company**

Accompany order with  
draft or post office  
money order.

Gateway Station  
KANSAS CITY, MO.



# Would You Invest **\$250** To Save **\$3500?**

Attached in 2  
Minutes.  
PRICE  
**\$2.50**

Strictly  
Guaranteed  
DEALERS and  
GARAGEMEN:  
We have a most  
interesting propo-  
sition.

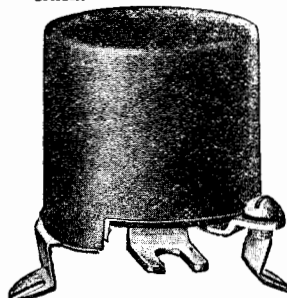

**T**HE LIFE OF YOUR STORAGE BATTERY and faithful operation of the entire Starting and Lighting System is directly dependent upon faithful operation of your GENERATOR CUTOUT. New York Cut-outs for Ford Cars automatically—without attention on your part keep the battery FULLY CHARGED and prevent WASTEFUL DISCHARGE—and have saved thousands of Ford owners the cost of a new storage battery.

Their construction represents the highest obtainable material, construction and workmanship. They are used by the best informed Service Stations and Garage Managers from Coast to Coast, who have learned that they are absolutely trouble-proof.

**NEW YORK COIL COMPANY**

338 Pearl Street

NEW YORK CITY

## Quick Detachable MAGNETO CONTACT POINT Insures Perfect Ignition

**N**O MORE greasy shirt sleeves, dirty hands, or backaches. Once this quick Detachable Point is installed. A necessity when Re-Lining the transmission of a Ford, as the Contact Point can be removed while removing the transmission cover, thus giving more space, and besides the Contact Point is not liable to be bent or broken, thus giving a rather poor contact after replacing the cover.

PRICE  
**\$1.00**  
POSTPAID

Dealers and Garagemen—Write for our very interesting proposition on this fast selling article.

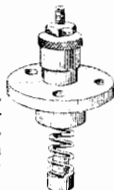

As Contact  
looks on Trans-  
mission Cover  
4 Point Con-  
tact Instead  
of one

### TO INSTALL

Simply remove old type contact point and replace in the same position the quick detachable assembly.



As Contact  
Point looks  
removed to  
clean  
Can be used  
as Ignition  
Lock if so  
desired

To remove, Clean and Replace this new type Plug requires but a fraction of the time ordinarily required, and WITHOUT THE AID OF A SPECIAL SCREW DRIVER.

**MERTON L. BRITT**

139 HUGO STREET,

SAN FRANCISCO, CALIF.

# REAL BUSINESS BRINGERS —K-D LAMPS



*Dandy, \$5.00*

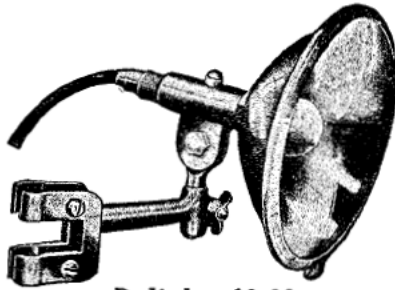

*Delight, \$8.00*

Every dealer knows that a vital part of his business consists of lamps.

K-D Lamps are absolutely unexcelled. For construction, for reliability and for margin of profit they're positively in a class by themselves.

Note the two spotlamps featured here. They're the most remarkable "buy" in the lamp world today.

Send for samples and jobbers' discounts.

Complete line of head, tail, side and parking lamps.

THE K-D LAMP CO.  
CINCINNATI, O.



## Avoid Needless Expense

There is just one way to avoid the expense and unsightliness of loose, cracked and rattling fenders on your Ford. Before the fenders break or loosen equip them with

### I-NE-DA FENDER BRACES

These practical devices keep your car looking trim and neat, prevent breakage from vibration and hold the fenders firm against wobbling and rattling. Inexpensive and easy to install they constitute a thoroughly practical and economical item. I-Ne-Da Braces are supplied in one style which fits all models including the one-ton truck chassis.

RETAIL PRICES: FRONTS—PER PAIR—\$1.25 REARS—PER PAIR—\$1.00

All Prices F. O. B. Kansas City.

DEALERS AND DISTRIBUTORS—Some Good Territory Still Open. Write Today.

Manufactured by I-NE-DA FENDER BRACE MFG. CO., Kansas City, Mo.

Sales Department **Buckley Motor Supply Company** 2005 E. 15th Street  
KANSAS CITY, MO.

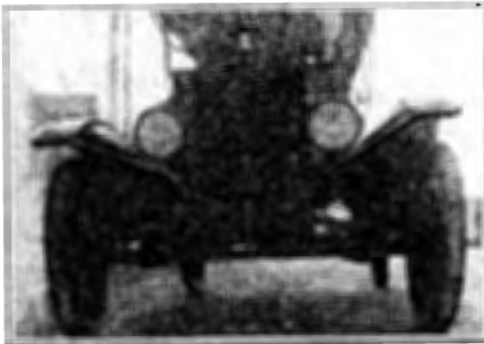

(Patent Applied for)

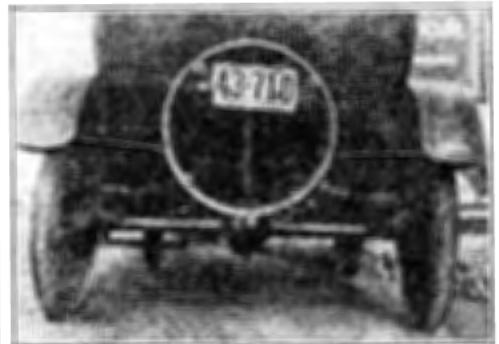

(Patent Applied for)

When writing advertisers—Just say FORD OWNER AND DEALER



## A Ford Sedan or Coupe Without Locking Door Handles is Incomplete

Basco Locking Door Handles protect the contents of the Ford Sedan or Coupe from thieves. Lock the doors and prevent the theft of robes, wraps, bags, packages, tools, etc.

Basco Locking Handles are furnished either "T" shaped as illustrated, or "L" shaped. Inside latch can also be supplied when it is desired to install only one locking handle.

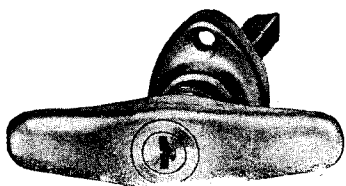

Ford T Shaped Handle No. 2183

FORD DEALERS—Ask Your Jobber or the Nearest Basco Service Station

**BRIGGS & STRATTON CO., Milwaukee**



**INSTALL  
a  
LYON FORD  
AUTOPARTS CONTROL**

## GIVE BEST FORD SERVICE

Parts Book arrangement—It is easy to secure parts.  
Plain label on each compartment—Anyone can operate.  
A compartment for each item—No shortages, you always have stock.  
Your repair men don't lose time getting material.

To start using a LYON Auto Parts Control—Put the parts in the bin. Even the labels are put on the compartments for you.

*Bulletin 106 gives all the details.*

**LYON METALLIC MANUFACTURING CO., Aurora, Illinois**

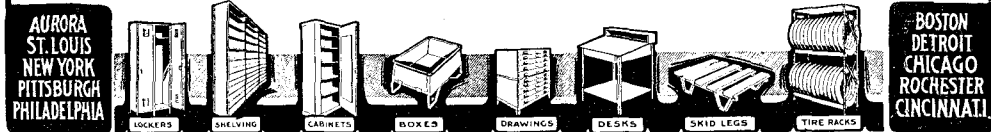

When writing advertisers—Just say FORD OWNER AND DEALER

## SUMMER COMFORT FOR YOUR CAR

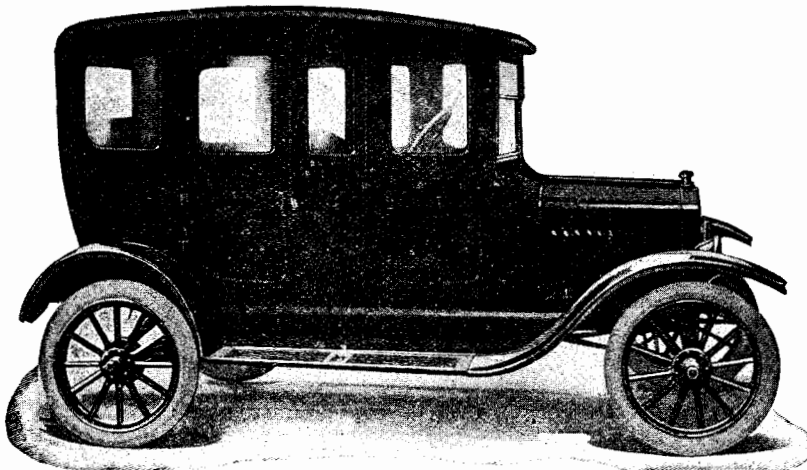

Cold weather is coming but it will not bother the hundreds of Ford owners who for comfort and economy have equipped their cars with the

### Kensington Closed Top

for Ford cars and Roadsters. The KENSINGTON is the completely satisfactory ALL-SEASON TOP. Designed for the utmost efficiency plus the most handsome appearance.

Built of wood reinforced with metal, covered with Fabrikoid and lined same as Sedan top. All glass set in wood frame and built into the

removable sides. Positively cannot be made to rattle. Complete instructions for installing furnished as well as materials, including door handles. You can do the work yourself.

You can have this quality and comfort at a small cost.

**PRICE COMPLETE FOR TOURING CARS, \$112.50—FOR ROADSTERS, \$85.00**

We pay war tax. Order now. The demand will be heavy.

**DEALERS—Others are reporting big sales. NOW is the season. Write or wire us today.**

**MONROE BODY CORPORATION  
LUDINGTON, MICHIGAN.**

## We Challenge Contradiction of Our Claims GET AN EXPERT'S OPINION

We are asked every day to explain wherein our TWIN SPRING SHOCK ABSORBER differs from the SHOCK ABSORBER in general use today. The answer is easy and clear to you. The great majority of SHOCK ABSORBERS in use today are nothing more or less than a brake applied on the leaf springs, which retards their action and prevents them from doing the work for which they were intended. They REDUCE the spring capacity of your car instead of INCREASING it, as should be the case.

### TWIN SPRING

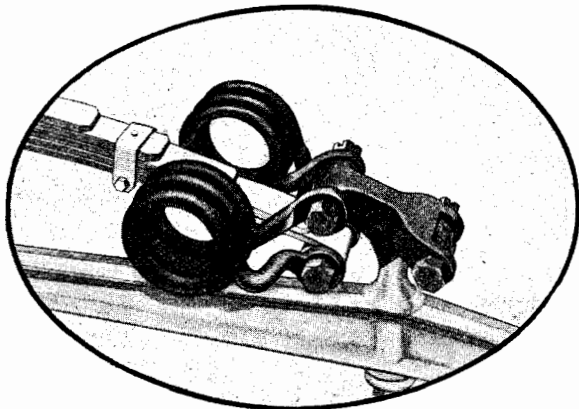

## SHOCK ABSORBERS

*For Fords*

Front and Rear Set Complete \$20.00 List

The TWIN SPRING SHOCK ABSORBER is a SUPPLEMENTARY SPRING, instantaneous in its action. The principle and result obtained therefrom is entirely foreign to the so-called SHOCK ABSORBER. TWIN SPRING SHOCK ABSORBERS are FREE TO ACT in every way in conjunction with the LEAF SPRING. They not only leave the LEAF SPRING free to perform the work for which they were designed, but they assist them to perform that work. Every road shock coming from the wheels passes through the TWIN SPRING SHOCK ABSORBER (see those coils) on its way to the body of your car. The shock is transformed and reduced, the LIFE is taken out of that shock right there, and that without in any way disturbing the action of the leaf springs. Let us prove to you, Mr. Car Owner, that our statements are correct.

**TWIN SPRING SHOCK ABSORBERS** add to and do not detract from the lines of the car.

Write for Agent's Proposition and Prices

**TWIN SPRING SALES CO.**

266 Essex St.,

SALEM, MASS.

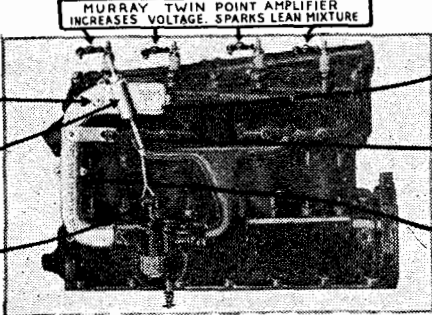

**MURRAY TWIN POINT AMPLIFIER  
INCREASES VOLTAGE. SPARKS LEAN MIXTURE**

**THERMO-STATIC PORT HOLE**  
KEEPS 180° F. TEMPERATURE

**COILED THERMOSTAT**  
ATTACHED TO NEEDLE VALVE CONTROLS GAS

**JUST ENOUGH GAS**  
AT JUST RIGHT TEMPERATURE FED AT ALL TIMES

**7 OPERATIONS DONE IN 5 MINUTES**  
ATTACHES THE F. & G.

**ONCE ATTACHED**  
NEVER NEEDS ATTENTION

**OUTLASTS ANY CAR**

F. & G. Automatic Fuel-izer—For Fords and Dodge Cars

## The F. & G. AUTOMATIC FUEL-IZER

**MAKES BIG SAVING IN GAS**

A trial convinces any Ford owner, and this trial can be made under our absolute guarantee of complete satisfaction or money refunded. Whether you are a Ford owner—Dealer—or Garage Man it will pay you to give the F. & G. a chance to prove its claims. That's all we ask.

**THE REASON**—Perfect motor action and consequently lowest gas consumption and greatest mileage can only be secured when vaporized gas is fed at 180° F.—the temperature of perfect combustion. The Automatic thermostatic control of the F. & G. Fuel-izer ALWAYS assures you of a steady feed of vaporized gas at this temperature under any and all operating conditions.

**GIVES PERFECT COMBUSTION**

SEND FOR A FUEL-IZER TODAY

Hundreds of F. & G. Fuel-izers are already in use and are giving perfect satisfaction. SEE FOR YOURSELF. We'll send you one for your car—USE IT. If it doesn't cut your gas bills—give your engine more power, life, and responsiveness—in short satisfy you in every respect—you may send it back after 30 days' use and we'll promptly refund the low, introductory purchase price of \$10.00. Ask about the Murray Twin Point Amplifier that increases voltage—sparks a lean mixture—and fires a broken plug. It is shown above.

**NOTICE**—Agents, Dealers, Salesmen... We have a money-making proposition to high-grade representatives—grant exclusive territories—and back you up with national advertising circulars and booklets. Write or wire at once.

**FACTS**

The F. & G. Automatic Regulator is—

- Absolutely Automatic
- Thermostatically Regulated
- Practically Indestructible.
- Installed in Five Minutes
- A Big Gas Saver
- A Big Carbon Eliminator
- An Oil Conservor
- An Investment that Pays for Itself in a Short Time.

**INVESTIGATE!**

**THE B. & H. SALES CO., Dept. F. 11 431 S. Dearborn St., Chicago**

## Can You Afford A Broken Arm?

Ask any of your brother Ford owners who have had their arms broken by backfire when cranking the car if they enjoyed the experience. It cost them pain, lost time and cold cash. Can you afford this?

Then—right now—see to it that you put on your car the device which prevents any chance of accident. Install a

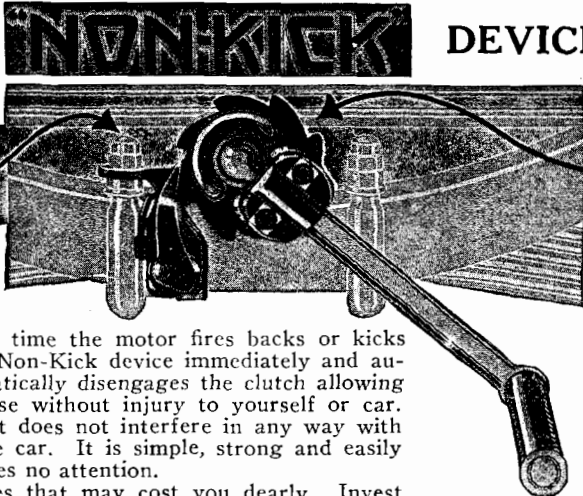

NONKICK

DEVICE

A child can put it on  
Only one nut to remove

Slips right on  
over the handle

**COST COMPLETE \$4.00**

Any time the motor fires backs or kicks the Non-Kick device immediately and automatically disengages the clutch allowing the motor to reverse without injury to yourself or car. At the same time it does not interfere in any way with the cranking of the car. It is simple, strong and easily attached and requires no attention. Stop taking chances that may cost you dearly. Invest now in a Non-Kick Device.

**DEALERS:**

No more practical or needed device was ever offered to Ford owners. Send for real proposition.

**NON-KICK DEVICE COMPANY**

KANSAS CITY, MISSOURI

**NOWURY TIMER AND EXTENSION**

100 PER CENT  
EFFICIENT

**PUT ONE ON YOUR CAR OR TRUCK**

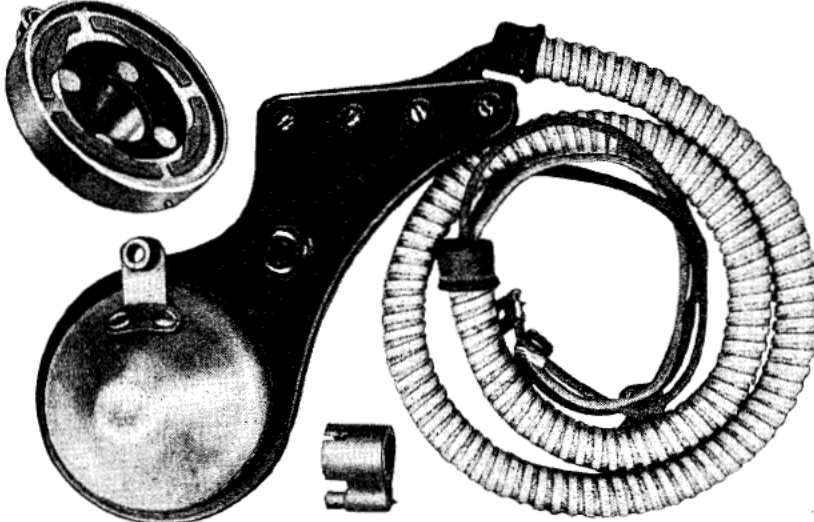

Use it for Ninety Days. If you are dissatisfied return it and get your money back. Every NOWURY Timer is guaranteed for the life of the car. All parts interchangeable and are replaced free of charge.

PRICE IN U. S.  
\$6.00 EACH.

East of Rocky  
Mountains

**NOWURY TIMER** has all of the good features and none of the bad ones. **THE ONLY PERFECT TIMER NEVER MADE** for Ford Cars and Trucks. You can go slower on high and pick up quicker than any high priced car on the market. Saves gasoline, does not require oil or grease and is water and dust-proof. **EQUIPPED WITH WIRES IN FLEXIBLE METAL CASING. ORDER NOW!**

YOU CAN GET THEM FROM  
US IF YOUR DEALER CAN'T  
SUPPLY YOU

**WORTHMORE**  
**Mfg. Co.**  
MINNEAPOLIS, MINN.  
14-16 Western Avenue

We want a live representative in every county in the United States. Write today for the territory you want. This is a real opportunity for the right man to make good.

**Johnson Carburetors for Ford Cars**

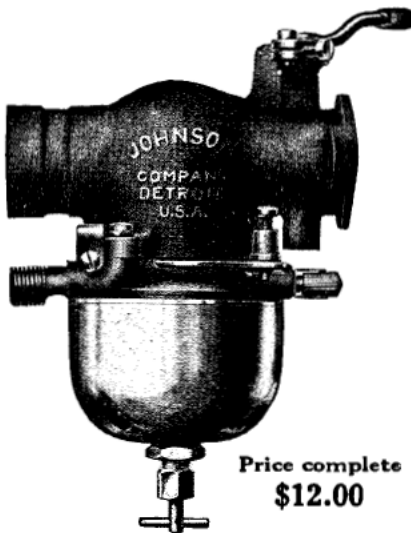

Price complete  
\$12.00

**Counts Every Drop of Gasoline.  
Makes Every Drop Count.**

**Strainers for Ford and  
Maxwell Cars.**



**Traps the Dirt. Fits Any Ford.  
Price \$1.25**

**JOHNSON COMPANY, 1909 Forest Ave. E., Detroit, Mich.**

# PRICES REDUCED

on

## SCHRADER UNIVERSAL PRODUCTS

ON AND AFTER November First, Schrader Products can be bought at the following reduced prices:

<b>Schrader</b>	<b>Tire Pressure Gauges, Now \$1.25 Each</b>
	Were \$1.50
<b>Universal</b>	<b>Truck Tire Gauges... Now \$1.75 Each</b>
	Were \$2.00
<b>Universal</b>	<b>Valve Caps... Now 25c</b>
	Were 40c (Per Box of Five)
<b>Universal</b>	<b>Valve Insides... Now 30c</b>
	Were 40c (Per Box of Five)

You need Schrader Universal Tire Valve Accessories to get the most mileage out of your tires. If your dealer does not stock them, send us his name.

### A. SCHRADER'S SON, Inc.

Makers of the Schrader Universal Tire Valve

BROOKLYN, N. Y.

CHICAGO

TORONTO

LONDON

## Keeps Trucks Moving in Winter Snow and Mud!

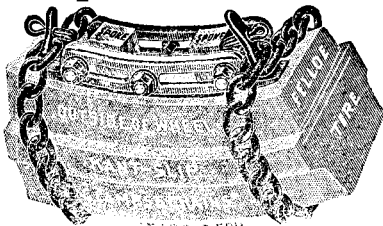

Who will pay for the time you lose this winter when your truck is stalled in snow or mud? Why experience this trouble, delay and cost at all? You can keep your truck operating all of the time with

### KANT SLIP CLAMPS AND CHAINS FOR FORD TRUCKS

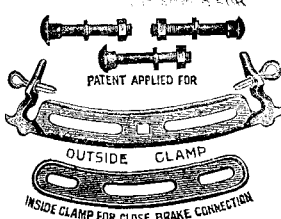

These clamps are attached permanently to the spokes in a few minutes and the chains can be quickly attached when emergency demands. They are equally serviceable on round or square spokes and solid or pneumatic tires. They assure traction and are proof against the delay due to bad winter roads.

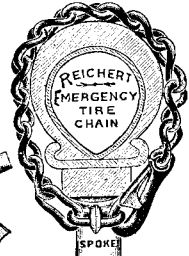
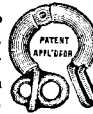

Do not wait until you need them. Get KANT-SLIP Clamps and Chains now.

**CAR AND TRUCK OWNERS**—Send for our complete catalog of truck and car chains before the roads are bad.

**DEALERS**—Stock now, a big business season is at hand. Send for complete information.

**EMERGENCY TIRE CHAINS**  
Every Ford owner should carry the Reichert emergency tire chain for car economy, tire and time saving. Simple, strong and serviceable.

### IMPERIAL BIT AND SNAP CO.

Department C

RACINE, WIS.

When writing advertisers—Just say FORD OWNER AND DEALER

## More Power and Speed—Longer Life

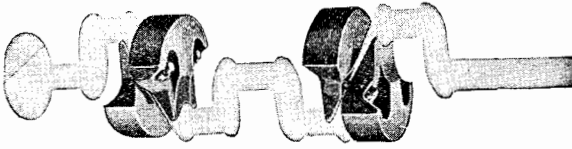

Many motorists fail to get the efficiency and pleasure they may from their motor. Vibration caused by an unbalanced crankshaft greatly decreases its power and speed and shortens its life. The motor doesn't run smoothly. There's no pleasure in driving that kind of a motor. Install a set of **Dunn Counterbalances** It's the sure way to overcome this trouble.

### DUNN COUNTERBALANCES

Dunn Counterbalances will stop the vibration at once. They will increase the power and speed of the motor and lengthen its life. It will run smoothly at any speed and driving will be a genuine pleasure. Dunn Counterbalances are guaranteed to give satisfaction. They can easily be installed by anyone in a few minutes. A wrench is the only tool needed. Get a set from your dealer or order direct. Jobbers, dealers and garage men find them active sellers. Write us for information.

#### This Valuable Book Is Free



Here's an interesting book that every Ford, Overland 4, Chevrolet 490 and Dodge car owner, every dealer or garage man will want. Complete and instructive. Tells how to prolong the life and increase the power, speed and endurance of automobile motors. Explains where acroplane and racing motors get their amazing power, and tells how the power of the above motors may be increased tremendously. Send a postal for it.

PRICES	
Ford .....	\$ 9.00
Overland 4.....	10.00
Chevrolet 490..	10.00
Dodge .....	12.00
<b>TERMS</b> —If your dealer cannot supply you, cash with order or C. O. D.	

**Dunn Manufacturing Co.**

Dept. F. D., Clarinda, Iowa.  
(Dunn Sales Co., 250 W. 54th St., N. Y.)

## FORD OWNERS—Here Is Closed Car Comfort

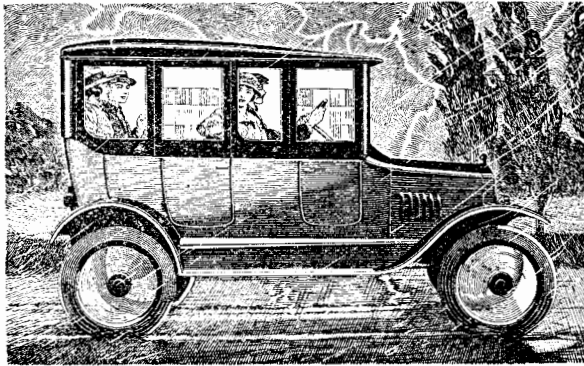

### Reduced Prices on Faultless 4 Season Tops

Use your economical Ford car the year around; install a **FAULTLESS 4 SEASON TOP**. No matter what the weather, you can ride in comfort, fully protected from rain or snow; plenty of cooling breezes for summer driving by lowering the windows and opening the windshield.

**FAULTLESS 4 SEASON TOPS** add to the appearance of your car; the frame is hard wood, well braced and ironed; rounded wood back overlaid with 20 gauge steel and then covered with waterproof artificial leather which also covers the roof. Tops are nicely painted and lined with gray limousine cloth. See your dealer today and order your top; if he cannot supply you, mail coupon below for circular. **DEALERS**—Be prepared to install **FAULTLESS 4 SEASON TOPS**. A money-maker for you. Mail coupon today.

AMERICAN AUTO TOP CO., Delphi, Ind. Dept. F.

Please mail me circular showing **FAULTLESS 4 SEASON TOPS**.

Name .....

Address .....

City .....

Please Check  
 Owner  Dealer State .....

**AMERICAN AUTO TOP CO.**  
**DELPHI, IND.**

Dept. F.

When writing advertisers—Just say **FORD OWNER AND DEALER**



## A Damaged McKinnon Radiator Is Easily Mended

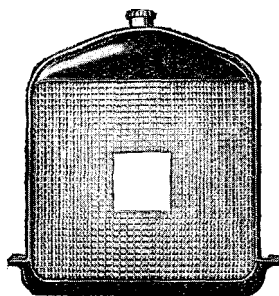

In case of damage cut out bad cells

In case your McKinnon Radiator is punctured in a collision, damaged cells can be cut out and new ones inserted. The radiator is then as good as new. The pictures show how simple a job it is.



That is just one of many advantages of the "really cellular" McKinnon Radiator. These cores are made by forming brass ribbon into

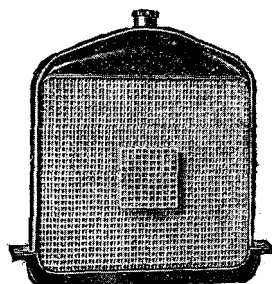

Put new section in place. Water circulates as before

a series of cells with vertical water passages between them. The whole core is tinned inside and out with pure solder, making a single rigid unit. No pinhole leaks are possible. Expansion prevents damage by freezing.

Over One Million McKinnon Type Radiators Are in Use on Overlands, Buicks, Willys-Knights, Oldsmobile 8's. Ask Their Owners.

### McKINNON DASH CO.—Radiator Division

250 AMHERST STREET,

BUFFALO, N. Y.

You Can Have a New McKinnon Core Put in Your Old Ford Radiator Shell. Write for Information.

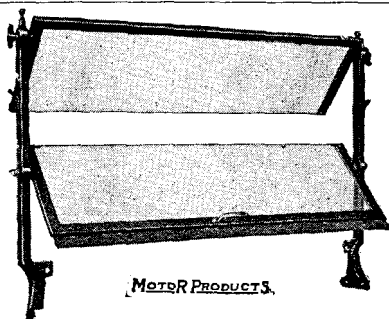

MOTOR PRODUCTS

## MOTOR PRODUCTS

### Rain Vision and Ventilating Windshields

FOR

### Ford Pleasure and Commercial Cars

MODEL 170

MODEL Z 17—For 1915 to 1921 Ford Pleasure Cars, where side oil lamps are desired. Supplied with plate glass.

MODEL 170—Same as Z 17 Model but without the side oil lamp brackets. Supplied with plate glass. For starter-equipped cars.

MODEL 150—For Re-Framing Glass of Regular Ford windshields; has side oil lamp brackets; everything except glass included.

MODEL 160—Same as Model 150 but without side oil lamp brackets. For starter equipped cars.

MODEL 100—For the Ford Truck. Supplied with plate glass. We can also supply slip dash for use with this shield at \$4.50 each.

MODEL 110—For Heavy Duty Trucks with extra wide dash. Supplied with plate glass.

Booklet 2000 Sent Free Upon Request

**MOTOR PRODUCTS CORPORATION, DETROIT, MICH.**

**DUAL CONTACT  
PREVENTS BURNING**

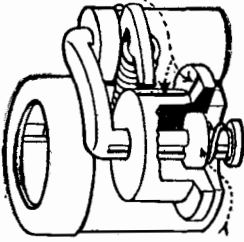

UNBROKEN WIPING CONTACT  
ELIMINATES ARCING ON  
THE SHAFT

**THE RUSH**

**Dual Contact  
Timer Roller**

Price \$1.50 Each

**THE RUSH**

**Adjustable  
Emergency  
Brake Shoes**

Price \$2.00 Per Set

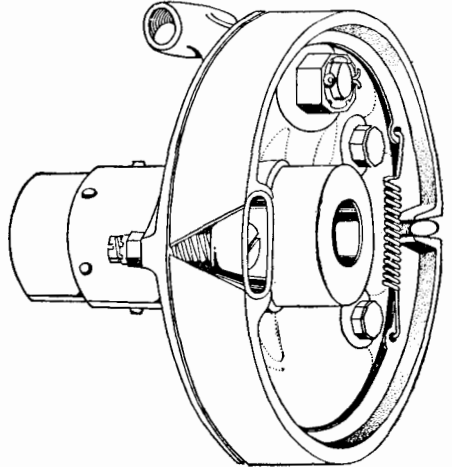

Just as the Rush Timer Roller has proven to be the **ONLY DEPENDABLE TIMER ROLLER** for Fords, so are the Rush Adjustable Emergency Brake Shoes proving to be the **ONLY DEPENDABLE BRAKE SHOES** for Ford Cars. They are easily adjustable without removing rear wheels (a screw driver and a wrench are the only tools necessary) and they can be adjusted so that the braking effect is the same on both rear wheels. They will outwear three or four sets of non-adjustable brake shoes.

**ABSOLUTE SATISFACTION GUARANTEED OR MONEY REFUNDED**

**THE HARTLAND CO., 1974 Broadway, New York**

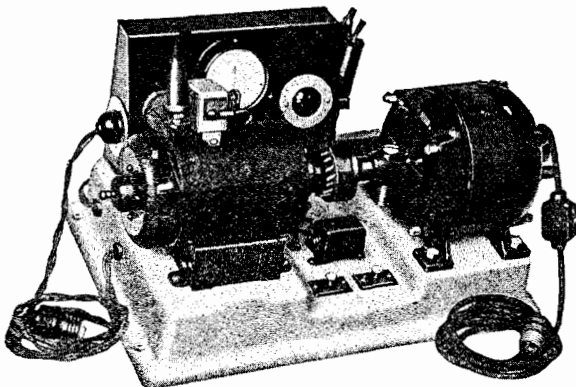

**For the Service  
Station or Garage**

Service station men have been looking for a satisfactory test stand for Ford generators and armatures which would do the work quickly and accurately. Here is the New

**ELMCO  
Junior Test Stand**

This is as efficient as the ElmcO Liberty model used everywhere

successfully and which sells for \$260. The ElmcO Junior is smaller and designed especially for Ford service needs... It costs only \$120.

The ElmcO Junior requires no clamps or holding vise to hold a generator. A growler, which also acts a magnetic clutch, holds a generator without vibration and like a vise of steel... All that is necessary is to pull the switch and the generator is locked securely in position.

A ¼ H. P. General Electric motor is used to drive the generator and the coupling needs no adjustment to hold the generator gear. A high grade ammeter and a voltmeter are mounted on the instrument board together with a trouble lamp and test prods. The switches which control the motor, cut-out and clutch are in plain sight and within easy reach. The base of the machine is made of aluminum.

*Your jobber has a stock. Order from him today.*

**THE ELECTRIC MACHINE COMPANY**  
INDIANAPOLIS, INDIANA

## R & R Automatic Grease Retainers

For Ford and Chevrolet Rear Axles  
Prevents loss of grease and from getting on tires, brake drums or wheels.  
No Special Tools Necessary to Install. Simply Remove Wheel and Roller Bearing, Insert R & R AUTOMATIC GREASE RETAINER and Your Grease Troubles Are Over.

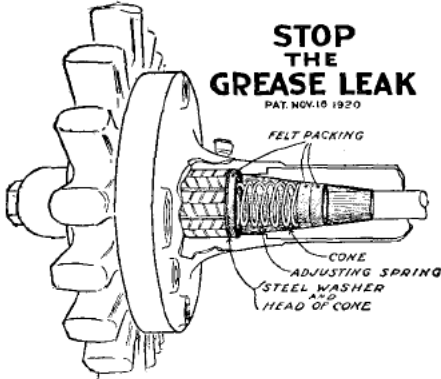

**STOP THE GREASE LEAK**  
PAT. NOV. 10 1920

If your garage man or dealer does not have it, send \$2.50 and a set of two will be sent you. Postage paid.

WRITE FOR EXCLUSIVE TERRITORY

Manufactured by

**THE MACORVEY COMPANY**

Wabash Building PITTSBURGH, PENNA.

## Send for this AUTOMOBILE HANDBOOK



301 pages  
156 illustrations

**\$1**

Everything you want to know about an automobile is explained in this I. C. S. AUTOMOBILE HANDBOOK. 301 pages—156 illustrations. The most complete little book of its kind ever printed.

Invaluable to the driver or owner who wishes to take care of his own car. Contains practical information on automobile troubles and describes the remedies in plain, simple language that any one can understand.

Just slip a dollar into an envelope—fill in the coupon and mail, and this I. C. S. Automobile Handbook will come to you by return mail.

*You run no risk! Money back if desired!*

----- TEAR OUT HERE -----  
INTERNATIONAL CORRESPONDENCE SCHOOLS  
Box 7161, Scranton, Pa.

I enclose One Dollar. Please send me—postpaid—the 301-page I. C. S. Automobile Handbook. It is understood that if I am not entirely satisfied I may return this book within five days and you will refund my money.

Name \_\_\_\_\_

Address \_\_\_\_\_

## FOR A PERFECT JOB OF CYLINDER LAPPING

There is one way to secure an easy, quick and perfect job in lapping cylinders or pistons. Use

### CYL-LAP

Cyl-lap is a harmless abrasive which combines the qualities of speed, high surface finish and positive removal of the lapping abrasive when the operation is finished. Does not contain severe abrasives or glass. Not imbedded in metal.

Send today for trial can

4 OZ. CAN, \$1.50

8 OZ. CAN, \$2.50

**Cyl-Lap Products Co.**

SEATTLE,

WASHINGTON

## For Weak MOTORS

New motors will perform up to scratch with almost any ordinary Piston Ring. Weak or worn motors won't. It takes

### PRESSURE PROOF PISTON RINGS

to bring back permanently that almost forgotten power, quick getaway, real reliability and comfortable economy.

Of course if Pressure Proof Piston Rings were installed first, motors could not lose their original vim and power.

One 3-part or two 2-part rings per piston are all you need.



MANUFACTURED BY  
**PRESSURE PROOF PISTON RING CO.**  
107 MASSACHUSETTS AVENUE, BOSTON MASS.  
CANADA PRESSURE PROOF RINGS LTD., 300 LIFE BLDG. MONTREAL, QUEBEC

# THE LIGHTS O' THE NIGHT

# HAWTHORNE BULLET LAMPS FOR ALL FORD CARS

## THE SUPREME ELECTRIC PARKING OR SIDE LAMP



Furnished with white light to the front and ruby light to the rear as danger signal. Fits the fender or can be used in pairs as side lamps. Full nickel-plated, each \$3. Black with nickel door, each \$2.75

## THE ALADDIN ELECTRIC SIDE LAMP

For all Ford Sedans and Coupes.

Attached in a jiffy. Will also fit all Ford Touring or roadsters made prior to 1920. Full nickel-plated, pr., \$5. Black with nickel door, per pair \$4.50

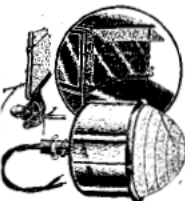

## STYLE B BULLET SIDE LAMP

The only lamp made that will fit the 1920 and 1921 Ford Touring and roadsters without any drilling or alterations. Attached in two minutes' time. Full nickel-plated, per pair, \$6.50. Black with nickel door, per pair \$6.00.

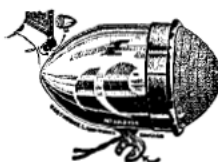

For Sale by Reliable Dealers and Jobbers the World Over. If your Dealer or Jobber Cannot Supply You, Send Us Your Order. We will find your nearest Dealer or Jobber for You.  
**HAWTHORNE LAMP WORKS, 1410 Michigan Avenue, CHICAGO, U. S. A.**

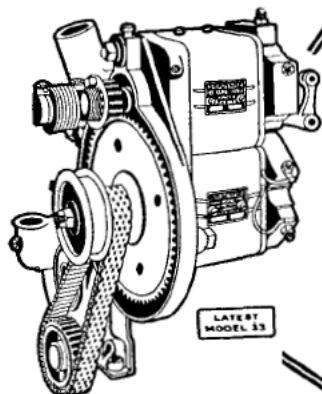

## \$49.75 Buys a Genuine HEINZE-SPRINGFIELD Starting and Lighting System.

Price includes Ammeter, Dash and Tail Lights, Lock and high-grade Battery of standard make. A quick sure start and bright steady lights all the time. Light and starter buttons on dash. Installation simple. Everything complete. Limited supply at this bed-rock figure. Order today—or write us for further details. Address

**The Service Products Co.,** Dept. C. Springfield, Ohio.  
 Western Rep.: **NORMAN COWAN CO.,** 451 Rialto Bldg., San Francisco  
 Texas and Oklahoma Rep.: **M. J. LA DUE,** 4310 Thomas Ave.

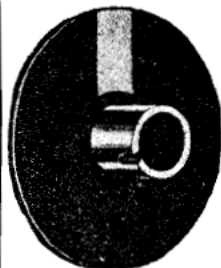

FREE FROM OIL



BUILT LIKE A Magneto

"LEADS WINGS TO YOUR FORD"

ABSOLUTELY FREE FROM OIL  
**Guaranteed for One Year**

EXCLUSIVE TERRITORY FOR DISTRIBUTORS AND DEALERS

Manufactured by **Omar Tire & Rubber Co.** 42 West 39th St. New York City



## SAVE \$25.00 BY DRIVING 100 TACKS



EASY TO APPLY

\$5.50 AND UP

We Tailor Top Roof Recoverings with Back Curtains to Fit All Models of Cars  
 Ford Roadster, \$5.50. Touring, \$6.95  
 For Other Cars, \$12 and \$16, With Large Plate Glass Lights. Seat Covers, \$3 Up.  
 All Prices Are for  
**GOODS DELIVERED AT YOUR DOOR**  
**CATALOG—SAMPLES FREE**  
**Auto Equipment Co., 33 Canal, Cincinnati, O.**

# BALANCED LIGHT WEIGHT FERROLYTE PISTONS

(Trade Mark Reg.)

## DESIGNED FOR EFFICIENCY

FORD AND OTHER MODELS

## The Perfection Auto Parts Co.

420 Lakeside Av. N. W., CLEVELAND, O.

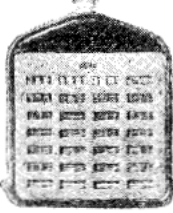

**\$1.50 HUTTER SHUTTER \$1.50**

## Ford Radiator Shutter

Sells at One Fourth the Price of Others

Conserve Engine Heat—Aid Vaporizing—Save on Gas  
Control Rush of Cold Air—Guard Against Costly Freezeups

Maintain High Engine Efficiency in All Kinds of Weather

Hutter Shutter—Open      A Necessity for Every Car      Hutter Shutter—Closed

### Cheapest Practical Shutter on the Market

Any Boy Can Attach It—Positively No Rattle—It's Made of Fibre  
Manufactured by

Shipped Prepaid on Receipt of \$1.50      **Hutter Shutter Co., STEVENS POINT, WIS.**      Dealer's Discount in Cases of 50

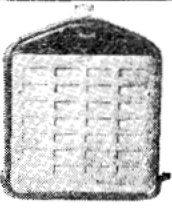

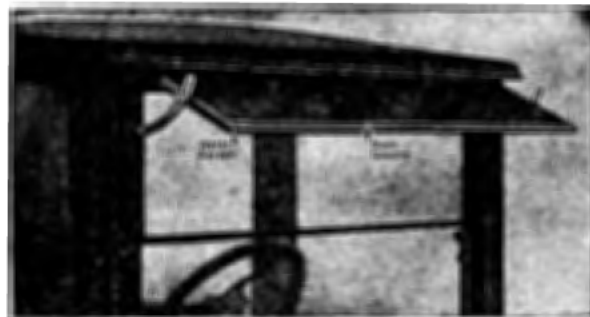

## RAIN - SUN

(Trade-Mark)  
THE

QUALITY VISION SHIELD  
WITH THE RAIN GROOVE  
SPECIAL FOR FORD enclosed cars, delivered any-where in U. S. **\$8.50**

Made of auto body steel. Handsomely finished in baked black enamel—(same as your car)—velvet green beneath.

ASK YOUR DEALER OR WRITE  
The Rain-Sun Vision Shield Co.,  
MFR'S  
904 West Pico Street, Los Angeles, Cal.

Patented Nov. 30th, 1920

## SULLIVAN "SLIP-ON"

# FORD — CAR — HEATER

WINTER COMFORT HEATER CO.  
1011 Wells Building  
MILWAUKEE, WISCONSIN

Type "S" and "C"

Price

# \$7.50

Nickel Plated  
Postage Extra

**FORD DEALERS**  
CAN SUPPLY YOU



Manufacturers of

## Commercial Bus and School Bodies for Ford Chassis

*Write us for Catalog and Prices*

### **McKay Carriage Co.**

Grove City, Pa.

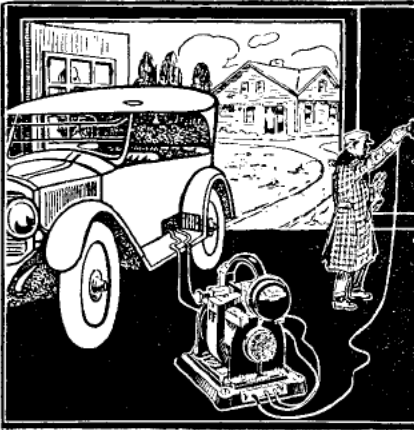

**10c Charges Your Storage Battery At Home With An F-F Booster**

Which is a Magnetic Rectifier for 105-125 Volt 60 Cycle Alternating Current. Leave Your Battery just as it is, in your car. Snap Charger Clips on battery terminals. Turn Switch and lock garage door, knowing Your Battery will be Charged in the morning. The Meters show you just the amount of current flowing. No skill required to operate. Everything Complete in One Compact Portable Charging Unit, Automatic Fool-Proof, Can not overcharge. Adjustable. Carbon electrodes rectify current lasting thousands of hours. By starting car quick, thus requiring fewer new batteries, Booster saves more than its cost. Do not think your battery is dead and worn out simply because it will not start your car.

**Buy a Booster and Fill It With Life. By Buying a Booster, You Save Money. PRE-WAR PRICES**  
 Bantam Type 6 charges 6 volt battery, 6 amps. \$15 Bantam Type 12 for 12 volt battery 5 amps \$15  
 Type 168 charges 6 volt battery at 12 amperes \$24 Type 1612 for 12 volt battery, 7 amperes \$24  
 Type 1628 Combination Type charges both 6 and 12 volt batteries at 12 and 7 amperes. \$36

The larger Types are recommended for the heavier batteries or where time is limited. Shipping Weights complete with AMMETER and BATTERY CLIPS, 12 to 15 lbs. Order from your Dealer or send check for Prompt Express Shipment; include Postage and Insurance charges for Parcel Post Shipment or tell us to forward C. O. D. Order Now or Write Immediately for FREE Descriptive BOOSTER Bulletin No 14.

**F-F Rotary Rectifier for Group Charging**  
 Real Economy in First Cost and in Service. Charges up to 36 cells. Full Wave, Automatic Dependable. Write Immediately for FREE Descriptive ROTARY Bulletin No. 14-A. Other F-F charging apparatus operates on Farm Lighting Plants & D. C. Circuits

**The France Manufacturing Co.** General Offices and Works: CLEVELAND, OHIO, U. S. A.  
 Canadian Representative: Battery Service and Sales Co., Hamilton, Ontario, Canada

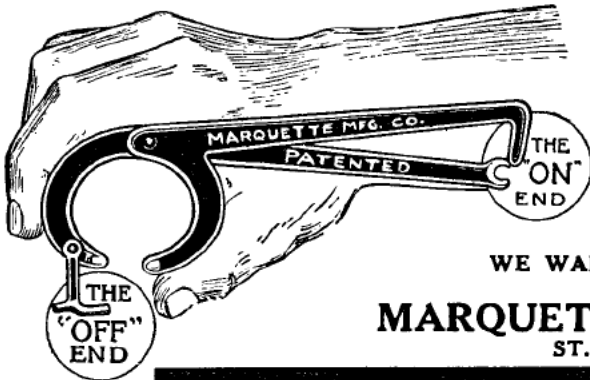

**A GRIP LIKE A GIANT HAND**

The "quick action" Marquette Tire Tool "takes them off and puts them on again." Removes and puts back on all size clincher tires. We guarantee it to do the work. An attractive dealer proposition. Write at once.

**WE WANT DEALERS NOW**  
 DEPT. F.

**MARQUETTE MFG. CO., Inc.**  
 ST. PAUL, MINN.



Dodge Motors. Fastest in the world. Doubles the value of your truck. Hill climbing for touring cars beyond your wildest dreams.

**Laurel Power Specialties FOR FORD and DODGE Motors**

SIXTEEN Valve Cylinder Heads; Racing gears; Racing bodies; Racing radiators; Worm and gear steering gears; 4-speed transmissions; Light pistons; Roller bearings; High speed camshafts; Parts for underslinging chassis; Counterbalances; Racing carburetors; Racing magnets; Also, counterbalanced crankshaft—one single forging.

Largest manufacturers of Power and Speed Specialties in the World.  
 DEALERS: Write for illustrated catalog on the above and other parts for Ford and Dodge Motors. No matter what you want, we have it.

**The Laurel Motors Corpora'n**  
 ANDERSON, INDIANA

**WINTER IS COMING!**

Parcel Post or your Dealer  
**\$2.50**  
 Complete FORD SET.

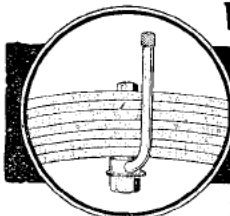

**HIRST**  
 INTERNAL SPRING LUBRICATOR

Attached to either old or new spring clip.

13th and Wallace Streets, Philadelphia, Pa.

**PROTECT** your springs against rust. Rain, slush and snow will cause your springs to rust. A 100% internally lubricated spring will prevent rust from accumulating and will make your car ride easier.

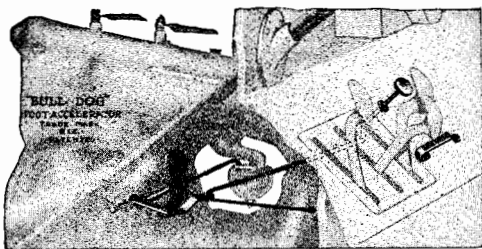

only \$150 now brings you the

**BULL DOG FOOT ACCELERATOR**

Nearly a million Ford owners are getting "big car" comfort in driving their cars with the Bull Dog Foot Accelerator.

The Bull Dog is simple in construction. Once installed it needs no further attention and lasts as long as the car.

Safety and comfort demand a Bull Dog Accelerator. Get one today. You can't buy a better accelerator at any price.

If your dealer cannot supply you, order direct.

**W. H. THOMAS MFG. COMPANY**  
SPENCER, IOWA

Sales Department, The Fulton Co.  
MILWAUKEE, WIS.

Price in Foreign Countries, \$1.90

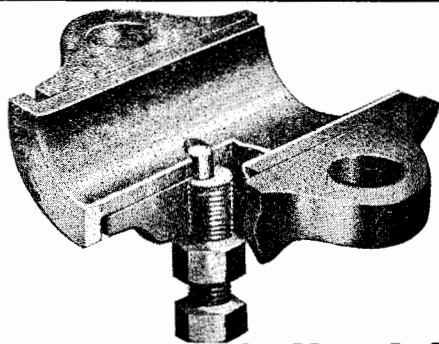

**All Is Needed—Here It Is**

End play in the Ford crankshaft always has been a familiar trouble. Now it has been permanently ended by the

**C-A ADJUSTABLE BEARING CAP**

(Patent Pending)

This device is simple in design and operation and has met with universal approval. Quickly installed it eliminates the hard starting, poor lights, noise and excess wear which results from crankshaft end play.

The C-A Adjustable Bearing Cap is strongly made and machined to fit perfectly. Equip your car today and end constant trouble and expense.

**PRICE COMPLETE, \$5.00**

DEALERS AND AGENTS:—Write for our special proposition.  
**ADJUSTABLE BEARING CO. INC.**  
116 S. 4th Street TERRE HAUTE, IND.

**The "Inland" Refacer**

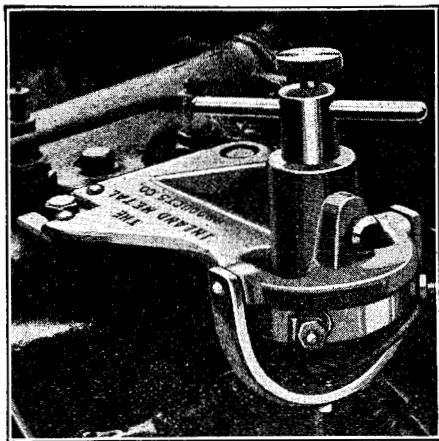

Type B

Refaces the Timer case without disconnecting any wires.

Ties Up the Car But a Few Minutes.

Sold on a Ten Day Trial Offer.

Ask for It.

**Price \$7.50** West of Rockies and Foreign \$8.00

**INLAND METAL PRODUCTS CO.**

Columbus, Indiana, U. S. A.

Originators of Practical Timer Refacing

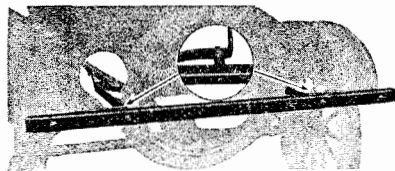

**Dow Double-Spring Bumpers**

*Softens The Force of Every Blow*

**D**OW-BUMPERS-ON means constant protection. The double-spring construction softens the force of the most severe impact to a gentle resistance. Dow Bumpers also add that refining touch in appearance so desirable to the Ford owner.

**Black Enamel \$8.00**

**Black and Nickel \$10.00**

**THE DOW CO., INCORPORATED**

Louisville, Kentucky.



**GARAGE**

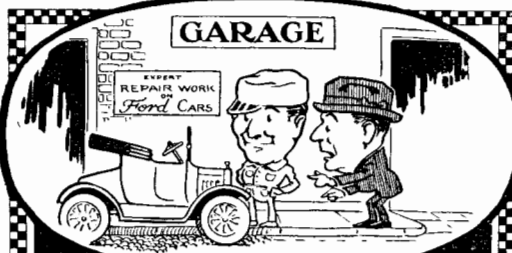

"This car runs like a chatterbox. What do you suppose is the matter?"

"Why you need some Viking Lining on your transmission bands--then she'll run smooth as silk."

**VIKING**

Transmission Lining - Exclusively for Fords

Sales Dept.  
**THE ZINKE CO., 1323 MICHIGAN BLVD.**  
 CHICAGO, ILL.  
 Manufacturers  
 Vogt Mfg. Corp., Rochester, N. Y.   
*Weavers for More Than Forty Years*

A  
Large Size  
Tilting  
Wheel  
That Sells



Because it results in complete satisfaction to the Ford owner, dealers are reporting rapid sales for the

MUNCIE TILTING STEERING WHEEL

The Muncie has a 17 inch walnut finished corrugated rim; polished aluminum spider, and is exceptionally well built throughout. Its easy operating tilting feature makes it specially convenient and practical. Its large size relieves driving strain.

It cannot rattle; can be put on quickly by anyone, and greatly improves the appearance of the car.

COST COMPLETE \$6.20

Money Refunded If Not Satisfactory  
**DEALERS-AGENTS:—Show it to Ford owners—tell 'em the price—it sells itself. Write today.**

SPURGEON BROS. MFG. CO.  
 MUNCIE, INDIANA

**SAFETY CLUTCH CONTROLLER**

For  
Ford  
Cars

Part indicated by arrow works loose on shaft, and when set in neutral (by applying the brake lever) it will stay in that position until pedal is put in low speed.

This little device, by keeping the clutch in neutral position at all times, insures perfect safety from car moving away while motor is left running.

It detects any trouble in the clutch.

Simplifies the changing of rear tires by relieving the Emergency brake pressure.

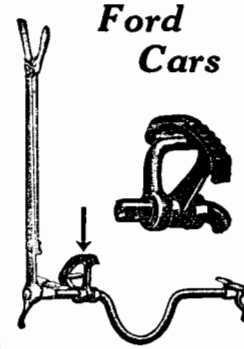

It saves tires and brake shoes.  
 Simplifies operating car in reverse by throwing the lever down.  
 Can be used in coasting.  
 Enables one to move car manually with little difficulty.  
 Easy to operate.

Standard Model \$5.50  
 F. O. B. New York  
 One Ton Truck Model \$6.00  
 F. O. B. New York

If Your Dealer Cannot Supply You Write to Us  
**DEALERS: Kindly Write for Particulars**  
**C. C. & F. MANUFACTURING CO.**  
 141 East 23rd Street      NEW YORK CITY



**"Beauty"  
DASH LAMP**

FOR FORDS

(ONE OF THE FAMOUS "HANDY" LINE)

THE ONE-POINT CONTACT  
 AND THE LIFT-SWITCH  
 INSURE A STEADY LIGHT  
 AND NO FRICTION  
 OR WEAR.

No small springs, plungers or other complications.  
 Lamp goes to you complete, ready to install.  
 No wires to cut, splice or tape;  
 no screw holes to drill or screws to fuss with.

ATTACH IT IN TEN MINUTES  
 Retail price \$1.25

Dealers, ask for quantity discounts.  
**CHICAGO ELECTRIC MFG. CO.**  
 2805 So. Halsted St.      CHICAGO



## CRONK SIMPLEX THREE SPEED SELECTIVE TYPE TRANSMISSION

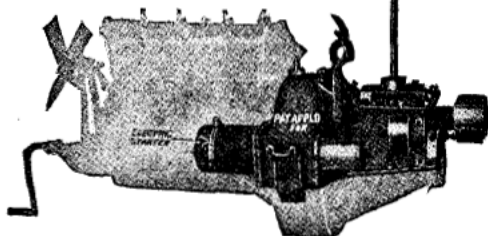

### MERCHANDISING A MECHANICAL ACCESSORY OF REAL MERIT

The Cronk Simplex Three Speed Selective type Transmission replaces the present Ford transmission completely and yet no cutting of parts, no fitting and no mechanical changes are necessary. It is a simple installation operation. It has been on the market for nearly two years, is fully protected by patents and its sale has been limited only by the production capacity of the factory. This production capacity has recently been increased to satisfy the demand and from now on, immediate deliveries will be possible.

Inquiries are coming in at the rate of more than \$1500.00 a day and the factory needs EXCLUSIVE TERRITORY DISTRIBUTORS to handle this business in different sections of the country.

This opportunity is open to men who are financially responsible and able to handle big business in a big way. The possible profits are limited only by the ability of the representative and are large enough to make the proposition extremely interesting to any man.

As only a limited number of territories are open, immediate action is necessary. All communications will, of course, be considered confidential.

E. D. & A. F. CRONK, INC., Utica, New York

## CHATTER—CHATTER COSTLY, ANNOYING

ELIMINATED FOR \$3.00



Feeds  
Brake  
Band

Feeds  
Low and  
Reverse  
Bands

### The Red Cup Lubricator

supplies RED CUP COMPOUND in the right proportions to the Ford Transmission Bands. The Compound softens the bands, removes glaze (CAUSE OF CHATTER). Easily operated by Key thru Floor Board. Anyone can install in five minutes. Compound is soluble in Oil.

Don't Let CHATTER Destroy your Car! Remember, the Red Cup Lubricator stops Chatter and keeps it out of the Bands or we refund your money.

Dealers Ask for Quantity Prices

RED CUP LUBRICATOR CO.

1603 S. Michigan Ave.

CHICAGO, ILL.

## Petry Tuning-Up-Valve FOR FORDS

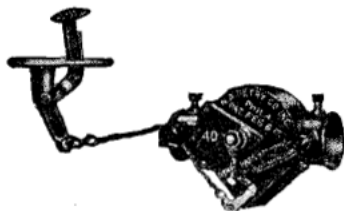

Why do particular motorists demand the Petry Tuning-up-Valve in preference to all others? Motorists find that the Petry Tuning-up-Valve is a carefully designed, well-made product, and not some castings carelessly assembled. It appeals, on sight, as a "good job." Compare it yourself with the ordinary Cut-out and your verdict will be that it is America's Best Tuning-up-Valve and "Scientific Detector" for tuning up and locating trouble.

Expels the full exhaust to the rear, not down. Does not spatter mud and stir up dust. Positive cut-off from the muffler. Spring away from heat. Compound lever makes the strong spring action smooth and easy. Spring adjustable. Valve seat and valve machined to prevent leakage.

Sold complete with Pedal and Chain for \$4.50

N. A. PETRY COMPANY, Inc.

Makers of Petry Pedal, Ventilator and Pump

338 N. Randolph St., Philadelphia

Western Distributor, Norman Cowan Co.,

445-451 Rialto Bldg., San Francisco, Cal.

## CYCLO

"Modified Vapor" System

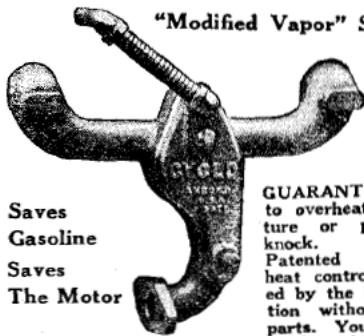

An exhaust heated aluminum manifold for FORDS.

Saves  
Gasoline  
Saves  
The Motor

GUARANTEED not to overheat the mixture or produce a knock. Patented automatic heat control, regulated by the intake suction without moving parts. You can run your Ford on a lean mixture with perfect pick-up. No more fouled spark plugs. Reduces carbon. Stops oil dilution. MAKES YOUR FORD RUN 100% SMOOTHER.

25 to 30 MILES PER GALLON  
OF GASOLINE

Plenty of power under all conditions with unusual gasoline economy. The Cyclo insures a quicker warm-up and get-away on cold mornings. Money refunded in 10 days if not satisfied.

Price Postpaid **\$12.00** 5% Additional for War Tax

We want live Ford Owner Agents and Dealers to demonstrate this remarkable invention. Write today for special plan.

CYCLO MANIFOLD COMPANY  
AKRON, OHIO

**AT LAST, A SUPER-SERVICE  
FENDER BRACE  
FOR FORDS**

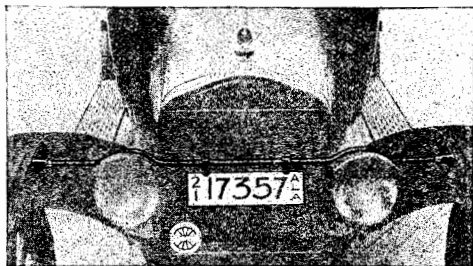

A fender brace that rigidly and permanently prevents front fenders rattling or cutting tires. Adds greatly to the car's appearance. Does not touch lamps or radiator. Holds license tag up out of the mud. Easily installed—no holes to bore, or subsequent service required on brace. Like all ARG accessories, made of best materials. Makes fenders outlast life of the car. Price \$2.50. Stops all front fender rattling and troubles.

Sales Department

**Jessop & Thompson**

1421 S. Michigan Ave., CHICAGO, ILL.

Manufactured by  
ARG AUXILIARY SPRING CO., Birmingham, Ala.

**SAVES  
TIRES**

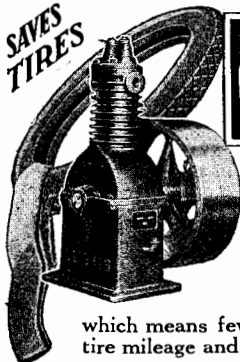

**FREE  
CURTIS AIR  
FREE FROM OIL**

**A Friendly Sign**  
Drivers of cars everywhere seek this sign because it is their assurance of clean, pure air, which means fewer blowouts, greater tire mileage and less repairs.

**CURTIS AIR—Free From Oil**

Blowouts—the bugbear of every auto driver—are often the result of the rotting of the inner tube, due to oil-soaked air. Offer your customers Curtis Air—free from oil—and cash in on the increased patronage that is sure to follow.

**Ask Your Jobber**

We manufacture several styles, types and sizes of Compressor Outfits. Ask your jobber for prices and complete information, or write us.

Style "X"  
Five sizes

**Curtis Pneumatic  
Machinery Co.**  
1639 Kienlen Ave.  
St. Louis, Mo.

Branch Office:  
532-L Hudson Terminal  
New York City

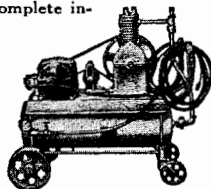

**WATERVLIET  
SPIRAL REAMERS**

FOR FORD AUTOMOBILES

"THEY WILL NOT CHATTER"

HIGH GRADE TOOLS FOR HIGH  
GRADE MECHANICS

We have just added a new SPECIAL SPIRAL ADJUSTABLE REAMER to our Ford Family.



Patent Pending.

No. 3022½ PE FORD EXPANDING REAMER with Pilot **\$15.00**

This Reamer is especially designed for Ford Piston Pins taking in standard pins as well as any over-size. The adjustment is simplicity itself. The adjusting screw in end regulates the size. The Rose Reamer on end of pilot does the rough cutting leaving the SPIRAL, FLUTED blades to do the finish reaming only.

The Pilot insures reaming both bushings in PERFECT ALIGNMENT. Without doubt the best tool for the purpose ever offered.

A Discount to the Trade.

**WATERVLIET TOOL CO., INC.**  
ALBANY, N. Y.

**COOK'S  
LUBRICANT**

*Equally Efficient in  
Summer or Winter*

Cook's Lubricant is not affected by temperature changes. It is an all-year-round lubricant that will not run or leak out of the gear case. Tests have proven that gears lubricated with Cook's Lubricant operate silently and do not lose power.



SENT FOR YOUR  
SAMPLE?

Your dealer stocks it because he knows it's good. Ask him or write us for samples.

A MARK known and respected around the world since 1868, for fair dealing, a quality product and an unexcelled service.

**Adam Cook's Sons**  
708-710 Washington St.  
New York

C-107



## The Venn Auto-Lock For Ford Cars

No Bother to Use

NOTHING TO CARRY BUT A KEY

Installed in a Few Minutes.

Corbin Four Tumbler Lock. Each One Different.

NOT NECESSARY TO RAISE HOOD

LOCKS THE PASSAGE OF GAS

Money Back  
If Not Satisfied **Price \$10** Cash  
With Order

DEALERS AND AGENTS WANTED

TAYLOR-SHANTZ CO.

482 St. Paul St.

ROCHESTER, N. Y.



Prices Cut to the Bone!

**HASTINGS**

GLASS REAR CURTAIN LIGHTS FOR FORDS NOW **\$1.65**

Cool Fall Evenings Here

With the first cold weather you will want protection from cold air, rain and snow. Replace your celluloid lights which have become cracked, torn and discolored, with Hastings Glass Rear Curtain Lights and be comfortable when driving.

ASK YOUR ACCESSORY DEALER

If he can't supply you with Hastings Ford necessities, write to us direct.

HASTINGS MANUFACTURING CO.  
25 E. Mill Street HASTINGS, MICH.

DEALERS—Your jobber can supply you.  
Write to him or to us for sales proposition and catalog of complete Hastings line.

**\$150.00**

## NOW BUYS THE CHAMPION

FORD MODEL T REBORING OUTFIT  
COMPLETE

New revised prices on other Champion  
Tools Are as Follows:

Fordson Reboring Outfit,  
Complete..... **\$160.00**

Champion 22" Back Geared  
Power Feed Drill Press..... **\$200.00**

Prices F. O. B. Phila., Pa.

Reboring outfits at these attractive prices can be furnished for hand or drill press operation.

Can you afford to overlook such valuable tools at these prices?

BUY NOW

**CHAMPION MFG. CO.**

2908-10 W. Fletcher Street  
PHILADELPHIA, PA.

**SPECIAL OFFER \$100**

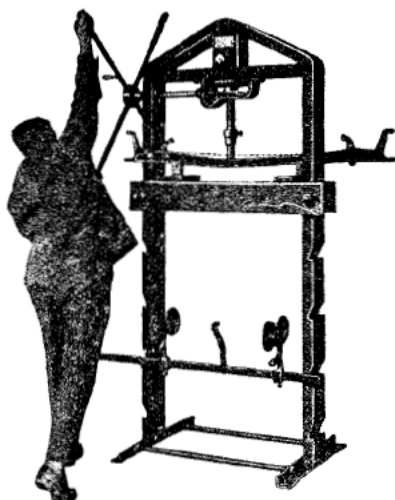

This Combination Arbor Press, Straightening Press and Truing-up Machine—  
**\$100.00 (formerly \$150.)**

Write for details at once.

DETROIT GARAGE EQUIPMENT CO.  
44 Hendrie DETROIT

**Eventually  
You Will Use a  
"Kemp Hotspot" Manifold**

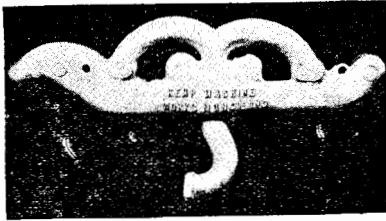

**E**CONOMY demands that sooner or later you will place this needed device on your car.  
It is scientifically designed to give perfect and uniform mixture of thoroughly vaporized gas and air to all cylinders. With even the lowest grade fuel you secure 100% efficiency.  
It eliminates 50% to 75% oil pumping trouble due to giving each cylinder a mixture of dry gas in which the combustion is instantaneous and complete. This keeps each and every cylinder firing regularly.  
It increases mileage, eliminates 25% of vibration, gives a snappy motor almost instantly, and permits easy starting in all kinds of weather.

**GUARANTEE**

Use a Kemp for thirty days. If not entirely satisfactory return it to your dealer who will refund full cost. We stand back of every manifold we make. If your dealer is not stocked give us his name and order direct.

Price \$9.00 F. O. B. Muncie Ind.  
DEALERS—Write for a Real Proposition.

**KEMP MACHINE WORKS**  
1217 So. Franklin MUNCIE, IND.

**WIRE  
WHEELS  
FOR  
FORD  
CARS**

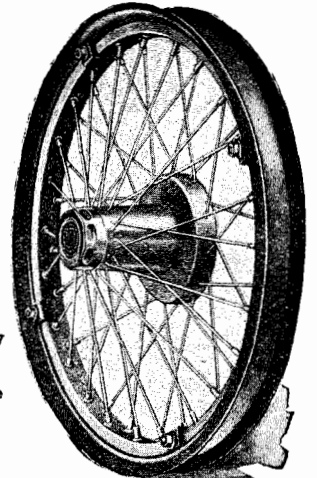

With Kelsey  
No. 88  
Demountable  
Rims.

Interchangeable With Standard Ford Rims  
Replacement Parts Carried by All Ford Dealers  
Set Is Complete Ready to Install

**LIST PRICE—ANY COLOR—\$60.00**

**We Have a Profitable Proposition  
for the Trade**

**E. T. WALLING SERVICE**

7173 CLAYTON AVE., DETROIT, MICH.

REPRESENTATIVES:

J. V. KANE & CO., 258 11th St., Philadelphia  
"TUCK" TURNER, 467 Murray Ave., Milwaukee

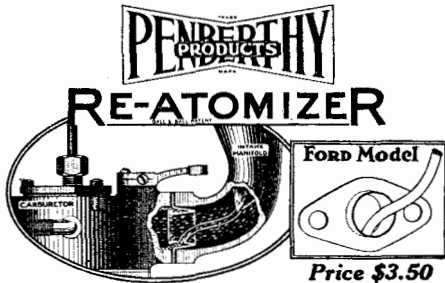

Price \$3.50

**T**HE PENBERTHY RE-ATOMIZER is a device that slips in between the carburetor and the intake manifold. It traps the liquid gasoline that condenses on the side walls of the manifold—and vaporizes it a second time.

THE PENBERTHY RE-ATOMIZER eliminates liquid gasoline in cylinders—consequent carbon-fouled spark plugs—quicker acceleration—quicker starting—greater flexibility—more power—more MILEAGE.

**For Fords—Price \$3.50**

Buy today from your dealer—or order direct.  
Literature on request.

**Penberthy Injector Co.**  
DETROIT, U. S. A.

Established 1886. Canadian Factory, Windsor, Ont.

*The* **MOORE**  
**TRANSMISSION**

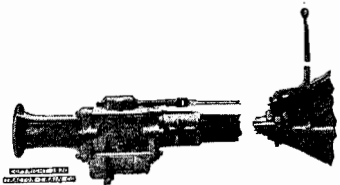

Increases the utility of your Ford by doubling the original power, and adding an Intermediate Speed.

FOR FURTHER INFORMATION  
WRITE US DIRECT.

**Tractor-Train Company**



MANUFACTURERS  
1344 Wall Street  
LOS ANGELES, CALIFORNIA

## HOW MUCH OIL?



◆◆◆◆◆  
This question is answered by a glance at the instrument board before you if your car is equipped with the

◆◆◆◆◆

## SIMPLEX OIL GAUGE

In plain view of the driver at all times it tells the exact level of oil. Ends the old trouble and inconvenience.

The Simplex Oil Gauge is simple in construction and just as simple to install. There are no cork floats or mechanical parts to get out of order, and it is absolutely reliable at all times.

Have this convenience and economy on your car. Ask your dealer or write us.

**DEALERS AND JOBBERS**—Show the Simplex Gauge and it sells. Write for complete information.

**SIMPLEX GAUGE MFG. COMPANY**  
907 PINE STREET ST. LOUIS, MO.

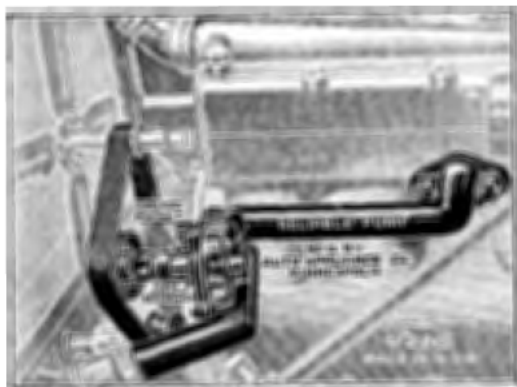

## A REAL CIRCULATING PUMP FOR \$7.50

Before you buy any circulating pump get full information on the

## RELIABLE PUMP

just coming on the market. It is highly efficient, easily installed, long-lived and fully guaranteed.

**INTRODUCTORY OFFER—SAVE \$1.50**

Cut out this ad and enclose with check or money order for \$6.00. You will save \$1.50 on the regular price and pump will be shipped to any part of the United States. If not satisfactory after a ten day trial return same at our expense and we will refund your money. Write for circulars.

**JOBBERS AND IMPORTERS:** Get your share of this business.

**DOUGLASS AUTO APPLIANCE CO.**  
2845 Chicago Avenue. MINNEAPOLIS, MINN.

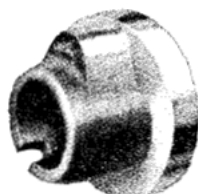
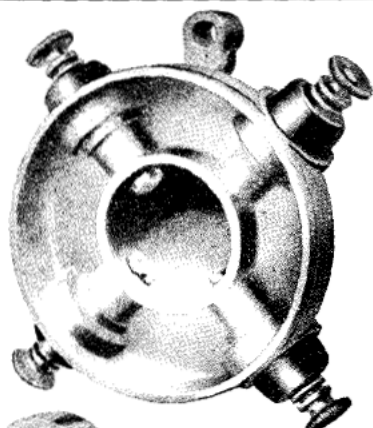

## FORD GENIUS AND HERZ GENIUS COMBINED

**FIFTEEN** years development by the great electrician Herz—Result—the remarkable new Hammerblow Timer for Fords.

We made the first Buick and Stevens-Duryea Timers fifteen years ago—we invented the word "Timer." We were first in ignition development—we are still first.

Now WE have the correct scientific principle for Fords—no unreliable brushes—no wearing and arcing roller assemblies to burn, pit and roll out—but simplicity itself—A hardened steel cam and four toolsteel plunger buttons assembled in a manganese bronze housing, the best material in the engineering world.

The steel cam makes contact and releases the plunger buttons on the trigger principle—the effect on the vibrators is like a hammerblow—they never stick. Never any sluggish after current—exact timing at all speeds.

Herz genius gives you a wonderfully elastic Ford, clocky regular ignition, instantaneous starting, immediate pick up, smooth slow idling and 20% saving in gas, if your present Timer is wearing out and behaving badly.

Our Timer will last as long as the motor, guaranteed against any replacement for two years.

**Low Introductory Price Only \$4.75**

Packed in a strong wooden box. Sold direct to the Ford owner, if your dealer has no stock.

**Send One Dollar at once, pay the balance to the postman. Money back if you are not delighted.**

## HERZ

Maker of the Famous Herz Bluestone Plug  
Dept. F. 182, Locust Ave.  
NEW YORK CITY, N. Y.

*Thousands of these Herz Hammerblow Timers have and will be sold. There is a Ford made every 60 seconds. National advertising plans and unusual sales policies and profits are now being arranged, substantial jobbers and dealers should connect enthusiastically with us at once.*

## MAKE YOUR FORD SAFE!

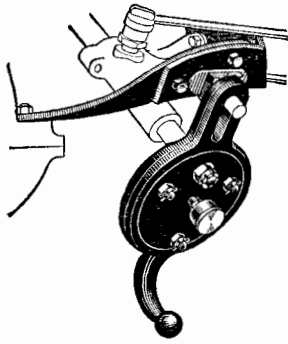

The Detroit Steering Control will give you absolute control of your Ford. It prevents the front wheels from getting locked hard over. Holds the car to the road and prevents road shocks from reaching the hands.

Can be installed in forty minutes. No holes to bore. Safe, simple, practical.

**PRICE \$15**

**DISTRIBUTORS**—We want hustlers with Ford cars who will push sales. It's a big profitable business. Write at once.

**DETROIT STEERING CONTROL CO.**  
2739 Atwater E. DETROIT, MICHIGAN

## DEALERS WANTED

TO HANDLE THE

# Colestock Synchronizer

ONLY TWO MOVING PARTS

The Timer with the KNIFE-SWITCH CONTACT

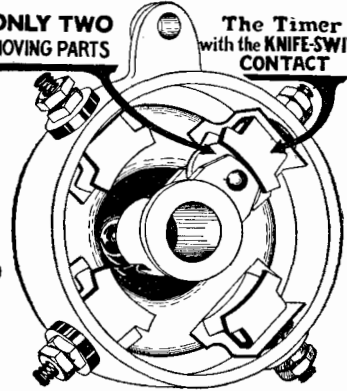

Retail Price \$2.00

Retail Price \$2.00

The simplified product of years of specialized experience. Full surface, knife-switch contact insures ample current carrying capacity and eliminates coil trouble. A good timer at a popular price. Good territory still open.

**Colestock Manufacturing Co.**  
2855 Montrose Ave., CHICAGO, ILL.

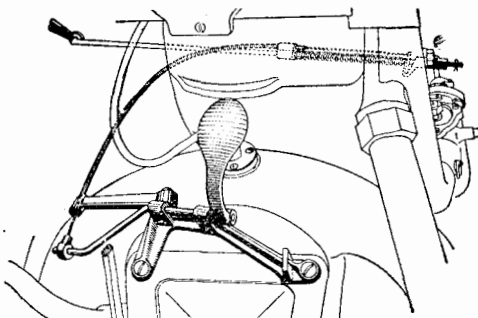

Pat. July 5, 1921. Other patents pending.

## MICHON Accelerator

CLUTCH SLIDE ALL Hand Adjustment FOR FORD CARS

The \$5,000 car affords no better accelerator. Here it is—the liveliest, easiest-selling Ford Accessory on the market because positively necessary for Ford Driver's Safety, Comfort, Convenience. Permits quick "pick up" from stand still to high speed, giving even, graduated, steady pull of automatic acceleration and eliminating the sudden opening of throttle valve and "jerk" in starting. Fully guaranteed. Attaches to motor, supporting floor board perfectly.

Retails at **\$3** Post Paid

Complete Anyone can install easily, quickly, without special tools.

Carburetor Adjustments Simple. All by hand. Just a simple twist of flexible connecting rod of Michon Accelerator with the fingers, opens or closes the carburetor "gas" feed to suit any atmo spheric condition—no special effort—no tools are needed—adjustments are positive and lasting. This feature alone is worth the price in convenience.

Interesting Discounts to Distributors, Jobbers and Ford Agents.  
**MICHON MANUFACTURING CO.**  
90 Michon Bldg., 124 No. Erie Street, TOLEDO, OHIO

## Keep The Air In Circulation With A National Ventilator

COLD or wet weather driving in a closed car or an open car with the side curtains in place, results in an unhealthy uncomfortable condition inside the car unless proper ventilation is provided—especially so if there are several passengers. The air becomes filled with carbon dioxide which lowers the vitality of the human body and adds to one's susceptibility to contract colds and other diseases.

A National Auto Ventilator on the cowl of your car will admit a constant flow of fresh air in any volume desired, without creating a draft. It is just as necessary for winter driving as ventilators are in crowded, stuffy street cars and trains.

There is a National Cowl Ventilator for every type of car. Price, complete, \$5.50. See your local dealer.

Dealers and Jobbers: There is a real sales opportunity for National Cowl Ventilators during the winter months. Take Advantage of it.

**NATIONAL ALUMINUM CO.**  
1905 Frederick St. RACINE, WIS.

# The New Republic

## 31x4 GRANDE CORD

STRAIGHT SIDE, STAGGARD TREAD  
ready Nov. 1st

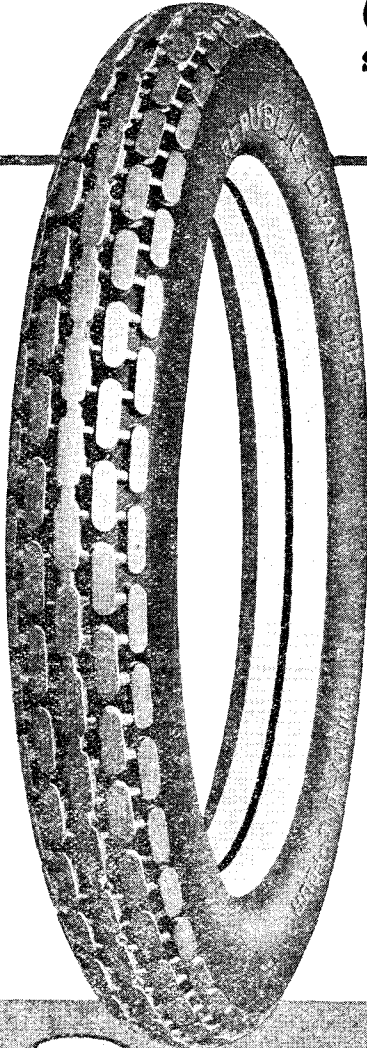

AS the illustration indicates, the "Thirty-One-Four" Grande Cord is mighty good looking—and full of strength and service.

Standard Oversize with staggard tread, it is made to fit 30x3½ straight side rims.

Tread and side walls beautifully black, the "Thirty-One-Four" features the new breaker construction that unites carcass and tread into one inseparable unit.

Dealers in light cars know that this new tire means longest uninterrupted service to all owners of light cars using this equipment. It WILL give more mileage. Think what it means to your customers.

*LIGHT CAR DEALERS NOTE:—30x3½ straight side demountable rims, interchangeable with standard rims without changing wheel, are now available from rim manufacturers at reasonable cost.*

Place your order with nearest Republic jobber, branch or warehouse, and get full information on our 1922 sales proposition. Immediate deliveries. Write.

**The Republic Rubber Company  
of New York**

221-223 WEST 37TH STREET  
New York . . . . . 221-223 West 37th St.  
Philadelphia . . . 2835 West Van Pelt St.  
Cincinnati . . . . 424 West Fourth St.  
Pittsburgh . . . . . 953 Liberty Ave.  
Cleveland, 632 Frankfort Ave., N. W.  
Buffalo . . . . . 725 Main St.  
Minneapolis . . . . . 428 Stinson Blvd.  
Chicago . . . . . 1720 So. Michigan Ave.  
Atlanta . . . . . Corner Ivy and Harris St.  
Kansas City . . . . . 2004 Grand Ave.

# Republic

STAGGARD  
TREAD

GRANDE CORDS AND FABRIC TIRES

*All Standard Sizes—Factories—Youngstown, O.*

THE  
**OILOMATIK**

LUBRICATOR automatically feeds the oil to the motor as needed, holding it at all times at the proper level—midway between the two pet cocks. Gives perfect lubrication to Ford motor; eliminates guess-work.

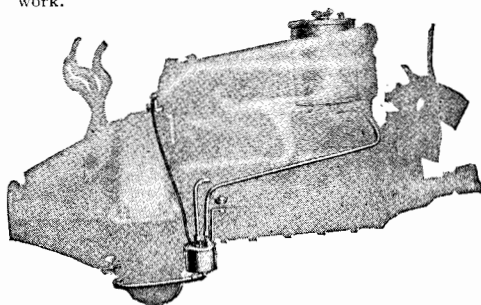

ANOTHER THING—Should you fail to refill the tank the OILOMATIK has a very unique low oil Alarm, which warns you before the level reaches the danger point.

Price \$15.00

Local Distributors order one today.  
Exclusive territory.

**Auto Products Mfg. Co.**

341 East Ohio Street  
CHICAGO, ILL.

**“Katta-Pilla”**  
Metal and Cork Fan Belts



Are made of thin steel links, Fibro Pins and Corks; are noiseless—RUN SLACK—practically indestructible, unexpected breakage impossible; are unaffected by dirt, water, heat or oil; will not fall down, wear out, get hard, rot, break, tear, stretch or shrink.

**100% EFFICIENT—100% PROTECTION**  
Saves Oil, Saves Gasoline, Saves Overheating,  
Saves Valves, Saves Bearings,  
Saves Cylinders

**Fit Any Car, Truck or Tractor**

“Kork-Tred” Ford Transmission Lining is the original cork lining. There is nothing—“Just as Good.” No other cork insert lining contains the LUBRICATION OIL CUPS. This feature is fully protected by patents and cannot be duplicated. Don't let 'em fool you with substitutes that have tapered corks which fall out. Will outwear four sets of any other kind of lining. Send for Booklet. Dealers, we have a money making proposition for you.

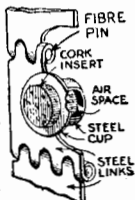

**“Kork-Tred” Inc.** 500 Fifth Ave.  
Dept. 8, N. Y. City

**Auto Owners WANTED!**



To introduce the best automobile tires in the world. Made under our new and exclusive Internal Hydraulic Expansion Process that eliminates Blow-Out—Stone-Bruise—Rim Cut and enables us to sell our tires under a

**10,000 MILE GUARANTEE**

We want an agent in every community to use and introduce these wonderful tires at our astonishingly low prices to all motor car owners.

**FREE TIRES for YOUR OWN CAR** to a representative in each community. Write for booklet fully describing this new process and explaining our amazing introductory offer to owner agents.

**Hydro-United Tire Co.**  
DEPT. 191 CHICAGO OR PHILADELPHIA

**LOCKWOOD**  
TIMER EXTENSION  
FOR  
Ford Cars and Trucks

Contact Plates Contact Shoes

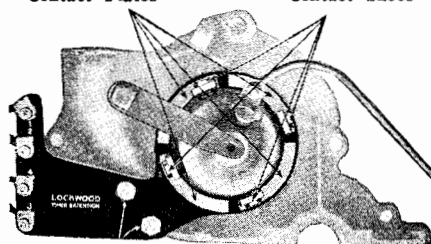

Bolts Holding Extension

**LOOSE WIRES ELIMINATED**  
**IGNITION TROUBLE SOLVED**  
**SURE SPARK**  
**EASIER STARTING**  
**SMOOTHER RUNNING**

PRICE **\$3.50**  
IN U. S. A.

DEALERS AND AGENTS WANTED

**Lockwood Products Co.**

307-9 Met. Bank Bldg.  
MINNEAPOLIS, MINN.



# THE HEART OF YOUR CAR

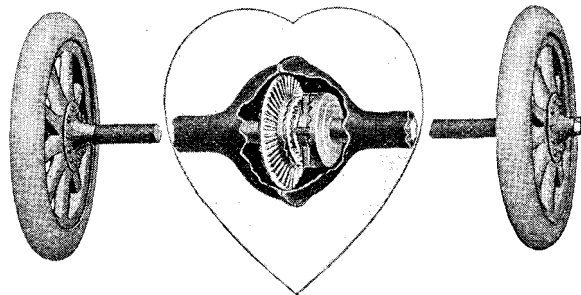

**H**ERE is a device that does away with all of the familiar faults and disadvantages of the gear differential. Besides this it adds a score of advantages that the ordinary differential cannot possibly have. It dis-

places the old differential and adds economy, simplicity and a far wider range of service.

This remarkable invention gives 20 per cent more driving power, saves 20 per cent gasoline, tires and wear on working parts. It distributes driving power equally on both rear wheels; one wheel cannot pull harder nor turn faster than the other except on curves. It means sure driving on sand, mud, rough or slippery surfaces.

**DEALERS AND DISTRIBUTORS:**—Secure your agency immediately. Our proposition will be of real interest to you.

**International Auto Drive Co.**

629 E. Pearl Street CINCINNATI, OHIO

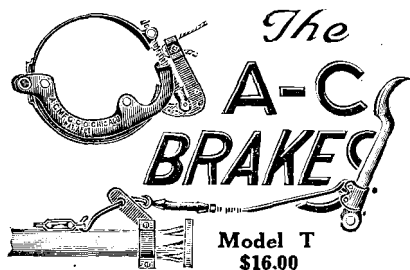
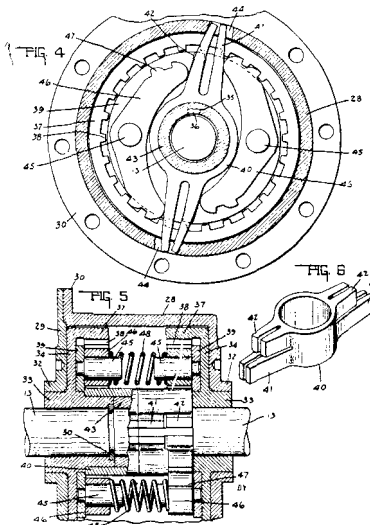

**Stop your Ford Car or Truck when you want to stop it without any chatter or jar**

*Thousands of satisfied users of A-C Brakes since 1915*

*Save your gears* in the rear axle. No more relining of transmission brake band. *Reline A-C Brakes* yourself. *Double the life of your car.*

*It's a great pleasure* to stop your car without chatter or jar. *A-C Brakes are the only cure for this trouble.*

*Write for catalog* and full information about *this absolute guarantee to deliver the goods.*

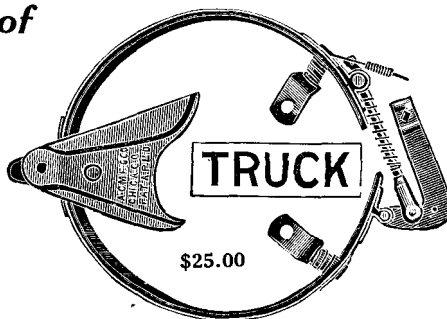

*Sold by all automobile jobbers and dealers. DEALERS—Write your nearest jobber.*

**A-C MANUFACTURING CO., 2251-55 W. Grand Ave., Chicago, Ill.**



## Here Is Real Comfort and Protection

With your roadster or touring car you can enjoy the comfort and freedom from drafts, snow or rain. Keep your car dry and warm by equipping it with

## H. & B. Weather Shields for Fords

"Keep the Weather Out and the Comfort In"

Patent Applied For

These practical devices can be attached in a few minutes and completely close the drafty leaky spaces between the windshield and side curtains. Made of sheet metal with a sealing flap of rubberized top fabric which fastens over side curtains.

No Wind, Rain, Sleet or Snow Can Possibly Enter

Simple, Strong. No Trouble. No Rattle. At Your Dealer's or Sent Direct.

Cost Complete \$2.80 per Pair

HOLMES & BOSTROM CO., Milwaukee, Wisconsin

FOUR IN ONE COASTERS FOR FORDS  
Coasts on the level, acts the same as a Bicycle With a Coaster

4

The Duncombe is the only Automobile Coaster manufactured. It relieves the strain on the Differential and Transmission.

1—Saves gasoline. Guaranteed to increase your mileage 50%.

2—Increases tire mileage. Saves nicking and the cutting of tires.

3—Reduces the back-lash, absorbs road shocks, reduces vibration.

4—Doubles the life of your car, reduces upkeep and makes a Ford ride like a high priced car.

PRICED AT FIFTEEN-FIFTY—To the Man Who Acts Quickly

It replaces the Ford Disk Drum Housing. Leading auto engineers say that it is one of the great forward movements in the auto world.

Attractive and Exclusive Territory Proposition to Distributors and Sales Representatives  
DUNCOMBE OVERRUNNING CLUTCH CO., 2033 Woodward Ave., Detroit, Mich.

## Do Not Raise Ford Body

Telescoping coils of chrome vanadium steel between leaf spring and axle. Absorb vibrations, snub rebounds, prevent sideways. Fit all Fords. No other shock absorbers like them. Retail price, \$21.00, set of four. Fully guaranteed, 10 days' trial; money back if not satisfactory.

PRESSED METAL MFG. CO.  
Waukesha, Wis.

DEALERS:—Write for discounts and merchandising plan. A real opportunity.

**CUSHION-COIL**  
PAT. PEND'G  
Shock Absorbers  
FOR FORDS



## COMBINED VALVE LIFTER AND GRINDER for Ford Cars

Lifts Valves at the Head

Valve Springs are not taken out but remain on holders. Carburetor or Manifold need not be removed.

TIME AND EFFORT SAVED

Complete Outfit for Lifting and Grinding Ford Valves, with Compound and Bobber Spring, \$2. (Colo. and West \$2.25) Ask your dealer or jobber or write for illustrations.

The Dual Tool Co.

12428 Euclid Ave.

CLEVELAND, OHIO



Spring Holder

## AUTOMOBILE SUPPLY BARGAINS

Look at This "Taber" Muffler Cut-Out

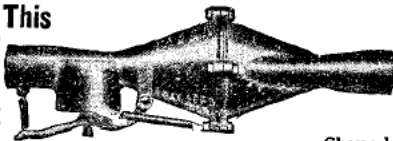

A Muffler with cast-in self-cleaning Cut-Out. It is proof against mud, carbon, rattle and blow-outs. It reduces back pressure to a minimum. It brings more power and gallon of gasoline.

Chevrolet  
Maxwell & Buick Cars  
For Ford & Fordson  
1.95 2.45

more miles out of every gallon of gasoline.

WE HAVE HUNDREDS OF SUCH BARGAINS!

We carry complete line of Fidelity Bodies, repair parts, tops, radiators, fenders and general accessories for Fords and other cars, all guaranteed standard quality.

Send for Free Catalog—Know what you should pay before you buy and be sure you are getting the lowest prices. Every page of this book is filled with bargains.

Nemco Bargain Supply House, Dept. 25, 1015 Jackson Blvd., Chicago

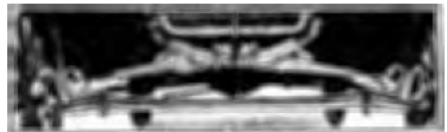

## FOR PERFECT RIDING

Ford owners are daily finding real car comfort and saving of cars and tires through the use of the

## "LONGSTRONG" SPRING

With this spring more resilience is guaranteed than with any shock absorber. It adds strength to the car and provides complete comfort, service and safety. It adds ten inches to the span of the standard Ford spring. Easily installed; requires no attention, and soon saves its cost.

Price complete with long clips ready to install, \$14.00.

DEALERS:—A Splendid Proposition Awaits You.

TERRE HAUTE AUTO SPRING CO.

TERRE HAUTE, INDIANA

When writing advertisers—Just say FORD OWNER AND DEALER

**NEW PRICES**—Recent sharp reductions in prices have resulted in even greater sales for **AUTOWA BODIES—For Ford Cars**

Above is shown the Autowa Five-Passenger Touring offering all the comfort and class design of highest-priced cars. This formerly sold for \$315. The new price is \$250. Similar reductions on Sleeper and Speedster types. Roadsters were \$325. Now \$225. Each Autowa represents expert workmanship, finest materials and substantial construction.

Send for catalog of complete line with full description  
**Ottawa Body Co., Ottawa, Illinois.**

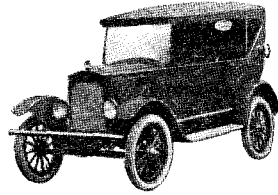

Attached in a moment. No tools or altering required. Self adjusting.

**—AND THE SPRINGS STAY OILED**

You know the importance of keeping your car springs properly lubricated—that it means saving of springs, tires and the car. You can keep springs oiled properly, easily and continuously with **NIFTY SPRING LUBRICATORS**

Just put them on and the springs Stay oiled. Just fasten the Nifty Lubricators around the thick part of the spring. Put oil in the reservoir and forget it. The oil will be properly distributed to every part of the spring.

Price, per set of four, \$1.50. Get them now.  
DEALERS: A sensible, speedy seller. Write for offer.  
**THE SPRINGCUP CO., 302 Schmid Bldg., St. Joseph, Mo.**

**WE TOP 'EM ALL**

Auto Tops for All Makes and Models of Cars  
Seat Covers—Dust Hoods—Fenders

Save one-half the cost of new Top by using our Slipover Coverings. Write for our Catalog.

**BUOB & SCHEU**

104-112 Webster Street

**CINCINNATI, OHIO**

**BATTERY-SUPPLIES**

*We Carry a Complete Line  
Plates—Jars—Covers—Separators—etc*  
**LEADER BATTERY EQUIPMENT CO. Inc.**

320 Title Guaranty Bldg., ST. LOUIS, MO.

MODEL 20 FRONT END TYPE

ALL ROLLER BEARINGS

POSITIVE LOCK

**WOODWARD 4 SPEEDS for FORD**

CARS AND TRUCKS

No. 1 UNDERDRIVE FOR POWER

No. 2 OVERDRIVE FOR SPEED

**BUILT THE BEST AND SELLS FOR LESS**

TRANSMISSIONS ONLY, ANY TYPE, \$80.00. Connections Extra for CARS \$12.50—TRUCKS \$17.50

323 Van Ness Ave  
SAN FRANCISCO

**WOODWARD & ROWE**

2125 Michigan Ave.  
CHICAGO

Agents and Distributors Wanted to Handle Exclusively

Easy Work

Good Profit

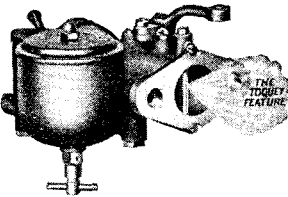

**QUICK SALES** Dealers everywhere report **SNAPPY PROFITS** in the sale of the **TOQUET CARBURETOR**

Ford owners know real value and they are quick to learn that the Toquet Carburetor positively does produce more power on hills—more speed on straight stretches—smoother idling through traffic—snappier pick-up—more miles per gallon of gas.

Every Toquet is absolutely guaranteed for complete satisfaction to the purchaser. We stand squarely behind it. Simple, well-made and efficient.

**TOQUET CARBURETOR CORP., Westport, Conn.**  
Car Owners, Dealers, Jobbers: Write for complete information today.

**SELF-OILING**

**BOLTLESS**

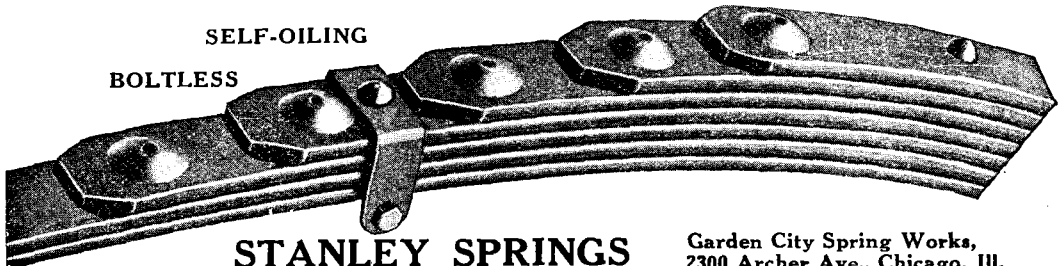

**STANLEY SPRINGS**

Garden City Spring Works,  
2300 Archer Ave., Chicago, Ill.

When writing advertisers—Just say **FORD OWNER AND DEALER**

Cooling Position  
Partly Open.

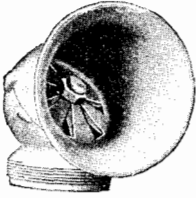

Cast Aluminum Highly Polished  
**\$2.85 PREPAID**  
Send for Circulars  
**RADIATOR FUNNEL CAP CO.**  
3852 Grand Boulevard, CHICAGO

**RADIATOR**

**SAFETY FUNNEL CAP**

A stationary Filler Cap. A Radiator Cooler. A Practical Funnel. A Reliable Overheat Meter. Good Looking. Sure.

Funnel Position  
Open for Filling

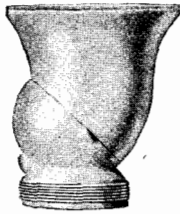

**MULTIPLE CANT-LEAK TIRE PUMP**

Built on a New Principle

NOTICE—The cast iron piston, light steel valve and three step-cut piston rings which expand thereby preventing leakage. Why lose patience or waste time in continually replacing leather washers in the old style pumps?

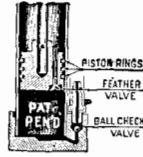

Fully Guaranteed  
PRICE \$6.00

We Also Manufacture  
**Froussard Cylinder**  
Reboring Machines  
**Multiple CANT-LEAK**  
Piston Rings  
Dealers, Agents and Sales  
Representatives wanted.  
**MULTIPLE BORING MACHINE CO., Inc.**  
St. Louis, Mo.

**INGRAM LIP-LOCK**

ACKNOWLEDGED THE "WORLD'S BEST"

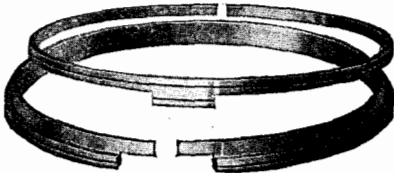

**PISTON RINGS**

ONCE INSTALLED THE TURN IS CALLED ON EXCESS GAS AND OIL BILLS  
POWER GALORE - ELIMINATES CARBON TROUBLES  
HEARTY CO-OPERATION WITH DEALERS AND USERS  
**INGRAM MOTOR CO.**  
EXECUTIVE OFFICES:  
2 RECTOR ST., NEW YORK CITY

**Cooper Special Cut-Out**

Attached without cutting exhaust pipe in two. Cannot rattle or chatter. Not affected by dirt, heat or carbon.

Sizes	With Pedal No. 3	With Pedal No. 4 or 5
1 1/2 inch Ford Size	\$3.00	\$3.50
1 5/8, 1 3/4, 1 7/8	3.50	4.00
2, 2 1/4	4.00	4.50
2 1/4, 2 3/8, 2 1/2, 2 5/8	4.50	5.00
2 3/4, 2 7/8, 3, 3 1/8	5.50	6.00

Special for Buick Cars, valve only \$3.00, with pedal 3, \$3.50, with pedal 4 or 5, \$4.00. If your dealer cannot supply you, write direct. Dealers, ask your jobber.

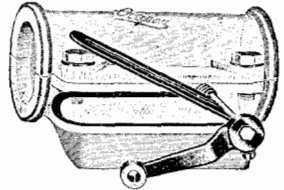

**COOPER MFG. COMPANY,**  
Dept. F  
Marshalltown, Ia.  
The Fulton Co.,  
Sales Mgrs.,  
Milwaukee, Wis.

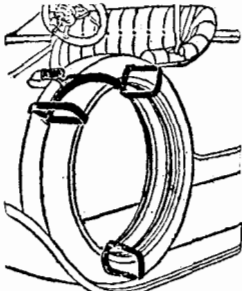

**TIRE**  
**Carrier**  
**\$1.25**

FITS REGULAR FORD BOLTS

Install it yourself in a jiffy!

Carries one or two tires, 3 or 3 1/2, mounted or unmounted. Tires can be locked securely to car. Dealers and jobbers write us.

**SHENAN TOOL & MACHINE CO**  
502 E. 9th St. Los Angeles, Cal.

**FEDERAL BODIES**

**WILL MAKE MONEY FOR YOU**

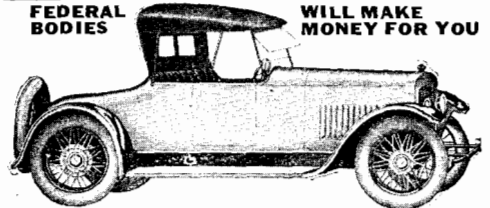

This beautiful "FRATERNITY" Roadster body built for Fords and Chevrolets is the latest and most comfortable body constructed. Choice of colors.

THE ABOVE IS ONE OF OUR TEN DISTINCTIVE DESIGNS  
DEALERS:—Write us at once for our new catalogue showing greatly reduced prices on FEDERAL Sport, Speed and Touring Bodies. Can make immediate shipments. **FORD BODIES AS LOW AS \$29.50**

Don't Pass Up This Opportunity  
**FEDERAL MOTOR SUPPLY CO., 2620 Michigan Ave., CHICAGO**  
Canadian Distributors: Auto Body Co., Toronto, Ont. Federal Auto Body Co., Campbellton, N. B.

**NEVER-FAIL**

**TIMER for Fords**

**Price \$2**

Phosphor bronze contacts, non-warp fibre, Never-fail **DIRECT THRUST** roller—no jump, no miss.

**NEVER FAIL PRODUCTS CORPORATION**

196 Jackson Avenue, Long Island City  
NEW YORK

**16,000 Miles without a Puncture**



Wonderful invention. Insyde Tyres—Inner Armor for automobile tires. Positively prevent punctures and blowouts. Guaranteed to give double tire mileage, any tire—old or new.

**Over 100,000 Satisfied Customers**  
Easily applied without tools. Just slip inside casing before replacing tube. Will not heat or pinch. Use over and over again. Old worn-out casings will give 3 to 5,000 miles more service. Low priced. Agents wanted in every county.

**American Accessories Co., 8-1937 Cincinnati, O.**



**ALL YEAR ROUND PACOS**  
 For winter and summer. A smart, low, foreign racing model for doctors, travelers, young men and women. Fits old or new Ford chassis. Write for attractive price TODAY.  
**PACO MFG. CO. Dept. 205, PEORIA, ILL.**

**BROWNIE OIL FILTER**  
**Don't Throw Away Your Dirty Oil!**  
 It is still good if you get the dirt out of it. Don't let your oil become a grinding compound. A BROWNIE FILTER will make it LIKE NEW. Three gallons will pay for the Filter.  
**Can You Afford to Be Without One?**  
 If your Dealer can't furnish, send direct.  
 Price \$2.50 Prepaid  
**A. J. BROWN, 376 31st St. Milwaukee, Wis.**



**SPARKO-GAP**  
 Now \$1.00 Retail!  
**Increases Engine Power 37%—Fires Even Fouled Spark Plugs**  
 Sparko-Gaps are patented—not to be confused with ordinary intensifiers. Their construction embodies the quench-gap principle used in wireless. Sparko-Gap produces the same remarkable results on all internal combustion engines. It is the only device to intensify spark approved by the United States Government. Thousands are sold everyday.  
**Increases Power—Saves Fuel—Prevents Carbon Trouble—Stops Oil Pumping.**  
**SPARKO-GAP CO.**  
 15 West 37th St., New York, N. Y.

**Liberal Discount to Agents**  
 Here is the chance of a lifetime to start an automobile business of your own. Agents are making real money selling Sparko-Gaps.  
 Write for Agency Proposition



**SURETY PEDAL PADS FOR FORDS \$1.25 PER SET**  
 Here's a thick molded pad of live rubber and heavy steel extension pedal in one. Gives the driver comfortable easy position with positive control at all times. **The Foot Can't Slip.** Complete satisfaction or your money back—that's our motto. Live representatives wanted.  
**GRANT AUTO APPLIANCE CO.**  
 315 S. Clinton Street CHICAGO, ILL.  
 Originators of the extension pedal idea. Licensed manufacturers under Grant Patents.

**HY-POWER TIMER**  
 For Ford Cars, Ford Trucks and Fordson Tractors  
**OUTLASTS FOUR ORDINARY TIMERS**  
 Is Averaging Over 16,000 Miles  
**Price \$1.50**  
**Send Us Your Order NOW**  
 Dealers and Jobbers Given Full Credit for All Mail Orders  
**BENFORD AUTO PRODUCTS, INC.**  
 MT. VERNON, N. Y.

**ROSE TIRE PUMPS**  
 The nation's best sellers. For years they have built their popularity on **EASY TIRE PUMPING.** You should sell them. Get our proposition. Ask about Rose Taper Nozzle Grease Guns, too.  
**Frank Rose Mfg. Co., Hastings, Nebr.**



**No Free Samples**  
**\$1.50 Worth FREE!**  
 I make this offer to prove to you that I have the most wonderful invention and quick seller never placed on the market. Every customer is a booster for you, and I will protect you on all resales. Do not confuse this device with so-called intensifiers, etc. Peck's Tester and Transformer will make an old worthless car run like a new car. It will save the cost of new piston rings and rebored cylinders. Fitted with my invention, a Ford runs like a 12-cylinder car. Thousands in use. Every customer satisfied. I furnish you advertising matter that makes an expert of an amateur in tracing and locating engine troubles. You make a dollar for every 10c invested. Quantity lots 100 for \$10. Retail price is 50 cents each. Owner-agents and dealers can get a set of 4 for 50 cents by sending this ad, which is good for \$1.50.  
**F. G. GARDEN, 311 So. Hicks St., Philadelphia AGENTS WANTED.**



**Money Makers For The Shop**  
 Repair shops which aim to make more money and do better work have quickly installed  
**LEWIS COMBINATION ALIGNING REAMER—For Ford Motors**  
 These perfect alignment on all bearings and will not dig, chatter or pull the babbit. No end thrust. Does rapid, accurate work easily. This is but one of the Lewis line of money-making equipment for the service station. Send for information covering all items.  
 Lewis Equipment will result in a big volume of business for you.  
**LEWIS TOOL COMPANY**  
 612 FIFTH AVE. MINNEAPOLIS, MINN.

When writing advertisers—Just say FORD OWNER AND DEALER.



**Sunlight Floods the Road with Light**

Increases your light 100%. Dimmer complies with all laws, and can be used on battery equipped Fords. Every Ford owner wanted as our agent. Regular price \$3.50—SPECIAL OFFER TO FORDOWNER READERS \$2.50 complete. SUNLIGHT CO., P. O. Box 394, Chicago, Ill.

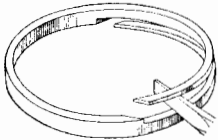

**STAR-K INLAND SPIRAL-CUT PISTON RING**

Highest grade. One piece, spirally cut, special heat treated. They "follow the wear" by uncoiling like a spring against cylinder walls with equal tension all around.

Stark Inland Machine Works



**STAR-K OILESS QUICK SEATING PISTON RING**

Stop oil pumping with this great popular priced ring. Has two oil grooves—one in middle for lubrication; one on lower shoulder to scrape down excess oil.

Velvet finish makes it "quick seating." E148



St. Louis, Mo.



**Don't Be a Mutt**

You don't need to pay a big, fancy price for a good spark plug any longer. Get a

**Little Jeff**

They sell at **Fifty-five Cents** retail for . . .

Besides giving you the best plug for a lot less money, we send free with every Little Jeff Plug one Little Jeff Plug Cleaner. This simple and ingenious new invention enables you to clean a set of plugs in two minutes. We will send one Little Jeff Plug Cleaner FREE to anyone upon receipt of a five cent stamp to cover cost of packing and mailing.

Write us today for booklet and prices

GENERAL ACCESSORIES CORPORATION, Chicago

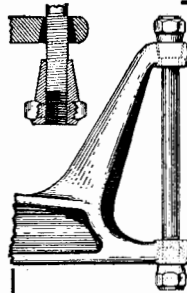

**STOP THAT WOBBLING AND RATTLE BY USING THE PRACTICAL LITTLE GIANT STEERING KNUCKLE TAKE-UP SPINDLE BOLT.**

This bolt can be put on any Ford or Chevrolet No. 490 axle by any workman. It is made to take up all play that is worn in a Ford or Chevrolet No. 490 axle. By tightening the nut it tightens the head of the bolt as well as the nut. This bolt is made of good steel. There is an oil hole for grease cup, nut to key with a cotter pin.

Price to dealers \$1.80 the pair. Retail at \$2.50. No experience necessary to install these bolts.

All one needs is a reamer, which we furnish for \$2.00. Prices to Jobbers made known on request. **THE LITTLE GIANT MFG. COMPANY**

212 N. Elm Street. IOLA, KANSAS.

**Big Money in Tire Repairing**

It's easy to make big extra profits doing tire repairing with a SHALER Vulcanizer. Many garages are making \$300 to \$500 every month. Requires no experienced operators—your ordinary help can quickly learn to operate it and do perfect work.

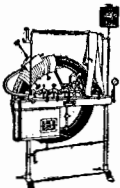

**SHALER STEAM VULCANIZER**

has Automatic Heat Control, and requires no regulating. Uses the Wrapped-Tread Method of repairing casings. Vulcanizes 12 casings and 200 tubes a day. Light, convenient and safe. Complete Outfit, with gas or gasoline burners, repair material, tools and full instructions, costs less than \$100.

Ask Your Jobber. Write us for complete catalog of the SHALER Line of Vulcanizers for tire repair shops and motorists' use.

C. A. SHALER CO., 2608 Fourth St., WAUPUN, WIS.

**HARVEY WHEELS**

**BETTER LOOKING—STRONGER**

More Ford owners daily are turning to Harvey Steel Wheels and Demountable Rims. Harvey steel wheels add to the appearance of any car and afford the greatest strength for their weight. They permit quickest tire change—add resiliency—easiest kept clean—give more miles per hour and less heat to tires. They are all steel and splendidly made.

Send for Complete Description and Prices Today

DEALERS:—There are real profits in offering this better wheel that car owners want.

**HARVEY RIM AND WHEEL CO., INC.**  
BUFFALO, NEW YORK

**New Life for Motors**



"Nu-Life" Piston Ring Expanders are placed under piston rings to restore their life. They absolutely stop oil pumping, cure piston slaps, increase compression, reduce noise

and carbon deposits, save oil and gasoline, and give life to the motor, without installing over-size rings or pistons. Made for all types of motors. To obtain best results install one under each piston ring. Price 25c each.

Ford Owners: Send \$3.00 for a Complete Set

**American Auto Products Co.**

1319 L Street, N. W., WASHINGTON, D. C.

**FOR YOUR FORD Excelsior Breather and Oil Filler Pipe**

Prevents oil spraying over motor, fan belts and wires. At your Dealers. If he cannot supply you, we will. Type A for 1915-1918 Fords; Type B for 1919-1921 Fords Easy to install. Black Enamel Finish.

Price **85c**

Manufactured by **EXCELSIOR AUTO PARTS & SUPPLY CO.**  
BRIDGEPORT, CONN.

**-LAMCO-**

Trade Mark Reg.



PRICES SLASHED—WRITE IMMEDIATELY FOR THE NEW CATALOG—JUST OFF PRESS

**Lehman Mfg. Co., Inc.** Cannelton, Ind.

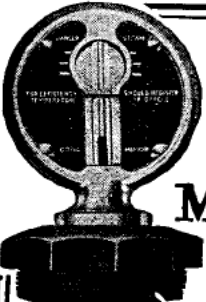

Special Model for the Ford

\$3.50

**BOYCE MOTO-METER**

*"Your car deserves one"*

THE MOTO-METER CO., INC.  
Long Island City New York, U. S. A.



**LONGSAFER**

(Patented)

**GASOLINE GAUGE AND GAS SAVER FOR FORD CARS**

Absolutely accurate gasoline tank gauge. Easy to inspect day or night; can be carried to light when necessary. No operative parts to stick, get out of order or collect dirt.

A loss by evaporation through vent hole, particularly during summer months, is prevented by venting through tube.

A convenient means for getting gasoline for priming cleaning tube for patch when making road repair, or any other purpose where a small quantity of gasoline is required.

Always read gauge before filling tank to check amount of gasoline required. Sizes to fit all Ford tanks. Price 75c by mail or at your dealers.

**BARCY-NICHOLSON COMPANY**  
2801 West Fort St., DETROIT, MICH.

NO MORE LOOSE CONNECTING RODS IN FORD CAR

**KIL-NOCK**

*Stops That Knock in Your Ford Motor*

We guarantee KIL-NOCK as represented, or Money Back.

Price per set..... **\$10.00**

DISTRIBUTORS AND DEALERS—WRITE FOR OUR PROPOSITION. THIS IS A REAL SELLER.

**KIL-NOCK COMPANY**  
DAVENPORT, IOWA, U. S. A.



**Quick Starting**

**Smooth Running!**

For immediate Starting and smooth running on coldest days—or in any weather install a

**Hot Spot Generator**

Attaches in one minute. Positively starts the motor on the coldest day. Can be operated one hundred times for one cent. No electricity required. Ready for immediate use. Get this time and trouble saver now. You will need it.

**COST COMPLETE \$1.00—POSTPAID**

AGENTS:—Write today for territory for this big seller.

**Hot Spot Generator Co.**  
1325 Walnut St., KANSAS CITY, MO.

**RED-I-FIT**

FOOT FEED

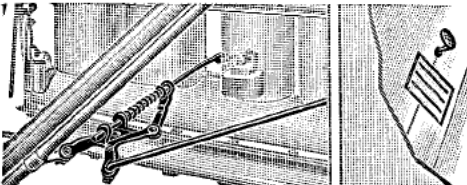

**ACCELERATORS WORK ALL THE TIME**

The extremely long life and unflinching service rendered so consistently is entirely due to their simple, but correct mechanical principle.

**GIVES THAT EASY AND POSITIVE MOTION**  
Installed by Two Cotter Pins  
**FITS ALL FORD CARS**

**HEATON-AULT, 6247 Greenwood Ave., Chicago.**

**MAKES ANY FORD a Delivery Truck**

**YOU** can convert your Ford into a practical delivery car chassis with 96 or 108 inches loading space back of driver's seat with the

**HAY-DEE EXTENSION**

A hammer and wrench—all that is needed.

**PRACTICAL AND ECONOMICAL.**

15-inch.....\$65 — 115-inch wheel base  
30-inch.....\$70 — 130-inch wheel base

DEALERS: Write for real profits.

**A. J. Diefenderfer Corp.**  
410 West 52nd St., NEW YORK CITY.

When writing advertisers—Just say FORD OWNER AND DEALER

## PERFECT LOCK

FOR FORD ROADSTER  
REAR COMPARTMENT LID

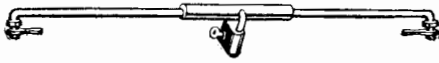

Locks Lid on both sides—  
and protects it in the center

WRITE FOR FULL PARTICULARS

THE STANDARD CORPORATION  
Columbus, Ohio.

## REYNOLDS SPRING CO.

RED DIAMOND CUSHIONS  
FOR FORD CARS

*A Perfected Product for Particular People*

Made by the largest exclusive Cushion Spring Factory in America and the most comfortable and durable cushions ever built by anybody.

Sold through regular channels only  
MANUFACTURERS SALES DEPT.  
REYNOLDS SPRING COMPANY THE ZINKE CO.  
JACKSON, MICH. 1323 Michigan Ave.  
CHICAGO, ILL.



**\$45**  
BUYS THIS  
SNAPPY  
SPEEDSTER

Just the graceful, racy sport car you want and you save big freight rates and one-half original cost through buying it knocked-down.

All parts cut to exact fit and accompanied by such complete, simple instructions that anyone can assemble it.

Complete with hood, Flat radiator shell, instrument board, upholstery, metal and wood parts, bolts, screws, etc.

Car owners and dealers: Send today for complete details.

CENTRAL AUTO SUPPLY CO.  
Eng. Dept. 123, Louisville, Ky.

## TIRE SAVING

Ford owners have at last found real tire economy in the new 1921 type

**ARMSTRONG**  
30 by 3½ R. C. N. S.  
CORD TIRE

This is full oversize, extra heavy shoulders. The handsomest and strongest tire of this size ever built. Guaranteed for 8,000 miles and good for double that.

DEALERS: We have an unusual proposition on a real seller among dealers for Fords. Write us today.

THE ARMSTRONG RUBBER CO., Inc.  
Sales Office, 4 W. 61st St. NEW YORK CITY

## STORM

CYLINDER REBORING  
MACHINES

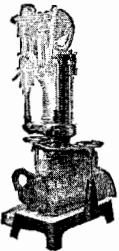

WORLD'S standard for speed, accuracy and reliability. Made in all sizes from small hand tools to large vertical Boring, Burnishing and Milling Machines.

Capacities to meet your requirements.

Write today for complete catalog covering Storm Equipment. Dept. M.

STORM MFG. CO.  
Minneapolis, Minn.

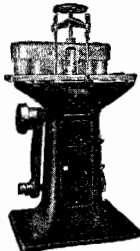

## LAMINUM

Laminated Shims are furnished ready-to-use for Ford crankshaft rear bearing, crankshaft front and center bearing, and connecting rod, in ½ or ⅜ inch thickness.

Address "Ford Sample Dept."

LAMINATED SHIM CO., Inc.  
14th St. & Governor Place, Long Island City, N. Y.  
DETROIT: Dime Bank Bldg. ST. LOUIS: Mazura Mfg. Co.  
CHICAGO: 1118 So. Michigan Ave.

The  
Jennings Governor  
for the  
Fordson Tractor  
The Jennings Engineering  
Company

504 Butler Building, DETROIT, MICH.

FOR FULL SATISFACTION USE  
Flynn Spark Plugs  
Full Particulars From  
JAMES FLYNN & CO.  
4551 White Plains Ave.  
BRONX, N. Y.



# STEEL WINGS



Comfort, Stability, Endurance  
TRIPLE PURPOSE SPRING  
FOR FORD FRONT

Guaranteed for the Life of Your Ford  
Eliminates All Necessity for Other Shock Absorbers

**STEEL WINGS CO.**  
Desk B. 670 Washington Blvd. CHICAGO, ILL.

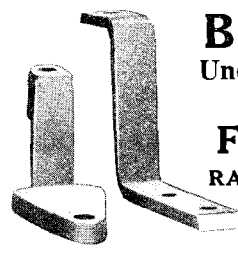

## BRECco

Underslinging Irons  
FOR FORDS  
FIAT TYPE  
RADIATOR SHELLS  
RADIUS ROD  
EXTENSIONS

Get our letter of instructions for underslinging cars

### BREEDEN & COLE

149 11th Street, SAN FRANCISCO, CAL.

## CLASSIFIED ADVERTISEMENTS

Advertisements inserted under this classification for 7c per word; name and address must be counted; no order for less than \$1.50. Cash must accompany order. Advertising copy due by the 10th of the month preceding date of issue. Write for Classified rates on twelve-time contracts. This advertising gets big results.

## Ford Speedster Bodies AND SPEED SPECIALTIES BIG PRICE REDUCTIONS

SAVE 30 to 60% BUY NOW!

This Month's Specials	Price	Special
Foot Accelerators.....	\$ 2.75	\$ 1.10
Manifold Hot Spots.....	5.00	2.19
Sight Feed Oilers.....	7.50	2.25
3:1 Bevel Gears.....	16.50	7.75
Underslung Fixtures.....	20.00	11.95
7-Day Waltham Auto Clock.....	25.00	9.50
4 Speed Victor-Ford Transmission.....	100.00	69.50

50% with order; Balance upon delivery. Satisfaction or money back guarantee. **I. H. Ford Speed & Power Equipment Manufacturers, 250 West 54th, New York. Cable Address Fordspeed Telephone Circle 0612.**

## Ford Top Recovers

**FORD TOP RECOVERS** of double texture, long grain, tan and black auto-leather, same as high grade tops are made of, consisting of roof, side quarters and back curtain with 2 oval glass lights nickel rimmed 5x7. Made up ready to slip on your old top for \$9.50. Tacks and binding included. We also make special seat covers for Ford Sedans. Covering, seats, backs, doors and panels from windows down to floor. Made of high grade seat-cover cloth as used in the larger cars. Edges all bound ready to attach in half hour. At a special low price of \$12.50. These top recovers and seat-covers are made of high grade material and will appeal to people wishing a first class article at a low price. Parcel post paid when money accompanies order. Write for samples. **Atlantic Auto Top Co., 3310 Atlantic Ave., Atlantic City, N. J.**

**NEUTRAL Safety Pedal.** Makes your Ford car a selective drive, will hold forward speed in neutral independent of emergency lever. A real necessity for a Ford car. County agents wanted. Send \$3.50 for agent's sample. **Auto Safety Supply Co., 3247 W. Van Buren St., Chicago, Ill.**

Fords run 34 miles per gallon on cheapest gasoline or half kerosene, using our 1922 carburetor. Increased power; styles for all motors; attach yourself. Money back guarantee; 30 days trial. Big profits to agents. **Air Friction Carburetor Co., 3211 Madison St., Dayton, Ohio.**

**Attention—Ford car and tractor owners—** Tractor top with back cushion curtains, all round, \$49.50. Ford one man tops complete with curtains, \$42 and up. Topping outfit roof quarters and back curtain, \$7.75 and up. Back curtains, \$2.90 and up. Side curtains, \$10.50. Five piece artificial lace door coverings and panels, \$3.00. Seat covers, \$7.50 and up. Twin front seat cushions, \$10.50. Single front seat cushions, \$8.00; Rear seat cushions, \$8.50. Back upholstery ready to tack in—Front seat back, \$10.00; rear seat back, \$11.00. Our entire line includes all makes of cars. Motor boats and motorcycles. We also re-cover tops sent to factory. Samples, material and prices upon request. **Atlantic Auto & Body Works, 136 Jamaica Ave., Brooklyn, N. Y.**

**AUTOMOBILE OWNERS: Why pay big prices for puncture and blowout repairs?** Our all rubber self-vulcanizing patch welds permanently. Easily applied—no delay—tire or tube ready for immediate use. Quantity sufficient for 50 or more punctures, cleaning fluid and buffer complete. Regular price \$1.00. Send us your dealer's name and address with \$1.00 for two full size outfits. **Iron-Clad Labs., Inc., 416 Carroll St., New Orleans, La.**

**WANTED—Men with Ford cars to sell STOKES CARBURETORS.** Exclusive territory given. Write for particulars. **Stokes Carburetor Co., Inc., Good Ground, Long Island, N. Y.**

**PATENTS—Write for illustrated Guide Book and Evidence of Conception Blank.** Send model or sketch and description for our free opinion of its patentable nature. Highest references. Prompt service. Reasonable terms. **Victor J. Evans & Co., 627 Ninth, Washington, D. C.**

**REBORE THE CYLINDER—Insert piston.** No grinding, no lapping. Our \$20 Ford Cylinder Re-boring Tool leaves the cylinder absolutely smooth all ready for the piston. Simple, easy, rapid, accurate. Request circular. **Goruse Company, Elmira, N. Y.**

**“INVENTORS—Don't lose your right to patent protection.** Send for blank form 'Evidence of Conception' to be signed and witnessed and information bulletin 'How to Establish Your Rights.'” Both are free and very desirable to proper patent procedure. **LANCASTER and ALLWINE, 238 Ouray Building, Washington, D. C.**

## Classified Advertisements—Continued

We want a selling connection in every City and County in the United States to market the "AMCO" Automatic Safety "STOP" Signal, the "AMCO" Auto-Light Deflectors and the "AMCO" Super TIMER for Ford Cars and Tractors. Three of the fastest selling accessories ever placed on the market. Parties must be able to finance themselves on a strictly cash basis. Address **The Art Metal Mfg. Co., E. 61st & Curtis, Cleveland, Ohio.**

**For Trade**—Ford Gray & Davis Single Unit Starter Less Battery. Want Ford Atwater-Kent or Philbrin Ignition System. **E. E. Bren-ton, Logansport, Indiana.**

**Automobile Owners** to use Time Saver the No-cement patch tire & tube ready for immediate use self-vulcanizing patch. Regular price, 50c, \$1.00, \$1.50. Post Paid order yours to-day. **Giant Accessories & Tire Co., 200 Brushton & Tioga, Pittsburg, Pa.**

**For Sale**—Up to date Garage 50x120 Cement Stucco front. Have Ford contract local branch willing to arrange to suitable party, have sold 20 cars over years contract. Address, **M. P. Ford Owner and Dealer, Milwaukee, Wis.**

Ford wheels throw grease? Best thing yet, only 50c a wheel, lets the roller bearing have grease but not the wheel. **Bethel Garage, Bethel, Vt.**

**Big Profits Easy**—Duplex Transformers needed on every auto. Save gas. Easily sold. Exclusive distributors wanted. **Jubilee Mfg. Co., 118 Sta. C, Omaha, Nebr.**

### AGENTS WANTED

Towlines sixteen feet long with hooks. Small enough for tool box. Replaced if broken within year. \$2.50 delivered. Agents price \$15.00 dozen. Sample \$1.50. Order sample today. Will buy back any you don't sell. **The Superior Manufacturing Co. Penn-Lillis Building, Cleveland, Ohio.**

**"Ford and Fordson Owners."**—Stop that motor from pumping oil. Instructions, Sample of treated piston \$1.00. No extra to buy. Eight years with Ford Motors. The only successful method known. Guaranteed or money refunded. **J. W. Reynolds, Liberal, Kans.**

**Champion Spark Plug Bargains!**—Compare prices, Ford size 59c. For other cars 69c. Sent postpaid anywhere. **Morris Service, Box 524, Omaha, Nebr.**

**SALESMAN.** If you are calling on dealers, garages and service stations you can add \$150.00 per month and upward to your income without extra effort, selling a standard replacement article, exclusive territory. State territory you cover and lines you handle now. Address **W. M. Meek, Tribune Building, New York City.**

**Wanted**—Salesmen who call on Ford Dealers, Service Stations, Garages, Jobbers and Accessory Stores. Can earn a neat sum each month without interfering with their regular work. Write for particulars.—**Ford Owner and Dealer Magazine, Dept. C., Montgomery Bldg., Milwaukee, Wis.**

**Agents, Make big money selling our world beater auto accessory.** Circulars and information free. Sample 25 cents. **Easton Sales Co., Southboro, Mass.**

**"Salesmen wanted — for A. U. W. Spring Lubricating Covers for Fords.** Easy seller. Terms attractive. Price Six Dollars for front and rear. **Harrison & Hall, Baltimore, Md.**"

**OIL GAUGE FOR FORDS.** Remarkable new invention. Sells on sight. Big profits easy. Exclusive distributors wanted. Address **Sales Mgr., 118 Sta. C, Omaha, Nebr.**

**Belt Power Attachment, Price \$6.** agents wanted. **George Stirdivant, Sheboygan Falls, Wis.**

**Avoid "turning turtle," leaving the road locking over center.** You can steer safely and easily out of ruts, through mud, sand, snow and on center-crowned roads, with our Worm Steering Gear. Same type as used on all larger cars. Prevents bumps or other obstacles turning the front wheel aside and throwing car from the road; gives you control of the steering. Also absorbs vibration, shock and strain on arms and shoulders. Makes a far safer and better car. Easily, quickly installed; no holes to bore; outlasts car. Guaranteed to satisfy you. Write for particulars. **Union Sales Co., Dept. 4, Omaha, Neb.**

**INVENTORS should write for our book "How to Obtain a Patent,"** which contains valuable information which every inventor should have. If you will send us a sketch, model or photograph of your invention we will promptly make search of the Patent Office records and advise you whether or not your invention is in our opinion patentable; our charge for the service being \$5.00. With an experience of over twenty years we feel that we are fitted to render you prompt efficient service which will merit your confidence. Moderate charges. Write today. **Talbert & Talbert, 451 Talbert Bldg., Washington, D. C.**

## Victor Foot Accelerators Sell!

### Ford Owners Want the Victor Foot Accelerator

Permits use of both hands for driving. No alterations to car necessary. Easily installed in ten minutes. Only two connections—hand throttle and carburetor. Spring action entirely independent of hand throttle. Quicker and smoother get-away. No part fastened to floor board to interfere in removing same. Direct connection to carburetor eliminating lost motion and complicated spring devices. No vibration; resists wear, guaranteed. Price \$2.25.

Sales Agents: We Have An Attractive Proposition For You. Write. **VICTOR PRODUCTS COMPANY, Springfield, Ohio.**

**\$50.00 Per Week, easy making and selling Anti-freezing compounds and polishes for Automobiles.** Four formulas \$1.00. Satisfaction guaranteed. **Alfred Bentz, Wauwatosa, Wis. Box B.**

**Salesmen Wanted:** If you are calling on any kind of automobile trade we have an accessory which is in demand and can be sold easily and will pay good commission. Now is the best season. Write at once stating territory you cover. **UNION SPECIALTIES CO., 5871 Glenwood, Chicago.**

**For Sale Roof 16 valve head type B in good running condition.** Price \$40, either cash or C. O. D. **Mark E. Otrich, Dongola, Ill.**

**"Salesmen with Ford cars! Look at our ad of the Venn Auto-Lock on page 127, and then write us for our liberal selling proposition to users.** **Taylor-Shantz Co., 482 St. Paul St., Rochester, N. Y.**"

**OIL PUMPING MOTORS are costly.** This trouble can be easily overcome. Write today for free advice on a simple and economical means of ending this nuisance. State make, model and year of your motor. **J. A. CHOPA, Auburn, Ind.**

**YOU CAN MAKE MONEY.** Your Ford and our seven passenger bus body, drop windows, nicely painted extra heavy springs \$100 cash.

**Cameron & Sons, North Chicago, Ill.**

## Classified Advertisements—Continued

**SYSTEMATIZE YOUR AUTO REPAIR SHOP**—Bin Label Cards for Ford Auto, Ford Starter, Ford One-Ton Truck and Fordson Tractor Parts, Sheet Metal Card Holders, Auto Stock Forms, Job Repair Tickets, Time sheets, Requisition Blanks, Order Books, Cash Sales Slips, Repair Tags. Send for free samples and free booklets: How to Systematize the Auto Stock Room and Build Bin Racks; Perpetual Stock Inventories, and Book-keeping Hints for the Auto Dealer. **Haddon Bin Label Co., Haddon Heights, N. J.**

**Peeljay step-cut piston rings for automobile, tractor, truck and marine engines.** Guaranteed to do everything a piston ring can do. Two to four and one-half inch diameter, fifty cents. Special set of twelve for Ford \$4.50. **Phil. Jacobs, Distributor, Portsmouth, Ohio.**

**AGENTS make big money selling our all rubber self-vulcanizing patch for tires and tubes.** Large orders from accessory dealers. Exclusive territory to right party. Send \$1.00 for complete outfit and instructions. **Iron-Clad Labs., 416 Carroll St., New Orleans, La.**

**Salesmen—To sell our Carbon Remover, Radiator Cement, Polish and other products to automobile owners and accessory dealers.** Big commissions and a wonderful opportunity for hustlers. **Bush Chemical Company, St. Louis, Mo.**

**Accessory Dealer, 100 Per Cent Profit on Cost.** Send name and address. We'll send you proposition, which gives you 100 per cent profit on cost, and our 50c size free, postage prepaid. No obligation to buy. **NoXal Co., 1238 Belmont Ave., Philadelphia, Pa.** Mention Ford Owner.

**AGENTS—\$250 worth Self-Selling Auto Devices** quickly made from \$10 worth of material. No experience or tools required. Fast seller, Agents or Mail Order. Investigate. **Exchange System, Cullom, Illinois.**

**Genuine Duntley Magneto Break Timers, for Fords.** Never misses. Formerly sold for \$5.00. Money order for \$2.00 brings one to you by prepaid insured mail. **E. Cowles, Columbus, Indiana**

**Late model genuine "Hot Spot" Wilmo manifold for Ford cars.** Check for \$3.75 gets immediate shipment. **United Supply Company, Dallas, Texas.**

**Wanted agents to sell Hercules heat-resisting tire and tube patch.** Exclusive territory and liberal commission.

### THE RILEY RUBBER CO.

543 Bienville St. New Orleans, La.

**HUBBELL GLASS WINDOWS**—the highest class, biggest value on the market, for replacing celluloid in rear curtains. Suspended from top bow of car with web straps to prevent sagging and tearing. **Black Enamel Frames, set of three, complete, \$2.00. Aluminum, \$2.50.** Postpaid. Agents wanted. **The Hubbell Mfg. Co., 1163 Addison Road, Cleveland, O.**

**Life time opportunity to represent manufacturer** nationally known product. Big repeats, handsome profit. Sample and information free. **Utility Co., 639 W. 44th St., N. Y.**

**Ford timers reground, better than new 35c, 3 for \$1.00; try us.** **Stephen Mackin Machine Shop, 54 Hermon St., Worcester, Mass.**

**A GENUINE FORD RACING CAR.** **Eiseman Magneto, Rayfield Carburetor, Outside exhaust, Torpedo body with high, narrow, honeycombed, radiator. Underslung frame.** Everything like new. Job cost \$1400. Plenty of extras. Send for photo, particulars and **DIRT CHEAP** price. **Fose 306 Hearst Building, Chicago, Ill.**

**16 Valve Roof Cylinder Head, \$65.00, used one month, complete with special gasket.** **H. Penrose, 1927 West Pacific St., Philadelphia, Pa.**

**10,000 Money making plans, any one of which may increase your earnings \$5 to \$25 per day.** Details 25c. **Business Builders, Box 720, Minneapolis, Minn.**

**"Worth hundreds of dollars to every car owner; worth thousands to manufacturers and garages**—Formulas, 17 different auto necessities for \$1.00; Descriptive circular **FREE.** **Eureka Supply Co., Wheeling, W. Va."**

**Is your Ford Timer equipped with the Ahern Timer Wire Guard.** If not send \$1.25 to **M. Ahern 13 Columbia St., Ansonia, Conn.,** and he will send you a real trouble Saver.

**Matthews Farm Light Plant and Duro Water System for sale at big discount.** Never used. Will sell either or both. **The Way Company, Houston, Texas.**

**\$108, weekly, selling our marvelous new Heat-O-Meter.** Every automobilist wants one. Wonderful opportunity; write today. **Pegasus Co., 160 E. 31 St., New York.**

**DON'T BREAK YOUR ARM cranking your Ford.** Get a Miller Starter for \$5.75, postpaid, try it, then get an agency and sell to your neighbors and make money. **H. A. MILLER, Mfr., Memphis, Missouri.**

**MAKE RESERVATION FOR SPACE NOW IN THE**

**JANUARY New York Auto Show**  
and  
**Business Revival Number**

This will positively be the biggest, the most interesting and talked about issue of Ford Owner and Dealer Magazine ever published. It's a great advertising medium.

Address Dept., G.

**FORD OWNER and DEALER**  
**Milwaukee, Wis.**

Ford Owner and Dealer Magazine published monthly, at Milwaukee, Wis., required by the act of Aug. 24, 1912. Publisher **H. A. Apple, 504 Montgomery Bldg., Milwaukee, Wis.;** Editor **H. A. Apple, 504 Montgomery Bldg., Milwaukee, Wis.;** Business Manager **C. P. Treviranus, 507 Montgomery Bldg.;** Advertising Manager, **F. L. Goulston, 505 Montgomery Bldg., Milwaukee, Wis.;** Managing Editor, **H. J. Larkin, 503 Montgomery Bldg., Milwaukee, Wis. Owners: Trade Press Publishing Co., 505 Montgomery Bldg., Milwaukee, Wis.;** **H. A. Apple, 504 Montgomery Bldg., Milwaukee, Wis.;** **Rose M. Apple, 790 Farwell Ave., Milwaukee, Wis.;** **F. L. Goulston, Known bondholders, mortgagees and other security holders, holding 1 per cent or more of total amount of bonds, mortgages, or other securities, none. P. C. Treviranus, Business Manager. Sworn to and subscribed before me this 8th day of October, 1921. B. H. Boettcher, (seal), Notary Public, Milwaukee County, Wis. (My commission expires March 25, 1923.)**

# INDEX TO ADVERTISERS

## A

A. C. Mfg. Co. ....133  
 Adjustable Bearing Co., Inc. ....123  
 Advance Automobile Acc. Corp. ....1  
 Ajax Auto Parts Co. ....67  
 Alger Mfg. Co. ....26 and 27  
 American Accessories Co. ....136  
 American Auto Products Co. ....138  
 American Auto Top Co. ....116  
 American Taximeter Co. ....104  
 A. R. G. Auxiliary Spring Co. ....126  
 Armstrong Rubber Co., Inc. ....140  
 Arvin Heater Co. ....69  
 Atwater Kent Mfg. Co. ....19  
 Auto Equipment Co. ....120  
 Auto Products Co. ....28  
 Auto Specialties Mfg. Co. ....98  
 Automatic Auto Locks, Ltd. ....106  
 Auto Products Mfg. Co. ....132

## B

Ballman-Whitten Electric Co. 97  
 Barcy-Nicholson Co. ....139  
 Benford Auto Products Co. ....137  
 B. & H. Sales Co. ....113  
 Breeden & Cole. ....141  
 Briggs & Stratton Co. ....111  
 Merton L. Britt. ....109  
 A. J. Brown. ....137  
 Buob & Scheu. ....135  
 Burd High Compression Ring Co. ....106  
 Byrne-Kingston & Co. ....44

## C

Cantrell-Miller Mfg. Co., Inc. ....35  
 Castor Distributing Corp. ....31  
 Cataract Mfg. Co. ....5  
 C. C. & F. Mfg. Co. ....124  
 Central Auto Supply Co. ....140  
 Champion Mfg. Co. ....127  
 Champion Spark Plug Co. ....108  
 Chicago Electric Mfg. Co. ....124  
 Cincinnati Lamp & Bracket Co. 103  
 Cleveland Water Still Co. ....101  
 Clover Mfg. Co. ....100  
 Colestock Mfg. Co. ....130  
 Adam Cooks' Sons. ....  
 Cooper Mfg. Co. ....136  
 C. Cowles & Co. ....107  
 Cramer Mfg. Co. ....2  
 E. D. & A. F. Cronk, Inc. ....125  
 Curtis Pneumatic Mch. Co. ....126  
 Cyclo Manifold Co. ....125  
 Cyl-Lap Products Co. ....119

## D

Dale Mfg. Co. ....7  
 Defender Auto Lock Co. ....14  
 Detroit Garage Equipment Co. ....127  
 Detroit Parts Mfg. Co. ....16  
 Detroit Sterling Control Co. ....130  
 A. J. Diefenderfer Corp. ....139  
 Douglas Auto Appliance Co. ....129  
 Dow Chemical Co. ....39  
 Dow Co. ....123  
 Dual Tool Co. ....134  
 Duncombe Overrunning Clutch Co. ....134  
 Dunn Mfg. Co. ....116

## E

Eclipse Timer Mfg. Co. ....20  
 Electric Machine Co. ....118  
 Ensign Carburetor Co. ....32  
 Essential Automotive Prod. Co. 64A  
 Excelsior Auto Parts Co. ....138

## F

Federal Motor Supply Co. ....136  
 James Flynn & Co. ....140  
 Four-A Products Co. ....25  
 France Mfg. Co. ....122

## G

Garden City Spring Works. ....135  
 F. G. Garden. ....137  
 Gemco Mfg. Co. ....177  
 General Accessories Corp. ....138  
 A. Gilbert & Sons Brass Fdry. Co. ....100  
 G. & O. Mfg. Co. ....75  
 Grant Auto Appliance Co. ....137

## H

Harvey Rim & Wheel Co. ....138  
 Hartland Co. ....118  
 Robt. H. Hassler, Inc. Front Cover Hastings Mfg. Co. ....127  
 Hawthorne Lamp Works. ....120  
 Heaton-Ault Co. ....139  
 Herz. ....129  
 F. G. Hirst. ....122  
 Holley Carburetor Co. ....36 and 37  
 Holms & Bostrom. ....134  
 Hot Spot Generator Co. ....139  
 Hugro Mfg. Co. ....12  
 Hutter-Shutter Co. ....121  
 Hydro-United Tire Co. ....132

## I

Imperial Bit & Snap Co. ....115  
 Independent Storage Battery Co. 108  
 I-Na-Da Fender Brace Mfg. Co. 110  
 Ingram Motor Co. ....136  
 Inland Metal Products Co. ....123  
 International Auto Drive. ....133  
 International Correspondence Schools. ....119

## J

Jaffe Radiator Co. ....10  
 Jennings Engineering Co. ....140  
 Johnson Co. ....114

## K

K-D Lamp Co. ....110  
 Komp Mch. Wks. ....28  
 Keystone Reamer & Tool Co. ....33  
 Kil-Noek Co. ....139  
 Kork-Tred, Inc. ....132

## L

Laminated Shim Co., Inc. ....140  
 Lazear Products Co. ....22  
 Laurel Motor Corp. ....122  
 Leader Battery Equip. Co., Inc. 185  
 Lehman Mfg. Co., Inc. ....139  
 Lewis Tool Co. ....137  
 Little Giant Mfg. Co. ....138  
 Lockwood Products Co. ....132  
 David Lupton's Sons Co. ....18  
 Lyon Metallic Mfg. Co. ....111

## M

Macorvey Co. ....119  
 Marathon Elec & Mfg. Co. ....131  
 Marquette Mfg. Co. ....122  
 Marvel Carburetor Co. ....100  
 Master Products Co. ....105  
 McKay Carriage Co. ....121  
 McKinnon Dash Co. ....117  
 Metal Specialties Mfg. Co. ....30  
 Michon Mfg. Co. ....130  
 Miller-West Co. ....102  
 Milwaukee Auto Eng. & Sup Co. Inside Front Cover  
 Monroe Body Corp. ....112  
 Morton & Brett. ....100  
 Moto-Meter Co., Inc. ....139  
 Motor Products Corp. ....117  
 Multiple Boring Mch. Co. ....136

## N

Nathan Novelty Mfg. Co. ....107  
 National Aluminum Co. ....130  
 National Rubber Piller Co. ....103  
 Never-Fail Products Corp. ....136  
 New England Mills Co. ....134  
 New York Coil Co. ....109 and 40  
 Non-Kick Device Co. ....113

## O

Omar Tire & Rubber Co. ....120  
 Ohio Instrument Mfg. Co. ....24  
 Ottawa Body Co. ....135

## P

Paco Mfg. Co. ....137  
 Penberthy Injector Co. ....128  
 Perfection Auto Parts Co. ....120  
 Perfex Radiator Co. ....102  
 N. A. Petry Co., Inc. ....125  
 Phoenix Mfg. Co. ....101  
 Piston Ring Co. ....34  
 Plate Glass Mfrs. of America 104  
 Pressed Metal Mfg. Co. ....134  
 Pressure Proof Piston Ring Co. 119

## R

Racine Screw Works. ....101  
 Radiator Pannel Cap Co. ....128  
 Rain-Sun Vision Shield Co. ....121  
 Rajo Motor Co. ....3  
 Republic Rubber Co. ....131  
 Red Cup Lubricator Co. ....125  
 Reynolds Spring Co. ....140  
 Ringless Piston Co. Back Cover

Romort Mfg. Co. ....11  
 Frank Rose Mfg. Co. ....137

## S

Safety Oiling System, Inc. ....41  
 Scandinavia Belting Co. Inside Back Cover  
 A. Schrader's Son, Inc. ....115  
 Security Auto Lock Co. ....73  
 Service Products Co. ....120  
 C. A. Shaler Co. ....138  
 Shehan Tool & Mch. Co. ....136  
 Simplex Hot Plate Co. ....13  
 Simplex Gauge Co. ....129  
 Smooth-On Mfg. Co. ....105  
 South Bend Wrench & Tool Co. 15  
 Sparko-Gap Co. ....137  
 Springcup Co. ....135  
 Spurgeon Bros Mfg. Co. ....124  
 Standard Corp. ....140  
 Standard Motor Parts Co. ....17  
 Stark-Inland Mch. Works. ....138  
 Steel Products Mfg. Co. ....71  
 Steel Wings Co. ....141  
 Storm Mfg. Co. ....140  
 Sunlight System Co. ....138  
 Taylor-Shantz Co. ....127  
 Terre Haute Auto Spring Co. ....134  
 W. H. Thomas Mfg. Co. ....123  
 Thomson-Friedlob Mfg. Co. ....42  
 Toledo Automotive Products Co. 105  
 Toquet Carb. Co. ....135  
 Tractor Train Co. ....128  
 Turner Mfg. Co. ....21  
 Twin Springs Sales Co. ....112

## T

Van Atlas Corp. ....29  
 Vix Motor Accessories House. 23  
 Vogt Mfg. Co. ....124

## W

Walker Mfg. Co. ....8 and 9  
 E. T. Walling Service. ....128  
 W. J. Walsh. ....105  
 Watervliet Tool Co., Inc. ....126  
 West Mfg. Co. ....6  
 Edwin L. Wiegand Co. ....99  
 Williams Bros. Aircraft Corp. 64B  
 Willard Storage Battery Co. ....43  
 K. R. Wilson. ....4  
 Winter Comfort Heater Co. ....121  
 Wire Wheel Corp. of America 38  
 Woodward & Rowe. ....135  
 Worthmore Mfg. Co. ....114

## Y

Yale Corp. ....106



## SCANDINAVIA BRAKE LINING IN A NEW BOX

BRIGHTLY ARRAYED—TO EMPHASIZE ITS LEADERSHIP  
AND DISTINGUISHED SERVICE.

**S**CANDINAVIA Brake Lining for Ford Cars persistently and consistently holds its quality—a quality that cannot be made over night. The same high standard has been maintained throughout the years past and is still maintained despite the pressure of big business.

Our faith in the inherent desire of men to have the best brake lining that human minds and hands can make is responsible for the Superiority of Scandinavia.

So far as the dealer is concerned it is not merely a question of quality, or price, or advertising, or service or any other one thing.

It is the combination of all these vital merchandising factors which Scandinavia offers you.

Constructed of the best long staple cotton, interwoven into a compact fabric, especially impregnated processed and hardened to resist oil, heat and grit.

Let us send you our booklet—"How to change Ford brake and transmission linings."

*Scandinavia Brake Lining is as efficient as an  
Air Brake. Be sure—look for the New Box.*

**ATTRACTIVE JOBBER AND DEALER PROPOSITION.**

## SCANDINAVIA BELTING CO.

106 Reade Street, New York City.

BRANCHES: Atlanta, Boston, Chicago, Cleveland, Easton, Pa., Pittsburg,  
San Francisco, Los Angeles, Portland, Ore.



TRADE MARK

## THE RINGLESS PISTON

An installation of Ringless Pistons in the engine of your car is a simple matter.... But the results in increased motor efficiency, are far-reaching and Permanent. For the Ringless Piston, Tismer Patent, is delivering engine service today which was undreamed of when piston rings were considered a necessary evil.

It has not only proved that rings are unnecessary, but are a primary cause of oil-pumping, the formation of oil-carbon, over-heating, pre-ignition, fouled valves and loss of power. In a word, the Ringless Piston "gives the oil a chance"—to lubricate the cylinders and form a gas-tight seal against compression.

Once in place, each piston will outlast the engine, without further attention or adjustment. It will keep the combustion chamber free from oil, eliminate smoke from the exhaust and absolutely prevent damage from over-heating.



The Old Style Piston



The Ringless Piston

*Send for descriptive folder*



This is accomplished without any structural change in the motor itself.

It can be installed as a piston replacement wherever motors are overhauled. It requires no special machinery or tools for a perfect installation. Its cost is within the reach of every car owner.

This Company or its branches will furnish further information upon request.

### THE RINGLESS PISTON REPLACEMENT CORPORATION

103 Park Avenue  
NEW YORK

225 North Mich. Blvd.  
CHICAGO

126 New Montgomery St.  
SAN FRANCISCO

When writing advertisers—Just say FORD OWNER and DEALER