

**Ford**

THE UNIVERSAL CAR

**Price List of Parts  
and Accessories**

**MODEL T**

**Ford Motor Company**  
DETROIT, MICHIGAN

**July 1st, 1921**

---

**Prices subject to change without notice**

---

Of the net amount at which these parts are billed to purchasers who purchase direct from the Ford Motor Company (except parts which show no Tax Status, if any) 20/21 represents the price of the goods and 1/21 represents excise tax.

# Ford Motor Company

## FORD FACTORIES AND BRANCHES

Ford Factory, Detroit—*Parent Plant*  
Ford Factory, Ford, Ontario, Canada  
Ford Factory, Manchester, England

## AMERICAN WHOLESALE BRANCHES

Atlanta	Cleveland	Fargo	Los Angeles	Oklahoma City	Salt Lake City
Buffalo	Columbus	Houston	Louisville	Omaha	San Francisco
Cambridge	Dallas	Indianapolis	Memphis	Philadelphia	Scranton
Charlotte	Denver	Jacksonville	Milwaukee	Pittsburgh	Seattle
Chicago	Des Moines	Kansas City, Mo.	Minneapolis	Portland	Washington
Cincinnati	Detroit	Kearney, N. J.	New Orleans	St. Louis	

## FOREIGN BRANCHES AND SERVICE STATIONS

Bordeaux, France	Copenhagen, Denmark	Montevideo, Uruguay	St. John, N. B.
Buenos Aires, Argentina	London, Eng.	Montreal, Que.	Toronto, Ont.
Cadiz, Spain	London, Ontario	Regina, Sask.	Vancouver, B. C.
Calgary, Alta.	Manchester, Eng.	San Paulo, Brazil	Winnipeg, Manitoba

Foreign Department—1710 Broadway, New York  
There are Ford Agents in all Principal Cities

## IMPORTANT

INSIST on getting GENUINE Ford Parts when your Ford car needs repairing. Don't allow "bogus" or imitation Parts to go in your car.

## Instructions for Ordering Parts

- 1—Order all parts through the nearest Branch or Dealer.
- 2—Always give **Catalog Number** and **Name** of each part ordered.
- 3—Mail and Parcel Post orders must be accompanied by an amount sufficient to cover **Postage**.
- 4—All prices are net f. o. b. Branch, Factory or Dealer.
- 5—Specify how shipments are to be made.
- 6—Orders for parts should be written separately from correspondence pertaining to other matters.

## Telegraph Code

To save expense, to expedite ordering and for your convenience, we have arranged a code word for each part of the Ford Model T car. In addition, we list below a brief General Code covering miscellaneous instructions, questions and answers relative to the shipment of parts.

**Toperig**—Ship to me (us) by express.

**Toperkleur**—Ship by express to \_\_\_\_\_

**Topersteen**—Ship to me (us) by freight.

**Toper**—Ship to me (us) by parcel post.

**Topfton**—When and how did you ship parts called for in my (our) telegram of \_\_\_\_\_

**Topflutch**—When and how will you ship parts called for in my (our) telegram of \_\_\_\_\_

**Topfwasser**—When and how will you ship parts called for in my (our) letter of \_\_\_\_\_

# PRICE LIST OF PARTS

FORD MODEL T 1909-1921

EFFECTIVE JULY 1st, 1921

## Parts Price List Index

	Page
Ammeter .....	31
Axle—Front .....	7
Axle—Rear .....	5
Battery Bracket and Parts .....	32
Bendix Drive .....	31
Body Parts .....	23
Carburetor .....	27
Carburetor Attachments .....	27
Coil and Parts—Spark .....	31
Commutator .....	16
Cotter Pins .....	33
Cut-outs .....	31
Fan .....	26
Fenders .....	27
Frame .....	9
Gasoline Tank .....	12
Generator and Parts .....	32
Hood .....	26
Horn .....	34
Lamps .....	34
Magneto .....	16
Motor .....	12-13
Muffler .....	26
Radiator—Thermo Syphon .....	24
Running Board and Shields .....	30
Springs .....	23
Starter Parts .....	31-32
Starting Crank .....	24
Steering Gear .....	21
Switch .....	31
Tools .....	33
Tops .....	36
Transmission .....	16
Transmission Control .....	19
Transmission Cover .....	17
Truck Parts .....	38-40
Wheels .....	9
Windshields .....	34
Wiring .....	31

Part No.	Name of Part	Year	Specifications	Price	Tax Status	Code Word	Fac. No.	No. Req. per Car
<b>REAR AXLE</b>								
2500	Rear axle assembly	1909-21	.56-inch tread	\$80 00	MH	Aband	95E	1
2501	Axle housing—right	1915-21		10 00	MH	Absolve	7635C	1
2502	Axle housing—left	1915-21		10 00	MH	Absume	7636C	1
2503E	Axle housing bolt	1913-21	$\frac{3}{8}$ " x $1\frac{1}{4}$ "	03		Ajoy	2854	7
2503F	Axle housing bolt nut	1909-21	Used on 2503E	02		Doric	44	7
2504	Rear axle case gasket	1919-21		03		Abraun	139	1
2505	Axle shaft—tapered	1912-21	$1\frac{1}{8}$ " x $31\frac{1}{8}$ "	2 50	MH	Abode	2818	2
2506	Axle shaft washer	1909-21	$1\frac{1}{8}$ " dia. fibre	03		Abound	39	1
2508	Axle shaft roller bearing	1909-21	$2\frac{1}{4}$ " x 4"	1 25		Abraise	253	4
2509	Axle shaft roller bearing sleeve—right	1909-21	.4" long	30		Abray	170	2
2509B	Axle shaft roller bearing sleeve—left	1909-21		30		Abate	161	2
2510	Axle housing cap	1909-19	$2\frac{1}{4}$ " dia.	05		Abroad	56	2
2510A	Axle housing cap	1919-21		05		Abridge	56B	2
2510A	Axle outer roller bearing steel washer	1909-21	$2\frac{1}{4}$ " dia.	03		Absinthe	199	2
2510B	Axle outer roller bearing felt washer	1909-21	$2\frac{1}{4}$ " dia.	05		Absist	54	2
2512C	Diff. case—left (no bushing used)	1914-21		1 75	MH	Abut	84	1
2513C	Diff. case—right (no bushing used)	1914-21		1 10	MH	Ache	81	1
2514	Diff. case stud	1909-15	$\frac{3}{8}$ " x $2\frac{3}{4}$ "	05		Arcadian	52	3
2514B	Diff. case stud	1915-21	$\frac{3}{8}$ " x $2\frac{3}{4}$ "	05		Ale	2865	3
2515	Diff. case stud nut	1909-21	Used on 2514-2514B	03		Egret	8	3
2518	Diff. drive gear	1909-21	40 teeth	4 00	MH	Accost	12B	1
2519	Diff. drive gear screw	1909-21	$\frac{1}{8}$ " x $\frac{1}{2}$ "	05		Accoy	103	10
2519A	Diff. gear lock ring	1909-21		03		Acetic	118	2
2520B	Diff. gear	1909-21	24 teeth	1 50	MH	Ace	13B	2
2521B	Diff. gear key	1911-21	$1\frac{3}{8}$ " long	05		Acrid	137	2
2524C	Diff. pinion	1915-21	12 teeth	60	MH	Admire	14D	3
2526B	Diff. spider	1909-21		80	MH	Adduce	15D	1
2528	Diff. thrust washer	1909-21	$3\frac{3}{4}$ " dia. metal	20		Adieu	30	2
2529	Diff. thrust plate	1909-21	$3\frac{3}{4}$ " dia. steel	15	MH	Adjoin	31	4
2530	Diff. thrust plate pin	1909-16	$\frac{1}{2}$ " long	03		Admix	17	4
2531	Diff. thrust plate pin	1909-16	$\frac{1}{2}$ " long	03		Adgase	37	2
2531B	Diff. thrust plate pin	1917-21		03		Age	7640	6
2532	Diff. housing oil plug	1909-21	$\frac{3}{4}$ " x 24 thds.	10		Agger	817	1
2545	Rear axle grease cup	1909-21		05		Ajar	76	1
2547	Rear radius rod	1909-21		2 80		Altar	152	2
2548	Radius rod nut	1909-21	$\frac{1}{8}$ " x 18 thds.	05		Amass	77	2
2549	Radius rod lock nut	1909-21	$\frac{1}{8}$ " x 18 thds.	05		Amber	78	2
2550	Radius rod lock washer	1909-21		02		Ambrush	2823	2
2551	Radius rod bolt	1909-21	$1\frac{1}{2}$ " x $1\frac{1}{2}$ "	05		Ampite	83	4
2551B	Radius rod bolt nut	1909-21	Used on 2551	05		Armor	60	4
2557	Hub cam shaft—right	1909-21	$3\frac{1}{4}$ " long	20		Amuck	92B	1
2558	Hub cam shaft—left	1909-21	$3\frac{1}{4}$ " long	20		Anchor	61B	1
2559	Hub cam shaft bushing	1909-21	$1\frac{1}{2}$ " bore, $\frac{1}{4}$ " dia.	10		Ancient	173	2
2562	Cam shaft lever	1909-21	$1\frac{1}{2}$ " bore	15		Arab	62	2
2563	Cam shaft lever pin	1909-21	$\frac{1}{8}$ " x $\frac{1}{2}$ "	03		Arbor	7	4
2564	Lever clevis pin	1909-21	$\frac{1}{8}$ " x 1"	05		Arcade	65	4
2566	Hub brake shoe	1909-21	Cast iron	40	MH	Arctic	2814	2
2567	Brake shoe support bolt	1909-21	$1\frac{1}{2}$ " x $1\frac{1}{8}$ "	05		Argus	59	2
2568	Brake shoe support nut	1909-21	$1\frac{1}{2}$ " x 20 thds. (Used on T2567)	05		Armor	60	2
2570B	Brake shoe coil spring	1913-21	$3\frac{3}{8}$ " long	03		Asug	2862	4
2571	UNIVERSAL JOINT ASSEMBLY	1909-21		2 25		Ashore	151B	1
2572	Joint knuckle (male)	1909-21		70		Ashust	45B	1
2573	Joint knuckle (female)	1909-21		85		Askew	46B	1
2574	Joint knuckle pin	1909-21	$\frac{3}{8}$ " x $1\frac{1}{2}$ "	02		Asleep	6	1
2575	Joint ring, complete	1909-21	$3\frac{1}{8}$ " dia.	60		Astert	49B	1
2576	Joint ring rivets (per set4)	1909-21	$1\frac{1}{2}$ " x $1\frac{1}{4}$ "	05		Atche	50	4
2577	Joint housing	1909-14	$4\frac{1}{4}$ " long	1 50		Atlas	70	1
2577B	Unlv. joint housing	1914-21		1 50		Atoll	7609	1
2578	Joint housing plug	1909-21	$1\frac{1}{2}$ " x 20 thds.	15		Atom	75	2
2579	Ball joint grease cup	1909-21	$\frac{1}{4}$ " pipe thds.	05		Attic	195	1
2580	Ball cap gasket	1909-21		05		Auburn	1518	1
2581	Drive shaft housing front bushing	1909-21	(1" bore) babbitt. Old No. 2540	40		Balkish	69	1
2582	D. S. tubing	1911-21	$50\frac{1}{8}$ " long	8 00	MH	Ballad	153B	1
2583	D. S. roller bearing housing	1911-21	$3\frac{1}{4}$ " long	2 00	MH	Ballot	191B	1
2583B	D. S. bearing housing	1920-21	Forging	2 50	MH	Bailace	191C	1
2584B	D. S. roller bearing stud	1912-21	$\frac{3}{8}$ " x $4\frac{3}{8}$ "	05		Baineal	183B	6
2584C	D. S. roller bearing stud nut	1912-21	Used on 2584B	05		Feast	184	6

Of the net amount at which these parts are billed to purchasers who purchase direct from the Ford Motor Company (except parts which show no Tax Status, if any) 20/21 represents the price of the goods and 1/21 represents excise tax.

**Insist upon genuine Ford parts**

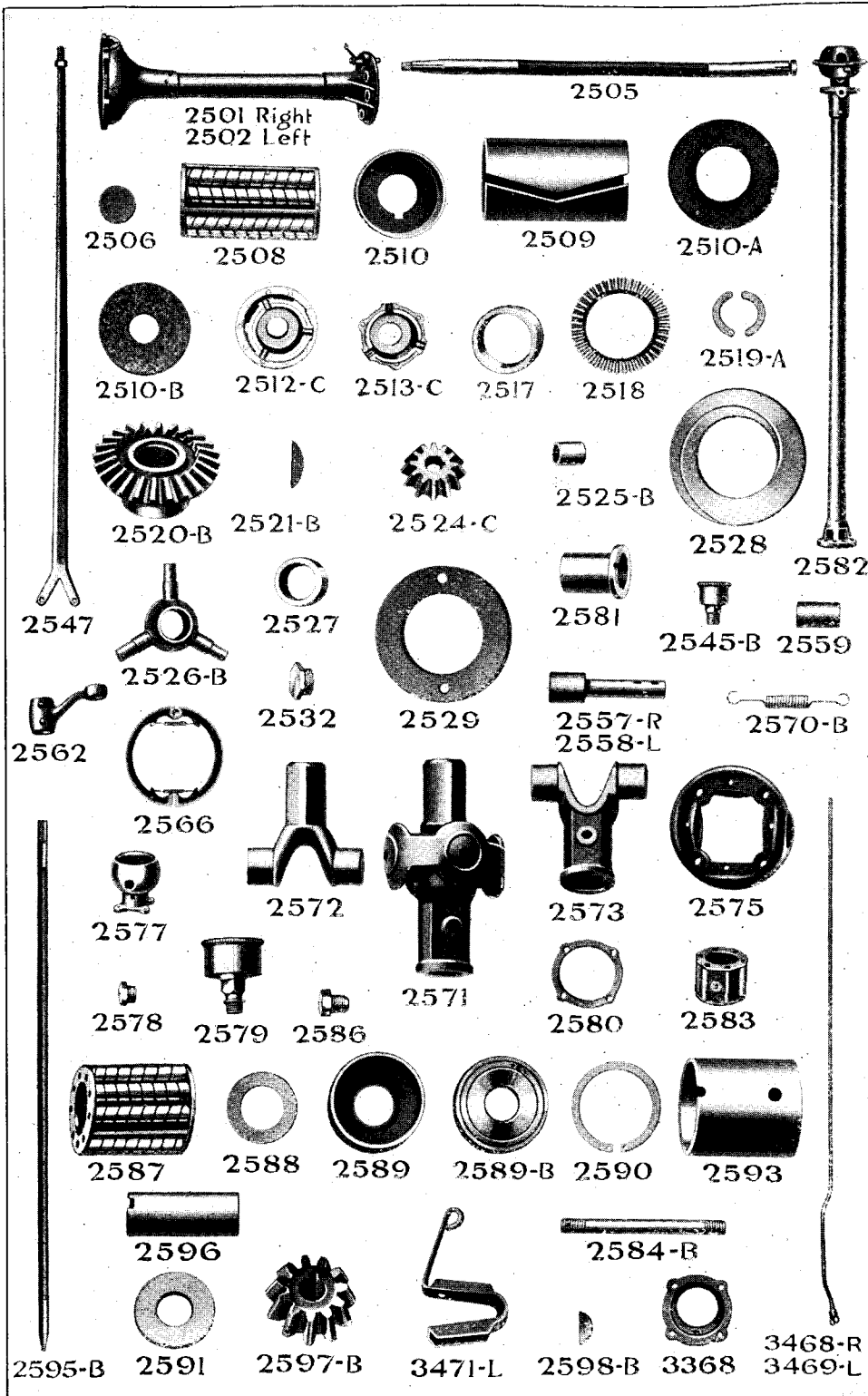

Plate No. 1

Part No.	Name of Part	Year	Specifications	Price	Tax Status	Code Word No.	Fac. No.	No. Req. per Car
<b>REAR AXLE—Continued</b>								
2586	D. S. roller bearing housing set screw	1911-21	1/2" x 20 thds	\$0 05		Banco	101	1
2587	D. S. roller bearing	1911-21	2 3/8" long	1 50		Balsam	108	1
2588	D. S. roller bearing distance plate	1911-21	2 1/4" dia.	05	MH	Bandlet	106	1
2589	D. S. ball race	1911-21	2 3/8" dia.	35		Bandon	186	1
2589B	D. S. ball bearing assembly	1911-21		1 00		Bander	185	1
2589C	D. S. thrust bearing assy	1920-21		1 00		Bane	185B	1
2590	D. S. ball retainer	1911-21	2 1/4" dia.	03		Bandroe	190	1
2591	D. S. ball thrust collar	1911-21	2 1/4" dia.	30		Bandault	188	1
2592	D. S. ball bearings, each	1911-21	Order 2811					
2593	D. S. roller bearing sleeve	1911-21	2 3/8" dia., 2 3/8" long	1 90		Bangle	107	1
2595B	D. S. only (tapered)	1911-21	1 3/8" x 53 1/16"	4 00	MH	Banjo	87D	1
2596	D. S. sleeve	1911-21	1" bore, 3 1/8" long	1 20		Banshee	163B	1
2597B	D. S. pinion	1911-21	Taper bore, 11 teeth	1 50	MH	Banewort	16C	1
2597C	D. S. pinion	1911-21	Taper bore, 10 teeth	1 50	MH	Banneret	16	1
2598	D. S. castle nut	1911-21	3/8" x 18 thds	05		Banket	124	1
2598B	D. S. pinion key	1911-21		05		Banker	57B	1
<b>REAR AXLE—60 INCH TREAD</b>								
2600C	Rear axle housing—right	1915-16	Dia. of bell 9 3/4"	12 00	MH	Bang	2728C	1
2601C	Rear axle housing—left	1915-16	Dia. of bell 9 3/4"	12 00	MH	Bard	2729C	1
2602B	Rear axle shaft—tapered	1911-16	1 1/4" x 33 1/16"	3 00	MH	Baptism	2725	2
2604	Rear radius rod	1909-16	53 3/8" tube only	4 00		Barbett	1726	2
<b>FRONT AXLE</b>								
2691	Front axle only	1909-21	56" tread	10 00	MH	Barber	202B	1
2694B	Spindle body—right	1911-21	Less cones and washer	1 60	MH	Barbian	280	1
2695B	Spindle body—left	1911-21	Less cones and washer	1 60	MH	Barbiton	281	1
2696	Spindle arm—right or left	1911-19		60	MH	Bardism	7716	2
2696B	Spindle arm—right	1911-15	With hole for speedometer support	75	MH	Bardo	7715A	1
2696C	Spindle arm—right	1919-21		60	MH	Barm	7715B	1
2696D	Spindle arm—left	1919-21		60	MH	Barry	7716B	1
2697	Spindle arm nut	1911-21	Order 2548					
2702	Spindle assembly—right	1909-10		5 00	MH	Barkate	203A	1
2703	Spindle assembly—left	1909-10		5 00	MH	Barker	204A	1
2704	Stationary cone	1909-21	1 1/16" bore	20		Barkless	205	2
2705	Adjusting cone—right thread	1909-21	3/4" x 16 thds., R. T.	20		Barley	206	1
2706	Adjusting cone—left thread	1909-21	3/4" x 16 thds., L. T.	20		Barrack	207	1
2707	Spindle nut—right thread	1909-21	3/4" x 16 R. H. thds.	10		Barrow	209B	1
2708	Spindle nut—left thread	1909-21	3/4" x 16 L. H. thds.	10		Baron	208B	1
2709	Spindle washer	1909-21	3/16" hole x 1 3/8"	02		Barras	210	2
2710	Spindle bolt with oiler	1910-21	1/2" x 6 3/4"	25		Barter	7708	2
2711	Spindle bolt nut	1909-21	Order 2568					
2713	Spindle body bush, pair	1909-21	1/2" bore	30		Bartram	223	2
2714	Spindle arm bushing	1909-21	1 1/8" bore, 1 1/8" dia., 1" L.	05		Barwood	225	2
2715	Spindle oiler	1909-21	Order 3817					
2715B	Spindle bolt oiler assy.	1915-16		05		Bead	4081	2
2715C	Spindle oiler	1917-18		05		Bilge	2944	2
2715D	Spindle oiler	1919-21	Order 3176C					
2717	Spindle con. rod	1909-21	46 3/4" long	2 50	MH	Basalt	264	1
2718	Spindle con. rod bolt with oiler	1909-21	1 1/8" x 2 1/4"	20		Basan	7706	2
2719	Spindle con. rod bolt nut	1909-21	1 1/8" x 20 thds	03		Bashful	220	2
2721	Spindle con. rod yoke	1909-18	2 3/4" long	40		Hashule	248	1
2721B	Spindle con. rod yoke ball	1919-21		25		Baroko	226	1
*2721C	Spindle con. rod yoke	1919-21		50		Barse	248B	1
2722	Steering yoke clamp bolt	1909-18		05		Era	79	
2722B	Steering yoke clamp bolt nut	1909-18	Used on 2722	03		Egret	8	
2725B	Steering gear con. rod	1909-21	Includes ball sockets	1 00	MH	Baslard	289	1
2728	Ball socket cap	1909-21		15		Basent	254B	2
2729B	Ball socket bolt and nut	1909-21	Order 2722 & 2722B					
2733	Front radius rod	1909-19		2 75	MH	Beardless	263	1
2733B	Front radius rod	1919-21		2 75	MH	Bedazzle	263B	1
2734	Front radius rod nut	1909-21	Order 2548					
2736	Front radius rod ball cap	1909-21		15		Beaufet	217	1
2737	Front radius rod ball socket	1911-21		25		Beckon	809B	1
2741	Radius rod ball cap stud	1911-21		03		Plateau	4365	2
2741B	Radius rod ball cap stud nut	1911-21	Used on 2741	03		Egret	8	2
2742	Radius rod ball cap sprg	1911-21		03		Bicep	292	2
2760	FRONT AXLE ONLY	1911-16	60" tread	14 00	MH	Bechance	1720	1
2761	Steering spindle con. rod	1909-16	60" tread	3 00	MH	Becket	1725	1
2762	Steering gear con. rod	1909-16	60" tread, includes ball sockets	1 25	MH	Becloud	2739	1

\*When substituting 2721C for old style yoke, also order 2721B Ball.

Of the net amount at which these parts are billed to purchasers who purchase direct from the Ford Motor Company (except parts which show no Tax Status, if any) 20/21 represents the price of the goods and 1/21 represents excise tax.

**Insist upon genuine Ford parts**

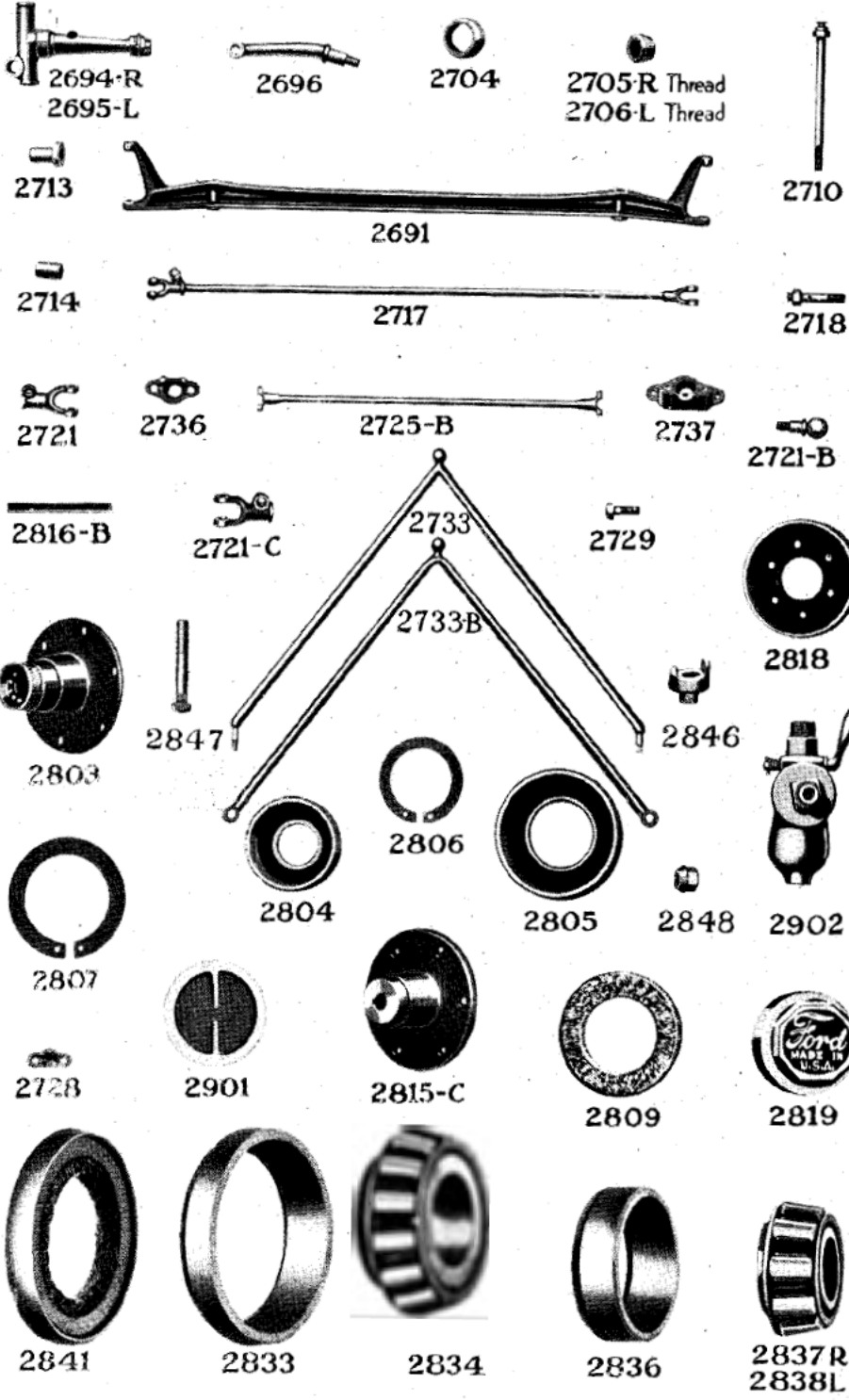

Part No.	Name of Part	Year	Specifications	Price	Tax Status	Code Word	Fac. No.	No. Req. per Car
2694-R	2695-L	2696	2704	2705-R Thread	2706-L Thread			
2710	2714	2717	2718	2721-B	2725-B	2729	2733	2733B
2736	2737	2816-B	2818	2819	2825	2825B	2827	2828
2833	2834	2836	2837R	2838L	2841	2843	2844	2846
2847	2848	2849	2850	2851B	2852B	2853	2854B	2855
2856	2857	2858	2859	2860	2863	2880	2881	2882
2883	2884	2885	2886	2887	2888	2889	2890	2891
2892	2893	2894	2895	2896	2897	2898	2899	2900
2901	2902	2903	2904	2905	2906	2907	2908	2909
2910	2911	2912	2913	2914	2915	2916	2917	2918
2919	2920	2921	2922	2923	2924	2925	2926	2927
2928	2929	2930	2931	2932	2933	2934	2935	2936
2937	2938	2939	2940	2941	2942	2943	2944	2945
2946	2947	2948	2949	2950	2951	2952	2953	2954
2955	2956	2957	2958	2959	2960	2961	2962	2963
2964	2965	2966	2967	2968	2969	2970	2971	2972
2973	2974	2975	2976	2977	2978	2979	2980	2981
2982	2983	2984	2985	2986	2987	2988	2989	2990
2991	2992	2993	2994	2995	2996	2997	2998	2999
3000								

Of the net amount at which these parts are billed to purchasers who purchase direct from the Ford Motor Company (except parts which show no Tax Status, if any) 20/21 represents the price of the goods and 1/21 represents excise tax.

Insist upon genuine Ford parts

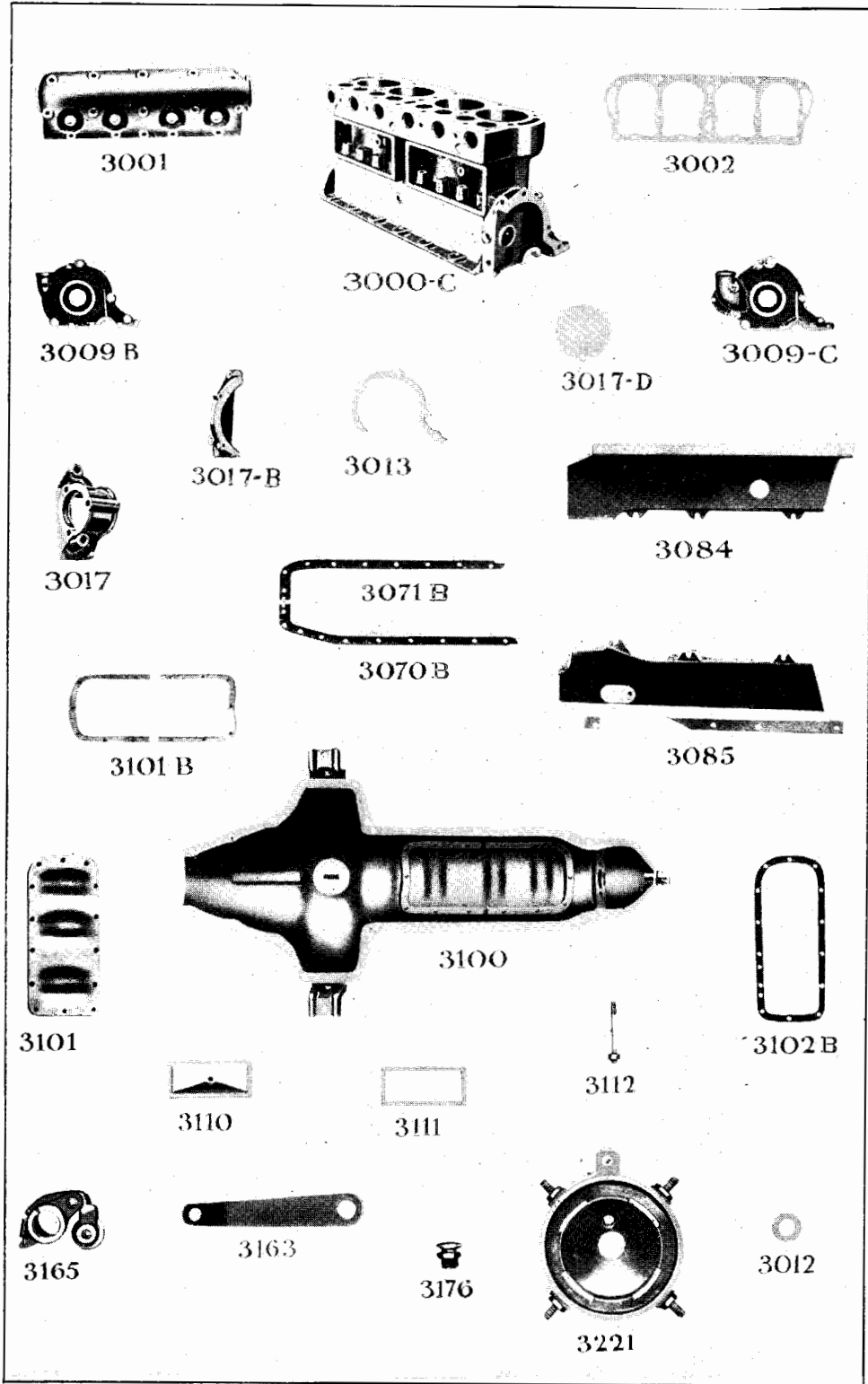

Plate No. 3

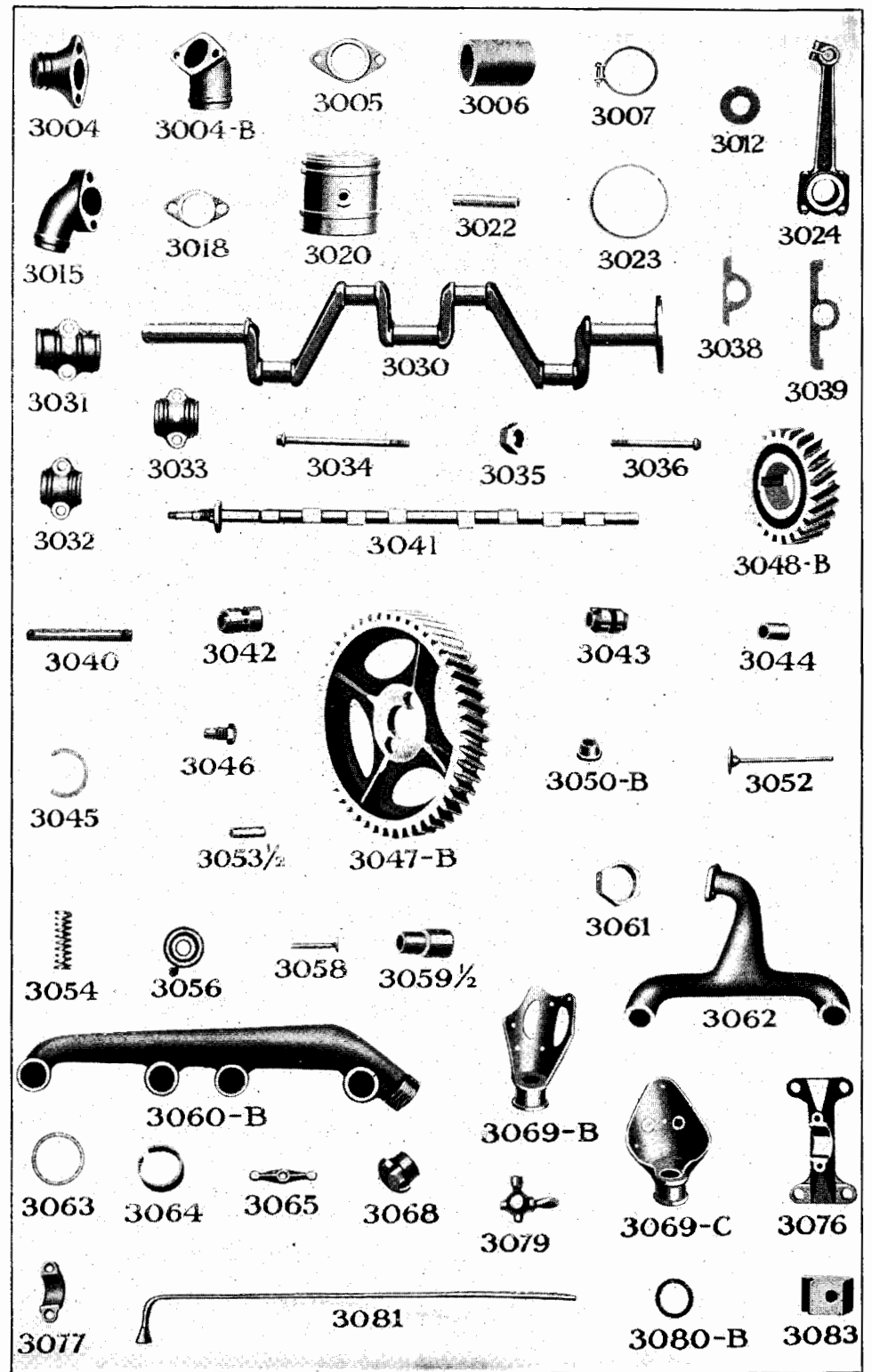

Plate No. 4

Table with columns: Part No., Name of Part, Year, Specifications, Price, Tax Status, Word No., Code Fac. No., Req. per Car. Includes sections for GASOLINE TANK and MOTOR.

xWhen used on car not equipped with starter also order 3017B, 3017C, 3011, 3008 and 3016.
†Used with 3000C cylinder on cars not equipped with starter.
\*Connecting rods requiring new bearings will be exchanged at Branch or Factory for \$1.00 each.

Of the net amount at which these parts are billed to purchasers who purchase direct from the Ford Motor Company (except parts which show no Tax Status, if any) 20/21 represents the price of the goods and 1/21 represents excise tax.

Insist upon genuine Ford parts

Table with columns: Part No., Name of Part, Year, Specifications, Price, Tax Status, Word No., Code Fac. No., Req. per Car. Includes section for MOTOR—Continued.

\*When used to replace spur type gear also order 3048B.
†When used to replace spur type gear also order 3047B.

Of the net amount at which these parts are billed to purchasers who purchase direct from the Ford Motor Company (except parts which show no Tax Status, if any) 20/21 represents the price of the goods and 1/21 represents excise tax.

Insist upon genuine Ford parts



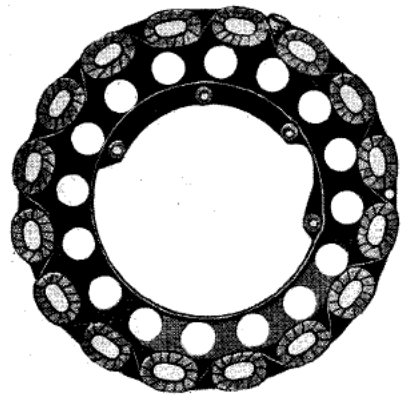

3250-D



3254

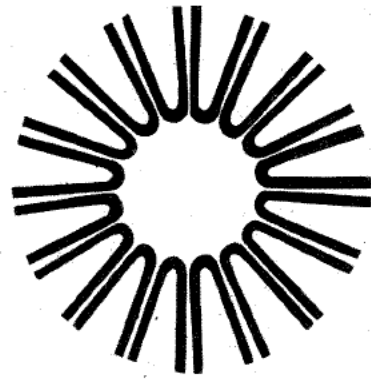

3276-B



3260



3257



3270



3278



3255-B



3272

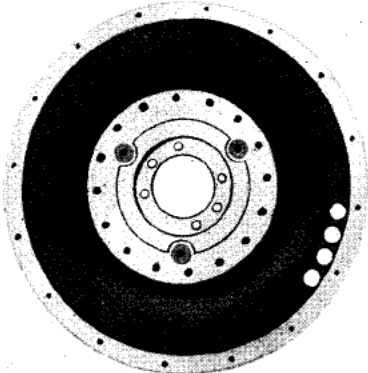

3269-C



3279



3269-E



3277



3277-B

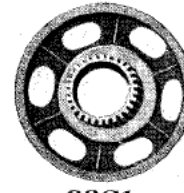

3301



3304



3309

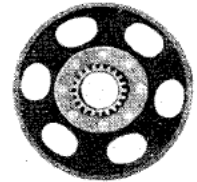

3306

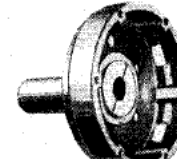

3311



3314



3314 1/2



3320-B



3313



3315



3317



3320-C

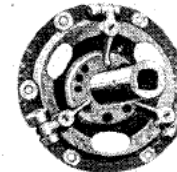

3321

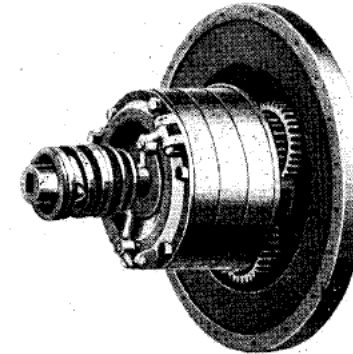

3300



3328



3327-B



3329

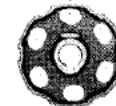

3332



3356



3330



3331

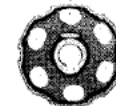

3332



3356



3337



3338



3340



3334



3341

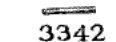

3342



3344



3341



3368

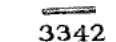

3342



3344



3341



3369

Part No.	Name of Part	Year	Specifications	Price	Tax Status	Code Word	Fac. No.	No. per Car	Req.
<b>MOTOR—Continued</b>									
3088D	Engine pan and hood board bolt	1918-21	Truck—Old No. 1128	\$ 0	03	Shamble	TT4073	2	
3088E	Engine pan and hood board bolt nut	1909-21	Used on 3088B-C and D	02		Missive	1309		
3100	CRANK CASE WITH LOWER COVER	1912-21		13	00	MH	Closet	1526E	1
3101	Crank case lower cover	1912-21	6 3/4" x 15 1/2"	50		MH	Closure	1582	1
3101B	Crank case lower cover reinforcement	1912-21		30			Clothes	4378-4379	1
3102B	Cr. c. lower cover gasket	1912-21	Cork	10			Clotting	1586	1
3103	Crank case lower cover screw	1912-21	3/8" x 1 1/8"	03			Cloudlet	4328	14
3110	Cylinder valve cover	1912-21	3 3/4" x 8"	15		MH	Clovene	656	2
3111B	Cyl. valve cover gasket	1912-21	Cork	05			Cloven	660	2
3112	Cyl. valve cover screw	1912-21	3/8" x 2 3/8"	03			Compone	654	2
3114	Crank case arm with rivets	1909-21		35			Cloth	815	2

COMMUTATOR

3162	Com. case support bolt	1912-19	3/8" x 2 1/4" x 24 thds	05		Connote	4441	1	
3162B	Com. case support bolt	1919-21	Starter type	05		Constrict	1756	1	
3163	Com. case spring	1912-21	3 1/4" C. to C.	05		Conoid	689	1	
3165	Com. brush only	1912-21		35		Conquest	4481	1	
3176	Com. oiler	1912-16	1/8" pipe thds	05		Coomb	2383	1	
3176B	Com. oiler	1917-18		05		Coot	480	1	
3176C	Com. oiler	1919-21		05		Cooke	480B	1	
3177	Com. felt ring	1912-21	Felt	03		Coombox	5930	1	
3206	Com. brush cap	1909-21	7/8" dia.	02		Convert	468	1	
3207	Com. brush cap pin	1909-21	1/2" x 3/8"	01		Convict	466	1	
3210	Com. contact point nut	1910-21	1/4" hex.	02		Cooper	472B	8	
3220	Com. lock nut	1909-21	1/8" x 18 thds	05		Crater	471	1	
3221	Com. case with fibre assembled	1912-21		70		Crato	5908	1	
3222	Com. shield	1912-21		02		Crash	5923	1	

MAGNETO

3250D	Magneto coil assembly	1915-21	Used with 3/4" magnets	6	00	Craft	5941B	1	
3252	Magneto spool support screw	1909-21	Order 3371	03		Corbell	537B	16	
3254	Magnet bolt	1909-21	3/8" x 1 1/2"	01		Corrupt	624	16	
3255B	Magnet bolt washer	1911-21	3/8" hole, 3/8" dia.	05		Cordial	535C	16	
3257	Magnet brass support	1909-21	3/8" x 3/4" brass	25		MH	Cornus	1545	1
3260	Magneto con. assembly	1909-21	On trans. cover	01			Cornute	1508	2
3261B	Magneto contact nut	1909-21		01			Cornel	1565	
3261C	Magneto contact screw washer	1909-21		05			Cornise	1509	1
3262	Magneto contact spring	1909-21	Coil spring	10			Corsage	4350	
3262B	Magneto contact screw and spring assb.	1919-21		10			Cortile	1505B	3
3266	Magneto contact fibre screw	1909-21	1/2" long	01			Crumple	4382	
3267	Magneto primary insulating block	1915-21		05			Crush	1503B	
3267B	Magneto contact insulator	1919-21		10			Crutch	8611	
3267C	Magneto contact insulator shell	1919-21		03			Cousin	1885	1
3268	Fly wheel ring gear	1919-21	For starter	2	00	MH	Cosmic	701B	1
3269C	Fly wheel	1911-19		6	00	MH	Cozy	701C	1
3269G	Fly wheel only	1919-21	Starter type	6	00	MH			
3269H	Fly wheel with ring gear and magnets assmbld	1919-21	Starter type	16	00	MH	Cranch	5946B	1
3270	Fly wheel cap screw	1909-21	1/2" x 1 1/2"	10			Cossack	721	4
3271	Fly wheel dowel pin	1909-21	3/8" x 1 1/2"	05			Costard	722	2
3272	Magneto coil support shim	1909-21	Sheet steel	05			Costrel	584	1
3276B	Magnet (16) per set	1915-21	3/4" steel set	6	00		Court	5933	16
3277	Magnet clamp	1911-21		03			Cotland	623	16
3277B	Magnet clamp	1913-14		10			Cotta	4499	16
3278	Magnet clamp screw	1911-21	2 3/8" x 24 thds. brass	03			Cottage	625	16
3279	Magneto-contact washer	1909-21	On trans. cover cork	03			Cough	560	1

TRANSMISSION

3300B	Transmission assembly	1919-21	Starter type. Does not include gear or magnets	38	00	MH	Daciam	744C	
3301	Trans. reverse plate assembly	1909-21		3	20	MH	Dacolt	747	1
3304	Trans. reverse gear bushing	1909-21	2 3/8" rear	70			Daddy	705	1

Of the net amount at which these parts are billed to purchasers who purchase direct from the Ford Motor Company (except parts which show no Tax Status, if any) 20/21 represents the price of the goods and 1/21 represents excise tax.

Insist upon genuine Ford parts

Part No.	Name of Part	Year	Specifications	Price	Tax Status	Code Word	Fac. No.	No. per Car	Req.
<b>TRANSMISSION—Continued</b>									
3305	Trans. reverse and S. S. rivet	1909-21	1 1/8" x 1 1/8"	\$ 0	05	Dado	708	8	
3306	TRANS. SLOW SPEED PLATE ASSEMBLY	1909-21		3	00	MH	Dagger	748	1
3309	Trans. slow speed gear bushing	1909-21	1 3/8" ream	60			Dairy	745	1
3310	Trans. brake drum rivet	1909-21	1/2" x 1 1/8"	05			Daisy	711	8
3311	TRANS. BRAKE DRUM ASSEMBLY	1909-21		3	50	MH	Dakir	750	1
3313	TRANS. TRIPLE GEAR ASSEMBLY	1909-21		2	40	MH	Dallop	751B	3
3314 1/2	Trans. triple gear flanged bushing	1911-21	1 1/8" dia. x 1 1/8"	30			Dalriad	716B	3
3315	Trans. triple gear shaft	1909-21	1 1/8" dia. x 2 1/2"	20			Dalrotz	715	3
3316	Trans. triple gear riveting pin	1909-21	3/8" x 1 3/8"	05			Damar	720	24
3317	Trans. driven gear	1909-21	27 teeth	1	00	MH	Damask	713	1
3318	Trans. driven gear key	1909-21		03			Dampen	714	2
3320C	Trans. driven gear sleeve bushing	1909-21	1 1/2" long	30			Dark	712	2
3320D	Driven gear sleeve washer	1909-21		03			Darken	776	3
3321	TRANS. DRIVING PLATE ASSEMBLY	1909-21		4	00	MH	Dannock	749	1
3323	Trans. driving platescrew	1909-21	Order 3371						
3325	Trans. driving plate rivet	1909-21	1/8" x 5/8"	05			Darner	736	8
*3327B	Trans. driving plate bushing	1909-21	1 1/8" x 1 1/4"	25			Darsis	772	1
3328	Trans. thrust plate—small	1909-21	.6" dia.	15		MH	Dauphin	727	12
3329	Trans. thrust plate—large	1909-21	.6 1/4" dia.	15		MH	Davine	728	13
3331	Trans. gear shaft	1909-21	1" dia. x 7 1/2" over all	2	00	MH	Decurt	723B	1
3332	Trans. clutch disc drum	1909-21	4 1/8" dia.	2	00	MH	Deeply	725B	1
3333	Trans. clutch disc drum key	1909-21		05			Defalk	726B	1
3334	Trans. clutch disc drum set screw	1909-21	3/8" x 3/4"	05			Defeat	752	1
3336	Trans. clutch push ring	1909-21	6 1/8" O. D.	50		MH	Defile	770	1
3337	Trans. clutch finger	1909-21		20			Define	732	3
3337 1/2	Trans. clutch fingerscrew	1909-21	3/8" x 3/4" x 24 thds	05			Defour	756	3
3337B	Trans. clutch finger and screw	1909-21		25			Defix	765	3
3338	Trans. clutch finger pin	1909-21	1 1/8" x 1 5/8"	02			Deform	735	3
3340	Trans. clutch spring	1909-21	2 3/8" dia. x 2 3/4" long	35			Defoue	737	1
3341	Trans. clutch spring support	1909-21		15		MH	Delator	738	1
3342	Trans. clutch spring thrust ring pin	1909-21	5/8" x 2 3/8"	05			Delete	739	1
3344	Trans. clutch shift	1909-21		75		MH	Delight	733	1

TRANSMISSION COVER

3362	Trans. cover bolt and nut	1909-21	3/8" x 1 1/8". Order 2722 & 2722B						
3363	Trans. cover gasket (front)	1909-21	3/8" x 1 1/2" x 15 1/2" felt	05			Defy	872B	1
3363B	Trans. cover gasket—short	1909-21	3/8" x 1 1/2" x 13" felt	03			Defiant	4358	1
3367	Trans. cover door screw	1909-21	3/8" x 1 1/2"	02			Demain	430	6
3368	Universal ball cap (rear)	1909-21	5/8"	30		MH	Demarch	818	1
3369	Universal ball cap (front)	1909-21	Bearing included	1	00	MH	Demarga	819D	1
3371	Universal ball cap screw	1909-21	3/8" x 1 1/8"	05			Demise	731	2
3372	Universal ball cap bolt and nut	1909-21	Order 2722 & 2722B						
3375	Trans. cover screw	1909-21	Order 3072						
*3376B	TRANS. COVER	1919-21	Starter type	7	50	MH	Den	826E	1
3377B	Trans. cover gasket (pair)	1909-21	Cork	15			Dennet	885B	1
3378	Trans. cover sloping door	1911-21	9 3/8" long	15		MH	Dental	1546D	1
3379B	Trans. cover sloping door gasket	1911-21	Cork	05			Denude	1547C	1
3380	Bendix cover	1919-21		35		MH	Tendon	1763	1
3381	Bendix cover gasket	1919-21		03			Thigh	1764	1
3382	Trans. cover rear plate	1919-21		10		MH	Deputy	1761	1
3383	Trans. cover front plate	1919-21		15		MH	Descry	1758	1

\*When using short bushing in making repairs remove driving plate key.

†When ordered to replace cover on cars below 2044100 also order 3402D clutch lever and shaft.

Of the net amount at which these parts are billed to purchasers who purchase direct from the Ford Motor Company (except parts which show no Tax Status, if any) 20/21 represents the price of the goods and 1/21 represents excise tax.

Insist upon genuine Ford parts



Part No.	Name of Part	Year	Specifications	Price	Tax Status	Code Word	Fac. No.	No. per Car	Req.
----------	--------------	------	----------------	-------	------------	-----------	----------	-------------	------

TRANSMISSION CONTROL—Continued

3471	Hub brake rod support—left	1909-21		\$ 0 10		Drugg	1398	1	
3472	Hub brake rod support bolt	1909-21	1/4" x 1 1/8"		03	Methol	1308	2	
3472B	Hub brake rod support bolt nut	1909-21	Used on 3472		02	Missive	1309	2	

STEERING GEAR

3500C	Steering gear assembly	1911-21	.51" long	12 00	MH	Estopped	5042	1	
3501C	Steering gear rim	1920-21	16"	1 20		Estuary	901C	1	
3502	Steering gear rim screw	1909-21	No. 12, 3/4"	02		Eblis	6849	4	
3503D	Steering gear spider	1920-21	16"	80		Etager	902C	1	
3503E	Steering gear spider and rim	1909-21	16"	2 00	MH	Euloglc	995A2	1	
3504	Steering gear cover	1909-21	2 1/4" x 18 thds	35		Ecbol	5039	1	
3505	Steering gear cover screw	1909-21	No. 6, 32 x 3/8"	02		Eccope	910	1	
3506	Steering gear cover bushing	1909-21	1" long, steel	15		Echo	914	1	
3506B	Steering gear driving pinion washer	1909-21	Steel	02		Elf	5026	1	
3507	Steering gear internal gear case and bushing	1909-21		1 50		Egg	5036	1	
3509	Steering gear quadrant	1909-21		15		Ectype	906B	1	
3510	Steering gear quadrant rivet	1909-21	3/8" x 1 1/4"	01		Eden	5041	2	
3511	Steering gear wheel nut	1909-21	3/8" x 16 thds	15		Edict	913	1	
3512C	Steering gear tubing assembly	1912-21	Applies to No. 3500C	6 00		Ethicer	5016	1	
3513B	Steering tubing flange screw	1913-16	1/8" x 1 1/8"	03		Ethule	5019	1	
3513C	Steering tubing flange screw	1913-21	1/8" x 1 1/8"	03		Platter	5018	3	
3514	Steering tubing flange screw nut	1913-21	Used on 3513B and C	02		Harrow	926		
3516C	Steering gear post	1912-21	Applies to No. 3500C	2 50		Estricked	5043	1	
3517	Steering gear pinions, each	1909-21	12 teeth	15		Egad	916	3	
3518	Steering gear pinion pin	1909-21	3/8" x 1 1/8"	03		Egest	917	3	
3519	Steering gear drive pinion	1909-21	12 teeth	30		Egger	911	1	
3520	Steering gear drive pinion key	1909-21	1/8" sq. x 3 1/2"	03		Egma	909	1	
3521	Steering gear pinion shaft bushing	1909-14	7/8" bore x 1 1/2"	30		Egress	912	1	
3523	Steering gear post castle nut	1909-21	Order 2568			Euter	5038	1	
3524E	Throttle rod	1912-21	47 1/4" Applies to 3500C	40		Evans	5037	1	
3525E	Lead rod	1912-21	51 1/8" Applies to 3500C	40		Elite	935	2	
3527	Lead and throttle rod spring	1909-21		03		Elope	936	2	
3528	Lead and throttle rod collar	1909-21	1/8" bore x 1 1/8"	02		Elvan	937	5	
3529	Lead and throttle rod pin	1909-21	3/8" x 1 1/8"	01		Embank	946	1	
3530	Lead rod lever	1909-21		15		Ember	947	1	
3531	Throttle rod lever	1909-21		05		Emblem	938	1	
3532	Throttle rod guide	1909-21	3/4" bore	10		Embrace	2082	1	
3534B	Commutator pull rod	1912-21		10		Emboss	1329	1	
3535	Carburetor pull rod	1909-21	14 1/8" long	10		Embraid	1326	1	
3536	Ball and socket joint	1909-21		02		Embrute	1327	1	
3537	Ball and socket joint nut	1909-21	3/4" x 32 thds			Eupon	996	1	
3539B	Steering post bracket with bushing	1911-21	Touring	90		Dream	TT996	1	
3539C	Steering post bracket with bushing	1918-21	Truck—Old No. 1105	90		Envault	944-5027	1	
3540	Steering post bracket bolt and nut—long	1909-21	Order 3073 & 3074B			Empact	945	1	
3541	Steering post bracket bolt and nut—short	1911-21	Order 3074 and 3074B			Drift	TT945	1	
3544	Steering post bracket felt washer	1909-21		03		Epharch	929B	1	
3545	Steering post bracket bushing	1909-21	3/4" bore, brass, 2 pieces	20		Ephod	930	1	
3546	Steer. post bracket block	1909-21	Wood	10		Drum	TT5044	1	
3546B	Steer. post bracket block	1918-21	Truck—Old No. 1106	05					
3547	Steering gear ball arm	1909-21		50					
3548	Steering gear ball arm key	1909-21		05					
3549	Steering gear bracket dust cap	1918-21	Truck—Old No. 1107	05					

Of the net amount at which these parts are billed to purchasers who purchase direct from the Ford Motor Company (except parts which show no Tax Status, if any) 20/21 represents the price of the goods and 1/21 represents excise tax.

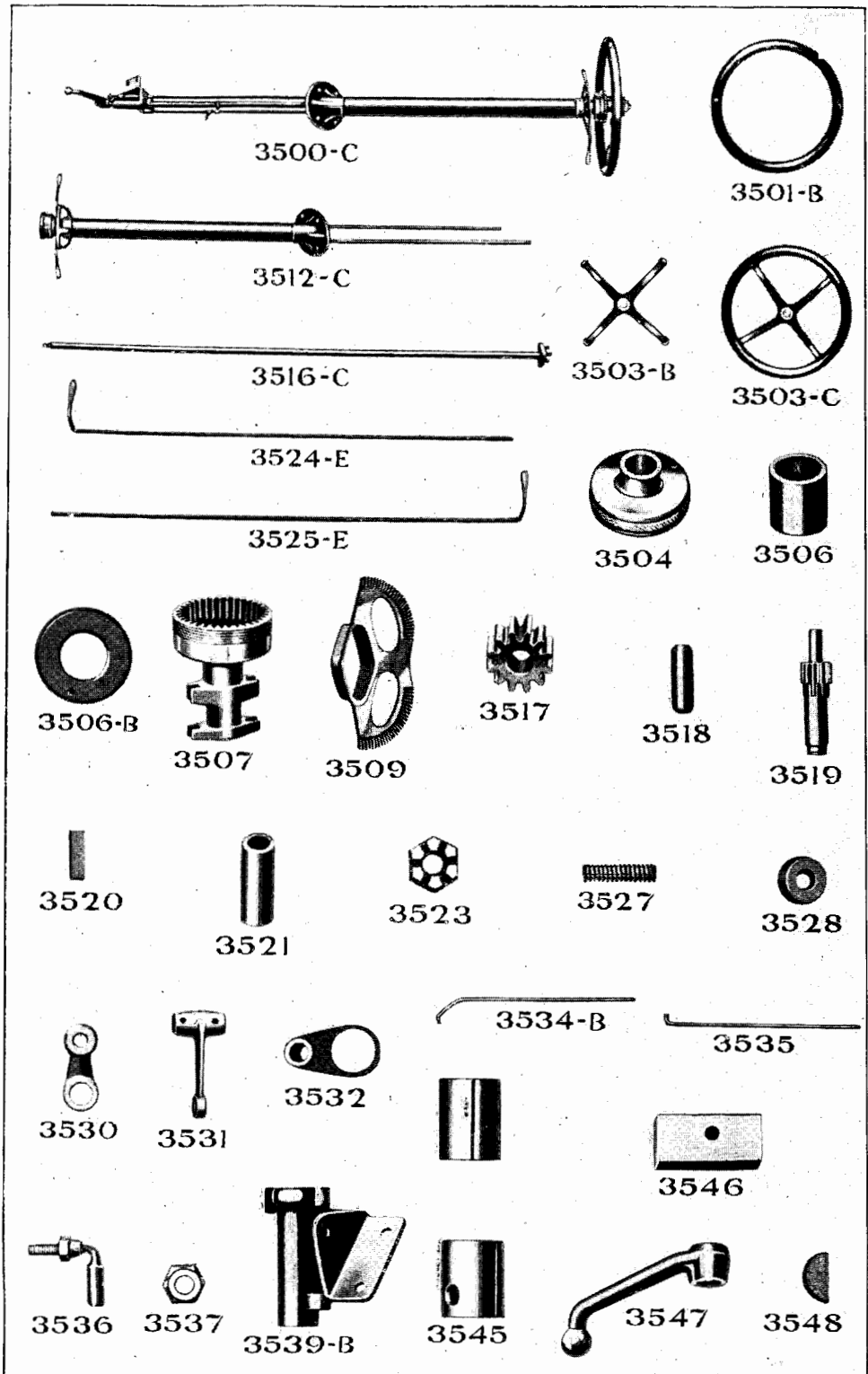

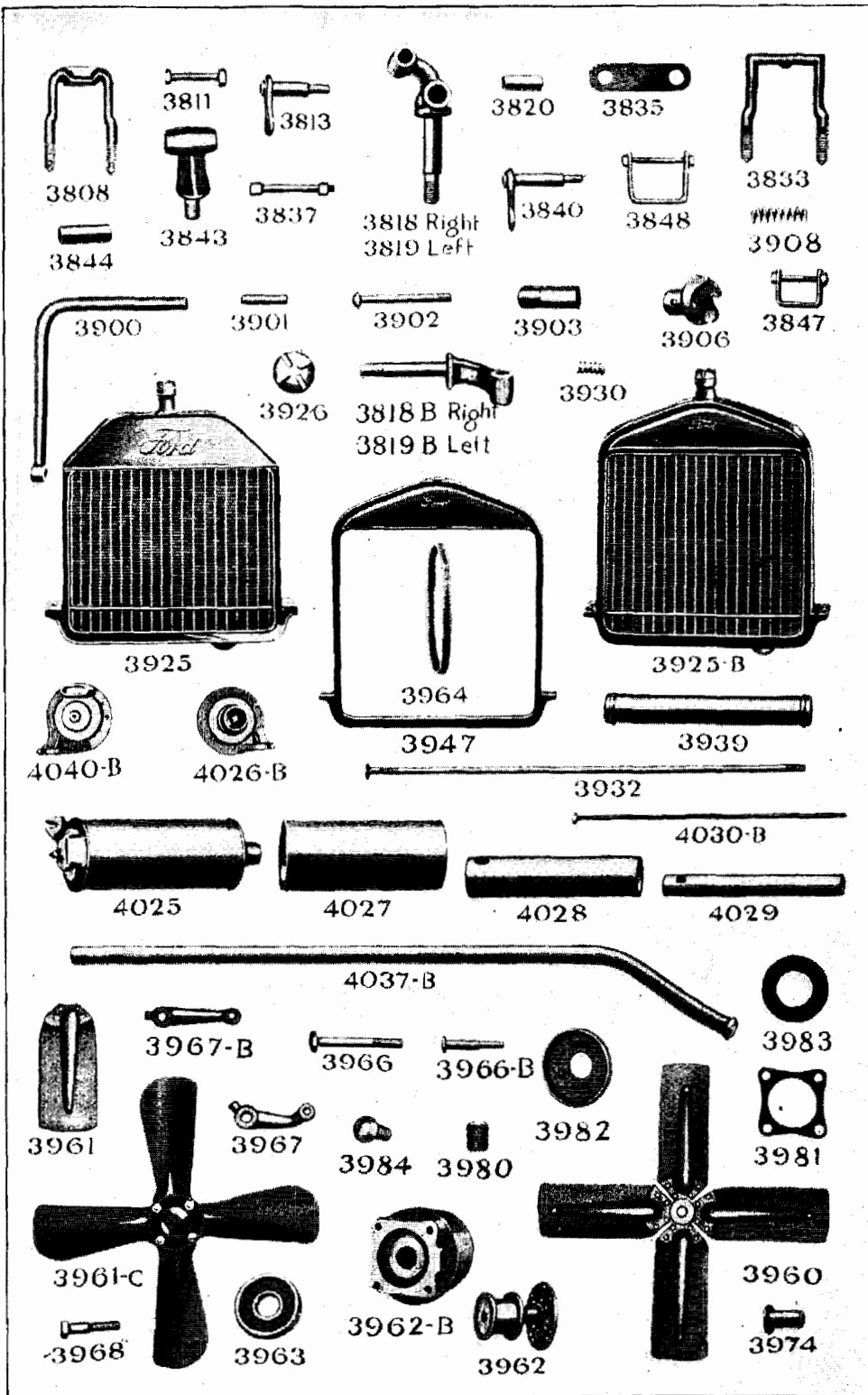

Plate No. 9

Part No.	Name of Part	Year	Specifications	Price	Tax Status	Code Word	Fac. No.	No. per Car	Req
<b>BODY PARTS</b>									
3601B	Body bracket on body	1910-21	Center and rear	\$ 0 10		Fabric	1624	6	
3602D	Body bracket con. bolt			03		Poach	5653	6	
3602E	Body bracket con. bolt	1916-21		03		Pilgrim	2431	6	
3602F	Body bracket con. bolt nut	1916-21	Used on 3602D and E	03		Bashful	220		
3624E	Front floor rubber mat	1915-21	28 1/4 x 29 1/4 Tr. & Rbt	2 00		Faith	7299	1	
3626B	Floor board (first)	1915-21	Tour. R'nab't & Coupelet	60		Farm	7296	1	
3626C	Floor board with plate (first)	1915-21		70		Farrago	4200		
3627B	Floor board (second)	1915-21	Tour. Runab't & Coupelet	60		Faro	7297	1	
3627C	Floor board with plate (second)	1915-21		70		Fascia	4201		
3628	Floor board (third)	1915-21	Specify size	70		Fasces	1404B	1	
3628B	Floor board with plate (third)	1915-21		80		Fascine	7104		
3630	Floor board forward plate for pedals	1909-21	2 7/8" x 3 3/8"	10		Fateful	1400C	1	
3632	Floor board rear plate for pedals	1909-21	2 7/8" x 4 7/8"	10		Father	1095C	1	
3633	Floor board plate for side lever	1909-21	2 3/8" x 8 3/4"	10		Fathom	1094B	1	
3634D	Dash	1913-14	21 1/2" x 32 1/4"	6 25		Flamgo	5336	1	
3634E	Dash	1915-16		3 50		Fleet	7462	1	
3634G	Dash	1917-21		3 00		Fringe	8754	1	
3638B	Dash shield	1919-21		10		Faubaage	5432B	1	
3639	Dash weatherstrip—side	1917-21		05		Flicker	8747	2	
3639B	Dash weatherstrip—top	1917-21		20		Floren	8752	1	
*3640C	Dash bracket—left	1917-21		20		Foal	8722	1	
*3641C	Dash bracket—right	1917-21		20		Fowl	8721	1	
3642B	Dash bracket to dash bolt	1917-21		03		Rodent	8740	4	
3642C	Dash bracket to dash bolt nut	1917-21	Used on 3642B	02		Harrow	926	4	
3645	Dash bracket to dash bolt	1909-16	3/8" x 1 1/4" x 18 thds.	03		Favos	2427	2	
3645B	Dash bracket to dash bolt nut	1909-16	Used on 3645	02		Gram	341	2	
3653B	Dash to body bracket bolt	1915-21	Touring car	03		Planet	4248	2	
3653C	Dash to body brkt. bolt nut	1915-21	Used on 3653B	02		Gram	341	2	
3654	Dash to body gasket	1918-21		05		Feaze	8769	1	
3660C	Tail lamp and license bracket assembly	1915-21	Touring car, Sedan, Town car	50		Flour	7506	1	
3660D	Tail lamp and license bracket assembly	1915-21	Runabout and 1916-17 Coupelet	40		Flute	7505	1	
3662	Front license bracket-R	1920-21		10		Fluffy	287	1	
3663	Front license bracket-L	1920-21		10		Fluently	288	1	
3664	Front license bracket	1921		15		Fluxion	493	1	
3667E	Front seat cushion	1909-21		8 00	MH	Farce	8076	1	
3670D	Rear seat cushion	1909-21		8 00	MH	Forum	7032	1	
3676B	Tonneau mat	1911-21	30" x 28" wool	1 60		Flatus	1606B	1	

<b>SPRINGS</b>									
3809	Front spring	1909-21		3 20	MH	Gadan	332	1	
3801	First leaf (main leaf)	1909-21		90		Golf	2943	1	
3802B	Second leaf	1909-21		65		Goose	2935	1	
3803	Third leaf	1909-16	Tapered ends	50		Gaddish	356	1	
3803B	Third leaf	1916-21	Square ends	50		Gopher	2936	1	
3804	Fourth leaf	1909-16	Tapered ends	40		Gadoid	357	1	
3804B	Fourth leaf	1916-21	Square ends	40		Gosling	2937	1	
3805	Fifth leaf	1909-16	Tapered ends	35		Gallic	358	1	
3805B	Fifth leaf	1916-21	Square ends	35		Gossip	2938	1	
3806	Sixth leaf	1909-16	Tapered ends	20		Gafol	359	1	
3806B	Sixth leaf	1916-21	Square ends	30		Gothic	2939	1	
3807	Seventh leaf	1909-16	Tapered ends	25		Gaiter	360	1	
3807B	Seventh leaf	1916-21	Square ends	25		Gally	2947	1	
3808	Front spring clip	1909-21		25		Galena	325C	2	
3809	Front spring clip nut	1909-21	Order 2568						
3810	Front spring clip bar	1921		30		Gallate	342	1	
3811	Front spring tie bolt	1909-21	3/8" x 2 1/4"	04		Galley	1362	1	
3811B	Front spring tie bolt nut	1909-21	Used on 3811	02		Galleon	1363	1	
3813	Front spring hanger	1909-21	Each	20		Gambit	246B	4	
3815	Front and rear spring hanger nut	1909-21	Order 2719						
3817	Front and rear spring hanger oiler	1909-16		05		Gamin	218	8	
3818	Front spring perch-right	1909-19		70	MH	Gamut	274	1	

\*When used on 1911-16 cars redrill frame.

Of the net amount at which these parts are billed to purchasers who purchase direct from the Ford Motor Company (except parts which show no Tax Status, if any) 20, 21 represents the price of the goods and 1, 21 represents excise tax.

Insist upon genuine Ford parts

Part No.	Name of Part	Year	Specifications	Price	Tax Status	Code Word	Fac. No.	Req. per Car
----------	--------------	------	----------------	-------	------------	-----------	----------	--------------

SPRINGS—Continued

3818B	Front spring perch-right	1919-21		\$ 0 70	MH	Garret	274B	1
3819	Front spring perch-left	1909-19		70	MH	Gander	275	1
3819B	Front spring perch-left	1919-21		70	MH	Gastar	275B	1
3820	Front spring perch bushing	1909-21	1 1/2" x 1 1/2"	05		Gangue	230	4
3821	Front spring perch nut	1909-21	3/8" x 18 thds. Order 2828	10		Gannet	262	1
3823	Front spring leather	1909-21	1 1/2" x 5 3/4"	10		Ganoid	333	1
3824	REAR SPRING	1909-21	56" tread, 8 leaf	9 00	MH	Gantlope	361	1
3825	First leaf (main leaf)	1909-19	Tapered ends	1 70		Gallop	361B	1
3825B	First leaf (main leaf)	1918-21		1 70		Gantois	362	1
3826	Second leaf	1909-19	Tapered ends	1 55		Galore	362B	1
3826B	Second leaf	1918-21	Square ends	1 55		Ganza	363	1
3827	Third leaf	1909-19	Tapered ends	1 40		Garnish	363B	1
3827B	Third leaf	1918-21	Square ends	1 40		Gaphare	364	1
3828	Fourth leaf	1909-19	Tapered ends	1 25		Gender	364B	1
3828B	Fourth leaf	1918-21	Square ends	1 25		Garden	365	1
3829	Fifth leaf	1909-19	Tapered ends	1 10		Genus	365B	1
3829B	Fifth leaf	1918-21	Square ends	1 10		Garland	366	1
3830	Sixth leaf	1909-19	Tapered ends	1 00		Ghoul	366B	1
3830B	Sixth leaf	1918-21	Square ends	1 00		Garlic	367	1
3831	Seventh leaf	1909-19	Tapered ends	90		Giant	367B	1
3831B	Seventh leaf	1918-21	Square ends	90		Gimlet	368B	1
3832B	Eighth leaf	1909-21	Square ends	80		Game	326	2
3833	Rear spring clip	1909-21	4 1/8"	25		Gascon	329	2
3834	Rear spring clip nut	1909-21	Order 2548	10		Gastric	1352	1
3835	Rear spring clip bar	1909-21	3/8" x 1 1/4" x 4" x 1/8"	05		Gaufer	1353	1
3837	Rear spring tie bolt	1909-21	3/8" x 2 1/4"	02		Gaulus	91 1/2B	4
3837B	Rear spring tie bolt nut	1909-21	Used on 3837	20		Gavel	94	1
3840	Rear spring hanger	1909-21	Each	10		Gavot	2804	2
3842	Rear spring leather pad	1909-21	2" x 10 1/4"	50	MH	Gawky	172	4
3843	Rear spring perch	1909-21		05		Gazara	174	2
3844	Rear spring perch bushing	1909-21	5/8" bore x 3/4" dia. x 2"	10		Gazzam	374	2
3845	Rear spring perch nut	1909-21	1 1/8" x 16 thds.	10		Gown	2953	2
3847	Front spring clip assembly with bolt and nut	1909-16		10		Gecko	376	2
3847B	Front spring clip assembly with bolt and nut	1916-21	(for 6 leaf spring)	10		Gemmy	378	2
3848	Rear spring clip assembly with bolt and nut	1909-17		10				
3848B	Rear spring clip assembly with bolt and nut	1918-21		10				

REAR SPRING—60 INCH TREAD

3850	Rear spring	1909-16	48 1/2" long, 8 leaf	12 00	MH	Geddur	1704	1
3851	Rear spring clip	1909-16	1 1/8" x 4 1/8"	25		Gelder	1737	2
3852	Rear spring tie bolt	1909-16	3/8" x 3 1/2"	10		Gemote	1738	1
3852B	Rear spring tie bolt nut	1909-16	Used on 3852	02		Gaufer	1353	1
3853	First leaf (main leaf)	1909-16		2 40		Gemsbok	1739	1
3854	Second leaf	1909-16		2 00		Gershon	1740	1
3855	Third leaf	1909-16		1 60		Gerper	1741	1
3856	Fourth leaf	1909-16		1 40		Gherkin	1742	1
3857	Fifth leaf	1909-16		1 30		Gibbet	1743	1
3858	Sixth leaf	1909-16		1 20		Ginger	1744	1
3859	Seventh leaf	1909-16		1 00		Gipsire	1745	1
3860	Eighth leaf	1909-16		90		Gisarm	1746	1

STARTING CRANK

3900	Starting crank only	1909-21		70		Hernia	519B	1
3901	Starting crank handle	1909-21		25		Heron	520	1
3902	Starting crank handle bolt	1909-21	1/2" x 4 5/8"	10		Herpes	521	1
3903	Starting crank sleeve	1909-21	1 1/8" bore x 1 1/2" x 2 3/4"	10		Hesper	523	1
3905	Starting crank ratchet pin	1909-21	1 1/8"	05		Hestern	4491	1
3906	Starting crank ratchet	1909-21		25		Hetman	528	1
3908	Starting crank spring	1909-21		05		Hilding	626	1
3909	Starting crank handle spring	1915-21		03		Hitter	5911	1

RADIATOR—THERMO-SYPHON

3925	Radiator	1909-16		20 00	MH	Hominy	1106C	1
3925B	Radiator	1917-21		23 00	MH	Honey	8700	1
3925C	Radiator less shell	1917-21		21 50	MH	Hop	8736	1
3926	Radiator cap	1909-21		20	MH	Hoثير	8714	1
3928	Radiator pad	1909-19	Leather	05		Hovel	1105	2
3929	Radiator stud	1909-19	3/8" x 2 1/8"	05		Hoxy	1162	2
3929B	Radiator stud	1919-21		05		Hoax	1162B	2
3929C	Radiator stud nut	1909-21	Used on 3929 & 3929B	03		Hive	1154	2
3930	Radiator stud spring	1909-21	Order No. 2742					
3931 1/2	Radiator stud washer nut	1909-21	3/8" x 24 thds.	03		Huffish	1161	2

Of the net amount at which these parts are billed to purchasers who purchase direct from the Ford Motor Company (except parts which show no Tax Status, if any) 20/21 represents the price of the goods and 1/21 represents excise tax.

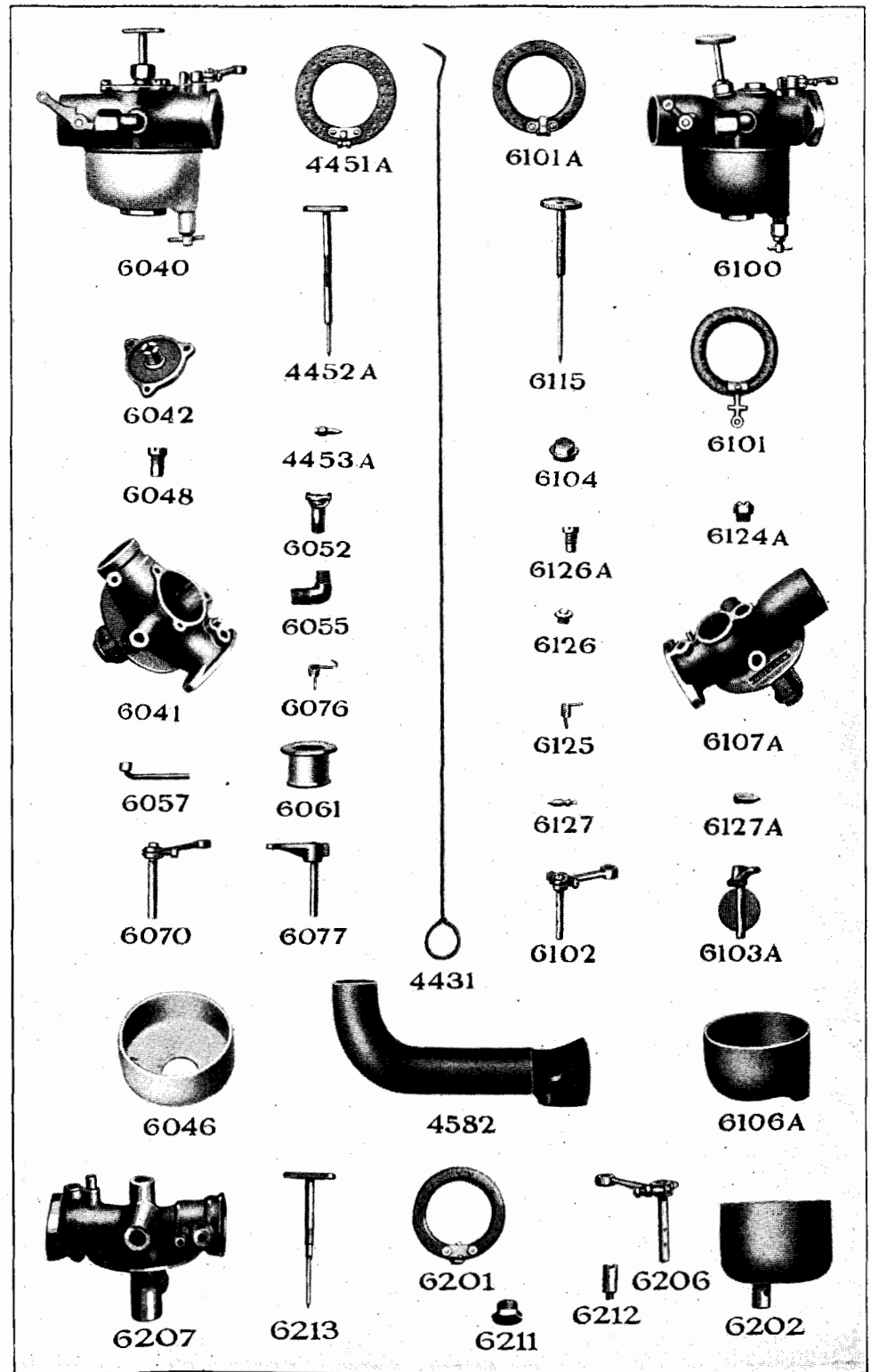

Insist upon genuine Ford parts

Part No.	Name of Part	Year	Specifications	Price	Tax Status	Code Word	Fac. No.	No. Req. per Car
<b>RADIATOR THERMO-SYPHON—Continued</b>								
3932	Radiator rod	1909-21	20 3/4" long	\$ 0 15	MH	Huller	1111B	1
3934	Radiator rod nut	1909-21	3/8" x 24 thds	03		Humbler	517	1
3939	Outlet connection pipe	1909-21	1 3/4" x 12"	35		Humic	1121	1
3940	Outlet connection cock	1909-21	Order 3079					
3944	Outlet connection hose	1909-21	1 3/4" x 2 3/4"	15		Hungry	507	2
3945	Outlet connection hose clip	1909-21	2 3/8" dia	05		Hunter	554	4
3947	Radiator shell	1917-19		1 50	MH	Hymn	8737	1
3947B	Radiator shell	1919-21		1 50	MH	Hymnal	8737B	1
3975	Radiator stud spring upper thimble	1919-21		02		Hump	1115	1
3976	Radiator stud spring lower thimble	1919-21		03		Hurst	1114	1
<b>RADIATOR FAN</b>								
3960	Fan and pulley assembly	1909-20		1 50	MH	Hutten	619	1
3961	Fan blade	1909-20		10		Hyades	611	4
3961B	Fan blade rivets, per dozen	1909-20		05		Hyad	1566	16
3961C	Fan blade assy	1920-21		30		Iambe	620	1
3962	Driven fan pulley	1909-20	Brass, upper	80		Hydra	618	1
3962B	Driven fan pulley with bushing	1920-21		1 00		Iaon	618B	1
3963	Fan drive pulley	1909-20	Steel, lower	30		Hydrant	602	1
3963B	Fan drive pulley	1920-21		20		Hydromel	602B	1
3964	Fan belt	1909-16	23 3/8" long	35		Hydrate	609	1
3964C	Fan belt	1917-20	In carton, 26 1/2" long	35		Impel	609B	1
3964D	Fan belt	1920-21	27 1/2" long	35		Idiom	609C	1
3966	Fan shaft	1909-20	1 1/8" x 4 1/8"	20		Hyper	606	1
3966B	Fan shaft	1920-21		30		Iasius	606B	1
3967	Fan bracket	1909-16		40		Hypo	604	1
3967B	Fan bracket	1917-21		40		Idyl	604B	1
3968	Fan bracket bolt	1909-21	1/2" x 2 3/8"	15		Hypere	605	1
3970	Fan grease cup	1909-21		10		Hyppish	601	1
3973	Fan adjusting screw	1909-21	3/8" x 1 1/8"	03		Groats	645	1
3973B	Fan adjusting screw nut	1909-21	Used on 3973	03		Humbler	517	1
3974	Fan driven pulley bushing	1917-20		20		Knaq	8757	1
3974B	Fan driven pulley bushing	1920-21		20		Ibhar	8757B	2
3980	Fan pulley plug	1920-21		03		Ibidem	633	1
3981	Fan pulley gasket	1920-21		01		Icarian	634	1
3982	Fan shaft cap	1920-21		02		Icllius	635	1
3983	Fan shaft felt washer	1920-21		02		Iconism	637	1
3984	Fan blade screw	1920-21		01		Ictus	652	4
3985	Fan blade screw washer	1920-21	Order T 3261C					4
3986	Fan shaft nut	1920-21	Order T 2719					1
<b>MUFFLER</b>								
4025	Muffler assembly	1909-20		2 00	MH	Jobal	1200	1
4025B	Muffler assembly	1921	Includes 3061 & 4037C	3 50	MH	Jocasta	1200C	1
4026B	Muffler head—front	1917-20		45		Julep	1202C	1
4026C	Muffler head—front	1921	Pressed steel	20		Julian	1202D	1
4027	Muffler shell—outer	1909-21	5" dia. x 12"	25		Jabin	1203	1
4028	Muffler shell—middle	1909-21	3 1/2" dia. x 13"	20		Jackal	1204	1
4029	Muffler shell—inner	1909-20	2" dia. x 14"	15		Jaday	1205	1
4030	Muffler rod	1909-17	1 1/8" x 13 3/8"	10		Jadish	1206	3
4030B	Muffler rod	1917-20		10		Jocose	1206B	1
4031	Muffler rod nut	1909-20	3/8" x 24 thds. Order 3446					
4032	Muffler head retainer	1921		02		Jole	1210	1
4033	Muffler head retainer bolt and nut	1921	Order 4819B and 4819D					
4035	Muffler head bolt washer	1921		01		Jovy	5508	1
4037B	Long exhaust pipe	1909-20		2 00		Jaunty	1214	1
4037C	Long exhaust pipe	1920-21		2 25		Jazerant	1214B	1
4040B	Muffler head—rear	1917-21		45		Jesuit	1201D	1
4040C	Muffler head—rear	1921	Pressed steel	20		Jeush	1201E	1
4041	Muffler head to frame bolt and nut	1917-21	Order 2722 & 3066B					
4041B	Muffler head to frame bolt and nut	1921	Order 3074 and 3074B					
<b>HOOD</b>								
4050	Hood	1909-16	22" long	5 00		Jibsam	1300	1
4050B	Hood	1917-21		5 00	MH	Jilt	8726	1
4051	Hood handle	1909-21	5 1/2" long	05		Jingal	1314	2
4052	Hood clip	1909-16	3 1/8" long	10		Jippo	1310	4
4052B	Hood clip	1917-21		10		Jowl	8731	4
4053	Hood clip spring	1909-16		03		Jockey	1311	4
4053B	Hood clip spring	1917-21		03		Juice	8734	4
4056	Hood board—left	1909-16	22 3/4" long	25		Johim	1339	1
4056B	Hood board—left	1917-21		20		Kilt	8742	1
4057	Hood board—right	1909-16	22 3/4" long	25		Jorum	1340	1
4057B	Hood board—right	1917-21		20		Kine	8741	1
4060B	Hood support on dash	1915-16		1 50		Juror	7464	1
4060C	Hood pad (on dash)	1917-21		10	MH	Kite	8711	2

Of the net amount at which these parts are billed to purchasers who purchase direct from the Ford Motor Company (except parts which show no Tax Status, if any) 20/21 represents the price of the goods and 1/21 represents excise tax.

Insist upon genuine Ford parts

Part No.	Name of Part	Year	Specifications	Price	Tax Status	Code Word	Fac. No.	No. Req. per Car
<b>HOOD—Continued</b>								
4060D	Hood pad (on radiator shell)	1917-21		\$ 0 20	MH	Kid	8710	1
4061B	Hood clasp (on dash)	1917-21		05		Kit	8720	1
4061C	Hood clasp (on dash) screw	1917-21		02		Knee	8763	2
4061D	Hood clasp (on dash)	1920-21		05		Kitten	8720B	1
4073	Hood block support—front right	1917-21		05		Knot	8743	1
4074	Hood block support—front left	1917-21		05		Kiln	8744	1
4075	Hood block support—rear right	1917-21		05		King	8745	1
4076	Hood block support—rear left	1917-21		05		Kirk	8746	1
<b>KINGSTON CARBURETOR</b>								
6100	Carburetor complete	1909-21		6 00		Mason	553A1	1
6101A	Carburetor float assb	1917-21		1 00		Moslem	6369	1
6101	Float with lever	1915-16		1 00		Marsh	6351	1
6127A	Gasoline valve	1917-21		35		Moral	6377	1
6115	Spray needle assembly	1910-21		50		Medal	3010	1
Parts for 1909-16 Carburetors supplied by Bryne Kingston Co., Kokomo, Ind.								
<b>FORD CARBURETOR (MODEL "G")</b>								
6040	Carburetor complete	1909-21		6 00	MH	Mire	553A2	1
4451A	Float with lever	1914-21		75		Muzzle	6333	1
4452A	Spray needle assembly	1914-21		20		Myrtle	6335	1
4453A	Gasoline inlet needle	1914-21		30		Mystic	6324	1
Parts for 1909-13 Carburetors supplied by Holley Kerosene Carburetor Co., Detroit, Mich.								
<b>HOLLEY CARBURETOR (MODEL "NH")</b>								
6200	Carburetor complete	1920-21		6 00		Mutably	553A3	1
6201	Float with lever	1920-21		1 00		Mutage	6333B	1
6213	Spray needle assembly	1920-21		60		Mutiny	6335B	1
(Other parts required may be ordered by plate numbers; prices quoted on application.)								
<b>CARBURETOR ATTACHMENTS</b>								
4127A	Carb. adjusting rod bracket	1909-21	On dash	05		Lastage	1357	1
4129A	Carb. adjusting rod	1909-21		20		Latten	7920	1
4130	Carb. flange bolt	1909-21		03		Myth	1388	2
4130B	Carb. flange bolt nut	1909-21	Used on 4130	05		Humbler	5 7	2
4134	Carb. flange gasket	1909-21		05	MH	Lecturn	1380B	1
4431	Carb. priming rod	1909-21		05		Loach	2000	1
4582	Carb. hot air pipe	1912-21		20		Monkey	606	1
4583	Priming bell crank	1919-21	Starter type	15		Tenet	7691	1
4585	Priming rod plate	1919-20	Coupe starter type	15		Thrum	7064	1
4586	Priming rod plate	1919-20	Sedan starter type	15		Thrusse	7665	1
4587B	Priming rod	1919-21	Sedan starter type	20		Thule	6628	1
4588B	Priming rod	1919-21	Coupe, T. C. & Rbt. starter type	20		Thumb	6627	1
4589	Carburetor priming rod	1919-21	Starter type	05		Thunder	8797B	1
<b>FENDERS—56 INCH TREAD</b>								
4800B	Front fender—right	1917-21	All Cars	6 00	MH	Nook	7976	1
4801B	Front fender—left	1917-21	All Cars	6 00	MH	Noose	7977	1
4802F	Rear fender—right	1917-21	All Cars	5 00	MJ	Norse	8850	1
4803F	Rear fender—left	1917-21	All Cars	5 00	MH	Nougat	8851	1
4804D	Rear fender iron—right and left	1913-21	Touring car	20		Smile	5405	2
4804E	Rear fender iron—right	1913-21	Torpedo & Coupelet	60		Saire	5563	1
4804F	Rear fender iron—left	1913-21	Torpedo & Coupelet	60		Shrub	5390	1
4804G	Rear fender iron—right or left	1916-17	Sedan	40		Nubble	8154A	2
4804K	Fender iron—right or left	1918-21	Sedan	40		Shoggle	8154B	2
4805B	Rear fender iron bolt	1915-21	Touring, 5/16" x 3/4"	03		Rascal	7171	6
4805C	Rear fender iron bolt nut	1915-21	Used on 4805B	02		Gram	341	6
4806B	Fender eye bolt	1909-21		06		Pepsin	1942	4
4806C	Fender eye bolt washer	1909-21		01		Perish	1943	4
4806D	Fender eye bolt nut	1909-21	Used on 4806B	03		Elk	29	4
4808	Front fender iron bolt (side)	1910-21	3/8" x 3 1/2"	03		Module	1323	2
4808B	Front fender iron bolt (bottom)	1910-21	3/8" x 1 1/2"	03		Griffin	347	2
4808D	Front fender iron bolt nut	1910-21	Used on 4808 & 4808B	03		Egret	8	8
4808C	Front fender apron to frame bolt	1915-21	1/4" x 5/8"	03		Placid	4088	4
4808E	Front fender apron to frame bolt nut	1915-21	Used on 4808C	02		Missive	1309	4
4809	Front fender iron—right or left	1909-21		75		Sistom	343	2

Of the net amount at which these parts are billed to purchasers who purchase direct from the Ford Motor Company (except parts which show no Tax Status, if any) 20/21 represents the price of the goods and 1/21 represents excise tax.

Insist upon genuine Ford parts





Part No.	Name of Part	Year	Specifications	Price	Tax Status	Code Word	Fac. No.	No. per Car	Req.
<b>RUNNING BOARDS AND SHIELDS—56 INCH TREAD</b>									
4812	Running board—right or left	1909-21	.44 $\frac{1}{2}$ " long	\$2 00	MH	Shrew	5418	1	
4814C	Running board shield—right	1917-21	All Cars	2 60	MH	Shrlne	7986	1	
4815C	Running board shield—left	1917-21	All Cars	2 60	MH	Shroud	7987	1	
4816	Running board truss rod—front with nuts	1909-21		50	MH	Skybird	5804	1	
4817	Running board truss rod—rear with nuts	1909-21		50	MH	Skyman	5805	1	
4817B	Truss rod nut	1909-21		03		Skyward	339	4	
4818	Running board bracket	1909-21		1 00		Skyhawk	336	4	
4818B	Running board bracket assembly			1 30		Skyish	2926	2	
4819	Run. board to rear fender bolt	1909-20	$\frac{1}{4}$ " x $1\frac{1}{8}$ "	03		Musty	1344B	4	
4819B	Run. board to rear fender bolt	1921	$\frac{5}{16}$ " x $1\frac{3}{8}$ "	03		Rascal	8161	4	
4819C	Running board to rear fender nut	1909-21	Used on 4819	02		Missive	1309	4	
4819D	Run. board to rear fender nut	1909-21	Used on 4819B and 4820C	02		Harrow	926		
4820	Running board to front fender bolt and nut	1909-20	Order 4808C and 4808E						
4820C	Running board to front fender bolt	1921		03		Skiver	8109	4	

**RUNNING BOARD—TRUCK**

4830	Running board—right or left	1918-21	Old No. 1129	75	MH	Gull	TT-5418	2	
4831	Running board bracket	1918-21	Old No. 1130	40		Heck	TT-2926	4	
4832	Running board bracket brace	1918-21	Old No. 1131	15		Hedge	TT-2927	2	
4833	Running board bracket rear brace	1918-21	Old No. 1132	30		Hedging	TT-2929	1	

Of the net amount at which these parts are billed to purchasers who purchase direct from the Ford Motor Company (except parts which show no Tax Status, if any) 20/21 represents the price of the goods and 1/21 represents excise tax.

Part No.	Name of Part	Year	Price	Tax Status	Code Word	Fac. No.	No. per Car	Req.	
<b>FORD SPARK COIL</b>									
5000	Coil (includes switch)	1909-21	\$11 75	MH	Negus	1383	1		
5001	Coil (starter type)—less switch	1909-21	11 00		Neil	1383B	1		
5002	Coil box with cover (includes switch)	1914-21	2 75	MH	Nenia	5858	1		
5003	Coil box with cover (starter type)—less switch	1919-21	2 00	MH	Nepeta	5858B	1		
5004	Coil box cover	1915-21	30		Neptune	7910	1		
5005	Switch cover	1914-17	05		Nones	5835	1		
5005B	Switch cover	1918-21	10		Nonage	5835b	1		
5006	Switch plug	1914-21	05		Nopal	5815	1		
5007	Coil unit, $3\frac{1}{2}$ " x $2\frac{1}{8}$ " x 5"	1914-21	2 25	MH	Nongin	5845	4		
5008	Vibrator with tungsten point	1914-21	10		Nonce	6797	4		
5009	Vibrator bridge with tungsten point	1914-21	15		Novia	6702	4		

**SWITCH**

5010	Switch assembly (on coil)	1914-21	75		Nidor	5873	1	
5012	Switch (ignition) (starter type on instrument board)	1919-21	1 50		Tolad	7675E	1	
5013	Keys (switch)—give serial number	1919-21	10		Thrall	5815B	1	
5014	Starting switch (on floor board)	1919-21	80		Topaz	8792	1	
5015	Extension (starting switch plunger)	1919-21	10		Tetric	8793	1	

**AMMETER**

5016	Ammeter	1919-21	1 50		Tassel	7680	1	
5017	Ammeter lens and rim	1919-21	30		Tensor	8105	1	

**BENDIX DRIVE**

5018	Bendix	1919-21	5 00		Tattler	1883	1	
5019	Head (Bendix)	1919-21	50		Thine	2007	1	
5020	Key (Bendix)	1919-21	02		Tholl	1751	1	
5021	Shaft and gear (Bendix)	1919-21	4 50		Thurl	2026	1	
5022	Spring (Bendix)	1919-21	75		Tinge	2006	1	
5023	Screw (Bendix shaft spring)	1919-21	10		Tinsel	1983	1	
5024	Screw (Bendix head spring)	1919-21	05		Tipple	1781	1	
5025	Washer (Bendix spring screw lock)	1919-21	05		Tipsy	1782	2	

**WIRING**

5026	Spark plug wire $14\frac{1}{2}$ " No. 1 cyl.	1909-21	15	MH	Nohob	1365	1	
5027	Spark plug wire (also magneto to coil) $10\frac{1}{2}$ " No. 2 cyl.	1909-21	15	MH	Nachor	1366	1	
5028	Spark plug wire, 7" No. 3 and 4 cyls.	1909-21	10	MH	Nalad	1376	2	
5029	Spark plug wire terminal	1909-21	03		Nailer	1381	8	
5030	COMMUTATOR WIRE (non starter type)	1909-21	90	MH	Nandu	7502	1	
5031	Commutator wire (starter type)	1919-21	90	MH	Trifle	7502B	1	
5032	Com. wire terminal (coil end)	1909-21	01		Napher	1385	4	
5033	Com. wire loom support	1909-21	03		Napple	1390	2	
5034	Wire (ammeter to cut-out) Sedan 33"	1919	15	MH	Topic	7683	1	
5035	Wire (ammeter to cut-out) Sedan 49"	1919-21	20	MH	Topmast	7683B	1	
5036	Wire (ammeter to cut-out) Coupe 23"	1919	15	MH	Torch	7684	1	
5037	Wire (ammeter to cut-out) Coupe 41"	1919-21	20	MH	Rabid	7684B	1	
5038	Wire (ammeter to ignition switch)	1919-21	10	MH	Torpid	7681	1	
5039	Wire (generator to cut-out)	1919	15	MH	Trash	7687	1	
5040	Wire (terminal block to switch)	1919-21	10	MH	Trench	8894B	1	
5041	Wire (lighting)	1919-21	1 00	MH	Tromp	7682B	1	
5042	Wire (switch) Sedan	1919-21	70	MH	Troth	7685B	1	
5043	Wire (switch) Coupe	1919-21	60	MH	Truce	7686B	1	
5044	Block (terminal)	1919-21	10		Teller	1950	1	
5045	Screw (terminal block to cast)	1919-21	01		Tocsin	2073	2	
5046	Cable (battery to switch) $28\frac{1}{4}$ "	1919-21	90	MH	Tepor	1889B	1	
5047	Cable (battery to switch) $34\frac{1}{4}$ "	1920	1 00	MH	Pantry	1889C	1	
5048	Cable (ground) 20"	1919	70	MH	Terse	1890	1	
5049	Cable (ground) $9\frac{1}{8}$ "	1919-21	50	MH	Testa	1890B	1	
5050	Cable (ground) $11\frac{1}{8}$ "	1920	60	MH	Parish	1890C	1	
5051	Cable (switch to motor)	1919-21	65	MH	Tether	1891	1	
5052	Bolt (battery cable terminal)	1919-21	04		Pelvis	1937	2	
5052B	Nut (battery cable term. bolt) Used on 5052	1919-21	03		Pennon	1938	2	

**CUT-OUTS**

5054	Cut-out (electric) (dash type)	1919	1 50		Tenant	7677	1	
5055	Cut-out (electric)	1919-21	1 50		Tendril	7677B	1	

**STARTER PARTS**

5056	Gasket (motor mounting)	1919-21	02		Theme	1768		
5057	Gasket (gen. head)	1919-21	02		Thane	1774		
5058	Screw (gen. mounting, short)	1919-21	03		Thrack	1755		
5059	Screw (Bendix cover)	1919-21	01		Thrave	1765		
5060	Screw (term. block to wire)	1919-21	01		Thwack	2015		
5061	Screw (ammeter to plate)	1919-21	01		Thwart	5819		
5062	Screw (motor mounting)	1919-21	03		Thymet	1760		

Of the net amount at which these parts are billed to purchasers who purchase direct from the Ford Motor Company (except parts which show no Tax Status, if any) 20/21 represents the price of the goods and 1/21 represents excise tax.

**Insist upon genuine Ford parts**

**Insist upon genuine Ford parts**

Part No.	Name of Part	Year	Price	Tax Status	Code Word	Fac. No.	No. Req. per Car
<b>STARTING MOTOR AND PARTS</b>							
5099	Motor (starting)	1919-21	\$18 00	MH	Tidbit	1877	
5100	Armature	1919-21	6 00		Tabld	1940	
*5101	Band (cover)	1919-21	20		Tallage	1801	
5102	Bracket (brush end)	1919-21	50		Talmen	1868	
5103	Bracket assem. (mounting)	1919-21	2 00		Tawny	2037	
5104	Brush	1919-21	30		Tanvat	1806	
5105	Bushing (shaft, rear)	1919-21	40		Tapnet	1759	
5106	Bushing (shaft, front)	1919-21	20		Tapster	1789	
5107	Coil assembly (field)	1919-21	2 00		Targum	1871	
5108	Holder assem. (brush)	1919-21	70		Talpa	1864B	
5109	Insulator (terminal, outer)	1919-21	05		Talus	1795	
*5110	Insulator (terminal, inner)	1919-21	03		Tambac	1794	
5112	Nut (terminal)	1919-21	05		Tambour	1791	
*5113	Screw (field)	1919-21	02		Tamis	1788	
*5114	Screw (brush end bracket to yoke)	1919-21 doz.	10		Tamkin	1808	
5115	Spring (brush tension)	1919-21	05		Tampon	1809	
5116	Washer (terminal)	1919-21	02		Tarras	1792	
5117	Washer (terminal, inner, steel)	1919-21	02		Tarsic	1798	
5118	Yoke (motor) assembly	1919-21	5 50		Tartly	1852	

**GENERATOR AND PARTS**

5119	Generator	1919-21	18 00	MH	Tetter	1879	
†5120	Armature (less bearings)	1919-21	6 00		Tanling	1925	
5121	Bearing (small)	1919-21	1 20		Tannic	1838	
5122	Bearing (large)	1919-21	1 45		Tantrum	1841	
5123	Bolt (terminal)	1919-21	03		Tegmen	1836	
5124	Bracket (brush end)	1919-21	40		Telary	1894	
5125	Brush (large)	1919-21	20		Tempean	1844	
5126	Brush (small)	1919-21	20		Tempter	1845	
5127	Disc (large bearing)	1919-21	03		Tendry	1847	
5128	Felt (small bearing)	1919-21	03		Tenter	2033	
5130	Head	1919-21	50		Tercel	2044	
5131B	Holder (small brush)	1919-21	15		Ternor	1821	
5132B	Ring (brush holder)	1919-21	10		Terrapin	1996	
5132C	Holder assem. (brush)	1919-21	60		Ternary	1865	
5132D	Holder assem. (brush) less small brush holder	1919-21	45		Ternate	1920	
5133	Insulator (terminal, outer)	1919-21	05		Terras	1827	
5134	Nut (terminal)	1919-21	03		Tilling	1818	
5134B	Nut (small brush holder stud)	1919-21	02		Tilmsus	6754	
5135	Oiler	1919-21	10		Testern	1837	
5136	Pin (pinion to shaft)	1919-21 doz.	05		Testudo	1750	
5137	Pinion	1919-21	50		Throng	1752	
5138	Retainer (small bearing felt)	1919-21	02		Theban	1832	
5139	Spring (large brush)	1919-21	05		Theist	1967	
5140	Spring (small brush)	1919-21	05		Themis	1988	
5141	Stud (small brush holder)	1919-21	05		Theon	1823B	
5141B	Stud (small brush holder)	1919-21	02		Theoric	1823C	
5142	Washer (terminal)	1919-21	02		Thermal	1831	
5142B	Washer (small brush holder stud)	1919-21 doz.	05		Phrase	2058	
5143	Winding assembly (field)	1919-21	2 00		Tholus	1978	
5144	Wire (brush to terminal)	1919-21	08		Thorp	1851	
5145	Yoke (generator) assembly	1919-21	5 00		Thorite	1887	

**BATTERY BRACKET AND PARTS**

5150	Bracket assem.	1919-21	1 00		Tattoo	8841	
5151	Bolt (clamp)	1919-21	03		Rustic	8846	
5151B	Nut (clamp bolt) Used on 5151	1919-21	03		Elk	29	
5152	Clamp	1919-21	05		Tetrad	8844	

**SPARK PLUGS**

5200	Spark plug (Bethlehem)	1909-21	60		Tirrit	1386A2	4
5201	Spark plug (Champion)	1909-21	75		Tirzah	1386A1	4
5202	Spark plug porcelain (Bethlehem)	1909-21	35		Titia	3761	4
5203	Spark plug porcelain (Champion)	1909-21	40		Titling	3760	4

\*Also for generator.

†Armature may be exchanged with dealer at \$5.00.

Of the net amount at which these parts are billed to purchasers who purchase direct from the Ford Motor Company (except parts which show no Tax Status, if any) 20/21 represents the price of the goods and 1/21 represents excise tax.

Part No.	Name of Part	Year	Specifications	Price	Tax Status	Code Word	Fac. No.	No. Req. per Car
<b>REPAIR TOOLS</b>								
1349	Hub cap wrench		Regular equipment	\$ 0 20		Pacal	1349	
1387	Adjustable wrench		Regular equipment	50		Pacos	1387	
1902	Screw driver		Regular equipment	50		Padan	1902	
1903	Pliers		Regular equipment	40		Paddy	1903	
1917	Double end wrench		Regular equipment	20		Pagan	1917	
2335	Spark plug and cyl. head bolt wrench		Regular equipment	50		Pavid	5893	
2336	Tool roll		Regular equipment	30		Pawky	1979	
2337	Oil can		Regular equipment	30		Paxos	1384	
2338	Tire pump		Regular equipment	2 00		Payser	1368	
2340	Tire irons, each		Regular equipment	15		Pelage	4069	
2343	Jack		Regular equipment	2 00		Poser	3389	
3Z-604	Valve grinder			2 75		Palster		
3Z-611	Small time gear and trans. driven gear puller			2 00		Pantile		
3Z-614	Transmission clutch disc drum puller			1 25		Papaw		
3Z-619	Crank shaft bearing bolt wrench		Oval head	60		Felox		
3Z-703	Tire iron (large)			60		Fathos		
3Z-2034	Trans. band ratchet wrench			50		Poplin		
3Z-2304	Connecting rod cap bolt nut brace wrench with universal joint for No. 4 connecting rod			2 50		Quadra		
3Z-2316	Fixture for assembling roller bearing cups			8 00		Quaffer		
3Z-4712	Bendix shaft head puller			1 50		Queach		
3Z-4730	Valve spring lifter			50		Qepus		
5Z-152	Rear axle housing bolt nut wrench Old No. 3Z-616			40		Parvis		
5Z-153	Socket wrench for crank shaft bearing bolt nut Old No. 3Z-644			60		Passim		
5Z-154	Body bracket connecting bolt R. & L. wrench Old No. 3Z-719			50		Proverb		
5Z-155	3/4" L socket wrench Old No. 3Z-645 and 3Z-755			50		Pastei		
5Z-156	Crank shaft bearing bolt wrench Old No. 3Z-782			50		Poloy		
5Z-157	Connecting rod cap bolt nut L wrench (Cylinder No. 4) Old No. 3Z-2010			50		Quack		
5Z-158	Drive shaft housing stud nut wrench for 1/2" nut Old No. 3Z-620			50		Parent		
5Z-159	Connecting rod T wrench Old No. 3Z-783			75		Pygmy		
5Z-160	3/4" T socket wrench Old No. 3Z-643			75		Parfit		
5Z-161	Body bracket connecting bolt T wrench, front and center Old No. 3Z-673			80		Prater		
5Z-162	Large cam gear lock nut wrench Old No. 3Z-655			60		Pavan		
5Z-163	Generator third brush adjusting wrench Old No. 3Z-4137			30		Quaver		
5Z-165	Drive shaft pinion T wrench Old No. 3Z-790			80		Fuzzle		
5Z-193	Spindle cone adjusting open end wrench Old No. 3Z-699			40		Profile		
5Z-195	3/4" open end wrench Old No. 3Z-646			30		Pastor		
5Z-196	Rear axle entering wrench Old No. 3Z-627			50		Potion		
5Z-204	Exhaust pack nut open end wrench Old No. 3Z-624			1 00		Potash		
5Z-206	Rear axle nut open end wrench Old No. 3Z-675			80		Porite		
5Z-209	Connecting rod clamp screw wrench Old No. 3Z-647			60		Parrot		
5Z-210	Fly wheel cap screw wrench Old No. 3Z-1179			1 00		Palmly		
5Z-212	Body bracket connecting bolt holding open end wrench Old No. 3Z-686			30		Preen		
5Z-232	Spindle arm bushing driver Old No. 3Z-1956			60		Quincy		
5Z-249	Generator third brush adjusting wrench New Style			30		Quatch		
5Z-285	1/4" hex. brace wrench Old Nos. 3Z-698 and 3Z-786			80		Prince		
5Z-286	Rear axle nut and housing plug brace wrench Old No. 3Z-751			1 00		Pulpit		
5Z-287	Rear wheel puller assembly Old No. 3Z-612			1 50		Panary		
5Z-289	3/4" brace socket wrench Old No. 3Z-1173 and 3Z-1223B			1 00		Parsee		
5Z-290	Piston ring squeezer Old No. 3Z-652			30		Patile		
16Z-4992	Large time gear puller			11 00		Queasy		
20Z-340	Valve seat reamer Old No. 3Z-617-1			2 75		Papula		
20Z-340-1	Valve seat reamer cutter Old No. 3Z-617-2			1 65		Papur		
21Z-356	Valve seat reamer handle Old No. 3Z-617-3			1 10		Pasha		

**REPAIR TOOLS—TRUCK**

5Z-288	Rear wheel puller assembly Old No. 3Z-2257			1 50		Hock		
3389X	Jack			3 00		Hog		

**COTTER PINS**

	Fac. No.		Fac. No.
1/8" x 1" cotter pins	421	1/8" x 1/2" cotter pins	66
1/8" x 3/4" cotter pins	753	1/8" x 1/4" cotter pins	544
1/8" x 1" cotter pins	82	1/8" x 3/8" cotter pins	88
Price, per dozen			\$0 05
Price, per gross			25
Price, per thousand			75

Of the net amount at which these parts are billed to purchasers who purchase direct from the Ford Motor Company (except parts which show no Tax Status, if any) 20/21 represents the price of the goods and 1/21 represents excise tax.

Insist upon genuine Ford parts

Insist upon genuine Ford parts

# Price List of Accessories and Accessory Parts

Part No.	Name of Part	Make	Year	Code	Price	Tax Status
<b>ELECTRIC HORN</b>						
6432X	Electric horn complete	Ulcer			\$ 2 50	
7915X	Electric horn terminal wire 9"	Ulna			05	MH
7917X	Electric horn to switch wire 35½"	Ultra			15	MH
8028X	Horn switch assembly	Valiant			30	MH
<b>ELECTRIC HEAD LAMPS (STANDARD 1915-21)</b>						
6511BX	Head lamp assembly—used with dimmer on magneto current (when used on magneto current without dimmer use T 6572X bulb per pair)	Unific			7 00	
6511CX	Head lamp assembly—two bulb type—per pair	Unport			7 00	
6511DX	Head lamp assembly—with "Tu-Lite" frosted bulb—per pair	Uualist			7 00	
6511EX	Head lamp assembly—with "Tu-Lite" clear bulb—per pair	Unbias			7 00	
6594X	Head lamp door assembly—used with 6511DX	Union			75	
6594BX	Head lamp door assembly—with green visor lens	Unitor			75	
6589X	Head lamp switch assembly—with screws	Ural			35	
8650X	Head lamp and horn switch assembly	Urith			40	
8892X	Dimmer resistance coil with wires	Urbox			70	MH
6572X	Head lamp bulb—double contact used with magneto without dimmer	Urban			50	
6572BX	Head lamp bulb—double contact—used with dimmer without starter, or with resistance coil with starter	Uracca			50	
6572CX	Head lamp bulb—single contact—used with storage batteries	Urcan			50	
6572DX	Head lamp bulb "Tu-Lite" double filament—frosted	Urgia			75	
6572EX	Head lamp bulb "Tu-Lite" double filament—clear	Uriel			75	
6520X	Dimmer bulb (for head and tail lamp) single contact	Vamos			28	
6578X	Head lamp door lens gasket	Urchin			05	
6576X	Head lamp door lens—8½"—used with 6511DX	Urn			20	
6576BX	Head lamp door lens—8½"—with green visor	Urith			25	
6592X	Head lamp plug—with thimble	Urus			15	
6585X	Head lamp reflector	Urva			1 00	
6585BX	Head lamp reflector (dimmer type)	Urbos			1 00	
6577X	Head lamp door lens retainer	Usher			05	
6580X	Head lamp focusing screw	Utas			05	
6591X	Head lamp focusing screw spring	Ute			03	
6574X	Head lamp bulb socket	Vagrant			15	
6586X	Head lamp reflector spring	Vail			05	
7487X	Switch to terminal wire—11¾" long	Valise			05	MH
7489X	Lamp to lamp wire—40" long	Vallum			15	MH
7490X	Lamp to ground wire—10¾" long	Vamp			05	MH
<b>SIDE OIL AND TAIL LAMPS—1915-21</b>						
6561X	Side oil lamp, per pair	Van			4 50	
6568X	Tail lamp	Vandal			2 50	
7669X	Electric tail lamp assembly	Vanquish			1 25	
6484BX	Electric tail lamp red lens	Vales			15	
6495X	Electric tail lamp bulb socket	Valgus			20	
6599X	Side oil and tail lamp fount	Vane			50	
6956X	Side oil lamp door	Vanish			50	
6957X	Tail lamp door	Vapid			50	
6966X	Tail lamp white lens and frame	Vapor			20	
6460X	Lamp burner including wick	Varif			30	
6958X	Lamp chimney case	Varus			30	
6472X	Lamp chimney	Vase			30	
6959X	Lamp chimney cover	Vassal			25	
6483X	Side oil lamp door lens	Vat			15	
6484X	Tail lamp door red lens	Vault			15	
6393X	Side oil lamp to bracket bolt nut	Veal			03	
6486X	Lamp door hinge pin	Veer			05	
6392X	Lamp wick	Vega			05	
<b>TOURING CAR AND TORPEDO WINDSHIELDS—1915-21</b>						
*7840X	Windshield assembly, less brackets, bolts, nuts and washers	Vender			15 00	MH
7818BX	Windshield hinge assembly—right	1917-21 Vent			40	
7819BX	Windshield hinge assembly—left	1917-21 Verb			40	
7820AX	Windshield upper frame asser.bly	1915-16 Verge			1 50	
7820BX	Windshield frame assembly—upper	1917-21 Vermin			1 50	
7822AX	Windshield upper half assembly	1915-16 Verse			7 00	MH
7822BX	Windshield upper half assembly	1917-21 Verst			7 00	MH
7823X	Windshield lower half assembly	1915-21 Vertex			8 00	MH
7802X	Windshield lower frame only	1915-21 Venge			1 00	
7803X	Windshield lower frame filler block	1915-21 Verve			20	
7839X	Windshield frame filler block	1915-16 Vervet			15	
7888X	Windshield block (frame filler)—upper	1917-21 Vesper			15	
7810X	Windshield hinge bol	1915-16 Vespido			05	
7845X	Windshield bracket—right	1915-21 Vestal			60	
7845BX	Windshield bracket—right	1915-21 Vestado			60	
7846X	Windshield bracket—left	1915-21 Vestry			60	
7846BX	Windshield bracket—left	1919-21 Vexil			60	
7824X	Windshield glass clamp	1915-21 Veto			05	
7801X	Windshield frame—upper	1915-16 Vial			75	
7887X	Windshield frame—upper	1917-21 Vicar			75	
7890X	Windshield hinge—lower left	1917-21 View			15	

\*Order 7845X-7846X extra for 1915-16 cars.

Of the net amount at which these parts are billed to purchasers who purchase direct from the Ford Motor Company (except parts which show no Tax Status, if any) 20/21 represents the price of the goods and 1/21 represents excise tax.

**Insist upon genuine Ford parts**

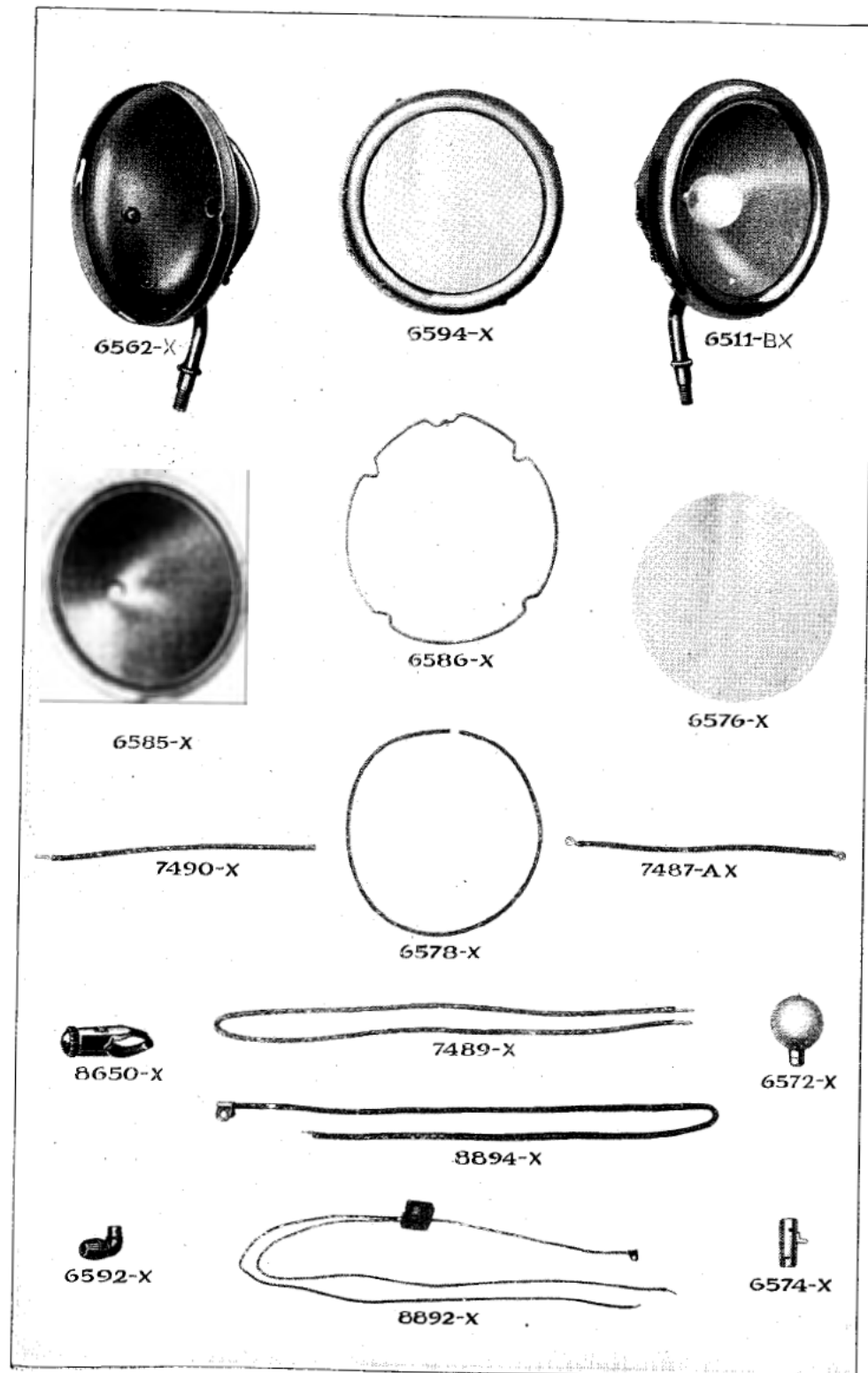

Part No.	Name of Part	Make	Year	Code	Price	Tax Status
<b>TOURING CAR AND TORPEDO WINDSHIELDS—1915-21—Continued</b>						
7805X	Windshield left hand upper hinge		1915-21	Viking	\$ 0 15	
7889X	Windshield hinge—lower right		1917-21	Vim	15	
7807X	Windshield right hand upper hinge		1915-21	Vina	15	
3827X	Windshield top snap loop		1915-21	Vine	05	
1154X	Windshield hinge bolt nut		1915-21	Vintage	03	
2449BX	Windshield glass clamp screw		1915-21	Viol	01	
2257BX	Windshield hinge to frame screw		1915-21	Virent	02	
292X	Windshield hinge spring (Order T2742)					
7851X	Windshield upper glass stop—nickel		1915-21	Vise	25	
7852X	Windshield lower glass stop—nickel		1915-21	Vitals	25	
7808X	Windshield hinge thimble		1915-21	Vitex	05	

**TOURING CAR TOPS—1915-21**

*7940X	Touring car top complete		1915-21	Warm		MH
6882X	Touring car storm curtain (R. H.)		1915-21	Warp	2 50	MH
6883X	Touring car storm curtain (L. H.)		1915-21	Warren	2 50	MH
4966BX	Touring car side curtain (R. H.)		1915-21	Wart	3 00	MH
4967BX	Touring car side curtain (L. H.)		1915-21	Wash	3 00	MH
6894X	Touring car center deck complete		1915-21	Wasp	10 00	MH
6886X	Touring car center deck only 91 1/2" x 50"		1915-21	Waste	6 00	
8913X	Touring car side quarter (R. H.)		1915-21	Watch	2 00	
8914X	Touring car side quarter (L. H.)		1915-21	Water	2 00	
6815X	Touring car side quarter pad		1915-21	Watt	1 50	
6940X	Touring car back stay and curtain assembly		1915-21	Wax	3 50	MH
3897X	Touring car wood bow		1913-17	Weapon	1 50	
8973X	Touring car front and rear extension rib		1918-21	Yawn	40	
8974X	Touring car front and rear upright rib		1918-21	Yell	40	
4596X	Touring car bow separator—male		1913-17	Wedge	05	
4597X	Touring car bow separator—female		1913-17	Weed	05	
6832X	Touring car bow separator		1918-21	Whelp	05	
6860AX	Touring car front extension bow socket (R. H.)		1915-17	Weep	1 00	
6860BX	Touring car front extension rib socket (R. H.)		1918-21	Wealth	1 00	
6861AX	Touring car front extension bow socket (L. H.)		1915-17	Weir	1 00	
6861BX	Touring car front extension rib socket (L. H.)		1918-21	Weary	1 00	
3884AX	Touring car rear extension bow socket (R. H.)		1913-17	Weld	1 00	
3884BX	Touring car rear extension rib socket (R. H.)		1918-21	Wedding	1 00	
3885AX	Touring car rear extension bow socket (L. H.)		1913-17	Welkin	1 00	
3885BX	Touring car rear extension rib socket (L. H.)		1918-21	Welt	1 00	
6862AX	Touring car front upright bow socket (R. H.)		1915-17	Well	1 00	
6862BX	Touring car front upright rib socket (R. H.)		1918-21	Whig	1 00	
6863AX	Touring car front upright bow socket (L. H.)		1915-17	Welsh	1 00	
6863BX	Touring car front upright rib socket (L. H.)		1918-21	Whilk	1 00	
3882AX	Touring car rear upright bow socket (R. H.)		1913-17	West	1 00	
3882BX	Touring car rear upright rib socket (R. H.)		1918-21	Yauk	1 00	
3883AX	Touring car rear upright bow socket (L. H.)		1913-17	Wether	1 00	
3883BX	Touring car rear upright rib socket (L. H.)		1918-21	Yawl	1 00	
7831X	Curtain to windshield hook		1915-21	Whame	03	
7832X	Curtain to body hook		1915-21	Whaul	03	
6837X	Touring car key strap assembly		1913-18	Whale	05	
8992X	Rib socket cotter		1918-21	Wheeze	05	
3924X	Touring car top to windshield strap assembly		1915-21	Wharf	25	
3629X	Touring car rear stay strap assembly complete		1913-21	Wheat	40	
6925X	Touring car curtain to windshield strap assembly		1915-19	Whine	10	
6926X	Touring car curtain to lamp bracket strap assembly		1915-19	Whip	10	
3754X	Touring car curtain glove fastener assembly		1913-21	Whist	05	
6829AX	Touring car duquesne clip—upper		1914-17	Whoop	05	
6829BX	Touring car extension support—upper		1918-21	Yelk	10	
6830AX	Touring car duquesne clip—lower		1914-17	Wick	05	
6830BX	Touring car extension support—lower		1918-21	Yeoman	05	
8937X	Touring car top snap fastener—single		1917-21	Wig	05	
8938X	Touring car top snap fastener—double		1917-21	Willow	05	
3314X	Touring car top prop rest with strap		1913-21	Wind	60	
3858X	Touring car top prop rest arm		1913-21	Wine	25	
3624X	Touring car bow socket to seat iron jappaned nut		1913-21	Wing	05	
3383X	Curtain celluloid 20" x 36"—.015 thick		1913-21	Wink	1 60	
3383X	Curtain celluloid 10" x 18"—.015 thick		1913-21	Winter	40	
4981X	Touring car top visor		1920-21	Wizen	75	

\*Inquire of Branch or Dealer for price.

Of the net amount at which these parts are billed to purchasers who purchase direct from the Ford Motor Company (except parts which show no Tax Status, if any) 20/21 represents the price of the goods and 1/21 represents excise tax.

Part No.	Name of Part	Make	Year	Code	Price	Tax Status
<b>TORPEDO TOP PARTS—1915-21</b>						
*7941X	Torpedo top complete		1915-21	Wisdom		MH
4971X	Torpedo top—second and third wood bows		1914-18	Wish	\$ 0 50	
6929X	Torpedo top—first bow		1915-18	Wisp	50	
8772X	Rib—upright		1918-21	Wenny	40	
8988X	Rib—front extension		1918-21	Wept	40	
8989X	Rib—rear extension		1918-21	Westing	40	
6870X	Torpedo top bow socket—upright—(R. H.)		1915-18	Witch	1 25	
6870BX	Torpedo top rib socket—upright—(R. H.)		1918-21	Whaling	1 25	
6871X	Torpedo top bow socket—upright—(L. H.)		1915-18	Withe	1 25	
6871BX	Torpedo top rib socket—upright—(L. H.)		1918-21	Wheede	1 25	
6872X	Torpedo top bow socket—front extension—(R. H.)		1915-18	Wizard	1 00	
6872BX	Torpedo top rib socket—front extension—(R. H.)		1918-21	Whelm	80	
6873X	Torpedo top bow socket—front extension—(L. H.)		1915-18	Witness	1 00	
6873BX	Torpedo top rib socket—front extension—(L. H.)		1918-21	Wherry	80	
4907X	Torpedo top bow socket—rear extension—(R. H.)		1913-18	Wolf	1 00	
4908X	Torpedo top bow socket—rear extension—(L. H.)		1918-21	Whestit	1 00	
4908BX	Torpedo top rib socket—rear extension—(L. H.)		1913-18	Woman	1 00	
6937X	Torpedo top side curtain—rear—(R. H.)		1918-21	Whewer	1 00	
6938X	Torpedo top side curtain—rear—(L. H.)		1915-21	Wood	2 00	MH
6935X	Torpedo top side curtain—front—(R. H.)		1915-21	Word	2 00	MH
6936X	Torpedo top side curtain—front—(L. H.)		1915-21	Work	2 50	MH
6950X	Torpedo top back curtain assembly		1915-21	World	2 50	MH
6965X	Torpedo top center deck complete		1915-21	Worm	3 00	MH
6964X	Torpedo top deck only		1915-21	Worry	6 00	MH
6962X	Torpedo top side quarter—(R. H.)		1915-21	Wrap	3 50	
6963X	Torpedo top side quarter—(L. H.)		1915-21	Wreck	1 25	
6806X	Torpedo top side quarter pad		1915-21	Wren	1 25	
3577X	Torpedo top prop rest with strap		1914-21	Wrist	1 00	
4955X	Torpedo top visor		1913-21	Yam	60	
			1920-21	Yamper	75	

\*Inquire of Branch or Dealer for price.

Of the net amount at which these parts are billed to purchasers who purchase direct from the Ford Motor Company (except parts which show no Tax Status, if any) 20/21 represents the price of the goods and 1/21 represents excise tax.

Insist upon genuine Ford parts

Insist upon genuine Ford parts

# Price List of Parts for Model T One Ton Truck

Part No.	Name of Part	Year	Price	Tax Status	Code Word	Model	Fac. No.	Req. per Car
<b>REAR AXLE</b>								
1000	Rear axle assembly	1913-21	\$200 00	MH.	Abed	TT	95	1
1001	Axle housing—right	1918-21	20 00	MH.	Abyss.	TT	14	4
1002	Axle housing—left	1918-21	20 00	MH.	Acme	TT	5	1
1003	Axle housing bolt	1918-21	04		Avail	TT	52	13
1003B	Axle housing bolt nut Used on 1003	1918-21	03		Bashful	TT	T220	13
1004	Axle housing cap	1918-21	60	MH.	Actor	TT	133	1
1005	Axle housing cap gasket	1918-21	02		Acute	TT	134	1
1006	Axle housing cap screw	1918-21	95		Adder	TT	72	4
1007	Axle housing cap screw lock wire	1918-21	02		Addle	TT	140	1
1008	Axle housing gasket—upper	1918-21	02		Agate	TT	138	1
1009	Axle housing gasket—lower	1918-21	06		Agast	TT	139	1
1010	Axle brake housing plate—right	1918-21	50	MH.	Agile	TT	147	1
1011	Axle brake housing plate—left	1918-21	50	MH.	Akin	TT	148	1
1012	Axle housing drain plug	1918-21	05		Alder	TT	136	2
1013	Axle shaft and nut	1918-21	6 00	MH.	Alex	TT	48	2
1014	Axle shaft cotter	1918-21	01		Alms	TT	165	2
1015	Axle shaft nut	1918-21	15		Aloe	TT	166	2
1016	Axle shaft washer	1918-21	05		Aloft	TT	135	2
1017	Axle shaft dust cap	1918-21	05		Alpha	TT	56	2
1018	Axle shaft inner ball bearing assembly	1918-21	6 50		Alpine	TT	125	2
1019	Axle shaft outer roller bearing	1918-21	1 75		Archer	TT	171	2
1020	Axle shaft outer roller bearing sleeve	1918-21	60		Argua	TT	170	2
1021	Axle shaft bearing felt	1918-21	10		Argue	TT	143	4
1022	Axle shaft bearing retainer	1918-21	10		Ark	TT	20	2
1023	Axle shaft bearing retainer washer	1918-21	05		Arre	TT	23	2
1024	Axle shaft felt retainer assembly	1918-21	15		Astral	TT	144	2
1025	Axle shaft felt retainer cup	1918-21	05		Atwist	TT	145	2
1026	Axle shaft felt retainer plate	1918-21	03		Atoll	TT	146	2
1027	Diff. gear	1918-21	2 00	MH.	Aura	TT	13	2
1028	Diff. gear case R. or L. half	1918-21	2 50	MH.	Author	TT	11	2
1029	Diff. gear case bolt	1918-21	05		Avail	TT	52	8
1031	Diff. gear lock ring	1918-21	05		Avoke	TT	118	2
1032	Diff. pinion	1918-21	80	MH.	Awake	TT	14	2
1033	Diff. pinion shaft	1918-21	30		Awry	TT	15	1
1034	Drive shaft	1918-21	10 00	MH.	Bait	TT	87	1
1036	D. S. tube assembly	1918-21	15 00	MH.	Balm	TT	153	1
1037	D. S. tube flange gasket	1918-21	02		Bandit	TT	194	1
1038	D. S. tube flange screw Order 1006	1918-21	10		Basil	TT	109	1
1039	D. S. felt	1918-21	05		Beaver	TT	110	1
1040	D. S. felt container	1918-21	1 20		Behind	TT	85	1
1041A	D. S. to worm coupling	1918-19	1 20		Bhang	TT	85B	1
1041B	D. S. to worm coupling	1920-21	1 20		Bhang	TT	85B	1
1042	D. S. to worm coupling pin	1918-21	03		Behold	TT	86	2
1043	Worm	1918-21	15 00	MH.	Berg	TT	16	1
1043B	Worm—5 1/8 to 1	1918-21	15 00	MH.	Bernese	TT	16B	1
1044	Worm gear	1918-21	16 00	MH.	Bible	TT	12	1
1044B	Worm gear—5 1/8 to 1	1918-21	16 00	MH.	Biflar	TT	12B	1
1045	Worm cotter Order 1014	1918-21	1 30		Bight	TT	108	2
1046	Worm roller bearing	1918-21	05		Bigot	TT	106	1
1047	Worm roller bearing retainer	1918-21	2 00		Bilog	TT	107	2
1048	Worm roller bearing sleeve	1918-21	05		Birch	TT	101	2
1049	Worm roller bearing housing screw	1918-21	1 20		Bird	TT	114	2
1050	Worm thrust bearing collar	1918-21	1 25		Bitter	TT	123	1
1051	Worm thrust ball and separator assembly	1918-21	15		Blaze	TT	22	1
1052	Worm thrust bearing plate	1918-21	40		Bleach	TT	111	1
1053	Worm thrust bearing retainer	1918-21	03		Blend	TT	112	1
1054	Worm thrust bearing retainer nut Order 1015	1918-21	2 50	MH.	Blind	TT	2814	2
1055	Worm thrust bearing retainer pin	1918-21	40	MH.	Blink	TT	58	4
1056	Brake shoe	1918-21	dz.05		Blue	TT	68	40
1057	Brake shoe lining, each	1918-21	10		Blunt	TT	67	2
1058	Brake shoe lining rivet	1918-21	15		Scion	TT	59	2
1059	Brake shoe spring	1918-21	10		Bengal	TT	T242	2
1060	Brake shoe bolt	1918-21	60		Bodkin	TT	61	2
1060B	Brake shoe bolt nut Used on 1060	1918-21	20		Booth	TT	62	2
1061	Brake expander	1918-21	25		Bright	TT	175	2
1062	Brake expander lever	1918-21	15		Bronze	TT	173	2
1064	Brake expander adjustment collar	1918-21	01		Brook	TT	7	2
1065	Brake expander bushing	1918-21	08		Broom	TT	176	4
1066	Brake expander pin	1918-21	05		Brow	TT	177	8
1067	Brake expander link	1918-21	50	MH.	Brush	TT	119	2
1068	Brake expander link pin	1918-21	10		Buck	TT	120	1
1069	Brake rod	1918-21	10		Bug	TT	121	1
1070	Brake rod support—right	1918-21	03		Serene	TT	1308	2
1071	Brake rod support—left	1918-21	02		Missive	TT	T1309	2
1072	Brake rod support bolt	1918-21	6 00		Burn	TT	152	2
1072B	Brake rod support bolt nut Used on 1072	1918-21	20		Acclaim	TT	84	1
1073	Rear radius rod	1918-21	15		Abscind	TT	83	4
1074	Rear radius rod bolt—front	1918-21	10		Bengal	TT	T242	1
1075	Rear radius rod bolt—rear	1918-21	50		Crape	TT	69	1
1075B	Rear radius rod bolt nut Used on 1074 & 1075	1918-21	10					
1076	Universal joint bushing	1918-21	50					

Of the net amount at which these parts are billed to purchasers who purchase direct from the Ford Motor Company (except parts which show no Tax Status, if any) 20/21 represents the price of the goods and 1/21 represents excise tax.

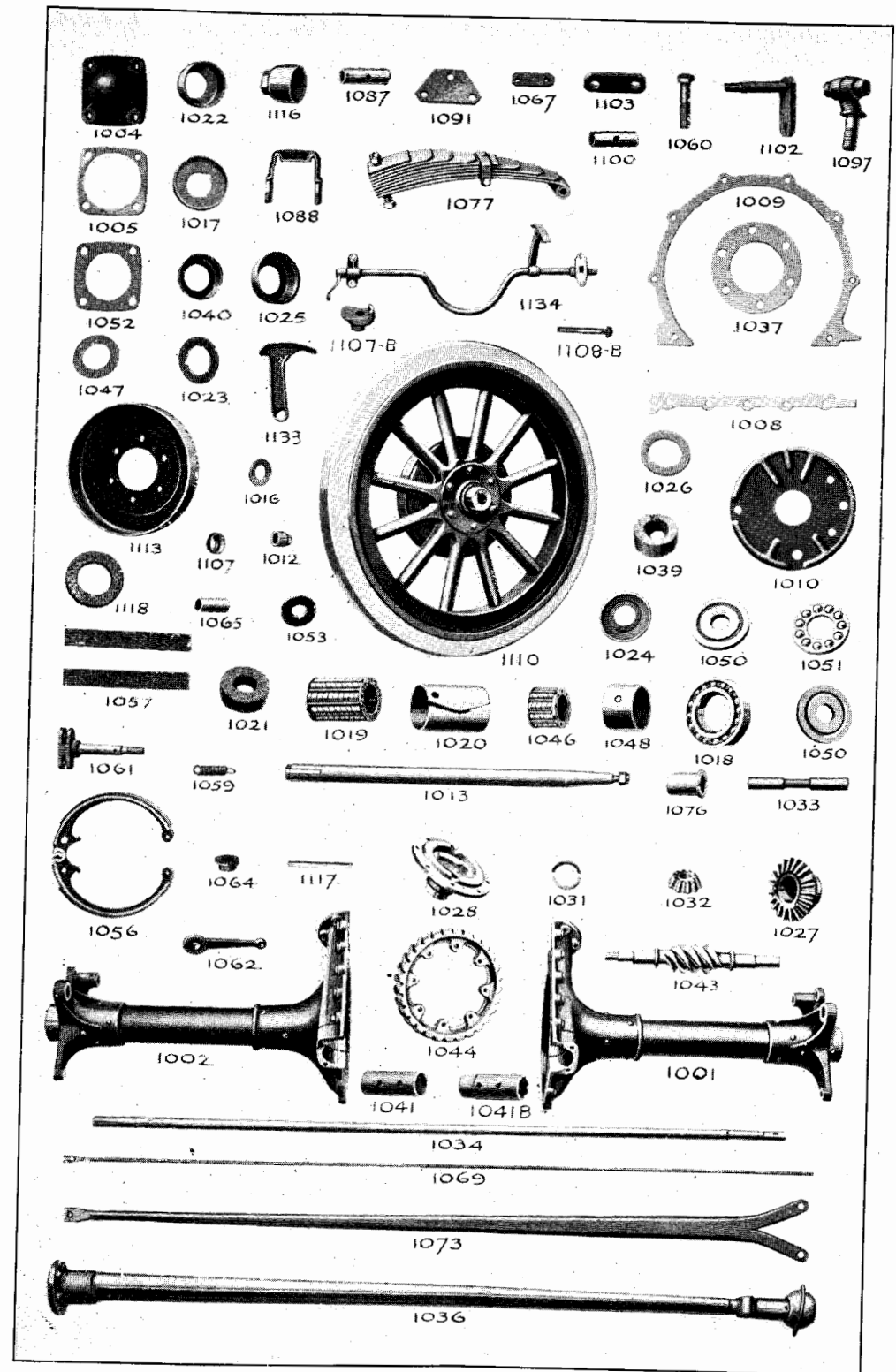

**Insist upon genuine Ford parts**

Part No.	Name of Part	Year	Price	Tax Status	Code Word	Model	Fac. No.	Req. per Car
<b>SPRING</b>								
1077	Rear spring—right or left, each	1918-21	\$ 6 00		MH. Cream	TT	333	2
1078	Spring leaf No. 1	1918-21	1 20		Creed	TT	334	2
1079	Spring leaf No. 2	1918-21	75		Crew	TT	362	2
1080	Spring leaf No. 3	1918-21	70		Crib	TT	363	2
1081	Spring leaf No. 4	1918-21	60		Crlsp	TT	364	2
1082	Spring leaf No. 5	1918-21	55		Croak	TT	365	2
1083	Spring leaf No. 6	1918-21	50		Crop	TT	366	2
1084	Spring leaf No. 7	1918-21	45		Croup	TT	367	2
1085	Spring leaf No. 8	1918-21	40		Crow	TT	368	2
1086	Spring leaf No. 9	1918-21	35		Crowd	TT	331	2
1087	Spring bushing	1918-21	20		Crumb	TT	332	2
1088	Spring clip	1918-21	45		Crusher	TT	326	2
1089	Spring clip nut	1918-21	15		Cry	TT	327	4
1091	Spring clip plate	1918-21	25		Cuff	TT	329	2
1092	Spring tie bolt	1918-21	35		Cult	TT	330	2
1093	Spring tie bolt nut. Order 1089	1918-21						
1094	Spring tie bolt cotter	1918-21	01		Cure	TT	328	2
1095	Spring clamp	1918-21	10		Curl	TT	375	2
1096	Spring clamp bolt	1918-21	04		Curse	TT	376	2
1096B	Spring clamp bolt nut Used on 1096	1918-21	02		Harrow		T926	2
1097	Spring perch	1918-21	1 00		MH. Dale	TT	2804	2
1098	Spring perch nut. Order 1015	1918-21						
1099	Spring perch cotter. Order 1014	1918-21						
1100	Spring perch bushing	1918-21	30		Demon	TT	172	2
1101	Spring perch bushing spacer	1918-21	05		Dean	TT	169	4
1102	Spring hanger assembly	1918-21	40		Dike	TT	91	4

**WHEELS**

1105B	Rear wheel complete (less tire) dem. Kelsey	Old No. 1109B	1919-21	25 00		Duelist	TT	7698	2
1105C	Rear wheel complete (less tire) dem. Hayes	Old No. 1109B	1919-21	25 00		Dulcant	TT	7698B	2
1106B	Dem. rim only—Kelsey	Old No. 1109C	1919-21	5 50		Duke	TT	8774	2
1106C	Dem. rim only—Hayes	Old No. 1109C	1919-21	5 50		Dumal	TT	8774B	2
1107B	Clamp and nut assembly—Kelsey	Old No. 1109D	1919-21	20		Duledge	TT	8807	12
1108B	Clamp bolt	Old No. 1109E	1919-21	10		Dullish	TT	8832	12
1109	Rear wheel complete, less tire		1918-20	18 00		Duel	TT	99	2
1110	Rear wheel complete, with solid tire		1918-20			Drone	TT	7645	2
1111	Rear hub		1918-21	4 00		Dumb	TT	40	2
1112	Rear hub flange		1918-21	60		Dusk	TT	149	2
1113	Rear hub brake drum		1918-21	2 00		Dutch	TT	3	2
1114	Rear hub bolt		1918-21	05		Dwarf	TT	28	12
1114B	Rear hub bolt nut Used on 1114		1918-21	03		Durity	TT	29	12
1116	Rear hub cap		1918-21	35		Dyke	TT	150	2
1117	Rear hub key		1918-21	05		Ear	TT	26	2
1118	Rear hub felt		1918-21	05		East	TT	162	2

**FRAME**

1119	Frame assembly		1918-21	30 00		MH. Eat	TT	300	1
1120	Side member—right		1918-21	10 00		Ebb	TT	301	1
1121	Side member—left		1918-21	10 00		Fish	TT	302	1
1122	Front cross member		1918-21	1 50		Flirt	TT	303	1
1123	Rear cross member		1918-21	4 50		Flock	TT	304	1
1124	Front corner bracket—right		1918-21	20		Frost	TT	305	1
1125	Front corner bracket—left		1918-21	20		Froth	TT	306	1
1125B	Front end spacer—right		1918-21	15		Fruitage	TT	319	1
1125C	Front end spacer—left		1918-21	15		Fruitful	TT	318	1
1126	Rear cross member gusset plate		1918-21	25		Ghost	TT	307	2

**TRANSMISSION CONTROL**

1133	Speed lever		1918-21	10		Hoe	TT	862	1
1134	Controller shaft with speed lever		1918-21	75		MH. Hod	TT	1557	1

Of the net amount at which these parts are billed to purchasers who purchase direct from the Ford Motor Company (except parts which show no Tax Status, if any) 20/21 represents the price of the goods and 1/21 represents excise tax.

**Insist upon genuine Ford parts**

Ford Form 1932 5-21-100M

