

Ford

THE UNIVERSAL CAR

**Price List of Parts
and Accessories**

MODEL T

Effective November 1, 1921

Ford Motor Company

DETROIT, MICHIGAN

November 1st, 1921

Prices subject to change without notice

Of the net amount at which these parts are billed to purchasers who purchase direct from the Ford Motor Company (except parts which show no Tax Status, if any) 20/21 represents the price of the goods and 1/21 represents excise tax.

IMPORTANT

INSIST on getting **GENUINE** Ford Parts when your Ford car needs repairing. Don't allow "bogus" or imitation Parts to go in your car.

Ford Motor Company

FORD FACTORIES AND BRANCHES

Ford Factory, Detroit—*Parent Plant*
Ford Factory, Ford, Ontario, Canada
Ford Factory, Manchester, England

AMERICAN WHOLESALE BRANCHES

Atlanta	Cleveland	Fargo	Los Angeles	Oklahoma City	Salt Lake City
Buffalo	Columbus	Houston	Louisville	Omaha	San Francisco
Cambridge	Dallas	Indianapolis	Memphis	Philadelphia	Scranton
Charlotte	Denver	Jacksonville	Milwaukee	Pittsburgh	Seattle
Chicago	Des Moines	Kansas City, Mo.	Minneapolis	Portland	Washington
Cincinnati	Detroit	Kearney, N. J.	New Orleans	St. Louis	

FOREIGN BRANCHES AND SERVICE STATIONS

Bordeaux, France	Copenhagen, Denmark	Montevideo, Uruguay	St. John, N. B.
Buenos Aires, Argentina	London, Eng.	Montreal, Que.	Toronto, Ont.
Cadiz, Spain	London, Ontario	Regina, Sask.	Vancouver, B. C.
Calgary, Alta.	Manchester, Eng.	San Paulo, Brazil	Winnipeg, Manitoba

Foreign Department—1710 Broadway, New York
There are Ford Agents in all Principal Cities

Instructions for Ordering Parts

- 1—Order all parts through the nearest Branch or Dealer.
- 2—Always give **Catalog Number** and **Name** of each part ordered.
- 3—Mail and Parcel Post orders must be accompanied by an amount sufficient to cover **Postage**.
- 4—All prices are net f. o. b. Branch, Factory or Dealer.
- 5—Specify how shipments are to be made.
- 6—Orders for parts should be written separately from correspondence pertaining to other matters.

Telegraph Code

To save expense, to expedite ordering and for your convenience, we have arranged a code word for each part of the Ford Model T car. In addition, we list below a brief General Code covering miscellaneous instructions, questions and answers relative to the shipment of parts.

Toperig—Ship to me (us) by express.

Toperkleur—Ship by express to _____

Topersteen—Ship to me (us) by freight.

Toper—Ship to me (us) by parcel post.

Topfton—When and how did you ship parts called for in my (our) telegram of _____

Topflutch—When and how will you ship parts called for in my (our) telegram of _____

Topfwasser—When and how will you ship parts called for in my (our) letter of _____

Parts Price List Index

	Page
Ammeter	30
Axle—Front	7
Axle—Rear	5
Battery Bracket and Parts	31
Bendix Drive	30
Body Parts	21
Carburetor	26
Carburetor Attachments	27
Coil and Parts—Spark	30
Commutator	16
Cotter Pins	32
Cut-outs	30
Fan	24
Fenders	27
Frame	9
Gasoline Tank	9
Generator and Parts	31
Hood	26
Horn	33
Lamps	33
Magneto	16
Motor	12
Muffler	26
Radiator—Thermo Syphon	24
Running Board and Shields	27
Spark Plugs	31
Springs	23
Starter Parts	30
Starting Crank	24
Steering Gear	19
Switch	30
Tools	32
Tops	35
Transmission	16
Transmission Control	17
Transmission Cover	17
Truck Parts	37
Wheels	9
Windshields	33
Wiring	30

PRICE LIST OF PARTS

FORD MODEL T 1909-1921

EFFECTIVE NOVEMBER 1st, 1921

Part No.	Name of Part	Year	Specifications	Price	Tax Status	Code Word	Fac. No.	No. per Car	Req. per Car
REAR AXLE									
2500	Rear axle assembly	1909-21	.50-inch tread	\$70 00	MH	Aband	95E	1	1
2501	Axle housing—right	1915-21		9 00	MH	Abslove	7635C	1	1
2502	Axle housing—left	1915-21		9 00	MH	Absume	7636C	1	1
*2503E	Axle housing bolt	1913-21	$\frac{3}{8}$ " x $1\frac{1}{2}$ "	03		Ajoy	2854	7	7
*2503F	Axle housing bolt nut	1909-21	Used on 2503E	02		Doric	44	7	7
*2504	Rear axle case gasket	1919-21		03		Abraum	139	1	1
2505	Axle shaft—tapered	1912-21	$1\frac{1}{2}$ " x $31\frac{1}{2}$ "	1 60	MH	Abode	2818	2	2
*2506	Axle shaft washer	1909-21	$1\frac{1}{2}$ " dia. fibre	03		Abound	39	1	1
2508	Axle shaft roller bearing	1909-21	$2\frac{1}{4}$ " x 4"	1 25		Abraise	253	4	4
2509	Axle shaft roller bearing sleeve—right	1909-21	4' long	25		Abray	170	2	2
2509B	Axle shaft roller bearing sleeve—left	1909-21		25		Abate	161	2	2
*2510	Axle housing cap	1909-19	$2\frac{1}{2}$ " dia.	05		Abroad	56	2	2
*2510 $\frac{1}{2}$	Axle housing cap	1919-21		05		Abridge	56B	2	2
*2510A	Axle outer roller bearing steel washer	1909-21	$2\frac{1}{2}$ " dia.	03		Absinthe	199B	2	2
*2510B	Axle outer roller bearing felt washer	1909-21	$2\frac{1}{2}$ " dia.	05		Abasist	54	2	2
2512C	Diff. case—left (no bushing used)	1914-21		1 50	MH	Abut	84	1	1
2513C	Diff. case—right (no bushing used)	1914-21		90	MH	Ache	81	1	1
2514	Diff. case stud	1909-15	$\frac{3}{8}$ " x $2\frac{3}{4}$ "	05		Arcadian	52	3	3
*2514B	Diff. case stud	1915-21	$\frac{3}{8}$ " x $2\frac{3}{4}$ "	05		Ale	2865	3	3
*2515	Diff. case stud nut	1909-21	Used on 2514-2514B	03		Egret	8	3	3
2518	Diff. drive gear	1909-21	40 teeth	3 00	MH	Accost	12B	1	1
*2519	Diff. drive gear screw	1909-21	$\frac{1}{2}$ " x $\frac{1}{2}$ "	03		Accoy	103	10	10
*2519A	Diff. gear lock ring	1909-21		03		Acetic	118	2	2
2520B	Diff. gear	1909-21	24 teeth	1 25	MH	Ace	13B	2	2
2521B	Diff. gear key	1911-21	$1\frac{1}{2}$ " long	05		Acrid	137	2	2
2524C	Diff. pinion	1915-21	12 teeth	35	MH	Admirer	14D	3	3
2526B	Diff. spider	1909-21		80	MH	Adduce	15D	1	1
2528	Diff. thrust washer	1909-21	$3\frac{3}{8}$ " dia. metal	15		Adieu	30	2	2
*2529	Diff. thrust plate	1909-21	$3\frac{3}{8}$ " dia. steel	15	MH	Adjoin	31	4	4
*2530	Diff. thrust plate pin	1909-16	$\frac{1}{2}$ " long	03		Admix	17	4	4
*2531	Diff. thrust plate pin	1909-16	$\frac{1}{2}$ " long	03		Adgase	37	2	2
*2531B	Diff. thrust plate pin	1917-21		03		Age	7640	6	6
2532	Diff. housing oil plug	1909-21	$\frac{3}{4}$ " x 24 thds.	05		Agger	817	1	1
*2545	Rear axle grease cup	1909-21		10		Ajar	76	2	2
2547	Rear radius rod	1909-21		2 50		Alcar	152	2	2
*2548	Radius rod nut	1909-21	$\frac{1}{2}$ " x 18 thds.	05		Amass	77	2	2
2549	Radius rod lock nut	1909-21	$\frac{1}{2}$ " x 18 thds.	05		Amber	78	2	2
*2550	Radius rod lock washer	1909-21	$\frac{1}{2}$ "	02		Ambush	2823	2	2
*2551	Radius rod bolt	1909-21	$\frac{1}{2}$ " x $1\frac{1}{2}$ "	05		Ampite	83	4	4
*2551B	Radius rod bolt nut	1909-21	Used on 2551	05		Armor	60	4	4
2557	Hub cam shaft—right	1909-21	$3\frac{1}{2}$ " long	20		Amuck	94B	1	1
2558	Hub cam shaft—left	1909-21	$3\frac{1}{2}$ " long	20		Anchor	61B	1	1
2559	Hub cam shaft bushing	1909-21	$\frac{1}{2}$ " bore, $\frac{1}{2}$ " dia.	10		Ancient	173	2	2
2562	Cam shaft lever	1909-21	$\frac{1}{2}$ " bore	15		Arab	62	2	2
*2563	Cam shaft lever pin	1909-21	$\frac{1}{2}$ " x $\frac{1}{2}$ "	03		Arbor	7	4	4
*2564	Lever clevis pin	1909-21	$\frac{1}{2}$ " x 1"	03		Arcade	65	4	4
2566	Hub brake shoe	1909-21	Cast iron	35	MH	Arctic	2814	2	2
*2567	Brake shoe support bolt	1909-21	$\frac{1}{2}$ " x $1\frac{1}{2}$ "	05		Argus	59	2	2
*2568	Brake shoe support nut	1909-21	$\frac{1}{2}$ " x 20 thds. (Used on T2567)	05		Armor	60	2	2
*2570B	Brake shoe coil spring	1913-21	$3\frac{3}{8}$ " long	03		Asug	2862	4	4
2571	UNIVERSAL JOINT ASSEMBLY	1909-21		2 00		Ashore	151B	1	1
2572	Joint knuckle (male)	1909-21		60		Ashust	45B	1	1
2573	Joint knuckle (female)	1909-21		70		Askew	46B	1	1
*2574	Joint knuckle pin	1909-21	$\frac{1}{2}$ " x $1\frac{1}{2}$ "	02		Asleep	6	1	1
2575	Joint ring, complete	1909-21	$3\frac{1}{2}$ " dia.	60		Astert	49B	1	1
*2576	Joint ring rivets (per set)	1909-21	$\frac{1}{4}$ " x $1\frac{1}{2}$ "	05		Atche	50	4	4
2577	Joint housing	1909-14	$4\frac{1}{2}$ " long	1 50		Atlas	70	1	1
2577B	Univ. joint housing	1914-21		1 50		Atoll	7609	1	1
*2578	Joint housing plug	1909-21	$\frac{1}{2}$ " x 20 thds.	05		Atom	75	2	2
2579	Ball joint grease cup	1909-21	$\frac{1}{4}$ " pipe thds.	15		Attic	195	1	1
*2580	Ball cap gasket	1909-21		05		Auburn	1518	1	1
2581	Drive shaft housing front bushing	1909-21	(1" bore), babbitt. Old No. 2540.	30		Balkish	69	1	1
2582	D. S. tubing	1911-21	50% long	8 00	MH	Ballad	153B	1	1
†2583B	D. S. bearing housing	1920-21	Forging	2 00	MH	Ballace	191C	1	1
2584B	D. S. roller bearing cap screw	1912-21	$\frac{1}{2}$ " x $4\frac{1}{2}$ "	05		Balneal	183B	6	6
*2584C	D. S. roller bearing stud nut	1912-21		05		Feast	184R	6	6

*For prices in quantities see special list to Dealers and Garages.

†When ordered to replace malleable type housing also order 2589C.

Of the net amount at which these parts are billed to purchasers who purchase direct from the Ford Motor Company (except parts which show no Tax Status, if any) 20/21 represents the price of the goods and 1/21 represents excise tax.

Insist upon genuine Ford parts

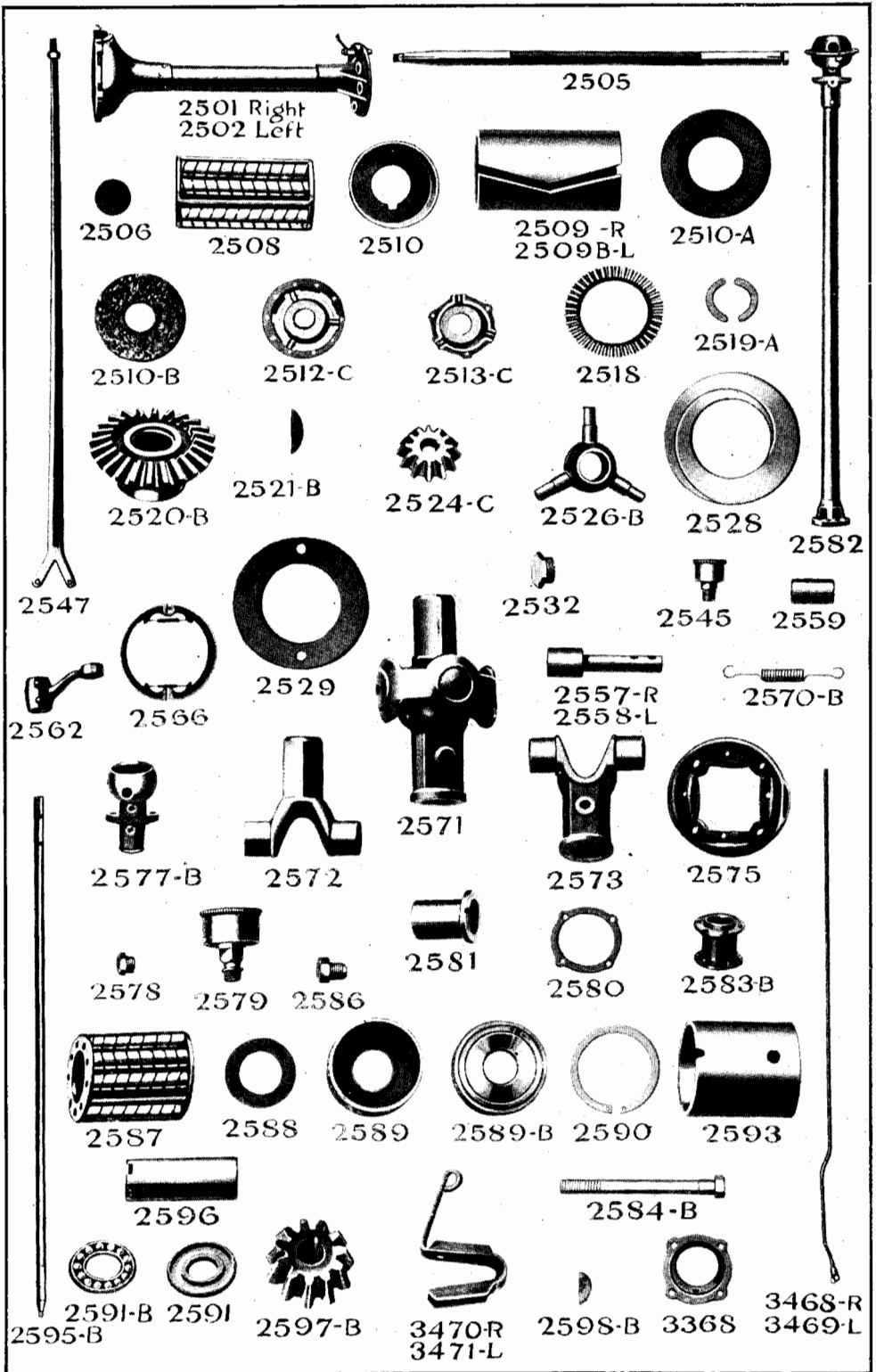

Plate No. 1

Part No.	Name of Part	Year	Specifications	Price	Tax Status	Code Word	Fac. No.	No. per Car	Req.
REAR AXLE—Continued									
2584D	D. S. roller bearing cap screw lock washer	1912-21	per doz.	\$0 05		Balnary	157	6	0
*2586	D. S. roller bearing housing set screw	1911-21	1/2" x 20 thds.	05		Banco	101R	1	1
2587	D. S. roller bearing	1911-21	2 5/8" long	1 25		Balsam	108	1	1
*2588	D. S. roller bearing distance plate	1911-21	2 1/4" dia.	05	MH	Bandlet	106R	1	1
2589	D. S. ball race	1911-21	2 5/8" dia.	35		Bandon	186R	1	1
2589B	D. S. ball bearing assembly	1911-21		1 00		Bander	185AR	1	1
2589C	D. S. thrust bearing assy	1920-21		75		Bane	185B	1	1
*2590	D. S. ball retainer	1911-21	2 1/4" dia.	03		Bandroe	190AR	1	1
2591	D. S. ball thrust collar	1911-21	2 1/4" dia.	25		Bandault	188	2	2
2591B	D. S. thrust balland retainer assembly	1920-21		25		Bandala	162	1	1
2592	D. S. ball bearings, each	1911-21	Order 2811						
2593	D. S. roller bearing sleeve	1911-21	2 5/8" dia., 2 7/8" long	1 70		Bangle	107R	1	1
2595B	D. S. only (tapered)	1911-21	1 1/2" x 53 1/4"	3 50	MH	Banjo	87D	1	1
2596	D. S. sleeve	1911-21	1" bore, 3 1/4" long	1 00		Banshee	163B	1	1
2597B	D. S. pinion	1911-21	Taper bore, 11 teeth	1 25	MH	Banewort	16C	1	1
2597C	D. S. pinion	1911-21	Taper bore, 10 teeth	1 25	MH	Banneret	16D	1	1
2598	D. S. castle nut	1911-21	5/8" x 18 thds.	05		Banket	124	1	1
*2598B	D. S. pinion key	1911-21		05		Banker	57B	1	1
REAR AXLE—60 INCH TREAD									
2600C	Rear axle housing—right	1915-16	Dia. of bell 9 3/4"	12 00	MH	Bang	2728C	1	1
2601C	Rear axle housing—left	1915-16	Dia. of bell 9 3/4"	12 00	MH	Bard	2729C	1	1
2602B	Rear axle shaft—tapered	1911-16	1 1/2" x 33 1/2"	3 00	MH	Baptism	2725	2	2
2604	Rear radius rod	1909-16	.53 3/8" tube only	2 00		Barbett	1726	2	2
FRONT AXLE									
2691	Front axle only	1909-21	.56" tread	10 00	MH	Barber	202B	1	1
2694B	Spindle body—right	1911-21	Less cones and washer	1 50	MH	Barbican	280	1	1
2695B	Spindle body—left	1911-21	Less cones and washer	1 50	MH	Barbiton	281	1	1
2696	Spindle arm—right or left	1911-19	Less cones and washer	60	MH	Barbism	7716	2	2
2696C	Spindle arm—right	1919-21		60	MH	Bard	7715B	1	1
2696D	Spindle arm—left	1919-21		60	MH	Barry	7716B	1	1
2697	Spindle arm nut	1911-21	Order 2548						
2702	Spindle assembly—right	1909-10		2 00	MH	Barkate	203A	1	1
2703	Spindle assembly—left	1909-10		2 00	MH	Barker	204A	1	1
2704	Stationary cone	1909-21	1 1/8" bore	20		Barkless	205	2	2
2705	Adjusting cone—right thread	1909-21	3/4" x 16 thds., R. T.	20		Barley	206	1	1
2706	Adjusting cone—left thread	1909-21	3/4" x 16 thds., L. T.	20		Barrack	287	1	1
*2707	Spindle nut—right thread	1909-21	3/4" x 16 R. H. thds.	10		Barrow	209B	1	1
*2708	Spindle nut—left thread	1909-21	3/4" x 16 L. H. thds.	10		Baron	208B	1	1
*2709	Spindle washer	1909-21	3/4" hole x 1 3/4" thds.	02		Barras	210	2	2
*2710	Spindle bolt with oiler	1910-21	1/2" x 6 3/4"	20		Barter	7708	2	2
2711	Spindle bolt nut	1909-21	Order 2568						
*2713	Spindle body bush (pair)	1909-21	1/2" bore	20		Bartram	223	2	2
*2714	Spindle arm bushing	1909-21	1/2" bore, 1 1/4" dia., 1" L.	05		Barwood	225	2	2
2715	Spindle oiler	1909-21	Order 3817						
2715B	Spindle bolt oiler assy.	1915-16		05		Beard	4081	2	2
*2715C	Spindle oiler	1917-18		05		Bilge	294	1	1
2715D	Spindle oiler	1919-21	Order 3176C						
2717	Spindle con. rod	1909-21	.46 3/4" long	2 50	MH	Basalt	264	1	1
*2718	Spindle con. rod bolt with oiler	1909-21	1 1/8" x 2 1/4"	15		Basan	7706	2	2
*2719	Spindle con. rod bolt nut	1909-21	1 1/8" x 20 thds.	03		Bashful	220	2	2
2721	Spindle con. rod yoke	1909-18	2 3/4" long	40		Bashule	248	1	1
2721B	Spindle con. rod yoke ball	1919-21		25		Baroko	226	1	1
†2721C	Spindle con. rod yoke	1919-21		50		Barse	248B	1	1
*2722	Steering yoke clamp bolt	1909-18		05		Era	79		
*2722B	Steering yoke clamp bolt nut	1909-18	Used on 2722	03		Egret	8		
2725B	Steering gear con. rod	1909-21	Includes ball sockets	1 00	MH	Baslard	289	1	1
2728	Ball socket cap	1909-21		12		Basent	254B	2	2
2729B	Ball socket bolt and nut	1909-21	Order 2722 & 2722B						
2733	Front radius rod	1909-19		2 50	MH	Beardless	263	1	1
2733B	Front radius rod	1919-21		2 50	MH	Bedazzle	263B	1	1
*2734	Front radius rod nut	1909-19	Order 2548						
2736	Front radius rod ball cap	1909-21		12		Beaufet	217	1	1
2737	Front radius rod ball socket	1911-21		25		Beckon	809B	1	1
*2741	Radius rod ball cap stud	1911-21		03		Plateau	4365	2	2
*2741B	Radius rod ball cap stud nut	1911-21	Used on 2741	03		Egret	8	2	2
*2742	Radius rod ball cap sprg	1911-21		03		Bicep	292	2	2
2760	FRONT AXLE ONLY	1911-16	60" tread	10 00	MH	Bechance	1720B	1	1
2761	Steering spindle con. rod	1909-16	60" tread	3 00	MH	Becket	1725	1	1
2762	Steering gear con. rod	1909-16	60" tread, includes ball sockets	1 25	MH	Becloud	2739	1	1

*For prices in quantities see special list to Dealers and Garages.
 †When substituting 2721C for old style yoke, also order 2721B Ball.

Of the net amount at which these parts are billed to purchasers who purchase direct from the Ford Motor Company (except parts which show no Tax Status, if any) 20/21 represents the price of the goods and 1/21 represents excise tax.

Insist upon genuine Ford parts

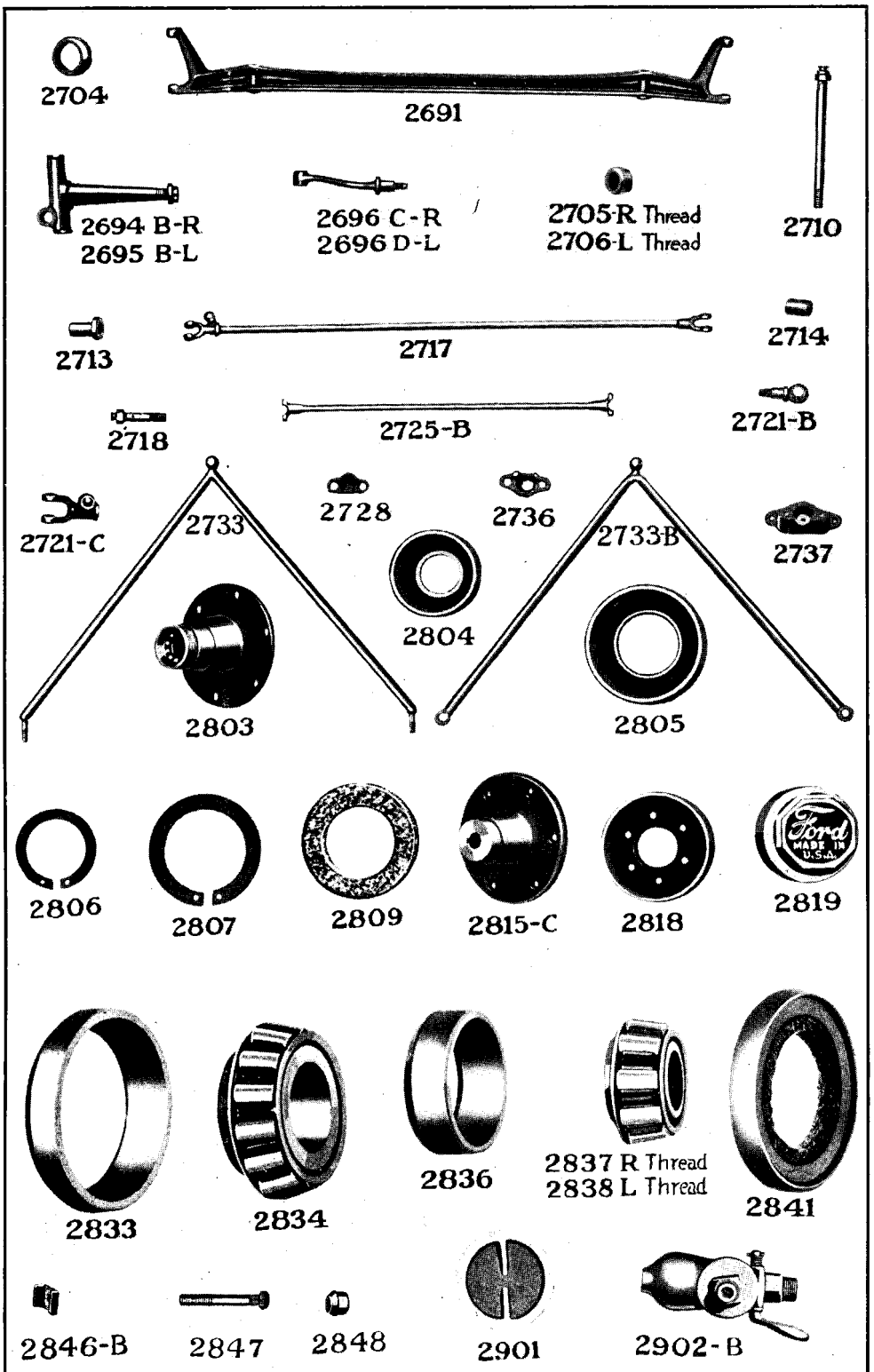

Part No.	Name of Part	Year	Specifications	Price	Tax Status	Code Word	Fac. No.	No. per Car	Req.
WHEELS									
2800	Front wheel	1909-21	.30" x 3"	\$10 00		Becomb	291B	2	
2800B	Front wheel—dem.	1919-21	Less rim and brgs., Kelsey	9 25		Baryton	291D	2	
2800C	Front wheel—dem.	1919-21	Less rim and brgs., Hayes	9 25		Basante	291E	2	
2800D	Front wheel—clincher— less hub	1909-21		7 25		Basaltine	295	2	
2800E	Front and rear wheel— dem.—less rim & hub	1919-21		6 50		Basilisk	293	4	
2801	Front wheel comp. R— Demountable	1919-21	Rim and Timken bearings included, Kelsey	14 00		Bereave	7697	1	
2801B	Front wheel comp. R— Demountable	1919-21	Rim and Timken bearings included, Hayes	14 00		Beseech	7697B	1	
2802	Front wheel comp. L— Demountable	1919-21	Rim and Timken bearings included, Kelsey	14 00		Behest	7697	1	
2802B	Front wheel comp. L— Demountable	1919-21	Rim and Timken bearings included, Hayes	14 00		Betoken	7697B	1	
2803	Front hub assembly less flange, bolts and nuts	1909-21	With ball bearings	2 00		Bedew	200	2	
2803B	Front hub with RB cups	1909-21		2 00		Bedouin	219	2	
2804	Outer race	1909-21	1 1/4" dia.	10		Bedere	234	2	
2805	Inner race	1909-21	2 1/4" dia.	20		Bedight	235	2	
*2806	Outer ball retainer	1909-21	1 1/4" dia.	02		Bedim	236	2	
*2807	Inner ball retainer	1909-21	2 1/4" dia.	03		Bedside	237	2	
*2808	Dust ring	1909-21	Steel, 2 1/4" dia.	05		Bedward	238	2	
*2809	Front and rear hub felt washer	1909-21	2 1/2" dia.	05		Bedje	239	4	
*2810	Large balls, each	1909-21	1 1/2"	04		Beefing	241	24	
*2811	Small balls, each	1909-21	3/8"	03		Beemol	249	22	
2814C	Rear wheel (taper hub)	1912-21	.30" x 3 1/2"	10 00		Beggah	2815	2	
2814D	Rear wheel—clincher— less hub	1909-21		7 50		Basifier	2816	2	
2814E	Rear wheel comp.—dem.	1919-21	Kelsey	12 00		Begin	7698	2	
2814F	Rear wheel comp.—dem.	1919-21	Hayes	12 00		Behoney	7698B	2	
2814G	Rear wheel—dem.	1919-21	Kelsey	9 25		Bashless	2815B	2	
2814H	Rear wheel—dem.	1919-21	Hayes	9 25		Basketry	2815C	2	
2815C	REAR HUB (TAPERED) less flange, bolts & nuts	1912-21		1 50	MH	Begol	2819	2	
*2816B	Rear hub key	1912-21	1/4" x 1/4" x 2 1/2"	03		Begloom	2863	2	
2818	Rear hub brake drum	1909-21	3" hole, 8" dia.	15		Beguller	3	2	
*2819	Hub cap	1909-21	2 1/2" x 2 1/2" thds.	50		Behave	7727	4	
*2825	Hub bolt	1911-21	3/8" x 2 1/2" x 16 thds.	03		Belay	28B	24	
*2825B	Hub bolt nut	1911-21	Used on 2825	03		Elk	29	24	
2827	Hub flange	1911-21	6" dia.	30		Bellow	233B	4	
*2828	Rear hub lock nut	1912-21	3/8" x 18 thds.	06		Bengal	242	2	
2833	Front hub bearing cup inner	1919-21		70		Benip	2955	2	
2834	Inside spindle cone and roller assembly	1919-21		1 10		Bent	205B	2	
2836	Front hub bearing cup outer	1919-21		60		Bepad	2956	2	
2837	Outside spindle cone and roller assembly—right thread	1919-21		75		Beplay	206B	1	
2838	Outside spindle cone and roller assembly—left thread	1919-21		75		Beplume	207B	1	
2841	Front hub dust capassy	1919-21		10		Besunk	350	2	
2845	Demountable rim only	1919-21	Kelsey	2 40		Bethrone	8774	4	
2845B	Demountable rim only	1919-21	Hayes	2 40		Bejape	8774B	4	
2846	Demountable rim clamp	1919-21	Kelsey	10		Betime	8831	16	
*2846B	Demountable rim clamp	1919-21	Kelsey	10		Betor	8831B	16	
2847	Demountable rim bolt	1919-21		05		Bewax	8832	16	
2848	Dem. rim bolt nut	1919-21	Hayes	05		Benison	8834B	16	
2848B	Dem. rim bolt nut	1919-21	Kelsey	05		Belabor	8834	16	
2849	Spare rim carrier	1919-21		2 75	MH	Belamy	8848-7510	1	
FRAME									
2850	Frame assembly	1909-21		13 00	MH	Belone	2916	1	
2851B	Side member—right	1914-21		4 00		Benign	2914	1	
2852B	Side member—left	1914-21		4 00		Berdash	2915	1	
2853	Front cross member	1909-21	22 3/4" long.	1 00		Beluga	303	1	
2854B	Rear cross member	1914-21		1 20		Bendiet	2913	1	
2855	Front corner bracket— right	1909-21		15		Benumb	305	1	
2856	Front corner bracket—left	1909-21		15		Bequest	306	1	
2857	Rear corner bracket— right	1909-21		15		Besiege	307	1	
2858	Rear corner bracket—left	1909-21		15		Bespawl	308	1	
2859	Frame front end spacer —left	1909-21		10		Benzoin	318B	1	
2860	Frame front end spacer —right	1909-21		10		Bestal	319B	1	
2863	Body bracket	1909-21	On frame	15		Bestow	344	4	
GASOLINE TANK									
2900B	Gas tank	1916-21	Sedan	7 00	MH	Binocle	7950	1	
2900C	Gasoline tank	1909-21	Elliptical	5 00	MH	Blacid	1303B	1	

*Fo: price: in quantities see special list to Dealers and Garages.

Of the net amount at which these parts are billed to purchasers who purchase direct from the Ford Motor Company (except parts which show no Tax Status, if any) 20/21 represents the price of the goods and 1/21 represents excise tax.

Insist upon genuine Ford parts



3001

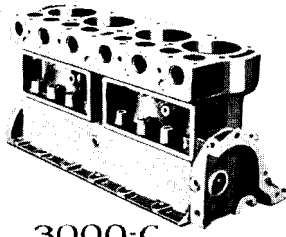

3000-C



3002



3009 B



3009-C



3017-B



3013



3017-D



3017



3084

3013-B

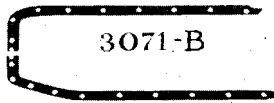

3071-B

3070-B



3085



3101 B

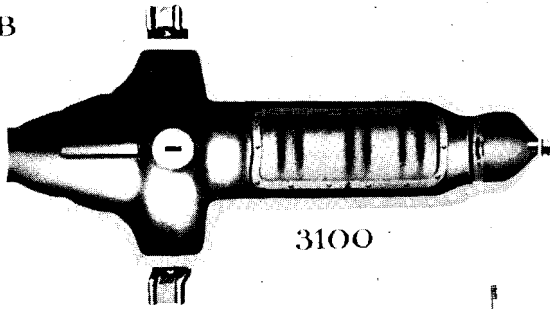

3100

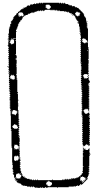

3102-B



3101



3110



3111-B



3112



3165



3163

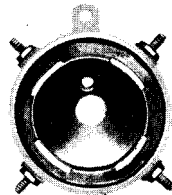

3221

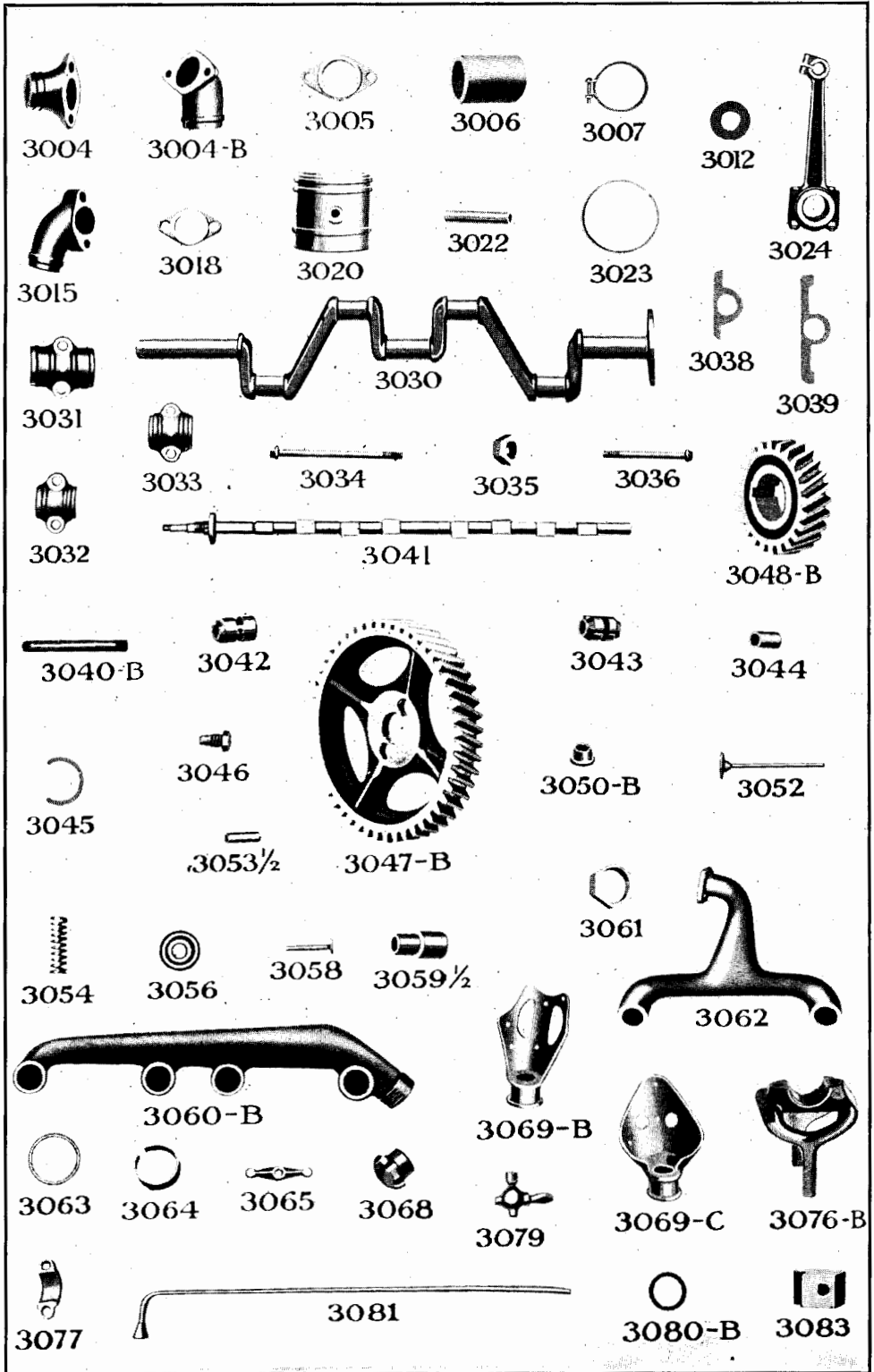

Part No.	Name of Part	Year	Specifications	Price	Tax Status	Code Word	Fac. No.	No. per Car	Req.
GASOLINE TANK—Continued									
*2901	Filling plug	1909-21	2 1/4"	\$ 0 10.		Biblist.	1317	1	1
2902B	Sediment bulb	1909-21	With pet cock	1 00.		Bickers	2088	1	1
2908	Pet cock	1909-21	Order 3079						
2909	Feed pipe	1909-21	Touring and Runabout, Also Coupe, 1915-17	25		Billet	1364	1	1
2909B	Feed pipe	1916-21	Sedan	30		Bismuth	7965		
2909C	Feed pipe	1918-19	Coupelet	50		Bisque	9775		
2909D	Feed pipe	1919-21	Coupe	40		Betray	8690	1	1
*2910	Feed pipe pack nut	1909-21	1/2" x 18 thds.	05		Billow	1374	2	2
2911	Feed pipe	1915	Sedan, 78" long	80		Betrap.	1394	1	1
2912	Sediment plug		Obsolete—Sub. with 3079						
2913	Feed pipe gasket	1909-21		02		Fester	5892		
2914	Gas tank support—R	1917-21		25		Bistort	2132	1	1
2914B	Gas tank support—R	1920-21	For elliptical tank	25		Bitume	2132B	1	1
2915	Gas tank support—L	1917-21		20		Bivous	2133	1	1
2915B	Gas tank support—L	1920-21	For elliptical tank	20		Bizarre	2133B	1	1
MOTOR									
x3000C	Cylinder	1909-21	Starter type	25 00.	MH.	Calcox	400D	1	1
x3000B	Cylinder (rebored)	1909-21	Starter type	15 00.	MH.	Calche	400E	1	1
3001	Cylinder head	1909-21		6 00.	MH.	Cabin	401C	1	1
*3002	Cyl. head gasket	1909-21		35	MH.	Caboose	402B	1	1
*3003	Cyl. head cap screw	1909-21	3/8" x 2 1/2"	05		Cackle	483B	15	15
*3003B	Cyl. head cap screw	1918-21	3/8" x 3 1/2"	05		Chub	483C		
3004	Cyl. head outlet connect.	1909-16	Cast iron	35	MH.	Caddow	446C	1	1
3004B	Cyl. head outlet connection	1917-21		35	MH.	Canls.	8719	1	1
*3005	Cyl. head outlet con. gasket	1909-21		05	MH.	Caddy	445B	1	1
3006	Cyl. head outlet hose	1909-21	2" x 4"	15		Cadet	448B	1	1
*3007	Cyl. head outlet hose clip	1909-21	2 3/8" dia.	05		Cadger	607B	2	2
*3008	Cyl. head outlet con. screw	1909-21	1/8" x 1 1/2"	05		Cadmean	550C	2	2
3009B	Cyl. front cover	1909-19		1 00.	MH.	Cage	690B	1	1
3009C	Cyl. front cover	1919-21	Starter type	1 00.	MH.	Canard	690C	1	1
3010	Cyl. cover bolt and nut	1909-21	3/8" x 1/2", Order 4808 & 4808D						
*3011	Cyl. cover cap screw	1909-21	3/8" x 1 1/2"	03		Cahoot	432	3	3
*3012	Cyl. cover felt	1909-21		05		Caitiff	504	1	1
*3013	Cyl. cover liner	1909-19	Paper	02		Cajole	505B	1	1
*3013B	Cyl. cover liner	1919-21	Paper—Starter type	03		Cajom	505C	1	1
3014	Cyl. cover and crank case bolt and nut	1909-21	3/8" x 1 1/2", Order 2722 & 2722B						
3015	Cyl. water inlet connection	1909-21	Cast iron	30	MH.	Calcine	442B	1	1
*3016	Cyl. inlet con. screw	1909-21	1/2" x 1 1/2"	05		Caldron	597	2	2
3017	Time gear cover	1919-21	Starter type	1 00.	MH.	Calico	1754	1	1
13017B	Time gear cover	1919-21		80	MH.	Callix	1769		
*3017C	Time gear cover gasket	1919-21	Old No. 4912	02		Candid	1775	1	1
3017D	Time gear cover plate	1919-21	Old No. 4922	05	MH.	Canine	1773	1	1
*3018	Cyl. water inlet gasket	1909-21	Copper	05	MH.	Calefy	596	1	1
3019	Cyl. water jacket plug	1909-13	1/2" pipe plug	05		Capin	557	3	3
3019B	Cyl. water jacket plug	1914-21		02		Canon	5919	3	3
3020	PISTON COMPLETE	1909-21	3 3/4" dia.	2 00.	MH.	Caliph	586C	4	4
3020C	PISTON COMPLETE	1909-21	.0025" oversize	2 00.	MH.	Canopy	683A	4	4
3020D	PISTON COMPLETE	1909-21	.03125" oversize	2 00.	MH.	Capon	683C	4	4
3020E	PISTON COMPLETE	1909-21	.033" oversize	2 00.	MH.	Churn	683B	4	4
3021	Piston only	1909-21	3 3/4" dia.	1 25.	MH.	Calious	418C	4	4
3021B	Piston only	1909-21	.0025" oversize	1 25.	MH.	Chopin	418DR	4	4
3021C	Piston only	1909-21	.03125" oversize	1 25.	MH.	Chord	418ER	4	4
3021D	Piston only	1909-21	.033" oversize	1 25.	MH.	Chute	418FR	4	4
3022	Piston pin	1909-21		30		Callot	419B	4	4
3022 1/2	Piston pin bushing (pair)	1909-21		25		Callow	668	4	4
*3023	Piston ring	1909-21	1 1/2" x 3 3/4"	15	MH.	Calmy	422C	12	12
*3023B	Piston ring	1909-21	.03125" oversize	15	MH.	Calf	422ER12		
*3023C	Piston ring	1909-21	.097" oversize	15	MH.	Caloric	422DR12		
*3023D	Piston ring	1909-21	.038" oversize	15	MH.	Caltrap	422FR12		
† 3024	CONNECTING ROD	1909-21	Includes bearings	1 50.	MH.	Calvish	641	4	4
*3025	Con. rod cap bolt	1909-21	3/8" x 2" x 24 thds.	05		Calyz	489B	8	8
*3026	Con. rod cap bolt nut	1909-21	Used on 3025	05		Camiou	490	8	8
*3029	Con. rod clamp screw	1909-21	3/8" x 1 1/2"	05		Cambrie	578	4	4
3030	CRANK SHAFT	1909-21	25 1/2" long	10 00.	MH.	Camel	498B	1	1
3031	C. S. rear bearing cap	1909-21	3 1/2" long, babbitted	50		Cameo	405AR	1	1
3032	C. S. front bearing cap	1909-21	1 1/2" long, babbitted	40		Camera	406A	1	1
3033	C. S. center bearing cap	1909-21	2 1/2" long, babbitted	40		Camlet	407B	1	1
3034	C.S. bearing bolt—center and front	1909-21	1/2" x 6 1/2" x 20 thds.	10		Camphor	408	4	4
*3035	C. S. bearing bolt nut	1909-21	Order 2568						
3036	C. S. rear bearing bolt	1909-21	1/2" x 4 1/2"	10		Candle	478	2	2
*3038	C.S. bearing liner—center and front	1909-21	1 1/4" long, brass	01		Cannon	502B	8	8
*3039	C. S. rear bearing liner	1909-21	3" long, brass	01		Canny	503B	4	4

*For prices in quantities see special list to Dealers and Garages.
 xWhen used on car not equipped with starter also order 3017B, 3017C, 3011, 3008 and 3016.
 †Used with 3000C cylinder on cars not equipped with starter.
 ††Connecting rods requiring new bearings will be exchanged at Branch or Factory for \$1.00 each.

Of the net amount at which these parts are billed to purchasers who purchase direct from the Ford Motor Company (except parts which show no Tax Status, if any) 20/21 represents the price of the goods and 1/21 represents excise tax.

Insist upon genuine Ford parts

Part No.	Name of Part	Year	Specifications	Price	Tax Status	Code Word	Fac. No.	No. per Car	Req.
MOTOR—Continued									
*3040	C. S. starting pin	1909-20	$\frac{3}{8}$ " x $2\frac{3}{4}$ "	\$0 05		Canoe	529B	1	
*3040B	C. S. starting pin	1920-21		05		Capable	529C	1	
3041	CAM SHAFT	1909-21		3 50	MH	Canteen	410	1	
3042	Cam shaft front bearing	1909-21	2" long	30		Canter	411	1	
3043	Camshaft center bearing	1909-21	$2\frac{1}{2}$ " long	30		Canthus	412B	1	
3044	Cam shaft rear bearing	1909-21	Bronze, $1\frac{1}{4}$ " long	15		Canto	413	1	
*3045	Cam shaft bearing ring	1909-21	$\frac{1}{4}$ " x $1\frac{1}{8}$ "	05		Canvas	534	2	
*3046	Camshaft bearing screw	1909-21	$\frac{1}{8}$ " x $\frac{3}{8}$ "	05		Capelin	414	2	
††3047B	Time gear—large (on cam shaft)	1909-21	Spiral	1 00	MII	Clang	415B	1	
†3048B	Time gear—small (on crank shaft)	1909-21	Spiral	75	MH	Claret	416B	1	
*3049	Cam shaft gear dowel pin	1909-21	$\frac{3}{8}$ " x $\frac{1}{8}$ "	05		Capra	417	2	
3050B	Cam shaft gear lock nut	1909-21		15		Captive	4453	1	
*3051	Small time gear key	1909-21		05		Capsize	477	1	
3052	Valve	1909-21	Exhaust and inlet	13		Capstan	424	8	
3052B	Valve	1909-21	$\frac{1}{4}$ " oversize stem	15		Cake	5913	8	
3053 $\frac{1}{2}$	Valve bushing	1909-21	$\frac{3}{8}$ " O. D. x 2" long	30		Captain	428	8	
3054	Valve spring	1909-21		05		Capture	431	8	
*3056	Valve spring seat	1909-21	$1\frac{1}{8}$ " dia. Per Set of 8	05		Carack	425	8	
*3057	Valve spring seat pin	1909-21	$\frac{1}{4}$ " x $\frac{11}{16}$ " Per Set of 8	05		Caranx	429	8	
*3058	Push rod	1909-21	$\frac{1}{8}$ " dia. $2\frac{1}{4}$ "	15	MH	Carat	426	8	
*3058B	Push rod	1909-21	$\frac{1}{4}$ " oversize stem	15	MH	Can tata	5914	8	
3059 $\frac{1}{2}$	Push rod bushing	1909-21	Iron	25		Chippy	427	8	
3060B	Exhaust manifold	1913-21	Iron	1 50	MII	Chirp	4483	1	
3061	Exhaust pipe pack nut	1909-21	$1\frac{7}{8}$ " x 18 thds.	20		Chitter	518	1	
3062	Inlet pipe	1909-21		1 30	MH	Chloris	512B	1	
*3063	Inlet and exh't pipe gasket	1909-21	$1\frac{1}{2}$ " O. D. copper	03	MH	Choker	513	6	
*3064	Inlet and exhaust pipe gland	1909-21	$1\frac{1}{4}$ " dia. iron	02		Chopper	514	6	
3065	Inlet and exhaust pipe clamp	1909-21	$2\frac{3}{4}$ " long	15	MII	Choral	515	4	
*3066	Inlet and exhaust clamp stud	1909-21	$\frac{3}{8}$ " x $3\frac{1}{4}$ "	05		Chorus	516	4	
*3066B	Inlet and exhaust clamp stud nut	1909-21	Used on 3066	03		Humbler	517	4	
3068	Breather pipe	1909-21	$1\frac{1}{8}$ " long	10	MH	Chuck	4468	1	
3069B	Crank case front end support	1911-17		1 00		Clam	801C	1	
3069C	Crank case front end support	1917-21		75		Clack	801D	1	
*3070B	Cr. case & cyl. gasket—left	1909-21	Cork	05		Clder	886	1	
*3071B	Cr. c. & cyl. gasket—right	1909-21	Cork	05		Cigar	887	1	
*3072	Crank case and cyl. cover cap screw	1909-21	$\frac{3}{8}$ " x 1"	03		Cinter	1388	2	
*3073	Crank case arm bolt—side	1909-21	$\frac{3}{8}$ " x $2\frac{1}{4}$ "	05		Grocer	479	2	
*3074	Crank case arm bolt—top	1909-21	$\frac{3}{8}$ " x $\frac{11}{16}$ "	05		Heath	940	2	
*3074B	Crank case arm bolt nut	1909-21	Used on 3073 & 3074	03		Egret	8		
†3076B	C. C. front bearing and spring clip	1921		1 25		Circean	320C	1	
*3076C	C. C. front bearing and spring clip nut	1921	Used on 3076B	05		Amass	77	2	
3077	Crank case front bearing cap	1909-21	Iron	20		Cizar	321	1	
*3078	Crank case front bearing screw	1909-21	$\frac{1}{4}$ " x $\frac{1}{4}$ "	05		Clabber	322	2	
*3078B	C. C. front bearing screw	1921	Order 3008						
3078C	C. C. front bearing lock washer	1921		01		Clachan	5636	2	
3079	Crank case oil cock	1909-21		15		Clamber	1515	2	
3080	Crank case drain cup plug	1909-21	Order 2532						
*3080B	Crank case drain cup plug gasket	1909-21		03	MH	Cliff	4339	1	
3081	Crank case oil tube	1909-21		25		Cleavast	543B	1	
3083	Crank case arm block	1909-21	Wood	05		Clergy	890	2	
*3083B	Crank case arm block	1918-21	Truck—Old No. 1127	05		Grape	TT890	2	
3084	Engine pan—right	1909-21		35	MH	Clicket	1330	1	
3085	Engine pan—left	1909-21		35	MH	Clientage	1331B	1	
*3088B	Engine pan and hood board bolt	1909-21	$\frac{1}{4}$ " x $3\frac{1}{4}$ "	03		Pitter	4074	2	
*3088C	Engine pan and hood board bolt	1909-21	$\frac{1}{4}$ " x $3\frac{3}{8}$ "	03		Pitpan	4073	2	
*3088D	Engine pan and hood board bolt	1918-21	Truck—Old No. 1128	03		Shamble	TT4073	2	
*3088E	Engine pan and hood board bolt nut	1909-21	Used on 3088B-C and D	02		Missive	1309		
3100	CRANK CASE WITH LOWER COVER	1912-21		12 00	MH	Closet	1526E	1	
3101	Crank case lower cover	1912-21	$6\frac{3}{8}$ " x $15\frac{1}{2}$ "	40	MH	Closure	1582	1	

*For prices in quantities see special list to Dealers and Garages.

††When used to replace spur type gear also order 3048B.

†When used to replace spur type gear also order 3047B.

‡When ordered to replace old style C. C. front frame bearing also order 2-3008, 2-3076C, 2-3078C, 1-3664, 1-3810 and 2-753 cover.

Of the net amount at which these parts are billed to purchasers who purchase direct from the Ford Motor Company (except parts which show no Tax Status, if any) 20/21 represents the price of the goods and 1/21 represents excise tax.

Insist upon genuine Ford parts



3250-D



3254



3276-B



3260

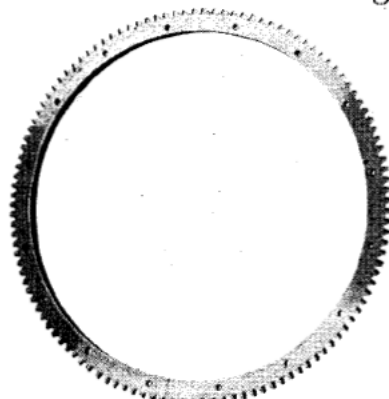

3268



3277



3277-B



3257



3270



3278



3255-B



3272

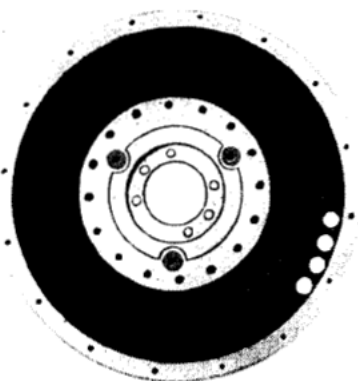

3269-C



3279



3269-E

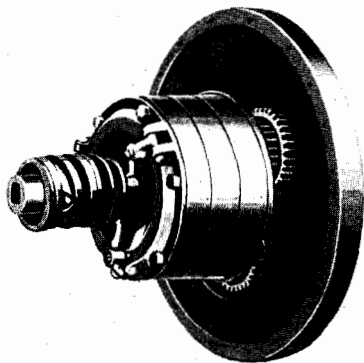

3300-B

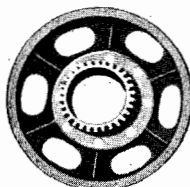

3301



3304



3309



3313



3314 1/2

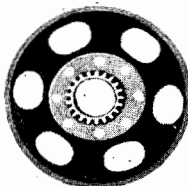

3306

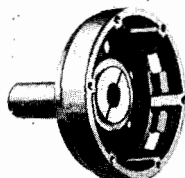

3311



3315



3317



3320-C



3320-D



3327-B

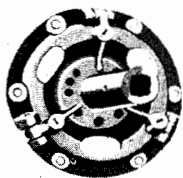

3321



3328



3329



3331



3332

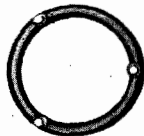

3336



3337



3334



3340



3368



3341



3342



3344

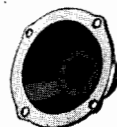

3369

Part No.	Name of Part	Year	Specifications	Price	Tax Status	Code Word	Fac. No.	Keq. per Car
MOTOR—Continued								
3101B.	Crank case lower cover reinforcement.	1912-21		\$ 0 30		Clothes.	4378-4379	1
*3102B.	Cr. c. lower cover gasket	1912-21	Cork.			Clotting.	1586	1
*3103.	Crank case lower cover screw.	1912-21	$\frac{1}{16}$ " x $\frac{1}{8}$ "	10		Cloudlet.	4328	14
3110.	Cylinder valve cover.	1912-21	$3\frac{3}{4}$ " x 8"	15	MH.	Clovate.	656	2
*3111B.	Cyl. valve cover gasket.	1912-21	Cork.	05		Cloven.	660	2
*3112.	Cyl. valve cover screw.	1912-21	$\frac{3}{8}$ " x 2 $\frac{1}{4}$ "	03		Compone.	654	2
3114.	Crank case arm with rivets.	1909-21		35		Cloth.	815	2
COMMUTATOR								
3162.	Com. case support bolt.	1912-19	$\frac{3}{8}$ " x 2 $\frac{1}{4}$ " x 24 thds.	05		Connote.	4441	1
3162B.	Com. case support bolt.	1919-21	Starter type.	05		Constrict.	1756	1
3163.	Com. case spring.	1912-21	$3\frac{1}{4}$ " C. to C.	05		Conoid.	689	1
3165.	Com. brush only.	1912-21		30		Conquest.	4481	1
3176.	Com. oiler.	1912-16	$\frac{1}{8}$ " pipe thds.	05		Coomb.	2383	1
3176B.	Com. oiler.	1917-18		05		Coot.	480	1
*3176C.	Com. oiler.	1919-21		05		Cookee.	480B.	1
*3177.	Com. felt ring.	1912-21	Felt.	03		Coombox.	5930	1
*3206.	Com. brush cap.	1909-21	$\frac{7}{8}$ " dia.	02		Convert.	468	1
*3207.	Com. brush cap pin.	1909-21	$\frac{1}{8}$ " x $\frac{1}{16}$ "	01		Convict.	466	1
*3210.	Com. contact point nut.	1910-21	$\frac{7}{8}$ " hex.	02		Cooper.	472B.	8
*3220.	Com. lock nut.	1909-21	$\frac{1}{16}$ " x 18 thds.	05		Crater.	471	1
3221.	Com. case with fibre assembled.	1912-21		60		Crato.	5908	1
*3222.	Com. shield.	1912-21		02		Crash.	5923	1
MAGNETO								
3250D.	Magneto coil assembly.	1915-21	Used with $\frac{3}{4}$ " magnets.	6 00		Craft.	5941B.	1
3252.	Magneto spool support screw.	1909-21	Order 3371.					
*3254.	Magnet bolt.	1909-21	$\frac{3}{8}$ " x 1 $\frac{1}{2}$ "	03		Corbeil.	537B.	16
3255B.	Magnet bolt washer.	1911-21	$\frac{3}{16}$ " hole, $\frac{7}{8}$ " dia.	01		Corrupt.	624	16
*3257.	Magnet brass support.	1909-21	$\frac{3}{8}$ " x $\frac{3}{4}$ " brass.	05		Cordial.	535C.	16
3260.	Magneto con. assembly.	1909-21	On trans. cover.	20	MH.	Cornus.	1545	1
3261B.	Magneto contact nut.	1909-21		01		Cornute.	1508	2
3261C.	Magneto contact screw washer.	1909-21		01		Cornel.	1565	
*3262.	Magneto contact spring.	1909-21	Coil spring.	05		Cornise.	1509	1
3262B.	Magneto contact screw and spring assb.	1919-21		10		Corsage.	4350	
3266.	Magneto contact fibre screw.	1909-21	$\frac{1}{4}$ " long.	01		Cortile.	1505B.	3
3267.	Magneto primary insulating block.	1915-21		05		Crumple.	4382	
3267B.	Magneto contact insulator.	1919-21		10		Crush.	1503B.	
3267C.	Magneto contact insulator shell.	1919-21		03		Crutch.	8611	
3268.	Fly wheel ring gear.	1919-21	For starter.	2 00	MH.	Cousin.	1885	1
3269C.	Fly wheel.	1911-19		6 00	MII.	Cosmic.	701B.	1
3269G.	Fly wheel only.	1919-21	Starter type.	6 00	MH.	Cozy.	701C.	1
3269H.	Fly wheel with ring gear and magnets assmbld.	1919-21	Starter type.	16 00	MH.	Cranch.	5946B.	1
3270.	Fly wheel cap screw.	1909-21	$\frac{1}{8}$ " x 1 $\frac{1}{16}$ "	10		Cossack.	721	4
*3271.	Fly wheel dowel pin.	1909-21	$\frac{1}{16}$ " x 1 $\frac{3}{16}$ "	05		Costard.	722	2
3272.	Magneto coil support shim.	1909-21	Sheet steel.	05		Costrel.	584	1
3276B.	Magnet (16) per set.	1915-21	$\frac{3}{4}$ " set	6 00		Court.	5933	16
*3277.	Magnet clamp.	1911-21		03		Cotland.	623	16
3277B.	Magnet clamp.	1913-14		10		Cotta.	4499	16
*3278.	Magnet clamp screw.	1911-21	2 $\frac{1}{4}$ " x 24 thds. brass.	03		Cottage.	625	16
*3279.	Magneto-contact washer.	1909-21	On trans. cover—cork.	01		Cough.	560	1
TRANSMISSION								
3300B.	Transmission assembly.	1919-21	Starter type. Does not include gear or magnets.	35 00	MH.	Daciam.	744C.	
3301.	Trans. reverse plate assembly.	1909-21		2 75	MH.	Dacolt.	747	1
3304.	Trans. reverse gear bushing.	1909-21	2 $\frac{1}{16}$ " ream.	50		Daddy.	705	1
3305.	Trans. reverse and S. S. rivet.	1909-21	$\frac{1}{16}$ " x $\frac{1}{16}$ " per doz.	05		Dado.	708	8
3306.	TRANS. SLOW SPEED PLATE ASSEMBLY.	1909-21		2 50	MII.	Dagger.	748	1
3309.	Trans. slow speed gear bushing.	1909-21	1 $\frac{1}{16}$ " ream.	45		Dairy.	745	1
3310.	Trans. brake drum rivet.	1909-21	$\frac{1}{16}$ " x $\frac{1}{16}$ " per doz.	05		Daisy.	711	8
3311.	TRANS. BRAKE DRUM ASSEMBLY.	1909-21		3 00	MII.	Dakir.	750	1
3313.	TRANS. TRIPLE GEAR ASSEMBLY.	1909-21		1 75	MII.	Dallop.	751B.	3

*For prices in quantities see special list to Dealers and Garages.

Of the net amount at which these parts are billed to purchasers who purchase direct from the Ford Motor Company (except parts which show no Tax Status, if any) 20/21 represents the price of the goods and 1/21 represents excise tax.

Insist upon genuine Ford parts

Part No.	Name of Part	Year	Specifications	Price	Tax Status	Code Word No.	Fac. No.	Req. per Car
TRANSMISSION—Continued								
3314½	Trans. triple gear flanged bushing	1911-21	1 1/8" dia. x 1 1/4"	\$0 25		Dalriad	716B.	3
3315	Trans. triple gear shaft	1909-21	1 1/8" dia. x 2 1/2"	15		Dalrotz	715	3
3316	Trans. triple gear riveting pin	1909-21	1/8" x 1 1/8"	05		Damar	720	24
3317	Trans. driven gear	1909-21	27 teeth	90	MH	Damask	713	1
3318	Trans. driven gear key	1909-21		03		Dampen	714	2
3320C	Trans. driven gear sleeve bushing	1909-21	1 1/2" long	20		Dark	712	2
3320D	Driven gear sleeve washer	1909-21		03		Darken	776	3
3321	TRANS. DRIVING PLATE ASSEMBLY	1909-21		3 50	MH	Dannock	749	1
3323	Trans. driving plate screw	1909-21	Order 3371					
3325	Trans. driving plate rivet	1909-21	3/8" x 3/8"	05		Darner	736	8
†3327B	Trans. driving plate bushing	1909-21	1 3/8" x 1 1/4"	20		Darsis	772	1
3328	Trans. thrust plate—small	1909-21	C" dia.	10	MH	Dauphin	727	12
3329	Trans. thrust plate—large	1909-21	6 1/8"	10	MH	Davine	728	13
3331	Trans. gear shaft	1909-21	1" dia. x 7 1/2" over all.	1 50	MH	Decurt	723B.	1
3332	Trans. clutch disc drum	1909-21	4 1/8" dia.	1 50	MH	Deeply	725B.	1
3333	Trans. clutch disc drum key	1909-21		05		Defalk	726B	1
3334	Trans. clutch disc drum set screw	1909-21	3/8" x 3/4"	05		Defeat	752	1
3336	Trans. clutch push ring	1909-21	6 1/8" O. D.	40	MH	Defie	770	1
3337	Trans. clutch finger	1909-21		15		Define	732	3
*3337½	Trans. clutch fingerscrew	1909-21	3/8" x 3/4" x 24 thds.	05		Deflour	756	3
3337B	Trans. clutch finger and screw	1909-21		20		Defix	765	3
3338	Trans. clutch finger pin	1909-21	1/4" x 1 5/8"	02		Deform	735	3
3340	Trans. clutch spring	1909-21	2 5/8" dia. x 2 3/4" long.	35		Defoue	737	1
3341	Trans. clutch spring support	1909-21		15	MII	Delator	738	1
*3342	Trans. clutch spring thrust ring pin	1909-21	1/8" x 2 3/8"	05		Delete	739	1
3344	Trans. clutch shift	1909-21		60	MII	Delight	733	1
TRANSMISSION COVER								
3362	Trans. cover bolt and nut	1909-21	3/8" x 1 1/8". Order 2722 & 2722B.					
*3363	Trans. cover gasket (front)	1909-21	1 1/4" x 1 1/2" x 15 1/2" felt.	05		Defy	872B.	1
3363B	Trans. cover gasket—short	1909-21	1 1/4" x 1 1/2" x 13" felt.	03		Defiant	4358	1
*3367	Trans. cover door screw	1909-21	3/8" x 1/2"	02		Demain	430	6
3368	Universal ball cap (rear)	1909-21	5 5/8"	30	MH	Demarch	818	1
3369	Universal ball cap (front)	1909-21	Bearing included.	90	MH	Demarga	819D.	1
*3371	Universal ball cap screw	1909-21	3/8" x 1 1/8"	03		Demise	731	2
3372	Universal ball cap bolt and nut	1909-21	Order 2722 & 2722B					
3375	Trans. cover screw	1909-21	Order 3072					
†3376B	TRANS. COVER	1919-21	Starter type	6 50	MII	Den	826E.	1
*3377B	Trans. cover gasket (pair)	1909-21	Cork	15		Dennet	885B.	1
3378	Trans. cover sloping door	1911-21	9 1/4" long.	15	MH	Dental	1546D	1
*3379B	Trans. cover sloping door gasket	1911-21	Cork	05		Denude	1547C.	1
3380	Bendix cover	1919-21		25	MH	Tendon	1763	1
*3381	Bendix cover gasket	1919-21		03		Thigh	1764	1
3382	Trans. cover rear plate	1919-21		10	MH	Deputy	1761	1
3383	Trans. cover front plate	1919-21		15	MH	Descry	1758	1
TRANSMISSION CONTROL								
3400	Trans. clutch release ring	1909-21	3 1/8" long.	25		Detail	741	1
3402D	Clutch lever and shaft	1913-21		45		Disdain	1548	
*3403	Clutch lever screw	1909-21	Order 3973					
*3403B	Clutch lever screw nut	1909-21	Used on 3403	03		Humbler	517	1
3405	Clutch lever pin	1909-21	3/4" x 1 1/8"	02		Detour	1553	1
3406B	Clutch release fork—right or left	1913-21		25		Deuce	4345	2
3406C	Clutch release fork pin	1913-21	Order 3405					
3408	Clutch release fork key	1909-14		05		Dilate	836	2
3409	Clutch release fork clamp screw	1909-14	3/8" x 1 1/8"	10		Dipper	835	2
3411	Clutch lever clevis pin	1909-21	Order 2564					
3413	TRANSMISSION BAND ASSEMBLY	1909-21		60	MII	Disblame	838B.	3
(Bands will be exchanged at Branch or Factory at 50c each.)								
*3415	Trans. band washer	1909-21	1 1/8" hole x 3/8" dia.	03		Discure	840	2
3416	Trans. band lining	1909-21		15	MII	Disedge	1562	3
3419	Trans. band adjusting screw	1909-21	3/4" x 3 1/8"	10		Disfriar	1533	1

*For prices in quantities see special list to Dealers and Garages.

†When using short bushing in making repairs remove driving plate key.

When ordered to replace cover on cars below 2044100 also order 3402D clutch lever and shaft.

Of the net amount at which these parts are billed to purchasers who purchase direct from the Ford Motor Company (except parts which show no Tax Status, if any) 20/21 represents the price of the goods and 1/21 represents excise tax.

Insist upon genuine Ford parts

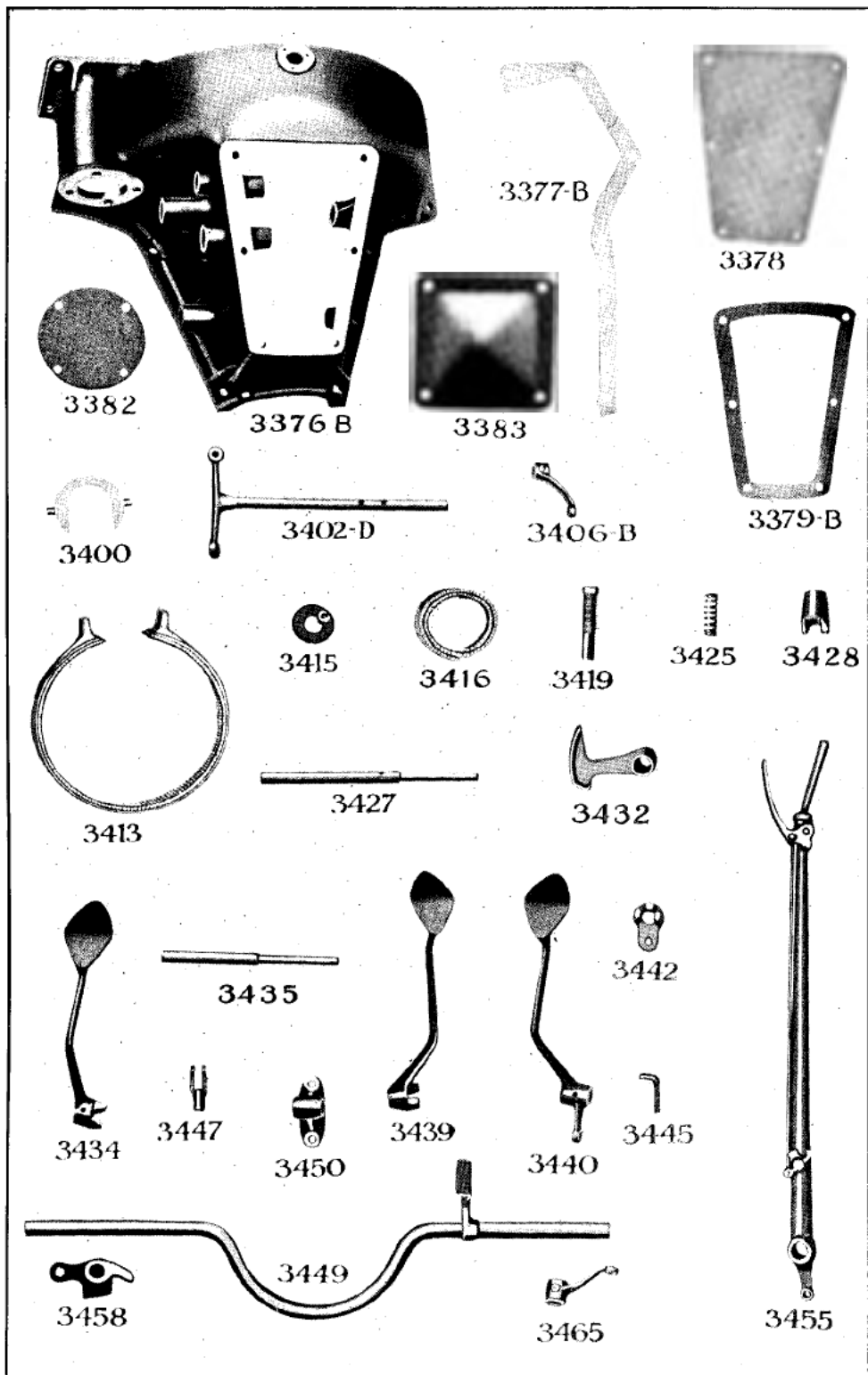

Part No.	Name of Part	Year	Specifications	Price	Tax Status	Code Word	Fac. No.	Req. per Car
TRANSMISSION CONTROL—Continued								
*3420	Trans. band adjusting screw nut	1909-21	3/4" x 16 thds.	\$0 05		Dislimb	1532	1
*3421B	Trans. band ear iron rivet, per doz.	1909-21	1/8" x 3/8"	05		Dismal	843	12
*3422B	Trans. band brass rivet, per doz.	1909-17	3/4" x 1/2"	05		Dismast	844B	6
*3423B	Trans. band brass rivet, per doz.	1909-21	3/4" x 1/8"	05		Dismaw	845B	18
*3425	Trans. band spring	1909-21	Coil	05		Dispark	841B	3
*3426	Trans. band adjusting nut	1909-21	5/8" x 20 thds.	05		Displat	851	2
3427	Slow speed shaft.	1909-21	5/8" x 9 3/8"	15		Disputz	848B	1
3428	Slow speed notch	1909-21	On slow speed shaft.	30		Distrand	4327	1
3429	Slow speed notch pin	1909-21	3/4" x 1 1/8"	02		Disrobe	1560	1
3432	Speed lever	1909-21		10		Distaff	862B	1
3434	Reverse pedal.	1909-21		60	MH	Disting.	4324	1
3435	Brake and rev. pedal shaft	1909-21	5/8" dia. x 7 1/8"	15		Distrite	849B	2
3436	Brake and rev. pedal support	1909-21		20		Distune	4325	2
*3437	Brake and rev. support bolt	1909-21	3/8" x 1 1/2"	05		Ditcher	1534	2
*3437B	Brake and rev. support bolt nut	1909-21	Used on 3437.	03		Egret	8	2
3439	Brake pedal	1909-21		60	MH	Ditrost	4323	1
3440	Clutch pedal	1909-21		60	MH	Ditty	854B	1
3441	Pedal pin.	1909-21	Order 3405.	20		Dookad.	4326	1
3442	Clutch pedal support	1909-21		05		Doorga	1536	2
*3443	Clutch pedal support bolt	1909-21	3/8" x 2"	20		Dookad.	4326	1
*3443B	Clutch pedal support bolt nut	1909-21	Used on 3443.	03		Egret	8	1
3445	Slow speed connection	1909-21		05		Doree	1540	1
*3446	Slow speed con. lock nut	1909-21	3/8" x 24 thds.	02		Doric	44	1
3447	Slow speed con. clevis.	1909-21		10		Dormer	802	1
3448	Controller quadrant	1909-21	On frame.	20		Dormouse	309B	1
3449	CONTROLLER SHAFT WITH SPEED LEVER	1909-21		80	MH	Doron	1557	1
3450	Controller shaft bracket	1909-21	On frame.	15		Dorrer	311	2
*3452	Controller shaft bracket bolt	1909-21		03		Fog	315	4
*3452B	Controller shaft bracket bolt nut	1909-21	Used on 3452.	02		Frolc	316	4
3455	HAND BRAKE LEVER ASSEMBLY	1909-21		1 25	MH	Dotant	1550	1
3456B	Hand brake lever pin.	1909-21	Order 2574.	05		Doublet	874	1
3457	Hand brake lever key.	1909-17		10		Doucet	875	1
3458	Hand brake lever pawl.	1909-21		02		Doura	876	1
*3459	Hand brake lever pawl pin	1909-21	1/4" x 1 1/4"	10		Dovecote	877	1
3460	Hand brake lever pawl rod	1909-21		15		Dovekie	4363	1
3462	Hand brake lever pawl lift assembly	1909-21	Handle and spring.	02		Dawcet	888	1
3463	Hand brake lever pawl lift spring	1909-21		20		Dawdy	864	1
3465	HUB BRAKE LEVER ON CONTROLLER SHAFT	1909-21		60	MH	Drongo	891B	1
3466	Hub brake lever pin.	1909-21	Order 3405.	60	MH	Droxap	1513B	1
3467	Hub brake lever clevis.	1909-21	2 1/8", Order 3447.	10		Dropsy	1367	1
3468	Hub brake pull rod—right.	1909-21	54 1/4" long.	10		Drugger	1398	1
3469	Hub brake pull rod—left	1909-21	54 1/8" long.	03		Methol	1308	2
3470	Hub brake rod support—right.	1909-21		02		Missive	1309	2
3471	Hub brake rod support—left.	1909-21		10				
*3472	Hub brake rod support bolt	1909-21	1/2" x 1 1/2"	03				
*3472B	Hub brake rod support bolt nut	1909-21	Used on 3472.	02				
STEERING GEAR								
3500C	Steering gear assembly.	1911-21	51" long	11 00	MH	Estopped	5042	1
3501C	Steering gear rim.	1920-21	16"	1 00		Estuary	901C	1
3502	Steering gear rim screw	1909-21	No. 12, 3/4"	02		Ebilis	6849	4
3503D	Steering gear spider.	1920-21	16"	60		Etagere	902C	1
3503E	Steering gear spider and rim	1909-21	16"	1 60	MH	Eulogic	995A2	1
3504	Steering gear cover	1909-21	2 1/2" x 18 thds.	35		Ecbole	5039	1
3505	Steering gear cover screw	1909-21	No. 6, 32 x 3/8"	02		Ecoope	910	1
3506	Steering gear cover bushing.	1909-21	1" long, steel.	15		Echo	914	1
3506B	Steering gear driving pinion washer	1909-21	Steel.	02		Elf	5026	1
3507	Steering gear internal gear case and bushing.	1909-21		1 25		Egg	5036	1
3509	Steering gear quadrant.	1909-21		15		Ectype	906B	1

*For prices in quantities see special list to Dealers and Garages.

Of the net amount at which these parts are billed to purchasers who purchase direct from the Ford Motor Company (except parts which show no Tax Status, if any) 20/21 represents the price of the goods and 1/21 represents excise tax.

Insist upon genuine Ford parts



3506

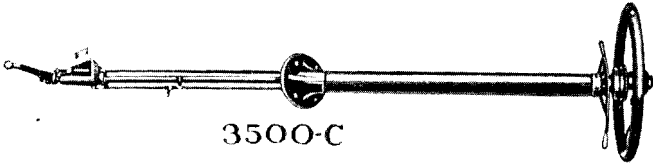

3500-C



3506-B



3501-C



3503-D

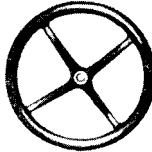

3503-E



3504

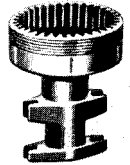

3507



3509

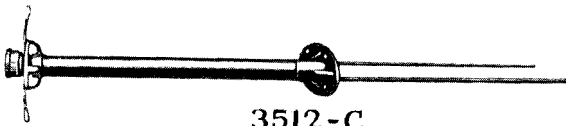

3512-C



3517



3516-C



3524-E



3518



3519



3525-E



3527



3530



3531



3532

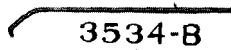

3534-B



3528



3535



3545



3546



3536

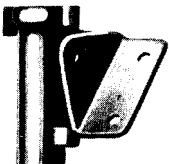

3539-B

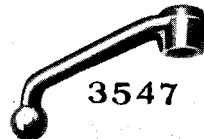

3547



3664

Part No.	Name of Part	Year	Specifications	Price	Tax Status	Code Word	Fac. No.	Req. per Car
STEERING GEAR—Continued.								
3510	Steering gear quadrant rivet	1909-21	$\frac{3}{8}$ " x $1\frac{1}{4}$ "	\$0	01	Eden	5041	2
3511	Steering gear wheel nut	1909-21	$\frac{5}{8}$ " x 16 thds.	15		Edict	913	1
3512C	Steering gear tubing assembly	1912-21	Applies to No. 3500C	4	00	Ethicer	5016	1
3513B	Steering tubing flange screw	1913-16	$\frac{1}{8}$ " x $1\frac{1}{8}$ "	03		Ethule	5019	1
*3513C	Steering tubing flange screw	1913-21	$\frac{1}{8}$ " x $1\frac{1}{8}$ "	03		Platter	5018	3
*3514	Steering tubing flange screw nut	1913-21	Used on 3513B and C	02		Harrow	926	
3516C	Steering gear post	1912-21	Applies to No. 3500C	1	75	Estricked	5043	1
3517	Steering gear pinion	1909-21	12 teeth	15		Egad	916	3
3518	Steering gear pinion pin	1909-21	$\frac{3}{8}$ " x $1\frac{1}{8}$ "	03		Egest	917	3
3519	Steering gear drive pinion	1909-21	12 teeth	30		Egger	911	1
3520	Steering gear drive pinion key	1909-21	$\frac{1}{8}$ " sq. x $\frac{3}{16}$ "	03		Egma	909	1
3523	Steering gear post castle nut	1909-21	Order 2568					
3524E	Throttle rod	1912-21	$47\frac{1}{16}$ " Applies to 3500C	40		Euter	5038	1
3525E	Lead rod	1912-21	$51\frac{1}{16}$ " Applies to 3500C	40		Evans	5037	1
3527	Lead and throttle rod spring	1909-21		03		Elite	935	2
3528	Lead and throttle rod collar	1909-21	$\frac{5}{16}$ " bore x $\frac{5}{16}$ "	02		Elope	936	2
3529	Lead and throttle rod pin	1909-21	$\frac{1}{16}$ " x $\frac{1}{16}$ "	01		Elvan	937	5
3530	Lead rod lever	1909-21		10		Embank	946	1
3531	Throttle rod lever	1909-21		10		Ember	947	1
3532	Lead and throttle rod guide	1909-21	$\frac{3}{4}$ " bore	05		Emblem	938	1
3534C	Commutator pull rod	1912-21		10		Embrace	2082	1
3535	Carburetor pull rod	1909-21	$14\frac{1}{16}$ " long	10		Emboss	1329	1
*3536	Ball and socket joint	1909-21		10		Embraid	1326	1
*3537	Ball and socket joint nut	1909-21	$\frac{3}{16}$ " x 32 thds.	02		Embrute	1327	1
3539B	Steering post bracket with bushing	1911-21	Touring	75		Eupon	996	1
3539C	Steering post bracket with bushing	1918-21	Truck—Old No. 1105	90		Dream	TT996	1
3540	Steering post bracket bolt and nut—long	1909-21	Order 3073 & 3074B					
3541	Steering post bracket bolt and nut—short	1911-21	Order 3074 and 3074B					
3544	Steering post bracket felt washer	1909-21		03		Endow	943	1
3545	Steering post bracket bushing	1909-21	$\frac{3}{4}$ " bore, brass, 2 pieces	20		Envault	944-5027	1
3546	Steer. post bracket block	1909-21	Wood	10		Empact	945	1
3546B	Steer. post bracket block	1918-21	Truck—Old No. 1106	05		Drift	TT945	1
3547	Steering gear ball arm	1909-21		50		Epoch	929B	1
*3548	Steering gear ballarm key	1909-21		05		Ephad	930	1
3549	Steering gear bracket dust cap	1918-21	Truck—Old No. 1107	05		Drum	TT5044	1
BODY PARTS								
3601B	Body bracket on body	1910-21	Center and rear	10		Fabric	1624	6
3602I	Body bracket con. bolt		$\frac{1}{8}$ " x $\frac{3}{16}$ "	03		Poach	5653	6
3602E	Body bracket con. bolt	1916-21	$\frac{1}{8}$ " x $1\frac{1}{2}$ "	03		Pilgrim	2431	6
3602F	Body bracket con. bolt nut	1916-21	Used on 3602D and E	03		Bashful	220	
3624E	Front floor rubber mat	1915-21	$28\frac{1}{4}$ x $29\frac{1}{8}$ " Tr. & Rb't	1	30	Faith	7299	1
3626B	Floor board (first)	1915-21	Tour. R'nab't&Coupelet	40		Farm	7296	1
3626C	Floor board with plate (first)	1915-21		50		Farrago	4200	
3627B	Floor board (second)	1915-21	Tour. Runab't&Coupelet	40		Faro	7297	1
3627C	Floor board with plate (second)	1915-21		50		Fascia	4201	
3628	Floor board (third)	1915-21	Specify size	65		Fasces	1404B	1
3628B	Floor board with plate (third)	1915-21		70		Fascine	7104	
3630	Floor board forward plate for pedals	1909-21	$2\frac{1}{8}$ " x $3\frac{1}{8}$ "	10		Fateful	1400C	1
3632	Floor board rear plate for pedals	1909-21	$2\frac{1}{8}$ " x $4\frac{7}{8}$ "	10		Father	1095C	1
3633	Floor board plate for side lever	1909-21	$2\frac{1}{8}$ " x $8\frac{3}{4}$ "	05		Fathom	1094B	1
3634D	Dash	1913-14	$21\frac{1}{2}$ " x $32\frac{1}{4}$ "	3	00	Flango	5336	1
3634E	Dash	1915-16		3	50	Fleet	7462	1
3634G	Dash	1917-21		3	00	Fringe	8754	1
3638B	Dash shield	1919-21		10		Fauge	5432B	1
3639	Dash weatherstrip—side	1917-21		05		Flicker	8747	2
3639B	Dash weatherstrip—top	1917-21		20		Floren	8752	1
†3640C	Dash bracket—left	1917-21		20		Foal	8722	1
†3641C	Dash bracket—right	1917-21		20		Fowl	8721	1

*For prices in quantities see special list to Dealers and Garages.
 †When used on 1911-16 cars rod drill frame.
 Of the net amount at which these parts are billed to purchasers who purchase direct from the Ford Motor Company (except parts which show no Tax Status, if any) 20/21 represents the price of the goods and 1/21 represents excise tax.

Insist upon genuine Ford parts

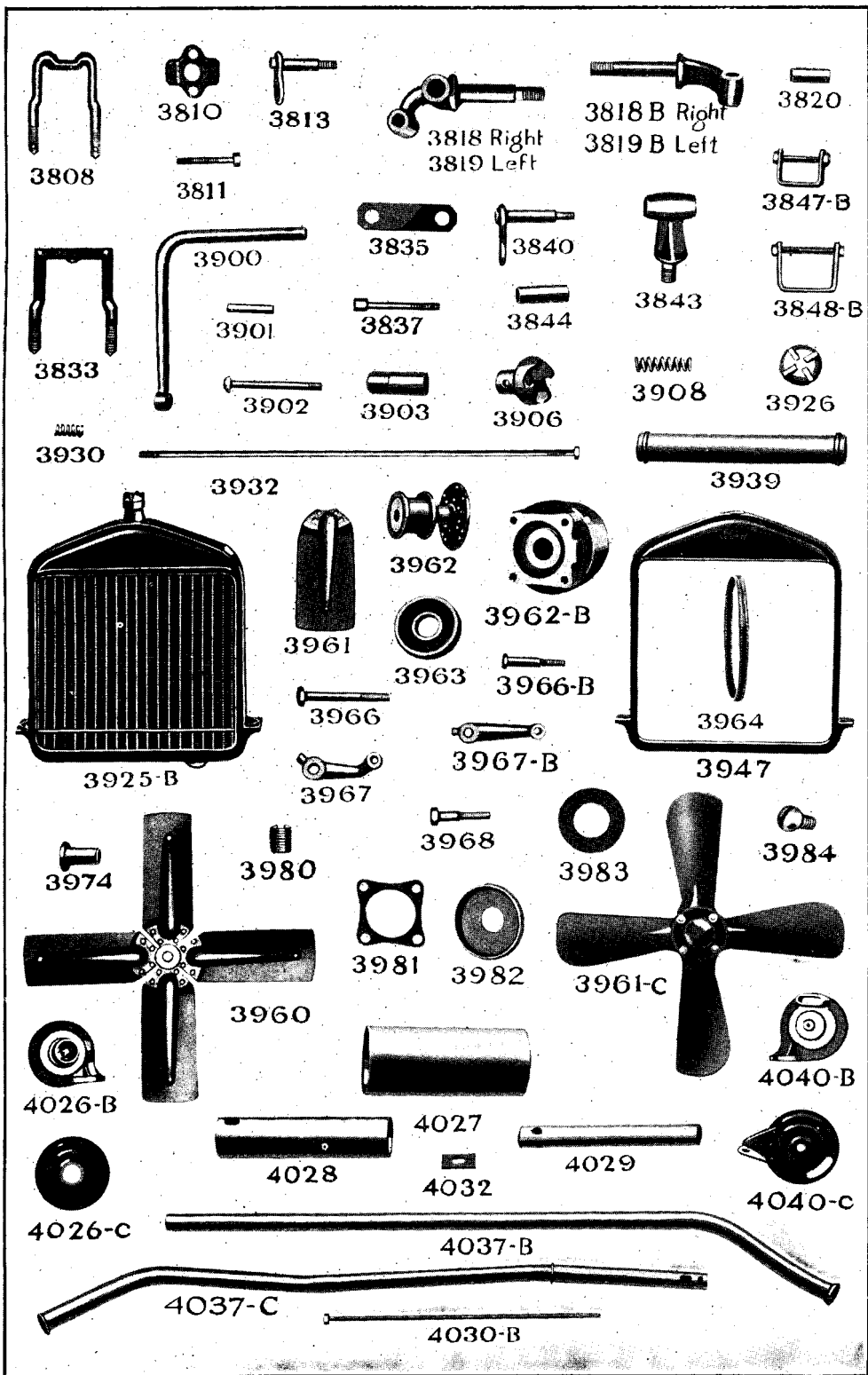

Part No.	Name of Part	Year	Specifications	Price	Tax Status	Code Word	Fac. No.	Req. per Car
BODY PARTS—Continued								
*3642B	Dash bracket to dash bolt	1917-21		\$0 03		Rodent	8740	4
*3642C	Dash bracket to dash bolt nut	1917-21	Used on 3642B	02		Harrow	926	4
3645	Dash bracket to dash bolt	1909-16	$\frac{1}{8}$ " x $1\frac{1}{4}$ " x 18 thds.	03		Favos	2427	2
3645B	Dash bracket to dash bolt nut	1909-16	Used on 3645	02		Gram	341	2
*3653B	Dash to body brkt. bolt	1915-21	Touring car	03		Planet	4248	2
*3653C	Dash to body brkt. bolt nut	1915-21	Used on 3653B	02		Gram	341	2
3654	Dash to body gasket	1918-21		05		Feaze	8769	
3660C	Tail lamp and license bracket assembly	1915-21	Touring car, Sedan	50		Flour	7506	1
3660D	Tail lamp and license bracket assembly	1915-21	Runabout and 1916-17 Coupelet	40		Flute	7505	1
3662	Front license bracket-R	1920-21		10		Fluffy	287	1
3663	Front license bracket-L	1920-21		10		Fluently	288	1
3664	Front license bracket	1921		15		Fluxion	493	1
3667E	Front seat cushion	1909-21		6 00	MH	Farce	8076	1
3667F	Front seat cushion	1921		6 00	MH	Farical	8076B	1
3670D	Rear seat cushion	1909-21		6 50	MH	Forum	7032	1
3670E	Rear seat cushion	1921		6 50	MH	Forthy	7032B	1
3676B	Rear floor mat	1911-21	30" x 28" wool	1 60		Flatus	1606B	1
3676C	Rear floor mat	1921		1 50		Flaunt	1606C	1
SPRINGS								
3800	Front spring	1909-21		2 75	MH	Gadan	332	1
3801	First leaf (main leaf)	1909-21		80		Golf	2943	1
3802B	Second leaf	1909-21		50		Goose	2935	1
3803	Third leaf	1909-16	Tapered ends	40		Gaddish	356	1
3803B	Third leaf	1916-21	Square ends	40		Gopher	2936	1
3804	Fourth leaf	1909-16	Tapered ends	30		Gadoid	357	1
3804B	Fourth leaf	1916-21	Square ends	30		Gosling	2937	1
3805	Fifth leaf	1909-16	Tapered ends	25		Gallic	358	1
3805B	Fifth leaf	1916-21	Square ends	25		Gossip	2938	1
3806	Sixth leaf	1909-16	Tapered ends	20		Gafol	359	1
3806B	Sixth leaf	1916-21	Square ends	20		Gothic	2939	1
3807	Seventh leaf	1909-16	Tapered ends	15		Gaiter	360	1
3807B	Seventh leaf	1916-21	Square ends	15		Gally	2947	1
3808	Front spring clip	1909-21		20		Galena	325C	2
3809	Front spring clip nut	1909-21	Order 2568					
3810	Front spring clip bar	1921		25		Gallate	342	1
*3811	Front spring tie bolt	1909-21	$\frac{1}{8}$ " x $2\frac{1}{4}$ "	04		Galley	1362	1
*3811B	Front spring tie bolt nut	1909-21	Used on 3811	02		Galleon	1363	1
3813	Front spring hanger	1909-21	Used on 3811 (Each piece)	15		Gambit	246B	4
3815	Front and rear spring hanger nut	1909-21	Order 2719					
3817	Front and rear spring hanger oiler	1909-16		05		Gamin	218	8
3818	Front spring perch-right	1909-19		60	MH	Gamut	274	1
3818B	Front spring perch-right	1919-21		60	MH	Garret	274B	
3819	Front spring perch-left	1909-19		60	MH	Gander	275	1
3819B	Front spring perch-left	1919-21		60	MH	Gastar	275B	
*3820	Front spring perch bushing	1909-21	$\frac{11}{16}$ " x $1\frac{1}{2}$ "	05		Gangue	230	4
3821	Front spring perch nut	1909-21	$\frac{1}{8}$ " x 18 thds. Order 2828					
3821B	Front spring perch nut	1921		06		Garble	240	1
*3823	Front spring leather	1909-21	$1\frac{1}{2}$ " x $5\frac{3}{4}$ "	10		Gannet	262	1
3824	REAR SPRING	1909-21	$5\frac{5}{8}$ " tread, 8 leaf	8 50	MH	Ganoid	353	1
3825	First leaf (main leaf)	1909-19	Tapered ends	1 70		Ganlope	361	1
3825B	First leaf (main leaf)	1918-21		1 70		Gallop	355	1
3826	Second leaf	1909-19	Tapered ends	1 55		Gantois	362	1
3826B	Second leaf	1918-21	Square ends	1 55		Galore	362B	1
3827	Third leaf	1909-19	Tapered ends	1 40		Ganza	363	1
3827B	Third leaf	1918-21	Square ends	1 40		Garnish	363B	1
3828	Fourth leaf	1909-19	Tapered ends	1 25		Gaphare	364	1
3828B	Fourth leaf	1918-21	Square ends	1 25		Gender	364B	1
3829	Fifth leaf	1909-19	Tapered ends	1 10		Garden	365	1
3829B	Fifth leaf	1918-21	Square ends	1 10		Genus	365B	1
3830	Sixth leaf	1909-19	Tapered ends	1 00		Garland	366	1
3830B	Sixth leaf	1918-21	Square ends	1 00		Ghoul	366B	1
3831	Seventh leaf	1909-19	Tapered ends	90		Garlic	367	1
3831B	Seventh leaf	1918-21	Square ends	90		Giant	367B	1
3832B	Eighth leaf	1909-21	Square ends	80		Gimlet	368B	1
3833	Rear spring clip	1909-21	$4\frac{1}{2}$ "	25		Game	326	2
*1834	Rear spring clip nut	1909-21	Order 2548					
3835	Rear spring clip bar	1909-21	$\frac{3}{8}$ " x $1\frac{1}{2}$ " x $4\frac{1}{2}$ " x $\frac{1}{16}$ "	10		Gascon	329	2
*1837	Rear spring tie bolt	1909-21	$\frac{3}{8}$ " x $2\frac{1}{8}$ "	05		Gastric	1352	1
*3837B	Rear spring tie bolt nut	1909-21	Used on 3837	02		Gaufer	1353	1
3840	Rear spring hanger	1909-21	(Each piece)	15		Gaulus	$9\frac{1}{2}$ B	4
3842	Rear spring leather pad	1909-21	$2\frac{1}{2}$ " x $10\frac{1}{4}$ "	10		Gavel	94	1
3843	Rear spring perch	1909-21		40	MH	Gavot	2804	2

*For prices in quantities see special list to Dealers and Garages.

Of the net amount at which these parts are billed to purchasers who purchase direct from the Ford Motor Company (except parts which show no Tax Status, if any) 20/21 represents the price of the goods and 1/21 represents excise tax.

Insist upon genuine Ford parts

Part No.	Name of Part	Year	Specifications	Price	Tax Status	Code Word	Fac. No.	Req. per Car
SPRINGS—Continued								
*3844	Rear spring perch bushing	1909-21	$\frac{1}{8}$ " bore x $\frac{3}{4}$ " dia. x 2" x 16 thds.	\$ 0 05		Gawky	172	4
*3845	Rear spring perch nut	1909-21		10		Gazara	174	2
*3847	Front spr'g clamp assembly with bolt and nut	1909-16		10		Gazzam	374	2
*3847B	Front spr'g clamp assembly with bolt and nut	1916-21	(for 6 leaf spring)	10		Gown	2953	2
*3848	Rear spr'g clamp assembly with bolt and nut	1909-17		10		Cecko	376	2
*3848B	Rear spr'g clamp assembly with bolt and nut	1918-21		10		Gemmy	378	2
REAR SPRING—60 INCH TREAD								
3850	Rear spring	1909-16	48 $\frac{1}{2}$ " long, 8 leaf	9 00	MH	Geddur	1704	1
3851	Rear spring clip	1909-16	$\frac{1}{8}$ " x 4 $\frac{1}{2}$ "	20		Gelder	1737	2
3852	Rear spring tie bolt	1909-16	$\frac{3}{8}$ " x $\frac{3}{8}$ "	10		Gemote	1738	1
*3852B	Rear spring tie bolt nut	1909-16	Used on 3852	02		Gaffer	1353	1
3853	First leaf (main leaf)	1909-16		1 83		Gemsbok	1739	1
3854	Second leaf	1909-16		1 67		Gershon	1740	1
3855	Third leaf	1909-16		1 49		Gerper	1741	1
3856	Fourth leaf	1909-16		1 29		Gherkin	1742	1
3857	Fifth leaf	1909-16		1 00		Gibbet	1743	1
3858	Sixth leaf	1909-16		90		Ginger	1744	1
3859	Seventh leaf	1909-16		75		Gipsire	1745	1
3860	Eighth leaf	1909-16		67		Gisarm	1746	1
STARTING CRANK								
3900	Starting crank only	1909-21		67		Herna	519B	1
3901	Starting crank handle	1909-21		23		Heron	520	1
*3902	Starting crank handle bolt	1909-21	$\frac{1}{2}$ " x 4 $\frac{1}{2}$ "	10		Herpes	521	1
3903	Starting crank sleeve	1909-21	$\frac{1}{4}$ " bore x $\frac{1}{2}$ " x $1\frac{1}{4}$ "	10		Hesper	523	1
*3905	Starting crank ratchet pin	1909-21	1 $\frac{3}{8}$ "	05		Hestern	4491	1
3906	Starting crank ratchet	1909-21		25		Hetman	528	1
*3908	Starting crank spring	1909-21		05		Hilding	626	1
3909	Starting crank handle spring	1915-21		63		Hitter	5911	1
RADIATOR—THERMO-SYPHON								
3925	Radiator	1909-16		20 00	MH	Hominy	1106C	1
3925B	Radiator	1917-21		20 00	MH	Honey	8700	1
3925C	Radiator less shell	1917-21		18 50	MH	Hop	8736	1
3926	Radiator cap	1909-21		15	MH	Hothir	8714	1
3928	Radiator pad	1909-19	Leather	65		Hovel	1105	2
3929	Radiator stud	1909-19	$\frac{3}{8}$ " x 2 $\frac{1}{8}$ "	65		Hoxy	1162	2
3929B	Radiator stud	1919-21		05		Hoax	1162B	2
3929C	Radiator stud nut	1909-21	Used on 3929 & 3929B	03		Hive	1154	2
3930	Radiator stud spring	1909-21	Order No. 2742	05		Huffish	1161	2
3931 $\frac{1}{2}$	Radiator stud washer nut	1909-21	$\frac{3}{8}$ " x 2 $\frac{1}{2}$ thds.	15	MH	Huller	1111E	1
3932	Radiator rod	1909-21	20 $\frac{3}{4}$ " long	03		Humbler	517	1
*3934	Radiator rod nut	1909-21	$\frac{3}{8}$ " x 2 $\frac{1}{2}$ thds.	35		Humble	1121	1
3939	Outlet connection pipe	1909-21	1 $\frac{3}{4}$ " x 12"	03		Order 3079		
3940	Outlet connection cock	1909-21	Order 3079	10		Hungry	507B	2
*3944	Outlet connection hose	1909-21	1 $\frac{3}{4}$ " x 2 $\frac{3}{4}$ "	05		Hunter	554	4
*3945	Outlet connection hose clip	1909-21	2 $\frac{1}{8}$ " dia	1 50	MH	Hymn	8737	1
3947	Radiator shell	1917-19		1 50	MH	Hymnal	8737B	1
3947B	Radiator shell	1919-21		02		Hump	1115	1
3975	Radiator stud spring upper thimble	1919-21		03		Hurst	1114	1
3976	Radiator stud spring lower thimble	1919-21		03				
RADIATOR FAN								
3960	Fan and pulley assembly	1909-20		1 50	MH	Hutten	619	1
3961	Fan blade	1909-20		10		Hyades	611	4
*3961B	Fan blade rivets, per dozen	1909-20		05		Hyad	1566	16
3961C	Fan blade assy	1920-21		30		Iambe	620	1
3962	Driven fan pulley	1909-20	Brass, upper	50		Hydra	618	1
3962B	Driven fan pulley with bushing	1920-21		70		Iaon	618B	1
3963	Fan drive pulley	1909-20	Steel, lower	30		Hydrant	602	1
3963B	Fan drive pulley	1920 21		20		Hydromel	602B	1
3964	Fan belt	1909-16	23" long	30		Hydrac	609	1
3964C	Fan belt	1917-20	1 carton, 26" long	30		Impel	609B	1
3964D	Fan belt	1920 21	27" long	30		Idiom	609C	1
3966	Fan shaft	1909-20	$\frac{1}{8}$ " x 4 $\frac{1}{8}$ "	20		Ilyper	606	1
3966B	Fan shaft	1920 21		30		Iasius	606B	1
3967	Fan bracket	1909-16		40		Hypo	604	1
3967B	Fan bracket	1917-21		30		Idyl	604B	1
*3968	Fan bracket bolt	1909-21	$\frac{1}{2}$ " x 2 $\frac{3}{8}$ "	15		Hyper	605	1
3970	Fan grease cup	1909-21		10		Ilypish	601	1
*3973	Fan adjusting screw	1909-21	$\frac{3}{8}$ " x 1 $\frac{1}{8}$ "	03		Groats	645	1

*For prices in quantities see special list to Dealers and Garages.

Of the net amount at which these parts are billed to purchasers who purchase direct from the Ford Motor Company (except parts which show no Tax Status, if any) 20/21 represents the price of the goods and 1/21 represents excise tax.

Insist upon genuine Ford parts



Part No.	Name of Part	Year	Specifications	Price	Tax Status	Code Word No.	Fac. No.	Req. per Car
RADIATOR FAN—Continued								
*3973B	Fan adjusting screw nut	1909-21	Used on 3973	\$0 03		Humber	517	1
3974	Fandrivenpulleybushing	1917-20		15		Knag	8757	1
3974B	Fandrivenpulleybushing	1920-21		15		Ibhar	8757B	2
3980	Fan pulley plug	1920-21		03		Ibidem	633	1
3981	Fan pulley gasket	1920-21		01		Icarian	634	1
3982	Fan shaft cap	1920-21		02		Icilius	635	1
3983	Fan shaft felt washer	1920-21		02		Iconism	637	1
3984	Fan blade screw	1920-21		01		Ictus	652	4
3985	Fan blade screw washer	1920-21	Order T 3261C					4
3986	Fan shaft nut	1920-21	Order T 2719					1

MUFFLER

4025	Muffler assembly	1909-20		2 00	MH	Jobal	1200	1
4025B	Muffler assembly	1921	Includes 3061 & 4037C	3 00	MH	Jocasta	1200C	1
4026B	Muffler head—front	1917-20		45		Julep	1202C	1
4026C	Muffler head—front	1921	Pressed steel	20		Julian	1202D	1
4027	Muffler shell—outer	1909-21	5" dia. x 12"	25		Jabin	1203	1
4028	Muffler shell—middle	1909-21	3 1/2" dia. x 13"	20		Jackal	1204	1
4029	Muffler shell—inner	1909-20	2" dia. x 14"	15		Jaday	1205	1
4030	Muffler rod	1909-17	3/8" x 13 3/4"	10		Jadish	1206	3
4030B	Muffler rod	1917-20		10		Jocose	1206B	1
*4031	Muffler rod nut	1909-20	3/8" x 24 thds. Order 3446					
4032	Muffler head retainer	1921		02		Jole	1210	1
4033	Muffler head retainer bolt and nut	1921	Order 4819B and 4819D					
4035	Muffler head bolt washer	1921		01		Jovy	5508	1
4037B	Long exhaust pipe	1909-20		1 75		Jaunty	1214	1
4037C	Long exhaust pipe	1920-21		2 00	MH	Jazerant	1214B	1
4040B	Muffler head—rear	1917-21		45		Jesuit	1201D	1
4040C	Muffler head—rear	1921	Pressed steel	20		Jeush	1201E	1
4041	Muffler head to frame bolt and nut	1917-20	Order 2722 & 3066B					
4041B	Muffler head to frame bolt and nut	1921	Order 3074 and 3074B					

HOOD

4050	Hood	1909-16	22" long	5 00		Jibsam	1300	1
4050B	Hood	1917-21		5 00	MH	Jilt	8726	1
4051	Hood handle	1909-21	5 1/2" long	05		Jingal	1314	2
4052	Hood clip	1909-16	3 1/4"	10		Jippo	1310	4
4052B	Hood clip	1917-21		05		Jowl	8731	4
4053	Hood clip spring	1909-16		02		Jockey	1311	4
*4053B	Hood clip spring	1917-21		02		Juice	8734	4
4056	Hood board—left	1909-16	22 3/4" long	25		Johim	1339	1
4056B	Hood block—left	1917-21		20		Kilt	8742	1
4057	Hood board—right	1909-16	22 3/4" long	25		Jorum	1340	1
4057B	Hood block—right	1917-21		20		Kine	8741	1
4060B	Hood support on dash	1915-16		1 50		Juror	7464	1
4060C	Hood pad (on dash)	1917-21		10	MH	Kite	8711	2
4060D	Hood pad (on radiator shell)	1917-21		20	MH	Kid	8710	1
4061B	Hood clasp (on dash)	1917-21		05		Kit	8720	1
4061C	Hood clasp (on dash) screw	1917-21		02		Knee	8763	2
4061D	Hood clasp (on dash)	1920-21		05		Kltten	8720B	1
4073	Hood block support—front right	1917-21		05		Knot	8743	1
4074	Hood block support—front left	1917-21		05		Kilt	8744	1
4075	Hood block support—rear right	1917-21		05		King	8745	1
4076	Hood block support—rear left	1917-21		05		Kirk	8746	1

KINGSTON CARBURETOR

6100	Carburetor complete	1909-21		6 00		Mason	553A1	1
6101A	Carburetor float assb	1917-21		75		Moslem	6369	1
6101	Float with lever	1915-16		75		Marsh	6351	1
6127A	Gasoline valve	1917-21		35		Moral	6377	1
6115	Spray needle assembly	1910-21		50		Medal	3010	1

Parts for 1909-16 Carburetors supplied by Bryne Kingston Co., Kokomo, Ind.

KINGSTON CARBURETOR (MODEL "L-4")

6150	Carburetor complete	1921		6 00		Mason	553A1	1
6155	Float with lever	1921		50		Medicate	6369B	1
6161	Spray needle assembly	1921	Order 6115					
6175	Gasoline valve	1921		35		Mediety	6377B	1

FORD CARBURETOR (MODEL "G")

6040	Carburetor complete	1909-21		6 00	MII	Mire	553A2	1
4451A	Float with lever	1914-21		50		Muzzle	6333	1
4452A	Spray needle assembly	1914-21		20		Myrtle	6335	1
4453A	Gasoline inlet needle	1914-21		20		Mystic	6324	1

Parts for 1909-13 Carburetors supplied by Holley Kerosene Carburetor Co., Detroit, Mich.

*For prices in quantities see special list to Dealers and Garages.

Of the net amount at which these parts are billed to purchasers who purchase direct from the Ford Motor Company (except parts which show no Tax Status, if any) 20/21 represents the price of the goods and 1/21 represents excise tax.

Insist upon genuine Ford parts

Part No.	Name of Part	Year	Specifications	Price	Tax Status	Code Word No.	Fac. No.	Req. per Car
HOLLEY CARBURETOR (MODEL "NH")								
6200	Carburetor complete	1929-21		\$6 00		Mutably	553A3	1
6201	Float with lever	1920-21		50		Mutage	6333B	1
6213	Spray needle assembly	1920-21		20		Mutiny	6335B	1
6217	Gasoline inlet needle	1920-21	Order 4453A					

(Other carburetor parts required may be ordered by plate numbers; prices quoted on application.)

CARBURETOR ATTACHMENTS

4127A	Carb. adjusting rod bracket	1909-21	On dash	05		Lastage	1357	1
4129A	Carb. adjusting rod	1909-21		20		Latten	7920	1
*4130	Carb. flange bolt	1909-21	Order 3072					
*4130B	Carb. flange bolt nut	1909-21	Used on 4130	03		Humbler	517	2
*4134	Carb. flange gasket	1909-21		05	MH	Lecturn	1380B	1
4431	Carb. priming rod	1909-21		05		Loach	2000	1
4582	Carb. hot air pipe	1912-21		20		Monkey	686	1
4583	Priming bell crank	1919-21	Starter type	15		Tenet	7691	1
4585	Priming rod plate	1919-20	Coupe starter type	15		Thrum	7664	1
4586	Priming rod plate	1919-20	Sedan starter type	15		Thurse	7665	1
4587B	Priming rod	1919-21	Sedan starter type	15		Thule	6628	1
4588B	Priming rod	1919-21	Coupe, T. C. & Rbt. starter type	15		Thumb	6627	1
4589	Carburetor priming rod	1919-21	Starter type	05		Thunder	8797B	1

FENDERS—56 INCH TREAD

4800B	Front fender—right	1917-21	All Cars	4 25	MH	Nook	7976	1
4801B	Front fender—left	1917-21	All Cars	4 25	MH	Noose	7977	1
4802F	Rear fender—right	1917-21	All Cars	3 75	MH	Norse	8850	1
4803F	Rear fender—left	1917-21	All Cars	3 75	MH	Nougat	8851	1
4804D	Rear fender iron—right and left	1913-21	Touring car	20		Smile	5405	2
4804E	Rear fender iron—right	1913-21	Torpedo & Coupelet	60		Shire	5563	1
4804F	Rear fender iron—left	1913-21	Torpedo & Coupelet	60		Shrub	5390	1
4804G	Rear fender iron—right or left	1916-17	Sedan	50		Nubble	8154A	2
4804K	Fender iron—right or left	1918-21	Sedan	40		Shoggle	8154B	2
4804L	Rear fender iron	1921	Touring	10		Shophan	7395	2
*4805B	Rear fender iron bolt	1915-21	Touring, $\frac{3}{8}$ " x $\frac{3}{4}$ "	03		Rascal	7171	6
4805C	Rear fender iron bolt nut	1915-21	Used on 4805B	02		Gram	341	6
4806B	Fender eye bolt	1909-21		06		Pepsin	1942	4
4806C	Fender eye bolt washer	1909-21		01		Perish	1943	4
*4806D	Fender eye bolt nut	1909-21	Used on 4806B	03		Eik	29	4
*4808	Front fender iron bolt (side)	1910-21	$\frac{3}{8}$ " x $\frac{3}{4}$ "	03		Module	1323	2
*4808B	Front fender iron bolt (bottom)	1910-21	$\frac{3}{8}$ " x $1\frac{1}{2}$ "	03		Griffin	347	2
*4808D	Front fender iron bolt nut	1910-21	Used on 4808 & 4808B	03		Egret	8	
*4808C	Front fender apron to frame bolt	1915-21	$\frac{1}{4}$ " x $\frac{5}{8}$ "	03		Placid	4088	4
*4808E	Front fender apron to frame bolt nut	1915-21	Used on 4808C	02		Missive	1309	4
4809	Front fender iron—right or left	1909-21		65		Sistom	343	2

RUNNING BOARDS AND SHIELDS—56 INCH TREAD

4812	Running board—right or left	1909-21	.44 $\frac{7}{8}$ " long	2 00	MH	Shrew	5418	1
4814C	Running board shield—right	1917-21	All Cars	2 40	MH	Shrine	7986	1
4815C	Running board shield—left	1917-21	All Cars	2 40	MH	Shroud	7987	1
4816	Running board truss rod—front with nuts	1909-21		50	MH	Skybird	5804	1
4817	Running board truss rod—rear with nuts	1909-21		50	MH	Skyman	5805	1
*4817B	Truss rod nut	1909-21		03		Skyward	339	4
4818	Running board bracket	1909-21		1 00		Skyhawk	336	4
4818B	Running board bracket assembly			1 30		Skyish	2926	2
*4819	Run. board to rear fender bolt	1909-20	$\frac{1}{4}$ " x $1\frac{1}{8}$ "	03		Musty	1344B	4
*4819B	Run. board to rear fender bolt	1921	$\frac{1}{8}$ " x $1\frac{3}{8}$ "	03		Rascal	8161	4
*4819C	Running board to rear fender nut	1909-21	Used on 4819	02		Missive	1309	4
*4819D	Run. board to rear fender nut	1909-21	Used on 4819B and 4820C	02		Harrow	926	
4820	Running board to front fender bolt and nut	1909-20	Order 4808C and 4808E					
4820C	Running board to front fender bolt	1921	Order 4805B					

*For prices in quantities see special list to Dealers and Garages.

Of the net amount at which these parts are billed to purchasers who purchase direct from the Ford Motor Company (except parts which show no Tax Status, if any) 20/21 represents the price of the goods and 1/21 represents excise tax.

Insist upon genuine Ford parts

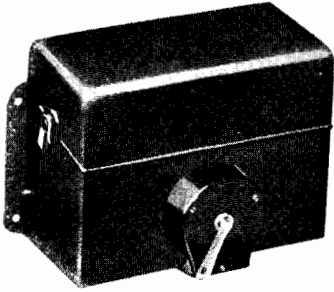

5000

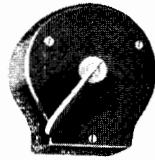

5010

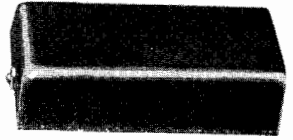

5004



5006



5008

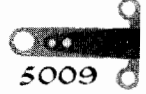

5009



5016

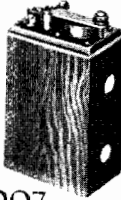

5007

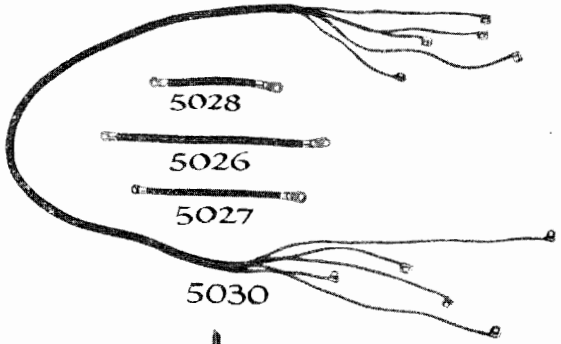

5028

5026

5027

5030

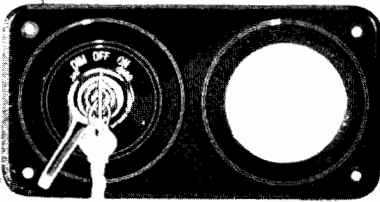

5012

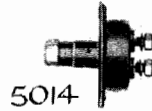

5014



5015



5047



5050



5051

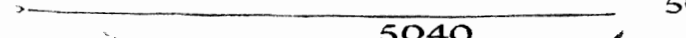

5040



5042



5031



5035



5038



5043



5037

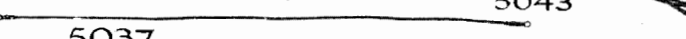

5039

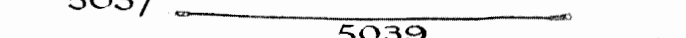

5041



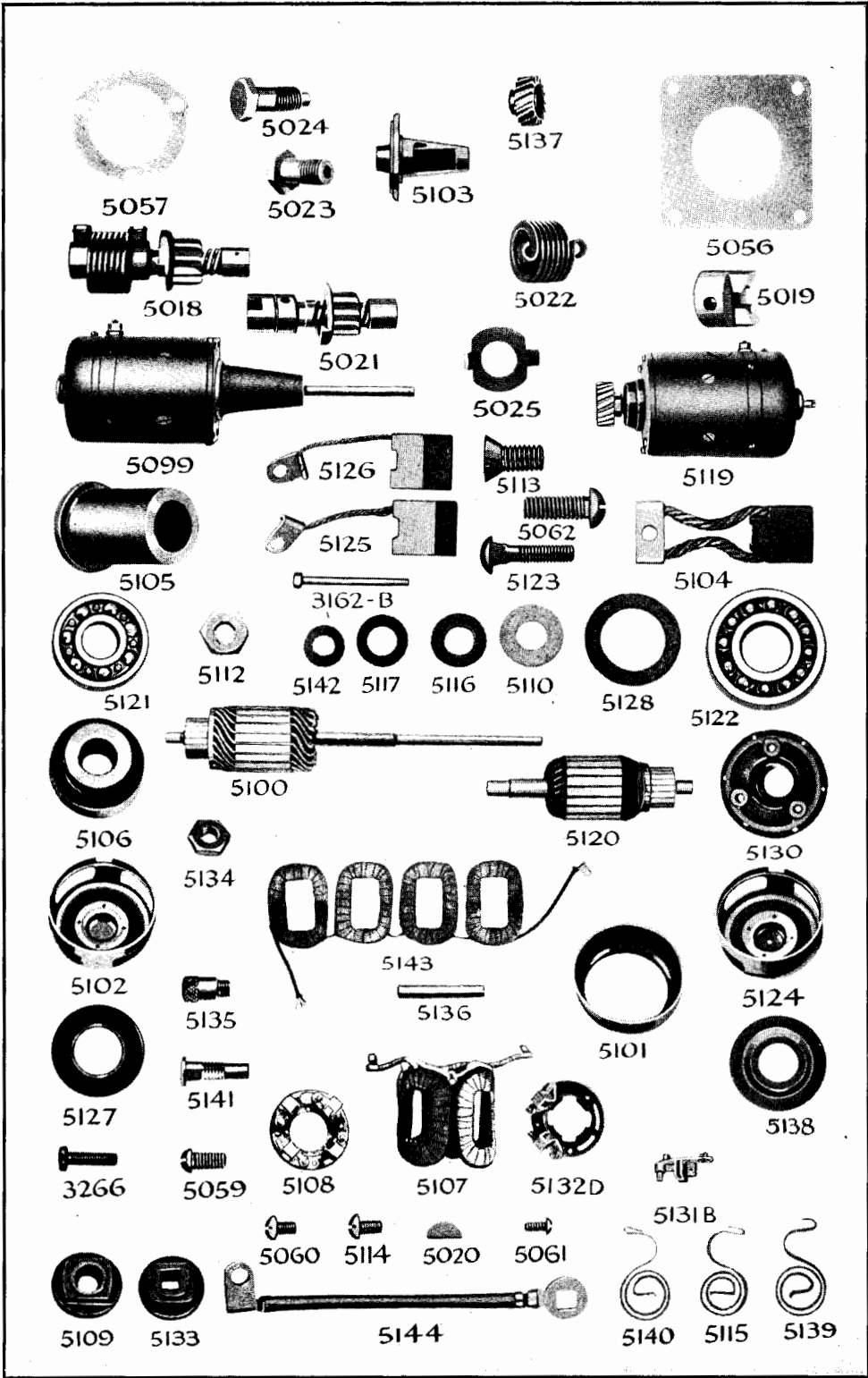

Plate No. 12

Part No.	Name of Part	Year	Price	Tax Status	Code Word	Fac. No.	Req. per Car
RUNNING BOARD—TRUCK							
4830	Running board—right or left	1918-21	75	MH	Gull	TT-5418	2
4831	Running board bracket	1918-21	40		Heck	TT-2926	4
4832	Running board bracket brace	1918-21	15		Hedge	TT-2927	2
4833	Running board bracket rear brace	1918-21	30		Hedging	TT-2929	1
FORD SPARK COIL							
5000	Coil (includes switch)	1909-21	9 75	MH	Negus	1383	1
5001	Coil (starter type)—less switch	1909-21	9 00		Neil	1383B	1
5002	Coil box with cover (includes switch)	1914-21	2 75	MH	Nenia	5858	1
5003	Coil box with cover (starter type)—less switch	1919-21	2 00	MH	Nepeta	5858B	1
5004	Coil box cover	1915-21	30		Neptune	7910	1
5005	Switch cover	1914-17	10		Nonas	5835	1
5005B	Switch cover	1918-21	10		Nonage	5835B	1
*5006	Switch plug	1914-21	05		Nopal	5815	1
5007	Coil unit, 3 1/2" x 2 1/4" x 5"	1914-21	1 75	MH	Noggin	5845	4
*5008	Vibrator with tungsten point	1914-21	07		Nonce	6797	4
*5009	Vibrator bridge with tungsten point	1914-21	10		Novia	6702	4
SWITCH							
5010	Switch assembly (on coil)	1914-21	75		Nidor	5873	1
5012	Switch (ignition) (starter type on instrument board)	1919-21	1 50		Tolad	7675E	1
5013	Keys (switch)—give serial number	1919-21	10		Thrall	5815B	1
5014	Starting switch (on floor board)	1919-21	75		Topaz	8792	1
5015	Extension (starting switch plunger)	1919-21	10		Tetric	8793	1
AMMETER							
5016	Ammeter	1919-21	1 25		Tassel	7680	1
5017	Ammeter lens and rim	1919-21	25		Tensor	8105	1
BENDIX DRIVE							
5018	Bendix	1919-21	5 00		Tattler	1883	1
5019	Head (Bendix)	1919-21	50		Thine	2007	1
5020	Key (Bendix)	1919-21	02		Tholl	1751	1
5021	Shaft and gear (Bendix)	1919-21	4 50		Thuri	2026	1
5022	Spring (Bendix)	1919-21	60		Tinge	2006	1
5023	Screw (Bendix shaft spring)	1919-21	10		Tinsel	1983	1
*5024	Screw (Bendix head spring)	1919-21	05		Tipple	1781	1
5025	Washer (Bendix spring screw lock)	1919-21	03		Tipsy	1782	2
WIRING							
*5026	Spark plug wire 1 1/4" No. 1 cyl.	1909-21	10	MH	Nohob	1365	1
*5027	Spark plug wire (also magneto to coil) 10 1/2" No. 2 cyl.	1909-21	10	MH	Nachor	1366	1
*5028	Spark plug wire, 7" No. 3 and 4 cyls.	1909-21	10	MH	Nalad	1376	2
5029	Spark plug wire terminal	1909-21	01		Nailer	1381	8
5030	COMMUTATOR WIRE (non starter type)	1909-21	65	MH	Nandu	7502	1
5031	Commutator wire (starter type)	1919-21	70	MH	Trifle	7502B	1
5032	Com. wire terminal (coil end)	1909-21	01		Napher	1385	4
5033	Com. wire loom support	1909-21	03		Napple	1390	2
5034	Wire (ammeter to cut-out) Sedan 33"	1919	15	MH	Topic	7683	1
5035	Wire (ammeter to cut-out) Sedan 49"	1919-21	20	MH	Topmast	7683B	1
5036	Wire (ammeter to cut-out) Coupe 23"	1919	15	MH	Torch	7684	1
5037	Wire (ammeter to cut-out) Coupe 41"	1919-21	20	MH	Rabid	7684B	1
5038	Wire (ammeter to ignition switch)	1919-21	10	MH	Torpid	7681	1
5039	Wire (generator to cut-out)	1919	15	MH	Trash	7687	1
5040	Wire (terminal block to switch)	1919-21	05	MH	Trench	8894B	1
5041	Wire (lighting)	1919-21	80	MH	Tromp	7682B	1
5042	Wire (switch) Sedan	1919-21	60	MH	Troth	7685B	1
5043	Wire (switch) Coupe	1919-21	60	MH	Truce	7686B	1
5044	Block (terminal)	1919-21	05		Teller	1950	1
5045	Screw (terminal block to dash)	1919-21	01		Tocsin	2073	2
5046	Cable (battery to switch) 28 1/4"	1919-21	80	MH	Tepor	1889B	1
5047	Cable (battery to switch) 34"	1920	85	MH	Pantry	1889C	1
5048	Cable (ground) 20"	1919	70	MH	Terse	1890	1
5049	Cable (ground) 9 3/4"	1919-21	50	MH	Testa	1890B	1
5050	Cable (ground) 11 1/2"	1920	60	MH	Parish	1890C	1
5051	Cable (switch to motor)	1919-21	65	MH	Tether	1891	1
5052	Bolt (battery cable terminal)	1919-21	04		Pelvis	1937	2
5052B	Nut (battery cable term. bolt) Used on 5052	1919-21	03		Pennon	1938	2
CUT-OUTS							
5054	Cut-out (electric) (dash type)	1919	1 50		Tenant	7677	1
5055	Cut-out (electric)	1919-21	1 50		Tendril	7677B	1
STARTER PARTS							
*5056	Gasket (motor mounting)	1919-21	02		Theme	1768	1
*5057	Gasket (gen. head)	1919-21	02		Thane	1774	1
5058	Screw (gen. mounting, short)	1919-21	03		Thrack	1755	1
5059	Screw (Bendix cover)	1919-21	01		Thrave	1765	1
5060	Screw (term. block to wire)	1919-21	01		Thwack	2015	1
5061	Screw (ammeter to plate)	1919-21	01		Thwart	5819	1
*5062	Screw (motor mounting)	1919-21	02		Thymet	1760	1

*For prices in quantities see special list to Dealers and Garages.

Of the net amount at which these parts are billed to purchasers who purchase direct from the Ford Motor Company (except parts which show no Tax Status, if any) 20/21 represents the price of the goods and 1/21 represents excise tax.

Insist upon genuine Ford parts

Part No.	Name of Part	Year	Price	Tax Status	Code Word	Fac. No.	No. Req. per Car
STARTING MOTOR AND PARTS							
5099	Motor (starting)	1919-21	\$16 00	MH	Tidbit	1877	1
†5100	Armature	1919-21	6 00		Tabid	1940	1
†5101	Band (cover)	1919-21	10		Tallage	1801C	1
5102	Bracket (brush end)	1919-21	50		Talmen	1868	1
5103	Bracket assem. (mounting)	1919-21	1 60		Tawny	2037	1
5104	Brush	1919-21	30		Tanvat	1806	1
5105	Bushing (shaft, rear)	1919-21	30		Tapnet	1759	1
5106	Bushing (shaft, front)	1919-21	15		Tapster	1789	1
5107	Coil assembly (field)	1919-21	2 00		Targum	1871	1
5108	Holder assem. (brush)	1919-21	60		Talpa	1864B	1
*5109	Insulator (terminal, outer)	1919-21	03		Talus	1795	1
†5110	Insulator (terminal, inner)	1919-21	02		Tambac	1794	1
*5112	Nut (terminal)	1919-21	03		Tambour	1791	1
†5113	Screw (field)	1919-21	02		Tamis	1788	1
†5114	Screw (brush end bracket to yoke)	1919-21	05 doz.		Tamkin	1808	1
*5115	Spring (brush tension)	1919-21	05		Tampon	1809	1
5116	Washer (terminal)	1919-21	02		Tarras	1792	1
5117	Washer (terminal, inner, steel)	1919-21	02		Tarsic	1798	1
5118	Yoke (motor) assembly	1919-21	5 00		Tartly	1852	1

GENERATOR AND PARTS

5119	Generator	1919-21	16 00	MH	Tetter	1879	1
†5120	Armature (less bearings)	1919-21	6 00		Tanling	1925	1
5121	Bearing (small)	1919-21	1 20		Tannic	1838	1
5122	Bearing (large)	1919-21	1 45		Tantrum	1841	1
5123	Bolt (terminal)	1919-21	03		Tegmen	1836	1
5124	Bracket (brush end)	1919-21	40		Telary	1894	1
5125	Brush (large)	1919-21	20		Tempean	1844	1
5126	Brush (small)	1919-21	20		Tempter	1845	1
5127	Disc (large bearing)	1919-21	03		Tendry	1847	1
5128	Felt (small bearing)	1919-21	03		Tenter	2033	1
5130	Head	1919-21	50		Tercel	2044	1
5131B	Holder (small brush)	1919-21	15		Termor	1821	1
5132B	Ring (brush holder)	1919-21	05		Terrapin	1996	1
5132C	Holder assem. (brush)	1919-21	60		Ternary	1865	1
5132D	Holder assem. (brush) less small brush holder	1919-21	45		Ternate	1920	1
*5133	Insulator (terminal, outer)	1919-21	03		Terras	1827	1
5134	Nut (terminal)	1919-21	03		Tilling	1818	1
5134B	Nut (small brush holder stud)	1919-21	02		Tilmus	6754	1
*5135	Oiler	1919-21	10		Testern	1837	1
5136	Pin (pinion to shaft)	1919-21	05 doz.		Testudo	1750	1
5137	Pinion	1919-21	40		Throng	1752	1
5138	Retainer (small bearing felt)	1919-21	02		Theban	1832	1
*5139	Spring (large brush)	1919-21	05		Thelst	1967	1
*5140	Spring (small brush)	1919-21	05		Themis	1988	1
5141	Stud (small brush holder)	1919-20	05		Theon	1823B	1
*5141B	Stud (small brush holder)	1919-21	02		Theoric	1823C	1
*5142	Washer (terminal)	1919-21	02		Thermal	1831	1
5142B	Washer (small brush holder stud)	1919-21	05 doz.		Phrase	2058	1
5143	Winding assembly (field)	1919-21	1 50		Tholus	1978	1
5144	Wire (brush to terminal)	1919-21	08		Thorp	1851	1
5145	Yoke (generator) assembly	1919-21	4 00		Thorite	1887	1

BATTERY BRACKET AND PARTS

5150	Bracket assem.	1919-21	90		Tattoo	8841	1
5151	Bolt (clamp)	1919-21	03		Rustic	8846	1
*5151B	Nut (clamp bolt) Used on 5151	1919-21	03		Elk	29	1
5152	Clamp	1919-21	05		Tetrad	8844	1

BATTERY (FORD)

5175	Battery	1919-21	25 00	MH	Twain	7670	1
------	---------	---------	-------	----	-------	------	---

SPARK PLUGS

5200	Spark plug (Bethlehem)	1909-21	60		Tirrit	1386A2	4
5201	Spark plug (Champion)	1909-21	75		Tirzah	1386A1	4
5202	Spark plug porcelain (Bethlehem)	1909-21	35		Titla	3761	4
5203	Spark plug porcelain (Champion)	1909-21	40		Titling	3760	4

*For prices in quantities see special list to Dealers and Garages.

†Also for generator.

‡Armature may be exchanged with dealer at \$5.00.

Of the net amount at which these parts are billed to purchasers who purchase direct from the Ford Motor Company (except parts which show no Tax Status, if any) 20/21 represents the price of the goods and 1/21 represents excise tax.

Insist upon genuine Ford parts

Part No.	Name of Part	Year	Specifications	Price	Tax Status	Code Word	Fac. No.	No. per Car	Req.
REPAIR TOOLS									
1349	Hub cap wrench		Regular equipment	\$ 0 20		Pacal		1349	
1387	Adjustable wrench		Regular equipment	50		Pacos		1387	
1903	Pliers		Regular equipment	25		Paddy		1903	
1917	Double end wrench		Regular equipment	20		Pagan		1917	
2335	Spark plug and cyl. head bolt wrench								
2336	Tool roll		Regular equipment	50		Pavid		5893	
2337	Oil can		Regular equipment	30		Pawky		1979	
2338	Tire pump		Regular equipment	30		Paxos		1384	
2340	Tire irons, each		Regular equipment	1 75		Payer		1368	
2343	Jack		Regular equipment	1 15		Pelage		4069	
3Z-619	Crank shaft bearing bolt wrench			50		Pelox		3389	
3Z-698	Cylinder water outlet connecting screw brace wrench								
5Z-152	Brake shoe support bolt brace wrench								
5Z-152	D/S bearing housing screw brace wrench								
5Z-152	Rear axle housing bolt nut wrench Old No. 3Z-616			40		Parvis			
5Z-153	Socket wrench for crank shaft bearing bolt nut Old No. 3Z-644			60		Passim			
5Z-154	Body bracket connecting bolt R. & L. wrench Old No. 3Z-719			40		Proverb.			
5Z-155	3/8" L socket wrench Old No. 3Z-645 and 3Z-755			45		Pastel			
5Z-156	Crank shaft bearing bolt wrench Old No. 3Z-782			50		Poloy			
5Z-157	Connecting rod cap bolt nut L wrench (Cylinder No. 4) Old No. 3Z-2010			40		Quack			
5Z-158	Drive shaft housing stud nut wrench for 1/2" nut Old No. 3Z-620			50		Parent			
5Z-159	Connecting rod T wrench Old No. 3Z-783			75		Pygmy			
5Z-160	3/8" T socket wrench Old No. 3Z-643			75		Parfit			
5Z-161	Body bracket connecting bolt T wrench, front and center Old No. 3Z-673			65		Prater			
5Z-162	Large cam gear lock nut wrench Old No. 3Z-655			55		Pavan			
5Z-163	Generator third brush adjusting wrench Old No. 3Z-4137			25		Quaver			
5Z-165	Drive shaft pinion T wrench Old No. 3Z-790			70		Puzzle			
5Z-193	Spindle cone adjusting open end wrench Old No. 3Z-699			30		Profile			
5Z-195	3/4" open end wrench Old No. 3Z-646			30		Pastor			
5Z-196	Rear axle entering wrench Old No. 3Z-627			40		Potlon			
5Z-204	Exhaust pack nut open end wrench Old No. 3Z-624			1 00		Potash			
5Z-206	Rear axle nut open end wrench Old No. 3Z-675			70		Porite			
5Z-209	Connecting rod clamp screw wrench Old No. 3Z-647			45		Parrot			
5Z-210	Fly wheel cap screw wrench Old No. 3Z-1179			75		Palmy			
5Z-212	Body bracket connecting bolt holding open end wrench Old No. 3Z-686			30		Preen			
5Z-232	Spindle arm bushing driver Old No. 3Z-1956			40		Quinsy			
5Z-249	Generator third brush adjusting wrench New Style			25		Quatch			
5Z-280	Valve grinder Old No. 3Z-604			75		Palster			
5Z-285	1/2" hex. brace wrench Old Nos. 3Z-698 and 3Z-786			75		Prince			
5Z-286	Rear axle nut and housing plug brace wrench Old No. 3Z-751			80		Pulpit			
5Z-287	Rear wheel puller assembly Old No. 3Z-612			1 25		Panary			
5Z-289	3/4" brace socket wrench Old No. 3Z-1173 and 3Z-1223B			85		Parsee			
5Z-290	Piston ring squeezer Old No. 3Z-652			30		Patile			
5Z-313	Fixture for assembling roller bearing cups Old No. 3Z-2316			8 00		Quaffer			
5Z-314	Transmission clutch disc drum puller Old No. 3Z-614			1 00		Papaw			
5Z-319	Valve spring lifter Old No. 3Z-4730			40		Palpus			
5Z-322	Tire iron (large) Old No. 3Z-703			50		Pathos			
5Z-323	Bendix shaft head puller Old No. 3Z-4712			1 25		Queach			
5Z-324	Trans. band ratchet wrench Old No. 3Z-2034			50		Poplin			
5Z-325	Connecting rod cap bolt nut brace wrench with universal joint for No. 4 connecting rod Old No. 3Z-2304			2 50		Quadra			
5Z-326	Small time gear and trans. driven gear puller Old No. 3Z-611			1 50		Pantle			
16Z-4992	Large time gear puller			11 00		Queasy			
20Z-340	Valve seat reamer Old No. 3Z-617-1			2 75		Papula			
20Z-340-1	Valve seat reamer cutter Old No. 3Z-617-2			1 65		Papur			
21Z-356	Valve seat reamer handle Old No. 3Z-617-3			1 10		Pasha			
REPAIR TOOLS—TRUCK									
5Z-288	Rear wheel puller assembly Old No. 3Z-2257			1 50		Hock			
3389X	Jack			3 00		Hog			
COTTER PINS									
		Fac. No.					Fac. No.		
1/2" x 1" cotter pins		421	3/8" x 1/2" cotter pins				66		
3/8" x 3/8" cotter pins		753	1/2" x 1/2" cotter pins				544		
1/2" x 1" cotter pins		82	3/8" x 3/8" cotter pins				88		
Price, per dozen				\$0 05					
Price, per gross				25					
Price, per thousand				75					

Of the net amount at which these parts are billed to purchasers who purchase direct from the Ford Motor Company (except parts which show no Tax Status, if any) 20/21 represents the price of the goods and 1/21 represents excise tax.

Insist upon genuine Ford parts

Price List of Accessories and Accessory Parts

Part No.	Name of Part	Make	Year	Code	Price	Tax Status
ELECTRIC HORN						
6432X	Electric horn complete			Ulcer	\$ 2 50	
7915X	Electric horn terminal wire 9"			Ultra	05	MH
7917X	Electric horn to switch wire 35 $\frac{1}{8}$ "			Ultra	15	MH
8028X	Horn switch assembly			Valiant	30	MH
ELECTRIC HEAD LAMPS (STANDARD 1915-21)						
6511BX	Head lamp assembly—used with dimmer on magneto current (when used on magneto current without dimmer use T 6572X bulb) per pair			Unific	7 00	
6511CX	Head lamp assembly—two bulb type—per pair			Unport	7 00	
6511DX	Head lamp assembly—with "Tu-Lite" frosted bulb—per pair			Unalist	7 00	
6511EX	Head lamp assembly—with "Tu-Lite" clear bulb—per pair			Unbias	7 00	
6594X	Head lamp door assembly—used with 6511DX			Union	55	
6594BX	Head lamp door assembly—with green visor lens			Unitor	65	
6589X	Head lamp switch assembly—with screws			Ural	35	
8650X	Head lamp and horn switch assembly			Urith	40	MH
8892X	Dimmer resistance coil with wires			Urbox	70	MH
6572DX	Head lamp bulb "Tu-Lite" double filament—frosted			Urgla	55	
6572EX	Head lamp bulb "Tu-Lite" double filament—clear			Uriel	55	
6578X	Head lamp door lens gasket			Urchin	05	
6576X	Head lamp door lens—8 $\frac{1}{8}$ "—used with 6511DX			Urn	15	
*6576BX	Head lamp door lens—8 $\frac{1}{8}$ "—with green visor			Uredo	25	
6592X	Head lamp plug—with thimble			Urus	15	
6585X	Head lamp reflector			Urva	1 00	
6585BX	Head lamp reflector (dimmer type)			Urbo	1 00	
6580X	Head lamp focusing screw			Utas	05	
6591X	Head lamp focusing screw spring			Ute	03	
6574X	Head lamp bulb socket			Vagrant	15	
6586X	Head lamp reflector spring			Vail	05	
7487X	Switch to terminal wire—11 $\frac{1}{4}$ " long			Valise	05	MH
7489X	Lamp to lamp wire—40" long			Vallum	15	MH
7490X	Lamp to ground wire—10 $\frac{3}{4}$ " long			Vamp	05	MH
SIDE OIL AND TAIL LAMPS—1915-21						
6561X	Side oil lamp, per pair			Van	4 50	
6568X	Tail lamp			Vandal	2 50	
7669X	Electric tail lamp assembly			Vanquish	1 00	
6484BX	Electric tail lamp red lens			Vales	15	
6495X	Electric tail lamp bulb socket			Valgius	20	
6599X	Side oil and tail lamp fount			Vane	50	
6956X	Side oil lamp door			Vanish	50	
6957X	Tail lamp door			Vapid	30	
6966X	Tail lamp white lens and frame			Vapor	20	
6460X	Lamp burner including wick			Varix	30	
6483X	Side oil lamp door lens			Vat	15	
6392X	Lamp wick			Vega	05	
TOURING CAR AND TORPEDO WINDSHIELDS—1915-21						
††7840X	Windshield assembly, less brackets, bolts, nuts and washers			Vender	13 50	MH
7818BX	Windshield hinge assembly—right		1917-21	Vent	40	
7819BX	Windshield hinge assembly—left		1917-21	Verb	40	
7820AX	Windshield upper frame assembly		1915-16	Verge	1 50	
7820BX	Windshield frame assembly—upper		1917-21	Vermin	1 50	
7822AX	Windshield upper half assembly		1915-16	Verse	6 50	MH
7822BX	Windshield upper half assembly		1917-21	Verst	6 50	MH
7823X	Windshield lower half assembly		1915-21	Vertex	7 00	MH
7802X	Windshield lower frame only		1915-21	Venge	1 00	
7803X	Windshield lower frame filler block		1915-21	Verve	20	
7839X	Windshield frame filler block		1915-16	Vervet	15	
7888X	Windshield block (frame filler)—upper		1917-21	Vesper	15	
7810X	Windshield hinge bolt		1915-16	Vespid	05	
7845X	Windshield bracket—right		1915-21	Vestal	60	
7845BX	Windshield bracket—right		1919-21	Vestado	50	
7846X	Windshield bracket—left		1915-21	Vestry	60	
7846BX	Windshield bracket—left		1919-21	Vexil	50	
7824X	Windshield glass clamp		1915-21	Veto	05	
7801X	Windshield frame—upper		1915-16	Vial	75	
7887X	Windshield frame—upper		1917-21	Vicar	75	
7890X	Windshield hinge—lower left		1917-21	View	15	

*For prices in quantities see special list to Dealers and Garages.

††Order 7845X-7846X extra for 1915-16 cars.

Of the net amount at which these parts are billed to purchasers who purchase direct from the Ford Motor Company (except parts which show no Tax Status, if any) 20/21 represents the price of the goods and 1/21 represents excise tax.

Insist upon genuine Ford parts



6511-EX

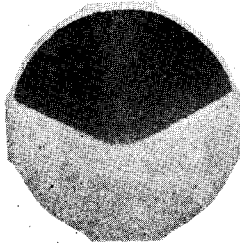

6576-BX

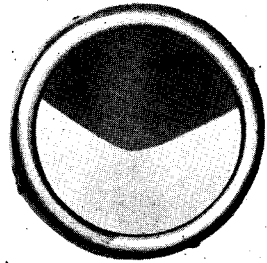

6594BX



6574-X



6592-X

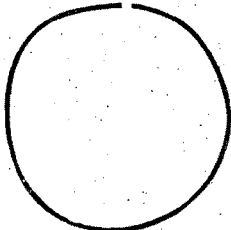

6578-X



6585-X

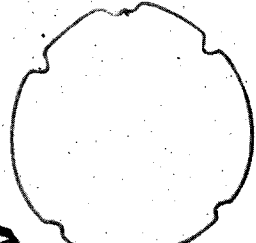

6586-X



6572-X



8028-X



7489-X



6460-X



7487-AX



7490-X



8892-X



6599-X

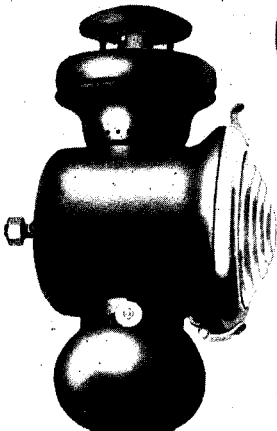

6561-X

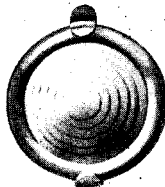

6956-X

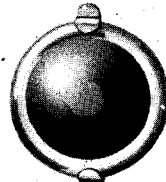

6957-X

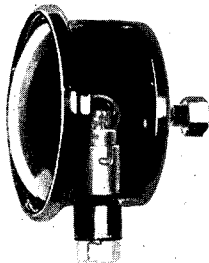

7669-X

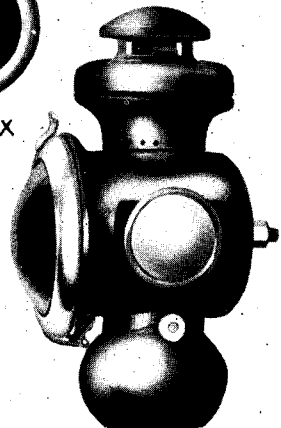

6568-X

Part No.	Name of Part	Make	Year	Code	Price	Tax Status
TOURING CAR AND TORPEDO WINDSHIELDS—1915-21—Continued						
7805X	Windshield left hand upper hinge		1915-21	Viking	\$ 0 15	
7889X	Windshield hinge—lower right		1917-21	Vim	15	
7807X	Windshield right hand upper hinge		1915-21	Vina	15	
3827X	Windshield top snap loop		1915-21	Vine	05	
1154X	Windshield hinge bolt nut		1915-21	Vintage	03	
2449BX	Windshield glass clamp screw		1915-21	Viol	01	
2257BX	Windshield hinge to frame screw		1915-21	Virent	02	
*292X	Windshield hinge spring (Order T2742)					
7851X	Windshield upper glass stop—nickel		1915-21	Vise	25	
7852X	Windshield lower glass stop—nickel		1915-21	Vitals	25	
7808X	Windshield hinge thimble		1915-21	Vitex	05	

TOURING CAR TOPS—1915-21

†7940X	Touring car top complete		1915-21	Warm		MH
6882X	Touring car storm curtain (R. H.)		1915-21	Warp	2 00	MH
6883X	Touring car storm curtain (L. H.)		1915-21	Warren	2 00	MH
4966BX	Touring car side curtain (R. H.)		1915-21	Wart	2 50	MH
4967BX	Touring car side curtain (L. H.)		1915-21	Wash	2 50	MH
6894X	Touring car center deck complete		1915-21	Wasp	7 50	MH
6886X	Touring car center deck only 91½" x 50"		1915-21	Waste	4 50	
8913X	Touring car side quarter (R. H.)		1915-21	Watch	1 50	
8914X	Touring car side quarter (L. H.)		1915-21	Water	1 50	
6815X	Touring car side quarter pad		1915-21	Watt	1 00	
6940X	Touring car back stay and curtain assembly		1915-21	Wax	3 00	MH
3897X	Touring car wood bow		1913-17	Weapon	75	
8973X	Touring car front and rear extension rib		1918-21	Yawn	40	
8974X	Touring car front and rear upright rib		1918-21	Yell	40	
4596X	Touring car bow separator—male		1913-17	Wedge	05	
4597X	Touring car bow separator—female		1913-17	Weed	05	
6832X	Touring car bow separator		1918-21	Whelp	05	
6860AX	Touring car front extension bow socket (R. H.)		1915-17	Weep	1 00	
6860BX	Touring car front extension rib socket (R. H.)		1918-21	Wealth	1 00	
6861AX	Touring car front extension bow socket (L. H.)		1915-17	Weir	1 00	
6861BX	Touring car front extension rib socket (L. H.)		1918-21	Weary	1 00	
3884AX	Touring car rear extension bow socket (R. H.)		1913-17	Weld	1 00	
3884BX	Touring car rear extension rib socket (R. H.)		1918-21	Wedding	1 00	
3885AX	Touring car rear extension bow socket (L. H.)		1913-17	Welkin	1 00	
3885BX	Touring car rear extension rib socket (L. H.)		1918-21	Welt	1 00	
6862AX	Touring car front upright bow socket (R. H.)		1915-17	Well	1 00	
6862BX	Touring car front upright rib socket (R. H.)		1918-21	Whig	1 00	
6863AX	Touring car front upright bow socket (L. H.)		1915-17	Welsh	1 00	
6863BX	Touring car front upright rib socket (L. H.)		1918-21	Whilk	1 00	
3882AX	Touring car rear upright bow socket (R. H.)		1913-17	West	1 00	
3882BX	Touring car rear upright rib socket (R. H.)		1918-21	Yauk	1 00	
3883AX	Touring car rear upright bow socket (L. H.)		1913-17	Wether	1 00	
3883BX	Touring car rear upright rib socket (L. H.)		1918-21	Yawl	1 00	
7831X	Curtain to windshield hook		1915-21	Whame	03	
7832X	Curtain to body hook		1915-21	Whaul	03	
6837X	Touring car key strap assembly		1913-18	Whale	05	
8992X	Rib socket cotter		1918-21	Wheeze	05	
3924X	Touring car top to windshield strap assembly		1915-21	Wharf	25	
3629X	Touring car rear stay strap assembly complete		1913-21	Wheat	40	
6925X	Touring car curtain to windshield strap assembly		1915-19	Whine	10	
6926X	Touring car curtain to lamp bracket strap assembly		1915-19	Whip	10	
3754X	Touring car curtain glove fastener assembly		1913-21	Whist	05	
6829AX	Touring car duquesne clip—upper		1914-17	Whoop	05	
6829BX	Touring car extension support—upper		1918-21	Yeik	10	
6830AX	Touring car duquesne clip—lower		1914-17	Wick	05	
6830BX	Touring car extension support—lower		1918-21	Yeoman	05	
8937X	Touring car top snap fastener—single		1917-21	Wig	05	
8938X	Touring car top snap fastener—double		1917-21	Willow	05	
3314X	Touring car top prop rest with strap		1913-21	Wind	60	
3858X	Touring car top prop rest arm		1913-21	Wine	25	
3624X	Touring car bow socket to seat iron japanned nut		1913-21	Wing	05	
3383X	Curtain celluloid 20" x 36"—.015 thick		1913-21	Wink	1 60	
3383X	Curtain celluloid 10" x 18"—.015 thick		1913-21	Winter	40	
4991X	Touring car top visor		1920-21	Wizen	50	

*For prices in quantities see special list to Dealers and Garages.

†Inquire of Branch or Dealer for price.

Of the net amount at which these parts are billed to purchasers who purchase direct from the Ford Motor Company (except parts which show no Tax Status, if any) 20/21 represents the price of the goods and 1/21 represents excise tax.

Insist upon genuine Ford parts

Part No.	Name of Part	Make	Year	Code	Price	Tax Status
TORPEDO TOP PARTS—1915-21						
††7941X	Torpedo top complete		1915-21	Wisdom		MH
4971X	Torpedo top—second and third wood bows		1914-18	Wish	\$ 0 50	
6929X	Torpedo top—first bow		1915-18	Wisp	50	
8772X	Rib—upright		1918-21	Wenny	40	
8988X	Rib—front extension		1918-21	Wept	40	
8989X	Rib—rear extension		1918-21	Westing	40	
6870X	Torpedo top bow socket—upright—(R. H.)		1915-18	Witch	1 25	
6870BX	Torpedo top rib socket—upright—(R. H.)		1918-21	Whaling	1 25	
6871X	Torpedo top bow socket—upright—(L. H.)		1915-18	Withe	1 25	
6871BX	Torpedo top rib socket—upright—(L. H.)		1918-21	Wheedle	1 25	
6872X	Torpedo top bow socket—front extension—(R. H.)		1915-18	Wizard	1 00	
6872BX	Torpedo top rib socket—front extension—(R. H.)		1918-21	Whelm	80	
6873X	Torpedo top bow socket—front extension—(L. H.)		1915-18	Witness	1 00	
6873BX	Torpedo top rib socket—front extension—(L. H.)		1918-21	Wherry	80	
4907X	Torpedo top bow socket—rear extension—(R. H.)		1913-18	Wolf	1 00	
4907BX	Torpedo top rib socket—rear extension—(R. H.)		1918-21	Whestit	1 00	
4908X	Torpedo top bow socket—rear extension—(L. H.)		1913-18	Woman	1 00	
4908BX	Torpedo top rib socket—rear extension—(L. H.)		1918-21	Whewer	1 00	
6937X	Torpedo top side curtain—rear—(R. H.)		1915-21	Wood	1 50	MH
6938X	Torpedo top side curtain—rear—(L. H.)		1915-21	Word	1 50	MH
6935X	Torpedo top side curtain—front—(R. H.)		1915-21	Work	2 00	MH
6936X	Torpedo top side curtain—front—(L. H.)		1915-21	World	2 00	MH
6950X	Torpedo top back curtain assembly		1915-21	Worm	2 50	MH
6965X	Torpedo top center deck complete		1915-21	Worry	4 50	MH
6964X	Torpedo top deck only		1915-21	Wrap	2 50	
6962X	Torpedo top side quarter—(R. H.)		1915-21	Wreck	1 00	
6963X	Torpedo top side quarter—(L. H.)		1915-21	Wren	1 00	
6806X	Torpedo top side quarter pad		1914-21	Wrist	60	
3877X	Torpedo top prop rest with strap		1913-21	Yam	60	
4955X	Torpedo top visor		1920-21	Yamper	50	

†† Inquire of Branch or Dealer for price.

Of the net amount at which these parts are billed to purchasers who purchase direct from the Ford Motor Company (except parts which show no Tax Status, if any) 20/21 represents the price of the goods and 1/21 represents excise tax.

Insist upon genuine Ford parts

Price List of Parts for Model T One Ton Truck

Part No.	Name of Part	Year	Price	Tax Status	Code Word	Model	Fac. No.	Req. per Car		
REAR AXLE										
1000	Rear axle assembly	1918-21	\$200	00	MH	Abed	TT	95	1	
1001	Axle housing—right	1918-21	20	00	MH	Abyss	TT	4	1	
1002	Axle housing—left	1918-21	20	00	MH	Acme	TT	5	1	
1003	Axle housing bolt	1918-21		04		Avail	TT	52	13	
1003B	Axle housing bolt nut Used on 1003	1918-21		03		Bashful	T220	13		
1004	Axle housing cap	1918-21		60	MH	Actor	TT	133	1	
*1005	Axle housing cap gasket	1918-21		02		Acute	TT	134	1	
1006	Axle housing cap screw	1918-21		05		Adder	TT	72	4	
1007	Axle housing cap screw lock wire	1918-21		02		Addle	TT	140	1	
1008	Axle housing gasket—upper	1918-21		02		Agate	TT	138	1	
1009	Axle housing gasket—lower	1918-21		06		Agast	TT	139	1	
1010	Axle brake housing plate—right	1918-21		50	MH	Agile	TT	147	1	
1011	Axle brake housing plate—left	1918-21		50	MH	Akin	TT	148	1	
1012	Axle housing drain plug	1918-21		05		Alder	TT	136	2	
1013	Axle shaft	1918-21		5	00	MH	Alex	TT	48	2
1014	Axle shaft cotter	1918-21		01		Alms	TT	165	2	
*1015	Axle shaft nut	1918-21		15		Aloe	TT	166	2	
*1016	Axle shaft washer	1918-21		05		Aloft	TT	135	2	
1017	Axle shaft dust cap	1918-21		05		Alpha	TT	56	2	
1018	Axle shaft inner ball bearing assembly	1918-21		6	50	Alpine	TT	125	2	
1019	Axle shaft outer roller bearing	1918-21		1	75	Archer	TT	171	2	
1020	Axle shaft outer roller bearing sleeve	1918-21		60		Arena	TT	170	2	
*1021	Axle shaft bearing felt	1918-21		10		Argue	TT	143	4	
1022	Axle shaft bearing retainer	1918-21		10		Ark	TT	20	2	
*1023	Axle shaft bearing retainer washer	1918-21		05		Arson	TT	23	2	
1024	Axle shaft felt retainer assembly	1918-21		15		Astral	TT	144	2	
1025	Axle shaft felt retainer cup	1918-21		05		Atwist	TT	145	2	
1026	Axle shaft felt retainer plate	1918-21		03		Atoll	TT	146	2	
1027	Diff. gear	1918-21		1	50	MH	Aura	TT	13	2
1028	Diff. gear case R or L. half	1918-21		2	50	MH	Author	TT	11	2
1029	Diff. gear case bolt	1918-21		04		Avail	TT	52	8	
1031	Diff. gear lock ring	1918-21		05		Avoke	TT	118	2	
1032	Diff. pinion	1918-21		80	MH	Awake	TT	14	2	
1033	Diff. pinion shaft	1918-21		30		Awry	TT	15	1	
1034	Drive shaft	1918-21		10	00	MH	Bait	TT	87	1
1036	D. S. tube assembly	1918-21		15	00	MH	Balm	TT	153	1
*1037	D. S. tube flange gasket	1918-21		02		Bandit	TT	194	1	
1038	D. S. tube flange screw	Order 1006								
1039	D. S. felt	1918-21		10		Basil	TT	109	1	
1040	D. S. felt container	1918-21		05		Beaver	TT	110	1	
1041	D. S. to worm coupling	1918-19		1	20		Behind	TT	85	1
1041B	D. S. to worm coupling	1920-21		1	20		Bhang	TT	85B	1
1042	D. S. to worm coupling pin	1918-21		03		Behold	TT	86	2	
1043	Worm	1918-21		15	00	MH	Berg	TT	16	1
1043B	Worm—5 1/4 to 1	1918-21		15	00	MH	Bernese	TT	16B	1
1044	Worm gear	1918-21		16	00	MH	Bible	TT	12	1
1044B	Worm gear—5 1/4 to 1	1918-21		16	00	MH	Bifilar	TT	12B	1
1045	Worm cotter	Order 1014								
1046	Worm roller bearing	1918-21		1	30		Bight	TT	108	2
1047	Worm roller bearing retainer	1918-21		05		Bigot	TT	106	1	
1048	Worm roller bearing sleeve	1918-21		2	00		Bigot	TT	107	2
1049	Worm roller bearing housing screw	1918-21		05		Birch	TT	101	2	
1050	Worm thrust bearing collar	1918-21		1	00		Bird	TT	114	2
1051	Worm thrust ball and separator assembly	1918-21		1	25		Bitter	TT	123	1
1052	Worm thrust bearing plate	1918-21		15		Blaze	TT	22	1	
1053	Worm thrust bearing retainer	1918-21		40		Bleach	TT	111	1	
*1054	Worm thrust bearing retainer nut	Order 1015	1918-21							
1055	Worm thrust bearing retainer pin	1918-21		03		Blend	TT	112	1	
1056	Brake shoe	1918-21		2	50	MH	Blind	TT	2814	2
1057	Brake shoe lining, each	1918-21		40	MH	Blink	TT	58	4	
1058	Brake shoe lining rivet	1918-21		dz.	10		Blue	TT	68	40
1059	Brake shoe spring	1918-21		10		Blunt	TT	67	2	
1060	Brake shoe bolt	1918-21		15		Scion	TT	59	2	
1060B	Brake shoe bolt nut Used on 1060	1918-21		06		Bengal	T242	2		
1061	Brake expander	1918-21		60		Bodkin	TT	61	2	
1062	Brake expander lever	1918-21		20		Booth	TT	62	2	
1064	Brake expander adjustment collar	1918-21		25		Brig	TT	175	2	
1065	Brake expander bushing	1918-21		15		Bronze	TT	173	2	
1066	Brake expander pin	1918-21		01		Brook	TT	7	2	
1067	Brake expander link	1918-21		08		Broom	TT	176	4	
1068	Brake expander link pin	1918-21		05		Brow	TT	177	8	
1069	Brake rod	1918-21		50	MH	Brush	TT	119	2	
1070	Brake rod support—right	1918-21		10		Buck	TT	120	1	
1071	Brake rod support—left	1918-21		10		Bug	TT	121	1	
1072	Brake rod support bolt	1918-21		03		Serene	T7181	2		
1072B	Brake rod support bolt nut Used on 1072	1918-21		02		Missive	T1309	2		
1073	Rear radius rod	1918-21		6	00		Burn	TT	152	2
1074	Rear radius rod bolt—front	1918-21		20		Acclaim	TT	84	1	
1075	Rear radius rod bolt—rear	1918-21		15		Abscind	TT	83	4	
1075B	Rear radius rod bolt nut Used on 1074 & 1075	1918-21		06		Bengal	T242	2		
1076	Universal joint bushing	1918-21		50		Crape	TT	69	1	

*For prices in quantities see special list to Dealers and Garages.

Of the net amount at which these parts are billed to purchasers who purchase direct from the Ford Motor Company (except parts which show no Tax Status, if any) 20/21 represents the price of the goods and 1/21 represents excise tax.

Insist upon genuine Ford parts

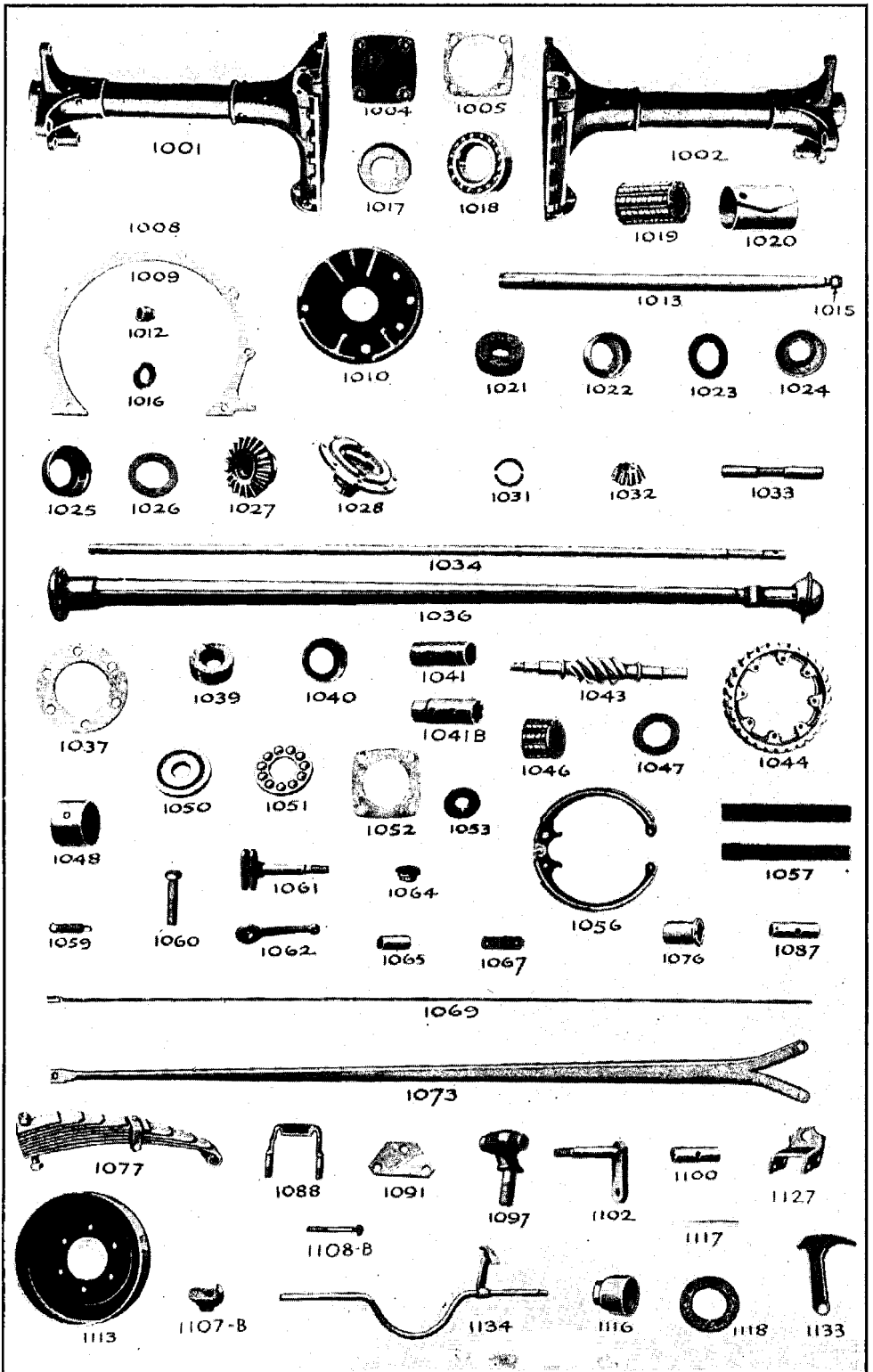

Plate No. 14

Part No.	Name of Part	Year	Price	Tax Status	Code Word	Fac. No. Model	Req. per car
SPRING							
1077	Rear spring—right or left, each	1918-21	\$ 5 50	MH	Cream	TT 333	2
1078	Spring leaf No. 1	1918-21	1 20		Creed	TT 334	2
1079	Spring leaf No. 2	1918-21	70		Crew	TT 362	2
1080	Spring leaf No. 3	1918-21	65		Grib	TT 364	2
1081	Spring leaf No. 4	1918-21	55		Croap	TT 365	2
1082	Spring leaf No. 5	1918-21	45		Croak	TT 366	2
1083	Spring leaf No. 6	1918-21	40		Crowp	TT 367	2
1084	Spring leaf No. 7	1918-21	35		Crow	TT 368	2
1085	Spring leaf No. 8	1918-21	30		Crowd	TT 331	2
1086	Spring leaf No. 9	1918-21	20		Crumb	TT 332	2
1087	Spring bushing	1918-21	45		Crusher	TT 326	2
1088	Spring clip	1918-21	15		Cry	TT 327	4
*1089	Spring clip nut	1918-21	25		Cuff	TT 329	2
1091	Spring clip plate	1918-21	35		Cult	TT 330	2
1092	Spring tie bolt	1918-21					
*1093	Spring tie bolt nut. Order 1089	1918-21					
1094	Spring tie bolt cotter	1918-21	01		Cure	TT 328	2
1095	Spring clamp	1918-21	10		Curl	TT 375	2
1096	Spring clamp bolt	1918-21	04		Curse	TT 376	2
*1096B	Spring clamp bolt nut Used on 1096	1918-21	02		Harrow	T926	2
1097	Spring perch	1918-21	1 00	MH	Dale	TT 2804	2
*1098	Spring perch nut. Order 1015	1918-21					
1099	Spring perch cotter. Order 1014	1918-21					
1100	Spring perch bushing	1918-21	30		Demon	TT 172	2
1101	Spring perch bushing spacer	1918-21	05		Dean	TT 169	4
1102	Spring hanger assembly	1918-21	40		Dike	TT 91	4

WHEELS

1105B	Rear wheel complete (less tire) dem. Kelsey	Old No. 1109B	1919-21	25 00	Duellist	TT 7698	2
1105C	Rear wheel complete (less tire) dem. Hayes	Old No. 1109B	1919-21	25 00	Dulcant	TT 7698B	2
1106B	Dem. rim only—Kelsey	Old No. 1109C	1919-21	5 50	Duke	TT 8774	2
1106C	Dem. rim only—Hayes	Old No. 1109C	1919-21	5 50	Dumal	TT 8774B	2
1107B	Clamp and nut assembly—Kelsey	Old No. 1109D	1919-21	20	Duledge	TT 8807	12
1108B	Clamp bolt	Old No. 1109E	1919-21	10	Dullish	TT 8832	12
1109	Rear wheel complete, less tire		1918-20	18 00	Duel	TT 99	2
1110	Rear wheel complete, with solid tire		1918-20		Drone	TT 7645	2
1111	Rear hub		1918-21	3 50	Dumb	TT 40	2
1112	Rear hub flange		1918-21	60	Dusk	TT 149	2
1113	Rear hub brake drum		1918-21	2 00	Dutch	TT 3	2
1114	Rear hub bolt		1918-21	05	Dwarf	TT 28	12
1114B	Rear hub bolt nut Used on 1114		1918-21	03	Durity	TT 29	12
1116	Rear hub cap		1918-21	35	Dyke	TT 150	2
*1117	Rear hub key		1918-21	05	Ear	TT 26	2
*1118	Rear hub felt		1918-21	05	East	TT 162	2

FRAME

1119	Frame assembly		1918-21	30 00	MH	Eat	TT 300	1
1120	Side member—right		1918-21	10 00		Ebb	TT 301	1
1121	Side member—left		1918-21	10 00		Fish	TT 302	1
1122	Front cross member		1918-21	1 50		Fliert	TT 303	1
1123	Rear cross member		1918-21	4 50		Flock	TT 304	1
1124	Front corner bracket—right		1918-21	20		Frost	TT 305	1
1125	Front corner bracket—left		1918-21	20		Froth	TT 306	1
1125B	Front end spacer—right		1918-21	15		Fruitage	TT 319	1
1125C	Front end spacer—left		1918-21	15		Fruitful	TT 318	1
1126	Rear cross member gusset plate		1918-21	25		Ghost	TT 307	2
1127	Rear cross member reinforcement		1918-21	40		Fruition	TT 325	2

TRANSMISSION CONTROL

1133	Speed lever		1918-21	10		Hoe	TT 862	1
1134	Controller shaft with speed lever		1918-21	75	MH	Hod	TT 1557	1

*For prices in quantities see special list to Dealers and Garages.

Of the net amount at which these parts are billed to purchasers who purchase direct from the Ford Motor Company (except parts which show no Tax Status, if any) 20/21 represents the price of the goods and 1/21 represents excise tax.

Insist upon genuine Ford parts

