

Ford

THE UNIVERSAL CAR

Price List
of Body
Parts

Model T

Ford Motor Company

DETROIT, MICHIGAN

IMPORTANT

INSIST on getting GENUINE Ford Parts when your Ford car needs repairing. Don't allow "bogus" or imitation Parts to be used in your car.



March 15, 1927

Prices subject to change without notice

Reprinted with permission of
FORD MOTOR COMPANY

INDEX

	Page
Cab (Closed)—1925-27.....	83
Cab (Open)—1924-26.....	83
Canopy Roof—1924-26.....	87
Coupe Body—1915-23.....	19
Coupe Body—1924-25.....	27
Coupe Body—1926-27.....	33
Express Body—1924-27.....	87
Fordor Sedan Body—1923-25.....	65
Fordor Sedan Body—1926-27.....	72
Pick-up Body—1925-27.....	89
*Platform Body—1925-27.....	89
Roadster Body—1915-22.....	5
Roadster Body—1922-25.....	5
Roadster Body—1926-27.....	7
Screens—1924-26.....	87
Stake Body—1925-27.....	89
Touring Car Body—1917-25.....	11
Touring Car Body—1926-27.....	15
Tudor Sedan Body—1915-23.....	40
Tudor Sedan Body—1924-25.....	49
Tudor Sedan Body—1926-27.....	55
†Windshield—Coupe & Sedan—1915-23.....	19

*Same as Stake Body less Racks

†For other Closed Body Windshields see Body Groups

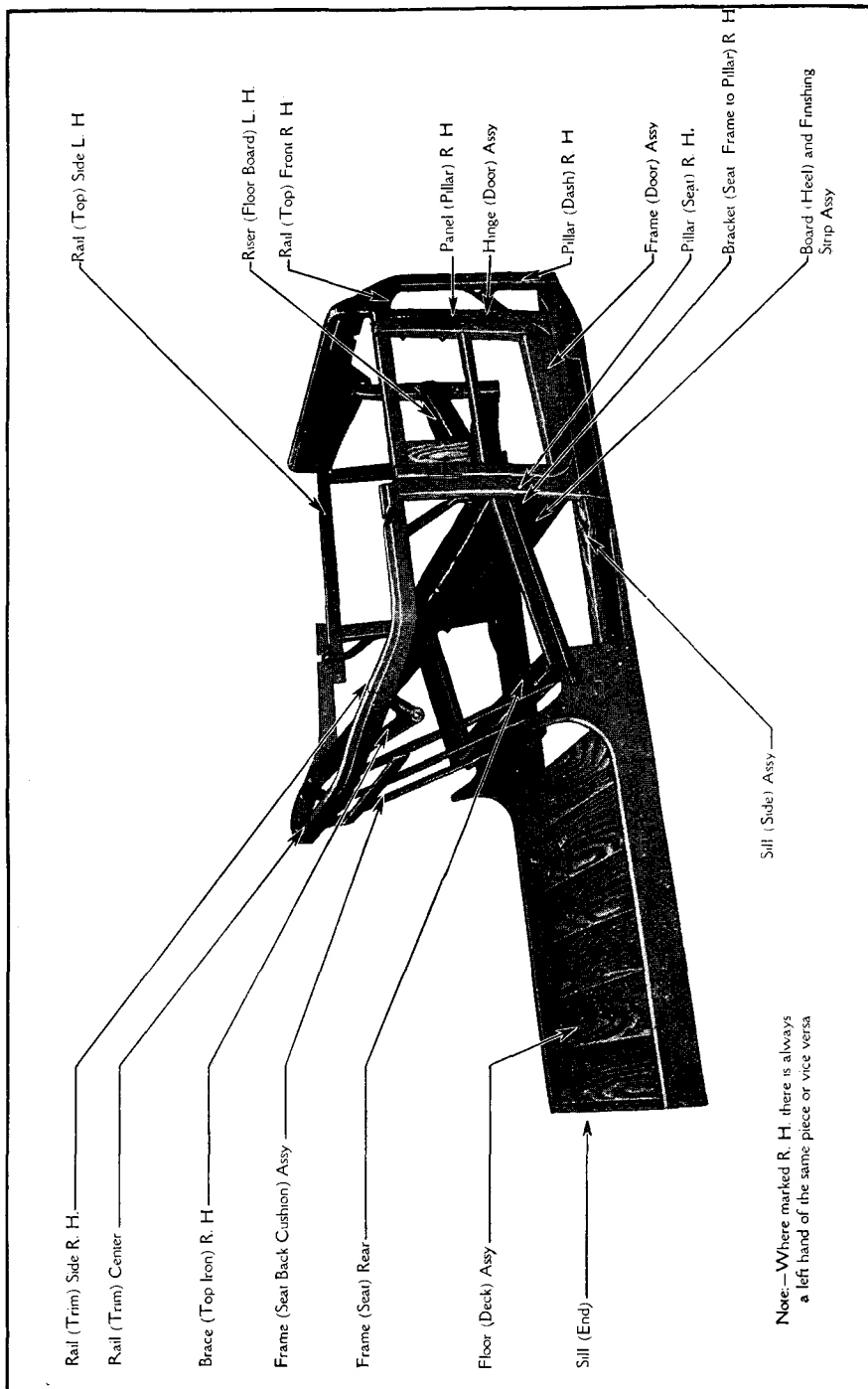

PRICE LIST OF BODY PARTS Ford Model T

Effective March 15, 1927

Note—When ordering upholstery or parts which are upholstered, always send sample of material desired. Panels, pillars, etc., are furnished unpainted and prices of these items as listed are for the unpainted parts.

Part No.	NAME	YEAR	PRICE
TORPEDO BODY PARTS—1915-22			
8350AX	Cowl	1915-22	\$ 8 00
8076ARX	Cushion (seat)	1915-22	6 00
7023BRX	Deck assy. (painted)	1914-22	20 00
5115X	Door assy. (upholstered and painted)	1915-22	5 00
5308X	Door (battery trap) assy.	1920-22	6 00
8021AX	Door (deck) assy.	1913-22	7 50
5569X	Fastener (deck door) assy.	1913-22	25
5297X	Hinge (door) assy.	1914-22	40
8431RX	Iron (body top) long—R. H.	1917-22	45
8432RX	Iron (body top) long—L. H.	1917-22	45
8401X	Iron (body top) short	1917-22	40
5680ARX	Lock (door) assy.	1913-22	25
7299ARX	Mat (floor rubber)	1915-22	8 50X 90
6641ARX	Panel (deck side) R. H.	1914-22	1 80
6642ARX	Panel (deck side) L. H.	1914-22	1 80
8132X	Panel (front side) R. H.	1915-22	4 00
8133X	Panel (front side) L. H.	1915-22	5 00
8024X	Panel (seat back)	1915-22	4 00
6638RX	Panel (seat side) R. H.	1914-22	5 00
6639RX	Panel (seat side) L. H.	1914-22	5 00
8420AX	Panel and frame (side) assy.—R. H.	1915-22	20 00
8421AX	Panel and frame (side) assy.—L. H.	1915-22	20 00
7193ARX	Pillar (dash) R. H.	1915-22	1 30
7194ARX	Pillar (dash) L. H.	1915-22	1 30
7195ARX	Pillar (panel) R. H.	1915-22	1 00
7196ARX	Pillar (panel) L. H.	1915-22	1 00
7197ARX	Pillar (seat) R. H.	1915-22	1 00
7198ARX	Pillar (seat) L. H.	1915-22	1 00
5205RX	Pin (door hinge)	1912-22	01
8433X	Plate (lock striker)	1917-22	20
7216RX	Rail (seat trim) assy.	1915-22	2 00
8334ARX	Rail (side top) R. H.	1915-22	20
8053ARX	Rail (side top) L. H.	1915-22	20
8336X	Spring (seat back)	1915-22	1 25
8083ARX	Upholstering (blind door) assy.	1915-22	30
8075RX	Upholstering (door) assy.	1915-22	20
8084RX	Upholstering (front) assy.	1915-22	10
8077ARX	Upholstering (seat back) assy.	1915-22	5 00
ROADSTER BODY PARTS—1922-25			
7375X	Board (heel) and finishing strip assy.	1922-25	1 10
7775RX	Brace (top iron) R.	1922-25	45
7776RX	Brace (top iron) L.	1922-25	45
8458RX	Bracket (seat frame to pillar) R. H.	1922-24	10
8459RX	Bracket (seat frame to pillar) L. H.	1922-24	10
8350BX	Cowl assy.	1922-23	6 00
8350CX	Cowl assy.	1923-25	3 00
8076BRX	Cushion (seat)	1922-25	6 00
7023BRX	Deck assy. (painted)	1922-25	20 00
5115X	Door assy. (upholstered and painted)	1922-25	5 00
8021BX	Door (deck) assy.	1922-25	3 00
5308X	Door (battery trap) assy.	1922-25	6 00
5458BRX	Floor (deck) assy.	1922-25	3 50
8442BRX	Frame (seat) rear	1922-24	35
8442CX	Frame (seat) rear	1924-25	35
8429BRX	Frame (seat) side—right	1922-24	20

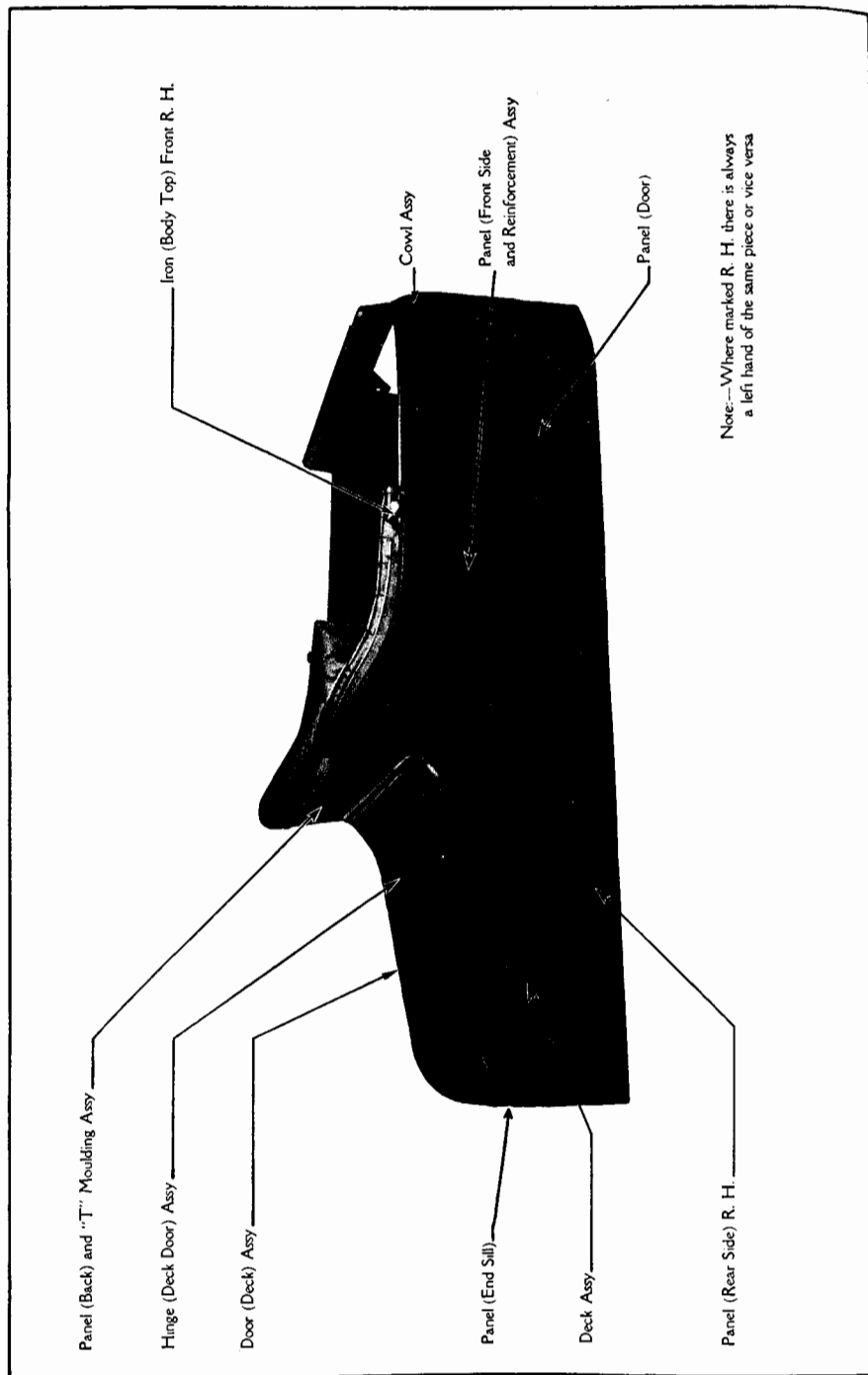

Part No.	NAME	YEAR	PRICE
ROADSTER BODY PARTS—1922-25—Continued			
8430BRX	Frame (seat) side—left	1922-24	\$ 0 20
7150BRX	Frame (seat) side—left	1924-25	10
8454BX	Frame (side) assy—right	1922-24	6 50
8454CX	Frame (side) assy—right	1924-25	6 50
8455BX	Frame (side) assy.—left	1922-24	6 50
8455CX	Frame (side) assy.—left	1924-25	6 50
5568BX	Hinge (deck door) assy.	1922-25	10
5297X	Hinge (door) assy.	1922-24	40
20022BRX	Hinge (door) assy.	1924-25	30
5178BIRX	Iron (body top) front—R. H.	1922-25	40
5179BIRX	Iron (body top) front—L. H.	1922-25	40
9484X	Key (deck lock)	1922-25	7 00C 10
5680ARX	Lock (door) assy.	1922-25	25
7299ARX	Mat (floor rubber)	1922-24	8 50X 90
7299BRX	Mat (floor rubber)	1924-25	8 50X 90
7751RX	Panel (deck side) R. H.	1922-25	2 25
7752RX	Panel (deck side) L. H.	1922-25	2 25
7753RX	Panel (deck rear)	1922-25	70
7800X	Panel (deck top) and hinge assy.	1922-25	1 25
6641BRX	Panel (rear side) R. H.	1922-25	35
6642BRX	Panel (rear side) L. H.	1922-25	35
7772RX	Panel (end sill)	1922-25	35
7128RX	Panel (door)	1922-25	1 00
6602BRX	Panel (instrument)	1922-25	1 00
8420BRX	Panel (side and frame) assy.—R. H.	1922-24	15 00
8420CX	Panel (side and frame) assy.—R. H.	1924-25	17 50
8421BRX	Panel (side and frame) assy.—L. H.	1922-24	15 00
8421CX	Panel (side and frame) assy.—L. H.	1924-25	17 50
7777X	Panel (back) and "T" moulding assy.	1922-25	2 50
7778ARX	Panel (front side) and reinforcement assy.—R. H.	1922-24	4 50
7778BX	Panel (front side) and reinforcement assy.—R. H.	1924-25	4 50
7779ARX	Panel (front side) and reinforcement assy.—L. H.	1922-24	4 50
7779BX	Panel (front side) and reinforcement assy.—L. H.	1924-25	4 50
7193BRX	Pillar (dash—right)	1922-23	1 30
7193CRX	Pillar (dash)—R. H.	1923-24	65
7193DRX	Pillar (dash)—R. H.	1924-25	65
7194BRX	Pillar (dash—left)	1922-23	1 30
7194CRX	Pillar (dash)—L. H.	1923-24	65
7194DRX	Pillar (dash)—L. H.	1924-25	65
7195BRX	Pillar (panel—right)	1922-24	50
7195CRX	Pillar (panel—right)	1924-25	50
7196ARX	Pillar (panel)—left	1924-25	1 00
7196BRX	Pillar (panel—left)	1922-23	50
7197ARX	Pillar (seat—right)	1922-24	1 00
7197BX	Pillar (seat—right)	1924-25	50
7198ARX	Pillar (seat—left)	1922-24	1 00
7198BX	Pillar (seat—left)	1924-25	50
7444X	Plug (front side panel)	1922-25	70
7204BRX	Rail (front top) R. H.	1922-24	35
20025X	Rail (front top) R. H.	1924-25	1 20
7205BRX	Rail (front top) L. H.	1922-24	60
7205CRX	Rail (front top) L. H.	1924-25	60
7205DRX	Rail (front top) L. H.	1925	60
8053BX	Rail (side top) L. H.	1925-25	30
8053CRX	Rail (side top) L. H.	1922-24	30
8053DRX	Rail (side top) L. H.	1925	25
8334BX	Rail (side top) R. H.	1922-24	10
7785RX	Rail (trim) center	1922-24	40
20505X	Rail (trim) center	1924-25	20
8351RX	Rail (side trim) assy.—R. H.	1922-24	65
20503X	Rail (side trim) assy.—R. H.	1924-25	25
8352RX	Rail (side trim) assy.—L. H.	1922-24	65
20504X	Rail (side trim) assy.—L. H.	1924-25	25
7291BRX	Riser (floor board) right	1922-24	15
7291CX	Riser (floor board) right	1924-25	15
7292BRX	Riser (floor board) left	1922-24	15
7292CX	Riser (floor board) left	1924-25	15
8050BX	Sill (end)	1922-25	50
8462BX	Sill (side) assy.—R. H.	1922-25	3 25
8463BX	Sill (side) assy.—L. H.	1922-25	3 25
5515X	Strap (door check)	1924-25	10
ROADSTER—1926-27			
45037X	Anti-rattler (seat back)	1926-27	02
48103X	Anti-rattler (rear cross member housing)	1926-27	10
45079X	Anti-rattler (tool box bottom)	1926-27	15
48218X	Anti-squeak (deck to body)	1926-27	15 yd.
40564X	Bar (seat frame)	1926-27	75
8952X	Binding (seat back)	1926-27	10 yd.

Part No.	NAME	YEAR	PRICE
ROADSTER—1926-27—Continued			
45127X	Board (front heel) assy.	1926-27	\$ 1 10
45158X	Board (front floor) and pedal shield assy.	1926-27	1 25
45331X	Board (No. 1 floor) and plate assy.	1926-27	50
45332X	Board (No. 2 floor) and plate assy.	1926-27	65
45333X	Board (No. 3 floor) and plate assy.	1926-27	75
45068X	Bottom (tool box)	1926-27	45
40026X	Brace (cowl) R. H.	1926-27	45
40027X	Brace (cowl) L. H.	1926-27	10
48031X	Brace (rear cross sill to deck floor)	1926-27	10
45139X	Brace (seat frame side to lock pillar) R. H.	1926-27	10
45140X	Brace (seat frame—side to lock pillar) L. H.	1926-27	10
45060X	Bracket (body)	1926-27	10
48102X	Bracket (body deck door support)	1926-27	30
57116X	Bracket (deck door support)	1926-27	05
45103X	Bracket (rocker panel support)	1926-27	10
45159RX	Bracket (side oil lamp—R. H.)	1926	30
45160RX	Bracket (side oil lamp—L. H.)	1926	30
45124X	Bracket (side sill to dash) R. H.	1926-27	10
45125X	Bracket (side sill to dash) L. H.	1926-27	10
48028X	Bracket (tire carrier support to back floor)	1926-27	15
48252X	Bumper (deck door)	1926-27	05
45523AX	Cardboard (cowl) assy.—R. H.	1926-27	20
45524AX	Cardboard (cowl) assy.—L. H.	1926-27	20
45512AX	Cardboard (door) R. H.	1926-27	60
45513AX	Cardboard (door) L. H.	1926-27	60
45141X	Connection—trim rail	1926-27	03
48100X	Channel (deck side panel retaining)	1926-27	50
45161X	Cowl and dash assy.	1926-27	15 00
45529AX	Cushion (seat) assy. (with buttons)	1926-27	6 50
45529BX	Cushion (seat) assy. (without buttons)	1926-27	6 50
40160X	Cushion (steering column)	1926-27	02
40166X	Cushion (steering column) lower	1926-27	03
†48213X	Deck assy.	1926-27	*20 00
48110ARX	Door (battery trap) assy.	1926	75
48110BX	Door (battery trap) assy.	1926-27	75
48207X	Door (deck) assy.	1926-27	9 00
45315X	Door assy.—R. H. (untrimmed and unpainted)	1926-27	3 50
45316X	Door assy.—L. H. (untrimmed and unpainted)	1926-27	3 50
†45320X	Door assy.—R. H. (complete)	1926-27	5 00
†45321X	Door assy.—L. H. (complete)	1926-27	5 00
17498X	Fastener (door trim)	1924-27	50C 01
41124X	Fastener (flush type) female	1926-27	05
41128X	Fastener (lift the dot) male	1926-27	03
48231X	Felt (deck door panel)	1926-27	10
45231X	Filler (cross sill)	1926-27	20
48080X	Filler (side sill)	1926-27	15
48056X	Frame (seat) center	1926-27	65
48123X	Frame (seat back cushion) assy.	1926-27	2 50
45056X	Frame (seat) side—R.	1926-27	30
45057X	Frame (seat) side—L.	1926-27	30
45122RX	Grommet (side curtain rod)	1926	02
48134X	Guide (deck door)	1926-27	05
48021X	Gusset (deck door bumper) R. H.	1926-27	10
48022X	Gusset (deck door bumper) L. H.	1926-27	10
48032X	Gusset (sill)	1926-27	10
45101X	Hinge (door) assy. upper—R. H.	1926-27	20
45102X	Hinge (door) assy. upper—L. H.	1926-27	20
45113X	Hinge (door) assy. lower—L. H.	1926-27	20
45108X	Hinge (door) assy. lower	1926-27	20
40180X	Hinge (ventilator lid)	1926-27	10
48815X	Housing (rear cross member)	1926-27	75
5190CX	Iron (body top seat) corner	1921-25-27	10
48090X	Iron (top) front	1926-27	15
57075X	Key (deck lock)	1926-27	8 00C 10
45335X	Lid (ventilator) assy.	1926-27	60
9482X	Lock (deck) assy.	1926-27	25
5680BX	Lock (door) assy.—R. H.	1926-27	25
5679BX	Lock (door) assy.—L. H.	1926-27	25
45592X	Mat (floor) and weatherstrip assy.	1926-27	1 50
48202X	Panel (back) assy.	1926-27	5 00
48205X	Panel (deck center) assy. upper	1926-27	4 50
48206ARX	Panel (deck center) assy. lower	1926	5 00
48206BX	Panel (deck center) assy.—lower	1926-27	5 00
48203ARX	Panel (deck side) assy.—R. H.	1926	10 00
40203BX	Panel (deck side) assy.—R. H.	1926-27	10 00
48204ARX	Panel (deck side) assy.—L. H.	1926	10 00
48204BX	Panel (deck side) assy.—L. H.	1926-27	10 00
48109ARX	Panel (deck floor) assy.	1926	4 00
48109BX	Panel (deck floor) assy.	1926-27	4.50
45018A2X	Panel (door rocker) assy.—R. H.	1926-27	40

*Not subject to regular discount. †Specify color of paint.

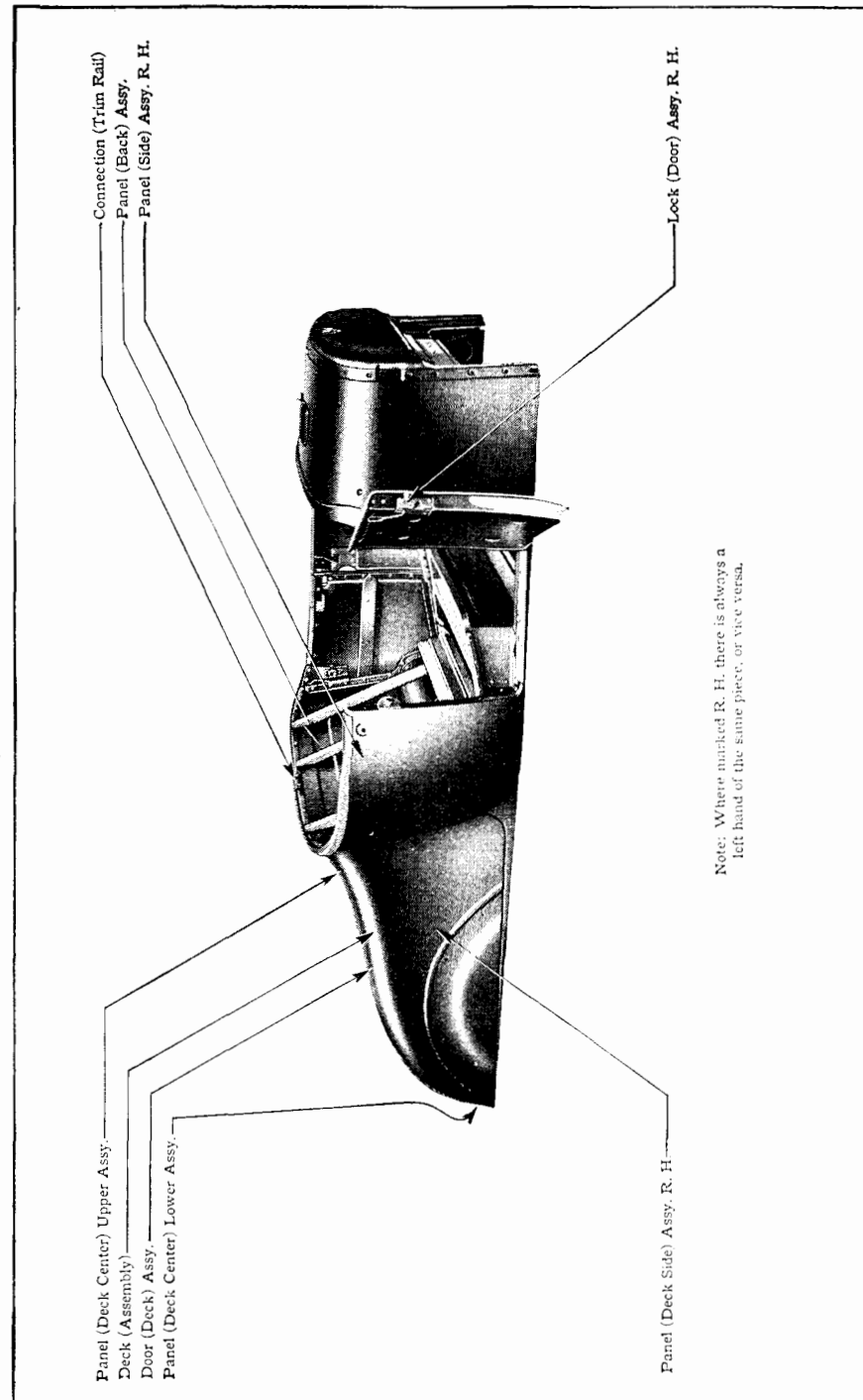

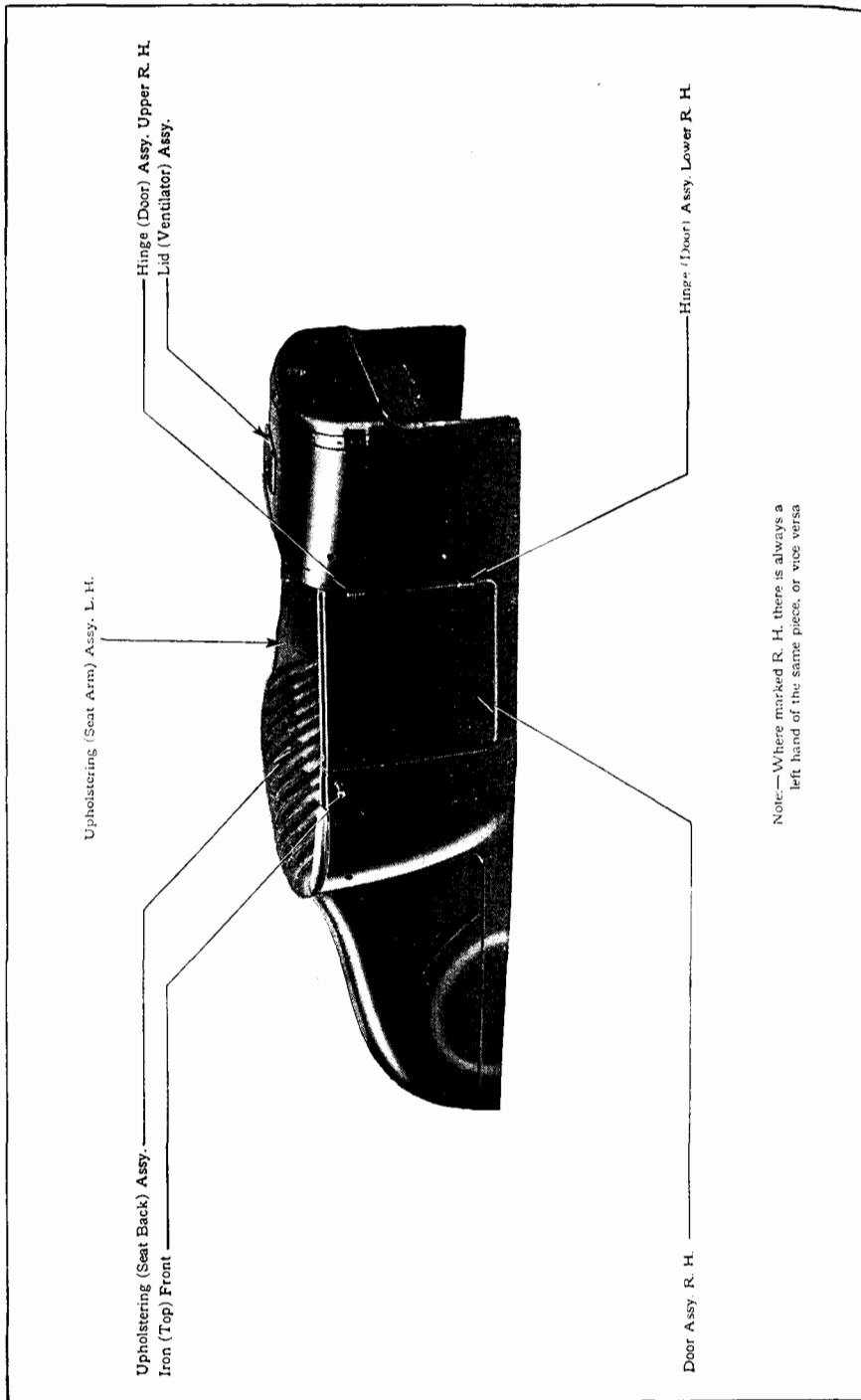

Part No.	NAME	YEAR	PRICE
----------	------	------	-------

ROADSTER BODY PARTS—1926-27—Continued

45019A2X	Panel (door rocker) assy.—L. H.	1926-27	\$ 0 40
40059X	Panel (instrument) (with dash lamp hole)	1926-27	1 50
45015X	Panel (instrument) (without dash lamp hole)	1926-27	1 50
48200X	Panel (side) assy.—R. H.	1926-27	3 00
48201X	Panel (side) assy.—L. H.	1926-27	3 00
45326X	Pillar (front lock) assy.—R. H.	1926-27	60
45327X	Pillar (front lock) assy.—L. H.	1926-27	60
45324X	Pillar (hinge) assy.—R. H.	1926-27	30
45325X	Pillar (hinge) assy.—L. H.	1926-27	30
40137X	Pin (ventilator lid hinge)	1926-27	1 00C
8433X	Plate (door lock striker)	1926-27	20
45082X	Plate (door scuff) R. H.	1926-27	65
45083X	Plate (door scuff) L. H.	1926-27	65
45213X	Plate (floor board No. 1)	1926-27	10
45218X	Plate (floor board No. 2)	1926-27	10
45122X	Plate (handbrake lever)	1926-27	05
7444X	Plug (side panel)	1926-27	05
45203X	Rail (seat back trim)	1926-27	20
40162X	Reinforcement (dash)	1926-27	02
48058X	Reinforcement (deck panel center) lower	1926-27	60
48033X	Reinforcement (tire carrier sill)	1926-27	20
48108X	Retainer (battery trap door)	1926-27	05
45065RX	Retainer (front lock pillar trim) R. H.	1926	10
45066RX	Retainer (front lock pillar trim) L. H.	1926	10
48113X	Retainer (padding)	1926-27	10
45093X	Riser (toe board) R. H.	1926-27	40
45094X	Riser (toe board) L. H.	1926-27	40
45130X	Shield (pedal)	1926-27	15
48002X	Side (body) assy.—R. H.	1926-27	13 50
48003X	Side (body) assy.—L. H.	1926-27	13 50
48208X	Sill (cross) rear assy.	1926-27	2 25
45024X	Sill (cross) rear—center	1926-27	85
45022X	Sill (cross) front	1926-27	75
48027X	Sill (cross) front	1926-27	90
8151BX	Spring (seat back) assy. (uph. with buttons)	1926-27	1 25
8151CX	Spring (seat back) assy. (uph. without buttons)	1926-27	1 25
45508AX	Spring (seat cushion) assy.	1926-27	2 25
40182X	Spring (ventilator lock)	1926-27	10
45196X	Strip (cowl ventilator weather) and hook assy.	1926-27	20
45251X	Strip (front seat side trim)	1926-27	10
45026X	Strip (front heel board finish)	1926-27	20
45235X	Strip (front hinge pillar trim) R. H.	1926-27	40
45236X	Strip (front hinge pillar trim) L. H.	1926-27	40
57117X	Support (deck door)	1926-27	10
45055A2X	Support (steering column)	1926-27	20
48035X	Trough (deck door drain)	1926-27	20
48224X	Upholstering (seat arm) assy.—R. H.	1926-27	1 00
48225X	Upholstering (seat arm) assy.—L. H.	1926-27	1 00
48223AX	Upholstering (seat back) assy.	1926-27	3 50
48223BX	Upholstering (seat back) assy.	1926-27	3 50

TOURING CAR BODY PARTS—1917-25

8476BX	Bar (rear seat) metal	1915-17 and 20-22	1 00
7375X	Board (front heel) and finishing strip assy.	1921-25	1 10
8349BX	Board (rear heel) and finishing strip assy.	1921-25	1 00
7148BX	Board (rear seat toe) assy.	1921-25	75
7143BX	Bottom (tool box) assy.	1921-25	75
7420X	Brace (fender and top iron) assy.—R. H.	1921-25	80
7421X	Brace (fender and top iron) assy.—L. H.	1921-25	80
7411RX	Bracket (fender)	1921-25	15
7411RX	Bracket (top iron)	1921-25	15
8350BX	Cowl	1921-23	6 00
8350CX	Cowl	1923-25	3 00
8076ARX	Cushion (front seat)	1909-21	6 00
8076BRX	Cushion (front seat)	1921-25	6 00
7032ARX	Cushion (rear seat)	1909-22	6 50
7032BRX	Cushion (rear seat)	1921-25	6 50
5115X	Door (front) assy. (upholstered and painted)	1915-25	5 00
5113X	Door (rear) assy.—R. H. (upholstered and painted)	1915-25	5 00
5114X	Door (rear) assy.—L. H. (upholstered and painted)	1915-25	5 00
7150BRX	Frame (front seat side)	1921-25	10
7141BRX	Frame (rear seat center)	1921-25	25
7139BRX	Frame (rear seat side) R. H.	1921-25	30
7140BRX	Frame (rear seat side) L. H.	1921-25	30
5297X	Hinge (door) assy.	1915-24	40
20022RX	Hinge (door) assy.	1925	30
5190CX	Iron (body top) rear seat—corner	1921-25	10
5178BIRX	Iron (body top) rear seat—side—R. H.	1921-25	40
5179BIRX	Iron (body top) rear seat—side—L. H.	1921-25	40
5145BRX	Iron (top) front seat	1921-24	40
5680ARX	Lock (door)—front R. H. and rear L. H.	1913-25	25

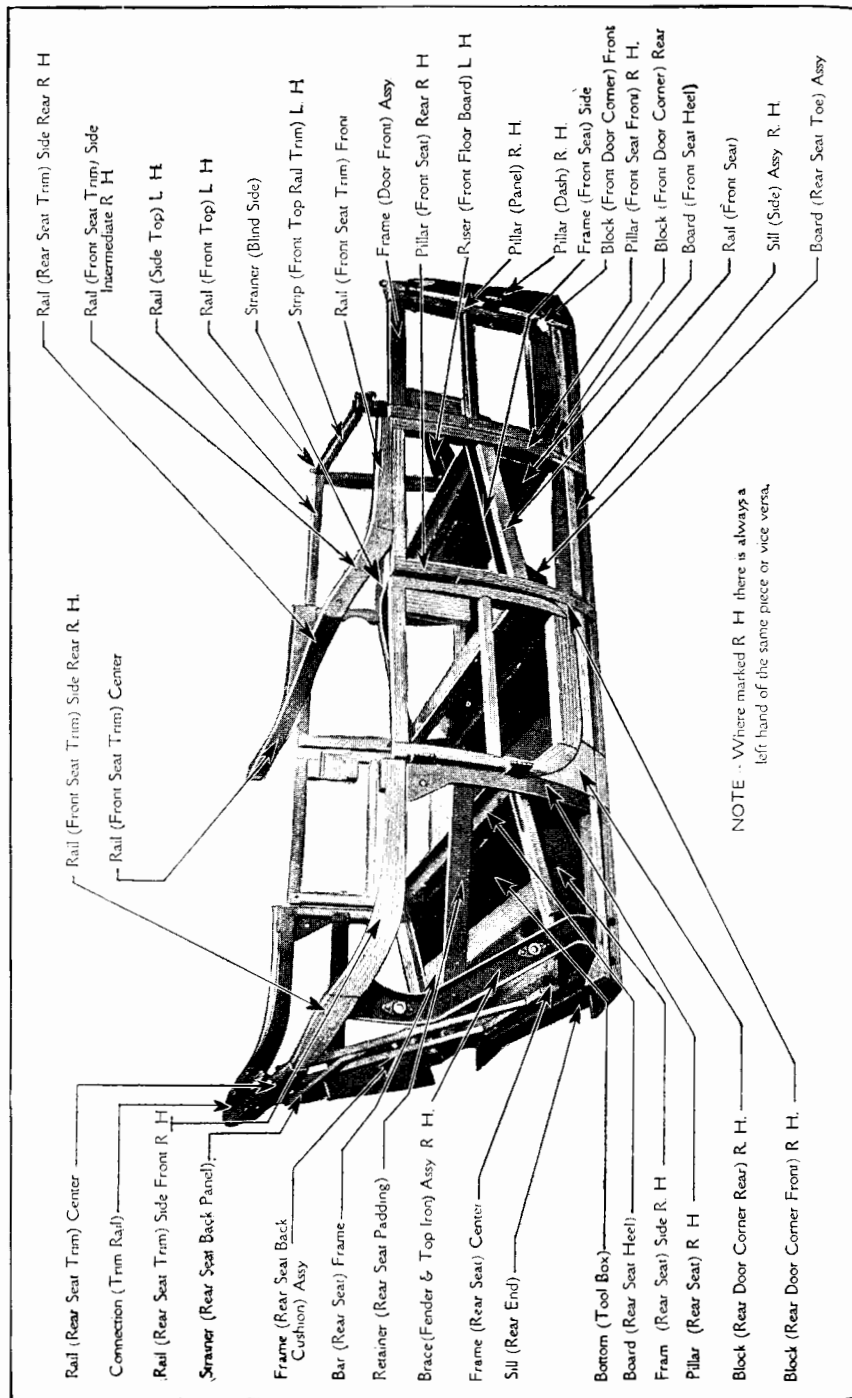

NOTE - Where marked R. H. there is always a left hand of the same piece or vice versa.

Part No.	NAME	YEAR	PRICE
TOURING CAR BODY PARTS—1917-25—Continued			
5679ARX	Lock (door)—rear R. H.	1913-25	\$0 25
7299ARX	Mat (front floor)	1915-24	8 50X 90
7299BRX	Mat (front floor)	1924-25	8 50X 90
1606BRX	Mat (rear floor)	1911-21	1 00
1606CRX	Mat (rear floor) (rubber)	1921-25	60
1606CRX	Mat (rear floor)	1921-25	75
8449BX	Panel (front seat back) and trim rail assy.	1921-25	4 25
5123BX	Panel (front side) L. H.	1921-24	3 00
5123CRX	Panel (front side) L. H.	1924-25	3 50
6122BX	Panel (front side) L. H.	1921-24	3 50
5122BX	Panel (front side) R. H.	1921-24	3 00
5122CRX	Panel (front side) R. H.	1924-25	3 50
5122DX	Panel (front side) R. H.	1921-24	3 50
6602BRX	Panel (instrument board)	1922-25	1 00
7120X	Panel (rear door) R. H.	1915-25	1 00
7121X	Panel (rear door) L. H.	1915-25	1 00
7437X	Panel (rear seat back) and "T" moulding assy.	1921-25	4 00
7438X	Panel (rear seat) and reinforcement assy.—R. H.	1921-25	3 00
7439X	Panel (rear side) and reinforcement assy.—L. H.	1921-25	3 50
8156BX	Panel (side) and frame assy.—R. H.	1921-24	*20 00
8156CX	Panel (side) and frame assy.—R. H.	1925	*20 00
8157BX	Panel (side) and frame assy.—L. H.	1921-24	*20 00
8157CX	Panel (side) and frame assy.—L. H.	1925	*20 00
7193BRX	Pillar (dash) R. H.	1921-23	1 30
7193CRX	Pillar (dash) R. H.	1923-24	65
7193DRX	Pillar (dash) R. H.	1924-25	65
7194BRX	Pillar (dash) L. H.	1921-23	1 30
7194CRX	Pillar (dash) L. H.	1923-24	65
7194DRX	Pillar (dash) L. H.	1924-25	65
7197BX	Pillar (front seat front) R. H.	1921-25	50
7198BX	Pillar (front seat front) L. H.	1921-25	50
7200BX	Pillar (front seat rear) R. H.	1921-25	50
7201BX	Pillar (front seat rear) L. H.	1921-24	50
7195BRX	Pillar (panel) R. H.	1921-24	50
7195CRX	Pillar (panel) R. H.	1924-25	50
7196BRX	Pillar (panel) L. H.	1921-25	50
7202BRX	Pillar (rear seat) R. H.	1921-25	60
7203BRX	Pillar (rear seat) L. H.	1921-25	60
5205RX	Pin (door hinge) de	1921-25	01
8433X	Plate (lock striker)	1917-25	20
8398BX	Rail (front seat trim) center	1921-25	75
8399BX	Rail (front seat trim) side—front—R. H.	1921-25	20
7390RX	Rail (front seat trim) side—front—L. H.	1921-25	25
7391RX	Rail (front seat trim) side—rear—R. H.	1921-25	35
7392RX	Rail (front seat trim) side—rear—L. H.	1921-25	35
7204BRX	Rail (front top) R. H.	1921-23	70
7204CRX	Rail (front top) R. H.	1923-24	40
7204DRX	Rail (front top) R. H.	1925	40
7205BRX	Rail (front top) L. H.	1921-23	1 20
7205CRX	Rail (front top) L. H.	1923-24	60
7205DRX	Rail (front top) L. H.	1925	60
8371BX	Rail (rear seat trim) center	1921-24	35
8371CX	Rail (rear seat trim) center	1925	45
8381X	Rail (rear seat trim) side—R. H.	1921-25	1 00
8397X	Rail (rear seat trim) side—L. H.	1921-25	1 00
7206X	Rail (side top) R. H.	1915-25	20
7207BX	Rail (side top) L. H.	1921-23 & 25	30
7207CRX	Rail (side top) L. H.	1923-24	50
7291BRX	Riser (front floor board) R. H.	1921-24	15
7291CRX	Riser (front floor board) R. H.	1924-25	15
7292BRX	Riser (front floor board) L. H.	1921-24	15
7292CX	Riser (front floor board) L. H.	1924-25	15
7135BRX	Sill (rear end)	1921-25	45
7175BX	Sill (side) assy.—R. H.	1921-25	3 50
7176BX	Sill (side) assy.—L. H.	1921-25	3 50
8151BRX	Spring (front back)	1921-25	1 25
8063BX	Spring (front cushion)	1921-25	2 00
8152BRX	Spring (rear back)	1921-25	1 50
5670BX	Spring (rear cushion)	1921-25	2 25
7208BX	Strainer (blind side)	1921-24	10
5515X	Strap (door) check	1925	10
5682BRX	Support (floor board) rear	1921-25	10
8083ARX	Upholstering (blind door) assy.	1915-25	30
8084X	Upholstering (front) assy.	1915-25	10
8075RX	Upholstering (front door) assy.	1915-25	20
8077AX	Upholstering (front seat back) assy.	1915-21	5 00
8376RX	Upholstering (front seat back) assy.	1921-25	5 00
8377RX	Upholstering (rear door) assy.—R. H.	1915-25	30
8078ARX	Upholstering (rear door) assy.—L. H.	1915-25	30
8078BRX	Upholstering (rear seat back) assy.	1915-21	6 00
	Upholstering (rear seat back) assy.	1921-25	6 00

*Not subject to regular discount.

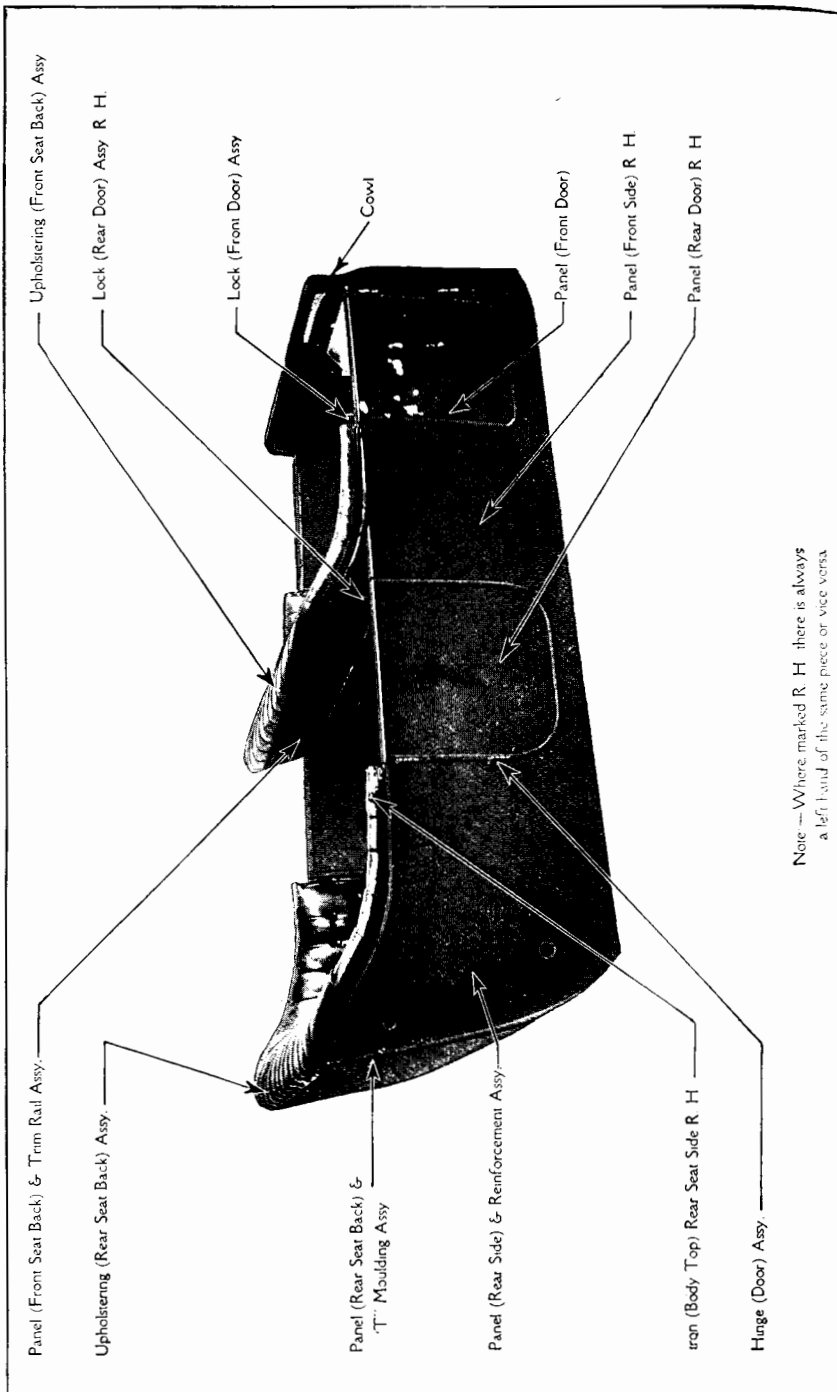

Note -- Where marked R. H. there is always
a left hand of the same piece or vice versa.

Part No.	NAME	YEAR	PRICE
TOURING CAR BODY PARTS—1926-27			
45037X	Anti-rattler (front seat back and door spacer)	1926-27	\$0 02
8283BX	Anti-rattler (front seat back panel)	1926-27	10
45079X	Anti-rattler (tool box bottom)	1926-27	15
40564X	Bar (front seat frame)	1926-27	75
45230X	Bar (rear seat frame)	1926-27	90
8952X	Binding (front seat back)	1926-27	10 yd.
8952X	Binding (rear seat back)	1926-27	10 yd.
45158X	Board (front floor) and pedal shield assy.	1926-27	1 25
45331X	Board (front floor) and plate assy. No. 1	1926-27	50
45332X	Board (front floor) and plate assy. No. 2	1926-27	65
45333X	Board (front floor) and plate assy. No. 3	1926-27	1 10
45127X	Board (front heel) assy.	1926-27	1 00
45330X	Board (rear floor) assy.	1926-27	75
45064X	Board (rear heel)	1926-27	75
45084X	Board (rear seat toe)	1926-27	75
45068X	Bottom (tool box)	1926-27	45
49026X	Brace (cowl)—R. H.	1926-27	45
49027X	Brace (cowl)—L. H.	1926-27	55
45307X	Brace (fender and top iron) assy.—R. H.	1926-27	55
45308X	Brace (fender and top iron) assy.—L. H.	1926-27	10
45139X	Brace (front seat frame—side to lock pillar) R. H.	1926-27	10
45140X	Brace (front seat frame—side to lock pillar) L. H.	1926-27	10
45060X	Bracket (body)	1926-27	10
45133X	Bracket (rear floor board support)	1926-27	03
45087X	Bracket (rear hinge pillar) R. H.	1926-27	10
45088X	Bracket (rear hinge pillar) L. H.	1926-27	10
45103X	Bracket (rocker panel support)	1926-27	30
45159RX	Bracket (side oil lamp) R. H.	1926	30
45160RX	Bracket (side oil lamp) L. H.	1926-27	10
45124X	Bracket (sill to dash) R. H.	1926-27	10
45125X	Bracket (sill to dash) L. H.	1926-27	03
45593AX	Bumper (door)	1926-27	20
45523AX	Cardboard (cowl) assy.—R. H.	1926-27	20
45524AX	Cardboard (cowl) assy.—L. H.	1926-27	60
45512AX	Cardboard (front door) R. H.	1926-27	60
45513AX	Cardboard (front door) L. H.	1926-27	10
8283BX	Cardboard (front seat back anti-rattler)	1926-27	60
45510AX	Cardboard (rear door) R. H.	1926-27	60
45511AX	Cardboard (rear door) L. H.	1926-27	15
45525AX	Cardboard (rear lock pillar) assy.—R. H.	1926-27	15
45526AX	Cardboard (rear lock pillar) assy.—L. H.	1926-27	15
45519X	Cardboard (rear seat side trim)	1926-27	10
45053RX	Connection (cross sill rear to side sill) R. H.	1926	10
45054RX	Connection (cross sill rear to side sill) L. H.	1926-27	15 00
45141X	Connection (trim) rail	1926-27	6 50
45161X	Cowl and dash assy.	1926-27	6 50
45529AX	Cushion (front seat) assy. (with buttons)	1926-27	6 50
45529BX	Cushion (front seat) assy. (without buttons)	1926-27	6 50
45545AX	Cushion (rear seat) assy. (with buttons)	1926-27	6 50
45545BX	Cushion (rear seat) assy. (without buttons)	1926-27	03
49160X	Cushion (steering column)	1926-27	02
40166X	Cushion (steering column) lower	1926-27	5 00
†45320X	Door (front) assy.—R. H. (complete)	1926-27	5 00
†45321X	Door (front) assy.—L. H. (complete)	1926-27	6 00
†45322X	Door (rear) assy.—R. H. (complete)	1926-27	6 00
†45323X	Door (rear) assy.—L. H. (complete)	1926-27	3 50
45315X	Door (front) assy.—R. H. (untrimmed and unpainted)	1926-27	3 50
45316X	Door (front) assy.—L. H. (untrimmed and unpainted)	1926-27	4 50
45317X	Door (rear) assy.—R. H. (untrimmed and unpainted)	1926-27	4 50
45318X	Door (rear) assy.—L. H. (untrimmed and unpainted)	1926-27	35
45046RX	Extension (side sill) R. H.	1926	35
45047RX	Extension (side sill) L. H.	1926-27	05
41124X	Fastener (flush type) female	1926-27	01
41128X	Fastener (lift and dot) male	1926-27	20
17498X	Fastener (trim)	1926-27	10
45231X	Filler (cross sill)	1926-27	1 25
45233X	Filler (slide sill)	1926-27	1 75
45311X	Frame (front seat) assy.	1926-27	30
45312X	Frame (rear seat) side—R. H.	1926-27	30
45077X	Frame (rear seat) side—L. H.	1926-27	45
45078X	Frame (rear seat) rear	1926-27	40
45069BX	Frame (rear seat back cushion) lower	1926-27	25
45208X	Frame (rear seat back cushion) upper	1926-27	10
45209X	Frame (rear seat center) rear	1926-27	1 50
45360X	Frame (rear seat cushion) assy.	1926-27	45
45314X	Frame (rear seat side) assy.—R. H.	1926-27	45
45358X	Frame (rear seat side) assy.—L. H.	1926-27	30
45359X	Frame (seat side) R. H.	1926-27	30
45056X	Frame (seat side) L. H.	1926-27	30
45057X	Grommet (slide curtain rod)	1926-27	02

†Specify color of paint.

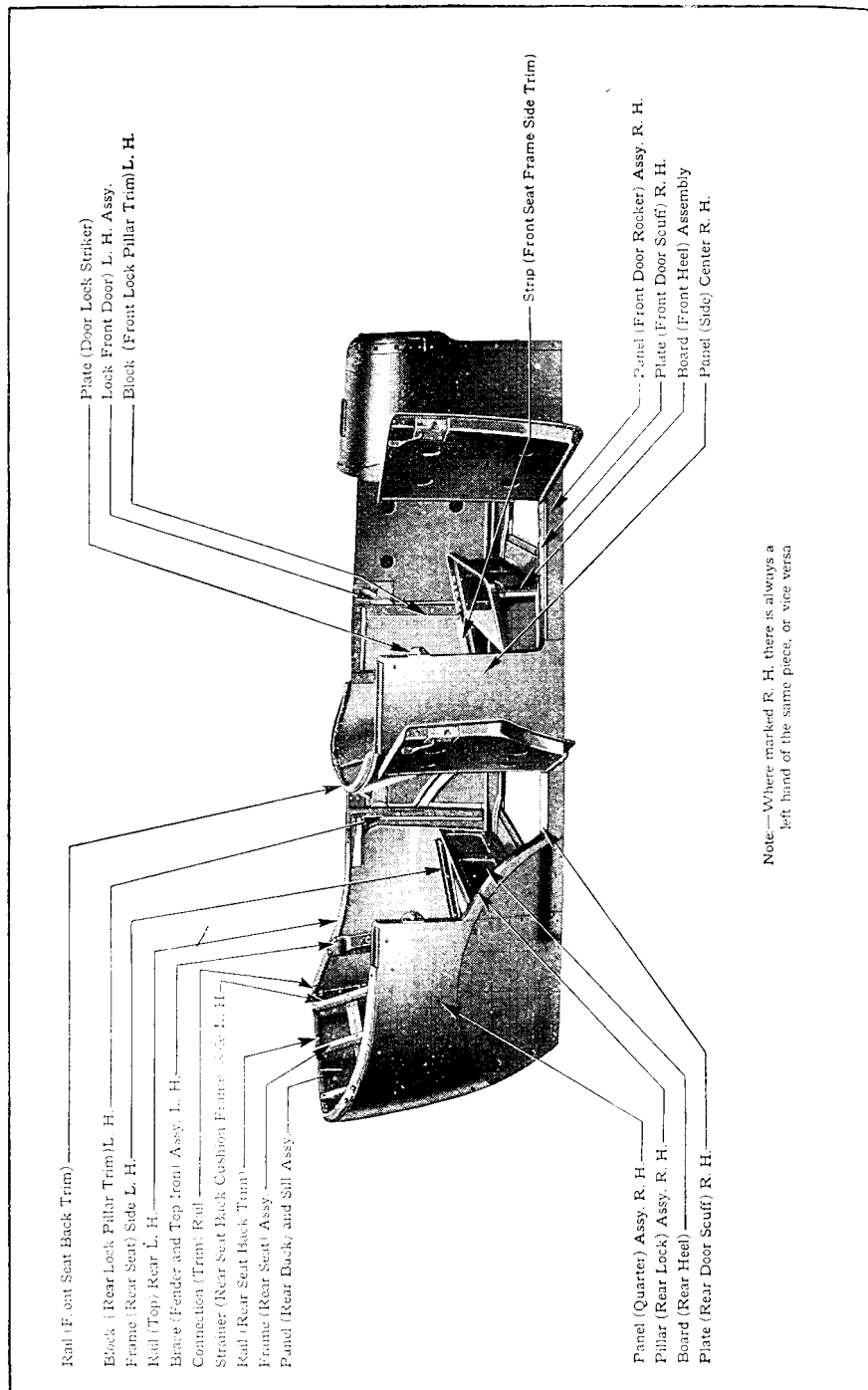

Part No.	NAME	YEAR	PRICE
TOURING CAR BODY PARTS—1926-27—Continued			
45113X	Hinge (door) assy.—front lower—L. H.	1926-27	\$ 0 20
45108X	Hinge (door) assy.—front lower—R. H.	1926-27	20
45101X	Hinge (door) assy.—front upper—R. H.	1926-27	20
45102X	Hinge (door) assy.—front upper L. H.	1926-27	20
45102X	Hinge (door) assy.—rear L. H.	1926-27	20
45101X	Hinge (door) assy.—rear R. H.	1926-27	20
40180X	Hinge (ventilator lid)	1926-27	10
45074BX	Housing (cross member) rear assy.	1926-27	1 50
45086X	Iron (top) assy.	1926-27	10
45156X	Iron (top) front	1926-27	10
5190CX	Iron (top rest)	1926-27	10
45335X	Lid (ventilator) assy.	1926-27	60
5680BX	Lock (door) assy.—front R. H.—rear R. H.	1926-27	25
5679BX	Lock (door) assy.—front L. H.—rear L. H.	1926-27	25
45592X	Mat (floor) and weatherstrip assy.—front	1926-27	1 50
45128X	Mat (floor) rear	1926-27	1 00
45018A2X	Panel (front door rocker) assy.—R. H.	1926-27	40
45019A2X	Panel (front door rocker) assy.—L. H.	1926-27	40
49059X	Panel (instrument) (with dash lamp hole)	1926-27	1 50
45015X	Panel (instrument) (without dash lamp hole)	1926-27	1 50
45304X	Panel (quarter) assy.—R. H.	1926-27	3 50
45305X	Panel (quarter) assy.—L. H.	1926-27	3 50
45310X	Panel (rear back) and sill assy.	1926-27	5 00
40052X	Panel (side) center R. H.	1926-27	1 00
40053X	Panel (side) center L. H.	1926-27	1 00
45324X	Pillar (hinge) assy.—R. H.	1926-27	30
45325X	Pillar (hinge) assy.—L. H.	1926-27	30
45326X	Pillar (front lock) assy.—R. H.	1926-27	60
45327X	Pillar (front lock) assy.—L. H.	1926-27	60
45338X	Pillar (lock) assy.—rear R. H.	1926-27	2 00
45339X	Pillar (lock) assy.—rear L. H.	1926-27	2 00
40137X	Pin (ventilator lid hinge)	1926-27	1 00C
48433X	Plate (door lock striker)	1926-27	20
45213X	Plate (floor board No. 1 pedal)	1926-27	10
45218X	Plate (floor board No. 2 pedal)	1926-27	10
45082X	Plate (front door scuff) R. H.	1926-27	65
45083X	Plate (front door scuff) L. H.	1926-27	65
45132X	Plate (hand brake lever)	1926-27	05
45091X	Plate (rear door scuff) R. H.	1926-27	1 00
45092X	Plate (rear door scuff) L. H.	1926-27	1 00
7444X	Plug (rear side panel)	1926-27	05
45202X	Rail (front seat back trim) R. H.	1926-27	20
45206X	Rail (front seat back trim) L. H.	1926-27	20
45203X	Rail (rear seat back trim)	1926-27	20
45200X	Rail (rear seat trim) center	1926-27	15
45080X	Rail (top) rear—R. H.	1926-27	15
45081X	Rail (top) front—L. H.	1926-27	15
40162X	Reinforcement (dash)	1926-27	02
45044X	Reinforcement (front seat back panel)	1926-27	15
45065RX	Retainer (front lock pillar trim) R. H.	1926	10
45066RX	Retainer (front lock pillar trim) L. H.	1926	10
45104X	Retainer (rear door lock pillar trim) R. H.	1926-27	25
45105X	Retainer (rear door lock pillar trim) L. H.	1926-27	25
45501X	Retainer (rear seat side trim) R. H.	1926-27	20
45502X	Retainer (rear seat side trim) L. H.	1926-27	20
45093X	Riser (toe board) R. H.	1926-27	40
45094X	Riser (toe board) L. H.	1926-27	40
45130X	Shield (pedal)	1926-27	15
45300X	Side (body) assy.—R. H.	1926-27	*20 00
45301X	Side (body) assy.—L. H.	1926-27	*20 00
45022X	Sill (cross) front	1926-27	75
45023X	Sill (cross) front center	1926-27	1 00
45025BX	Sill (cross) rear	1926-27	60
45024X	Sill (cross) rear—center	1926-27	85
45302X	Sill (side) assy.—R. H.	1926-27	3 75
45303X	Sill (side) assy.—L. H.	1926-27	3 75
8151BX	Spring (front seat back) (uph. with buttons)	1926-27	1 25
8151CX	Spring (front seat back) assy. (uph. without buttons)	1926-27	1 25
8152BX	Spring (rear seat back) (uph. with buttons)	1926-27	1 50
8152CX	Spring (rear seat back) (uph. without buttons)	1926-27	1 50
45508AX	Spring (front seat cushion) assy.	1926-27	2 25
45509AX	Spring (rear seat cushion) assy.	1926-27	2 25
40182X	Spring (ventilator lock)	1926-27	10
45043X	Strainer (front seat back panel)	1926-27	20
45238X	Strainer (rear seat back cushion frame)	1926-27	20
45196X	Strip (cowl ventilator weather) and hook assy.	1926-27	20
45026X	Strip (front heel board finish)	1926-27	20
45235X	Strip (front hinge pillar trim) R. H.	1926-27	40
45236X	Strip (front hinge pillar trim) L. H.	1926-27	40
45234X	Strip (front seat back trim)	1926-27	85
45251X	Strip (front seat side trim)	1926-27	10

*Not subject to regular discount.

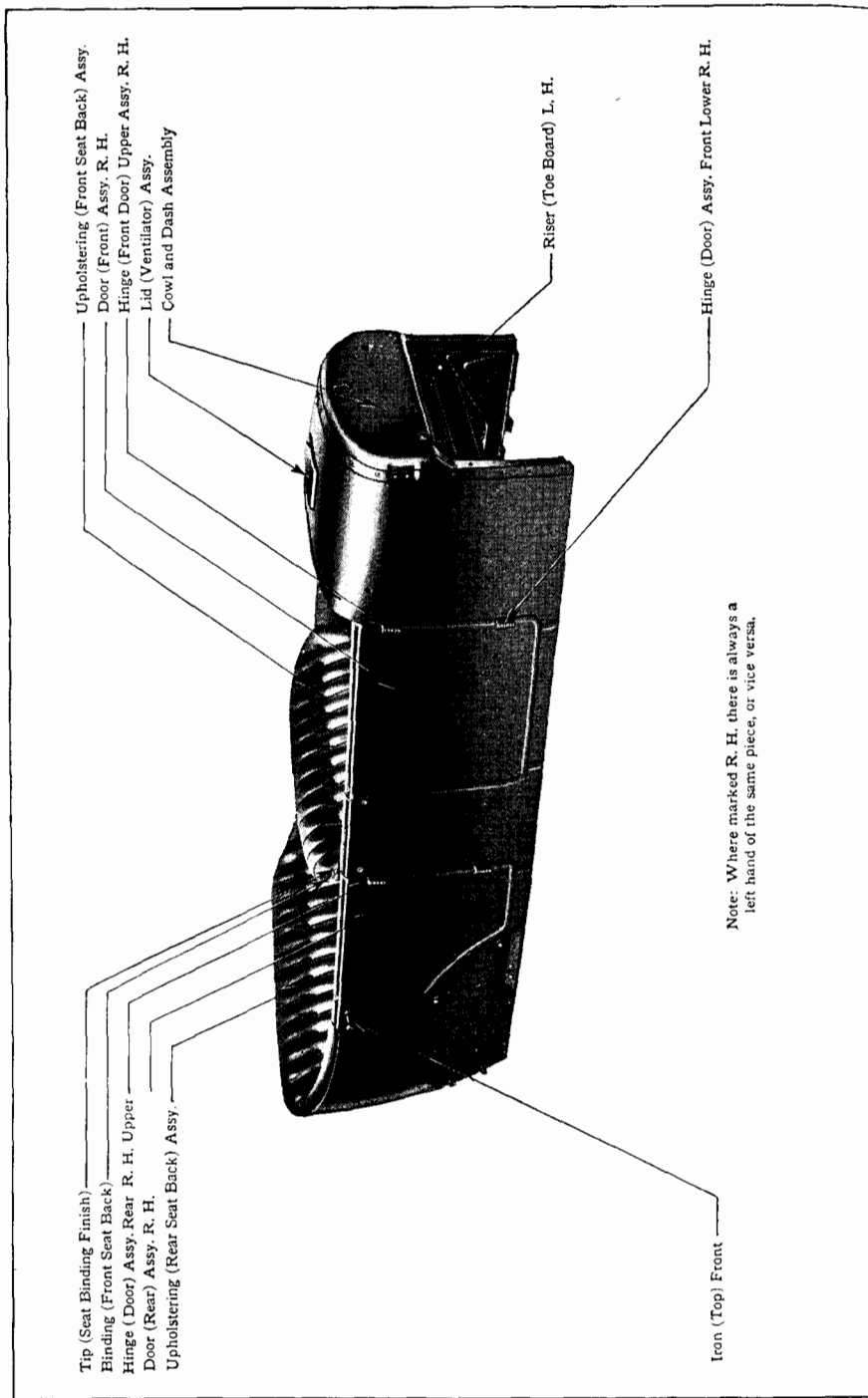

Part No.	NAME	YEAR	PRICE
----------	------	------	-------

TOURING CAR BODY PARTS—1926-27—Continued

45204X	Strip (rear seat trim) side	1926-27	\$0 20
45248X	Strip (rocker panel trim)	1926-27	15
45256X	Strip (seat back spring support)	1926-27	35
45243X	Support (rear floor board)	1926-27	25
45085X	Support (rear seat toe board)	1926-27	10
45067BX	Support (rear seat frame—rear)	1926-27	C5
45055A2X	Support (steering column)	1926-27	20
45568X	Upholstery (front seat arm) assy.—R. H.	1926-27	1 00
45569X	Upholstery (front seat arm) assy.—L. H.	1926-27	1 00
45560AX	Upholstery (front seat arm) assy. (with buttons)	1926-27	3 50
45560BX	Upholstery (front seat back) assy. (without buttons)	1926-27	3 50
45583X	Upholstery (rear seat arm) assy.—R. H.	1926-27	1 00
45584X	Upholstery (rear seat arm) assy.—L. H.	1926-27	1 00
45575AX	Upholstery (rear seat back) assy. (with buttons)	1926-27	3 00
45575BX	Upholstery (rear seat back) assy. (without buttons)	1926-27	3 00

COUPE AND SEDAN WINDSHIELD—1915-23

9025X	Bolt (glass clip)—Cp. Sn.	1915-23	3 50C	05
8689RX	Bracket (hinge) on pillar—Cp. Sn.	1916-23		40
9046RX	Bracket (ventilating) on pillar—R. H.—(Cp. 1919-23)			
	Sn.	1915-23		20
9047RX	Bracket (ventilating) on pillar—L. H.—(Cp. 1919-23)			
	Sn.	1915-23		20
9002RX	Bracket (ventilating) on sash—R. H.—Cp. Sn.	1915-23		15
9003RX	Bracket (ventilating) on sash—L. H.—Cp. Sn.	1915-23		15
9066X	Channel (center)—rubber—Cp. Sn.	1915-23		36
9013RX	Clip (glass) lower—Cp. Sn.	1915-23		10
9011RX	Clip (upper glass) R. H.—Cp. Sn.	1915-23		10
9012RX	Clip (upper glass) L. H.—Cp. Sn.	1915-23		10
9021X	Cone (hinge friction) Cp. Sn.	1915-19		15
G1B-6880X	Glass (upper and lower)—Cp.	1916-19		2 45
G26A-9534X	Glass (upper and lower)—(Cp. 1919-23) Sn.	1916-23		2 35
9014AX	Handle (lower sash) Cp. Sn.	1915-20		20
9014BRX	Handle (lower sash) Cp. Sn.	1920-23		10
9528ARX	Hinge (upper) assy.—R. H.—Cp. Sn.	1916-28		2 00
9528BRX	Hinge (upper) assy.—R. H.—Cp. Sn.	1920-23		2 25
9529ARX	Hinge (upper) assy.—L. H.—Cp. Sn.	1916-28		2 00
9529BRX	Hinge (upper) assy.—L. H.—Cp. Sn.	1920-23		2 25
9026X	Nut (glass clip) Cp. Sn.	1915-23		05
9090X	Retainer (glass) (Cp. 1920-22) Sn.	1915-23		30
9573RX	Retainer (weather strip) side—Cp.	1916-19		15
9537X	Retainer (weather strip) side—(Cp. 1919-21) Sn.	1916-20		15
5364RX	Retainer (weather strip) side—R. H.—Sn.	1920-21		20
10695BX	Retainer (weather strip) side—R. H.	1922-23		35
5365RX	Retainer (weather strip) side—L. H.—Sn.	1920-21		20
10696BX	Retainer (weather strip) side—L. H.	1922-23		35
9572RX	Retainer (weather strip) upper—Cp.	1916-19		20
9536RX	Retainer (weather strip) upper—(Cp. 1919-22) Sn.	1916-21		20
9527RX	Sash (lower) (Cp. 1919-22) Sn.	1916-23		6 50
9526BRX	Sash (upper) Cp. Sn.	1920-23		6 50
9222RX	Screw (lower sash handle)	1920-23	1 50C	03
9574BRX	Screw (upper hinge clamp) Cp. Sn.	1919-22		25
9006BRX	Screw (ventilating bracket thumb) nickel—Cp. Sn.	1919-23		15
9645RX	Strip (weather) side—rubber—Cp. Sn.	1916-23		10
9646RX	Strip (weather) upper—rubber—Cp. Sn.	1916-23		20
G32A-9541RX	Windshield complete—Cp.	1916-19		20 00
G32B-9538RX	Windshield complete—(Cp. 1919-23) Sn.	1916-23		20 50
G30A-9543RX	Windshield lower half assy.—Cp.	1916-19		9 75
G30B-9525RX	Windshield lower half assy.—(Cp. 1919-22) Sn.	1916-23		10 50
G31A-9542RX	Windshield upper half assy.—Cp.	1916-19		10 00
G31B-9524BRX	Windshield upper half assy.—Cp. Sn.	1919-23		10 00
G71A-9524ARX	Windshield upper half assy.—Sn.	1916-19		10 00

COUPE BODY PARTS—1915-23

5052ARX	Anti-rattler (door) assembly—female	1922-23		80
5053ARX	Anti-rattler (door) assembly—male	1922-23		15
8320BX	Anti-rattler (door lock lever)	1920-23		05
9455RX	Anti-rattler (door window) lower	1915-21		02
5095ARX	Anti-rattler (window lifter rod)	1922-23		05
5103X	Arm (window lifter counterbalance) assy.—R. H.	1922-23		40
5104X	Arm (window lifter counterbalance) assy.—L. H.	1922-23		40
10551X	Bar (door bottom) R. H.	1919-22		1 25
10552X	Bar (door bottom) L. H.	1919-22		1 25
9932AX	Beading (roof)	1919-21		3 00
9932BX	Beading (roof) front	1922-23		60
9346X	Beading (roof) rear	1922-23		75

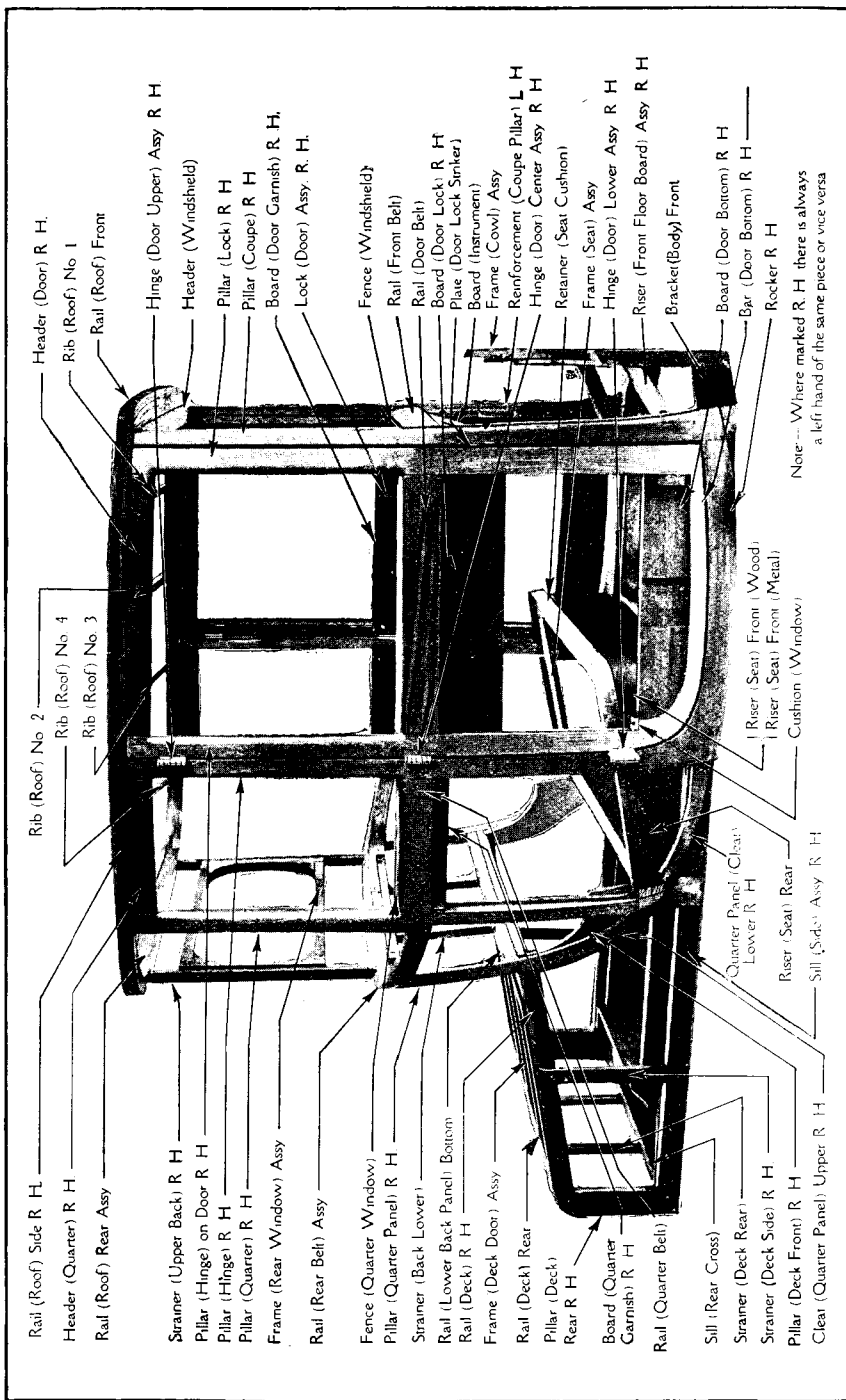

Part No.	NAME	YEAR	PRICE
COUPE BODY PARTS—1915-23—Continued			
10549ARX	Board (door bottom) R. H.	1919-22	\$1 75
10549BX	Board (door bottom) R. H.	1922-23	1 75
10550ARX	Board (door bottom) L. H.	1919-22	1 75
10550BX	Board (door bottom) L. H.	1922-23	1 75
10646X	Board (floor) No. 4	1919-23	1 75
10648BX	Board (instrument)	1922-23	2 00
9458X	Brace (coupe pillar) R. H.	1915-20	25
9459X	Brace (coupe pillar) L. H.	1915-20	25
9105RX	Bracket (hand rail)	1915-21	10
9486RX	Bumper (deck door)	1916-23	05
6927ARX	Bumper (door)	1915-21	05
6927BX	Bumper (door)	1922-23	05
9211RX	Bumper (door sill plate)	1919-21	05
6932RX	Bumper (door top rail)	1919-23	1 25
10728BRX	Carpet (cowl upholstering) assy.—R. H.	1919-23	1 25
10729BRX	Carpet (cowl upholstering) assy.—L. H.	1919-23	1 25
9054BRX	Carpet (floor) assy.	1915-23	4 00
10733BX	Carpet (heel board)	1922-23	1 50
9101ARX	Casing (door bumper)	1915-21	10
9101BX	Casing (door bumper)	1922-23	65
9768RX	Channel (back glass) rubber	1918-23	60
8466X	Channel (door window) assy.—R. H.	1919-21	1 75
8467X	Channel (door window) assy.—L. H.	1919-21	1 75
5229RX	Channel (door window glass) R. H.	1922	40
5230RX	Channel (door window glass) L. H.	1922	40
9997X	Channel (quarter window) assy.	1919-21	2 00
5237X	Channel (quarter window glass) assy.	1922	60
10589X	Cleat (quarter panel) lower—R. H.	1919-23	1 00
10590X	Cleat (quarter panel) lower—L. H.	1919-23	1 00
10591X	Cleat (quarter panel) upper—R. H.	1919-23	1 00
10592X	Cleat (quarter panel) upper—L. H.	1919-21	3 00
9967ARX	Cloth (back upholstering)	1922-23	3 00
9967BX	Cloth (back upholstering)	1923	3 00
9967CX	Cloth (back upholstering)	1923	35
10716BX	Cloth (body hinge pillar trimming)	1923	40
10716CRX	Cloth (body hinge pillar trimming)	1919-21	50
10710AX	Cloth (door header trimming)	1922-23	30
10710BX	Cloth (door header trimming)	1923	30
10710CX	Cloth (door header trimming)	1923	30
10715AX	Cloth (door hinge pillar trimming)	1919-21	50
10757AX	Cloth (door hinge pillar trimming)	1922-23	35
10757BRX	Cloth (door hinge pillar trimming)	1923	35
10715AX	Cloth (door lock pillar trimming)	1919-21	50
10715BX	Cloth (door lock pillar trimming)	1922-23	20
10715CRX	Cloth (door lock pillar trimming)	1923	50
10712AX	Cloth (door weatherstrip trimming)	1919-21	50
10712BX	Cloth (door weatherstrip trimming)	1922-23	30
10712CX	Cloth (door weatherstrip trimming)	1923	30
10709AX	Cloth (quarter header)	1919-21	50
10709BX	Cloth (quarter header)	1922-23	20
10709CX	Cloth (quarter header)	1923	20
10705AX	Cloth (seat cushion retainer)	1919-21	1 00
10705HX	Cloth (seat cushion retainer)	1922-23	1 00
10705CX	Cloth (seat cushion retainer)	1923	1 00
10270ARX	Cloth (trimming) heavy—gray	1919-21	4 00 yd
10270BX	Cloth (trimming) striped—brown	1922-23	6 00 yd
10306ARX	Cloth (trimming) light—gray	1919-21	1 00 yd
18070X	Cloth (trimming) plain—brown	1922-23	4 00 yd
10423RX	Cloth (window sash)	1919-21	50 yd
10706BX	Cloth (windshield header) trimming	1922-23	30
10706CX	Cloth (windshield header) trimming	1923	30
10309AX	Cord (seaming)	1918-21	10 yd
10309BRX	Cord (seaming) assy.	1922-23	10 yd
10311ARX	Cord (wind) assy.	1916-21	20 yd
10311BX	Cord (wind) assy.	1922-23	20 yd
10311CRX	Cord (wind) assy.	1923	20 yd
10816RX	Cover (body hinge pillar) R. H.	1922-23	1 00
10817RX	Cover (body hinge pillar) L. H.	1922-23	1 15
5060X	Cover (door anti-rattler) female	1922-23	1 20
10812RX	Cover (door header) R. H.	1922-23	1 20
10813RX	Cover (door header) L. H.	1922-23	1 00
10814RX	Cover (door hinge pillar) R. H.	1922-23	1 00
10815RX	Cover (door hinge pillar) L. H.	1922-23	80
10810RX	Cover (door lock pillar) R. H.	1922-23	80
10811RX	Cover (door lock pillar) L. H.	1922-23	1 00
10821RX	Cover (front roof rail)	1922-23	1 00
10808RX	Cover (quarter header) R. H.	1922-23	1 00
10809RX	Cover (quarter header) L. H.	1922-23	1 00
10818RX	Cover (quarter pillar) R. H.	1922-23	1 00
10819RX	Cover (quarter pillar) L. H.	1922-23	1 00
10820RX	Cover (windshield header)	1922-23	1 00

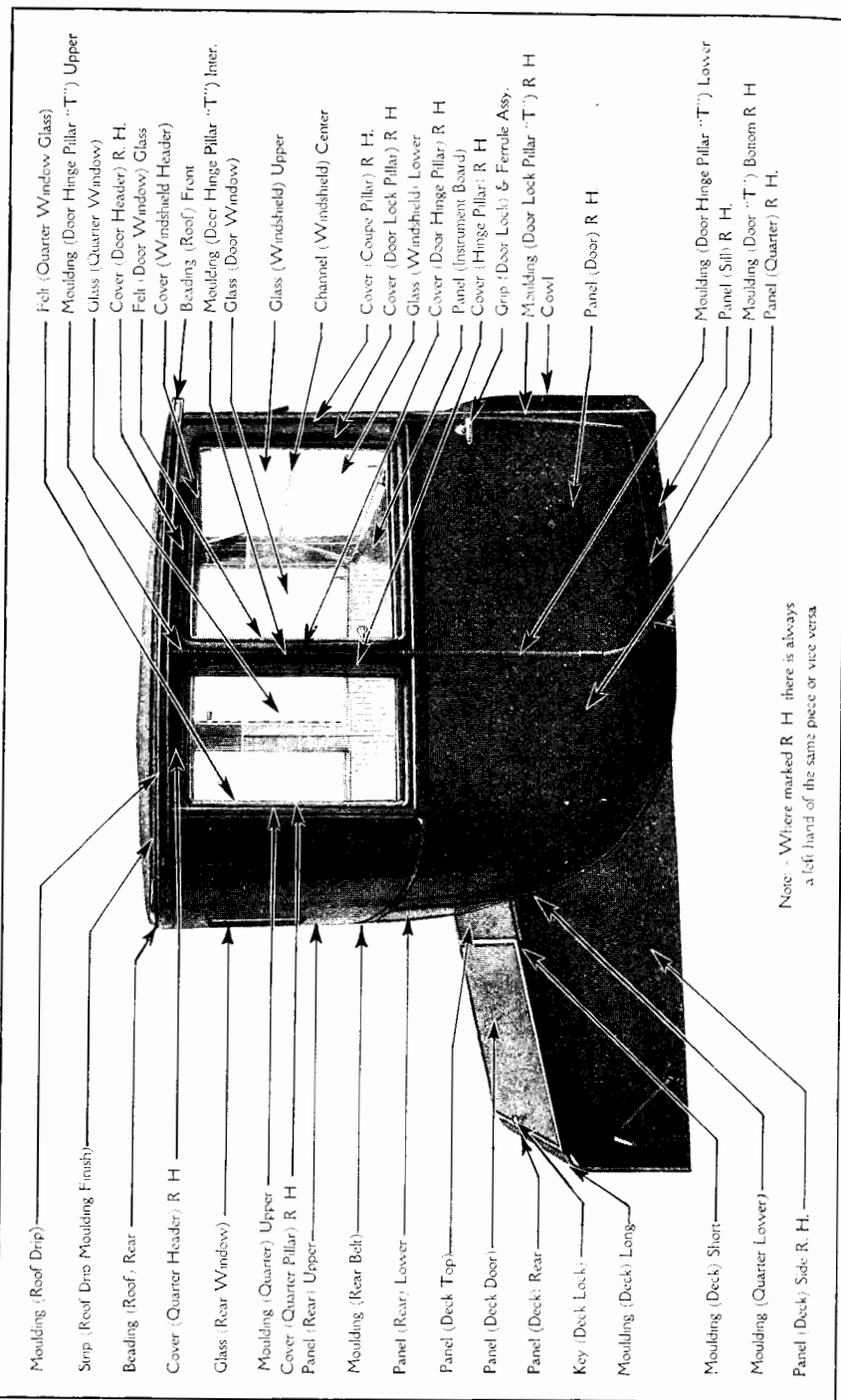

Part No.	NAME	YEAR	PRICE
COUPE BODY PARTS—1915-23—Continued			
9936X	Covering (roof)	1919-23	\$ 5 00
9185BX	Cowl	1919-23	20 00
50516X	Curtain (window) assy.	1922-23	2 00
5057X	Cushion (door anti-rattler)	1922-23	05
9621BRX	Cushion (seat) assy.	1918-21	*13 00
9621CRX	Cushion (seat) assy.	1922-23	*15 00
9621DX	Cushion (seat) assy.	1923	*15 00
10427ARX	Cushion (seat back) assy.	1919-21	15 00
10427BRX	Cushion (seat back) assy.	1922-23	15 00
10427CX	Cushion (seat back) assy.	1923	15 00
9462X	Cushion (window)	1915-23	03
10700CX	Door assy.—inc. window—R. H.	1922-23	*45 00
10700DX	Door assy.—inc. window—R. H.	1923	*45 00
10701CX	Door assy.—inc. window—L. H.	1922-23	*45 00
10701DX	Door assy.—inc. window—L. H.	1923	*45 00
10645X	Door (battery trap)	1920-23	75
9946X	Door (deck) assy. (Painted)	1916-23	8 00
10700BX	Door—less window—R. H.	1920-21	*45 00
10701BX	Door—less window—L. H.	1920-21	*45 00
8699X	Fence (door window)	1919-21	30
9995X	Fence (quarter window)	1919-20	20
9084AX	Fence (windshield)	1919-21	45
9084BX	Fence (windshield)	1922-23	45
9703ARX	Ferrule (door grip)	1917-23	15
10692X	Floor (metal rear) assy.	1922-23	10 00
10565X	Frame (cowl) assy.	1919-23	9 00
10525X	Frame (deck door) assy.	1919-23	7 50
10593X	Frame (rear window) assy.	1919-23	6 00
10520ARX	Frame (roof) assy.	1919-22	*20 00
10520BX	Frame (roof) assy.	1922-23	*20 00
10599X	Frame (seat) assy.	1919-23	6 00
16200X	Frame (seat back cushion) assy.	1919-23	3 00
G36C-9836RX	Glass (door window)	1917-19	3 75
G36D-8127ARX	Glass (door window)	1920-21	3 55
G36E-8127BRX	Glass (door window)	1922-23	3 55
G37A-8460RX	Glass (door window) and channel assy.—R	1922-23	4 75
G37B-8461RX	Glass (door window) and channel assy.—L	1922-23	4 75
G41B-9864RX	Glass (quarter window)	1918-19	2 65
G41C-8639ARX	Glass (quarter window)	1920-21	2 50
G41D-8639BRX	Glass (quarter window)	1922	2 60
G29C-9885RX	Glass (rear window) oval	1918-22	2 45
9058CRX	Grip (door lock) and ferrule assy.—"T"	1921	50
9058DRX	Grip (door lock) and ferrule assy.—"L"	1922-23	75
5378X	Handle (door pull)	1922-23	60
10543BRX	Header (door) R. H.	1922	2 25
10543CX	Header (door) R. H.	1922-23	2 25
10544BRX	Header (door) L. H.	1922	2 25
10544CX	Header (door) L. H.	1922-23	2 25
10649BX	Header (quarter) R. H.	1922	2 25
10649CX	Header (quarter) R. H.	1922-23	2 25
10650BX	Header (quarter) L. H.	1922	2 25
10650CX	Header (quarter) L. H.	1922-23	2 25
10647BX	Header (windshield)	1922	2 50
9481X	Hinge (deck door)	1916-23	40
8624AX	Hinge (door) assy.—center—R. H.	1920-23	50
8625AX	Hinge (door) assy.—center—L. H.	1920-23	50
8636AX	Hinge (door) assy.—lower—R. H.	1920-23	50
9579ARX	Hinge (door) assy.—lower—L. H.	1920-23	50
8630AX	Hinge (door) assy.—upper—R. H.	1920-23	50
8631AX	Hinge (door) assy.—upper—L. H.	1920-23	50
9484X	Key (deck lock)	1916-23	10
10342AX	Lace (pasting)	1915-21	15 yd
10342BRX	Lace (pasting)	1922-23	10 yd
9182BRX	Lever (door lock)	1920-22	35
9551BRX	Lifter (door window)	1918-20	1 25
9917AX	Lifter (quarter window)	1918-20	1 00
9917BX	Lifter (quarter window)	1922-23	1 00
9917AX	Lifter (window)	1921	1 00
9956AX	Lining (head) assy.	1918-21	4 00
9956BX	Lining (head) assy.	1922-23	7 00
9956CX	Lining (head) assy.	1923	7 00
9051BRX	Lock (door) R. H.	1920-23	1 50
9052BX	Lock (door) L. H.	1920-23	1 50
9482X	Lock (deck door)	1916-23	25
9802RX	Moulding (belt) door	1919-21	1 80
9718X	Moulding (belt) quarter	1919-23	1 00
9315X	Moulding (belt) rear	1919-23	2 50
9717X	Moulding (deck) long	1919-23	60
9712X	Moulding (deck) short	1919-23	25
9924RX	Moulding (door hinge pillar "T") intermediate	1919-23	25

* Not subject to regular discount.

1919

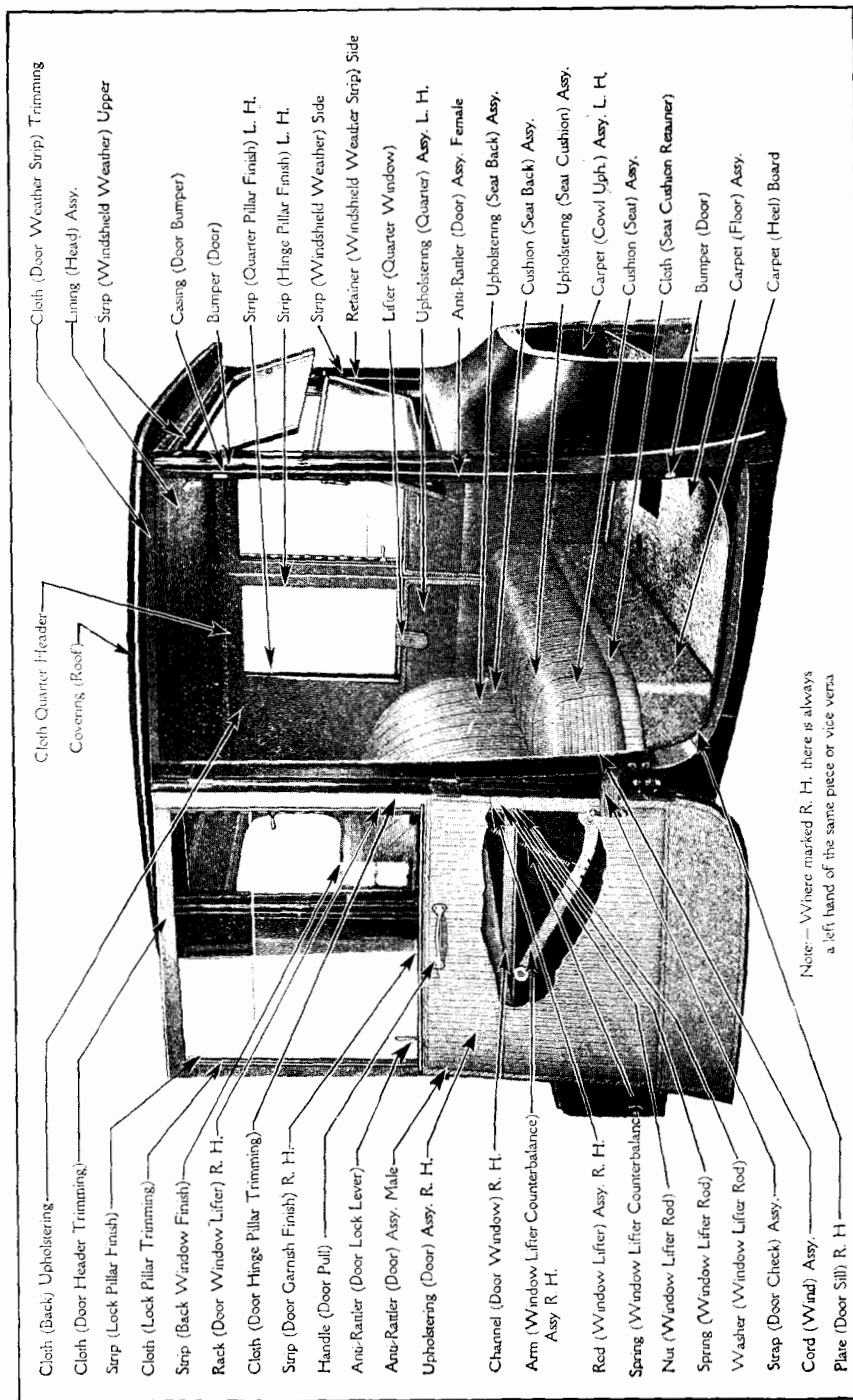

Part No.	NAME	YEAR	PRICE
COUPE BODY PARTS—1915-23—Continued			
9923RX	Moulding (door hinge pillar "T") lower	1919-23	\$0 20
9922RX	Moulding (door hinge pillar "T") upper	1919-23	10
9925RX	Moulding (door lock pillar "T") R. H.	1919-23	50
9926RX	Moulding (door lock pillar "T") L. H.	1919-23	50
9927RX	Moulding (door "T") bottom—R. H.	1919-23	35
9928RX	Moulding (door "T") bottom—L. H.	1919-23	35
9862RX	Moulding (quarter) lower—R. H.	1919-23	85
9863RX	Moulding (quarter) lower—L. H.	1919-23	85
9809RX	Moulding (quarter) upper—R. H.	1919-23	60
9810RX	Moulding (quarter) upper—L. H.	1919-23	60
9719BX	Moulding (roof drip)	1922-23	40
5085BX	Nut (window lifter rod)	1922-23	1 00C
9826X	Panel (deck door)	1919-23	7 50
9469X	Panel (deck) rear	1916-23	4 50
9191X	Panel (deck) side—R. H.	1915-23	7 00
9192X	Panel (deck) side—L. H.	1915-23	7 00
9947X	Panel (deck) top	1915-23	1 50
9721CX	Panel (door) R. H.	1922-23	9 00
9722CX	Panel (door) L. H.	1922-23	9 00
8026BX	Panel (instrument board)	1922-23	2 50
9723CX	Panel (quarter) R. H.	1922-23	13 00
9724CX	Panel (quarter) L. H.	1922-23	13 00
9190BX	Panel (rear) lower	1920-23	8 00
9945CX	Panel (rear) upper—with bead	1922-23	16 00
8997X	Panel (rocker) R. H.	1919-23	60
8998X	Panel (rocker) L. H.	1919-23	60
9184AX	Pawl (door lock plunger)	1915-23	15
10570X	Pillar (deck) rear—R. H.	1919-23	1 50
10571X	Pillar (deck) rear—L. H.	1919-23	1 50
10516BRX	Pillar (hinge) R. H.	1922	7 50
†10516CX	Pillar (hinge) R. H.	1922-23	7 50
10517BRX	Pillar (hinge) L. H.	1922	7 50
†10517CX	Pillar (hinge) L. H.	1922-23	7 50
10540BRX	Pillar (hinge) on door—R. H.	1922	4 00
†10540CX	Pillar (hinge) on door—R. H.	1922-23	4 00
10541BRX	Pillar (hinge) on door—L. H.	1922	4 00
†10541CX	Pillar (hinge) on door—L. H.	1922-23	4 00
10538BRX	Pillar (lock) R. H.	1922	4 50
†10538CX	Pillar (lock) R. H.	1922-23	4 50
10539BRX	Pillar (lock) R. H.	1922	4 50
†10539CX	Pillar (lock) R. H.	1922-23	4 50
10518BRX	Pillar (quarter) R. H.	1922	4 50
†10518CX	Pillar (quarter) R. H.	1922-23	4 50
10519BRX	Pillar (quarter) L. H.	1922	4 50
†10519CX	Pillar (quarter) L. H.	1922-23	4 50
10587X	Pillar (quarter panel) R. H.	1919-23	3 50
10588X	Pillar (quarter panel) L. H.	1919-23	3 50
9654RX	Pin (door hinge)	1915-23	03
9479RX	Pin (window lifter)	1915-23	03
9487X	Plate (deck door bumper)	1916-23	05
9485X	Plate (deck door lock striker)	1916-23	10
5059X	Plate (door anti-rattler cushion)	1922-23	03
17276AX	Plate (door lock striker)	1919-23	10
9727X	Plate (door sill) R. H.	1919-23	30
9728X	Plate (door sill) L. H.	1919-23	30
5088X	Plate (window lifter spring suspension)	1922-23	05
9073X	Plate (window lifter strap)	1915-21	03
7590X	Plunger (door lock) R. H.	1915-23	20
9454AX	Plunger (door lock) L. H.	1915-23	20
5224X	Rack door window lifter—R. H.	1922-23	45
5225X	Rack door window lifter—L. H.	1922-23	45
10575X	Rail (deck) R. H.	1919-23	1 50
10576X	Rail (deck) L. H.	1919-23	1 50
10577X	Rail (deck) rear	1919-23	1 50
10542X	Rail (door belt)	1916-21	1 75
9822X	Rail (door hand) assy.	1919-23	2 00
10531X	Rail (front belt)	1919-23	1 50
10532X	Rail (rear belt) assy.	1919-23	8 50
10556BX	Rail (roof) assy.—rear	1922-23	7 50
10553BX	Rail (roof) front	1922-23	2 00
10554BX	Rail (roof) side—R. H.	1922-23	3 50
10555BX	Rail (roof) side—L. H.	1922-23	3 50
10611X	Reinforcement (coupe pillar) R. H.	1919-23	1 25
10612X	Reinforcement (coupe pillar) L. H.	1919-23	1 25
5238X	Retainer (door window weather strip)	1922-23	15
10560BX	Rib (roof) No. 1	1919-23	1 35
10561BX	Rib (roof) No. 2	1919-23	1 35
10562BX	Rib (roof) No. 3	1919-23	1 35
10563BX	Rib (roof) No. 4	1919-23	1 35
10662X	Riser (front floor board) assy.—R. H.	1919-23	2 25

†With metal cover assembled.

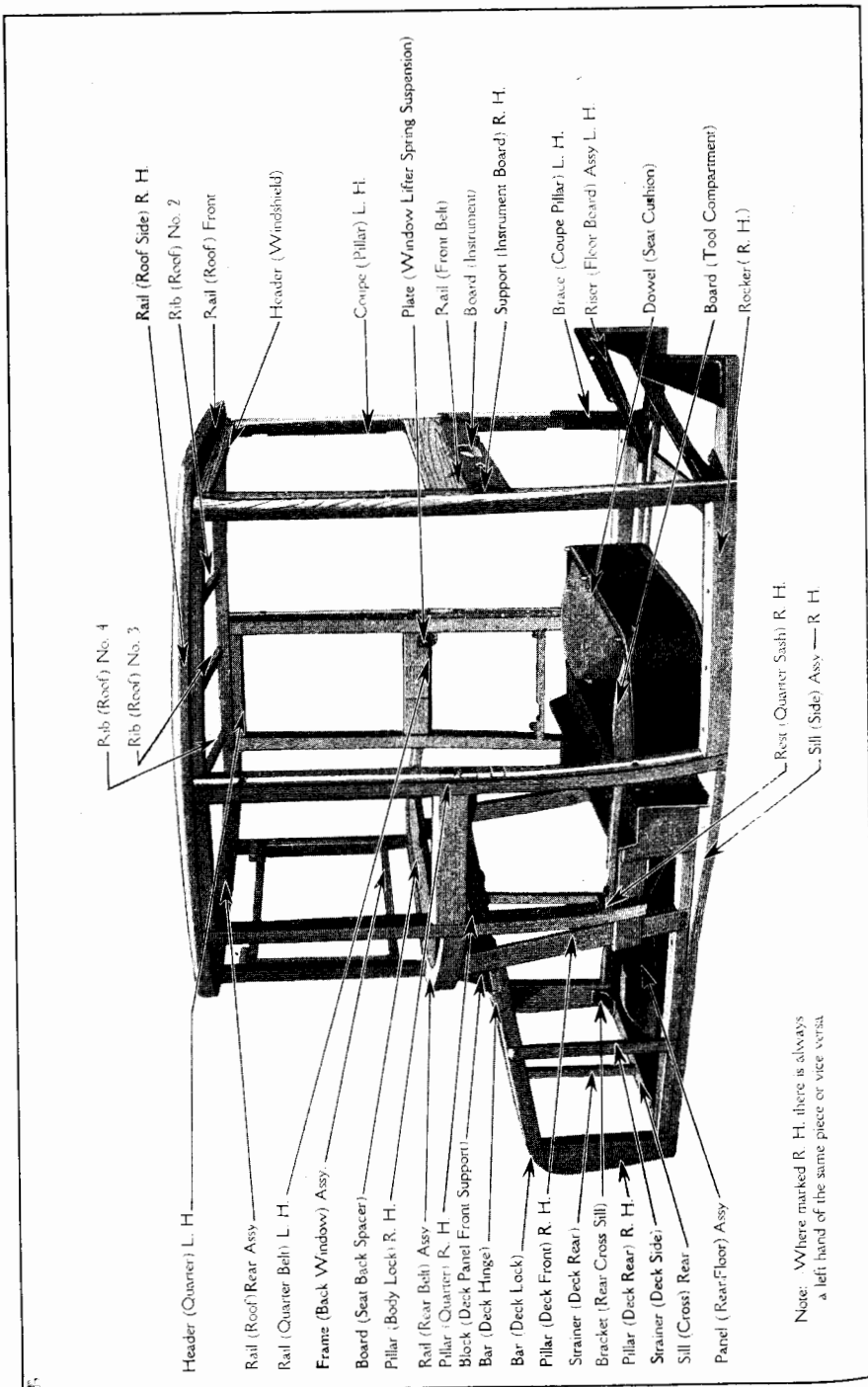

Part No.	NAME	YEAR	PRICE
COUPE BODY PARTS—1915-23—Continued			
10663X	Riser (front floor board) assy.—L. H.	1919-23	\$2 25
10604BX	Riser (seat) front	1922-23	3 50
10613X	Rocker—R. H.	1919-23	1 75
10614X	Rocker—L. H.	1919-23	1 75
5081RX	Rod (window lifter) assy.—R. H.	1922-23	40
5082RX	Rod (window lifter) assy.—L. H.	1922-23	40
9759A1X	Roller (window curtain) assy.	1922-23	90
18811X	Run (window glass)	1922-23	40
10665X	Sill (side) assy.—R. H.	1919-23	10 00
10666X	Sill (side) assy.—L. H.	1919-23	10 00
9938X	Spring (back cushion)	1915-23	1 50
9183AX	Spring (door lock lever)	1915-23	05
8122BX	Spring (seat cushion)	1915-23	4 00
5092X	Spring (window lifter counterbalance)	1922-23	10
5067BX	Spring (window lifter rod)	1922-23	03
9059ARX	Strap (door check) assy.	1915-21	40
10735AX	Strip (back window finish) assy.	1919-21	1 25
10735BRX	Strip (back window finish) assy.	1922-23	1 25
9713X	Strip (deck opening finish)	1916-23	1 00
8649CRX	Strip (door garnish finish) R. H.	1920-21	20
8679CRX	Strip (door garnish finish) L. H.	1920-21	20
10504X	Strip (door header finish) R. H.	1919-21	35
10505X	Strip (door header finish) L. H.	1919-21	35
10500X	Strip (door hinge pillar finish) R. H.	1919-21	25
10501X	Strip (door hinge pillar finish) L. H.	1919-21	25
5245X	Strip (door lock pillar finish)	1922-23	80
10752ARX	Strip (door window glass retainer) $\frac{1}{8}$ " thick	1922-23	10
10752BRX	Strip (door window glass retainer) $\frac{1}{8}$ " thick	1922-23	10
5233X	Strip (door window weather)	1922-23	15
5246X	Strip (hinge pillar finish)	1922-23	80
10508X	Strip (hinge pillar finish) R. H.	1919-21	25
10509X	Strip (hinge pillar finish) L. H.	1919-21	25
10502X	Strip (lock pillar finish) R. H.	1919-21	20
10503X	Strip (lock pillar finish) L. H.	1919-21	20
10506BRX	Strip (quarter garnish finish)	1919-21	20
10506CRX	Strip (quarter garnish finish)	1922-23	20
10512X	Strip (quarter header finish) R. H.	1919-21	15
10513X	Strip (quarter header finish) L. H.	1919-21	15
5246X	Strip (quarter pillar finish)	1922-23	30
10510X	Strip (quarter pillar finish) R. H.	1919-21	25
10511X	Strip (quarter pillar finish) L. H.	1919-21	25
8649DRX	Strip (door garnish finish) R. H.	1922-23	20
8649ERX	Strip (door garnish finish) R. H.—with pull boss	1923	20
8679DRX	Strip (door garnish finish) L. H.	1922-23	20
8679ERX	Strip (door garnish finish) L. H.—with pull boss	1923	20
10754ARX	Strip (quarter window glass retainer) $\frac{1}{8}$ " thick	1922-23	10
10754BRX	Strip (quarter window glass retainer) $\frac{1}{8}$ " thick	1922-23	10
9617X	Strip (roof drip moulding finish)	1922-23	20
9488X	Support (deck door)	1916-23	50
10726BX	Trimming (door weather strip) assy.	1922-23	50
10726CRX	Trimming (door weather strip) assy.	1923	50
10733AX	Trimming (heel board)	1919-21	1 50
9902AX	Upholstering (door) assy.—R. H.	1918-21	7 00
9902BX	Upholstering (door) assy.—R. H.	1922-23	4 50
9902CX	Upholstering (door) assy.—R. H.	1923	4 50
9902DX	Upholstering (door) assy.—R. H.	1923	4 50
9903AX	Upholstering (door) assy.—L. H.	1918-21	7 00
9903BX	Upholstering (door) assy.—L. H.	1922-23	4 50
9903CX	Upholstering (door) assy.—L. H.	1923	4 50
9903DX	Upholstering (door) assy.—L. H.	1923	4 50
9896BX	Upholstering (quarter) assy.—R. H.	1919-21	2 25
9896CX	Upholstering (quarter) assy.—R. H.	1922-23	2 50
9896DX	Upholstering (quarter) assy.—R. H.	1923	2 50
9897BX	Upholstering (quarter) assy.—L. H.	1919-21	2 25
9897CX	Upholstering (quarter) assy.—L. H.	1922-23	2 50
9897DX	Upholstering (quarter) assy.—L. H.	1923	2 50
10451AX	Upholstering (seat back) assy.	1919-21	7 50
10451BX	Upholstering (seat back) assy.	1922-23	7 50
10451CRX	Upholstering (seat back) assy.	1923	7 50
10450AX	Upholstering (seat cushion) assy.	1919-21	9 00
10450BX	Upholstering (seat cushion) assy.	1922-23	9 00
10450CRX	Upholstering (seat cushion) assy.	1923	9 00
8379ARX	Window (door) R. H.	1919-21	6 25
8402X	Window (door) L. H.	1919-21	6 25
8415AX	Window (quarter)	1919-21	4 60
COUPE BODY PARTS—1924-25			
8320BX	Anti-rattler (door lock lever)	1924-25	05
17385X	Arm (window lifter counterbalance) assy.—R. H.	1924-25	40
17386X	Arm (window lifter counterbalance) assy.—L. H.	1924-25	40

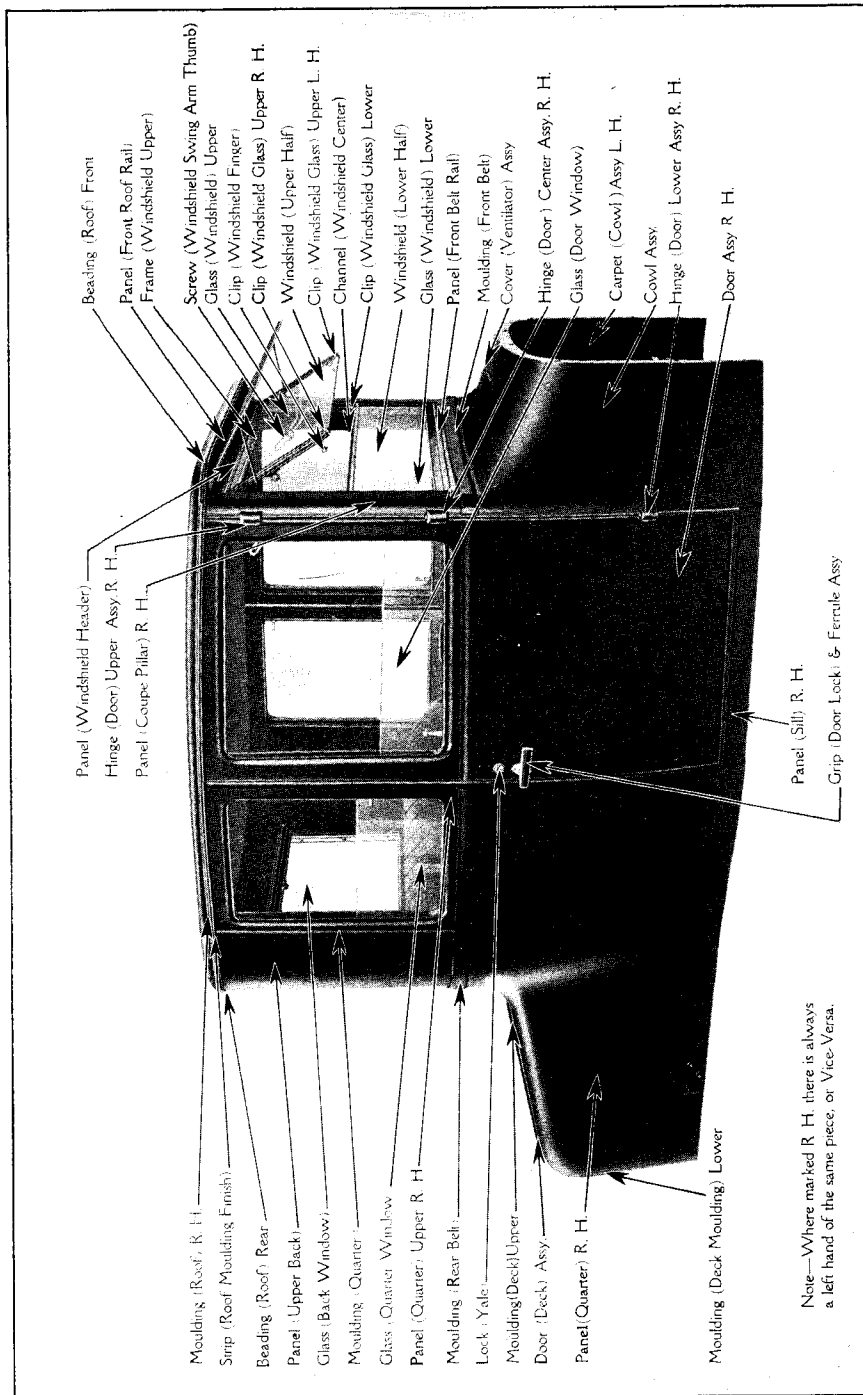

Part No.	NAME	YEAR	PRICE
COUPE BODY PARTS—1924-25—Continued			
17316ARX	Arm (windshield swing)	1924-25	\$0 50
16302RX	Bar (deck hinge)	1924-25	1 75
16301RX	Bar (deck lock) and bumper assy.	1924-25	1 75
18210X	Beading (roof)	1924-25	45
†16304ARX	Block (deck panel front support)—R. H.	1924	
†16304BRX	Block (deck panel front support)—R. H.	1924-25	
†16305ARX	Block (deck panel front support)—L. H.	1924	
†16305BRX	Block (deck panel front support)—L. H.	1924-25	
9495BX	Board (floor) No. 1 and plate assy.	1924-25	75
9496BX	Board (floor) No. 2 and plate assy.	1924-25	75
8169X	Board (floor) No. 3 and plate assembly	1924-25	1 70
17144X	Board (heel) assy.	1924-25	1 65
16023RX	Board (instrument)	1924-25	3 00
†16306ARX	Board (seat back spacer)	1924	
†16306BRX	Board (seat back spacer)	1924	
†16306CRX	Board (seat back spacer)	1924-25	
16157X	Board (tool compartment)	1924	1 00
7166X	Bolt (steering column support—upper to lower)	1924-25	50C 01
17335X	Bolt (windshield swing arm bracket)	1924-25	03
17050RX	Brace (coupe pillar) R. H.	1924-25	45
17051RX	Brace (coupe pillar) L. H.	1924-25	45
17072BRX	Brace (cowl) R. H.	1924-25	20
17073BRX	Brace (cowl) L. H.	1924-25	20
17412RX	Bracket (rear cross sill)	1924	15
17042RX	Bracket (ventilator hinge) on cowl	1924-25	20
17043X	Bracket (ventilator hinge) on shield	1924-25	10
17086RX	Bracket (visor)	1924-25	20
6927B2X	Bumper (door) long	1924-25	05
6927B1X	Bumper (door) short	1924-25	05
17352RX	Cap (visor bracket to visor rivet)	1924-25	05 dz.
18226RX	Cardboard (body lock pillar breakover) assy.	1924-25	20
18148RX	Cardboard (coupe pillar breakover) assy.—R. H.	1924-25	20
18149RX	Cardboard (coupe pillar breakover) assy.—L. H.	1924-25	20
18141X	Cardboard (door header breakover) assy.	1924	20
18142RX	Cardboard (door hinge pillar breakover) assy.	1924	20
18143X	Cardboard (door lock pillar breakover) assy.	1924	20
18124BRX	Carpet (cowl) assy.—R. H.	1924-25	1 00
18125BRX	Carpet (cowl) assy.—L. H.	1924-25	1 00
18120BRX	Carpet (floor) assy.	1924-25	3 75
18122BRX	Carpet (heel board) assy.	1924-25	2 00
9101X	Casing (door bumper)	1924-25	05
18804BX	Channel (back window glass)	1924-25	20
17118BRX	Channel (door window glass) assy.	1924	35
17387RX	Channel (quarter window glass) R. H.	1924-25	35
17388RX	Channel (quarter window glass) L. H.	1924-25	35
18800RX	Channel (windshield center)	1924-25	60
17325RX	Clip (windshield finger)	1924	15
17331RX	Clip (windshield glass) lower	1924-25	05
17322ARX	Clip (windshield glass) upper R. H.	1924	05
17322BRX	Clip (windshield glass) upper R. H.	1924-25	05
17323ARX	Clip (windshield glass) upper L. H.	1924	05
17323BX	Clip (windshield glass) upper L. H.	1924-25	05
18070RX	Cloth (trimming) plain	1924-25	4 00 yd.
18050RX	Cloth (trimming) striped	1924-25	5 00 yd.
18097RX	Cloth (upper back trimming) side	1924-25	1 00
18079RX	Cloth (upper back trimming) upper and lower	1924-25	45
18213RX	Cord (head lining seaming) assy.	1924-25	10 yd.
17048X	Cover (ventilator) assy.	1924-25	75
†7019BX	Cowl assy.	1924	12 00
17019CX	Cowl assy.	1924-25	12 00
50516X	Curtain (window) assy.	1924-25	2 00
18192RX	Cushion (seat) assy.—R. H.	1924-25	10 00
18193RX	Cushion (seat) assy.—L. H.	1924-25	10 00
18191RX	Cushion (seat back) assy.	1924-25	15 00
2069BX	Cushion (steering column)	1924-25	03
9462X	Cushion (window)	1924-25	03
18034A2X	Door assy.—L. H. (complete) (painted)	1924-25	*30 00
18033A2X	Door assy.—R. H. (complete) (painted)	1924-25	*30 00
10645X	Door (battery trap) assy.	1924-25	1 50
17423ARX	Door (deck) assy. (painted)	1924	7 50
5052BX	Dovetail (female) assy.	1924-25	20
5053BX	Dovetail (male)	1924-25	10
17076X	Dowel (seat cushion)	1924-25	05
16019X	Frame (back window) assy.	1924-25	4 00
17300RX	Frame (windshield—upper) hinge and channel assy.	1924-25	5 00
G49-18830	Glass (back window)	1924-25	2 25
G47-18833	Glass (door window)	1924-25	3 00
G53-18854	Glass (door window) and channel assy.—R. H.	1924-25	3 60
G54-18855	Glass (door window) and channel assy.—L. H.	1924-25	3 60

† Have made locally.
 * Not subject to regular discount.

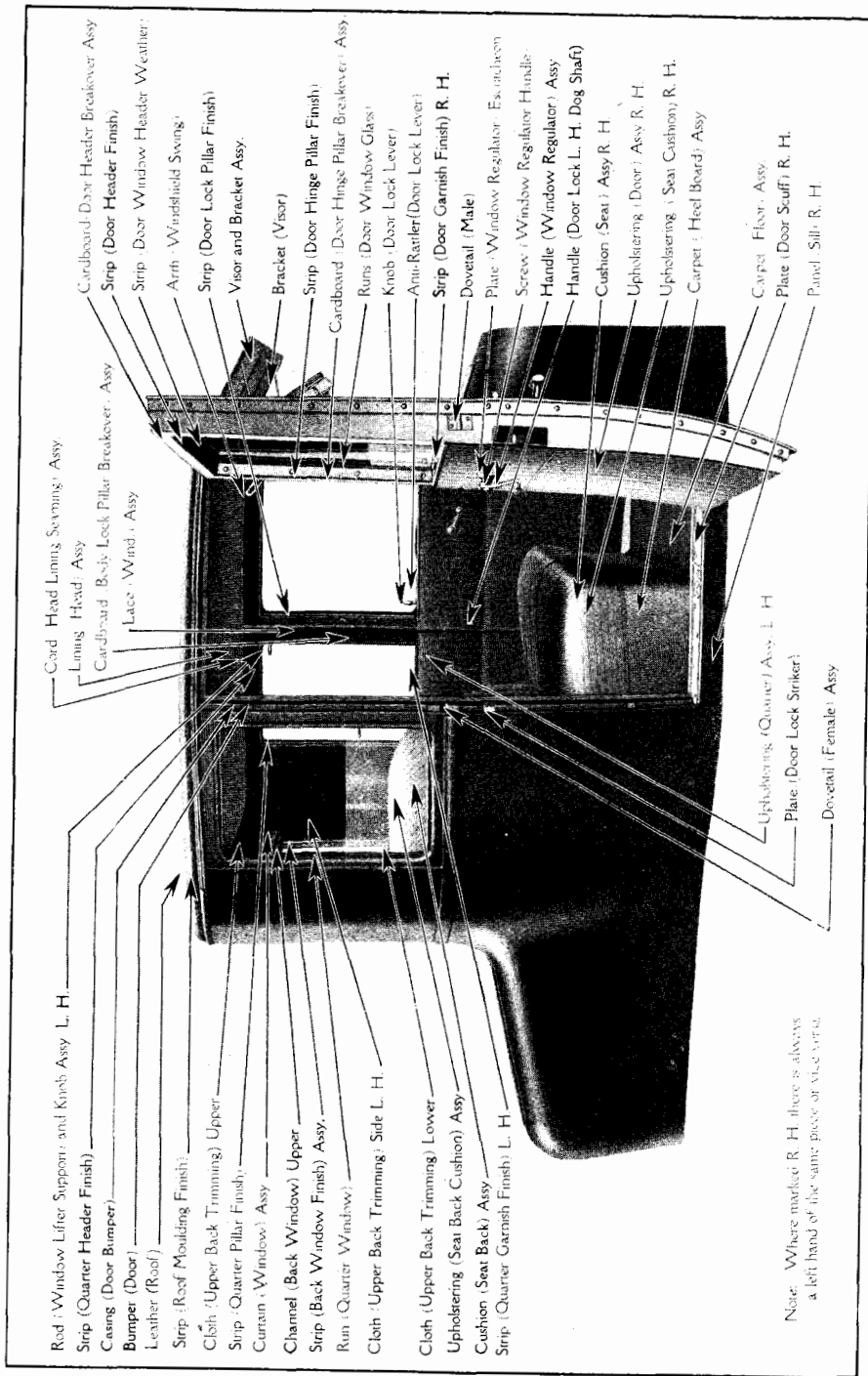

Note: Where marked R. H. there is always a left hand of the same piece or vice versa.

Part No.	NAME	YEAR	PRICE
COUPE BODY PARTS—1924-25—Continued			
G48-18836	Glass (quarter window)	1924-25	\$2 20
G45-18834	Glass (windshield) lower	1924-25	2 00
G46-18835	Glass (windshield) upper	1924-25	2 45
G55-18863	Glass (quarter window) and channel assy.—R. H.	1924-25	3 25
G56-18864	Glass (quarter window) and channel assy.—L. H.	1924-25	3 25
17130ARX	Grip (door lock) and ferrule assy.	1924	1 25
17130BRX	Grip (door lock) and ferrule assy.	1925	1 60
17044X	Handle (cowl ventilator)	1924-25	10
17273X	Handle (door lock L. H. dog shaft)	1924	15
17221ARX	Handle (window regulator) assy.	1924	65
17221BX	Handle (window regulator) assy.	1924	40
16310RX	Header (quarter) R. H.	1924-25	1 25
16311RX	Header (quarter) L. H.	1924-25	1 25
16090RX	Header (windshield)	1924-25	1 00
17401RX	Hinge (deck door) assy.	1924	45
17175ARX	Hinge (door) center assy.—R. H.	1924-25	40
17183ARX	Hinge (door) center assy.—L. H.	1924-25	40
17178ARX	Hinge (door) lower assy.—R. H.	1924-25	40
17186ARX	Hinge (door) lower assy.—L. H.	1924-25	40
17172ARX	Hinge (door) upper assy.—R. H.	1924-25	40
17180ARX	Hinge (door) upper assy.—L. H.	1924-25	40
9484X	Key (deck lock)	1924-25	7 00C
17282X	Key (safety lock) specify serial letters and number	1924-25	25
17261BX	Knob (door lock lever)	1924-25	15
18214RX	Lace (wind) assy.	1924-25	20 yd.
18159X	Leather (roof)	1924-25	4 50
18045RX	Lining (head) assy.	1924-25	5 00
9482X	Lock (deck) assy.	1924-25	25
17252ARX	Lock (door) assy.—R. H.—Ford design	1924	1 50
17750X	Lock (door) assy.—R. H.	1925	85
17250ARX	Lock (door) assy.—L. H.—Ford design	1924	1 50
17751X	Lock (door) assy.—L. H.	1925	85
17279X	Lock (safety) and keys	1924-25	1 00
17416RX	Moulding (deck moulding) upper	1924	20
17417RX	Moulding (deck moulding) lower	1924	40
17162RX	Moulding (front belt)	1924	1 50
17418RX	Moulding (quarter)	1924	45
17415RX	Moulding (rear belt)	1924	3 50
9719BX	Moulding (roof) R. H.	1924-25	40
9738RX	Moulding (roof) L. H.	1924-25	40
9085BX	Nut (window lifter support rod)	1924-25	1 00C
17334X	Nut (windshield swing arm bracket on channel bolt)	1924-25	03
17027BRX	Panel (coupe pillar) R. H.	1924-25	03
17028BRX	Panel (coupe pillar) L. H.	1924-25	45
17325X	Panel (deck door)	1924-25	45
17374X	Panel (deck) front	1924	3 50
17376X	Panel (deck) rear	1924	1 50
17450A3X	Panel (door) and frame assy.—R. H.	1924-25	2 75
17451A3X	Panel (door) and frame assy.—L. H.	1924-25	15 00
17017RX	Panel (front belt rail)	1924	40
17018RX	Panel (front roof rail)	1924	50
17016RX	Panel (instrument)	1924-25	1 25
17369RX	Panel (quarter) upper R. H.	1924-25	4 00
17370RX	Panel (quarter) upper L. H.	1924-25	4 00
17371X	Panel (quarter) lower R. H.	1924	12 00
17372X	Panel (quarter) lower L. H.	1924	12 00
17378RX	Panel (rear floor) assy.	1924	3 00
17434X	Panel (rocker) R. H.	1924-25	85
17435X	Panel (rocker) L. H.	1924-25	85
17373RX	Panel (upper back)	1924-25	6 00
17022RX	Panel (windshield header)	1924-25	50
16526RX	Pillar (body lock) R. H.	1924-25	3 00
16527RX	Pillar (body lock) L. H.	1924-25	3 00
16050RX	Pillar (coupe) R. H.	1924-25	4 50
16051RX	Pillar (coupe) L. H.	1924-25	4 50
16316RX	Pillar (deck front) R. H.	1924	4 50
16317RX	Pillar (deck front) L. H.	1924	
16318RX	Pillar (deck rear) R. H.	1924	
16319RX	Pillar (deck rear) L. H.	1924	
16314RX	Pillar (quarter) R. H.	1924-25	3 00
16315RX	Pillar (quarter) L. H.	1924-25	3 00
17047X	Pin (ventilator hinge clevis)	1924-25	02
9485X	Plate (deck lock striker)	1924	10
17113X	Plate (door scuff) R. H.	1924	30
17447RX	Plate (door scuff) R. H.	1924-25	40
17114X	Plate (door scuff) L. H.	1924	30
17448RX	Plate (door scuff) L. H.	1924-25	40
17276AX	Plate (door lock striker)	1924-25	10
17490X	Plate (door lock striker)	1924-25	10
17274X	Plate (door lock—L. H. dog shaft escutcheon)	1924	02

† Have made locally.

Part No.	NAME	YEAR	PRICE
----------	------	------	-------

COUPE BODY PARTS—1924-25—Continued

5088X	Plate (window lifter spring suspension)	1924-25	\$0 05
17227ARX	Plate (window regulator) escutcheon	1924	05
17227BX	Plate (window regulator) escutcheon	1925	05
17281X	Plate (Yale lock escutcheon)	1924	10
17045BRX	Quadrant (ventilator handle)	1924-25	15
17111X	Rack (window lifter) R. H.	1924-25	30
17112X	Rack (window lifter) L. H.	1924-25	30
16070RX	Rail (front belt)	1924-25	1 00
16320RX	Rail (quarter belt) R. H.	1924-25	1 50
16321RX	Rail (quarter belt) L. H.	1924-25	1 50
16325RX	Rail (rear belt) assy.	1924-25	7 50
16326RX	Rail (roof) front	1924	1 50
16087BRX	Rail (roof) front	1924-25	1 00
16327ARX	Rail (roof) side—R. H.	1924	3 00
16327BX	Rail (roof) side—R. H.	1924-25	3 00
16328ARX	Rail (roof) side—L. H.	1924	3 00
16328BX	Rail (roof) side—L. H.	1924-25	3 00
16332RX	Rail (roof) rear—assy.	1924	7 50
	Regulator (window) assy.—see page 93	1924-25	
16035RX	Rest (door sash)	1924	10
†16335RX	Rest (quarter sash) R. H.	1924-25	
†16336RX	Rest (quarter sash) L. H.	1924-25	
17315AX	Retainer (windshield glass) upper (use with thin glass)	1924-25	15
17315BX	Retainer (windshield glass) upper (use with thick glass)	1924-25	15
17314ARX	Retainer (windshield glass) lower (use with thin glass)	1924-25	15
17314BRX	Retainer (windshield glass) lower (use with thick glass)	1924-25	15
18267BX	Retainer (door header) assy.	1924-25	30
18268BRX	Retainer (door hinge pillar) assy.	1924-25	30
18265BRX	Retainer (door lock pillar) assy.	1924-25	30
16337BRX	Rib (roof) No. 1	1924-25	1 00
16338BRX	Rib (roof) No. 2	1924-25	1 00
16339BRX	Rib (roof) No. 3	1924-25	1 00
16340RX	Rib (roof) No. 4	1924-25	1 00
17354RX	Riser (floor board) assy.—R. H.	1924-25	50
17355RX	Riser (floor board) assy.—L. H.	1924-25	50
17351X	Rivet (visor bracket to visor)	1924-25	01
16341X	Rocker—R. H.	1924	1 50
16342X	Rocker—L. H.	1924	1 50
5081RX	Rod (window lifter support) and knob assy. R. H.	1924-25	40
5082RX	Rod (window lifter support) and knob assy. L. H.	1924-25	40
9759A1X	Roller (curtain) assy.	1924-25	90
18811X	Runs (window glass)	1924-25	40
18452X	Run (door window glass) assy.—hinge side R.—lock side—L.	1925	50
18453X	Run (door window glass) assy.—hinge side L.—lock side—R.	1925	50
17277RXX	Screw (door lock L. H. dog shaft handle)	1924	01
17225RXX	Screw (window regulator handle)	1924	05
17330A	Screw (windshield swing arm thumb)	1924	15
17283X	Screw (safety lock set)	1924	05
5309X	Screw (safety lock set bushing)	1924	01
17272ARX	Shaft (door lock dog) Ford design	1924	15
17272BRX	Shaft (door lock dog) Ferro design	1924	15
16346RX	Sill (cross) center—rear	1924-25	1 50
†16347RX	Sill (cross) rear	1924-25	
16350ARX	Sill (side) assy.—R. H.	1924	9 00
16350BRX	Sill (side) assy.—R. H.	1924-25	9 00
16351ARX	Sill (side) assy.—L. H.	1924	9 00
16351BX	Sill (side) assy.—L. H.	1924-25	9 00
18220AX	Spring (seat cushion) assy.—R. H.	1924-25	1 50
18221AX	Spring (seat cushion) assy.—L. H.	1924-25	1 50
9938X	Spring (seat back cushion) assy.	1924-25	03
5067BX	Spring (window lifter support rod)	1924	10
5092X	Spring (window lifter counterbalance)	1924	75
16355RX	Strainer (deck side)	1924	
†16356RX	Strainer (deck rear)	1924	
9059CX	Strap (door check) assy.	1924	30
17117X	Strip (back window finish) assy.	1924-25	75
17102X	Strip (door header finish)	1924-25	35
17342X	Strip (door hinge pillar finish) and spring assy.—R. H.	1925	30
17243X	Strip (door hinge pillar finish) and spring assy.—L. H.	1925	30
17106X	Strip (door garnish finish) R. H.	1924-25	30
17105X	Strip (door garnish finish) L. H.	1924-25	30
17244X	Strip (door lock pillar finish) and spring assy.—R. H.	1925	30

† Have made locally.

Part No.	NAME	YEAR	PRICE
----------	------	------	-------

COUPE BODY PARTS—1924-25—Continued

17245X	Strip (door lock pillar finish) and spring assy.—L. H.	1925	\$0 30
10239AX	Strip (door window glass retainer) (for use with thin glass)	1924	10
10239BX	Strip (door window glass retainer) (for use with thick glass)	1924	10
18801X	Strip (door window header weather)	1924-25	15
13850RX	Strip (door window weather) and retainer assy.	1924	20
17382RX	Strip (quarter header finish)	1924-25	20
17390RX	Strip (quarter garnish finish) R. H.	1924-25	15
17391RX	Strip (quarter garnish finish) L. H.	1924-25	15
17389ARX	Strip (quarter pillar finish)	1924-25	20
18862RX	Strip (quarter window weather) and retainer assy.	1924-25	25
9517X	Strip (roof moulding finish)	1924-25	20
17070RX	Support (instrument board) R. H.	1924-25	15
17071RX	Support (instrument board) L. H.	1924-25	15
7655RX	Support (steering column) upper	1924-25	20
7656X	Support (steering column) lower	1924-25	20
18020BX	Upholstering (door) assy.—R. H.	1924	2 75
†18020CRX	Upholstering (door) assy.—R. H.—steel door	1924	3 50
*18020DRX	Upholstering (door) assy.—R. H.—steel door	1925	2 75
18021BX	Upholstering (door) assy.—L. H.	1924	3 50
†18021CRX	Upholstering (door) assy.—L. H.—steel door	1925	3 50
*18021DRX	Upholstering (door) assy.—L. H.—steel door	1925	2 00
18018ARX	Upholstering (quarter) assy.—R. H.	1924	1 25
18018BRX	Upholstering (quarter) assy.—R. H.	1925	1 25
18019ARX	Upholstering (quarter) assy.—L. H.	1924	2 00
18019BRX	Upholstering (quarter) assy.—L. H.	1924-25	1 25
18024RX	Upholstering (seat cushion) assy.—R. H.	1924-25	4 50
18025RX	Upholstering (seat cushion) assy.—L. H.	1924-25	4 50
18028RX	Upholstering (seat back cushion) assy.	1924-25	8 00
18150RX	Visor and bracket assy.	1924-25	2 75
17350X	Washer (visor to roof rail screw finishing)	1924-25	01
17226X	Washer (window regulator handle screw lock)	1924	02
17224X	Washer (window regulator handle anti-rattler)	1924	01
17313BX	Washer (windshield swing arm bracket screw)	1924-25	01
G-52-18853RX	Windshield assy. (complete)	1924-25	16 25
G-51-18851RX	Windshield (upper half)	1924-25	8 25
G-50-18852RX	Windshield (lower half)	1924-25	4 55

COUPE BODY PARTS—1926-27

8320BX	Anti-rattler (door lock lever)	1926-27	05
48103X	Anti-rattler (rear cross member housing)	1926-27	10
45079X	Anti-rattler (tool box bottom)	1926-27	15
57512X	Anti-squeak (back panel to quarter panel)	1926-27	05
50214X	Arm (windshield swing)	1926-27	45
18210X	Beading (roof) front	1926-27	45
18210X	Beading (roof) rear	1926-27	45
45331X	Board (floor) No. 1 and plate assy.	1926-27	50
45332X	Board (floor) No. 2 and plate assy.	1926-27	50
45333X	Board (floor) No. 3 and plate assy.	1926-27	65
45158X	Board (front floor) and pedal shield assy.	1926-27	1 25
57104X	Board (heel) assy.	1926-27	1 50
57323RX	Board (seat back spacer) assy.	1926	3 00
17334X	Bolt (W/S swing arm)	1926-27	03
45068X	Bottom (tool box)	1926-27	75
50058X	Brace (lock pillar) R. H.	1926-27	10
50059X	Brace (lock pillar) L. H.	1926-27	10
50167X	Bracket (center hinge) assy.—R. H.	1926-27	35
50168X	Bracket (center hinge) assy.—L. H.	1926-27	35
45066X	Bracket (body)	1926-27	10
50092X	Bracket (coupe pillar) R. H.	1926-27	10
50093X	Bracket (coupe pillar) L. H.	1926-27	10
57116X	Bracket (deck door support)	1926-27	05
50269X	Bracket (door check strap) assy.	1926-27	15
45124X	Bracket (sill to dash) R. H.	1926-27	10
45125X	Bracket (sill to dash) L. H.	1926-27	10
50216X	Bracket (windshield swing arm pillar) assy.	1926-27	20
57121X	Bumper (deck door)	1926-27	05
50085A1X	Bumper (door) short	1926-27	05
50085A2X	Bumper (door) long	1926-27	05
50395A1X	Bumper (door) short	1926-27	05
50395A2X	Bumper (door) long	1926-27	05
†50527B X	Cardboard (cowl)—R. H.	1926-27	25
†50536B X	Cardboard (cowl)—L. H.	1926-27	25
57338 X	Carpet (floor) front assy.	1926-27	3 50
57501RX	Carpet (heel board) assy.	1926	80

†With fasteners staggered.

*With fasteners in straight line.

†When ordered to replace cowl carpet assy. also order 50527 BX

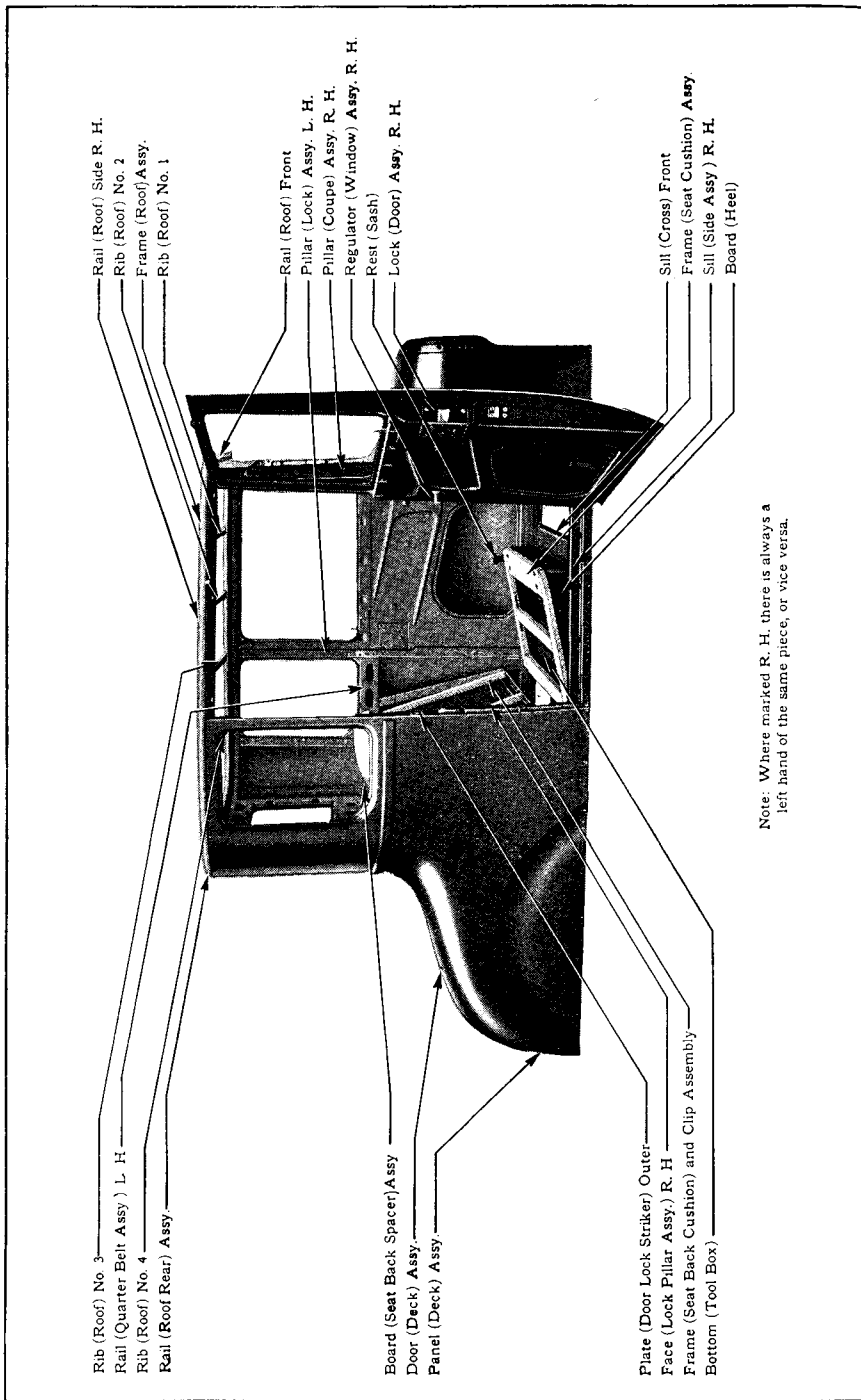

Note: Where marked R. H. there is always a left hand of the same piece, or vice versa.

Part No.	NAME	YEAR	PRICE
COUPE BODY PARTS—1926-27—Continued			
50343 X	Channel (back window glass)	1926-27	\$0 30
50265ARX	Channel (door glass) assy.	1926	40
50265BX	Channel (door window glass) assy.	1926-27	40
57135 X	Channel (quarter window glass)	1926-27	35
50505RX	Cloth (body) (gray-green)	1926	3 75 yd.
50907BX	Cloth (body) (gray-white)	1927	3 75 yd.
50506ARX	Cloth (headlining) (used with gray-green)	1926	2 50 yd.
50908BX	Cloth (headlining) (used with gray-white)	1927	2 50 yd.
57502ARX	Cloth (headlining) assy. (used with gray-green)	1926	4 00
57502BX	Cloth (headlining) assy. (used with gray-white)	1926-27	4 00
57533CX	Cloth (package tray)	1926-27	1 00
50915BX	Cloth (roof rail finish strip)	1926-27	15 yd.
57532 X	Cloth (spacer board rear)	1926-27	45
57533BRX	Cloth (spacer board center)	1926	75
57534 X	Cloth (spacer board) front	1926-27	45
50276 X	Clip (window glass run) upper	1926-27	03
50353 X	Clip (cowl attaching) female	1926-27	05
50351 X	Clip (cowl attaching) male	1926-27	05
8692 X	Clip (seat back attaching)	1926-27	10
57046RX	Connection (cross sill—rear to slide sill) R. H.	1926	10
57047RX	Connection (cross sill—rear to slide sill) L. H.	1926	10
50935 X	Cord (quarter and door covered seaming)	1926-27	03 yd.
50511RX	Cord (quarter and door covered seaming)	1926	03 yd.
50925BX	Cord (headlining seaming)	1926-27	10 yd.
50901BX	Cord (seat cushion seaming)	1926-27	10 yd.
50510X	Cord (curtain)	1926-27	02 yd.
50478 X	Cord (wind) assy.	1926-27	15 yd.
50519 X	Cord (windshield) assy.	1926-27	20 yd.
57624X	Cover (seat back cushion end)	1926-27	05
50215 X	Cup (windshield swing arm washer)	1926-27	02
50516 X	Curtain (window) assy.	1926-27	2 00
57305ARX	Cushion (seat) assy. (gray-green—hard)	1926	*15 60
57305C	Cushion (seat) assy. (gray-white)	1927	*15 00
57329ARX	Cushion (seat back) assy. (gray-green—hard)	1926	15 00
57329B	Cushion (seat back) assy. (gray-white)	1927	15 00
40160 X	Cushion (steering column) upper	1926-27	03
40166 X	Cushion (steering column) lower	1926-27	02
9462 X	Cushion (window)	1926-27	03
50137 X	Door assy.—R. H. (unpainted and untrimmed)	1926-27	*15 00
50138 X	Door assy.—L. H. (unpainted and untrimmed)	1926-27	*15 00
50345RX	Door assy.—R. H. (complete) (gray-green uph.)	1926	*32 50
50346RX	Door assy.—L. H. (complete) (gray-green uph.)	1926	*32 50
50931BX	Door assy.—R. H. (complete) (gray-white uph.)	1927	*32 50
50932PX	Door assy.—L. H. (complete) (gray-white uph.)	1927	*32 50
57319ARX	Door (battery trap) assy.	1926	1 00
57319BRX	Door (battery trap) assy.—37 $\frac{3}{4}$ " long	1926	1 50
57319CX	Door (battery trap) assy.—22 $\frac{1}{4}$ " long	1926-27	1 00
57092 X	Door (deck) assy.	1926-27	*12 50
5053B X	Dovetail (door) male assy.	1926-27	10
T5053CX	Dovetail (door) female assy.	1926-27	10
57030RX	Extension (seat back cushion support) R	1926	15
57036R	Extension (seat back cushion support) L	1926	60
57044RX	Extension (side sill) R. H.	1926	60
57045RX	Extension (side sill) L. H.	1926	60
50309 X	Face (lock pillar) assy. R. H.	1926-27	2 75
50310 X	Face (lock pillar) assy. L. H.	1926-27	2 75
10419 X	Fastener (carpet) assy.—female	1926-27	05
10416X	Fastener (carpet) male	1926-27	05
17498 X	Fastener (door trim)	1926-27	01
17802 X	Fastener (door window glass run) lower	1926-27	02
57327X	Frame (quarter window) assy.—R. H.	1926-27	75
57328X	Frame (quarter window) assy.—L. H.	1926-27	75
50201ARX	Frame (windshield) assy.	1926-27	5 00
50201BX	Frame (windshield) assy.	1926-27	3 00
16200 X	Frame (seat back cushion) and clip assy.	1926-27	3 50
57300 X	Frame (seat cushion) assy.	1926-27	7 50
57105 X	Frame (roof) assy.	1926-27	05
50125X	Filler (block window corner)	1926-27	10
57026X	Filler (body deck trough gusset) R. H.	1926-27	10
57027X	Filler (body deck trough gusset) L. H.	1926-27	10
45231 X	Filler (cross sill)	1926-27	20
50125 X	Filler (lock pillar to quarter belt rail finish strip)	1926-27	03
45233 X	Filler (side sill)	1926-27	10
50456 X	Glass (windshield)	1926-27	4 15
50252B X	Glass (door)	1926-27	3 50
50318B X	Glass (door) and channel assy.—R. H.	1926-27	4 20
50319B X	Glass (door) and channel assy.—L. H.	1926-27	4 20
57120 X	Glass (quarter)	1926-27	1 85
50336X	Glass (back window)	1926-27	2 25

*Not subject to regular discount.

†Specify color of paint.

50650BX Frame (rear window) assy

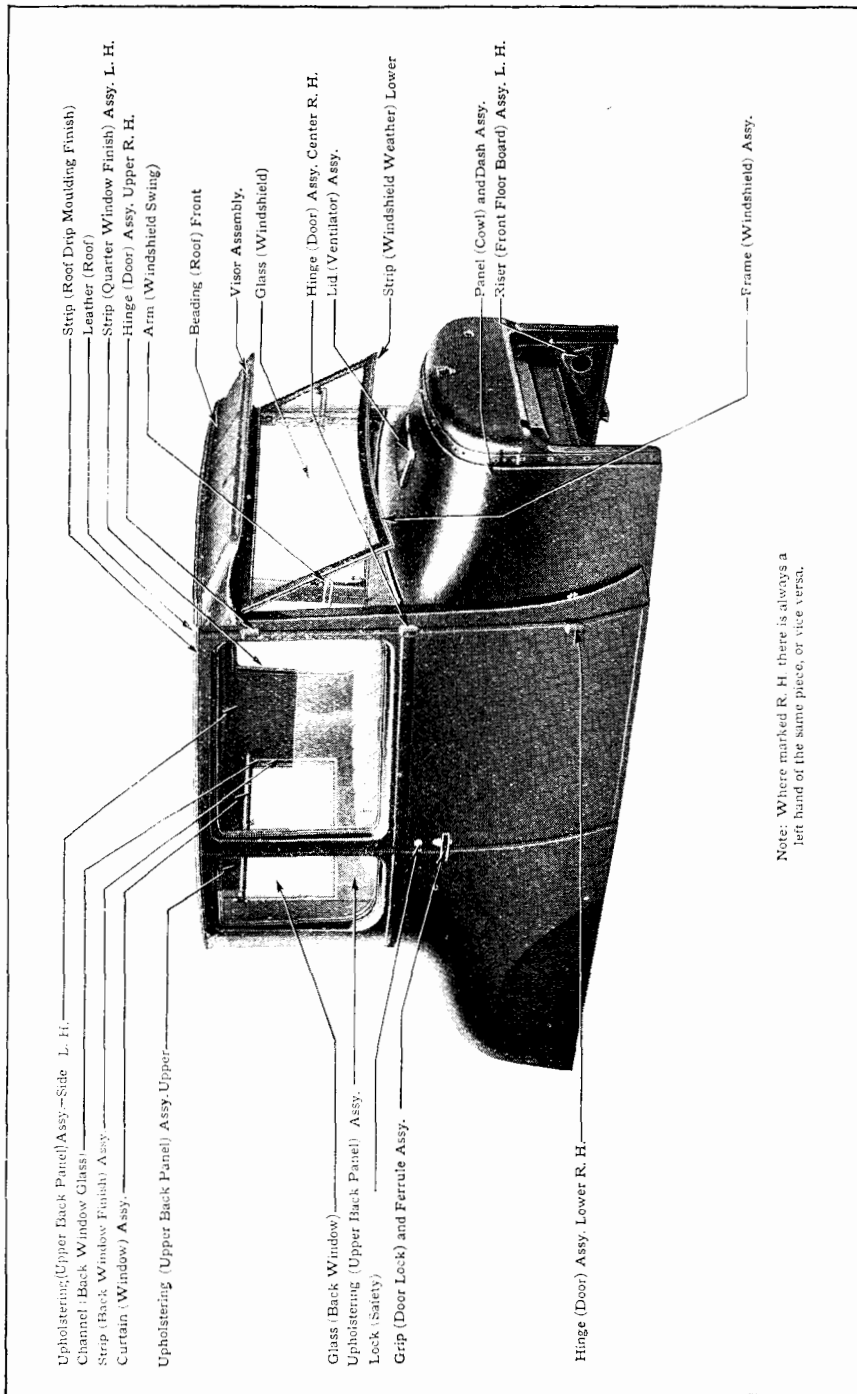

Part No.	NAME	YEAR	PRICE
COUPE BODY PARTS—1926-27—Continued			
17130BRX	Grip (door lock) and ferrule assy.	1926	\$ 60
17130C	Grip (door lock) and ferrule assy.	1926-27	60
50780 X	Grommet (starter switch)	1926-27	05
48134 X	Guide (deck door)	1926-27	05
57051 X	Gusset (body deck hinge) R. H.	1926-27	30
57052 X	Gusset (body deck hinge) L. H.	1926-27	30
57068 X	Gusset (deck door bumper) R. H.	1926-27	10
57069 X	Gusset (deck door bumper) L. H.	1926-27	10
17221B X	Handle (window regulator) assy.	1926-27	40
50071ARX	Header (windshield) assy.	1926	*10 00
50071BX	Header (windshield) assy.	1926-27	2 00
40180 X	Hinge (ventilator lid)	1926-27	10
50150 X	Hinge (door) assy.—upper R. H.	1926-27	35
50151 X	Hinge (door) assy.—upper L. H.	1926-27	35
50152 X	Hinge (door) assy.—center R. H.	1926-27	35
50153 X	Hinge (door) assy.—center L. H.	1926-27	35
50154 X	Hinge (door) assy.—lower R. H.	1926-27	35
50155 X	Hinge (door) assy.—lower L. H.	1926-27	35
57136 X	Hinge (deck) assy. R. H.	1926-27	20
57137 X	Hinge (deck) assy. L. H.	1926-27	20
57075 X	Key (deck lock)	1926-27	10
17282B X	Key (lock) (Baird)	1926-27	8 00 C 25
17282C X	Key (lock) (Yale D. F. series)	1926-27	25
17282D X	Key (lock) (Briggs-Stratton)	1926-27	25
18159 X	Leather (roof)	1926-27	4 50
45335 X	Lid (ventilator) assy.	1926-27	60
9482 X	Lock (deck) assy.	1926-27	25
17750 X	Lock (door) assy.—R. H.	1926-27	85
17751 X	Lock (door) assy.—L. H.	1926-27	85
50432 X	Lock (door) assy.—R. H.	1926-27	1 00
50433 X	Lock (door) assy.—L. H.	1926-27	1 00
17279B X	Lock (safety) and keys	1926-27	1 00
17347 X	Loop (door check strap)	1926-27	03
57038 X	Moulding (deck) R. H.	1926-27	1 25
57039 X	Moulding (deck) L. H.	1926-27	1 25
57123 X	Moulding (drip) R. H.	1926-27	30
57124 X	Moulding (drip) L. H.	1926-27	30
50396 X	Nut (coupe pillar to roof rail)	1926-27	03
17335 X	Nut (windshield swing arm bolt)	1926-27	03
57102ARX	Panel (back) assy.	1926	*17 00
57102B X	Panel (back) assy.	1926-27	*10 00
50315 X	Panel (cowl) and dash assy.	1926-27	17 50
57020ARX	Panel (deck floor) rear	1926	2 00
57020BX	Panel (deck floor) rear	1926-27	2 00
57103ARX	Panel (deck) assy.	1926	6 50
57103BX	Panel (deck) assy.	1926-27	6 50
57021 X	Panel (deck floor) front	1926-27	70
57071 X	Panel (deck hinge cover) assy.	1926	1 00
57012 X	Panel (lower quarter) R. H.	1926-27	10 00
57013 X	Panel (lower quarter) L. H.	1926-27	10 00
50072 X	Panel (instrument)	1926-27	3 50
57010 X	Panel (upper quarter) outside—R. H.	1926-27	3 00
57011 X	Panel (upper quarter) outside—L. H.	1926-27	3 00
50305ARX	Pillar (coupe) assy.—R. H.	1926	6 00
50306ARX	Pillar (coupe) assy.—L. H.	1926	6 00
50305BX	Pillar (coupe) assy.—R. H.	1926-27	5 00
50306BX	Pillar (coupe) assy.—L. H.	1926-27	5 00
50316 X	Pillar (lock) assy.—R. H.	1926-27	2 25
50317 X	Pillar (lock) assy.—L. H.	1926-27	2 25
57144 X	Pin (deck hinge pivot)	1926-27	05
40137X	Pin (ventilator lid hinge)	1926-27	1 00 C 02
50290 X	Plate (door bumper)	1926-27	10
50061 X	Plate (door lock striker) outer	1926-27	10
50060	Plate (door lock striker) inner	1926-27	15
57100BX	Plate (door scuff)	1926-27	15
57100ARX	Plate (door scuff) R. H.	1926	70
57101RX	Plate (door scuff) L. H.	1926	70
45213 X	Plate (floor board No. 1 pedal)	1926-27	10
45218 X	Plate (floor board No. 2 pedal)	1926-27	10
45132 X	Plate (side lever floor board)	1926-27	05
57029 X	Plate (seat back attaching)	1926-27	05
17227B X	Plate (window regulator handle secutcheon)	1926-27	05
57519 X	Rail (quarter belt) assy.—R. H.	1926	1 00
57520 X	Rail (quarter belt) assy.—L. H.	1926	1 00
57320 X	Rail (roof) front	1926-27	1 75
57312 X	Rail (roof) assy.—rear	1926-27	5 00
57309 X	Rail (roof) side—R. H.	1926-27	2 50
57310 X	Rail (roof) side—L. H.	1926-27	2 50
57310 X	Regulator (window) assy.—see page 93	1926	2 50

*Not subject to regular discount.

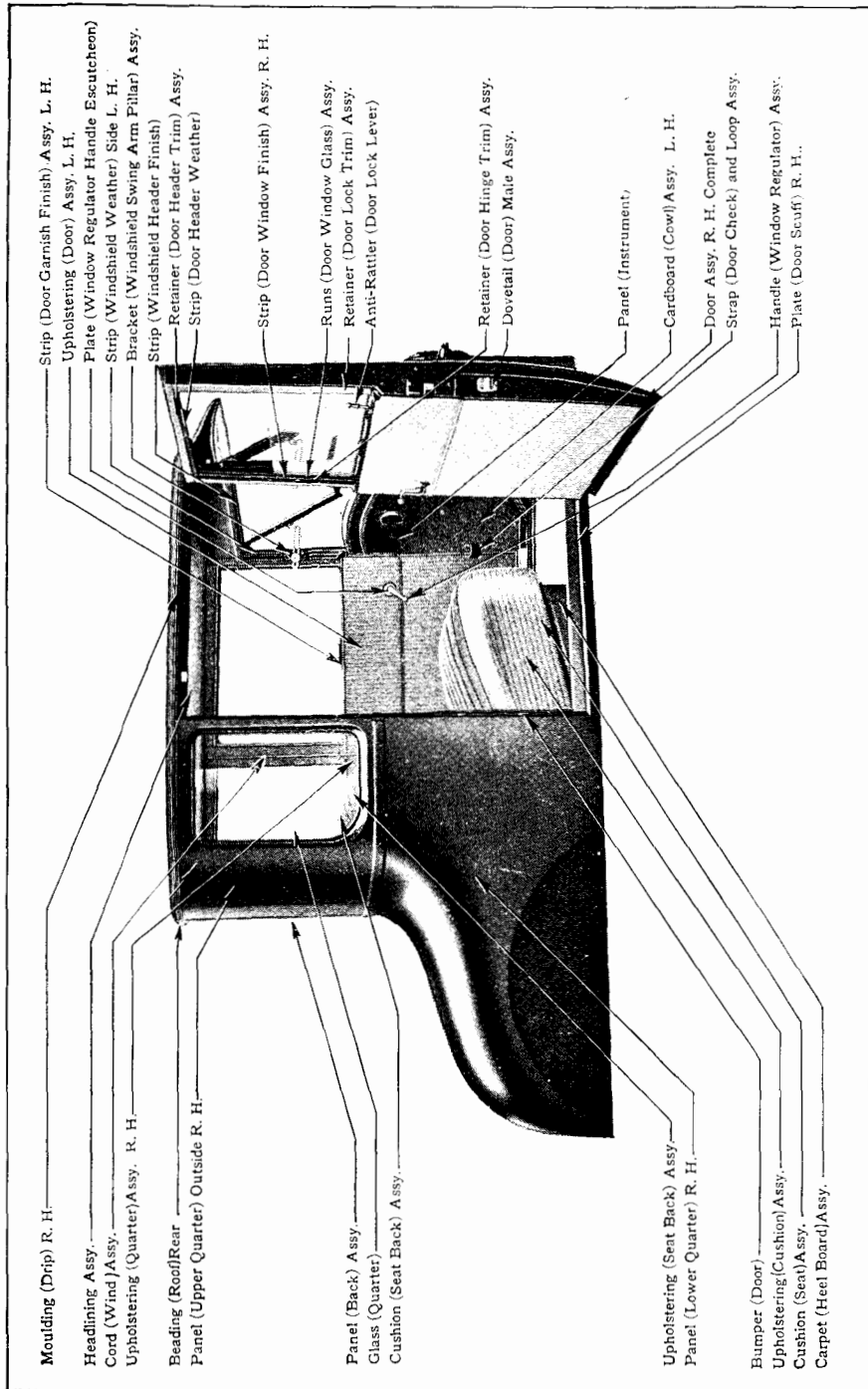

Part No.	NAME	YEAR	PRICE
----------	------	------	-------

COUPE BODY PARTS—1926-27—Continued

50501RX	Retainer (door header trim) assy.—R. H.	1926	\$ 0 35
50578RX	Retainer (door header trim) assy.—L. H.	1926	35
50580X	Retainer (door hinge trim) assy.	1926	35
50579ARX	Retainer (door lock trim) assy.	1926	35
50084X	Retainer (glass run)	1926-27	10
57315X	Rib (roof) No. 1	1926-27	30
57316X	Rib (roof) No. 2	1926-27	30
57317X	Rib (roof) No. 3	1926-27	30
57318X	Rib (roof) No. 4	1926-27	30
50334X	Riser (front floor board) assy.—R. II.	1926-27	79
50335X	Riser (front floor board) assy.—L. II.	1926-27	79
9759A1X	Roller (curtain) assy.	1926-27	90
18822X	Rubber (door dove tail)	1926-27	03
50338X	Run (door window glass) assy.	1926-27	45
45130X	Shield (pedal)	1926-27	15
57025X	Shim (deck lock)	1926-27	03
57040ARX	Sill (side) R. II.	1926	6 00
57040EX	Sill (side) R. II.	1926-27	3 00
57041ARX	Sill (side) L. II.	1926	6 00
57041BX	Sill (side) L. II.	1926-27	3 00
57080X	Sill (cross) front	1926-27	1 10
57043ARX	Sill (cross) rear	1926	1 25
57043BX	Sill (cross) rear	1926-27	75
57110RX	Sill (cross) assy.—center front	1926	1 25
50296X	Spacer (side to cross sill)	1926-27	03
17077X	Spring (door dove tail)	1926-27	05
57330X	Spring (seat cushion) assy.	1926-27	3 25
9938X	Spring (seat back cushion) assy.	1926-27	1 50
40182X	Spring (ventilator lock)	1926-27	20
18382X	Strap (door check) and loop assy.	1926-27	20
50049X	Strip (back window finish) assy.	1926-27	75
50332RX	Strip (coupe pillar finish) assy.—R. H.	1926	60
50333RX	Strip (coupe pillar finish) assy.—L. H.	1926	60
50188BX	Strip (coupe pillar finish) R. II.	1926-27	35
50189BX	Strip (coupe pillar finish) L. II.	1926-27	35
45196X	Strip (cowl ventilator weather) and hook assy.	1926-27	20
57511X	Strip (deck door weather and retainer) assy.	1926-27	80
50259X	Strip (door header weather)	1926-27	15
50462	Strip (door header weather) and retainer assy.	1926-27	30
50424X	Strip (door glass channel weather)	1926-27	15
50135ARX	Strip (door garnish finish) R. H.	1926	45
50135BX	Strip (door garnish finish) R. H.	1926-27	45
50136ARX	Strip (door garnish finish) L. H.	1926	45
50136BX	Strip (door garnish finish) L. H.	1926-27	45
50539RX	Strip (door opening weather) assy.	1926	35
50909BX	Strip (door opening weather) assy.	1927	35
50280X	Strip (door window finish) assy.—R. H.	1926	1 75
50281X	Strip (door window finish) assy.—L. H.	1926	1 75
50517AX	Strip (door window glass retaining) (with thin glass)	1926-27	10
50517BX	Strip (door window glass retaining) (with thick glass)	1926-27	10
57112ARX	Strip (quarter window finish) assy.—R. H.	1926	2 50
57112BX	Strip (quarter window finish) assy.—R. H.	1926-27	1 00
57113ARX	Strip (quarter window finish) assy.—L. H.	1926	2 50
57113BX	Strip (quarter window finish) assy.—L. H.	1926-27	1 00
57122X	Strip (roof drip moulding finish)	1926-27	15
50282AX	Strip (windshield glass retaining) upper (with thin glass)	1926-27	10
50282BX	Strip (windshield glass retaining) upper (with thick glass)	1926-27	10
50283AX	Strip (windshield glass retaining) lower (with thin glass)	1926-27	15
50283BX	Strip (windshield glass retaining) lower (with thick glass)	1926-27	15
50128RX	Strip (windshield header finish)	1926	35
50206X	Strip (windshield weather) side—R. H.	1926-27	10
50207X	Strip (windshield weather) side—L. H.	1926-27	10
50208X	Strip (windshield weather) lower	1926-27	20
57031X	Support (cushion frame)	1926-27	10
57134X	Support (deck door) and bracket assy.	1926-27	10
57125ARX	Support (quarter trim) R. H.	1926	25
57126ARX	Support (quarter trim) L. H.	1926	25
57125BX	Support (quarter trim)	1926-27	15
57089AX	Support (roof rail) and angle assy.—R. H.	1926-27	1 00
57090AX	Support (roof rail) and angle assy.—L. H.	1926-27	1 00
57065ARX	Support (seat back cushion)	1926	45
57065BX	Support (seat back cushion)	1926-27	45
45055A2X	Support (steering column)	1926-27	20
57516ARX	Upholstering (cushion) assy. (gray-green)	1926	6 00
57516BX	Upholstering (cushion) assy. (gray-white)	1927	6 00

Part No.	NAME	YEAR	PRICE
COUPE BODY PARTS—1926-27—Continued			
50479RX	Upholstering (door) assy.—R. H. (gray-green)	1926	\$3 25
50902BX	Upholstering (door) assy.—R. H. (gray-white)	1927	3 25
50480RX	Upholstering (door) assy.—L. H. (gray-green)	1926	3 25
50903BX	Upholstering (door) assy.—L. H. (gray-white)	1927	3 25
57503ARX	Upholstering (quarter) assy.—R. H. (gray-green)	1926	1 75
57503BRX	Upholstering (quarter) assy.—R. H. (gray-green)	1926	1 75
57503CX	Upholstering (quarter) assy.—L. H. (gray-white)	1927	1 75
57504ARX	Upholstering (quarter) assy.—L. H. (gray-green)	1926	1 75
57504BRX	Upholstering (quarter) assy.—L. H. (gray-green)	1926	1 75
57504CX	Upholstering (quarter) assy.—L. H. (gray-white)	1927	1 75
57521ARX	Upholstering (quarter window header) assy.—R. H. (gray-green)	1926	25
57521BX	Upholstering (quarter window header) assy.—R. H. (gray-white)	1927	25
57536ARX	Upholstering (quarter window header) assy.—L. H. (gray-green)	1926	25
57536BX	Upholstering (quarter window header) assy.—L. H. (gray-white)	1927	25
57584ARX	Upholstering (seat back cushion) assy. (gray-green)	1926	4 75
57584BX	Upholstering (seat back cushion) assy. (gray-white)	1927	4 75
57582ARX	Upholstering (upper back panel) assy.—lower (gray-green)	1926	45
57582BX	Upholstering (upper back panel) assy.—lower (gray-white)	1927	45
57537ARX	Upholstering (upper back panel) assy.—side—R. (gray-green)	1926	1 00
57537BX	Upholstering (upper back panel) assy.—side—R. (gray-white)	1927	1 00
57539ARX	Upholstering (upper back panel) assy.—side—L. (gray-green)	1926	1 00
57539BX	Upholstering (upper back panel) assy.—side—L. (gray-white)	1927	1 00
50503BRX	Upholstering (upper back panel) assy.—upper (gray-green)	1926	65
50905BX	Upholstering (upper back panel) assy.—upper (gray-white)	1927	65
50579R	Upholstering (body lock pillar) assy. (gray-green)	1926	35
50938BX	Upholstering (body lock pillar) assy. (gray-white)	1927	35
50502RX	Upholstering (windshield header) assy. (gray-green)	1926	1 00
50904BX	Upholstering (windshield header) assy. (gray-white)	1927	1 00
50537X	Visor assy.	1926-27	3 25
50200ARX	Windshield assy.	1926	11 25
50200BX	Windshield assy.	1926-27	11 25

Part No.	NAME	YEAR	PRICE
SEDAN BODY PARTS—1915-23			
5052ARX	Anti-rattler (door) assy.—female	1922-23	20
5053ARX	Anti-rattler (door) assy.—male	1922-23	15
8320BX	Anti-rattler (door lock lever)	1921-23	05
9455RX	Anti-rattler (window)	1916-21	02
5095ARX	Anti-rattler (window lifter rod)	1922-23	05
5104X	Arm (door window lifter) assy.—R. H.	1922-23	40
5103X	Arm (door window lifter) assy.—L. H.	1922-23	40
5103X	Arm (front quarter window lifter) assy.—R. H.	1922-23	40
5104X	Arm (front quarter window lifter) assy.—L. H.	1922-23	40
9681ARX	Back (driver's seat) with upholstery—malleable	1916-21	10 00
9681BRX	Back (driver's and pass. seat) with uphol. pressed steel	1921	10 00
9681CRX	Back (driver's seat) assy.—with uphol.—malleable	1922-23	10 00
9681DRX	Back (driver's seat) assy.—with uphol.—pressed steel	1922	10 00
9681ERX	Back (driver's seat) assy.—with uphol.—pressed steel	1923	10 00
9668ARX	Back (pass. seat) assy.—less uphol.—malleable	1917-21	3 75
9668BRX	Back (pass. and driver's seat) less uphol.—pressed steel	1921	3 75
9679ARX	Back (pass. seat) assy.—with uphol.—malleable	1917-21	10 00
9679BRX	Back (pass. and driver's seat) with uphol.—less supports—pressed steel	1921	9 50
9679CRX	Back (pass. seat) assy.—with uphol.—less supports—pressed steel	1922-23	9 50
9679DRX	Back (pass. seat) assy.—with uphol.—less supports—malleable	1922	9 50
9679ERX	Back (pass. seat) assy.—with uphol.—less supports—pressed steel	1923	9 50
10029RX	Bar (door bottom) R. H.	1919-23	1 60
10030RX	Bar (door bottom) L. H.	1919-23	1 60
9825RX	Base (driver's seat)	1916-23	2 00
10106RX	Block (cowl reinforcement)	1916-23	20
10107RX	Board (door bottom)	1919-23	1 00
9495ARX	Board (floor) assy.—1st	1916-23	75
9496ARX	Board (floor) assy.—2nd	1916-23	75

Part No.	NAME	YEAR	PRICE
SEDAN BODY PARTS—1915-23—Continued			
8169X	Board (floor) assy.—3rd	1916-23	\$ 1 70
10134ARX	Board (instrument)	1919-22	2 50
10134BRX	Board (instrument)	1922-23	2 00
10135AX	Bottom (pass. seat)—for malleable back	1922	2 00
10135CRX	Bottom (pass. seat)—for pressed steel back	1922-23	2 00
9553RX	Brace (body hinge pillar) R. H.	1922-23	20
9554RX	Brace (body hinge pillar) L. H.	1922-23	20
9500RX	Brace (body lock pillar)	1916-23	25
9498RX	Brace (coupe pillar) R. H.	1916-23	25
9499RX	Brace (coupe pillar) L. H.	1916-23	25
9502RX	Brace (rear pillar) R. H.	1916-23	40
9503RX	Brace (rear pillar) L. H.	1916-23	40
6927ARX	Bumper (door)	1915-21	05
6927BX	Bumper (door)	1922-23	05
9211RX	Bumper (door sill plate)	1915-21	05
10475RX	Carpet (cowl uphol.) assy.—R. H.	1922-23	1 25
10476RX	Carpet (cowl uphol.) assy.—L. H.	1922-23	1 25
10477RX	Carpet (door rocker) assy.	1919-23	75
10447RX	Carpet (driver's seat base) assy.	1916-23	3 00
10277CRX	Carpet (floor) front assy.	1922-23	3 50
10278CRX	Carpet (floor) rear assy.	1922-23	3 50
10411RX	Carpet (pass. seat bottom) assy.	1922-23	1 50
10478RX	Carpet (heel board) assy.	1922-23	1 75
9506ARX	Channel (back window glass)	1915-23	50
†9506BRX	Channel (back window glass)	1915-23	40
5072ARX	Channel (door window glass) R. H.	1922-23	35
5073ARX	Channel (door window glass) L. H.	1922-23	35
9686X	Channel (door window) and felt assy.—R. H.	1916-21	2 75
9690X	Channel (door window) and felt assy.—L. H.	1916-21	2 75
9598RX	Channel (front quarter window) and felt assy.—R. H.	1916-21	2 25
9599RX	Channel (front quarter window) and felt assy.—L. H.	1916-21	2 25
5070ARX	Channel (front quarter window glass) R. H.	1922-23	35
5071ARX	Channel (front quarter window glass) L. H.	1922-23	35
9604X	Channel (rear quarter window) and felt assy.—R. H.	1916-21	2 25
9605X	Channel (rear quarter window) and felt assy.—L. H.	1916-21	2 25
9804RX	Channel (rear quarter window glass) assy.	1922-23	60
10361AX	Cloth (back trimming) specify year	1916-21	3 00
10361BX	Cloth (back trimming)	1922-23	3 00
10361CRX	Cloth (back trimming)	1923	3 00
10366ARX	Cloth (coupe pillar trimming) Specify year	1916-21	15
10312AX	Cloth (door header trimming) Specify year	1916-21	20
10308X	Cloth (door pillar trimming) Specify year	1916-21	10
10380X	Cloth (driver's seat cushion) Specify year	1916-21	2 25
10323AX	Cloth (driver's seat cushion retainer) and pad assy. Specify year	1916-21	1 00
10323BX	Cloth (driver's seat cushion retainer) and pad assy.	1922-23	1 00
10323CRX	Cloth (driver's seat cushion retainer) and pad assy.	1923	1 00
10397BX	Cloth (driver's seat trim block)	1922-23	50
10397CRX	Cloth (driver's seat trim block)	1923	50
10312BX	Cloth (front quarter header trimming)	1922-23	20
10312AX	Cloth (header trimming front) Specify year	1916-21	20
10400AX	Cloth (pass. seat cushion) Specify year	1916-21	2 25
10312AX	Cloth (rear header trimming) Specify year	1916-21	20
10440AX	Cloth (rear seat cushion retainer) Specify year	1916-21	60
10440BX	Cloth (rear seat cushion retainer)	1922-23	60
10440CX	Cloth (rear seat cushion retainer)	1923	60
10270ARX	Cloth (trimming) heavy—gray		4 00 yd
10306ARX	Cloth (trimming) light—gray		1 00 yd
18070X	Cloth (trimming) plain—brown		4 00 yd
10270BX	Cloth (trimming) striped—brown	1922-23	6 00 yd
10423RX	Cloth (window sash)	1916-21	50 yd
8821RX	Connection (pass. seat leg)	1916-23	30
10403BRX	Cord (combination seaming) assy.	1922-23	20 yd
9247X	Cord (curtain)	1916-23	05 yd
10311ARX	Cord (wind) and pasting lace assy.	1916-21	20 yd
10311BX	Cord (wind) assy.	1922	20 yd
10311CRX	Cord (wind) assy.	1923	20 yd
5380RX	Cover (body hinge pillar) R. H.	1922-23	75
5381RX	Cover (body hinge pillar) L. H.	1922-23	75
5386RX	Cover (body lock pillar) R. H.	1922-23	75
5387RX	Cover (body lock pillar) L. H.	1922-23	75
5419RX	Cover (coupe pillar) inside—R. H.	1922-23	50
5420RX	Cover (coupe pillar) inside—L. H.	1922-23	50
5362BRX	Cover (coupe pillar) outside—R. H.	1922-23	1 00
5363BRX	Cover (coupe pillar) outside—L. H.	1922-23	1 00
5060X	Cover (door anti-rattler) female	1922-23	15
5388RX	Cover (door header) R. H.	1922-23	1 25
5389RX	Cover (door header) L. H.	1922-23	1 25
5382RX	Cover (door hinge pillar) R. H.	1922-23	60
5383RX	Cover (door hinge pillar) L. H.	1922-23	60

†Use with thick glass.

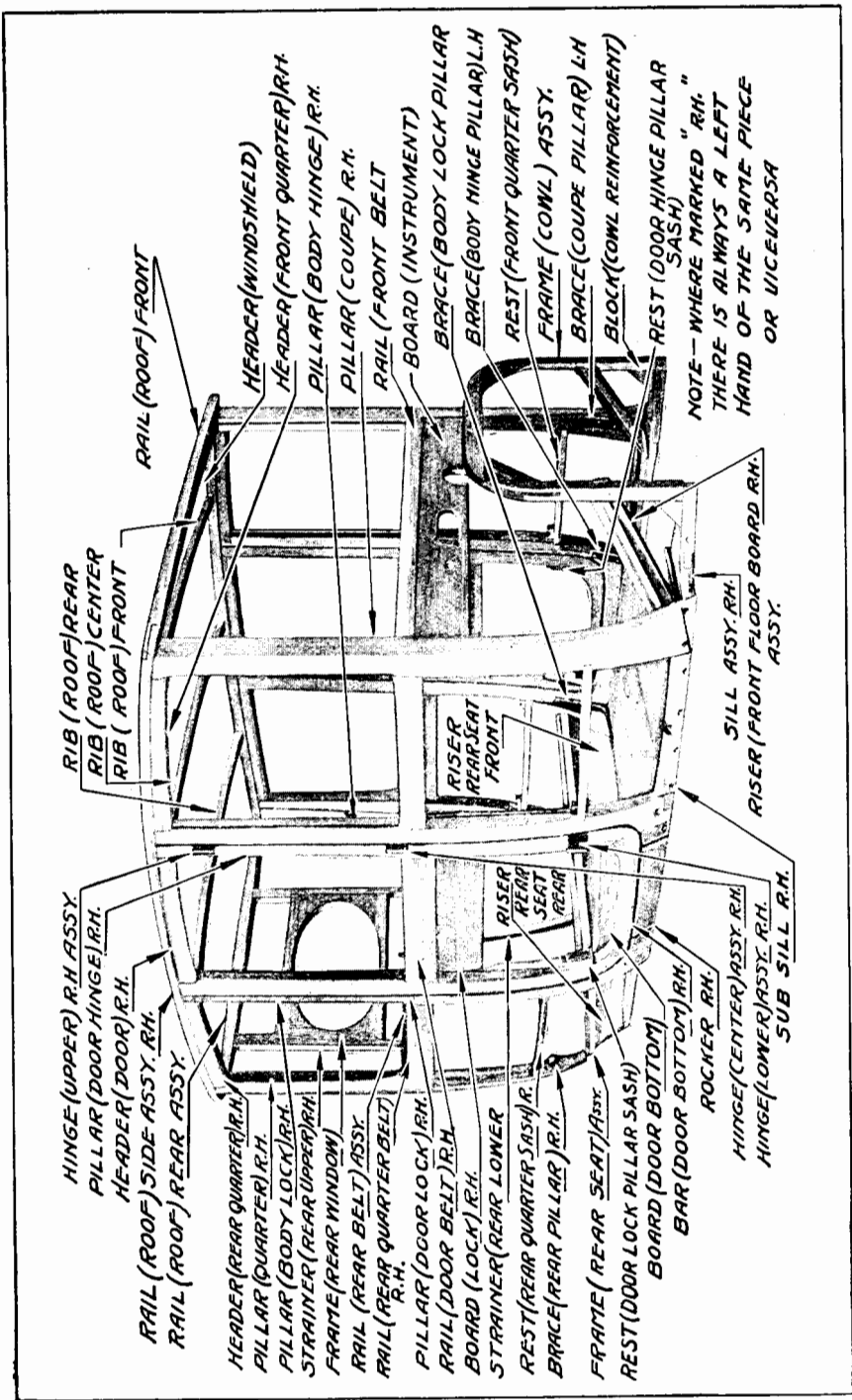

Part No.	NAME	YEAR	PRICE
----------	------	------	-------

SEDAN BODY PARTS 1915-23—Continued

5384RX	Cover (door lock pillar) R. H.	1922-23	\$ 0 75
5385RX	Cover (door lock pillar) L. H.	1922-23	75
5397BRX	Cover (front belt rail)	1922-23	1 00
5406RX	Cover (front quarter belt rail) R. H.	1922-23	80
5407RX	Cover (front quarter belt rail) L. H.	1922-23	80
5410RX	Cover (front quarter header) R. H.	1922-23	1 25
5411RX	Cover (front quarter header) L. H.	1922-23	1 25
5421RX	Cover (rear quarter belt rail) inside—R. H.	1922-23	30
5422RX	Cover (rear quarter belt rail) inside—L. H.	1922-23	30
5408RX	Cover (rear quarter belt rail) outside—R. H.	1922-23	1 25
5409RX	Cover (rear quarter belt rail) outside—L. H.	1922-23	1 25
5412RX	Cover (rear quarter header) R. H.	1922-23	1 25
5413RX	Cover (rear quarter header) L. H.	1922-23	1 25
5414RX	Cover (rear quarter pillar) R. H.	1922-23	1 25
5415RX	Cover (rear quarter pillar) L. H.	1922-23	1 25
5416RX	Cover (roof rail—front)	1922-23	60
5404RX	Cover (windshield header)	1922-23	1 00
9283RX	Cowl	1915-23	15 00
50516X	Curtain (rear window) assy.	1915-23	2 00
5057X	Cushion (door) anti-rattler	1922-23	25
9680ARX	Cushion (driver's seat) assy.	1917-21	8 00
9680BRX	Cushion (driver's seat) assy.	1922-23	8 00
9680CRX	Cushion (driver's seat) assy.	1923	8 00
9621BRX	Cushion (rear seat) assy.	1920-21	*13 00
9621CRX	Cushion (rear seat) assy.	1922-23	*15 00
9621DX	Cushion (rear seat) assy.	1923	*15 00
	Cushion (pass. seat) 1916-21—order 8124BX—Pass. seat cushion spring and 10456BX—pass. seat cushion upholstery assy.		
	Cushion (pass. seat) 1922-23—order 8124BX—Pass. seat cushion spring and 10456CX Pass. seat cushion upholstery assy.		
	Cushion (pass. seat) 1923—order 8124BX—Pass. seat cushion spring and 10456DX Pass. seat cushion upholstery assy.		
10427ARX	Cushion (rear seat back) assy.	1919-21	15 00
10427BRX	Cushion (rear seat back) assy.	1922-23	15 00
10427CX	Cushion (rear seat back) assy.	1923	15 00
2069ARX	Cushion (steering column)	1920-23	05
10074RX	Door (battery trap)	1919-23	75
9560BRX	Door—less window—R. H. (Painted)	1919-21	*45 00
9560CRX	Door—with window—R. H. (Painted)	1922-23	*45 00
9560DX	Door—with window—R. H. (Painted)	1923	*45 00
9561BX	Door—less window—L. H. (Painted)	1919-21	*45 00
9561CX	Door—with window—L. H. (Painted)	1922-23	*45 00
9561DX	Door—with window—L. H. (Painted)	1923	*45 00
5050RX	Felt (rear quarter header)	1922-23	05
9813RX	Felt (window channel)	1915-21	30 yd
9510AX	Fence (door window)	1916-21	35
9510BRX	Fence (door window)	1922-23	20
9511X	Fence (front quarter window)	1916-21	35
5098RX	Fence (rear quarter window)	1922-23	20
9510AX	Fence (rear quarter window)	1916-21	35
9084AX	Fence (windshield)	1915-21	45
10155X	Frame (cowl) assy.	1916-23	4 00
10161RX	Frame (rear seat) assy.	1916-23	4 00
10091X	Frame (rear window)	1916-23	2 50
G83-9257RX	Glass (back window)	1915-23	3 50
G81A-9214ARX	Glass (door window)	1915-21	4 15
G81B-9214BRX	Glass (door window)	1922-23	5 25
G84-9063RX	Glass (door window) and channel assy.—R.	1922-23	5 25
G89-9544RX	Glass (door window) and channel assy.—L.	1922-23	3 25
G49B-9513ARX	Glass (front quarter window)	1916-21	3 45
G69C-9513BRX	Glass (front quarter window)	1922-23	4 50
G73-9643R	Glass (front quarter window) and channel assy.—R.	1922-23	4 50
G74-9644R	Glass (front quarter window) and channel assy.—L.	1922-23	3 55
G82B-9514ARX	Glass (rear quarter window)	1916-21	3 75
G82C-9514BRX	Glass (rear quarter window)	1922-23	75
9058DRX	Grip (door lock) and ferrule assy.—"L"	1922-23	80
9058CRX	Grip (door lock) and ferrule assy.—"T"	1921	60
5378X	Handle (door pull)	1922-23	1 20
10062BX	Header (front quarter) R. H.	1922-23	1 20
10063BX	Header (front quarter) L. H.	1922-23	1 20
10056BX	Header (rear quarter) R. H.	1922-23	1 20
10057BX	Header (rear quarter) L. H.	1922-23	1 20
10025BX	Header (windshield)	1922-23	1 50
9204RX	Hinge (center) assy.	1915-23	50
9206RX	Hinge (lower) assy.	1915-23	50
9202RX	Hinge (upper) assy.	1915-23	50
10403AX	Lace (pasting) and seaming cord assy.—specify year	1915-21	20 yd

*Not subject to regular discount.

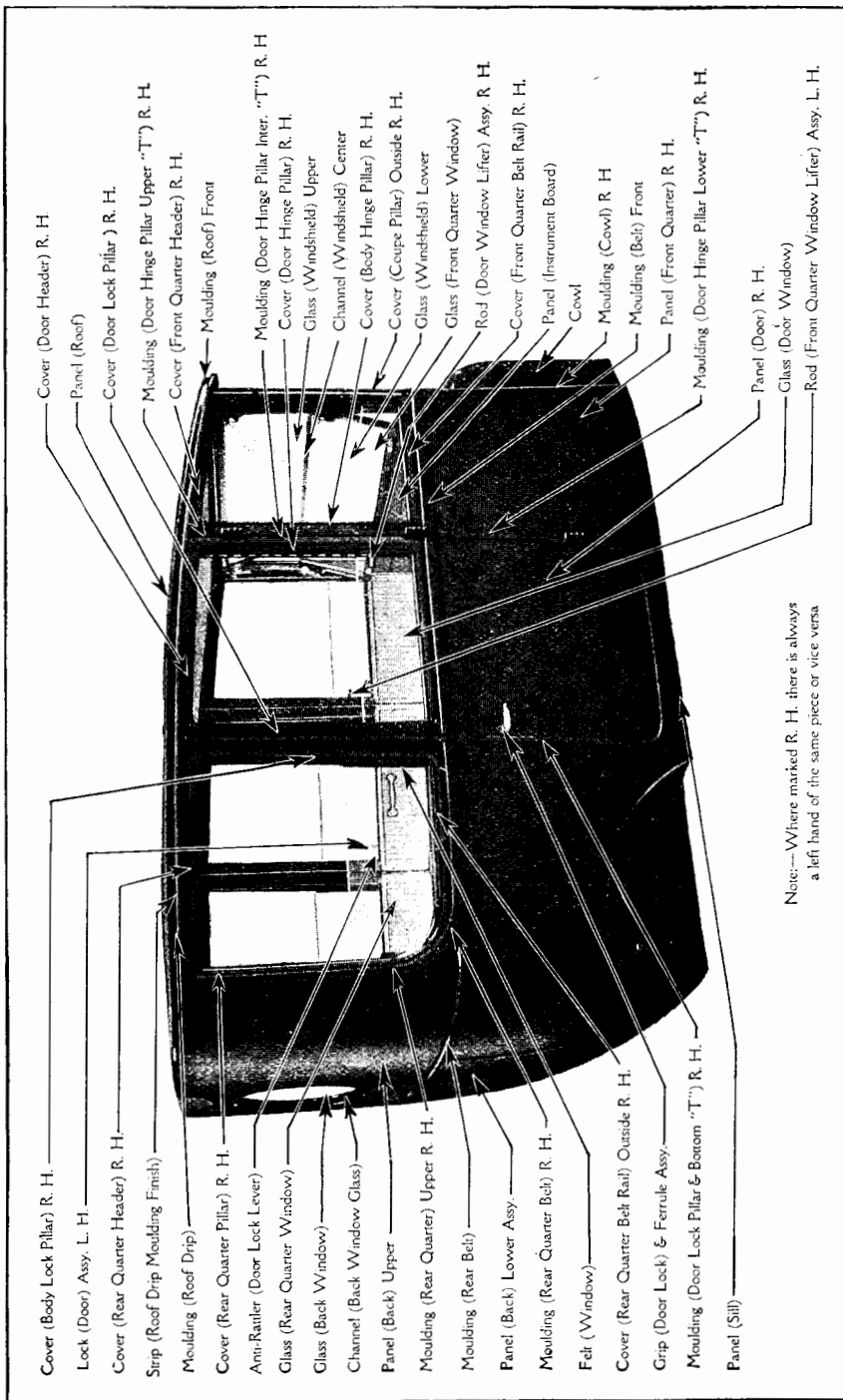

Note:—Where marked R. H. there is always a left hand of the same piece or vice versa

Part No.	NAME	YEAR	PRICE
SEDAN BODY PARTS—1915-23—Continued			
10342BRX	Lace (pasting)	1922-23	\$ 0 10 yd
9664BRX	Leg (pass. seat front) assy.—R. H.	1919-23	90
9665BRX	Leg (pass. seat front) assy.—L. H.	1919-23	90
9780BRX	Leg (pass. seat front) lower	1917-23	50
9781BRX	Leg (pass. seat front) upper—R. H.	1916-23	50
9782BRX	Leg (pass. seat front) upper—L. H.	1916-23	50
9620X	Leg (pass. seat rear) assy.	1917-20	75
9666BRX	Leg (pass. seat rear) lower	1919-23	50
8822ARX	Leg (pass. seat rear) upper	1919-23	25
9608X	Lifter (door window)	1915-20	1 25
9606AX	Lifter (quarter window)	1915-20	75
9606BX	Lifter (rear quarter window)	1922-23	75
9606CX	Lifter (rear quarter window)	1922-23	75
9606AX	Lifter (window)	1920-21	75
9540ARX	Lining (head) assy.	1915-21	4 00
9540BRX	Lining (head) assy.	1922-23	8 50
9540CX	Lining (head) assy.	1923	7 50
9052BX	Lock (door) assy.—R. H.	1919-23	1 50
9051BRX	Lock (door) assy.—L. H.	1919-23	1 50
10281X	Moulding (belt) door	1916-20	1 50
10282RX	Moulding (belt) front	1916-23	5 00
10288RX	Moulding (cowl) R. H.	1916-23	1 00
10289RX	Moulding (cowl) L. H.	1916-23	1 00
10294AX	Moulding (door hinge pillar "T") intermediate—R. H.	1916-21	30
10294BRX	Moulding (door hinge pillar "T") intermediate—R. H.	1922-23	30
10295AX	Moulding (door hinge pillar "T") intermediate—L. H.	1916-21	30
10295BRX	Moulding (door hinge pillar "T") intermediate—L. H.	1922-23	30
10296RX	Moulding (door hinge pillar "T") lower—R. H.	1916-23	25
10297RX	Moulding (door hinge pillar "T") lower—L. H.	1916-23	25
10292RX	Moulding (door hinge pillar "T") upper—R. H.	1916-23	20
10293RX	Moulding (door hinge pillar "T") upper—L. H.	1916-23	20
10298RX	Moulding (door lock pillar and bottom "T") R. H.	1916-23	70
10299RX	Moulding (door lock pillar and bottom "T") L. H.	1916-23	70
10287RX	Moulding (rear quarter belt) R. H.	1916-23	2 50
10283RX	Moulding (rear quarter belt) L. H.	1916-23	2 00
10284RX	Moulding (rear quarter) upper—R. H.	1916-23	1 00
10285RX	Moulding (rear quarter) upper—L. H.	1916-23	1 00
10286RX	Moulding (roof drip) side	1922-23	1 00
9297BRX	Moulding (roof) front	1922-23	1 00
10290RX	Nut (window lifter rod)	1922-23	63
5085AX	Panel (back lower) assy.—includes rear quarter panels—specify year	1916-23	40 00
8516X	Panel (back upper)—specify year	1916-23	24 00
9570RX	Panel (door) R. H.	1922-23	7 00
9567DRX	Panel (door) L. H.	1922-23	7 00
9568DRX	Panel (front quarter) R. H.	1915-23	17 00
9569RX	Panel (front quarter) L. H.	1915-23	17 00
9565RX	Panel (instrument board)	1922-23	2 50
8025BRX	Panel (rear quarter) assy.—R. H.	1915-23	12 50
9876X	Panel (rear quarter) assy.—L. H.	1915-23	12 50
9882X	Panel (roof)	1915-23	15 00
9074X	Panel (sill)	1916-23	50
9818RX	Pillar (body hinge) assy.—R. H.	1922-23	4 50
11020RX	Pillar (body hinge) assy.—L. H.	1922-23	4 50
11021RX	Pillar (body lock) assy.—R. H.	1922-23	7 00
11022RX	Pillar (body lock) assy.—L. H.	1922-23	7 00
11023RX	Pillar (coupe) assy.—R. H.	1922-23	9 00
11018RX	Pillar (coupe) assy.—L. H.	1922-23	9 00
11019RX	Pillar (door hinge) R. H.	1922-23	4 50
10005BRX	Pillar (door hinge) L. H.	1922-23	4 50
10006BRX	Pillar (door lock) R. H.	1922-23	4 50
10007BRX	Pillar (door lock) L. H.	1922-23	4 50
10008BRX	Pillar (quarter) R. H.	1922-23	5 00
10011BRX	Pillar (quarter) L. H.	1922-23	5 00
10012BRX	Plate (door anti-rattler)	1922-23	02
5059X	Plate (door lock striker) — Part 17276	1915-23	15
9060RX	Plate (door sill) R. H.	1915-23	40
9208RX	Plate (door sill) L. H.	1915-23	40
9209RX	Plate (steering column)	1919-23	10
7667RX	Plate (window lifter spring suspension)	1922-23	05
5088X	Rack (door window lifter—R. H.)	1922-23	30
5079RX	Rack (door window lifter—L. H.)	1922-23	30
5080RX	Rack (front quarter window lifter)	1922-23	30
5078RX	Rail (door belt) R. H.	1922-23	1 00
10069BRX	Rail (door belt) L. H.	1922-23	1 00
10078RX	Rail (door hand) assy.	1915-21	2 00
9822X			

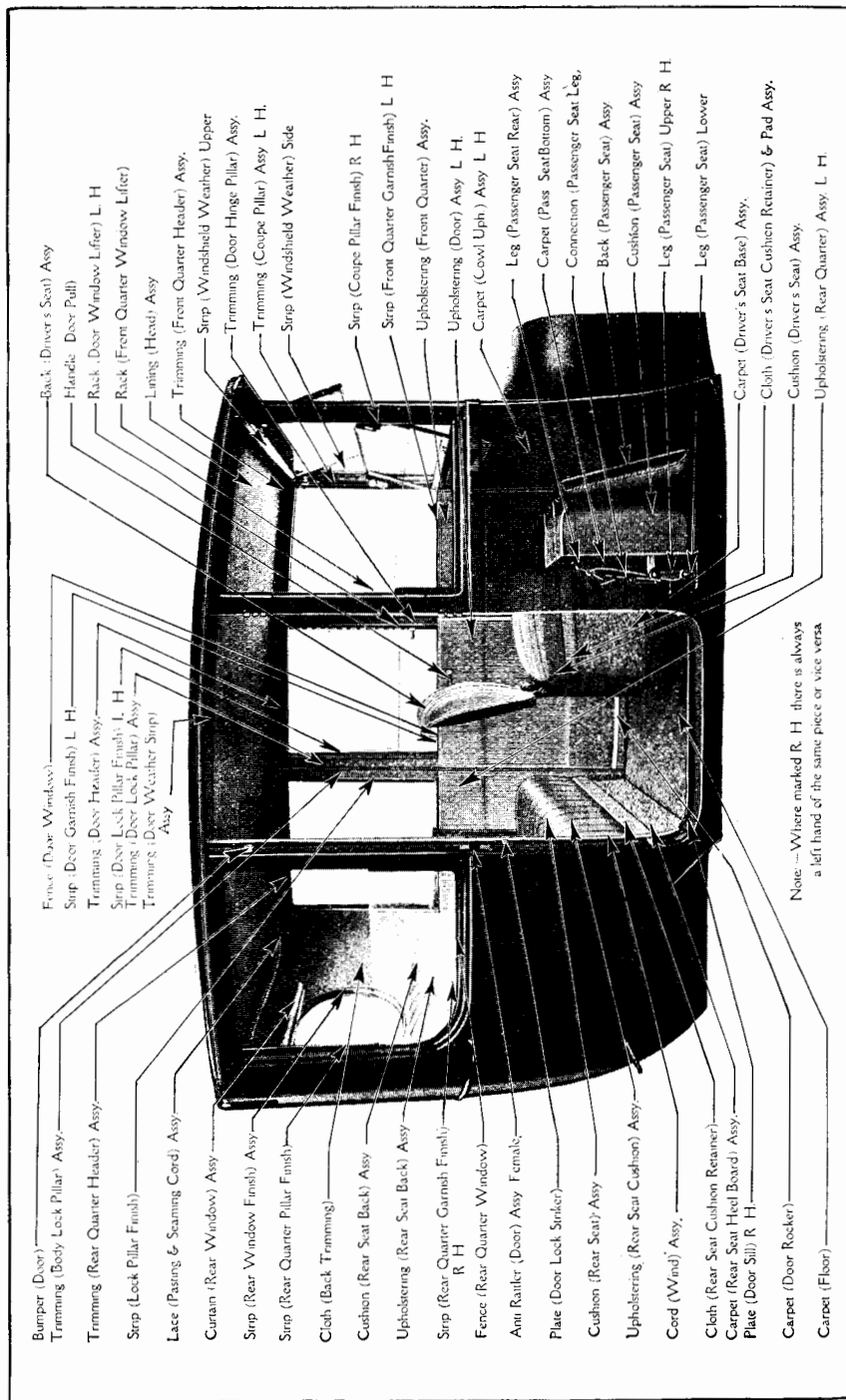

Note—Where marked R. H. there is always a left hand of the same piece or vice versa.

Part No.	NAME	YEAR	PRICE
SEDAN BODY PARTS—1915-23—Continued			
10023BRX	Rail (front belt)	1922-23	\$ 1 20
10143BX	Rail (front belt) and instrument board assy.	1915-21	6 60
10067BRX	Rail (front quarter belt) R. H.	1922-23	1 20
10068BRX	Rail (front quarter belt) L. H.	1922-23	1 20
10042BRX	Rail (rear quarter belt) R. H.	1922-23	1 50
10043BRX	Rail (rear quarter belt) L. H.	1922-23	1 50
10054RX	Rail (rear belt) assy.	1915-23	6 50
10026BRX	Rail (roof) front	1922-23	4 00
10142RX	Rail (roof) rear assy.	1922-23	6 00
10021BRX	Rail (roof side) assy.—R. H.	1922-23	7 00
10022BRX	Rail (roof side) assy.—L. H.	1922-23	7 00
10104RX	Rest (door lock pillar sash)	1922-23	19
5097RX	Retainer (door window weather strip)	1922-23	15
9879RX	Retainer (driver's seat cushion)	1915-23	40
5096RX	Retainer (front quarter window weather strip)	1922-23	18
5399RX	Retainer (instrument panel)	1922-23	20
10085RX	Rib (roof) center	1915-23	40
10083RX	Rib (roof) front	1915-23	40
10087RX	Rib (roof) rear	1915-23	40
10156RX	Riser (front floor board) assy.—R. H.	1915-23	2 00
10157RX	Riser (front floor board) assy.—L. H.	1915-23	2 00
10102RX	Riser (rear seat) front assy.	1922-23	3 00
10031RX	Rocker—R. H.	1918-23	2 50
10032RX	Rocker—L. H.	1918-23	2 50
5081RX	Rod (door window lifter) assy.—R. H.	1922-23	40
5082RX	Rod (door window lifter) assy.—L. H.	1922-23	40
5082RX	Rod (front quarter window lifter) assy.—R. H.	1922-23	40
5081RX	Rod (front quarter window lifter) assy.—L. H.	1922-23	40
9759AIX	Roller (back curtain) assy.	1915-21	90
9627RX	Roof assy.—specify make of body	1915-23	*25 00
1881X	Run (window)	1922-23	40
5061X	Screw (door bumper cover)	1922-23	01
9639ARX	Seat (driver's) assy. less cushion	1916-21	*16 00
9639BRX	Seat (driver's) assy. less cushion	1922-23	*16 00
9639CRX	Seat (driver's) assy. less cushion	1923	*16 00
9629ARX	Seat (pass.) assy.	1915-21	*17 50
9629BRX	Seat (pass.) assy.	1922-23	*17 50
9629CRX	Seat (pass.) assy.	1923	*17 50
10044RX	Sill (front quarter sub) R.	1915-23	50
10045RX	Sill (front quarter sub) L.	1915-23	50
8118X	Spring (driver's seat back)	1922-23	75
8123X	Spring (driver's seat cushion)	1916-23	1 25
8124BX	Spring (pass. seat cushion)	1916-23	1 25
8122BX	Spring (rear seat cushion)	1920-23	4 00
5067BX	Spring (window lifter rod)	1922-23	03
5092X	Spring (window lifter counterbalance)	1922-23	10
9059CX	Strap (door check) assembly	1922-23	30
10334ARX	Strip (back window finish) assy.	1915-21	1 00
10334BRX	Strip (back window finish) assy.	1922-23	1 00
10334CRX	Strip (back window finish) assy.	1923	1 00
10118X	Strip (coupe pillar finish)	1915-21	20
5074RX	Strip (coupe pillar finish)	1922	30
8585CRX	Strip (door garnish finish) R. H.	1920-21	25
8585DRX	Strip (door garnish finish) R. H.	1922-23	40
8585ERX	Strip (door garnish finish) R. H. with pull boss	1923	40
8586CRX	Strip (door garnish finish) L. H.	1920-21	25
8586DRX	Strip (door garnish finish) L. H.	1922-23	40
8586ERX	Strip (door garnish finish) L. H.—with pull boss	1923	40
10236ARX	Strip (door glass retaining) 1/4" thick	1922-23	10
10236BRX	Strip (door glass retaining) 1/4" thick	1922-23	10
10116X	Strip (door header finish)	1915-21	20
10112X	Strip (door hinge pillar finish)	1915-21	25
10112X	Strip (door lock pillar finish)	1915-21	25
5075RX	Strip (door lock pillar finish)	1922-23	30
5084RX	Strip (door window weather)	1922-23	10
10124AX	Strip (front quarter garnish finish) R. H.	1916-20	20
10124BX	Strip (front quarter garnish finish) R. H.	1920-21	20
10124CRX	Strip (front quarter garnish finish) R. H.	1922-23	40
10125AX	Strip (front quarter garnish finish) L. H.	1916-20	20
10125BX	Strip (front quarter garnish finish) L. H.	1920-21	20
10125CRX	Strip (front quarter garnish finish) L. H.	1922-23	40
10235ARX	Strip (front quarter glass retaining) 1/4" thick	1922-23	10
19235BRX	Strip (front quarter glass retaining) 1/4" thick	1915-21	20
10122X	Strip (front quarter window weather)	1922-23	10
5083RX	Strip (hinge pillar finish)	1915-21	25
10112X	Strip (lock pillar finish)	1915-21	25
10112X	Strip (lock pillar finish)	1922-23	30
5075RX	Strip (rear quarter garnish finish)	1916-20	20
10132AX	Strip (rear quarter garnish finish)	1922-23	20
10132BX	Strip (rear quarter garnish finish)	1920-21	20

* Not subject to regular discount.

Part No.	NAME	YEAR	PRICE
SEDAN BODY PARTS—1915-23—Continued			
10132CX	Strip (rear quarter garnish finish) R. H.	1922-23	\$ 0 40
10131RX	Strip (rear quarter garnish finish) L. H.	1922-23	40
10239AX	Strip (rear quarter glass retaining) 1/4" thick	1922-23	10
10239BX	Strip (rear quarter glass retaining) 3/8" thick	1922-23	10
10116X	Strip (rear quarter header finish)	1915-21	20
10112X	Strip (rear quarter pillar finish)	1915-21	25
5076RX	Strip (rear quarter pillar finish)	1922	30
17125X	Strip (roof moulding finish)	1922-23	25
9520AX	Support (driver's and pass. seat back) R. H.	1916-22	50
9521X	Support (driver's and pass. seat back) L. H.	1916-22	50
9520BRX	Support (driver's and pass seat back)—pressed steel design	1921-23	50
10247ARX	Trimming (body hinge pillar) assembly	1922-23	30
10247BRX	Trimming (body hinge pillar) assembly	1923	30
10250ARX	Trimming (body lock pillar) assembly	1922-23	30
10250BRX	Trimming (body lock pillar) assembly	1923	30
10241ARX	Trimming (coupe pillar) assembly—R. H.	1922-23	30
10241BRX	Trimming (coupe pillar) assembly—R. H.	1923	30
10242ARX	Trimming (coupe pillar) assembly—L. H.	1922-23	30
10242BRX	Trimming (coupe pillar) assembly—L. H.	1923	30
10244ARX	Trimming (door header) assembly	1922-23	30
10244BRX	Trimming (door header) assembly	1923	30
10248ARX	Trimming (door hinge pillar) assembly	1922-23	30
10248BRX	Trimming (door hinge pillar) assembly	1923	30
10249ARX	Trimming (door lock pillar) assembly	1922-23	30
10249BRX	Trimming (door lock pillar) assembly	1923	30
10245ARX	Trimming (door weather strip) assembly	1922-23	30
10245BRX	Trimming (door weather strip) assembly	1923	30
10243ARX	Trimming (front quarter header) assy.	1922-23	30
10243BRX	Trimming (front quarter header) assy.	1923	30
10246ARX	Trimming (rear quarter header) assembly	1922-23	30
10246BRX	Trimming (rear quarter header) assembly	1923	30
9684ARX	Upholstering (door) assy.—R. H.—specify year	1917-21	4 50
9684BRX	Upholstering (door) assy.—R. H.	1922-23	4 50
9684CRX	Upholstering (door) assy.—R. H.	1923	4 50
9685ARX	Upholstering (door) assy.—L. H.—specify year	1917-21	4 50
9685BRX	Upholstering (door) assy.—L. H.	1922-23	4 50
9685CRX	Upholstering (door) assy.—L. H.	1923	4 50
10454AX	Upholstering (driver's and pass seat back) assy.—front	1921	2 00
10455AX	Upholstering (driver's and pass. seat back)—rear	1921	2 00
10353AX	Upholstering (driver's seat back) assy.—front—malleable design	1922	3 50
10353BX	Upholstering (driver's seat back) assy.—front—pressed steel design	1922	3 50
10353CRX	Upholstering (driver's seat back) assy.—front—pressed steel design	1923	3 50
10354AX	Upholstering (driver's seat back) assy.—rear—malleable design	1922	1 75
10354BX	Upholstering (driver's seat back) assy.—rear—pressed steel design	1922	1 75
10354CRX	Upholstering (driver's seat back) assy.—rear—pressed steel design	1923	1 75
10453AX	Upholstering (driver's seat cushion) assy.	1917-21	4 00
10453BX	Upholstering (driver's seat cushion) assy.	1922-23	4 50
10453CRX	Upholstering (driver's seat cushion) assy.	1923	4 50
9698ARX	Upholstering (front quarter) R. H.—specify year	1915-21	1 75
9699X	Upholstering (front quarter) L. H.—specify year	1915-21	1 75
9698BRX	Upholstering (front quarter) assy.	1922-23	4 00
9698CX	Upholstering (front quarter) assy.	1923	4 00
10274BX	Upholstering (pass. seat back) assy.—front—malleable design	1922	2 75
10274CX	Upholstering (pass. seat back) assy.—front—pressed steel design	1922	2 75
10274DRX	Upholstering (pass. seat back) assy.—front—pressed steel design	1923	2 75
10458BX	Upholstering (pass. seat back) assy.—rear—malleable design	1922	2 50
10455CX	Upholstering (pass. seat back) assy.—rear—pressed steel design	1922-23	2 50
10455DRX	Upholstering (pass. seat back) assy.—rear—pressed steel design	1923	2 50
10456BRX	Upholstering (pass. seat cushion) assy.	1916-22	4 00
10456CX	Upholstering (pass. seat cushion) assy.	1922-23	4 00
10456DRX	Upholstering (pass. seat cushion) assy.	1923	4 00
10349ARX	Upholstering (rear quarter) assy.—R. H.—specify year	1915-21	3 00
10349BRX	Upholstering (rear quarter) assy.—R. H.	1922-23	3 00
10349CRX	Upholstering (rear quarter) assy.—R. H.	1923	3 00
10350ARX	Upholstering (rear quarter) assy.—L. H.—specify year	1915-21	3 00
10350BRX	Upholstering (rear quarter) assy.—L. H.	1922-23	3 00

Part No.	NAME	YEAR	PRICE
SEDAN BODY PARTS—1915-23—Continued			
10350CRX	Upholstering (rear quarter) assy.—L. H.	1923	\$ 3 00
10451AX	Upholstering (rear seat back) assy.	1920-21	7 50
10451BX	Upholstering (rear seat back) assy.	1922-23	7 50
10451CRX	Upholstering (rear seat back) assy.	1923	7 50
10450ARX	Upholstering (rear seat cushion) assy.—specify year	1915-21	9 00
10450BX	Upholstering (rear seat cushion) assy.	1922-23	9 00
10450CRX	Upholstering (rear seat cushion) assy.	1923	9 00
5068BX	Washer (window lifter rod)	1922-23	01
†9661AX	Window (door) R. H.	1915-20	8 00
†9661BRX	Window (door) R. H.	1921	6 75
†9662AX	Window (door) L. H.	1915-20	8 00
†9662BRX	Window (door) L. H.	1921	6 75
†9596ARX	Window (front quarter) R. H.	1915-21	6 00
†9597ARX	Window (front quarter) L. H.	1915-21	6 00
†9602ARX	Window (rear quarter) R. H.	1915-21	6 75
†9603ARX	Window (rear quarter) L. H.	1915-21	6 75

TUDOR SEDAN BODY PARTS—1924-25

8320BX	Anti-rattler (door lock lever)	1924-25	05
17316ARX	Arm (windshield swing)	1924-25	50
17587RX	Arm (window regulator counterbalance) assy.—R.	1924	60
17588RX	Arm (window regulator counterbalance) assy.—L.	1924	60
†8210X	Beading (roof)	1924-	45
9495BX	Board (floor) No. 1 and plate assy.	1924-25	75
9496BX	Board (floor) No. 2 and plate assy.	1924-25	75
8169X	Board (floor) No. 3 and plate assy.	1924-25	1 70
16506RX	Board (floor) No. 4 (large)	1924-25	75
16021BX	Board (floor) No. 5	1924	60
16021CX	Board (floor) No. 5	1924-25	60
16023RX	Board (instrument)	1924	3 00
†16534X	Board (quarter garnish) R. H.	1924	
†16535X	Board (quarter garnish) L. H.	1924	
17570RX	Board (rear heel) assy.	1924-25	1 00
17526X	Brace (body lock pillar) R. H.	1924-25	30
17527X	Brace (body lock pillar) L. H.	1924-25	30
17050RX	Brace (coupe pillar) R. H.	1924-25	45
17051RX	Brace (coupe pillar) L. H.	1924-25	45
17072BRX	Brace (cowl) R. H.	1924-25	20
17073BRX	Brace (cowl) L. H.	1924-25	20
17524RX	Brace (quarter pillar) R. H.	1924-25	60
17525RX	Brace (quarter pillar) L. H.	1924-25	60
17068X	Brace (roof rib No. 4) R. H.	1924	10
17069X	Brace (roof No. 4) L. H.	1924	10
17528RX	Bracket (body) rear	1924-25	15
17517RX	Bracket (passenger's seat leg)	1924-25	60
17042RX	Bracket (ventilator hinge) on cowl	1924-25	20
17043X	Bracket (ventilator hinge) on shield	1924-25	10
17086RX	Bracket (visor)	1924-25	20
6927B1X	Bumper (door) short	1924-25	05
18124BRX	Carpet (cowl) assy.—R. H.	1924-25	1 00
18125BRX	Carpet (cowl) assy.—L. H.	1924-25	1 00
18562BRX	Carpet (driver's seat base) assy.	1924-25	2 75
18120BRX	Carpet (floor) front assy.	1924	3 75
18621RX	Carpet (floor) front assy.	1924-25	4 50
18513RX	Carpet (floor) rear assy.	1924-25	3 75
18573RX	Carpet (passenger seat bottom) assy.	1924-25	1 25
18515RX	Carpet (rear heel board) assy.	1924-25	1 00
18146X	Cardboard (body lock pillar breakover) assy.	1924-25	20
18148RX	Cardboard (coupe pillar breakover) assy.—R. H.	1924-25	20
18149RX	Cardboard (coupe pillar breakover) assy.—L. H.	1924-25	20
18142RX	Cardboard (door hinge pillar breakover) assy.	1924	20
18143X	Cardboard (door lock pillar breakover) assy.	1924	20
18516RX	Cardboard (door weather strip) assy.	1924-25	20
18517RX	Cardboard (door header breakover) assy.	1924	20
9101BX	Casing (door bumper)	1924-25	05
18804BX	Channel (back window glass)	1924-25	20
17537ARX	Channel (door window glass) assy.—R. H.	1924	40
17537BRX	Channel (door window glass) assy.—R. H.	1925	40
17538ARX	Channel (quarter window glass) assy.—R. H.	1924	45
17538BRX	Channel (quarter window glass) assy.—R. H.	1925	45
17544ARX	Channel (quarter window glass) assy.—L. H.	1924	45
17544BRX	Channel (quarter window glass) assy.—L. H.	1925	45
18800RX	Channel (windshield center)	1924-25	60
17331RX	Clip (windshield glass) lower	1924-25	05
17322ARX	Clip (windshield glass) upper—R. H.	1924-25	05
17322BRX	Clip (windshield glass) upper—R. H.	1925	05
17323ARX	Clip (windshield glass) upper—L. H.	1924-25	05
17323BRX	Clip (windshield glass) upper—L. H.	1925	05

†Have made locally. †Window lifter not included.

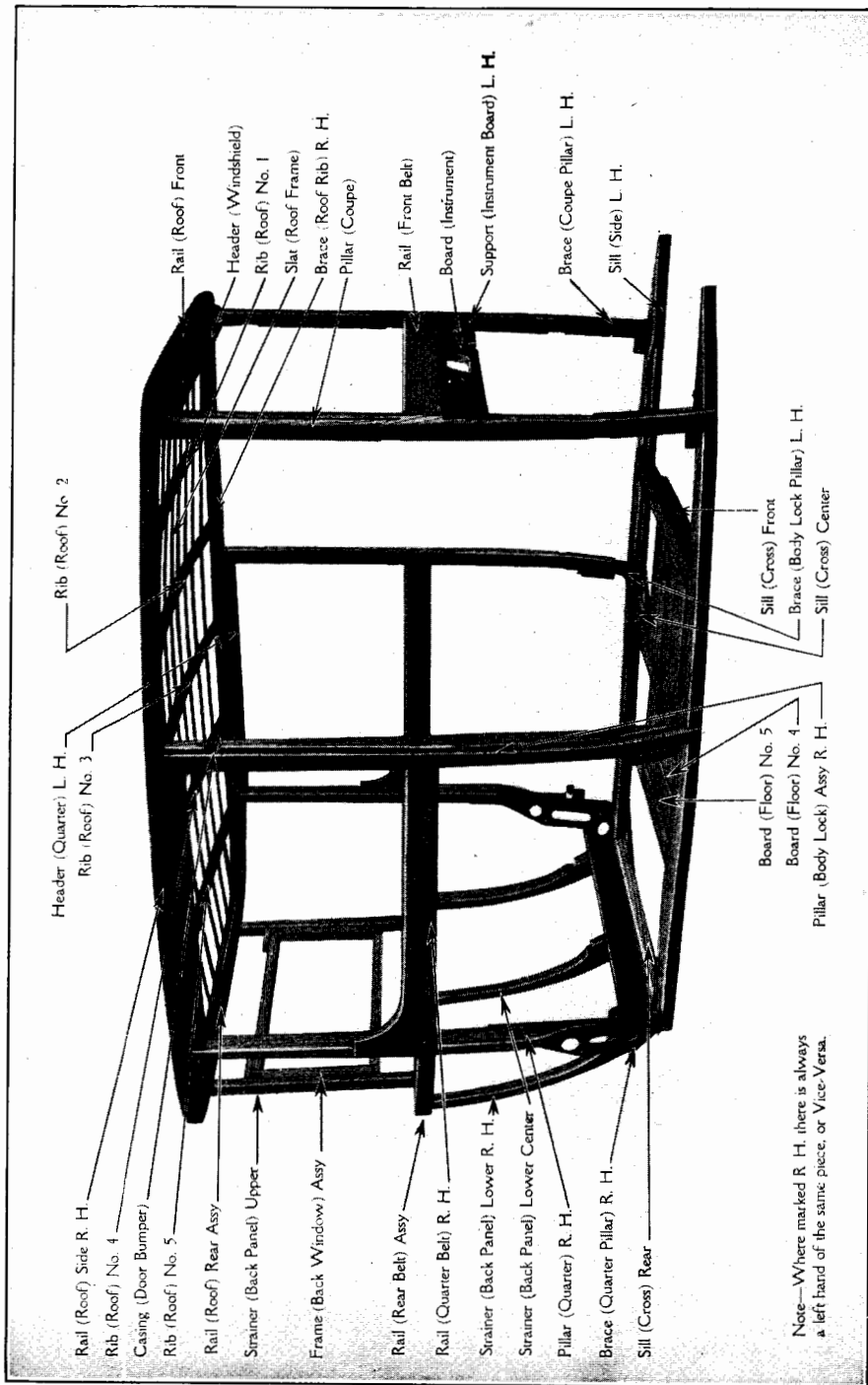

Part No.	NAME	YEAR	PRICE
TUDOR SEDAN BODY PARTS—1924-25—Continued			
17325RX	Clip (windshield finger)	1924	\$ 15
18182RX	Cord (covered seaming)	1924-25	05 yd.
18213RX	Cord (seaming) assy.	1925-25	10 yd.
17048X	Cover (ventilator) assy.	1924-25	75
50516X	Curtain (back window) assy.	1924-25	2 00
18560RX	Cushion (driver's seat) assy.	1924-25	9 00
18190RX	Cushion (rear seat) assy.	1914-25	15 00
18191RX	Cushion (rear seat back) assy.	1924-25	15 00
2069BX	Cushion (steering column)	1924-25	03
9462X	Cushion (window)	1924-25	03
17559A2RX	Door assy. (R. H. less trimming)	1924-25	*15 00
17560A2RX	Door assy. (L. H. less trimming)	1924-25	*15 00
18538A2RX	Door assy. (R. H. complete)	1924-25	*35 00
18539A2RX	Door assy. (L. H. complete)	1924-25	*35 00
16112ARX	Door (battery trap) assy.	1924	1 50
16112BRX	Door (battery trap) assy.	1924	1 50
16112CX	Door (battery trap) assy.	1924-25	1 00
5052BX	Dovetail (female assy.)	1924-25	20
5053BX	Dovetail (male assy.)	1924-25	10
17076X	Dowel (rear seat cushion)	1924-25	05
16019X	Frame (back window) assy.	1924-25	4 00
17513RX	Frame (pass. seat back) assy.	1924-25	1 25
16553RX	Frame (roof) assy.	1924-25	15 00
17300RX	Frame (upper windshield top hinge and channel assy.)	1924-25	5 00
17336RX	Frame (windshield upper side) and swing arm assy.—R. H.	1924-25	2 00
17337RX	Frame (windshield upper side) and swing arm assy.—L. H.	1924-25	2 00
G-124-18830X	Glass (back window)	1924-25	2 25
G-122-18502RX	Glass (door window)	1924-25	3 85
G-129-18605RX	Glass (door window) and channel assy.—L. H.	1924-25	5 00
G-128-18540RX	Glass (door window) and channel assy.—R. H.	1924-25	5 00
G-123-18501RX	Glass (quarter window)	1924-25	4 70
G-130-18541RX	Glass (quarter window) and channel assy.—R. H.	1924-25	6 00
G-131-18601RX	Glass (quarter window) and channel assy.—L. H.	1924-25	6 00
G-120-18834RX	Glass (windshield) lower	1924-25	2 00
G-121-18835RX	Glass (windshield) upper	1924-25	2 45
17150ARX	Grip (door lock) and ferrule assy. (Ferro design)	1924	1 25
17130BRX	Grip (door lock) and ferrule assy.	1924-25	60
17273X	Handle (door lock—L. H. dog shaft)	1924	15
17221BX	Handle (window regulator) assy.	1924-25	40
17044X	Handle (ventilator)	1924-25	10
16521RX	Header (quarter) R. H.	1924-25	
16522RX	Header (quarter) L. H.	1924-25	
16090RX	Header (windshield)	1924-25	1 00
17172ARX	Hinge (door) assy.—upper—R. H.	1924-25	40
17175ARX	Hinge (door) center assy.—R. H.	1924-25	40
17178ARX	Hinge (door) lower assy.—R. H.	1924-25	40
17180ARX	Hinge (door) upper assy.—L. H.	1924-25	40
17186ARX	Hinge (door) assy. lower—L. H.	1924-25	40
17183ARX	Hinge (door) assy. center—L. H.	1924-25	40
17549RX	Housing (rear cross member) assy.	1924-25	1 25
17282X	Key (safety lock) (Specify serial letters and number)	1924-25	25
17261BX	Knob (door lock lever)	1924-25	15
10342BRX	Lace (brown pasting)	1924-25	10 yd.
18214RX	Lace (wind) assy.	1924-25	20 yd.
18558X	Leather (roof)	1924-25	6 50
17515RX	Leg (pass. seat)	1924-25	1 75
18542RX	Lining (head) assy.	1924-25	8 00
17252ARX	Lock (door) assy.—R. H.	1924	1 50
17750X	Lock (door) assy.—R. H.	1925	85
17250ARX	Lock (door) assy.—L. H.	1924	1 50
17751X	Lock (door) assy.—L. H.	1925	85
17279X	Lock (safety) keys and escutcheon plate	1924-25	1 00
17164X	Moulding (back panel) upper—R. H.	1924-25	30
17165X	Moulding (back panel) upper—L. H.	1924-25	30
17166RX	Moulding (back panel) lower	1924-25	40
17162RX	Moulding (front belt)	1924	1 50
17510RX	Moulding (quarter belt) R. H.	1924-25	1 25
17511RX	Moulding (quarter belt) L. H.	1924-25	1 25
17531RX	Moulding (rear belt)	1924-25	1 00
17532RX	Moulding (roof drip)	1924-25	45
17017RX	Panel (front belt rail)	1924	40
17016RX	Panel (instrument)	1924-25	1 25
17506RX	Panel (quarter) upper—R. H.	1924-25	4 00
17507RX	Panel (quarter) upper—L. H.	1924-25	4 00
17579RX	Panel (quarter) lower assy.—R. H.	1924-25	6 00
17580RX	Panel (quarter) lower assy.—L. H.	1924-25	6 00

*Not subject to regular discount
† Have made locally.

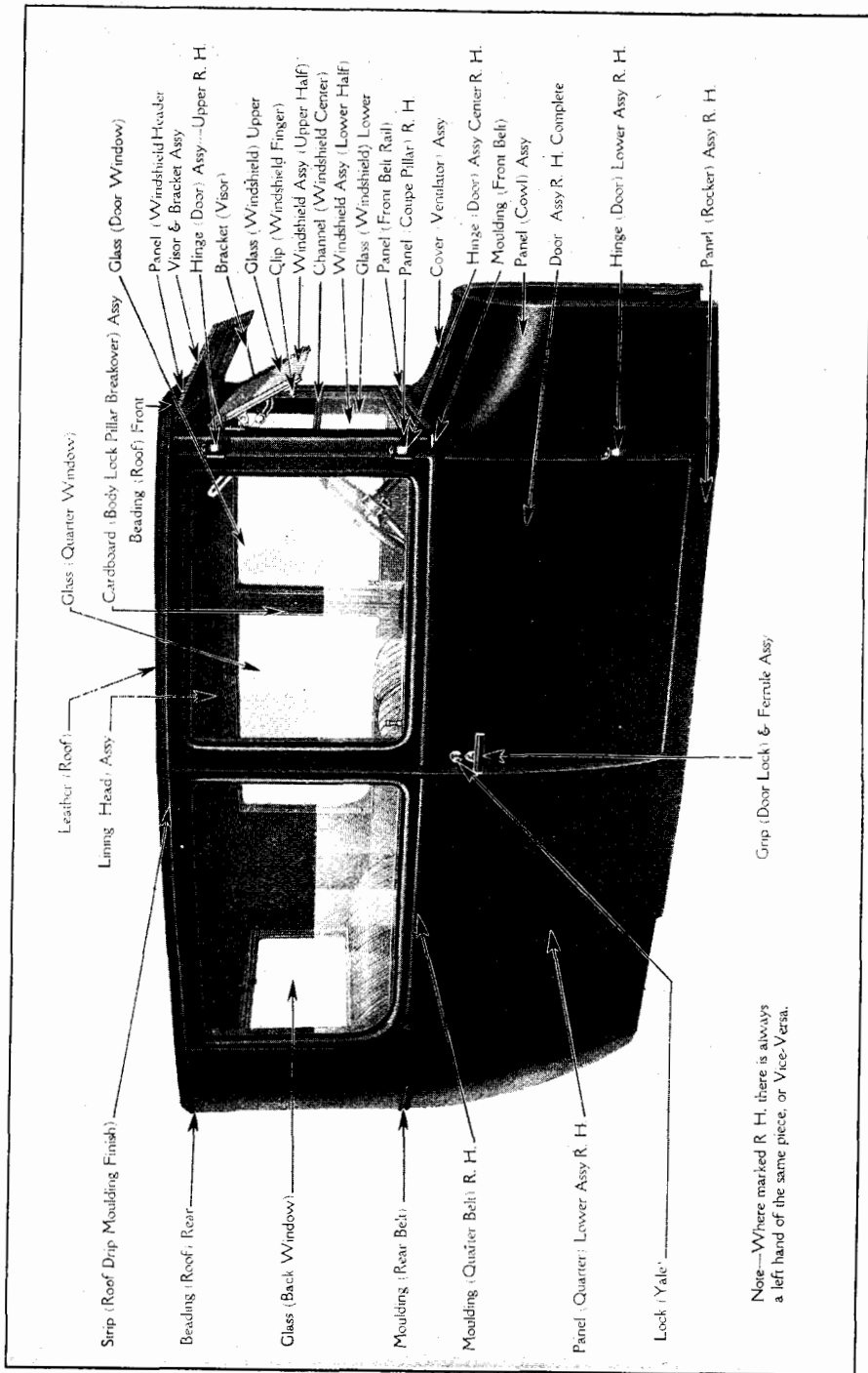

Part No.	NAME	YEAR	PRICE
TUDOR SEDAN BODY PARTS—1924-25—Continued			
17505RX	Panel (back) upper	1924-25	\$ 7 50
17024RX	Panel (back) lower	1925	5 00
17027BRX	Panel (coupe pillar) R. H.	1924-25	45
17028BRX	Panel (coupe pillar) L. H.	1924-25	45
17019BX	Panel (cowl) assy.	1924	12 00
17019CX	Panel (cowl) assy.	1925	12 00
17018RX	Panel (front roof rail)	1924-25	50
17568RX	Panel (rocker) assy.—R. H.	1924-25	90
17569RX	Panel (rocker) assy.—L. H.	1924-25	90
17022RX	Panel (windshield header)	1924	50
16526R	Pillar (body lock) assy.—R. H.	1924-25	3 00
16527R	Pillar (body lock) assy.—L. H.	1924-25	3 00
16050RX	Pillar (coupe) R. H.	1924-25	4 50
16051RX	Pillar (coupe) L. H.	1924-25	4 50
16528RX	Pillar (quarter) R. H.	1924-25	1 50
16529RX	Pillar (quarter) L. H.	1924-25	1 50
17518RX	Pin (passenger seat leg)	1924-25	05
17047X	Pin (ventilator hinge clevis)	1924-25	02
17550RX	Plate (door scuff) R. H.	1924-25	50
17551RX	Plate (door scuff) L. H.	1924-25	50
17276RX	Plate (door lock striker)	1924	10
17490X	Plate (door lock striker)	1925	10
17274X	Plate (door lock L. H.—dog shaft escutcheon)	1924	02
8170X	Plate (side lever floor board)	1924	10
17227ARX	Plate (window regulator escutcheon)	1924	05
17227BX	Plate (window regulator escutcheon)	1925	05
17281X	Plate (safety lock escutcheon)	1924	10
17045BRX	Quadrant (ventilator handle)	1924-25	15
16070RX	Rail (front belt)	1924-25	1 00
16523RX	Rail (quarter belt) R. H.	1924-25	1 50
16524RX	Rail (quarter belt) L. H.	1924-25	1 50
16548RX	Rail (rear belt) assy.	1924-25	4 00
16545RX	Rail (roof) side—R. H.	1924-25	4 00
16546RX	Rail (roof) side—L. H.	1924-25	4 00
16083X	Rail (roof) rear assy.	1924-25	5 50
16087ARX	Rail (roof) front	1924	1 75
16087BRX	Rail (roof) front	1924-25	1 00
5105X	Regulator (window) assy.—(see page 93)	1924-25	
16540RX	Retainer (window run)	1924-25	10
16541RX	Rib (roof) No. 1	1924-25	40
16542RX	Rib (roof) No. 2	1924-25	40
16543RX	Rib (roof) No. 3	1924-25	40
16544RX	Rib (roof) No. 4	1924-25	40
16545RX	Rib (roof) No. 5	1924-25	40
17354RX	Riser (floor board) assy.—R. H.	1924-25	50
17355RX	Riser (floor board) assy.—L. H.	1924-25	50
9759A1X	Roller (window curtain) assy.	1924-25	90
18811X	Runs (window glass)	1924-25	40
17283RX	Screw (safety lock bushing)	1924	05
5309X	Screw (safety lock bushing)	1925	01
18563RX	Seat (driver's) assy.	1924-25	16 00
17565RX	Seat (driver's) assy.—less trimming	1924-25	5 00
18564RX	Seat (pass.) assy.	1924-25	*17 50
16502RX	Sill (cross) front	1924-25	90
16503RX	Sill (cross) center	1924-25	85
16504RX	Sill (cross) rear	1924-25	1 25
16500RX	Sill (side) R. H.	1924-25	4 50
16501RX	Sill (side) L. H.	1924-25	4 50
16538RX	Slat (roof frame)	1924-25	20
18565RX	Spring (driver's seat cushion)	1924-25	1 50
18614RX	Spring (driver's seat back)	1924-25	75
18566RX	Spring (pass. seat cushion)	1924-25	1 50
18223X	Spring (rear seat cushion)	1924-25	8 00
9938X	Spring (rear seat back)	1924-25	1 50
17046X	Spring (ventilator)	1924-25	10
16045X	Strainer (back panel) upper—(Have made locally.)	1924-25	75
16046RX	Strainer (back panel) lower—R. H.	1924-25	75
16047RX	Strainer (back panel) lower—L. H.	1924-25	75
16048RX	Strainer (back panel) lower, center	1924-25	1 00
16209X	Strainer (rear seat back cushion frame)	1924-25	20
9059CX	Strap (door check) assy.	1924-25	30
17117X	Strip (back window finish) assy.	1924-25	75
17534RX	Strip (door garnish finish) R. H.	1924-25	45
17535RX	Strip (door garnish finish) L. H.	1924-25	45
17521RX	Strip (door header finish)	1924-25	85
18507AX	Strip (door window glass retaining) thick	1924-25	10
18507BX	Strip (door window glass retaining) thin	1924-25	10
18505X	Strip (door window header weather)	1924-25	20
18504RX	Strip (door window weather)	1924	10
17520RX	Strip (quarter header finish)	1924-25	35

†Does not include cushion.

*Not subject to regular discount.

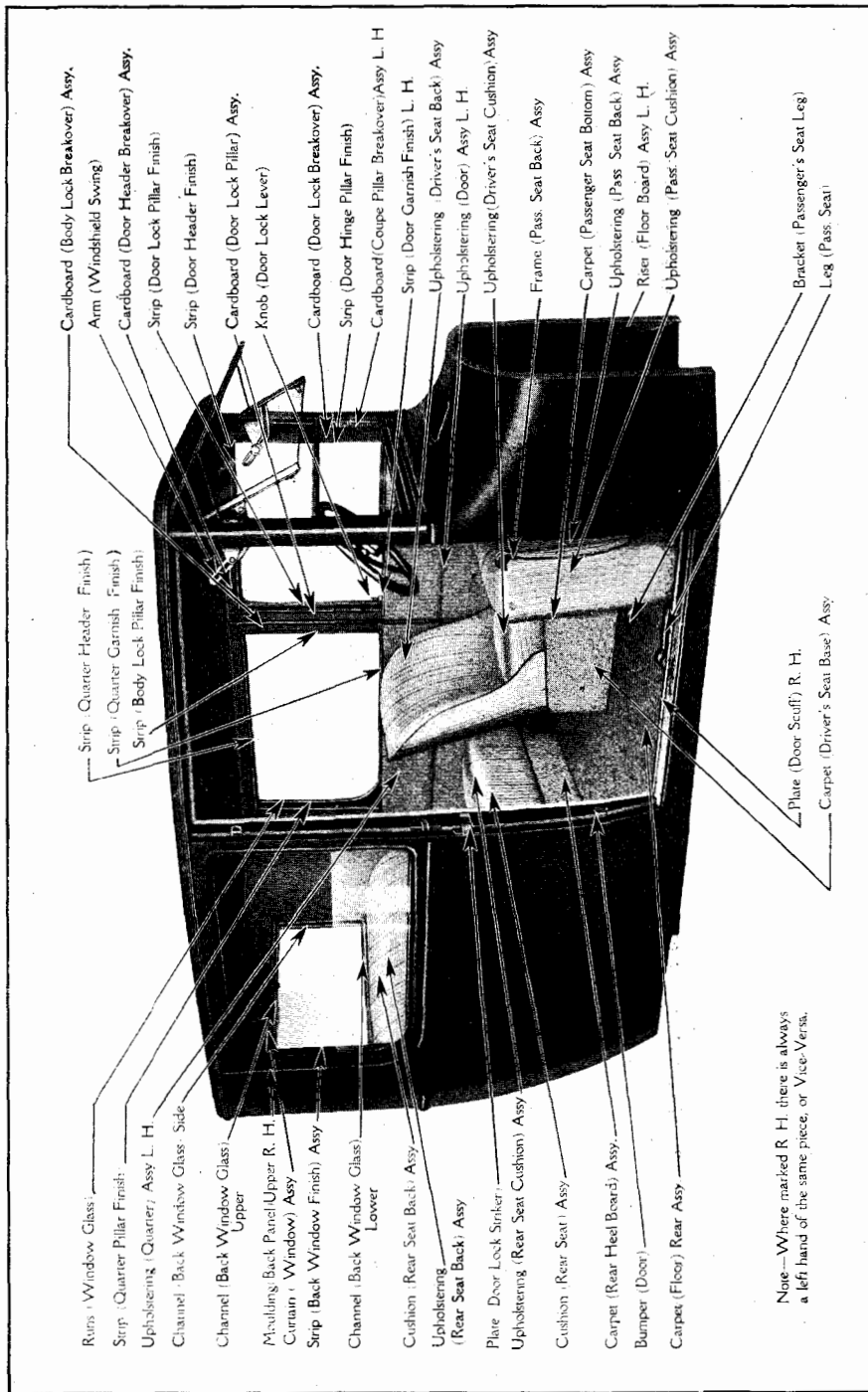

Note—Where marked R. H. there is always a left hand of the same piece, or Vice-Versa.

Part No.	NAME	YEAR	PRICE
TUDOR SEDAN BODY PARTS—1924-25—Continued			
17536RX	Strip (quarter garnish finish)	1924-25	\$ 0 35
17617X	Strip (quarter pillar finish) and spring assy.—R. H.	1924-25	25
17618X	Strip (quarter pillar finish) and spring assy.—L. H.	1924-25	25
18508ARX	Strip (quarter window glass retaining) thin	1924-25	15
18508BRX	Strip (quarter window glass retaining) thick	1924-25	15
18506RX	Strip (quarter window header weather)	1924-25	20
18503RX	Strip (quarter window weather)	1924-25	05
17533RX	Strip (roof drip moulding finish)	1924-25	20
18812RX	Strip (windshield weather) side	1924-25	10
17070RX	Support (instrument board) R. H.	1924-25	15
17071RX	Support (instrument board) L. H.	1924-25	15
18813X	Tubing (windlace)	1924-25	03 ft.
18548ARX	Upholstering (door) assy.—R. H.	1924-25	3 25
18548BX	Upholstering (door) assy.—L. H.	1925	5 00
18549ARX	Upholstering (door) assy.—R. H.	1924-25	3 25
18549BX	Upholstering (door) assy.—L. H.	1925	5 00
18588RX	Upholstering (driver's seat back) assy.	1924-25	6 00
18592X	Upholstering (driver's seat cushion) assy.	1924-25	4 00
18568RX	Upholstering (pass. seat cushion) assy.	1924-25	4 00
18569RX	Upholstering (pass. seat back) and cardboard assy.	1924-25	2 25
18570RX	Upholstering (pass. seat back) assy.—rear	1924-25	1 50
18550RX	Upholstering (quarter) assy.—R. H.	1924-25	5 00
18551RX	Upholstering (quarter) assy.—L. H.	1924-25	8 00
18027RX	Upholstering (rear seat cushion) assy.	1924-25	8 00
18028RX	Upholstering (rear seat back cushion) assy.	1924-25	8 00
18150RX	Visor and bracket assy.	1924-25	2 75
G126-18851RX	Windshield assy. (upper half)	1924-25	8 25
G125-18852RX	Windshield assy. (lower half)	1924-25	4 55
G127-18853RX	Windshield assy. (complete)	1924-25	16 25

Part No.	NAME	YEAR	PRICE
TUDOR BODY PARTS—1926-27			
50530X	Anti-rattler (bucket seat cardboard)	1926-27	20
8320BX	Anti-rattler (door lock lever)	1926-27	05
50520X	Anti-rattler (rear cross member housing)	1926-27	30
50214X	Arm (windshield swing)	1926-27	45
50764ARX	Back (passenger seat) assy.—trimmed (gray-green-hard)	1926	9 00
50764BRX	Back (passenger seat) assy.—trimmed (gray-green-soft)	1926	9 00
50764CX	Back (passenger seat) assy.—trimmed (gray-white)	1927	9 00
18210X	Beading (roof) front	1926-27	45
18210X	Beading (roof) rear	1926-27	45
50643X	Block (bucket seat riser)	1926	25
50644X	Block (passenger seat riser)	1926	20
45331X	Board (floor) No. 1 and plate assy.	1926-27	50
45332X	Board (floor) No. 2 and plate assy.	1926-27	50
45333X	Board (floor) No. 3 and plate assy.	1926-27	65
50627X	Board (floor) No. 4 assembly	1926-27	1 50
50628X	Board (floor) No. 5 assembly	1926-27	1 00
45158X	Board (front floor) and pedal shield assy.	1926-27	1 25
50344X	Board (rear heel) assembly	1926-27	60
50636ARX	Bottom (passenger seat) assy.	1926	1 75
50058X	Brace (back pillar) R. H.	1926-27	10
50059X	Brace (back pillar) L. H.	1926-27	10
50178X	Brace (roof rib No. 2)	1926-27	10
45060X	Bracket (body)	1926-27	10
50167X	Bracket (center hinge) assy.—R.	1926-27	35
50168X	Bracket (center hinge) assy.—L.	1926-27	35
50092X	Bracket (coupe pillar) R. H.	1926-27	10
50093X	Bracket (coupe pillar) L. H.	1926-27	10
50269X	Bracket (door check strap) assy.	1926-27	15
50337ARX	Bracket (rear seat cushion frame)	1926	10
50337BX	Bracket (rear seat cushion frame)	1926-27	15
45124X	Bracket (side sill to dash) R. H.	1926-27	10
45125X	Bracket (side sill to dash) L. H.	1926-27	10
50216X	Bracket (windshield swing arm pillar)	1926-27	10
50395A2X	Bumper (door) long	1926-27	05
50395A1X	Bumper (door) short	1926-27	05
50085A1X	Bumper (door) short	1926-27	05
50085A2X	Bumper (door) long	1926-27	05
†150527BX	Cardboard (cowl)—R. H.	1926-27	25
†50536BX	Cardboard (cowl)—L. H.	1926-27	20
18593X	Cardboard (passenger seat bottom)	1926	10
50481ARX	Cardboard (passenger seat bottom)	1926	75
50481BX	Cardboard (passenger seat bottom)	1926-27	75
50545X	Carpet (drivers seat base) assy.	1926-27	1 25
50513X	Carpet (floor) assembly—front	1926-27	3 75

††When ordered to replace cowl carpet assy. also order 50536BX
 †When ordered to replace cowl carpet assy. also order 50527BX

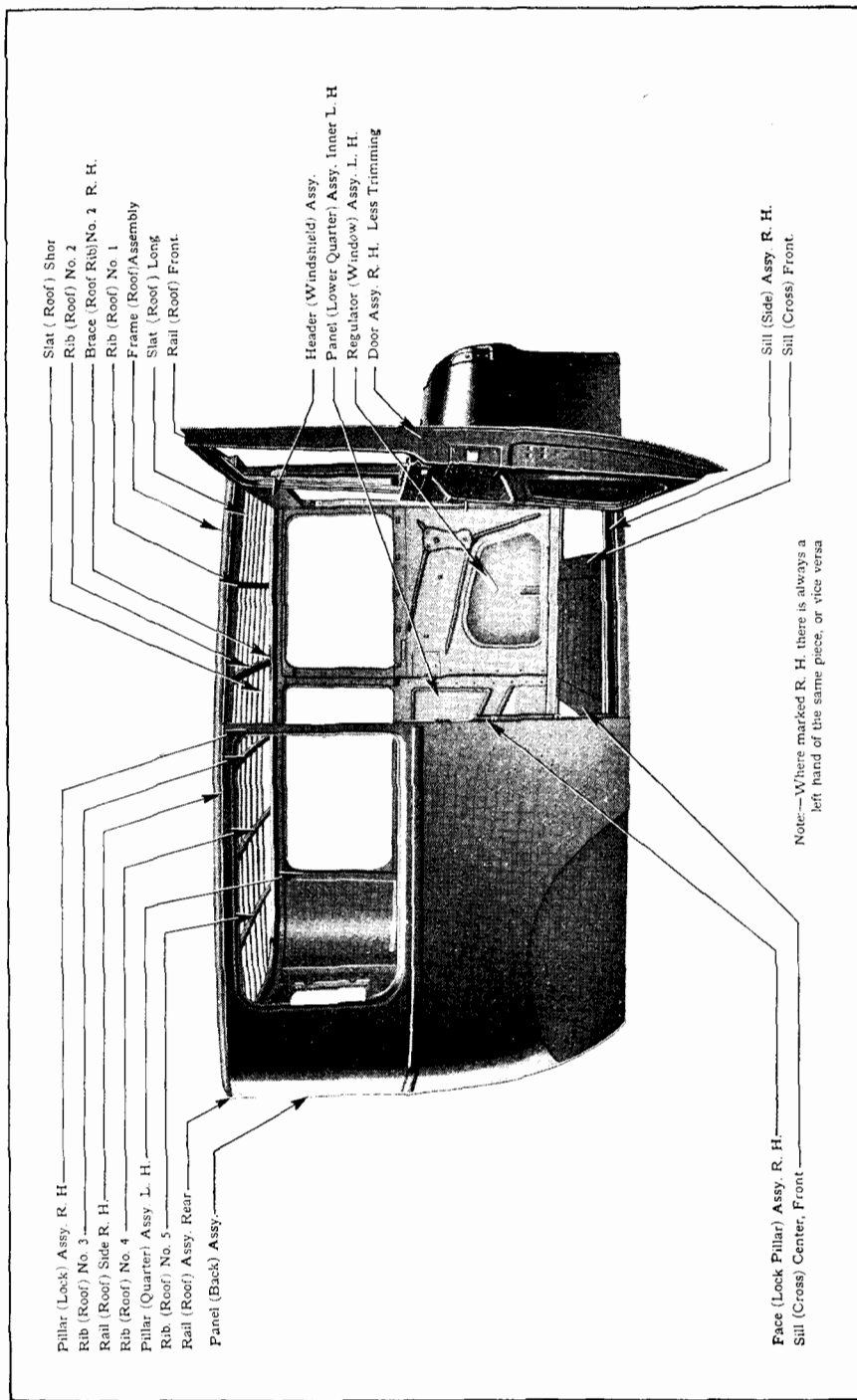

Part No.	NAME	YEAR	PRICE
----------	------	------	-------

TUDOR BODY PARTS—1926-27—Continued

50514X	Carpet (floor) assembly—rear	1926-27	\$ 3 75
50548RX	Carpet (heel board) assy.	1926	75
50343X	Channel (back window glass)	1926-27	30
50265ARX	Channel (door window glass) assy.	1926	40
50265BX	Channel (door window glass) assy.	1926-27	40
50264ARX	Channel (quarter window glass) assy.	1926	40
50264BX	Channel (quarter window glass) assy.	1926-27	40
50353X	Clip (cowl attaching) female	1926-27	05
50354X	Clip (cowl attaching) male	1926-27	05
8692X	Clip (rear seat back cushion frame)	1926-27	10
17246X	Clip (rear seat cushion spring)	1926-27	02
50276X	Clip (window glass run) upper	1926-27	03
50505RX	Cloth (body) (gray-green-hard)	1926	3 75 yd.
50907ARX	Cloth (body) (gray-green-soft)	1926	3 75 yd.
50907BX	Cloth (body) (gray-white)	1927	3 75 yd.
50506RX	Cloth (headlining) (used with 50505RX)	1926	2 50 yd.
50908ARX	Cloth (headlining) (used with 50907ARX)	1926	2 50 yd.
50908BX	Cloth (headlining) (used with 50907BX)	1927	2 50 yd.
50550ARX	Cloth (headlining) assy. (gray-green-hard)	1926	6 00
50550BRX	Cloth (headlining) assy. (gray-green-soft)	1926	6 00
50550CX	Cloth (headlining) assy. (gray-white)	1927	6 00
50915BX	Cloth (roof rail finish strip)	1926-27	15 yd.
50510X	Cord (curtain)	1926-27	02 yd.
50925ARX	Cord (headlining seaming) assy.	1926	10 yd.
50925BX	Cord (headlining seaming) assy.	1926	10 yd.
50511RX	Cord (quarter and door covered seaming)	1926	03 yd.
50935X	Cord (quarter and door covered seaming)	1927	03 yd.
50590RX	Cord (roof rail finish strip seaming) assy.	1926	10 yd.
50473RX	Cord (seat back seaming) assy.	1926-27	10 yd.
50901ARX	Cord (seat cushion seaming) assy.	1926	10 yd.
50901BX	Cord (seat cushion seaming) assy.	1927	10 yd.
50519X	Cord (lock pillar wind) assy.	1926-27	20 yd.
50478X	Cord (door hinge wind) assy.	1926-27	15 yd.
50215X	Cup (windshield swing arm washer)	1926-27	02 yd.
50516X	Curtain (window) assy.	1926-27	2 00
50769ARX	Cushion (bucket seat) assy. (gray-green-hard)	1926	7 50
50769BRX	Cushion (bucket seat) assy. (gray-green-soft)	1926	7 50
50769CX	Cushion (bucket seat) assy. (gray-white)	1927	7 50
50766ARX	Cushion (rear seat) assy. (gray-green-hard)	1926	15 00
50766BRX	Cushion (rear seat) assy. (gray-green-soft)	1926	15 00
50766CX	Cushion (rear seat) assy. (gray-white)	1927	15 00
50765ARX	Cushion (rear seat back) assy. (gray-green-hard)	1926	15 00
50765BRX	Cushion (rear seat back) assy. (gray-green-soft)	1926	15 00
50765CX	Cushion (rear seat back) assy. (gray-white)	1926	15 00
40166X	Cushion (steering column) lower	1926-27	02
40160X	Cushion (steering column) upper	1926-27	03
9462X	Cushion (window)	1926-27	03
150345RX	Door assy.—R. H. complete (gray-green-hard uph.)	1926	*32 50
150346RX	Door assy.—L. H. complete (gray-green-hard uph.)	1926	*32 50
150931ARX	Door assy.—R. H. complete (gray-green-soft uph.)	1926	*32 50
150932ARX	Door assy.—L. H. complete (gray-green-soft uph.)	1926	*32 50
150931BRX	Door assy.—R. H. complete (gray-white uph.)	1927	*32 50
150932BRX	Door assy.—L. H. complete (gray-white uph.)	1927	*32 50
50137X	Door assy. R. H. (unpainted and untrimmed)	1926-27	*15 00
50138X	Door assy. L. H. (unpainted and untrimmed)	1926-27	*15 00
5053CX	Dove tail (door) male assy. (tongue off center)	1926-27	10
5053BX	Dove tail (male) assy.	1926-27	10
50309X	Face (lock pillar) assy.—R. H.	1926-27	2 75
50310X	Face (lock pillar) assy.—L. H.	1926-27	2 75
10419X	Fastener (carpet) assy.—female	1926-27	05
10416X	Fastener (carpet) assy.—male	1926-27	05
17498X	Fastener (door trim)	1926-27	01
17802X	Fastener (door window glass run) lower	1926-27	02
50099X	Foot (bucket seat leg)	1926-27	10
50099X	Foot (pass. seat leg)	1926-27	10
50629X	Frame (bucket seat) bottom assembly	1926-27	2 00
50314ARX	Frame (passenger seat back) and support assy.	1926	2 00
50314BRX	Frame (passenger seat back) and support assy.	1926-27	2 00
16200X	Frame (rear seat back cushion) and clip assembly	1926-27	3 00
16225X	Frame (rear seat cushion) assembly	1926-27	2 25
50324X	Frame (roof) assembly	1926-27	15 00
50201ARX	Frame (windshield) assy.	1926	5 00
50201BX	Frame (windshield) assy.	1926-27	5 00
50336	Glass (back window)	1926-27	2 25
50252BX	Glass (door)	1926-27	3 50
50318BX	Glass (door) and channel assy.—R. H.	1926-27	4 20
50319BX	Glass (door) and channel assy.—L. H.	1926-27	4 20
50251BX	Glass (quarter)	1926-27	4 20
50388B	Glass (quarter and channel assy.) R. H. & L. H.	1926-27	4 85

*Not subject to regular discount †Specify color of paint.

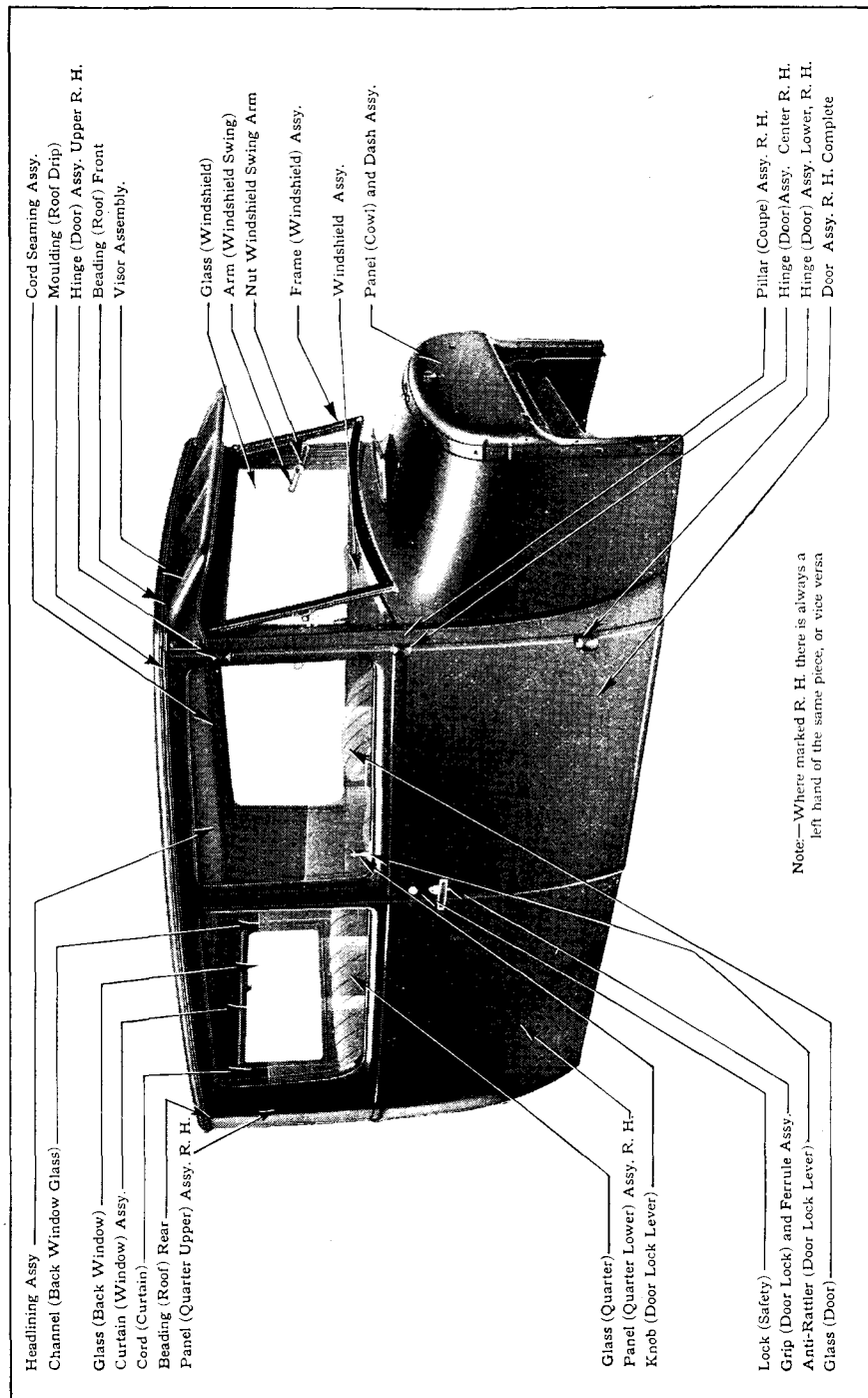

Part No.	NAME	YEAR	PRICE
TUDOR BODY PARTS—1926-27—Continued			
50456X	Glass (windshield)	1926-27	\$ 4 15
17130BRX	Grip (door lock) and ferrule assy.	1926	60
17130CX	Grip (door lock) and ferrule assy.	1926-27	60
50165X	Grommet (bucket and passenger seat leg)	1926-27	05
17221BX	Handle (window regulator) assy.	1926-27	40
50071ARX	Header (windshield) assy.	1926	*10 00
50071BX	Header (windshield) assy.	1926-27	2 00
50152X	Hinge (door) assy.—center—R. H.	1926-27	35
50153X	Hinge (door) assy.—center—L. H.	1926-27	35
50154X	Hinge (door) assy.—lower—R. H.	1926-27	35
50155X	Hinge (door) assy.—lower—L. H.	1926-27	35
50150X	Hinge (door) assy.—upper—R. H.	1926-27	35
50151X	Hinge (door) assy.—upper—L. H.	1926-27	35
45198X	Hook (cowl ventilator weather strip)	1926-27	03
50102X	Housing (rear cross member) assy.	1926-27	1 50
17282DX	Key (safety lock) (specify serial letters and numbers)	1926-27	25
17261BX	Knob (door lock lever)	1926-27	15
18558X	Leather (roof)	1926-27	6 50
50105X	Leg (bucket seat)	1926-27	30
50105X	Leg (pass. seat)	1926-27	30
45335X	Lid (ventilator) assembly	1926-27	60
17750X	Lock (door) assembly—R. H.	1926-27	85
17751X	Lock (door) assembly—L. H.	1926-27	85
50432X	Lock (door) assy.—R. H.	1926-27	1 00
50433X	Lock (door) assy.—L. H.	1926-27	1 00
17279X	Lock (safety) and keys	1926-27	1 00
17347X	Loop (door check strap)	1926-27	03
50244X	Moulding (roof drip)	1926-27	35
17499X	Nail (door trim)	1926-27	01
50396X	Nut (roof rail to coupe pillar)	1926-27	03
50397X	Nut (seat leg)	1926-27	10
50399X	Nut (bucket seat leg)	1926-27	15
17334X	Nut (windshield swing arm)	1926-27	03
50575X	Pad (drivers seat back and burlap) assy.	1926-27	80
50571X	Pad (drivers seat cushion and burlap) assy.	1926-27	60
50572X	Pad (passenger seat back)	1926-27	20
50577X	Pad (passenger seat back filler) large	1926-27	20
50571X	Pad (passenger seat cushion and burlap) assy.	1926-27	60
18247X	Pad (rear seat back spring and burlap) assy.	1926-27	1 10
18245X	Pad (rear seat cushion spring and burlap) assy.	1926-27	1 25
50302X	Panel (back) assy.	1926-27	*15 00
50315X	Panel (cowl) and dash assy.	1926-27	17 50
50072X	Panel (instrument)	1926-27	3 50
50163X	Panel (lower quarter inner) and nut assy.—R. H.	1926-27	1 50
50164X	Panel (lower quarter inner) and nut assy.—L. H.	1926-27	1 50
50328X	Panel (quarter lower) assy.—R. H.	1926-27	6 00
50329X	Panel (quarter lower) assy.—L. H.	1926-27	7 50
50326X	Panel (quarter upper) assy.—R. H.	1926-27	4 00
50327X	Panel (quarter upper) assy.—L. H.	1926-27	4 00
50330X	Panel (quarter upper and lower) assy.—R. H.	1926-27	10 00
50331X	Panel (quarter upper and lower) assy.—L. H.	1926-27	10 00
50112X	Panel (quarter lining) R. H.	1926-27	40
50113X	Panel (quarter lining) L. H.	1926-27	40
50305ARX	Pillar (coupe) assy.—R. H.	1926	6 00
50305BX	Pillar (coupe) assy.—R. H.	1926-27	7 50
50306ARX	Pillar (coupe) assy.—L. H.	1926	6 00
50306BX	Pillar (coupe) assy.—L. H.	1926-27	7 50
50316X	Pillar (lock) assy.—R. H.	1926-27	2 25
50317X	Pillar (lock) assy.—L. H.	1926-27	2 25
50322X	Pillar (quarter) assy.—R. H.	1926-27	1 25
50323X	Pillar (quarter) assy.—L. H.	1926-27	1 25
50369X	Pin (bucket seat leg)	1926-27	05
40137X	Pin (ventilator lid hinge)	1926-27	1 00C
50369X	Pin (pass. seat leg)	1926-27	05
50290X	Plate (door bumper)	1926-27	10
50060X	Plate (door lock striker) inner	1926-27	15
50061X	Plate (door lock striker) outer	1926-27	10
50253ARX	Plate (door scuff) R. H.	1926-27	40
50253BX	Plate (door scuff) R. or L.	1926	20
50254RX	Plate (door scuff) L. H.	1926	40
45213X	Plate (floor board No. 1 pedal)	1926-27	10
45218X	Plate (floor board No. 2 pedal)	1926-27	10
50257RX	Plate (quarter scuff) R. H.	1926	35
50258RX	Plate (quarter scuff) L. H.	1926	35
45132X	Plate (side lever)	1926-27	05
17227BX	Plate (window regulator escutcheon)	1926-27	05
50613X	Rail (roof) front	1926-27	1 75
50614 X	Rail (roof) side—R. H.	1926-27	3 00
50615X	Rail (roof) side—L. H.	1926-27	3 00

*Not subject to regular discount

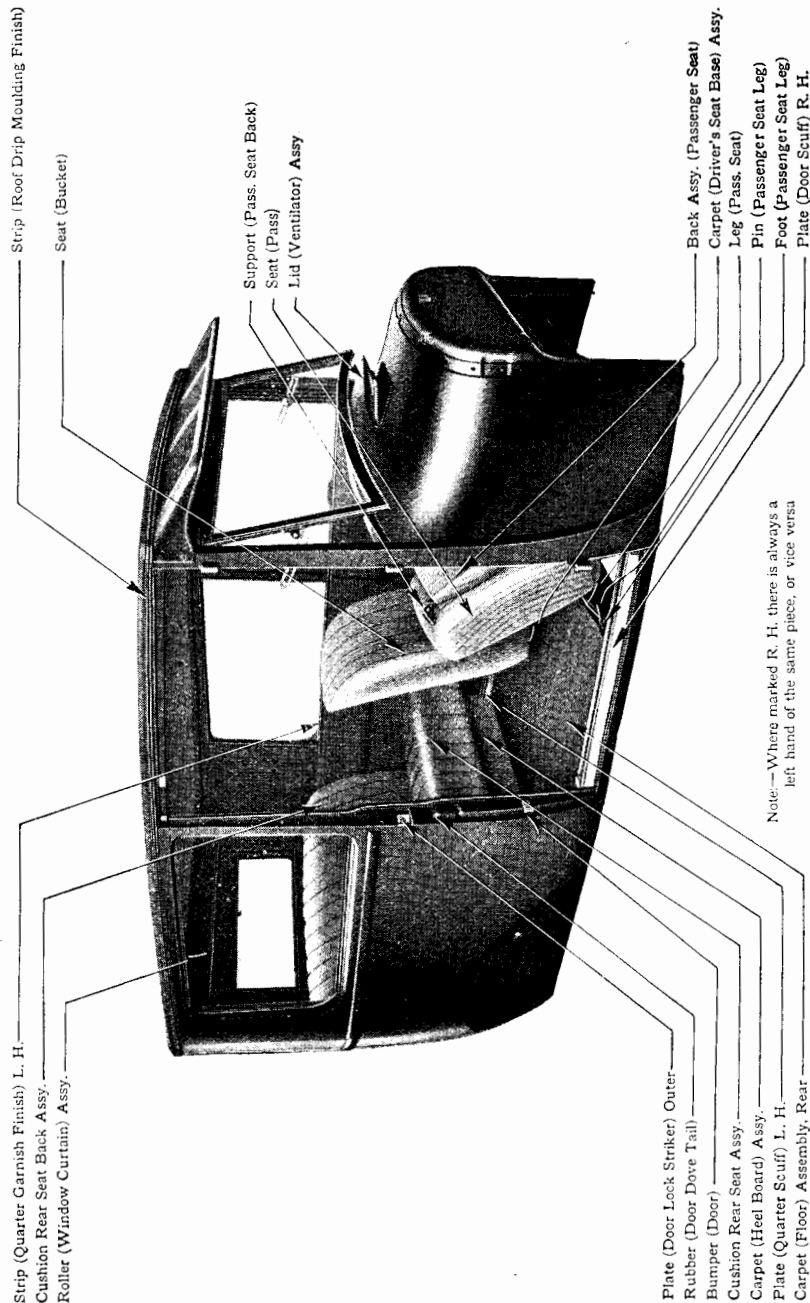

Part No.	NAME	YEAR	PRICE
TUDOR BODY PARTS—1926-27—Continued			
50325X	Rail (roof) assy.—rear	1926-27	\$ 5 00
	Regulator (window) assy.—(see page 93)	1926	
50297X	Reinforcement (back to quarter panel) upper	1926-27	03
50110X	Reinforcement (quarter window opening) R. H.	1926-27	10
50111X	Reinforcement (quarter window opening) L. H.	1926-27	10
50116X	Reinforcement (quarter to back panel)	1926-27	05
50368X	Reinforcement (pass. seat bottom)	1926-27	15
50108X	Rest (pass. seat)	1926-27	15
50108X	Rest (bucket seat)	1926-27	15
50106X	Retainer (bucket seat cushion)	1926-27	50
50670X	Retainer (bucket seat cushion) and wire assy.	1926-27	65
50084X	Retainer (door glass run)	1926-27	10
50238X	Retainer (quarter window glass run)	1926-27	10
50620X	Rib (roof) No. 1	1926-27	30
50621X	Rib (roof) No. 2	1926-27	30
50622X	Rib (roof) No. 3	1926-27	30
50623X	Rib (roof) No. 4	1926-27	30
50624X	Rib (roof) No. 5	1926-27	30
50331X	Riser (front floor board) assy.—R. H.	1926-27	70
50335X	Riser (front floor board) assy.—L. H.	1926-27	70
9759-A1X	Roller (window curtain) assy.	1926-27	90
18822X	Rubber (door dove tail)	1926-27	03
50338X	Run window glass assy.	1926-27	45
50355X	Seat (bucket) assy. without trim	1926-27	6 00
50378ARX	Seat (bucket) assy.—completely trimmed (gray-green-hard)	1926	*22 50
50378BRX	Seat (bucket) assy.—completely trimmed (gray-green-soft)	1926	*22 50
50378CX	Seat (bucket) assy.—completely trimmed (gray-white)	1926	*22 50
50370X	Seat (pass.) assy. (without trimming)	1926-27	6 00
50535ARX	Seat (pass.) assy.—completely trimmed (gray-green-hard)	1926	*20 00
50535BRX	Seat (pass.) assy.—completely trimmed (gray-green-soft)	1926	*20 00
50535CX	Seat (pass.) assy.—completely trimmed—(gray-white)	1927	*20 00
18543X	Sheeting (roof)	1926-27	80
45130X	Shield (pedal)	1926-27	15
50300X	Side (body) assy.—R. H.	1926-27	*30 00
50301X	Side (body) assy.—L. H.	1926-27	*30 00
50699X	Sill (cross) assy.—center—rear	1926-27	80
50009X	Sill (cross) center—front	1926-27	90
50008X	Sill (cross) front	1926-27	80
45025ARX	Sill (cross) rear	1926	1 50
45025BRX	Sill (cross) rear	1926-27	60
50303ARX	Sill (side) assy.—R. H.	1926	3 50
50304ARX	Sill (side) assy.—L. H.	1926	3 50
50303BX	Sill (side) assy.—R. H.	1926-27	3 50
50304BX	Sill (side) assy.—L. H.	1926-27	3 50
50641X	Slat (roof) long	1926-27	20
50642X	Slat (roof) short	1926-27	20
50371X	Socket (rear seat back clip)	1926-27	05
50619X	Spacer (rear seat back cushion frame)	1926-27	60
50296X	Spacer (side to cross sill)	1926-27	03
50533X	Spring (bucket seat back) assy.	1926-27	75
50534ARX	Spring (bucket seat cushion) assy.	1926	1 25
50534BRX	Spring (bucket seat cushion) assy.	1926-27	1 25
17077X	Spring (door dovetail)	1926-27	05
50528X	Spring (pass. seat cushion) assy.	1926-27	1 25
18223RX	Spring (rear seat cushion) assy.	1926	3 00
9938X	Spring (rear seat back) assy.	1926-27	1 50
50809AX	Spring (rear seat cushion) assy.	1926-27	3 00
40182X	Spring (ventilator lock)	1926-27	10
18380X	Strap (door check)	1926-27	15
18382X	Strap (door check) and loop assy.	1926-27	20
50541X	Strip (bucket seat back trim) outside	1926-27	05
50542X	Strip (bucket seat back trim) inside—short	1926-27	03
50499X	Strip (back window finish) assy.	1926-27	75
50188ARX	Strip (coupe pillar finish) R. H.	1926	35
50188BX	Strip (coupe pillar finish) R. H.	1926-27	35
50189ARX	Strip (coupe pillar finish) L. H.	1926	35
50189BX	Strip (coupe pillar finish) L. H.	1926-27	35
45197X	Strip (cowl ventilator weather)	1926-27	15
45196X	Strip (cowl ventilator weather) and hook assy.	1926-27	20
50136BX	Strip (door garnish finish) L. H.	1926-27	45
50135BX	Strip (door garnish finish) R. H.	1926-27	45
50424X	Strip (door glass channel weather)	1926-27	30
50462X	Strip (door header weather and retainer) assy.	1926-27	15
50259X	Strip (door header weather)	1926-27	15

*Not subject to regular discount

Part No.	NAME	YEAR	PRICE
TUDOR BODY PARTS—1926-27—Continued			
50539RX	Strip (door opening weather) assy. (gray-green-hard)	1926	\$ 0 35
50909ARX	Strip (door opening weather) assy. (gray-green-soft)	1926	35
50909BX	Strip (door opening weather) assy. (gray-white)	1926-27	35
50517AX	Strip (door window glass retaining) (with thin glass)	1926-27	10
50517BX	Strip (door window glass retaining) (with thick glass)	1926-27	10
50280ARX	Strip (door window finish) assy.—R. H.	1926	1 75
50281ARX	Strip (door window finish) assy.—L. H.	1926	1 75
50280BRX	Strip (door window finish) assy.—R. H.	1926-27	1 25
50281BRX	Strip (door window finish) assy.—L. H.	1926-27	1 25
50230X	Strip (lock pillar finish) R.	1926-27	50
50231X	Strip (lock pillar finish) L.	1926-27	50
50425X	Strip (quarter glass channel weather)	1926-27	15
50463X	Strip (quar. header weather) and retainer assy.	1926	45
50234X	Strip (quarter window finish) assy.—R. H.	1926-27	1 50
50235X	Strip (quarter window finish) assy.—L. H.	1926-27	1 50
50193X	Strip (quarter garnish finish) R. H.	1926-27	45
50197X	Strip (quarter garnish finish) L. H.	1926-27	45
50260X	Strip (quarter header weather)	1926-27	25
50518AX	Strip (quarter window glass retaining) (with thin glass)	1926-27	10
50518BX	Strip (quarter window glass retaining) (with thick glass)	1926-27	10
50245X	Strip (roof drip moulding finish)	1926-27	20
50206X	Strip (windshield weather) side—R. H.	1926-27	10
50207X	Strip (windshield weather) side—L. H.	1926-27	10
50208X	Strip (windshield weather) bottom	1926-27	20
50282AX	Strip (windshield glass retaining) upper (with thin glass)	1926-27	10
50282BX	Strip (windshield glass retaining) upper (with thick glass)	1926-27	10
50283AX	Strip (windshield glass retaining) lower (with thin glass)	1926-27	15
50283BX	Strip (windshield glass retaining) lower (with thick glass)	1926-27	15
50128RX	Strip (windshield header finish)	1926	35
9520BRX	Support (pass. seat back)	1926	50
9520CX	Support (passenger seat back)	1926-27	50
50358X	Support (rear seat cushion) rear	1926-27	40
17597X	Support (rear seat cushion) side—R. H.	1926-27	15
17598X	Support (rear seat cushion) side—L. H.	1926-27	15
50049X	Support (roof rail) rear	1926-27	75
50185AX	Support (roof rail) R. H.	1926-27	1 75
50186AX	Support (roof rail) L. H.	1926-27	1 75
45055A2X	Support (steering column) L. H. control	1926-27	20
50503RX	Upholstering (back panel upper) assy.—upper (gray-green-hard)	1926	65
50905ARX	Upholstering (back panel upper) assy.—upper (gray-green-soft)	1926	65
50905BX	Upholstering (back panel upper) assy.—upper (gray-white)	1927	65
50498ARX	Upholstering (quarter panel) assy.—R. H. (gray-green-hard)	1926	4 00
50498BRX	Upholstering (quarter panel) assy.—R. H. (gray-green-soft)	1926	4 00
50498CX	Upholstering (quarter panel) assy.—R. H. (gray-white)	1927	4 00
50499ARX	Upholstering (quarter panel) assy.—L. H. (gray-green-hard)	1926	4 00
50499BRX	Upholstering (quarter panel) assy.—L. H. (gray-green-soft)	1926	4 00
50499CX	Upholstering (quarter panel) assy.—L. H. (gray-white)	1927	4 00
50484ARX	Upholstering (quarter window header) assy.—R. H. (gray-green-hard)	1926	35
50484BRX	Upholstering (quarter window header) assy.—R. H. (gray-green-soft)	1926	35
50484CX	Upholstering (quarter window header) assy.—R. H. (gray-white)	1927	35
50486ARX	Upholstering (quarter window header) assy.—L. H. (gray-green-hard)	1926	35
50486BRX	Upholstering (quarter window header) assy.—L. H. (gray-green-soft)	1926	35
50486CX	Upholstering (quarter window header) assy.—L. H. (gray-white)	1926	35
50504RX	Upholstering (back panel upper) assy.—lower (gray-green-hard)	1926	65
50906ARX	Upholstering (back panel upper) assy.—lower (gray-green-soft)	1926	65
50906BX	Upholstering (back panel upper) assy.—lower (gray-white)	1927	65
50579X	Upholstering (body lock pillar) assy. (gray-green-hard)	1926	35

Part No.	NAME	YEAR	PRICE
TUDOR SEDAN BODY PARTS—1926-27—Continued			
50938ARX	Upholstering (body lock pillar) assy. (gray-green-soft)	1926	\$0 35
50938BX	Upholstering (body lock pillar) assy. (gray-white)	1927	35
50479RX	Upholstering (door) assy.—R. H. (gray-green-hard)	1926	3 25
50902ARX	Upholstering (door) assy.—R. H. (gray-green-soft)	1926	3 25
50902BX	Upholstering (door) assy.—R. H. (gray-white)	1927	3 25
50480RX	Upholstering (door) assy.—L. H. (gray-green-hard)	1926	3 25
50903ARX	Upholstering (door) assy.—L. H. (gray-green-soft)	1926	3 25
50903BX	Upholstering (door) assy.—L. H. (gray-white)	1927	3 25
50587ARX	Upholstering (drivers seat back) assy. (gray-green-hard)	1926	4 50
50587BRX	Upholstering (drivers seat back) assy. (gray-green-soft)	1926	4 50
50587CX	Upholstering (drivers seat back) assy. (gray-white)	1927	4 50
50588ARX	Upholstering (drivers seat cushion) assy. (gray-green-hard)	1926	3 50
50588BRX	Upholstering (drivers seat cushion) assy. (gray-green-soft)	1926	3 50
50588CX	Upholstering (drivers seat cushion) assy. (gray-white)	1927	3 50
50578RX	Upholstery (door header) assy.—L. H. (gray-green-hard)	1926	40
50501RX	Upholstery (door header) assy.—R. H. (gray-green-hard)	1926	40
50580RX	Upholstery (door hinge pillar) assy.	1926	35
50590ARX	Upholstering (passenger seat back) and cardboard assy.—front (gray-green-hard)	1926	2 25
50590BRX	Upholstering (passenger seat back) and cardboard assy.—front (gray-green-soft)	1926	2 25
50590CX	Upholstering (passenger seat back) and cardboard assy.—front (gray-white)	1927	2 25
50591ARX	Upholstering (passenger seat back) assy.—rear (gray-green-hard)	1926	1 25
50591BRX	Upholstering (passenger seat back) assy.—rear (gray-green-soft)	1926	1 25
50591CX	Upholstering (passenger seat back) assy.—rear (gray-white)	1927	1 25
50589ARX	Upholstering (passenger seat cushion) assy. (gray-green-hard)	1926	3 50
50589BRX	Upholstering (passenger seat cushion) assy. (gray-green-soft)	1926	3 50
50589CX	Upholstering (passenger seat cushion) assy. (gray-white)	1927	3 50
50586RX	Upholstering (rear seat back) assy. (gray-green-hard)	1926	6 00
50929ARX	Upholstering (rear seat back) assy. (gray-green-soft)	1926	6 00
50929BX	Upholstering (rear seat back) assy. (gray-white)	1927	6 00
50585ARX	Upholstering (rear seat cushion) assy. (gray-green-hard)	1926	6 00
50585BRX	Upholstering (rear seat cushion) assy. (gray-green-soft)	1926	6 00
50585CX	Upholstering (rear seat cushion) assy. (gray-white)	1927	6 00
50488ARX	Upholstering (upper back panel) side—R. H. (gray-green-hard)	1926	1 50
50488BRX	Upholstering (upper back panel) side—R. H. (gray-green-soft)	1926	1 50
50488CX	Upholstering (upper back panel) side—R. H. (gray-white)	1927	1 50
50489ARX	Upholstering (upper back panel) side—L. H. (gray-green-hard)	1926	1 50
50489BRX	Upholstering (upper back panel) side—L. H. (gray-green-soft)	1926	1 50
50489CX	Upholstering (upper back panel) side—L. H. (gray-white)	1927	1 50
50502RX	Upholstering (windshield header) assy. (gray-green-hard)	1926	1 00
50904ARX	Upholstering (windshield header) assy. (gray-green-soft)	1926	1 00
50904BX	Upholstering (windshield header) assy. (gray-white)	1927	1 00
50537X	Visor assembly	1926-27	3 25
50797X	Wadding (roof)	1927	3 30
50752X	Wadding (drivers seat back)	1926-27	15
50200ARX	Windshield assembly	1926	10 25
50200BX	Windshield assembly	1926-27	10 25

Part No.	NAME	YEAR	PRICE
FORDOR SEDAN BODY PARTS—1923-25—Continued			
16138RX	Frame (front seat back) upper assy.	1923-25	\$ 3 50
16142RX	Frame (front seat back) lower assy.	1923-25	2 25
10155X	Frame (cowl) assy.	1923	2 00
17300RX	Frame (windshield upper) top hinge and channel assy.	1923-25	5 00
G101-18830X	Glass (back window)	1923-25	2 25
G100-18831X	Glass (quarter window)	1923-25	3 00
G98-18833X	Glass (front door window)	1923-25	3 00
G99-18832X	Glass (rear door window)	1923-25	3 00
G96-18834RX	Glass (windshield) lower	1923-25	2 00
G97-18835RX	Glass (windshield) upper	1923-25	2 45
G105-18854X	Glass (front door window) and channel assy.—R. H.	1923-24	3 60
G106-18855X	Glass (front door window) and channel assy.—L. H.	1923-24	3 60
G107-18856X	Glass (rear door window) and channel assy.	1923-24	3 50
G108-18857X	Glass (quarter window) and channel assy.—R. H.	1923-25	3 55
G109-18858X	Glass (quarter window) and channel assy.—L. H.	1923-25	3 55
17130ARX	Grip (door lock) and ferrule assy.	1923-24	1 25
17130BRX	Grip (door lock) and ferrule assy.	1924-25	60
17221ARX	Handle (window regulator) assy.	1923-24	65
17221BX	Handle (window regulator) assy.	1924-25	40
17273X	Handle (door lock—dog shaft)	1923-24	15
17044X	Handle (ventilator)	1923-25	10
16090RX	Header (windshield)	1923-25	1 00
16095X	Header (quarter) R. H.	1923-25	60
16096X	Header (quarter) L. H.	1923-25	60
17172ARX	Hinge (rear door) upper assy.—L. H.	1923-25	40
17172BRX	Hinge (front door) upper assy.—R. H.	1923-25	40
17175ARX	Hinge (rear door) center assy.—L. H.	1923-25	40
17175BRX	Hinge (front door) center assy.—R. H.	1923-25	40
17178ARX	Hinge (rear door) lower assy.—L. H.	1923-25	40
17178BRX	Hinge (front door) lower assy.—R. H.	1923-25	40
17180ARX	Hinge (front door) upper assy.—L. H.	1923-25	40
17180BRX	Hinge (rear door) upper assy.—R. H.	1923-25	40
17186ARX	Hinge (rear door) lower assy.—R. H.	1923-25	40
17186BRX	Hinge (front door) lower assy.—L. H.	1923-25	40
17183ARX	Hinge (front door) center assy.—L. H.	1923-25	40
17183BRX	Hinge (rear door) center assy.—R. H.	1923-25	40
17090RX	Housing (rear cross member) assy.	1923-25	1 50
17282X	Key (safety lock) (specify serial letter and number)	1923-24	25
17261BX	Knob (door lock lever)	1923-24	25
18214RX	Lace (wind assy.)	1923-24	15
18395RX	Lace (wind assy.)	1924-25	25 yd.
18160X	Leather (roof)	1923-25	6 50
18913X	Lens (dome light)	1923-25	10
18044X	Lining (head) assy.	1923-24	8 00
18378RX	Lining (head) assy.	1924-25	8 00
17279X	Lock (safety) and keys	1923-25	1 00
17250ARX	Lock (rear door) assy.—R. H. Ford design	1923-24	1 50
17751X	Lock (rear door) assy.—R. H.	1924-25	85
17251ARX	Lock (rear door) assy.—L. H. Ford design	1923-24	1 50
17752X	Lock (rear door) assy.—L. H.	1924-25	85
17252ARX	Lock (front door) assy.—R. H. Ford design	1923-24	1 50
17750X	Lock (front door) assy.—R. H.	1924-25	85
17250ARX	Lock (front door) assy.—L. H. Ford design	1923-24	1 50
17751X	Lock (front door) assy.—L. H.	1924-25	85
17124X	Moulding (roof drip)	1923-25	55
17150X	Moulding (front door lock pillar "T") R. H.	1923-24	60
17151X	Moulding (front door lock pillar "T") L. H.	1923-24	60
17151X	Moulding (rear door lock pillar "T") R. H.	1923-24	60
17150X	Moulding (rear door lock pillar "T") L. H.	1923-24	60
17152X	Moulding (front door bottom "T")	1923-24	60
17153X	Moulding (front door hinge pillar "T") lower R. H.	1923-24	45
17154X	Moulding (front door hinge pillar "T") lower L. H.	1923-24	20
17155X	Moulding (front door hinge pillar "T") center—lower	1923-24	50
17156X	Moulding (front door hinge pillar "T") center—upper	1923-24	25
17157X	Moulding (front door hinge pillar "T") upper	1923-24	10
17158X	Moulding (rear door bottom "T") R. H.	1923-24	70
17159X	Moulding (rear door bottom "T") L. H.	1923-24	70
17155X	Moulding (rear door hinge pillar "T") center—lower	1923-24	50
17160X	Moulding (rear door hinge pillar "T") center—upper	1923-24	30
17157X	Moulding (rear door hinge pillar "T") upper	1923-24	10
17162RX	Moulding (front belt)	1923-24	1 50
17163X	Moulding (rear belt)	1923-25	80
17164X	Moulding (back panel) upper—R. H.	1923-25	30
17165X	Moulding (back panel) upper—L. H.	1923-25	30
17166RX	Moulding (back panel) lower	1923-25	40
17167X	Moulding (quarter belt) R. H.	1923-25	1 00
17168X	Moulding (quarter belt) L. H.	1923-25	1 00
16218X	Moulding (front seat) assy.—side	1923-24	20

Part No.	NAME	YEAR	PRICE
FORDOR SEDAN BODY PARTS—1923-25—Continued			
18379RX	Moulding (front seat) assy.—side	1924-25	\$ 0 20
18216X	Moulding (front seat) assy.—back	1923-24	50
17334X	Nut (windshield swing arm bracket bolt)	1923-25	03
5085BX	Nut (window lifter support rod)	1923-25	1 00C
17001X	Panel (front door) R. H.	1923-24	7 50
17002X	Panel (front door) L. H.	1923-24	7 50
17003RX	Panel (rear door) R. H.	1923-24	7 50
17004RX	Panel (rear door) L. H.	1923-24	7 50
17005X	Panel (quarter) upper—R. H.	1923-25	3 00
17006X	Panel (quarter) upper—L. H.	1923-25	3 00
17007RX	Panel (quarter) lower—R. H.	1923-25	5 00
17008RX	Panel (quarter) lower—L. H.	1923-25	5 00
17009X	Panel (front rocker) R. H.	1923-25	35
17010X	Panel (front rocker) L. H.	1923-25	35
17011X	Panel (rear rocker) R. H.	1923-25	35
17012X	Panel (rear rocker) L. H.	1923-25	35
17016RX	Panel (instrument)	1923-24	1 25
17346RX	Panel (instrument)	1924-25	1 00
17017RX	Panel (front roof rail)	1923-24	40
17018RX	Panel (front roof rail)	1923-24	50
17027BRX	Panel (coupe pillar) R. H.	1923-25	45
17028BRX	Panel (coupe pillar) L. H.	1923-25	45
17021ARX	Panel (front seat back)	1923-25	4 00
17021BX	Panel (front seat back)	1923-25	4 00
17022RX	Panel (windshield header)	1923-25	5 50
17023X	Panel (back) upper	1923-25	6 75
17024RX	Panel (back) lower	1923-25	5 00
17025X	Panel (body lock pillar) R. H.	1923-25	1 25
17026X	Panel (body lock pillar) L. H.	1923-25	1 25
17029X	Panel (quarter corner) R. H.	1923-25	10
17030X	Panel (quarter corner) L. H.	1923-25	10
16050RX	Pillar (coupe) R. H.	1923-25	4 50
16051RX	Pillar (coupe) L. H.	1923-25	4 50
16054RX	Pillar (body hinge) assy.—R. H.	1923-25	3 50
16055RX	Pillar (body hinge) assy.—L. H.	1923-25	3 50
16056RX	Pillar (quarter) R. H.	1923-25	1 25
16057RX	Pillar (quarter) L. H.	1923-25	1 25
17047X	Pin (ventilator hinge clevis)	1923-25	02
17143X	Plate (front door scuff) R. H.	1923-25	30
17144X	Plate (front door scuff) L. H.	1923-25	30
17145X	Plate (rear door scuff) R. H.	1923-25	30
17146X	Plate (rear door scuff) L. H.	1923-25	30
17227ARX	Plate (window regulator escutcheon)	1923-24	05
17227BRX	Plate (window regulator escutcheon)	1925	05
17276RX	Plate (door lock striker)	1923-24	10
17490X	Plate (door lock striker)	1924-25	10
17129RX	Plate (steering column)	1923-24	02
17274X	Plate (door lock dog shaft escutcheon)	1923-24	15
17045BRX	Quadrant (ventilator handle)	1923-25	30
17111X	Rack (quarter window lifter) R. H.	1923-25	30
17112X	Rack (quarter window lifter) L. H.	1923-25	1 00
16070RX	Rail (front belt)	1923-24	45
16071X	Rail (front door belt) R. H.	1923-24	45
16072X	Rail (front door belt) L. H.	1923-24	45
16073X	Rail (rear door belt) R. H.	1923-24	45
16074X	Rail (rear door belt) L. H.	1923-24	45
16075X	Rail (quarter belt) R. H.	1923-25	1 25
16076X	Rail (quarter belt) L. H.	1923-25	3 00
16077RX	Rail (rear belt) assy.	1923-25	4 00
16081ARX	Rail (roof) side—R. H.	1924-25	4 00
16081BRX	Rail (roof) side—L. H.	1923-25	4 00
16082ARX	Rail (roof) assy.—R. H.	1924-25	4 00
16082BRX	Rail (roof) assy.—L. H.	1923-25	4 00
16083X	Rail (roof) rear assy.	1923-25	5 50
16087ARX	Rail (roof) front	1923-25	1 75
16087BRX	Rail (roof) front	1924-25	1 00
18901BX	Reflector (dome light) assy.	1923-25	65
	Regulator (window)—(see page 93)	1923-25	35
16041X	Rest (quarter sash) R. H.	1923-25	35
16042X	Rest (quarter sash) L. H.	1923-25	30
16043X	Rest (rear door lock pillar sash)	1923-24	10
16035RX	Rest (front door sash)	1923-25	45
16097ARX	Rest (quarter sash) assy.—R. H.	1923-25	45
16098ARX	Rest (quarter sash) assy.—L. H.	1923-25	45
17315AX	Retainer (windshield glass) upper (for thin glass)	1923-25	15
17315BX	Retainer (windshield glass) upper (for thick glass)	1923-25	15
17314ARX	Retainer (windshield glass) lower (for thin glass)	1923-25	15
17314BRX	Retainer (windshield glass) lower (for thick glass)	1923-25	15
18461BRX	Retainer (door header) assy.	1924-25	30
18459BRX	Retainer (door lock pillar) assy.	1924-25	30
18462BRX	Retainer (front door hinge pillar) assy.	1924-25	30

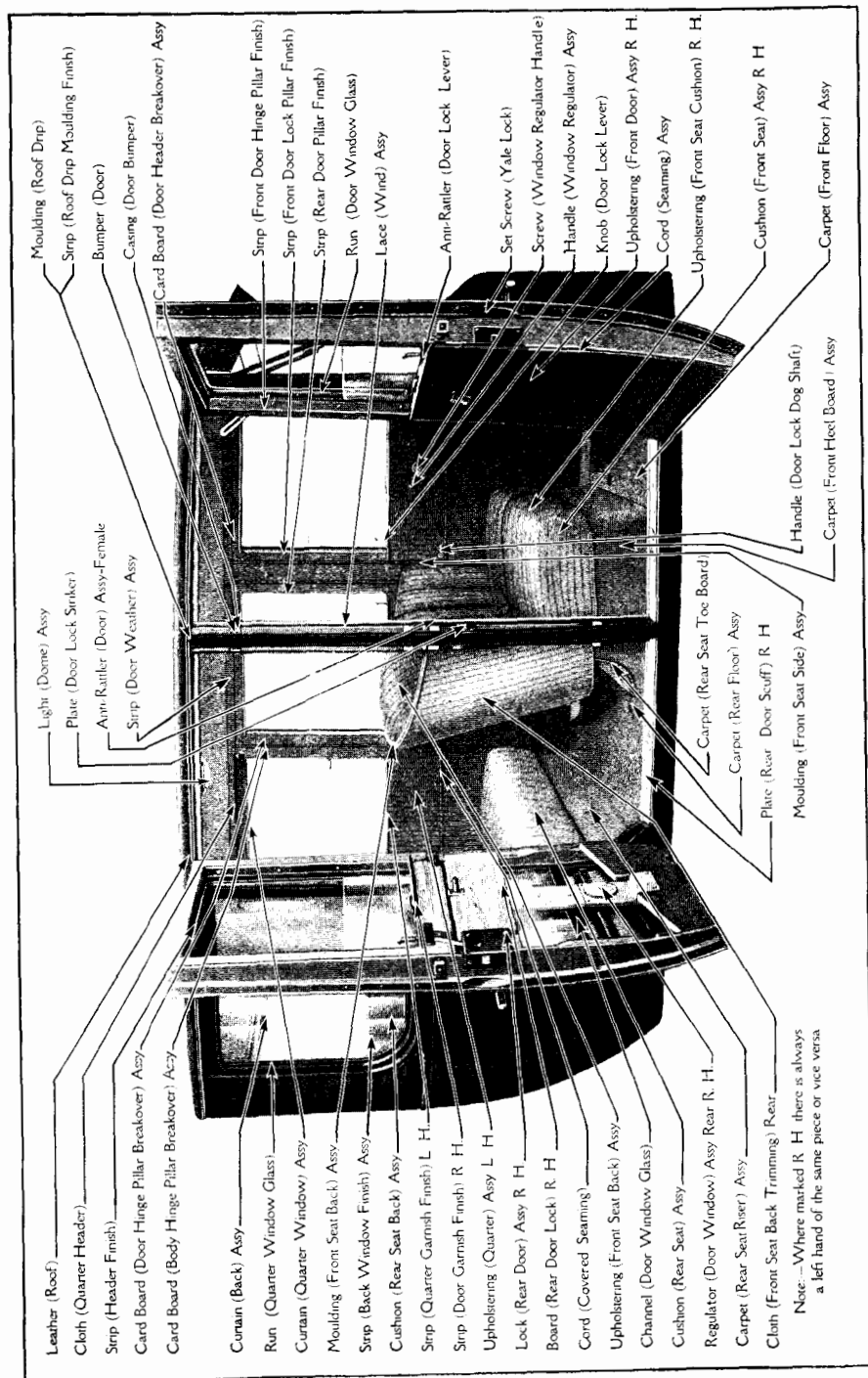

Part No.	NAME	YEAR	PRICE
FORDOR SEDAN BODY PARTS—1923-25—Continued			
18466BRX	Retainer (rear door hinge pillar) assy.	1924-25	\$ 0 30
16120X	Rib (roof) No. 1	1923-25	30
16121X	Rib (roof) No. 2	1923-25	30
16122X	Rib (roof) No. 3	1923-25	30
16123X	Rib (roof) No. 4	1923-25	30
16124X	Rib (roof) No. 5	1923-25	30
16026X	Riser (rear seat) front	1923-25	1 75
16027X	Riser (rear seat) rear	1923-25	75
17354RX	Riser (floor board) assy.—R. H.	1924-25	50
17355RX	Riser (floor board) assy.—L. H.	1924-25	50
17351X	Rivet (visor bracket to visor)	1923-25	01
17145X	Rod (window lifter support) and nut assy.—L. H.	1923-25	40
17146X	Rod (window lifter support) and nut assy.—R. H.	1923-25	40
9759A1X	Roller (back window curtain) assy.	1923-25	25
9758A1X	Roller (quarter window curtain) assy.	1923-25	1 25
18811X	Runs (window glass)	1923-24	40
17277RX	Screw (door lock dog shaft handle)	1923-24	01
17225RX	Screw (window regulator handle)	1923-24	05
17283RX	Screw (safety lock set)	1923-24	05
5309Y	Screw (safety lock bushing set)	1921-25	75C 01
17320RX	Screw (windshield swing arm bracket)	1923-24	10
17330ARX	Screw (windshield swing arm thumb)	1923-25	15
17272ARX	Shaft (door lock—dog) (Ford design)	1923-24	15
17272BRX	Shaft (door lock—dog) (Ferro design)	1923-24	15
16003X	Sill (cross) front	1923-25	45
16004X	Sill (cross) center	1923-25	75
16005RX	Sill (cross) rear	1923-25	1 25
16006ARX	Sill (side) and rocker assy.—R. H.	1923	5 50
16006BRX	Sill (side) and rocker assy.—R. H.	1923-24	4 50
16006CRX	Sill (side) and rocker assy.—R. H.	1924-25	4 50
16007ARX	Sill (side) and rocker assy.—L. H.	1923	5 50
16007BRX	Sill (side) and rocker assy.—L. H.	1923-24	4 80
16007CRX	Sill (side) and rocker assy.—L. H.	1924-25	4 50
16125RX	Slat (roof frame)	1923-25	25
5067BX	Spring (window lifter support rod)	1923-25	03
5092X	Spring (window lifter counterbalance)	1923-25	10
18220RX	Spring (front seat cushion) assy.—R. H.	1923-25	1 50
18221RX	Spring (front seat cushion) assy.—L. H.	1923-25	1 50
18222X	Spring (front seat back) assy.	1923-25	1 25
18223RX	Spring (rear seat cushion) assy.	1923-25	3 00
9938X	Spring (rear seat back) assy.	1923-25	1 50
16045X	Strainer (back panel) upper	1923-25	20
16046RX	Strainer (back panel) lower—R. H.	1923-25	75
16047RX	Strainer (back panel) lower—L. H.	1923-25	75
16048RX	Strainer (back panel) lower—center	1923-25	1 00
9059CX	Strap (door check) assy.	1923-24	30
18382X	Strap (door check) assy.	1924-25	20
17102X	Strip (header finish)	1923-25	35
17103X	Strip (quarter garnish finish) R. H.	1923-25	15
17104X	Strip (quarter garnish finish) L. H.	1923-25	15
17106X	Strip (front door garnish finish) R. H.	1923-25	30
17105X	Strip (front door garnish finish) L. H.	1923-25	30
17105X	Strip (rear door garnish finish) R. H.	1923-25	30
17106X	Strip (rear door garnish finish) L. H.	1923-25	30
17244X	Strip (rear door lock pillar finish) and spring assy.—R. H.	1923-25	30
17245X	Strip (rear door lock pillar finish) and spring assy.—L. H.	1923-25	30
17244X	Strip (rear door hinge pillar finish) and spring assy.—L. H.	1923-25	30
17245X	Strip (rear door hinge pillar finish) and spring assy.—R. H.	1923-25	30
17242X	Strip (front door hinge pillar finish) and spring assy.—R. H.	1923-25	30
17243X	Strip (front door hinge pillar finish) and spring assy.—L. H.	1923-25	30
17244X	Strip (front door lock pillar finish) and spring assy.—L. H.	1923-25	30
17245X	Strip (front door lock pillar finish) and spring assy.—R. H.	1923-25	30
17110X	Strip (quarter pillar finish)	1923-24	20
17117X	Strip (back window finish) assy.	1923-25	75
17125X	Strip (roof drip moulding finish)	1923-25	25
10239AX	Strip (window glass retaining) thick	1923-24	10
10239BX	Strip (window glass retaining) thin	1923-24	10
18801X	Strip (window header weather)	1923-25	15
18803X	Strip (door window weather)	1923-24	05
18850X	Strip (window weather) and retainer assy.	1923-24	20
17074X	Support (instrument board) and cowl brace assy.—R. H.	1923-24	65

Part No.	NAME	YEAR	PRICE
FORDOR SEDAN BODY PARTS—1923-25—Continued			
17075X	Support (instrument board) and cowl brace assy.—L. H.	1923-24	\$ 0 65
18904ARX	Switch (dome light)	1923	75
18904BX	Switch (dome light) assy.	1923-25	35
†18020ARX	Upholstering (front door) assy.—R. H. (brown)	1923	3 50
18020BX	Upholstering (front door) assy.—R. H. (brown)	1923-24	2 75
*18383ARX	Upholstering (front door) assy.—R. H. (blue)	1924	2 75
†18383BRX	Upholstering (front door) assy.—R. H. (blue)	1924	2 75
††18383CRX	Upholstering (front door) assy.—R. H. (blue)	1924-25	3 50
††18383DRX	Upholstering (front door) assy.—R. H. (blue)	1925	3 50
†18021ARX	Upholstering (front door) assy.—L. H. (brown)	1923	3 50
18021BX	Upholstering (front door) assy.—L. H. (brown)	1923-24	2 75
*18384ARX	Upholstering (front door) assy.—L. H. (blue)	1924	2 75
†18384BRX	Upholstering (front door) assy.—L. H. (blue)	1924	2 75
††18384CRX	Upholstering (front door) assy.—L. H. (blue)	1924-25	3 50
††18384DRX	Upholstering (front door) assy.—L. H. (blue)	1925	3 50
†18029ARX	Upholstering (rear door) assy.—R. H. (brown)	1923	3 00
†18292BX	Upholstering (rear door) assy.—R. H. (brown)	1923-24	2 75
*18385ARX	Upholstering (rear door) assy.—R. H. (blue)	1924	4 00
†18355BRX	Upholstering (rear door) assy.—R. H. (blue)	1924	4 00
††18385CRX	Upholstering (rear door) assy.—R. H. (blue)	1924-25	5 00
††18385DRX	Upholstering (rear door) assy.—R. H. (blue)	1925	5 00
†18030ARX	Upholstering (rear door) assy.—L. H. (brown)	1923	3 00
18030BX	Upholstering (rear door) assy.—L. H. (brown)	1923-24	2 75
*18386ARX	Upholstering (rear door) assy.—L. H. (blue)	1924	4 00
†18386BRX	Upholstering (rear door) assy.—L. H. (blue)	1924	4 00
††18386CRX	Upholstering (rear door) assy.—L. H. (blue)	1924-25	5 00
††18386DRX	Upholstering (rear door) assy.—L. H. (blue)	1925	5 00
18024RX	Upholstering (front seat cushion) assy.—R. H. (brown)	1923-24	4 50
18389RX	Upholstering (front seat cushion) assy.—R. H. (blue)	1924-25	4 50
18025RX	Upholstering (front seat cushion) assy.—L. H. (brown)	1923-24	4 50
18390RX	Upholstering (front seat cushion) assy.—L. H. (blue)	1924-25	4 50
18026X	Upholstering (front seat back) assy. (brown)	1923-24	7 00
18391RX	Upholstering (front seat back) assy. (blue)	1924-25	7 00
18027RX	Upholstering (rear seat cushion) assy. (brown)	1923-24	8 00
18392RX	Upholstering (rear seat cushion) assy. (blue)	1924-25	8 00
18028RX	Upholstering (rear seat back cushion) assy. (brown)	1923-24	8 00
18393RX	Upholstering (rear seat back cushion) assy. (blue)	1924-25	7 50
18022X	Upholstering (quarter) assy.—R. H. (brown)	1923-24	2 25
18387ARX	Upholstering (quarter) assy.—R. H. (blue)	1924	2 25
*†18387BRX	Upholstering (quarter) assy.—R. H. (blue)	1924-25	2 25
18023X	Upholstering (quarter) assy.—L. H. (brown)	1923-24	2 25
18388ARX	Upholstering (quarter) assy.—L. H. (blue)	1924	2 25
*†18388BRX	Upholstering (quarter) assy.—L. H. (blue)	1924-25	2 25
18379RX	Upholstering (upper back panel trim) upper (brown)	1923-24	45
18351X	Upholstering (upper back panel trim) upper (blue)	1925	30
18081X	Upholstering (upper back panel trim) side (brown)	1923-24	65
18352X	Upholstering (upper back panel trim) side (blue)	1924-25	65
18277RX	Upholstering (upper back panel) assy.—lower (brown)	1923-24	20
18427RX	Upholstering (upper back panel) assy.—lower (blue)	1924-25	25
18150RX	Visor and bracket assy.	1923-25	2 75
17350X	Washer (visor to roof rail screw finishing)	1923-25	01
17226X	Washer (window regulator handle screw lock)	1923-24	02
17224X	Washer (window regulator handle anti-rattler)	1923-24	01
17313BX	Washer (windshield swing arm bracket screw)	1923-25	01
17313ARX	Washer (windshield swing arm bracket screw)	1923	02
G103-18851RX	Windshield assy.—upper half	1923-25	8 25
G102-18852RX	Windshield assy.—lower half	1923-25	4 55
G104-18853RX	Windshield assy.—complete	1923-25	16 25
18911X	Wire (dome light switch to light) assy.	1923-25	15
18907RX	Wire (dome light switch to ammeter) assy.	1923	40
18909RX	Wire (dome light to ground) assy.	1923	25
18917X	Wire (dome light to ammeter) assy.	1923-25	50
18919X	Wire (dome light switch to ground connector) assy.	1923-25	15

FORDOR BODY PARTS—1926-27

8320-BX	Anti-rattler (door lock lever)	1926-27	05
18241X	Anti-rattler (front seat back spring)	1926-27	15
54404X	Anti-rattler (rear cross member housing)	1926-27	15

†With carpet at bottom. ††Headlining cloth—wood frame door. *Body cloth—wood frame door.
 ††Steel door—staggered fasteners. †††Steel door—fasteners in line. **Headlining cloth.

Part No.	NAME	YEAR	PRICE
FORDOR BODY PARTS—1926-27—Continued			
5095BX	Anti-rattler (window lifter support rod)	1926-27	\$0 05
5103X	Arm (window lifter counterbalance) assy.—L. H.	1926-27	40
5104X	Arm (window lifter counterbalance) assy.—R. H.	1926-27	40
50214X	Arm (windshield swing)	1926-27	45
17141X	Back (front seat) assy. (less trimming)	1926-27	8 50
54508X	Back (front seat) assy. (complete)	1926	21 00
18210X	Beading (roof) front	1926-27	45
18210X	Beading (roof) rear	1926-27	45
16014X	Board (dome light)	1926-27	50
9496BX	Board (floor) No. 2 and plate assy.	1926-27	75
16020CX	Board (floor) No. 4	1926-27	60
16021CX	Board (floor) No. 5	1926-27	60
16022CRX	Board (floor) No. 6	1926	70
16022DX	Board (floor) No. 6	1926-27	70
18301X	Board (front seat heel) and carpet assy.	1926-27	3 00
18302X	Board (rear seat toe) and carpet assy.	1926-27	3 00
16118X	Board (quarter garnish) R. H.	1926-27	50
16130X	Board (quarter garnish) L. H.	1926-27	50
16157X	Board (tool box)	1926-27	1 00
17144X	Board (front seat heel) assy.	1926-27	1 65
17014X	Board (rear seat toe) assy.	1926-27	1 50
54232X	Board (floor) No. 1 and plate assy.	1926-27	1 75
8169X	Board (floor) No. 3 and plate assy.	1926-27	1 70
17097X	Board (quarter garnish) and finish strip assy.—R. H.	1926-27	75
17098X	Board (quarter garnish) and finish strip assy.—L. H.	1926-27	75
17334X	Bolt (windshield swing arm)	1926-27	03
17052X	Brace (body lock pillar)	1926-27	40
17058X	Brace (body lock pillar to roof rail) R. H.	1926-27	30
17059X	Brace (body lock pillar to roof rail) L. H.	1926-27	30
54092X	Brace (body hinge pillar) assy.—R. H.	1926-27	1 00
54093X	Brace (body hinge pillar) assy.—L. H.	1926-27	1 00
54025X	Brace (coupe pillar) R. H.	1926-27	75
54026X	Brace (coupe pillar) L. H.	1926-27	75
54094X	Brace (quarter pillar) assy.—R. H.	1926-27	1 00
54095X	Brace (quarter pillar) assy.—L. H.	1926-27	1 00
17068X	Brace (roof rib No. 4) R. H.	1926-27	1 10
17069X	Brace (roof rib No. 4) L. H.	1926-27	1 10
54079X	Bracket (dash to coupe pillar)	1926-27	25
54049X	Bracket (rear sill corner) R. H.	1926-27	45
54050X	Bracket (rear sill corner) L. H.	1926-27	45
54080X	Bracket (sill corner)	1926-27	30
50216X	Bracket (windshield swing arm pillar) assy.	1926-27	20
50212X	Bracket (windshield frame swing arm)	1926-27	10
6927B1X	Bumper (door) short	1926-27	05
6927B2X	Bumper (door) long	1926-27	05
6520X	Bulb (dome light)	1926-27	1.60X15.00C 20
54608X	Cardboard (cowl upholstery) R. H.	1926-27	10
54609	Cardboard (cowl upholstery) L. H.	1926-27	10
54578X	Carpet (cowl uph.) and cardboard assy.—R. H.	1926-27	1 50
54579X	Carpet (cowl uph.) and cardboard assy.—L. H.	1926-27	1 50
54573X	Carpet (floor) front assy.	1926-27	3 25
54591X	Carpet (floor) rear assy.	1926-27	2 50
54593X	Carpet (front seat heel board) assy.	1926-27	1 35
54596X	Carpet (rear seat riser) assy.	1926-27	1 25
54581X	Carpet (rear seat toe board) assy.	1926-27	1 50
9101BX	Casing (door bumper)	1926-27	05
17118FX	Channel (front door window glass) assy.—R. H.	1926-27	30
17199X	Channel (front door window glass) assy.—L. H.	1926-27	30
17121X	Channel (quarter window glass) R. H.	1926-27	35
17122X	Channel (quarter window glass) L. H.	1926-27	35
17118FX	Channel (rear door window glass) assy.—L. H.	1926-27	30
17199X	Channel (rear door window glass) assy.—R. H.	1926-27	30
18804BX	Channel (back window glass)	1926-27	20
54416X	Channel (windshield center)	1926-27	60
8692X	Clip (rear seat back cushion frame)	1926-27	10
54417X	Clip (windshield glass) lower—L. H.	1926-27	05
54418X	Clip (windshield glass) upper—L. H.	1926-27	05
54418X	Clip (windshield glass) lower—R. H.	1926-27	05
54417X	Clip (windshield glass) upper—R. H.	1926-27	05
54505X	Cloth (body) (gray-red)	1926	4 75 yd.
50907BX	Cloth (body) (gray-white)	1927	4 75 yd.
54506X	Cloth (headlining) (gray-red)	1926	3 25 yd.
50908B	Cloth (headlining) (gray-white)	1927	3 25 yd.
50935X	Cord (covered seaming) (quarters and doors)	1926-27	03 yd.
54545RX	Cord (seat back seaming) assy.	1926	10 yd.
54546RX	Cord (head lining seaming) assy.	1926-27	15 yd.
54425X	Cover (cowl ventilator) assy.	1926-27	1 75
54298X	Cowl and dash assy.	1926-27	12 50
50516X	Curtain (back window) assy.	1926-27	2 00
54410RX	Curtain (back window) assy.	1926	2 00
54411ARX	Curtain (quarter window) assy.	1926-27	2 00

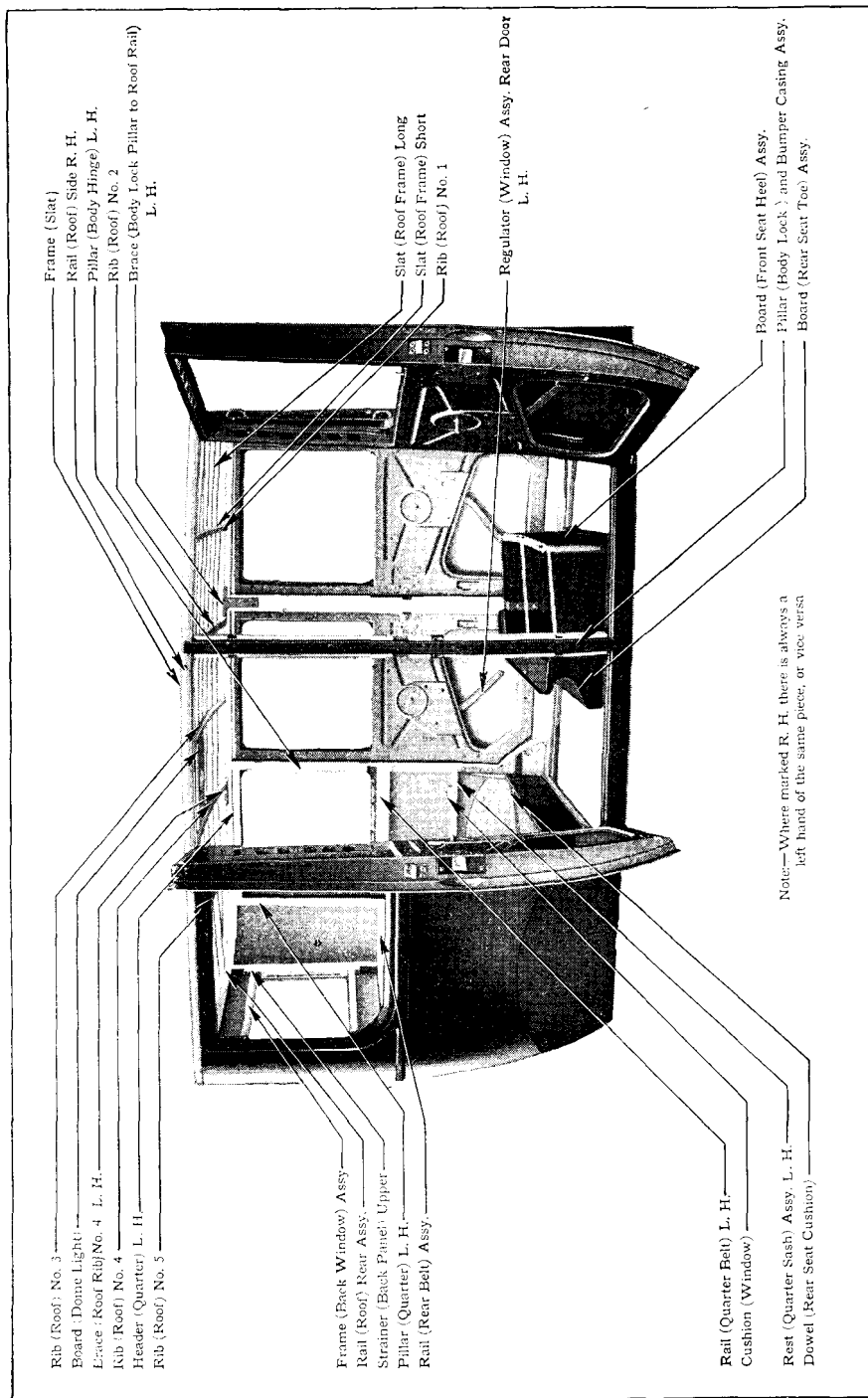

Part No.	NAME	YEAR	PRICE
FORDOR BODY PARTS—1926-27—Continued			
54411B	Curtain (quarter window) assy.	1926-27	\$2 00
40166X	Cushion (steering column) lower	1926-27	02
40150X	Cushion (steering column) upper	1926-27	03
9462X	Cushion (window)	1926-27	03
54554BX	Cushion (front seat assy.—L. (narrow pleat—gray-white)	1927	8 00
54717ARX	Cushion (rear seat back) assy. (wide pleat—gray-red)	1926	12 50
54717BX	Cushion (rear seat back) assy. (wide pleat—gray-white)	1927	12 50
54552ARX	Cushion (rear seat back) assy. (narrow pleat—gray-red)	1926	12 50
54552BX	Cushion (rear seat back) assy. (narrow pleat—gray-white)	1927	12 50
54718ARX	Cushion (rear seat) assy. (wide pleat—gray-red)	1926	15 00
54718BX	Cushion (rear seat) assy. (wide pleat—gray-white)	1927	15 00
54551ARX	Cushion (rear seat) assy. (narrow pleat—gray-red)	1926	15 00
54551BX	Cushion (rear seat) assy. (narrow pleat—gray-white)	1927	15 00
54719ARX	Cushion (front seat) assy.—R. (wide pleat gray-red)	1926	8 00
54719BX	Cushion (front seat) assy.—R. (wide pleat gray-white)	1927	8 00
54553ARX	Cushion (front seat) assy.—R. (narrow pleat—gray-red)	1926	8 00
54553BX	Cushion (front seat) assy.—R. (narrow pleat—gray-white)	1927	8 00
54720ARX	Cushion (front seat) assy.—L. (wide pleat—gray-red)	1926	8 00
54720BX	Cushion (front seat) assy.—L. (wide pleat—gray-white)	1927	8 00
54554ARX	Cushion (front seat) assy.—L. (narrow pleat—gray-red)	1926	8 00
18902BX	Dome (dome light) assy.	1926-27	40
16112CX	Door (battery trap) assy.	1926-27	1 00
17450A3X	Door (front) assy.—R. H. (untrimmed and unpainted)	1926-27	12 50
17451A3X	Door (front) assy.—L. H. (untrimmed and unpainted)	1926-27	12 50
754271ARX	Door (front) assy.—R. (gray-red uph.)	1926	*30 00
754271BX	Door (front) assy.—R. (gray-white uph.)	1927	*30 00
754272ARX	Door (front) assy.—L. (gray-red uph.)	1926	*30 00
754272BX	Door (front) assy.—L. (gray-white uph.)	1927	*30 00
17137A3X	Door (rear) assy.—R. H. (untrimmed and unpainted)	1926-27	12 50
17138A3X	Door (rear) assy.—L. H. (untrimmed and unpainted)	1926-27	12 50
754273ARX	Door (rear) assy.—R.—with flap (gray-red uph.)	1926	*30 00
754273BRX	Door (rear) assy.—R.—without flap (gray-red uph.)	1926	*30 00
754273CX	Door (rear) assy.—R. (gray-white uph.)	1927	*30 00
754274ARX	Door (rear) assy.—L.—with flap (gray-red uph.)	1926	*30 00
754274BRX	Door (rear) assy.—L.—without flap (gray-red uph.)	1926	*30 00
754274CX	Door (rear) assy.—L. (gray-white uph.)	1927	*30 00
5052BX	Dovetail (door) female assy.	1926-27	20
5053BX	Dovetail (door) male assy.	1926-27	10
5053CX	Dovetail (door) male assy. (tongue off center)	1926-27	10
17065X	Dowel (rear seat cushion)	1926-27	05
10416X	Fastener (carpet) assy.—male	1926-27	05
10419X	Fastener (carpet) assy.—female	1926-27	05
17800X	Fastener (door window glass run) upper—R. H.	1926-27	02
17801X	Fastener (door window glass run) upper—L. H.	1926-27	02
17802X	Fastener (door window glass run) lower	1926-27	02
17498X	Fastener (trim)	1926-27	50C 01
16019X	Frame (back window) assy.	1926-27	1 50
16250X	Frame (front seat cushion) assy.—R. H.	1926-27	1 50
16251X	Frame (front seat cushion) assy.—L. H.	1926-27	1 50
16100RX	Frame (roof) assy.	1926	*15 00
16200X	Frame (rear seat back cushion) assy.	1926-27	3 00
16225X	Frame (rear seat cushion) assy.	1926-27	2 25
54055X	Frame (windshield upper) assy.	1926-27	2 75
54051X	Frame (windshield lower) assy.	1926-27	1 75
18830X	Glass (back window)	1926-27	2 75
18833X	Glass (front door window)	1926-27	3 20
18854X	Glass (front door window) and channel assy.—R. H.	1926-27	3 60
18855X	Glass (front door window) and channel assy.—L. H.	1926-27	3 60
18857X	Glass (quarter window) and channel assy.—R. H.	1926-27	3 80
18858X	Glass (quarter window) and channel assy.—L. H.	1926-27	3 80
18831X	Glass (quarter window)	1926-27	3 20
18856X	Glass (rear door window) and channel assy.	1926-27	3 80
18832X	Glass (rear door window)	1926-27	3 20
54053X	Glass (windshield) lower	1926-27	2 15
54070X	Glass (windshield) upper	1926-27	2 60
17130BRX	Grip (door lock) and ferrule assy.	1926	60
17130C	Grip (door lock) and ferrule assy.	1926-27	60
17221BX	Handle (door window regulator) assy.	1926-27	40
16095X	Header (quarter) R. H.	1926-27	60

*Not subject to regular discount.

†Specify color of paint.

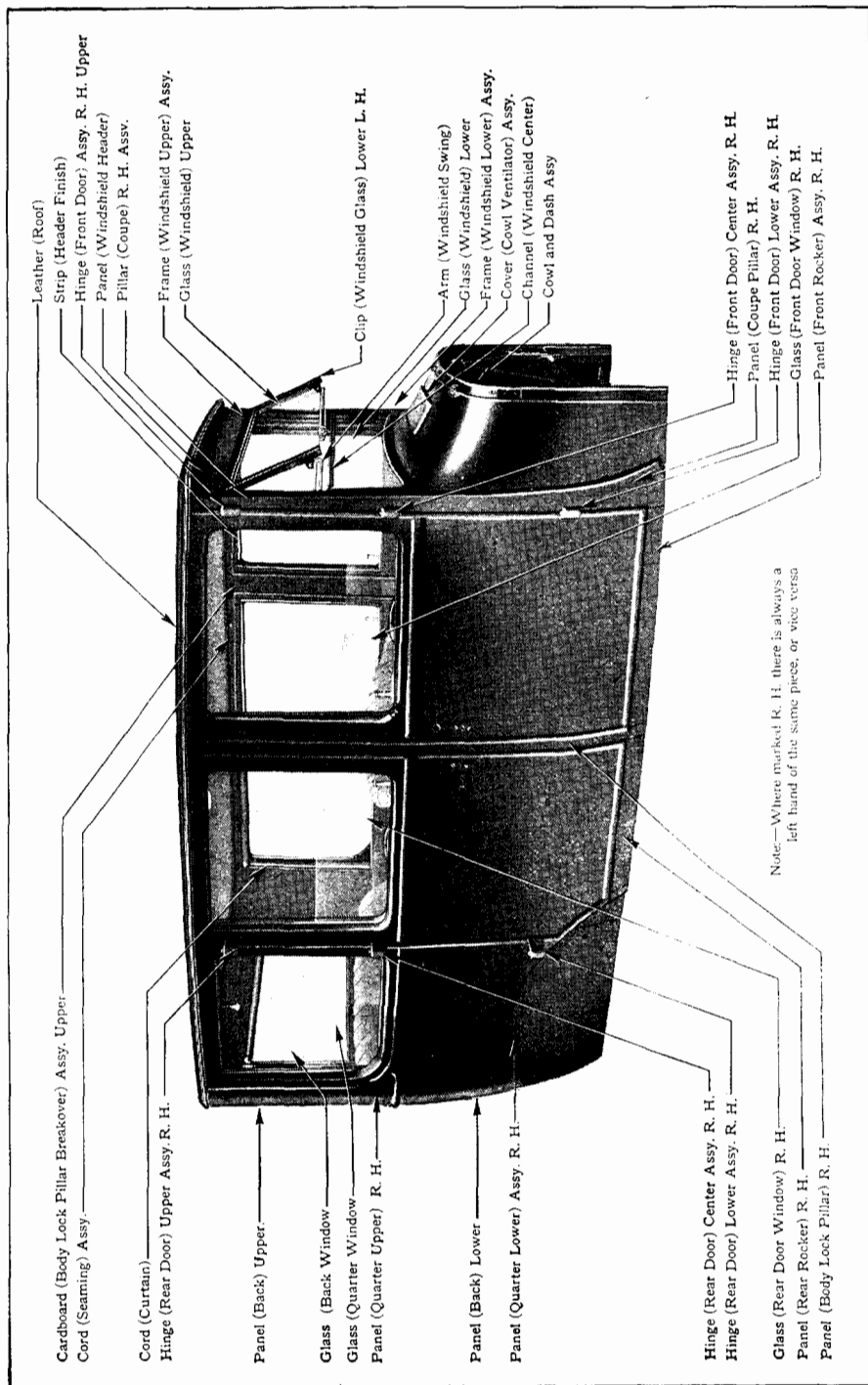

Part No.	NAME	YEAR	PRICE
----------	------	------	-------

FORDOR SEDAN BODY PARTS—1926-27—Continued

16096X	Header (quarter) L. H.	1926-27	\$0 60
54202X	Header (windshield)	1926-27	1 50
17172ARXX	Hinge (rear door) assy.—upper L. H.	1926	40
17172ARXX	Hinge (front door) assy.—upper R. H.	1926	40
17175ARXX	Hinge (rear door) assy.—center L. H.	1926	40
17175ARXX	Hinge (front door) assy.—center R. H.	1926	40
17178ARXX	Hinge (rear door) assy.—lower L. H.	1926	40
17178ARXX	Hinge (front door) assy.—lower R. H.	1926	40
17180ARXX	Hinge (front door) assy.—upper L. H.	1926	40
17180ARXX	Hinge (rear door) assy.—upper R. H.	1926	40
17186ARXX	Hinge (rear door) assy.—lower R. H.	1926	40
17186ARXX	Hinge (front door) assy.—lower L. H.	1926	40
17183ARXX	Hinge (front door) assy.—center L. H.	1926	40
17183ARXX	Hinge (rear door) assy.—center R. H.	1926	40
17175BX	Hinge (front door) assy.—center R.	1926-27	40
17183BX	Hinge (front door) assy.—center L.	1926-27	40
17176BX	Hinge (front door) assy.—lower R.	1926-27	40
17186BX	Hinge (front door) assy.—lower L.	1926-27	40
17172BX	Hinge (front door) assy.—upper R.	1926-27	40
17180BX	Hinge (front door) assy.—upper L.	1926-27	40
17183BX	Hinge (rear door) assy.—center R.	1926-27	40
17175BX	Hinge (rear door) assy.—center L.	1926-27	40
17186BX	Hinge (rear door) assy.—lower R.	1926-27	40
17178BX	Hinge (rear door) assy.—lower L.	1926-27	40
17180BX	Hinge (rear door) assy.—upper R.	1926-27	40
17172BX	Hinge (rear door) assy.—upper L.	1926-27	40
54077X	Housing (rear cross member) assy.	1926-27	2 00
17282DX	Key (safety lock) (specify serial letter and numbers)	1926-27	25
17261BX	Knob (door lock lever)	1926-27	15
54556ARX	Lace (wind) assy. (gray-red)	1926	20 yd.
54556BX	Lace (wind) assy. (gray-white)	1927	20 yd.
18160X	Leather (roof)	1926-27	6 50
18913X	Lens (dome light)	1926-27	10
54557ARX	Lining (head) assy. (gray-red)	1926	7 00
54557BX	Lining (head) assy. (gray-white)	1927	7 00
17750X	Lock (front door) assy.—R. H.	1926-27	85
17751X	Lock (front door) assy.—L. H.	1926-27	85
17751X	Lock (rear door) assy.—R. H.	1926-27	85
17752X	Lock (rear door) assy.—L. H.	1926-27	85
17279X	Lock (safety) and keys	1926-27	1 00
17347X	Loop (door check strap)	1926-27	03
17144X	Moulding (back panel) upper R. H.	1926-27	30
17165X	Moulding (back panel) upper L. H.	1926-27	30
17163X	Moulding (rear belt)	1926-27	80
17124X	Moulding (roof drip)	1926-27	55
17167X	Moulding (quarter belt) R.	1926-27	1 00
17168X	Moulding (quarter belt) L.	1926-27	1 00
54011X	Panel (rear door corner block) R. H.	1926-27	35
54012X	Panel (rear door corner block) L. H.	1926-27	35
17005X	Panel (quarter) upper R. H.	1926-27	3 00
17006X	Panel (quarter) upper L. H.	1926-27	3 00
54096X	Panel (quarter) assy.—lower R. H.	1926-27	5 00
54097X	Panel (quarter) assy.—Lower L. H.	1926-27	5 00
17009X	Panel (front rocker) R. H.	1926-27	35
17010X	Panel (front rocker) L. H.	1926-27	35
17011X	Panel (rear rocker) R. H.	1926-27	35
17012X	Panel (rear rocker) L. H.	1926-27	35
54021X	Panel (instrument)	1926-27	3 50
54016X	Panel (coupe pillar) R. H.	1926-27	1 00
54017X	Panel (coupe pillar) L. H.	1926-27	1 00
17021BX	Panel (front seat back)	1926-27	4 00
54018X	Panel (windshield header)	1926-27	75
17023X	Panel (back) upper	1926-27	6 75
54064X	Panel (back) lower assy.	1926-27	4 00
17025X	Panel (body lock pillar) R. H.	1926-27	1 25
17026X	Panel (body lock pillar) L. H.	1926-27	1 25
17029X	Panel (quarter corner) R. H.	1926-27	10
17030X	Panel (quarter corner) L. H.	1926-27	10
16052X	Pillar (body lock) R. H.	1926-27	4 00
16053X	Pillar (body lock) L. H.	1926-27	4 00
54085X	Pillar (coupe) assy.—R. H.	1926-27	5 00
54086X	Pillar (coupe) assy.—L. H.	1926-27	5 00
54212X	Pillar (body hinge) R. H.	1926-27	1 50
54213X	Pillar (body hinge) L. H.	1926-27	1 50
54214X	Pillar (quarter) R. H.	1926-27	1 00
54215X	Pillar (quarter) L. H.	1926-27	1 00
17113X	Plate (front door scuff) R. H.	1926-27	30
17114X	Plate (front door scuff) L. H.	1926-27	30
17115X	Plate (rear door scuff) R. H.	1926-27	30
17116X	Plate (rear door scuff) L. H.	1926-27	30
18920X	Plate (dome light switch escutcheon)	1926-27	02

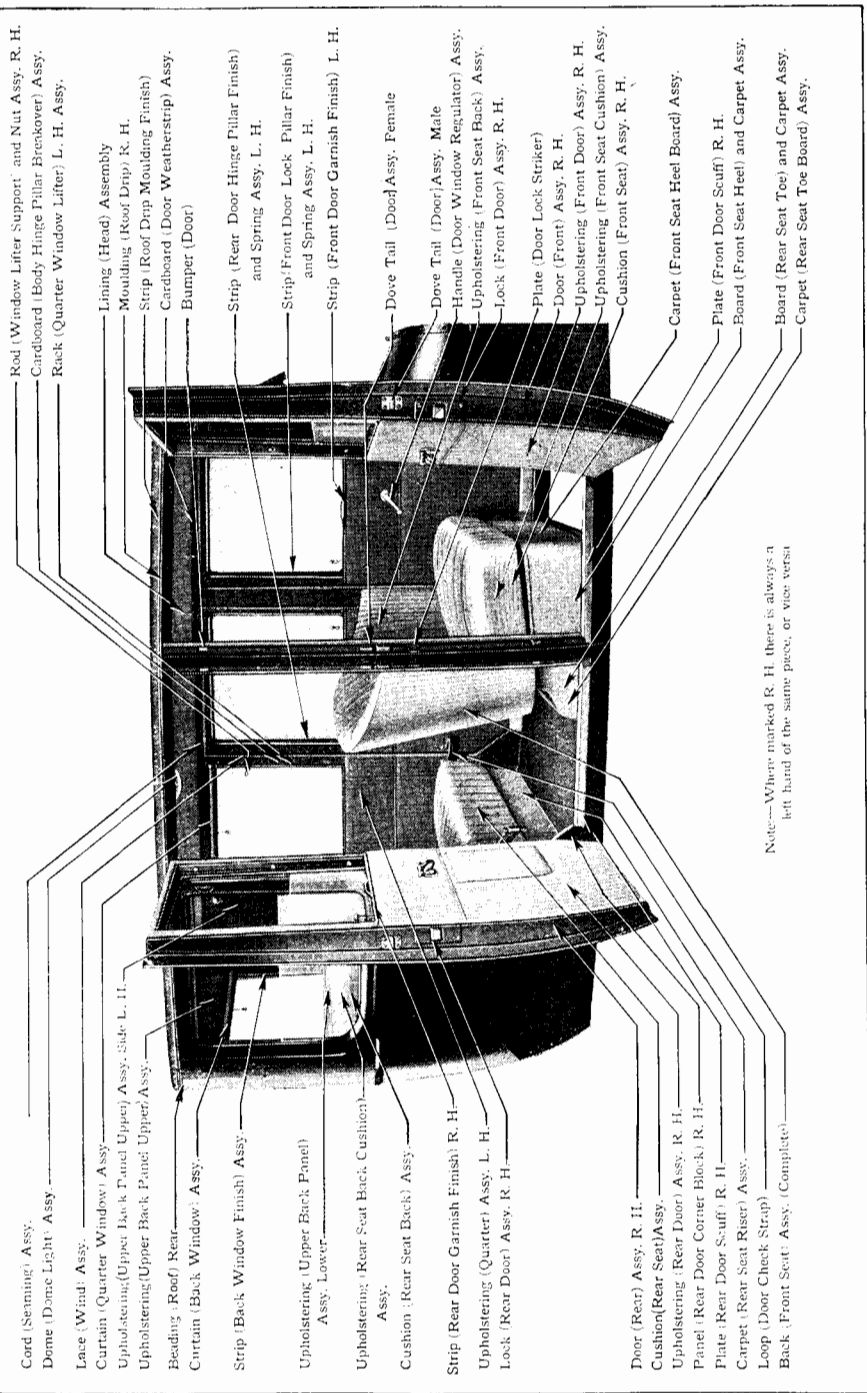

Part No.	NAME	YEAR	PRICE
FORDOR BODY PARTS—1926-27—Continued			
17490X	Plate (door lock striker)	1926-27	\$0 10
45213X	Plate (floor board No. 1 pedal)	1926-27	10
45218X	Plate (floor board No. 2 pedal)	1926-27	10
5088X	Plate (window lifter spring suspension)	1926-27	05
8170X	Plate (side lever floor board)	1926-27	10
17227BX	Plate (window regulator escutcheon)	1926-27	05
54424X	Quadrant (cowl ventilator)	1926-27	40
17111X	Rack (quarter window lifter) R. H.	1926-27	30
17112X	Rack (quarter window lifter) L. H.	1926-27	30
17127X	Rack (quarter window lifter) Assy.—R. H.	1926-27	75
17128X	Rack (quarter window lifter) Assy.—L. H.	1926-27	75
54203X	Rail (front belt)	1926-27	1 20
16166X	Rail (front seat trim)	1926-27	10
16075X	Rail (quarter belt) R. H.	1926-27	1 25
16076X	Rail (quarter belt) L. H.	1926-27	1 25
16260X	Rail (quarter belt) Assy.—R. H.	1926-27	1 75
16261X	Rail (quarter belt) Assy.—L. H.	1926-27	1 75
54268X	Rail (rear belt) Assy.	1926-27	3 00
54256X	Rail (roof) front	1926-27	1 75
54252X	Rail (roof) side R. H.	1926-27	3 00
54253X	Rail (roof) side L. H.	1926-27	3 00
16083X	Rail (roof) Assy.—rear	1926-27	5 50
18901BX	Reflector (dome light) Assy.	1926-27	65
17064X	Regulator (window) (see page 87)	1926	
54448X	Reinforcement (front seat heel board to toe board)	1926-27	15
	Reinforcement (rear door cor. trk. block to pillar) R. H.	1926-27	15
54449X	Reinforcement (rear door cor. trk. block to pillar) L. H.	1926-27	15
16097BX	Rest (quarter sash) Assy.—R. H.	1926-27	45
16098BX	Rest (quarter sash) Assy.—L. H.	1926-27	45
5105X	Retainer (quarter window run)	1926-27	10
17126X	Retainer (quarter window weatherstrip)	1926-27	15
19006X	Retainer (battery trap door)	1926-27	05
16120X	Rib (roof) No. 1	1926-27	30
16121X	Rib (roof) No. 2	1926-27	30
16122X	Rib (roof) No. 3	1926-27	30
16123X	Rib (roof) No. 4	1926-27	30
16124X	Rib (roof) No. 5	1926-27	30
54240X	Riser (front floor board) Assy.—R. H.	1926-27	1 00
54241X	Riser (front floor board) Assy.—L. H.	1926-27	1 00
16026X	Riser (rear seat) front	1926-27	1 75
54267X	Riser (rear seat) rear	1926-27	1 00
17145X	Rod (window lifter support) and nut Assy.—R. H.	1926-27	40
17146X	Rod (window lifter support) and nut Assy.—L. H.	1926-27	40
18811X	Run (window glass)	1926-27	40
9758A1X	Roller (quarter window curtain) Assy.	1926-27	1 25
9759A1X	Roller (back window curtain) Assy.	1926-27	90
18822X	Rubber (door dove tail)	1926-27	50
18452X	Run (front door window glass) hinge side—R. H.	1926-27	50
18453X	Run (front door window glass) lock side—L. H.	1926-27	50
18452X	Run (rear door window glass) lock side—R. H.	1926-27	50
18452X	Run (rear door window glass) hinge side—L. H.	1926-27	50
18453X	Run (front door window glass) lock side—R. H.	1926-27	50
18453X	Run (front door window glass) hinge side—L. H.	1926-27	50
18453X	Run (rear door window glass) lock side—L. H.	1926-27	50
18453X	Run (rear door window glass) hinge side—R. H.	1926-27	50
54266X	Sill (cross) center	1926-27	1 00
16003X	Sill (cross) front	1926-27	45
54219X	Sill (cross) rear	1926-27	1 50
45130X	Shield (pedal)	1926-27	15
54251X	Slat (roof frame) long	1926-27	25
16256X	Slat (roof frame) short	1926-27	20
8693X	Socket (rear seat back cushion frame)	1926-27	10
17077X	Spring (door dove tail)	1926-27	05
18220AX	Spring (front seat cushion) Assy.—R.	1926-27	1 50
18221AX	Spring (front seat cushion) Assy.—L.	1926-27	1 50
18222X	Spring (front seat back) Assy.	1926-27	1 25
17433AX	Spring (quarter window lifter counterbalance)	1926-27	10
18223AX	Spring (rear seat cushion) Assy.	1926-27	3 00
17046X	Spring (ventilator)	1926-27	10
16045X	Strainer (black panel) upper	1926-27	20
54216X	Strainer (black panel) lower	1926-27	45
18382X	Strap (door check) and loop Assy.	1926-27	20
17117X	Strip (back window finish) Assy.	1926-27	75
54068X	Strip (coupe pillar finish) R. H.	1926-27	75
54069X	Strip (coupe pillar finish) L. H.	1926-27	75
10240AX	Strip (door window glass retaining) (Used with thick glass)	1926-27	10
10240BX	Strip (door window glass retaining) (Used with thin glass)	1926-27	10

Part No.	NAME	YEAR	PRICE
FORDOR BODY PARTS—1926-27—Continued			
17106X	Strip (front door garnish finish) R. H.	1926-27	\$0 30
17105X	Strip (front door garnish finish) L. H.	1926-27	30
17242X	Strip (front door hinge pillar finish) and spring assy.—R. H.	1926-27	30
17243X	Strip (front door hinge pillar finish) and spring assy.—L. H.	1926-27	30
17244X	Strip (front door lock pillar finish) and spring assy.—L. H.	1926-27	30
17245X	Strip (front door lock pillar finish) and Spring assy.—R. H.	1926-27	30
16145BX	Strip (front seat trim) side	1926-27	20
16167X	Strip (front seat lower trim) outer	1926-27	30
16168X	Strip (front seat lower trim) corner fastener	1926-27	30
17102X	Strip (header finish)	1926-27	35
17103X	Strip (quarter garnish finish) R. H.	1926-27	15
17104X	Strip (quarter garnish finish) L. H.	1926-27	15
10239AX	Strip (quarter window glass retaining) thick	1926-27	10
10239BX	Strip (quarter window glass retaining) thin	1926-27	10
18850X	Strip (quarter window weather) and retainer assy.	1926-27	20
17105X	Strip (rear door garnish finish) R. H.	1926-27	30
17110X	Strip (quarter pillar finish) R.	1926-27	20
17140X	Strip (quarter pillar finish) L.	1926-27	20
54038X	Strip (windshield weather) lower	1926-27	25
54088X	Strip (windshield weather) side upper	1926-27	10
17106X	Strip (rear door garnish finish) L. H.	1926-27	30
17244X	Strip (rear door lock pillar finish) and spring assy.—R. H.	1926-27	30
17244X	Strip (rear door hinge pillar finish) and spring assy.—L. H.	1926-27	30
17245X	Strip (rear door hinge Pillar finish) and spring assy.—R. H.	1926-27	30
17245X	Strip (rear door lock pillar finish) and spring assy.—L. H.	1926-27	30
54208X	Strip (rear rocker trim) R. H.	1926-27	50
54209X	Strip (rear rocker trim) L. H.	1926-27	50
17125X	Strip (roof drip moulding finish)	1926-27	25
18819X	Strip (window header finish and weather) assy.	1926-27	45
54030X	Strip (windshield header finish)	1926-27	35
54061AX	Strip (windshield glass retaining) lower	1926-27	10
54061BX	Strip (windshield glass retaining) lower	1926-27	10
54062AX	Strip (windshield glass retaining) upper	1926-27	10
54062BX	Strip (windshield glass retaining) upper	1926-27	10
45055A2X	Support (steering column)	1926-27	20
54071X	Support (front floor board riser) R.	1926-27	35
54072X	Support (front floor board riser) L.	1926-27	35
54081X	Support (rear seat cushion frame) R.	1926-27	50
54082X	Support (rear seat cushion frame) L.	1926-27	50
18904BX	Switch (dome light) assy.	1926-27	35
18813X	Tubing (Windface)	1926-27	30 ft.
54603ARX	Upholstering (body hinge pillar) assy.—R. (gray-red)	1926	15
54603BX	Upholstering (body hinge pillar) assy.—R. (gray-white)	1927	15
54604ARX	Upholstering (body hinge pillar) assy.—L. (gray-red)	1926	15
54604BX	Upholstering (body hinge pillar) assy.—L. (gray-white)	1927	15
54605ARX	Upholstering (body lock pillar) assy. upper (gray-red)	1926	45
54605BX	Upholstering (body lock pillar) assy. upper (gray-white)	1927	45
54620ARX	Upholstering (door header) assy. (gray-red)	1926	30
54620BX	Upholstering (door header) assy. (gray-white)	1927	30
54614ARX	Upholstering (door lock pillar) assy. (gray-red)	1926	30
54614BX	Upholstering (door lock pillar) assy. (gray-white)	1927	30
54601ARX	Upholstering (door weatherstrip) assy. (gray-red)	1926	20
54601BX	Upholstering (door weatherstrip) assy. (gray-white)	1927	20
54613ARX	Upholstering (front door hinge pillar) assy. (gray-red)	1926	35
54613BX	Upholstering (front door hinge pillar) assy. (gray-white)	1927	35
54661ARX	Upholstering (front seat cushion) assy.—R. wide pleat (gray-red)	1926	3 75
54661BX	Upholstering (front seat cushion) assy.—R. wide pleat (gray-white)	1927	3 75
54564ARX	Upholstering (front seat cushion) assy.—R.—narrow pleat (gray-red)	1926	3 75
54564BX	Upholstering (front seat cushion) assy.—R.—narrow pleat (gray-white)	1927	3 75
54673ARX	Upholstering (front seat cushion) assy.—L.—wide pleat (gray-red)	1926	3 75

Part No.	NAME	YEAR	PRICE
FORDOR BODY PARTS—1926-27—Continued			
54673BX	Upholstering (front seat cushion) assy.—L.—wide pleat (gray-white)	1927	\$3 75
54565ARX	Upholstering (front seat cushion) assy.—L.—narrow pleat (gray-red)	1926	3 75
54565BX	Upholstering (front seat cushion) assy.—L.—narrow pleat (gray-white)	1927	3 75
54558ARX	Upholstering (front door) assy.—R. (gray-red)	1926	3 00
54558BX	Upholstering (front door) assy.—R. (gray-white)	1927	3 00
54559ARX	Upholstering (front door) assy.—L. (gray-red)	1926	3 00
54559BX	Upholstering (front door) assy.—L. (gray-white)	1927	3 00
54560ARX	Upholstering (rear door) assy.—R. with flap (gray-red)	1926	4 75
54560BRX	Upholstering (rear door) assy.—R. without flap (gray-red)	1926	4 75
54560CX	Upholstering (rear door) assy.—R. (gray-white)	1927	4 75
54561ARX	Upholstering (rear door) assy.—L. with flap (gray-red)	1926	4 75
54561BRX	Upholstering (rear door) assy.—L. without flap (gray-red)	1926	4 75
54561CX	Upholstering (rear door) assy.—L. (gray-white)	1927	4 75
54624ARX	Upholstering (rear door hinge pillar) assy. (gray-red)	1926	40
54624BX	Upholstering (rear door hinge pillar) assy. (gray-white)	1927	40
54698ARX	Upholstering (rear seat cushion) assy.—wide pleat (gray-red)	1926	6 50
54698BX	Upholstering (rear seat cushion) assy.—wide pleat (gray-white)	1927	6 50
54567ARX	Upholstering (rear seat cushion) assy.—narrow pleat (gray-red)	1926	6 50
54567BX	Upholstering (rear seat cushion) assy.—narrow pleat (gray-white)	1927	6 50
54651ARX	Upholstering (front seat back) assy.—wide pleat (gray-red)	1926	10 00
54651BX	Upholstering (front seat back) assy.—wide pleat (gray-white)	1927	10 00
54570ARX	Upholstering (front seat back) assy.—narrow pleat (gray-red)	1926	10 00
54570BX	Upholstering (front seat back) assy.—narrow pleat (gray-white)	1927	10 00
54691ARX	Upholstering (rear seat back cushion) assy.—wide pleat	1926	10 00
54691BX	Upholstering (rear seat back cushion) assy.—wide pleat (gray-white)	1927	10 00
54568ARX	Upholstering (rear seat back cushion) assy.—narrow pleat (gray-red)	1926	6 50
54568BX	Upholstering (rear seat back cushion) assy.—narrow pleat (gray-white)	1927	6 50
54607ARX	Upholstering (front seat back frame side) assy. (gray-red)	1926	25
54607BX	Upholstering (front seat back frame side) assy. (gray-white)	1927	25
54562ARX	Upholstering (quarter) assy.—R. (gray-red)	1926	2 25
54562BX	Upholstering (quarter) assy.—R. (gray-white)	1927	2 25
54563ARX	Upholstering (quarter) assy.—L. (gray-red)	1926	2 25
54563-BX	Upholstering (quarter) assy.—L. (gray-white)	1927	2 25
54539ARX	Upholstering (qtr. header trim) (gray-red)	1926	15
54539BX	Upholstering (qtr. header trim) (gray-white)	1927	15
54629ARX	Upholstering (upper back panel) assy.—side—R. (gray-red)	1926	1 00
54629BX	Upholstering (upper back panel) assy.—side—R. (gray-white)	1927	1 00
54630ARX	Upholstering (upper back panel) assy.—side—L. (gray-red)	1926	1 00
54630BX	Upholstering (upper back panel) assy.—side—L. (gray-white)	1927	1 00
54571ARX	Upholstering (upper back panel) assy.—lower (gray-red)	1926	35
54571BX	Upholstering (upper back panel) assy.—lower (gray-white)	1927	35
54529ARX	Upholstering (upper back panel) upper (gray-red)	1926	35
54529BX	Upholstering (upper back panel) upper (gray-white)	1927	35
54409ARX	Upholstering (windshield header) assy. (gray-red)	1926	40
54409BX	Upholstering (windshield header) assy. (gray-white)	1927	40
54412X	Visor assembly	1926-27	3 50
18179X	Wadding (roof)	1926-27	70
54053X	Windshield (lower half) assy.	1926-27	4 50
54052X	Windshield (upper half) assy.	1926-27	6 00
18911X	Wire (dome light switch to light) assy.	1926-27	15
18917X	Wire (dome light to ammeter) assy.	1926-27	30

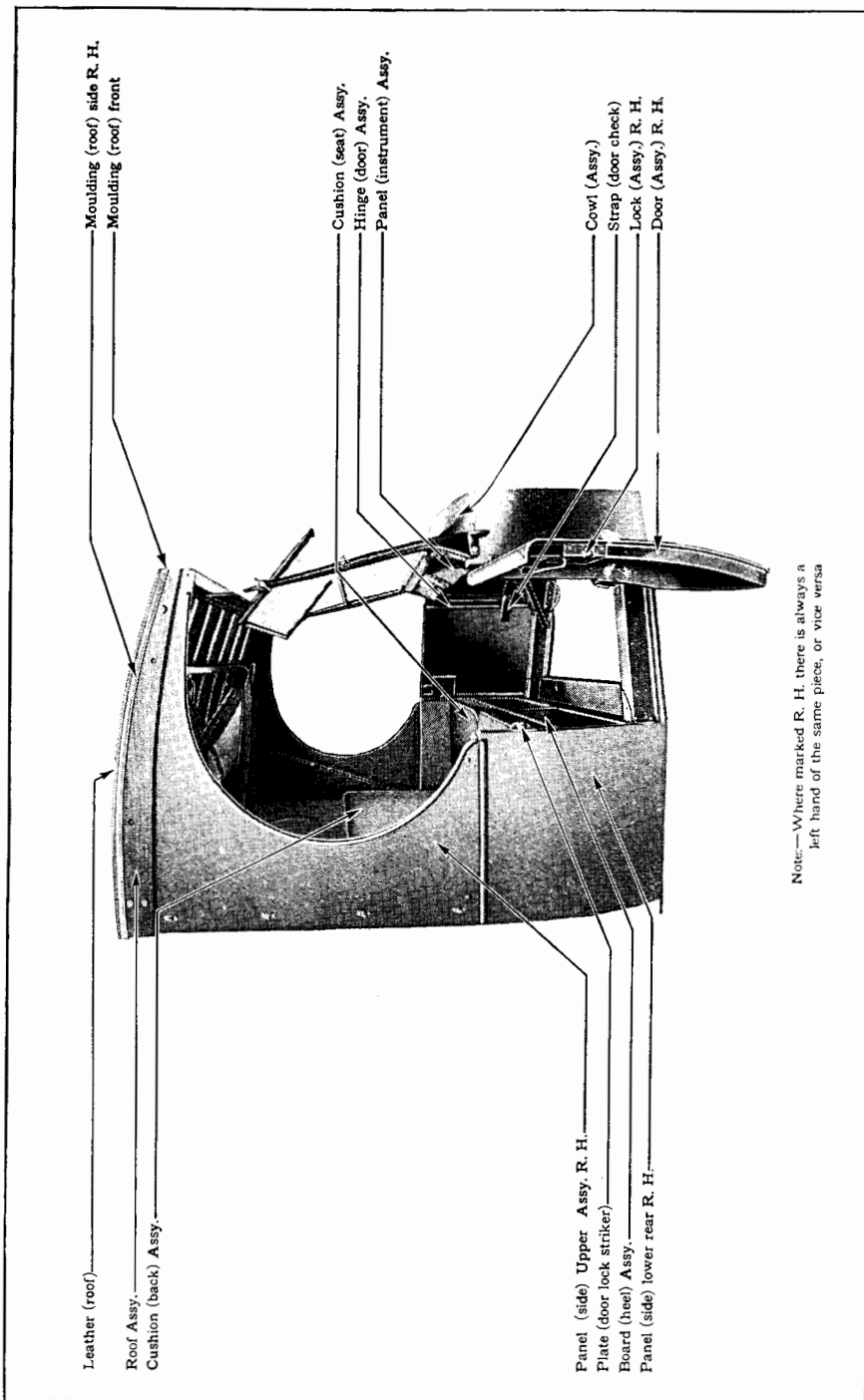

Note:—Where marked R. H. there is always a left hand of the same piece, or vice versa

Part No.	NAME	YEAR	PRICE
----------	------	------	-------

TRUCK OPEN CAB—1924-26

T- 9495BX	Board (floor and plate assy. No. 1)	1924-26	\$ 0 75
T- 9496BX	Board (floor and plate assy. No. 2)	1924-26	75
TT-12308X	Board (floor and plate assy. No. 3)	1924-26	1 00
TT-12279X	Board (heel) assy.	1924-26	4 00
TT-12242X	Brace (end sill corner) R. H.	1924-26	20
TT-12243X	Brace (end sill corner) L. H.	1924-26	20
TT-12272X	Bracket (roof frame) R. H.	1924-26	20
TT-12273X	Bracket (roof frame) L. H.	1924-26	20
TT-12244X	Bracket (body) front	1924-26	15
T- 8350CX	Cowl (assy.)	1924-26	3 00
TT-12339RX	Curtain (side) assy.—R. H.	1924-26	2 75
TT-12347X	Curtain (side) and rod assy.—R. H.	1924-26	3 50
TT-12340RX	Curtain (side) assy.—L. H.	1924-26	2 75
TT-12348X	Curtain (side) and rod assy.—L. H.	1924-26	3 50
TT-12325X	Cushion (seat) assy.	1924-26	3 00
TT-12344X	Cushion (back) assy.	1924-26	4 50
T- 2069BX	Cushion (steering column support)	1924-26	03
TT-12209X	Door (assy.) R. H. (painted)	1924-26	6 00
TT-12210X	Door (assy.) L. H. (painted)	1924-26	6 00
T- 8940X	Eyelet (curtain fastener)	1924-26	75C 01
T- 3510X	Eyelet (curtain)	1924-26	02
T- 8937X	Fastener (single snap)	1924-26	3 50C 05
TT-12253X	Frame (seat) side	1924-26	35
TT-12254X	Frame (seat) rear	1924-26	80
TT-12263X	Frame (side) assy.—R. H.	1924-26	18 00
TT-12264X	Frame (side) assy.—L. H.	1924-26	18 00
TT-12322X	Frame (roof) assy.	1924-26	7 50
TT-12365ARX	Glass (back window)	1924-26	90
TT-12365BX	Glass (back window)	1924-25	65
TT- 7827X	Glass (windshield) upper	1924-25	2 65
T- 9534X	Glass (windshield) lower	1924-25	2 35
TT-12215X	Hinge (door) assy.	1924-26	35
TT-12341X	Leather (roof)	1924-26	2 50
T- 5679ARX	Lock (assy.) L. H. (painted)	1924-26	25
T- 5680ARX	Lock (assy.) R. H. (painted)	1924-26	25
TT-12287X	Moulding (roof)—front	1924-26	30
TT-12201RX	Panel (side) front—R. H.	1924-26	1 00
TT-12202RX	Panel (side) front—L. H.	1924-26	1 00
TT-12203RX	Panel (side) lower rear—R. H.	1924-26	1 00
TT-12204RX	Panel (side) lower rear—L. H.	1924-26	1 00
TT-12208RX	Panel (back) upper	1924-26	3 25
TT-12270RX	Panel (side) upper assy.—R. H.	1924-26	3 50
TT-12271RX	Panel (side) upper assy.—L. H.	1924-26	3 50
TT-12262RX	Panel (back) lower and end sill assy.	1924-26	7 50
TT-12293RX	Panel (seat) R. H.	1924-26	55
TT-12294RX	Panel (seat) L. H.	1924-26	55
T- 6609RX	Panel (instrument) assy.	1924-26	1 25
T- 8170X	Plate (hand brake lever)	1924-26	10
T- 8433X	Plate (door lock striker)	1924-26	20
TT-12480RX	Rail (roof) front	1924-26	75
TT-12313RX	Rail (roof) side—R. H.	1924-26	75
TT-12314RX	Rail (roof) side—L. H.	1924-26	75
TT-12320RX	Rail (roof) rear	1924-26	1 25
TT-12491RX	Rib (roof) No. 1	1924-26	40
TT-12492RX	Rib (roof) No. 2	1924-26	40
TT-12493RX	Rib (roof) No. 3	1924-26	40
TT-12349RX	Roof assy.	1924-26	15 00
*TT-12291ARX	Rod (side curtain) R. H.	1924	50
*TT-12292ARX	Rod (side curtain) L. H.	1924	50
TT-12321RX	Slat (roof)	1924-26	10
TT-12278RX	Spring (seat cushion)	1924-26	1 50
T- 5515X	Strap (door check)	1924-26	10
T- 7655RX	Support (steering column) upper—steel	1924-26	20
T- 7656X	Support (steering column) lower—steel	1924-26	10
TT-12335X	Upholstering (seat cushion) assy.	1924-26	2 75
TT-12336X	Upholstering (seat back cushion) assy.	1924-26	3 75
TT-12350RX	Visor (assy.)	1924-26	45
TT-7822X	Windshield (upper) assy.	1924-25	4 20
T-7823BX	Windshield (lower) assy.	1924-25	3 75
TT-7840X	Windshield assy.	1924-25	10 25

TRUCK CLOSED CAB—1925-27

T-17316ARX	Arm (windshield swing)	1925-26	50
T-50214X	Arm (windshield swing)	1926-27	45
TT-12676X	Bar (seat cushion)	1925-26	30
T-8169X	Board (floor) No. 3 and plate assy.	1925-27	1 70
T-9495BX	Board (floor) No. 1 and plate assy.	1925-27	75

*Rods for 1925-26 curtains furnished assembled to curtains.

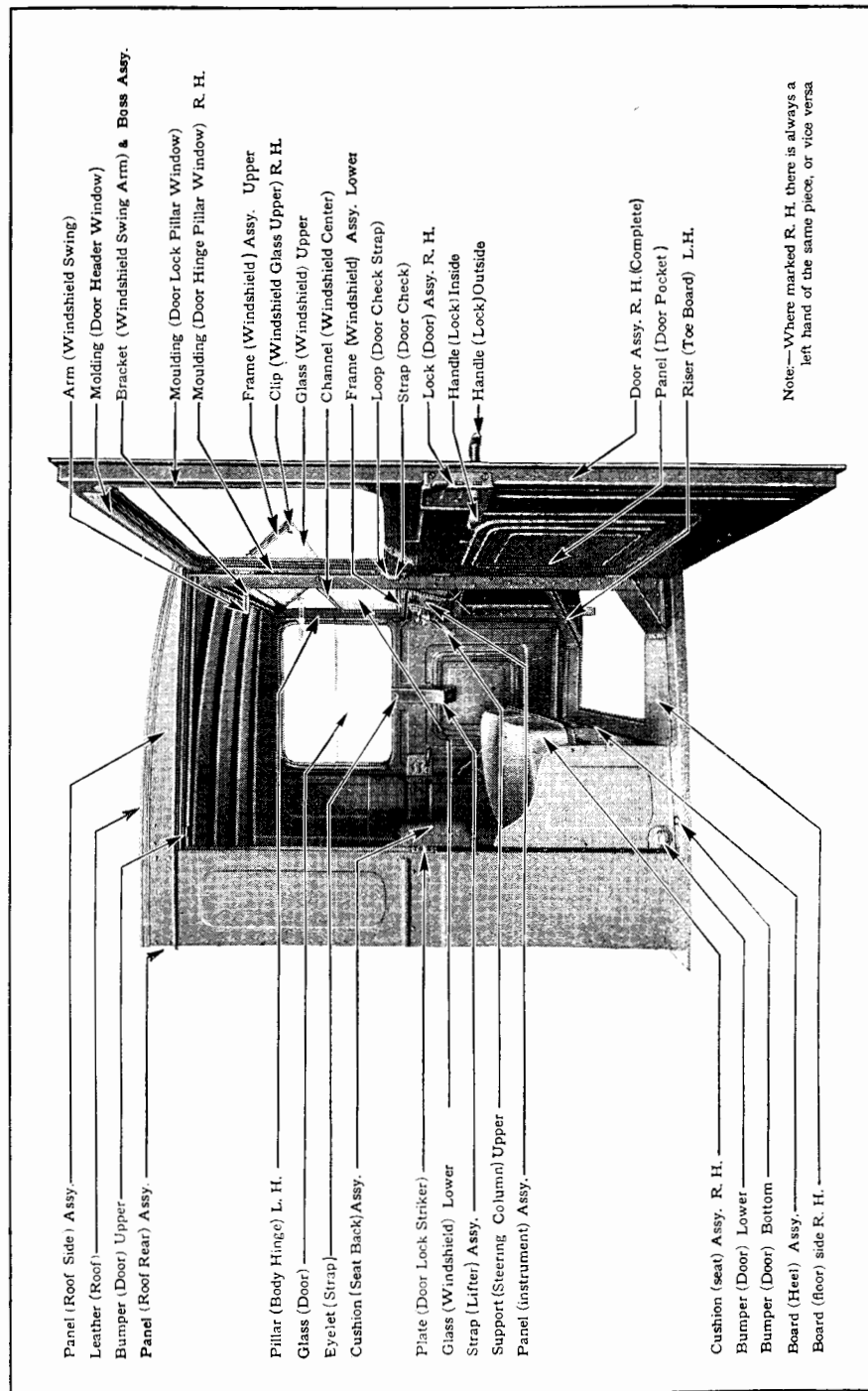

Part No.	NAME	YEAR	PRICE
TRUCK CLOSED CAB—1925-27—Continued			
T-9496BX	Board (floor) No. 2 and plate Assy.	1925-27	\$0 75
TT13119 X	Board (heel) Assy.	1925-27	2 00
TT12542X	Board (side floor) R. H.	1925-27	45
TT12543X	Board (side floor) L. H.	1925-27	45
TT12506X	Bracket (body) front—R. H.	1925-27	25
TT12513X	Bracket (body) front—L. H.	1925-27	25
T-50216X	Bracket (windshield swing arm) and boss Assy.	1925-27	20
TT12583X	Bumper (door) upper	1925-27	05
TT12584X	Bumper (door) lower	1925-27	05
TT13107X	Bumper (door) bottom	1925-27	05
TT12674X	Cardboard (seat back cushion)	1925-27	15
TT12660X	Channel (back window glass)	1925-27	15
TT12620X	Channel (door glass)	1925-27	30
T-9066X	Channel (windshield center)	1925-27	35
TT12684X	Clip (windshield glass) upper—R. H.	1925-27	05
TT12685X	Clip (windshield glass) upper—L. H.	1925-27	05
TT12653X	Clip (windshield lower glass)	1925-27	03
T-17048X	Cover (ventilator) Assy.	1925-27	75
TT13011X	Cushion (seat) Assy.—R. H.	1925-27	3 50
TT13012X	Cushion (seat) Assy.—L. H.	1925-27	3 50
TT13010X	Cushion (seat back) Assy.	1925-27	4 25
T-2069BX	Cushion (steering column support)	1925-27	03
T-9462X	Cushion (window)	1925-27	03
TT12590X	Door Assy.—R. H. (complete) (painted)	1925-27	20 00
TT12694X	Door Assy.—R. H. (less glass)	1925-27	15 00
TT12591X	Door Assy.—L. H. (complete) (painted)	1925-27	20 00
TT12695X	Door Assy.—L. H. (less glass)	1925-27	15 00
TT12626X	Eyelet (strap)	1925-27	02
T-17802X	Fastener (door glass run) lower	1925-27	02
TT12633X	Fastener (door glass run) upper	1925-27	01
T-10419X	Fastener (carpet) female	1925-27	05
TT12661X	Ferrule (door lock grip)	1925-27	05
TT12658X	Frame (back window)	1925-27	65
TT12659X	Glass (back window)	1925-27	65
TT12617X	Glass (door)	1925-27	3 90
TT12616X	Glass (door window) and channel Assy.	1925-27	5 00
T-9534X	Glass (windshield) upper and lower	1925-27	2 35
TT12628X	Handle (lock) outside	1925-27	45
TT12629X	Handle (lock) inside	1925-27	25
T-17044X	Handle (ventilator)	1925-27	10
TT12676X	Hinge (cushion) bar Assy.	1925-27	30
TT12608X	Hinge (door) Assy.—R. H.	1925-27	15
TT12609X	Hinge (door) Assy.—L. H.	1925-27	15
TT12666X	Leather (roof)	1925-27	3 00
TT13130X	Lock (door) Assy.—R. H.	1925-27	50
TT13131X	Lock (door) Assy.—L. H.	1925-27	50
T-17347X	Loop (door check strap)	1925-27	03
TT-12677BX	Mat (floor)	1925-27	1 50
TT-12697X	Mat (floor) and foot pedal wind protector Assy.	1925-27	2 00
TT12610X	Moulding (door header window)	1925-27	20
TT12611X	Moulding (door hinge pillar window) R. H.	1925-27	15
TT12612X	Moulding (door hinge pillar window) L. H.	1925-27	15
TT12613X	Moulding (door lock pillar window)	1925-27	15
TT12551X	Panel (back center)	1925-27	1 50
TT12558X	Panel (back lower)	1925-27	90
TT12559X	Panel (back upper)	1925-27	2 00
TT12518X	Panel (cowl top) and windshield lower panel Assy.	1925-27	4 25
TT12596X	Panel (door pocket)	1925-27	30
TT12691X	Panel (instrument) Assy.	1925-27	1 75
TT12571X	Panel (roof rear) Assy.	1925-27	1 50
TT12574X	Panel (roof front) Assy. and windshield header	1925-27	2 25
TT12579X	Panel (roof side) R. H.	1925-27	65
TT12580X	Panel (roof side) L. H.	1925-27	65
TT12566X	Panel (tool box side) R. H.	1925-27	1 20
TT12567X	Panel (tool box side) L. H.	1925-27	1 20
TT12568X	Panel (tool box center)	1925-27	1 25
TT12511X	Pillar (body hinge) R. H.	1925-27	1 00
TT12512X	Pillar (body hinge) L. H.	1925-27	1 00
TT12621X	Pin (door glass channel)	1925-27	01
T-9654RX	Pin (door hinge)	1925-26	03
TT12569X	Plate (door lock striker)	1925-27	10
T-1400CRX	Plate (floor board No. 1 pedal)	1925	10
T-1095CRX	Plate (floor board No. 2 pedal)	1925	10
T-45213	Plate (floor board No. 1 pedal)	1926-27	10
T-45218	Plate (floor board No. 2 pedal)	1926-27	10
T-8170X	Plate (slide lever floor board)	1925-27	10
TT13115X	Quadrant (ventilator)	1925-27	20
TT12667X	Rib (roof)	1925-27	15
TT12523X	Riser (toe board) R. H.	1925-27	70
TT12692X	Riser (seat) R. H. Assy.	1925-27	80
TT12524X	Riser (toe board) L. H.	1925-27	1 70

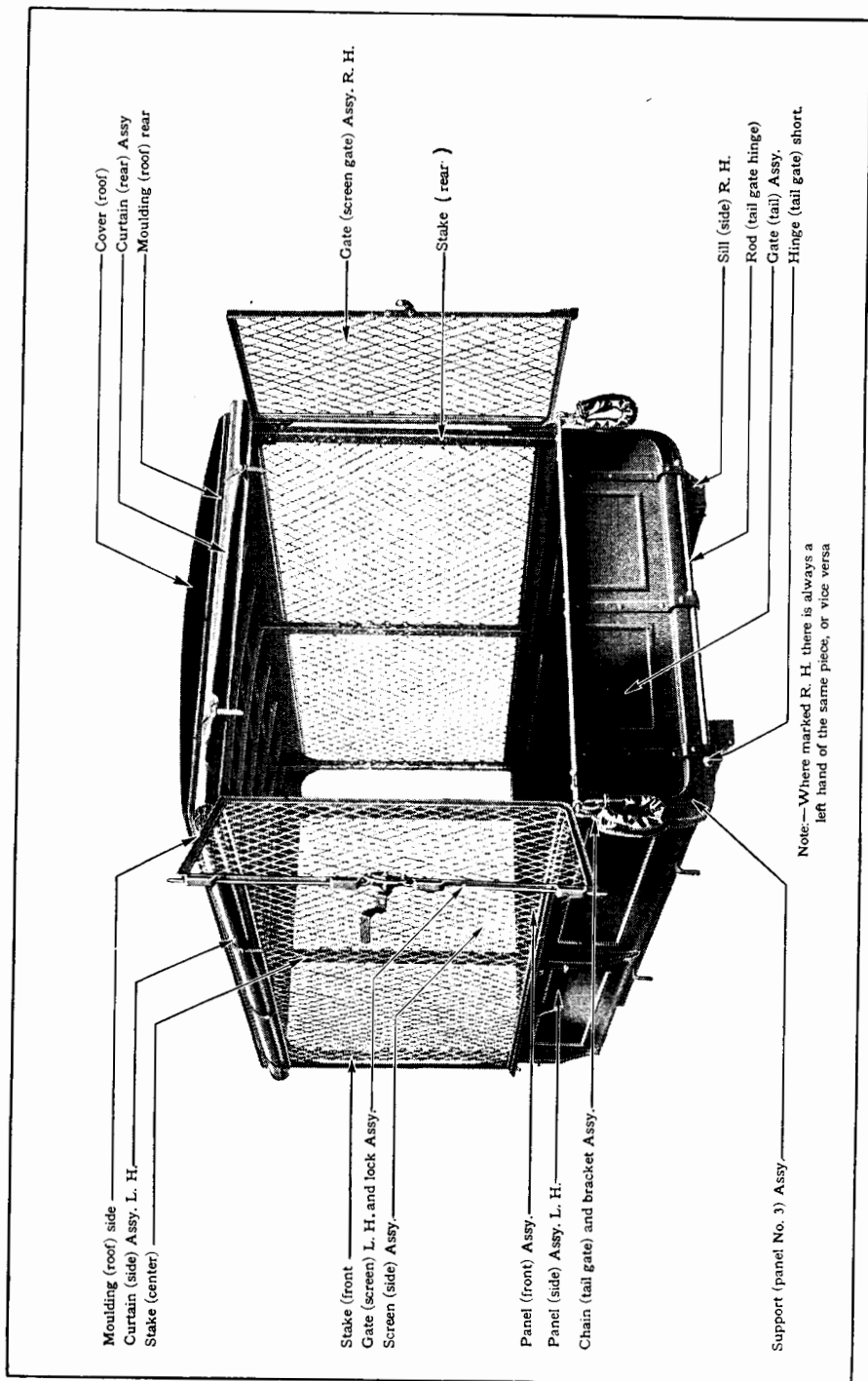

Part No.	NAME	YEAR	PRICE
----------	------	------	-------

TRUCK CLOSED CAB—1925-27—Continued

TT12693X	Riser (seat) L. H. assy.	1925-27	\$0 30
TT12618X	Run (door glass) assy.	1925-27	45
T-1096RX	Shield (pedal plate)	1925-26	1 35X
TT12600X	Side assy.—R. H.	1925-27	*20 00
TT12601X	Side assy.—L. H.	1925-27	*20 00
TT12507X	Sill (cross) rear	1925-27	1 25
TT12675X	Spacer (front body bracket)	1925-27	1 05
TT12688X	Spring (seat back cushion)	1925-27	2 25
TT12686X	Spring (seat cushion) R. H.	1925-27	1 75
TT12687X	Spring (seat cushion) L. H.	1925-27	1 75
TT13123X	Spring (ventilator)	1925-27	05
TT12615X	Strap (door check)	1925-27	15
TT12624X	Strap (lifter) assy.	1925-27	30
T-18503RX	Strip (door glass header weather)	1925-26	05
T-18507AX	Strip (door window glass retaining)	1925-27	10
T-18507BX	Strip (door window glass retaining)	1925-27	10
TT12670X	Strip (roof trim) rear	1925-27	15
TT12671X	Strip (roof trim) front	1925-27	15
TT12668X	Strip (roof trim) side—R. H.	1925-27	15
TT12669X	Strip (roof trim) side—L. H.	1925-27	15
T-17315AX	Strip (windshield glass retaining)	1925-27	15
T-17315BX	Strip (windshield glass retaining)	1925-27	15
TT12586X	Strip (windshield weather) lower	1925-27	15
TT12614X	Strip (windshield weather) upper	1925-27	05
TT12657X	Support (steering column) upper	1925-27	25
T-7656X	Support (steering column) lower	1925-27	10
TT12646X	Windshield (upper) frame assy.	1925-27	2 00
TT12647X	Windshield (lower) frame assy.	1925-27	1 50
TT-13142X	Windshield (upper) assy.	1925-27	5 70
TT-13143X	Windshield (lower) assy.	1925-27	4 60

TRUCK EXPRESS BODY—1924-27

TT-12028X	Board (floor) center	1924-27	1 50
TT-12029X	Board (floor) side—R. H.	1924-27	1 50
TT-12030X	Board (floor) side—L. H.	1924-27	1 50
TT-12045X	Board (floor) intermediate—R. H.	1924-27	1 50
TT-12046X	Board (floor) intermediate—L. H.	1924-27	1 50
TT-12039X	Chain (tail gate) and bracket assy.	1924-27	7 00
TT-12011X	Gate (tail) assy.	1924-27	8 00
TT-12006X	Hinge (tail gate) short	1924-27	30
TT-12054X	Panel (side) assy.—R. H.	1924-27	15 00
TT-12055X	Panel (side) assy.—L. H.	1924-27	15 00
TT-12056X	Panel (front) assy.	1924-27	5 50
TT-12047X	Plate (body to frame) long	1924-27	15
TT-12048X	Plate (body to frame) short	1924-27	10
TT-12007X	Retainer (floor board) rear	1924-27	1 25
TT-12012X	Retainer (floor board) R. H.	1924-27	75
TT-12013X	Retainer (floor board) L. H.	1924-27	75
TT-12010X	Rod (tail gate hinge)	1924-27	60
TT-12031X	Sill (side) R. H.	1924-27	3 50
TT-12032X	Sill (side) L. H.	1924-27	3 50
TT-12033X	Sill (cross) front	1924-27	1 25
TT-12008X	Sill (cross) rear	1924-27	1 50
TT-12042X	Strip (floor) side	1924-27	75
TT-12014X	Strip (floor) center	1924-27	75
TT-12009X	Support (panel No. 3) assy.	1924-27	6 00

TRUCK CANOPY ROOF & SCREENS—1924-26

TT-12442RX	Bracket (roof) rear R. H. and front L. H.	1924-26	25
TT-12443RX	Bracket (roof) rear L. H. and front R. H.	1924-26	25
TT-12465RX	Cover (roof)	1924-26	4 00
TT-12452RX	Curtain (side) assy.—R. H.	1924-26	7 00
TT-12453RX	Curtain (side) assy.—L. H.	1924-26	7 00
TT-12463RX	Curtain (rear) assy.	1924-26	4 00
T-8940X	Eyelet (curtain fastener)	1924-26	01
T-8937X	Fastener (single snap)	1924-26	3 50C
TT-12475RX	Frame (roof) assy.	1924-26	05
TT-12404X	Gate (screen gate) assy.—R. H.	1924-26	13 50
TT-12406X	Gate (screen) L. H. and lock assy.	1924-26	6 00
TT-12420RX	Hinge (screen gate) upper assy.—R. H.	1924-26	60
TT-12423RX	Hinge (screen gate) lower assy.—L. H.	1924-26	60
TT-12421RX	Hinge (screen gate) lower assy.—R. H.	1924-26	60
TT-12422RX	Hinge (screen gate) upper assy.—L. H.	1924-26	60
TT-12402RX	Lever (screen gate lock) and shaft assy.	1924-26	85
TT-12287X	Moulding (roof) rear	1924-26	80
TT-12449X	Moulding (roof) side	1924-26	85
TT-12494RX	Rib (roof)	1924-26	80

*Not subject to regular discount.

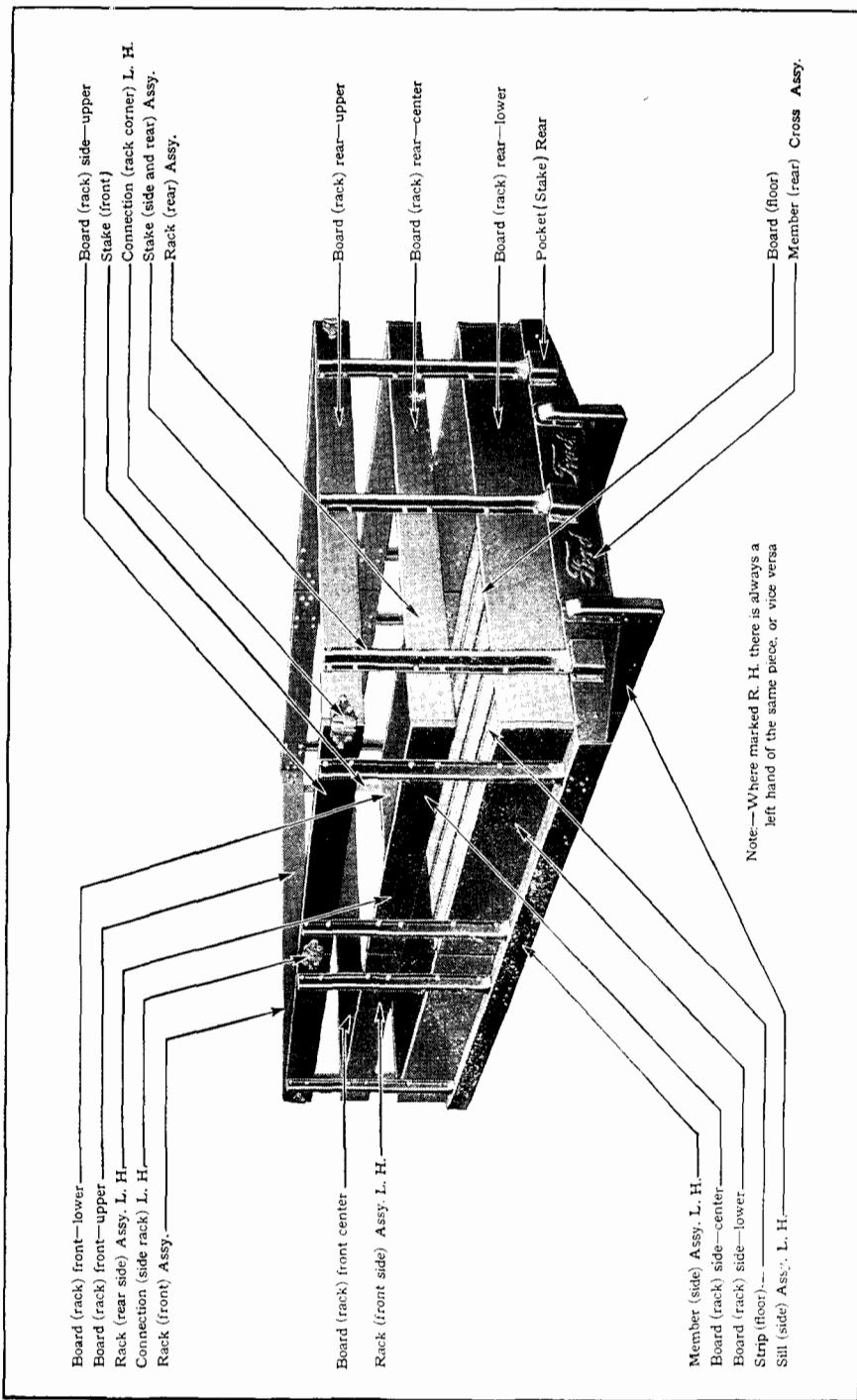

Part No.	NAME	YEAR	PRICE
----------	------	------	-------

TRUCK CANOPY ROOF & SCREENS—1924-26—Continued

TT-12401RX	Screen (side) assy.	1924-26	\$ 8 00
TT-12484RX	Slat (roof)	1924-26	45
TT-12488RX	Stake (center)	1924-26	55
TT-12490RX	Stake (front and rear)	1924-26	55
TT-12379RX	Strip (roof joint weather)	1924-26	20

TRUCK STAKE BODY—1925-27

TT-12722X	Angle (side sill to cross member) R. H.	1925-27	10
TT-12723X	Angle (side sill to cross member) L. H.	1925-27	10
TT-12740X	Board (floor) center	1925-27	2 50
TT-12741X	Board (floor) side—R. H.	1925-27	2 50
TT-12742X	Board (floor) side—L. H.	1925-27	2 50
TT-12744X	Board (rack) side—lower	1925-27	70
TT-12745X	Board (rack) side—center	1925-27	45
TT-12746X	Board (rack) side—upper	1925-27	45
TT-12747ARX	Board (rack) rear—lower	1925	70
TT-12747BX	Board (rack) rear—lower	1926-27	70
TT-12748ARX	Board (rack) rear—center	1925	45
TT-12748BX	Board (rack) rear—center	1926-27	45
TT-12749ARX	Board (rack) rear—upper	1925	45
TT-12749BX	Board (rack) rear—upper	1926-27	45
TT-12750ARX	Board (rack) front—lower	1925	70
TT-12750BX	Board (rack) front—lower	1926-27	70
TT-12751ARX	Board (rack) front—center	1925	45
TT-12751BX	Board (rack) front—center	1926-27	45
TT-12752ARX	Board (rack) front—upper	1925	70
TT-12752BX	Board (rack) front—upper	1926-27	70
TT-12726X	Bracket (body) front	1925-27	15
TT-12733X	Connection (side rack)—R. H.	1925-27	15
TT-12734X	Connection (side rack)—L. H.	1925-27	15
TT-12735X	Connection (rack corner)—R. H.	1925-27	15
TT-12736X	Connection (rack corner)—L. H.	1925-27	15
TT-12743X	Filler (side sill)	1925-27	1 75
TT-12701X	Member (side) assy.—R. H.	1925-27	4 25
TT-12702X	Member (side) assy.—L. H.	1925-27	4 25
TT-12703ARX	Member (rear) assy.	1925	7 00
TT-12737ARX	Member (front cross) assy.	1925	2 75
TT-12738ARX	Member (cross) intermediate assy.	1925	2 00
TT-12727X	Pocket (stake) front	1925-27	15
TT-12728X	Pocket (stake) rear	1925-27	25
TT-12732X	Pocket (stake) side	1925-27	20
TT-12721X	Reinforcement (cross member rear to side sill)	1925-27	30
TT-12724X	Reinforcement (corner)	1925-27	10
TT-12753AX	Rack (front) assy.	1925-26	3 75
TT-12753BX	Rack (front) assy.	1926-27	3 75
TT-12754AX	Rack (rear) assy.	1925-26	5 25
TT-12754BX	Rack (rear) assy.	1926-27	5 25
TT-12755X	Rack (front side) assy.—R. H.	1925-27	4 00
TT-12756X	Rack (front side) assy.—L. H.	1925-27	4 00
TT-12760X	Rack (rear side) assy.—R. H.	1925-27	4 00
TT-12761X	Rack (rear side) assy.—L. H.	1925-27	4 00
TT-12706X	Sill (side) assy.—R. H.	1925 7	2 75
TT-12707X	Sill (side) assy.—L. H.	1925 7	2 75
TT-12708X	Sill (front) assy.	1925-27	1 75
TT-12705X	Stake (side and rear) assy.	1925-27	70
TT-12719ARX	Stake (front)	1925	45
TT-12719BX	Stake (front) assy.	1926-27	45
TT-12731X	Strip (floor)	1925-27	50
TT-12717AX	Support (floor board)	1925-26	75
TT-12717BX	Support (floor board)	1926-27	75

PICK-UP BODY—1925-27

6155X	Bar (tail gate)	1925-27	50
6175RX	Board (floor) R. H.	1925	90
48819X	Board (floor) R. H.	1925-27	1 00
6181RX	Board (floor) L. H.	1925	90
48820X	Board (floor) L. H.	1926-27	1 00
6179RX	Board (floor) center	1925	80
48823X	Board (floor) center front	1926-27	25
48822X	Board (floor) center—rear	1926-27	50
6176RX	Board (floor) intermediate—L. H.	1925	1 00
48821X	Board (floor) intermediate—R. H.	1926-27	1 00
6180RX	Board (floor) intermediate—L. H.	1925	60
48824X	Board (floor) intermediate—L. H.	1926-27	60
48825X	Bracket (tail gate hinge) R.	1926-27	10
48826X	Bracket (tail gate hinge) L.	1926-27	10
6157X	Chain (tail gate) and bracket assy.	1925-27	60
48832X	Cleat (floor board)	1926-27	25

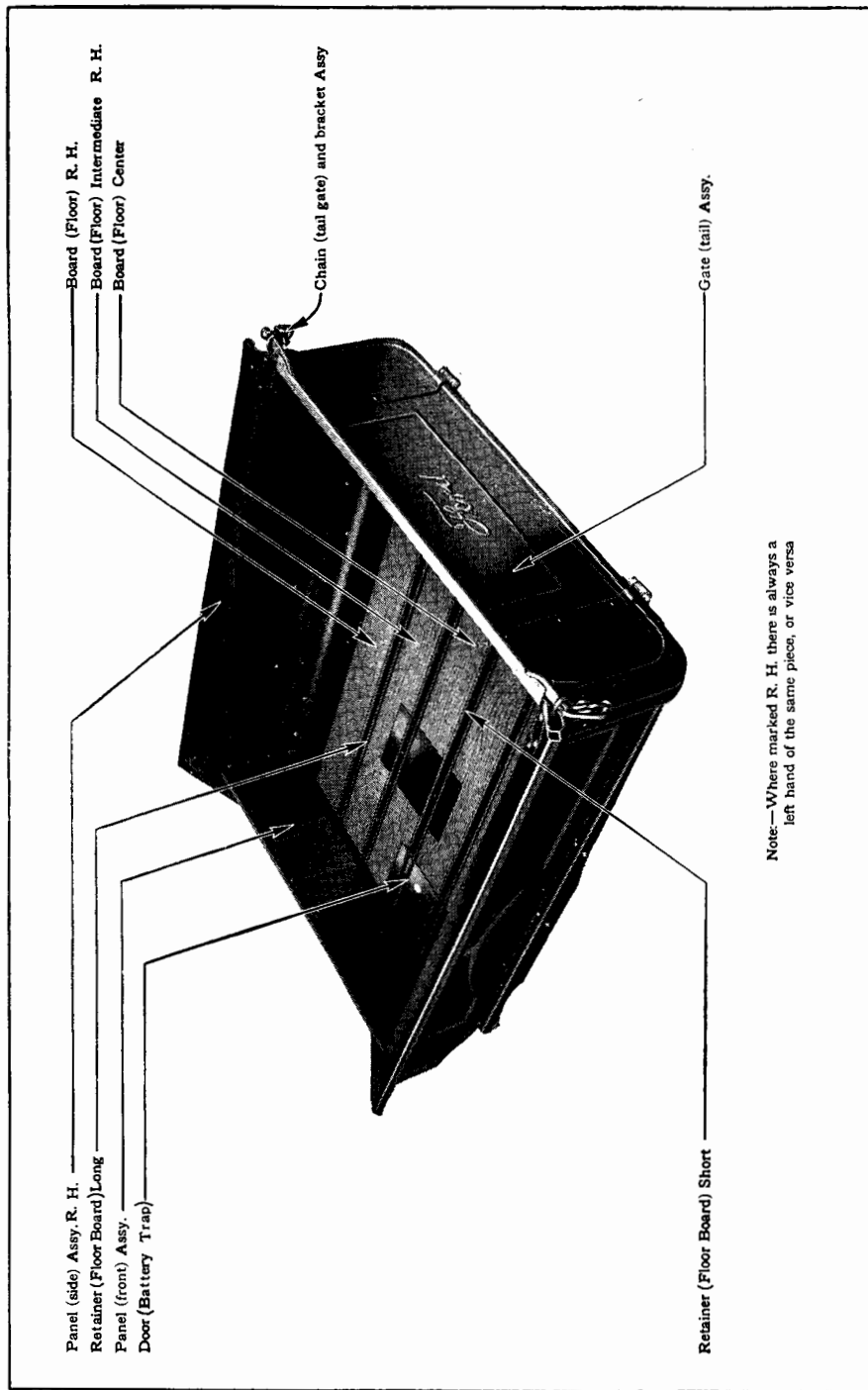

Part No.	NAME	YEAR	PRICE
PICK-UP BODY PARTS—1925-27—Continued			
6174X	Door (battery trap)	1925-27	\$0 65
6173X	Filler (side panel support—rear)	1925-27	50
6184X	Gate (tail) assembly	1925-27	4 00
48815X	Housing (rear cross member)	1926-27	75
6206RX	Panel (front) Assy.	1925	4 00
48827X	Panel (front) Assy.	1926-27	4 00
6203RX	Panel (side) R. H. Assy.	1925	7 00
48828X	Panel (side) R. H. Assy.	1926-27	7 00
6204RX	Panel (side) L. H. Assy.	1925	7 00
48829X	Panel (side) L. H. Assy.	1926-27	7 00
6171X	Retainer (floor board) long	1925-27	40
6172RX	Retainer (floor board) short	1925	35
48816X	Retainer (floor board) short	1926-27	35
48817X	Retainer (floor board center) short	1926-27	25
48818X	Retainer (floor board center) long	1926-27	25
6168X	Support (rear floor board)	1925-27	50
6207RX	Support (side panel) Assy. rear	1925	3 50
48836X	Support (side panel) Assy. rear	1926	3 00

List showing where various types of Window Regulators are used in Ford Closed Bodies

Type of Regulators	COUPE—1924-27	Used With
*17200-CX & DX	18034A1X	Door R.—Wood Frame
*17201-EX, FX, GX & HX	18033A2X	Door R.—Steel
*17200-DX & 17201-CX	18034A1X	Door L.—Wood Frame
*17200-EX, FX, GX & HX	18034A2X	Door L.—Steel
50400	50345X	Door R.—Steel
50401	50346X	Door L.—Steel

TUDOR—1924-27

†17200-BX	18538A1X	Door R.—Wood Frame
†*17201-EX & IX	18538A2X	Door R.—Steel
‡17201-BX	18539A1X	Door L.—Wood Frame
†*17200-EX & IX	18539A2X	Door L.—Steel
‡50400-X	50345X	Door R.—Steel
‡50401-X	50346X	Door L.—Steel

FORDOR—1923-27

*17200-AX & BX	18035X	Door Frt. R.—Wood Frame—brown uph.
*17201-AX & BX	18036X	Door Frt. L.—Wood Frame—brown uph.
*17201-AX & BX	18037X	Door Rear R.—Wood Frame—brown uph.
*17200-AX & BX	18038X	Door Rear L.—Wood Frame—brown uph.
*17200-AX & BX	18373A2X	Door Frt. R.—Wood Frame—blue uph.
*17201-AX & BX	18374A2X	Door Frt. L.—Wood Frame—blue uph.
*17201-AX & BX	18375A2X	Door Rear R.—Wood Frame—blue uph.
*17200-AX & BX	18376A2X	Door Rear L.—Wood Frame—blue uph.
*17201-EX, FX, GX & HX	18373A3X	Door Frt. R.—Steel—blue uph.
*17200-EX, FX, GX & HX	18374A3X	Door Frt. L.—Steel—blue uph.
*17200-EX, FX, GX & HX	18375A3X	Door Rear R.—Steel—blue uph.
*17201-EX, FX, GX & HX	18376A3X	Door Rear L.—Steel—blue uph.
*17201-EX, FX, GX & HX	54271X	Door Frt. R.—Steel—brown uph.
*17200-EX, FX, GX & HX	54272X	Door Frt. L.—Steel—brown uph.
*17200-EX, FX, GX & HX	54273X	Door Rear R.—Steel—brown uph.
*17201-EX, FX, GX & HX	54274X	Door Rear L.—Steel—brown uph.

Following are list prices of above Regulators:

17200BX	\$2.50	17201BX	\$2.50
17200DX	2.50	17201GX	1.50
17200GX	1.50	50401X	1.25
50400X	1.25		

*17200-AX, 17201-AX, 17200-CX and 17201-CX are obsolete and replaced by 17200-DX. When using the "DX" Type regulator to replace the "AX" or "CX" type, also replace the lock board. 17200-EX, FX, HX, IX and 17201-EX, FX, HX, IX are obsolete and replaced by 17200-GX and 17201-GX.

†Also used for Tudor quarter window left.

‡Also used for Tudor quarter window right.

NOTE—Wood frame doors listed above are no longer supplied. It is, therefore, necessary to use steel doors when replacement doors are required.

