



A8

Audi A8

Audi
Truth in Engineering 

If it was this easy, it wouldn't be an Audi.



IMAGINE DEVOTING YOUR LIFE TO BUILDING YOUR MODEL.

When you were a kid, you probably felt quite proud when you completed a model kit. We understand. At Audi, it takes countless hours for a single Audi to go from idea to design to roadworthy, and that's time we are very proud to devote. Our obsession for detail, commit-

ment to premium fit and finish and passion for unparalleled engineering go into every model. It's the kind of discipline that the word "painstaking" was invented to describe. Not to say it's a chore—no, assembling an Audi is a labor of love, and it shows every time you sit in one, engage the ignition and nudge the accelerator. Creating an Audi isn't easy, but the results help define what Audi means to the people who drive one.



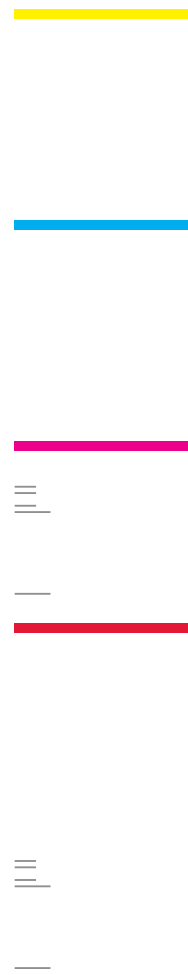
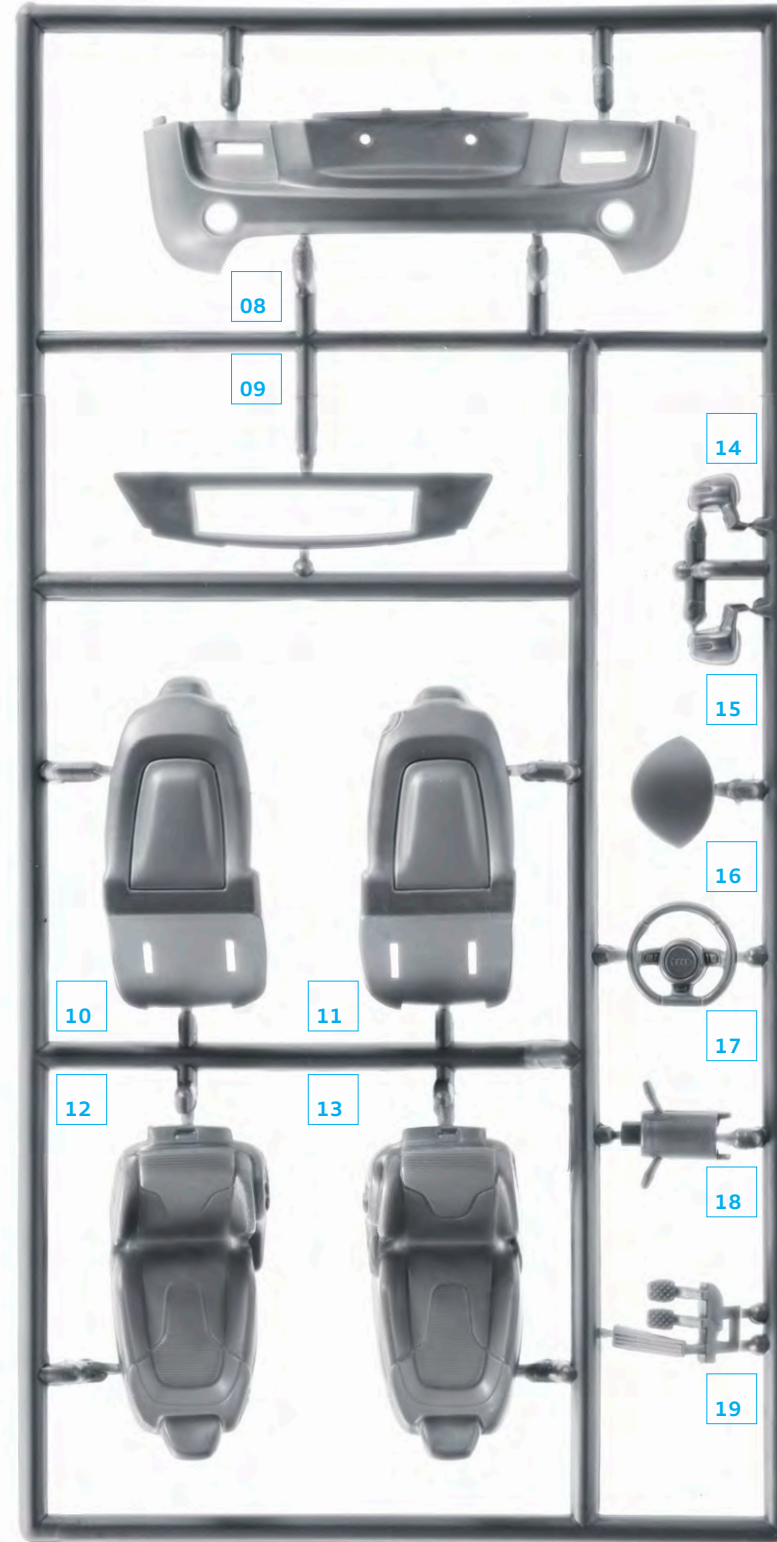
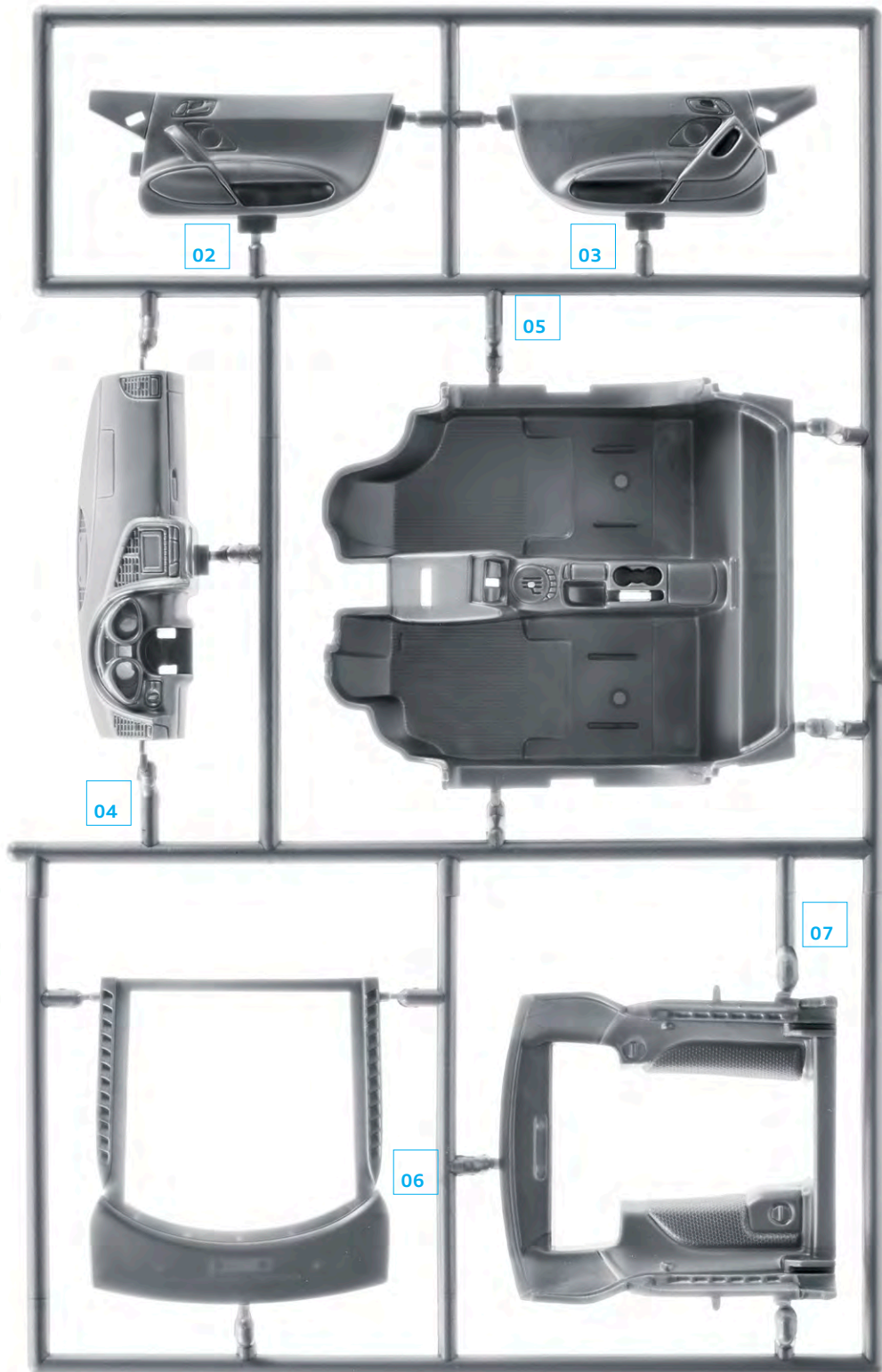



The door of perception.

OUR REPUTATION HINGES ON THE QUALITY OF THINGS YOU DON'T SEE.

It's said that, when one door closes, another one opens. It sounds as if whoever said it spent some time at an Audi research and development facility. After all, while you'll open and close the door on your Audi thousands of times without thinking about it, we've obsessed about it for you, in detail. Not just about the reliability of it opening and

closing, but on the proper weight that will make it more pleasing to close. How the locks should click when they are engaged. The optimal acoustic placement for the speaker port. There are the hinges too, of course. And the door itself, which we designed to take the brunt of side-impact collisions, and several dozen other safety considerations (to say nothing of the countless other components, processors, sensors, window features and the inner workings most people will never see). Our doors are more than a symbol of welcoming you into your vehicle, they are products of Audi engineering, and the very perception of Audi hinges on them as much as our hinges help support the door.

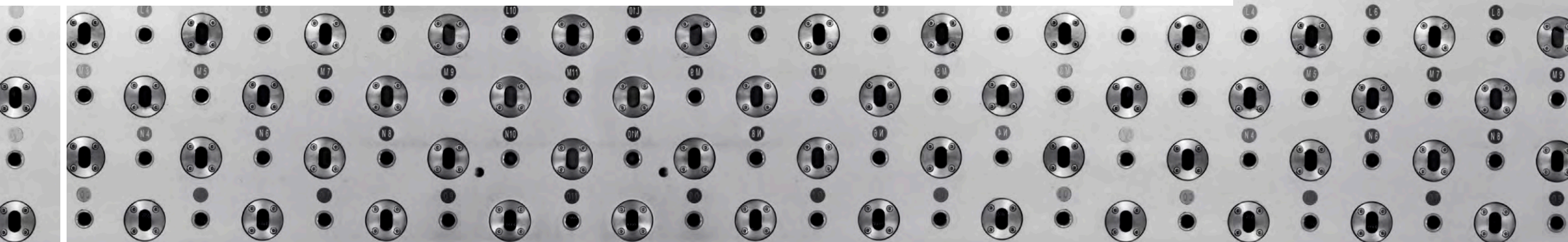

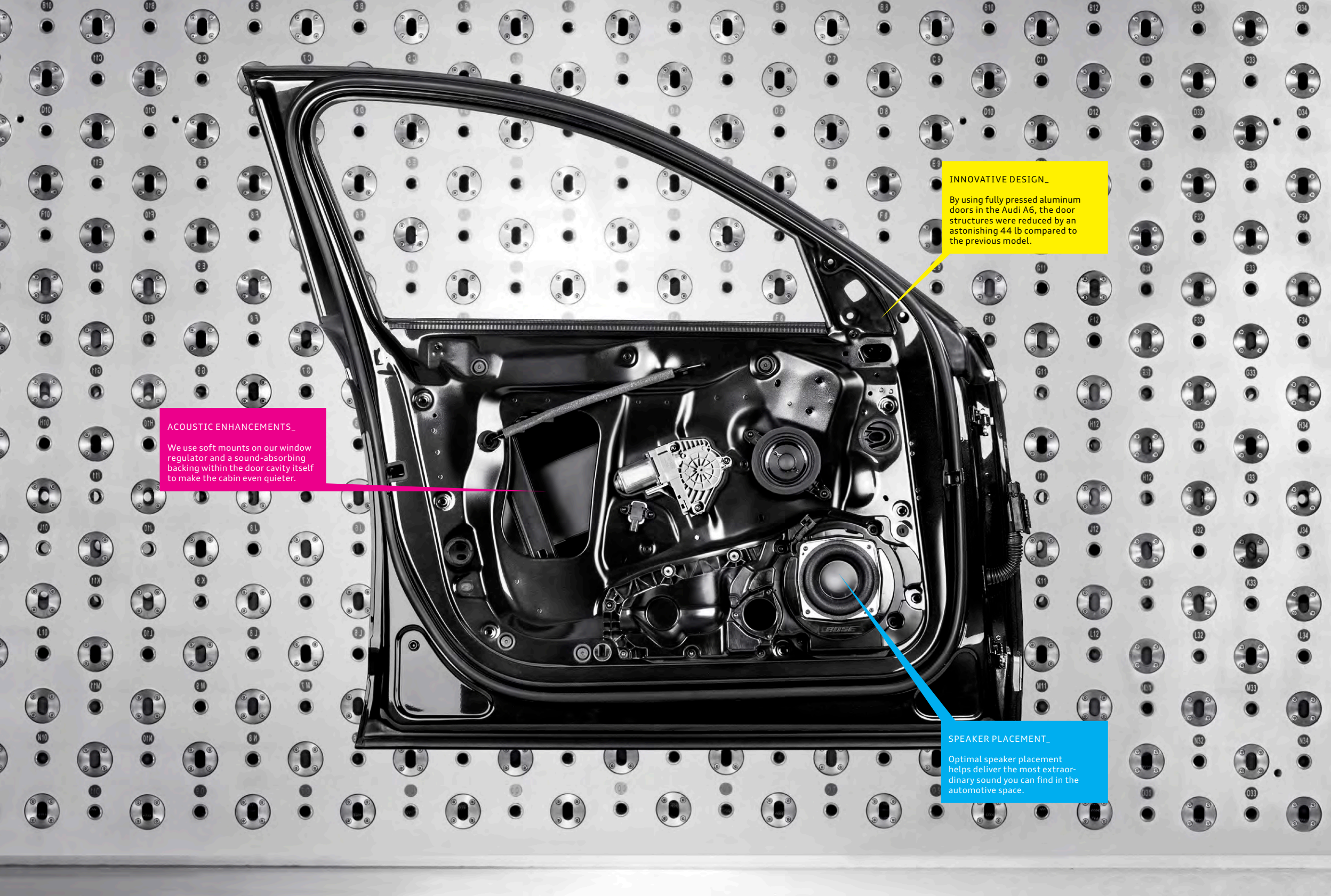

INNOVATIVE DESIGN_
By using fully pressed aluminum doors in the Audi A6, the door structures were reduced by an astonishing 44 lb compared to the previous model.

ACOUSTIC ENHANCEMENTS_
We use soft mounts on our window regulator and a sound-absorbing backing within the door cavity itself to make the cabin even quieter.

SPEAKER PLACEMENT_
Optimal speaker placement helps deliver the most extraordinary sound you can find in the automotive space.

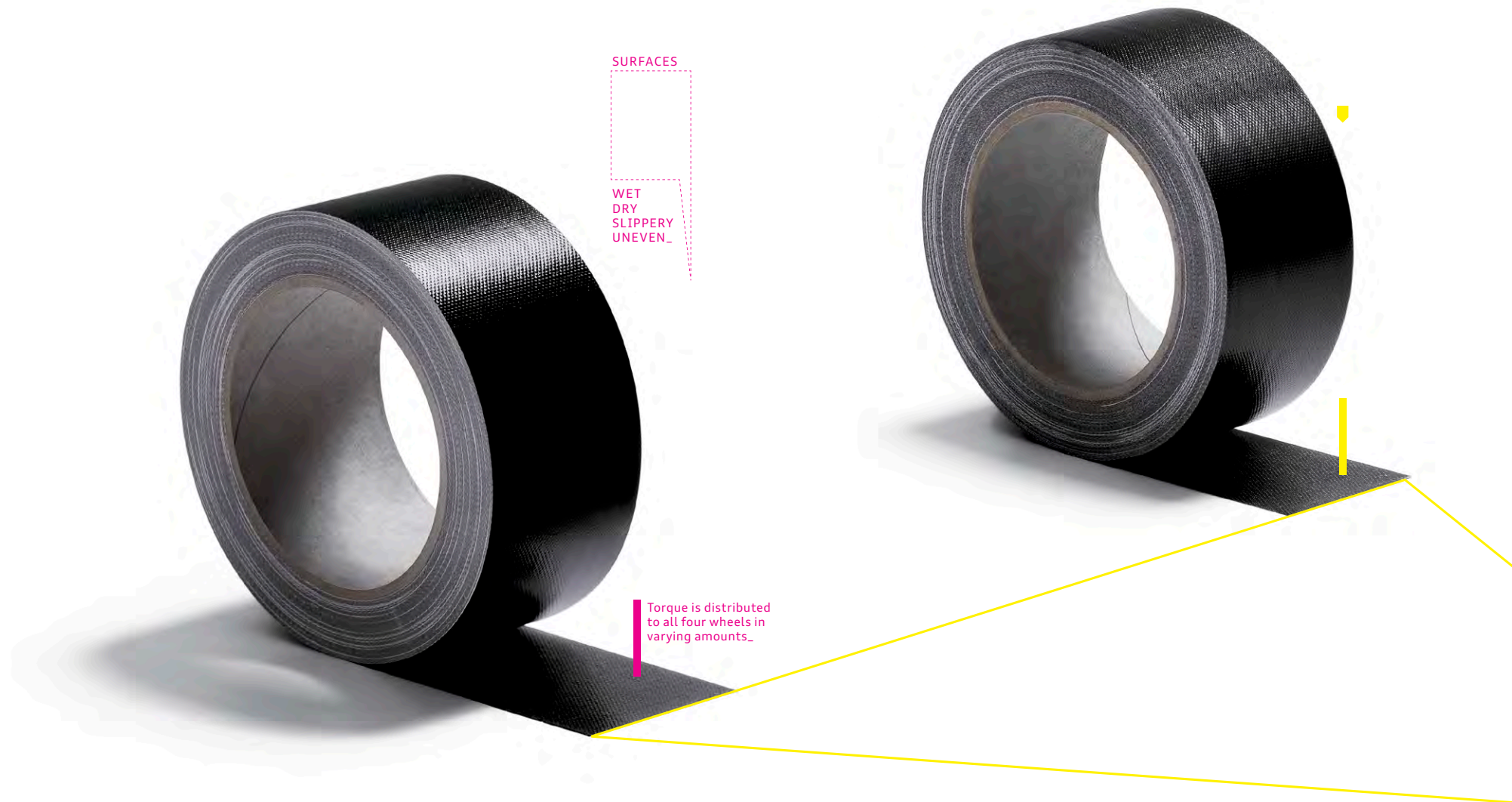

quattro® HAS MAINTAINED ITS GRIP ON OUR THINKING AND THE ROADS WE TRAVEL.

For more than 30 years, Audi has been focused on quattro® all-wheel drive. During that time, it has evolved into an overarching idea of performance, a technological system of ratios, power delivery and driving dynamics working seamlessly together, orchestrated through the drivetrain, providing power where and when it is needed most.

In many ways, this has been a three-decade drive, from the Alps to the autobahn—and points beyond. You've seen quattro® capabilities in the way we dominated the World Rally Championship for years, in the grip you have in inclement weather, and in the variable power distribution you enjoy in good conditions.¹ For more than 30 years, and with over five million quattro® systems on the road, we have continued to refine the technology, developing an available rear sport differential to help maximize performance and available torque vectoring to assist with cornering traction while helping to improve handling. We've boldly stuck to what worked while the world was trying to catch up, and we built on it.

¹ When driving during cold, rainy, snowy or icy weather conditions, ensure that your vehicle is equipped with appropriate all-season or winter tires. Even with appropriate tires, you must always drive in a manner appropriate for the weather, visibility and road conditions.

When we think of a good idea, it sticks.

Torque vectoring_

By independently braking the inside cornering wheels, torque is then transferred to the outside cornering wheels. This intelligent application of power, known as torque vectoring, is available on select quattro® models and helps promote neutral handling by calculating the driver's steering input and desired level of acceleration.

Sport differential_

To help ensure high cornering agility, the available sport differential uses torque vectoring, and then adds to that by mechanically applying additional torque to the outside rear cornering wheel. Through an electrohydraulic multiplate clutch pack and gear-set, the outside rear cornering wheel speed is increased by as much as 10%.



CORNERS

CURVES
MOUNTAINS
OBSTACLES
HANDLING
UNEXPECTED_

Impressive stability, more assured road-holding, enhanced agility and improved steering precision_



TRACTION

ACCELERATION
TOWING
SNOW
CRUISING
GRAVEL_

quattro® directs the amount of torque required to suit the job at hand_

The obsessive engineering of maximum fitness.



ENGINEERING POWER IS MORE THAN JUST ADDING MUSCLE.

There is an art to fitness. Yes, there are some who go for the massive, sculptured muscle look. But there is something more compelling out there for those with more refined tastes. The kind of sculpted efficiency found in Audi engines elevates the driving experience through smaller, finely tuned forced-in-

duction engines. For the drive to feel lean and precise, we've shaved off unwanted pounds. Sure, large numbers might distract some, but a champion impresses with its grace, power and athletic balance—captured in the right suspension setting, or a torque-vectoring corner. Audi engineers shape power that celebrates a true dedication to craft. It means strength that pulses at the moment of acceleration, provides a true, quick response as you change lanes, and turns the most routine cloverleaf into a joyful application of performance handling¹. This is the art of maximum fitness, to the point where others just feel a little flabby.



FSI®

The FSI direct injection fuel system directly injects fuel into the combustion chambers at precisely managed times and depths. What that means for drivers is that a fully homogenized intake charge helps increase power while also reducing fuel consumption and emissions, making efficiency more powerful.¹

TFSI®

At Audi, TFSI represents a combination of two of the brand's core areas of expertise—direct injection and forced induction. By adding turbocharging or supercharging to FSI direct injection, the pressurized intake charge is cooled by directly injected fuel, thus achieving efficiency and performance combined with higher compression ratios—previously only attainable by naturally aspirated engines.²

TDI®

A turbocharged, fuel-sipping variant, our TDI® clean diesel engines deliver uncompromising Audi performance with bold efficiency.¹ Yes, it gets better mileage per gallon than comparable gasoline engines,² but it also produces more low-end torque, which is best expressed in the elasticity you have when passing in the 30- to 60-mph range.

1. Always obey all speed and traffic laws. 2. See www.fueleconomy.gov for EPA estimates and emissions data. Your mileage and emissions will vary and depend on several factors, including your driving habits and vehicle condition.



ultra



ELEPHANT SKULL

How nature solved the apparent conundrum of an elephant's skull didn't escape the notice of Heinrich Timm, the longtime lead engineer for Audi. The weight of the tusks and the general size of an elephant's head would seem to make it impossible for the animal to actually be able to carry it. But the design genius behind the elephant's skull is to make it lightweight yet sturdy. Its predominantly hollow design is buffered by thin, connective bone walls, which act as strong, weight-bearing cells. Audi designers used that idea when building our aluminum and steel structures. Reducing weight, yet enabling strength.

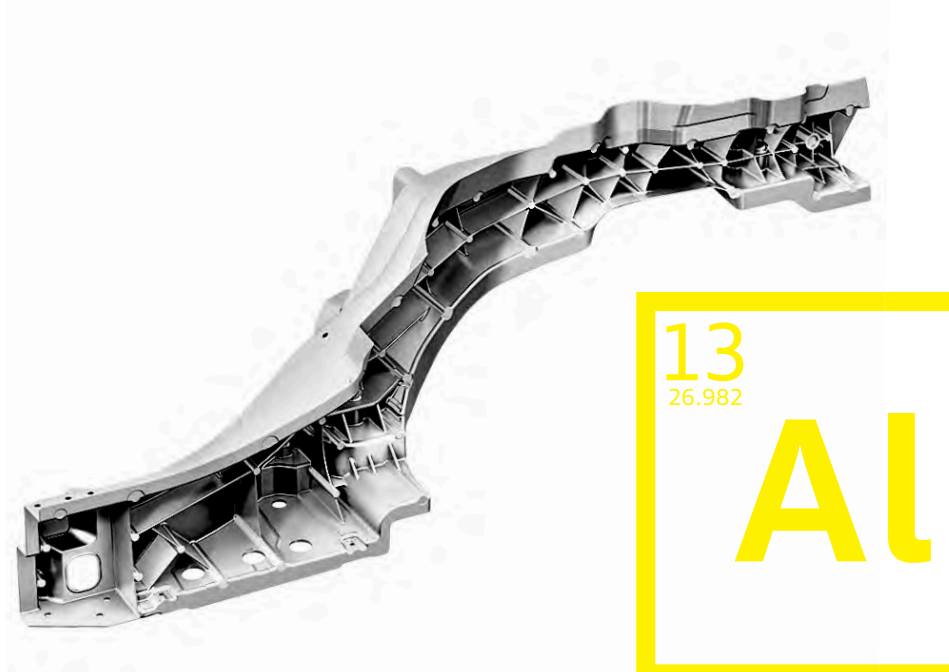

13
26.982
Al

ALUMINUM

Our large aluminum castings are a telling example of ultra lightweight technology. Primarily used in high-stress areas, these castings achieve exceptional rigidity while also allowing for freedom of design, all while remaining extremely lightweight.



How studying elephant skulls makes for superior handling.

THE ELEGANT STRUCTURE OF NATURE BECOMES A BLUEPRINT OF EFFICIENCY.

It seems strange to say that, while we build strong, complex and high-performing machines, we're naturalists at heart. Then again, it might not be that unusual, seeing how nature itself builds strong, complex and high-performing machines as well. When we developed the thinking behind our ultra® lightweight technology initiative,

we knew that nature would serve as an inspiration to greater structural efficiency. Take the structure of the elephant skull pictured here. It has to be lightweight, yet capable of carrying a heavy load. It's porous, but its structure is such that it enhances its stability and strength. We do the same, for example, with aluminum. Positioned one way, aluminum materials can be flexible. Positioned another, they are strong and rigid, and help give better support. We also looked to bamboo, which is strong at the conjoined areas (nodes), and flexible along its stem. Our designs allow for both rigidity and flexibility where each is most needed, and for efficiency overall. As we continue to develop strategies to improve the performance aspects and efficiency of our vehicles, we don't shy away from the world around us? We boldly engage it even closer still.

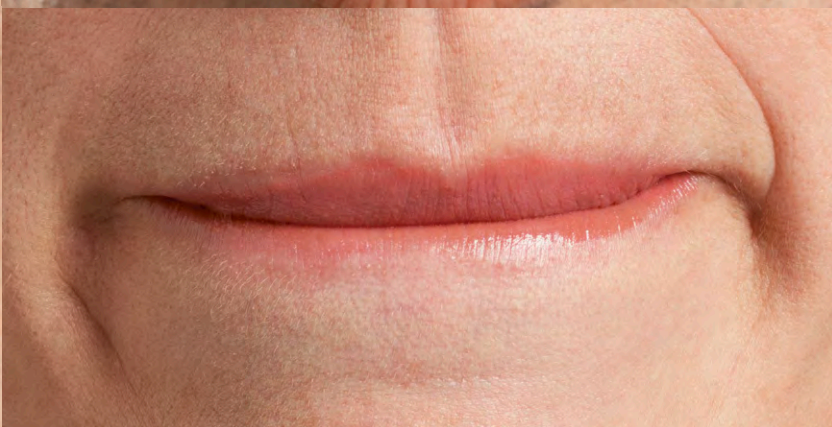



Just talk to us, baby.



AUDI CONNECT® REALLY GETS WHAT YOU ARE SAYING.

Share what's on your mind. Looking for a great Chinese food place? We'll help you get there. Thinking about a rest stop? We'll locate the nearest gas station for you, and even give you the price of their fuel. In fact, in your Audi, just say the word, and we'll help you find almost anything, even your home phone number. With available Audi connect with Google

Voice™ command capabilities, we've developed a way to let you articulate your desires, even if that's just finding the closest burger stand or the best hotel.¹ MMI® navigation plus with Audi connect helps integrate networking capabilities on the go, along with Google Earth™ with 3D satellite imagery, to help you avoid traffic (and possibly saying things you might regret).² Audi connect also provides fast data transfer speeds and Wi-Fi® connectivity for up to eight passenger devices to help you stay informed. It offers a full suite of services and interactivity, and, yes, even the closest Szechuan restaurant, which you can find by using its Google™ Local Search capabilities. Best of all, you don't even have to say "Thank you," even if we appreciate it when you do.

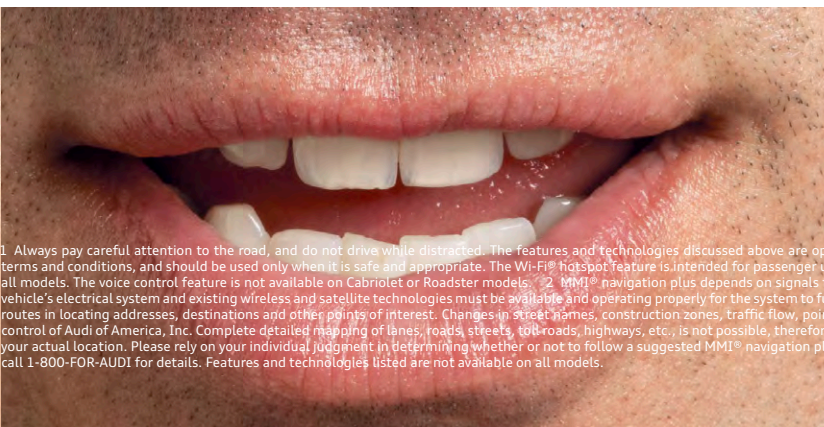

1. Always pay careful attention to the road, and do not drive while distracted. The features and technologies discussed above are optional, may require an additional subscription with separate terms and conditions, and should be used only when it is safe and appropriate. The Wi-Fi® hotspot feature is intended for passenger use only. Features and technologies listed are not available on all models. The voice control feature is not available on Cabriolet or Roadster models. 2. MMI® navigation plus depends on signals from the worldwide Global Positioning Satellite network. The vehicle's electrical system and existing wireless and satellite technologies must be available and operating properly for the system to function. The system is designed to provide you with suggested routes in locating addresses, destinations and other points of interest. Changes in street names, construction zones, traffic flow, points of interest and other road system changes are beyond the control of Audi of America, Inc. Complete detailed mapping of lanes, roads, streets, toll roads, highways, etc., is not possible, therefore you may encounter discrepancies between the mapping and your actual location. Please rely on your individual judgment in determining whether or not to follow a suggested MMI® navigation plus route. For mapping updates please see your Audi dealer or call 1-800-FOR-AUDI for details. Features and technologies listed are not available on all models.





How we know exactly what you feel.

CLEAN, BEAUTIFUL DESIGN COMES FROM DEDICATED CRAFTSMEN UNAFRAID OF GETTING THEIR HANDS DIRTY.

Our hands give you shade and sanctuary. Our hands give you comfort and control. You might not sense our hands nearby, but our hands know exactly what you feel. That's because we've been there. After all, our hands crafted a customized world that's dedicated to control, comfort and entertainment. We're talking,

of course, about the cabin of your Audi vehicle. Optimized luxury, designed by committed craftsmen who had you in mind when they chose the leather seating surfaces, created the contoured seats or provided the refinement of ergonomic design and an available more intuitive MMI® system. There are small touches that help simplify the overall design, and there are large statements to help you feel at ease. It is your Audi interior, shaped by the kind of people who know you want to experience luxury firsthand.



As you can see, our design will help channel water away from the mirror, allowing you a clearer view of what's behind you.



The molding on the inner A-pillar helps direct water away from the area where the windshield and A-pillar meet. Once the water is there, aerodynamic forces take over and funnel the water up and out of the windshield area rather than back and across the side windows.

You have to weather adversity to know things like this.

WHAT YOU DON'T KNOW MIGHT HELP YOU.

Think of it this way—if it rains, would you notice a dry side view mirror? Maybe not, but compared to one with beads of rain on it and distorted reflections, you would. It's a little thing, perhaps, but these little things are part of our deep obsession with crafting a premium driving experi-

ence. We design our exterior side mirrors with small sills to channel water along their upper edge, helping to leave your view unobstructed. We also design our windshield moldings with channels that allow rain water to efficiently run off instead of returning to the windshield wiper path. These are small touches, thought of by engineers and crafted by designers who don't necessarily call attention to their skills. Instead, these details reflect a commitment to quality that you might never notice—until a moment of bad weather or adversity, when you might. But don't worry. We don't mind if you don't notice us, now and then.



Either think about the
future, or make history.



e-tron

Pre-production vehicle shown.

e-tron[®]

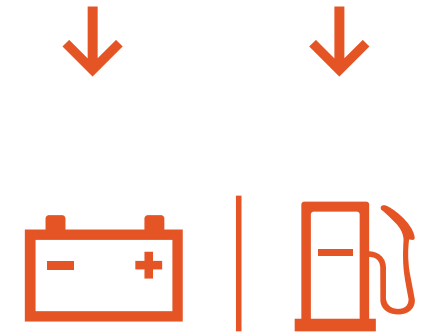

SUPREME PRACTICAL LUXURY WITH A SUNNY KIND OF ENERGY.

Talking about a better future is easy. After all, how can you be held accountable for something that never arrives? But if you really want to affect it, to make history, you have to do more than talk. Enter e-tron[®]. It's not the first plug-in electric hybrid to the market, but we are making it the most forward-thinking Audi ever produced. For example, we will be including a

level 2 charger with our A3 Sportback e-tron PHEV for owners who want to drive on electricity as much as possible. We also plan to offer unique sustainable energy offerings like an available solar powered connection to your charger. It's not just practical, it's premium too, in style, in performance and in fit and finish, like any other Audi vehicle. The A3 e-tron will be able to take on the average daily commute on electric-only before the efficient 1.4 TFSI[®] gas engine is needed.¹ But more than that, it will be Audi making smart technology smarter, with innovative kinetic-energy-harnessing when you brake, and better performing than what came before it. With the Audi e-tron vehicles, we're saying the future is now.

¹ Preliminary manufacturer's estimates.

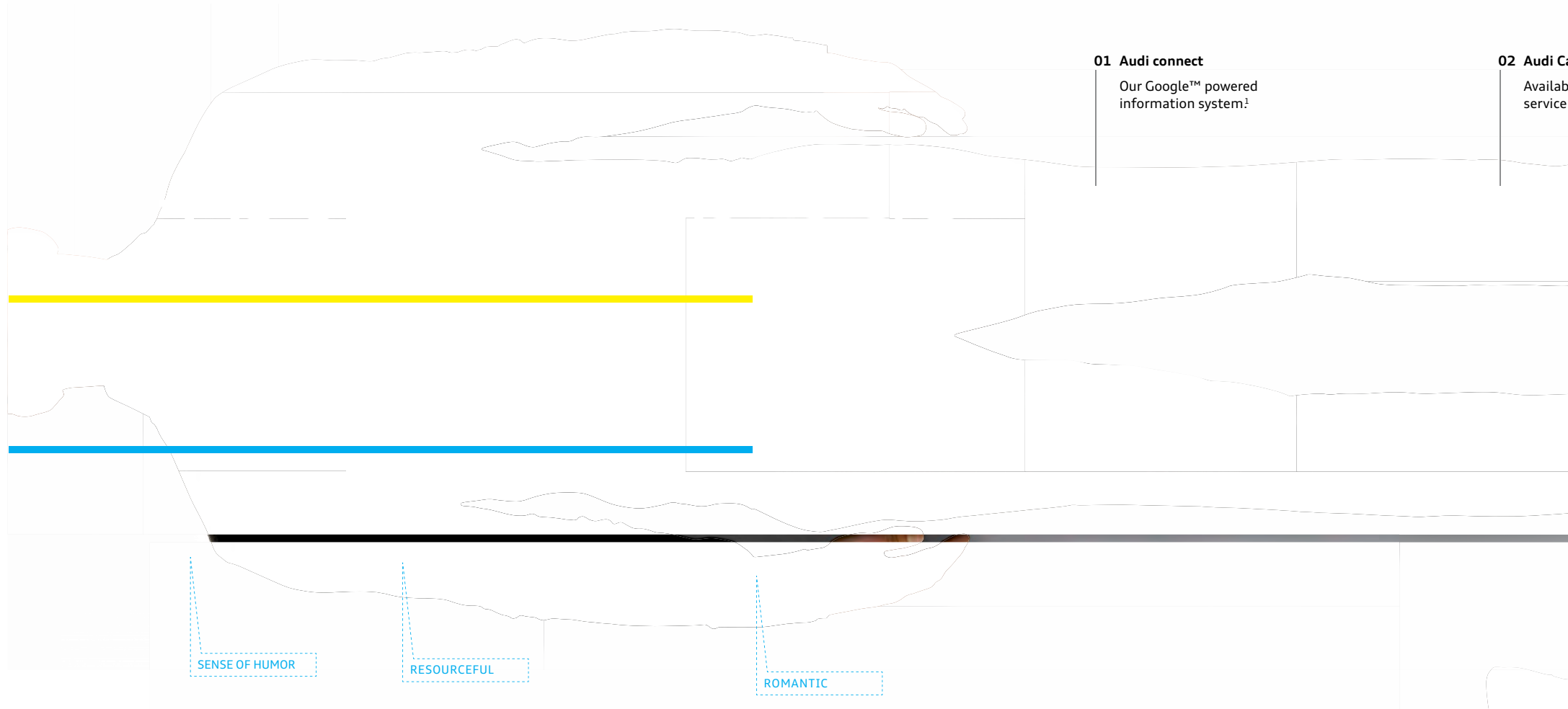

MOVING FROM LUST TO APPRECIATION TAKES A DEEPER UNDERSTANDING.

When you are attracted to something, the effects are immediate, the domination, total. For a relationship to last, though, it must move beyond that passionate initial phase. It's what comes next that turns a bright flame into an eternal torch. That's why Audi doesn't simply design premium vehicles for the

short-term, but offers an entire experience that we hope lasts a lifetime. Do you want to customize your Audi? We offer Audi exclusive materials and colors. Do you want care-free service options? Audi Care is available. MMI® updates, trial offers for Audi connect®, a full suite of available Audi driver assistance technologies—these might not be the reasons why you fell in love with an Audi, but they are, perhaps, the things that help keep the heart fires stoked.¹

¹ Optional features and technologies listed are not available on all models. See Infotainment/Technology section of the Featured Content page for important information regarding MMI® navigation plus and required SiriusXM® subscriptions.

are
le convenient
option.

03 MMI updates
MMI navigation and other
software updates¹

04 SiriusXM® Satellite Radio
Endlessly diverse music
channels with a compli-
mentary trial offer²

05 Audi exclusive
Available customizable
exterior and interior color
and material options.

SENSE OF STYLE

GENEROUS

LOVING

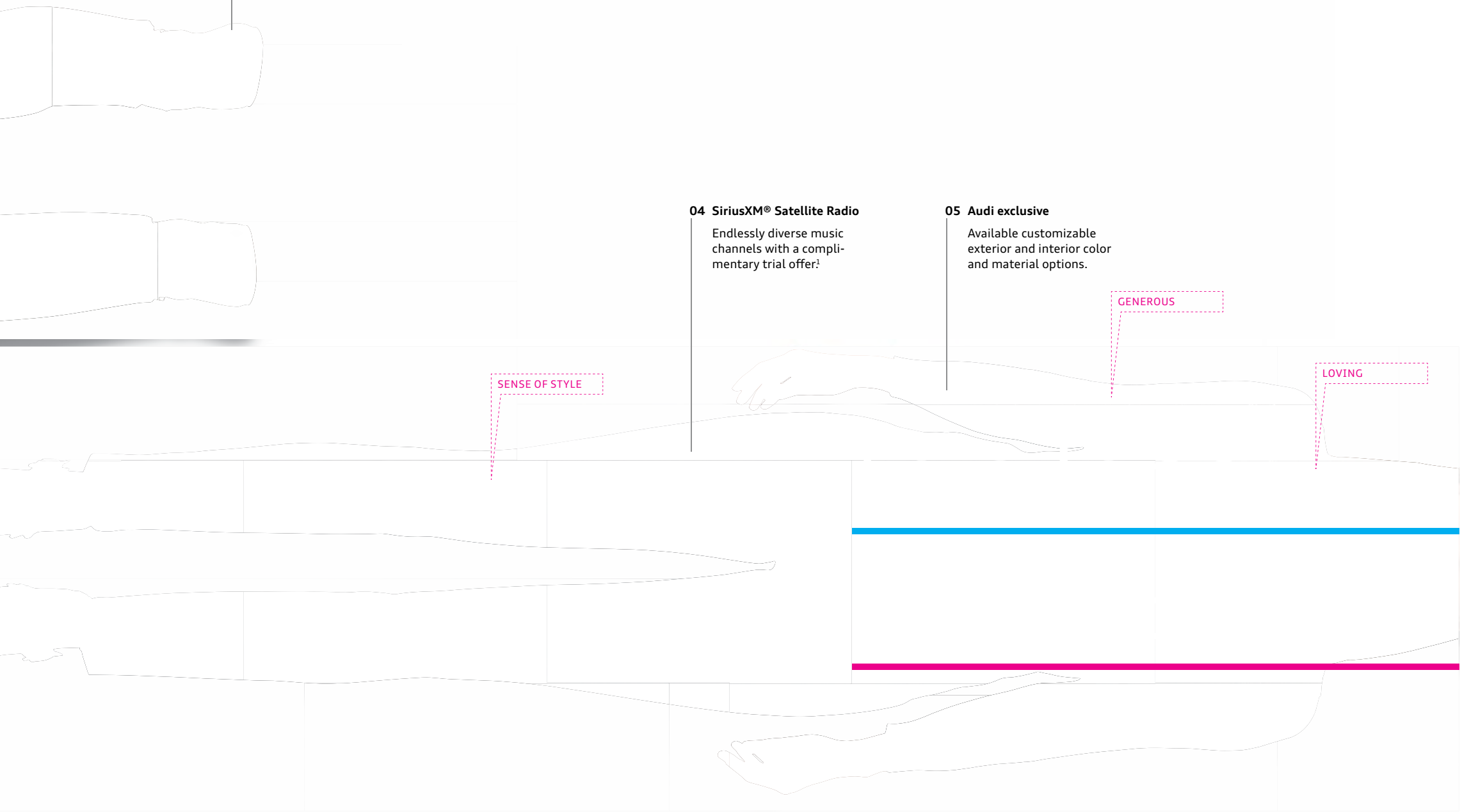

STATUS IS BUT STATURE IS WANT LUXURY YOU **IN** TASTE FOR AN **A8** IS ABOUT

Inspirations that build an icon.

The alchemy needed to build an automotive icon is elusive. Sure, it's found, partly, on an assembly line, with committed artisans taking pride in every stitch they oversee. It's also on a drafting board, sketched by visionaries looking to further expand what we look for in automotive design lines. But it's also in the countless inspirations, ones little and large, that not only capture a bold thought or striking idea, but execute them. Examples of these can be found in the foundational stories we tell about our company and our vehicles. These stories show how an abstract idea can turn into a powerful, sculpted machine, and then how that machine can help forge an iconic reputation for a brand. Out of the inspirations we find in engineering, art and the large world of ideas, we have created a fearless, iconic company of substance and luxury: Audi.

NICE,
TRUTH. YOU
THAT MATCHES
THE FINER THINGS.
ENGINEERING
ENVY AS MUCH
AS DESIRE.





Design

We do not follow design trends. We set them.

Consider it an ode to overachievement.

You're the type that dreams big, then goes out there and achieves it. Now comes the time to express all that you've accomplished in the most physically poetic way—the new Audi A8. Its attraction starts with its dynamic lines that highlight its luxurious proportions, while also giving it a modern, sleek elegance. Looking closer, you might also notice the considerable obsession put into the finest details, the character line running along the roof, linking front and rear, or the precise shoulder line and wide, shaded edge, adding to the naturalistic flow of a design that seamlessly extends from the headlights through the body and into the rear deck lid. But while the A8 can be appreciated as sculpture, it's not meant to be placed on a pedestal. It engages, enlivens and demands to be driven. It is design as design is meant to be—something intended to elicit an emotional response, while conveying a sense of prestige and distinction, not to mention confirming yours the second you step inside.



Enlighten

A new light on illumination just happened to be a design boon.

The intersection of fine art and four wheels.

While we know that the artist is compelled by an unseen, outside force during the creative process, it's a lesser-known fact that our engineers and designers are driven by a similar power. Beginning with the chiseled V shape across the hood that originates from the Singleframe® grille, perfectly proportioned lines travel the length of the vehicle, culminating in the coupe-like rear end of the Audi A8. The iconic, bold illumination given off by signature LED lighting technology bookends the A8 with artisanal flair. So whether you're drawn to the power of the available 4.0-liter TFSI® V8, the notable efficiency¹ of the 3.0-liter TDI® clean diesel engine, or the exclusivity of the A8 L W12, we've committed ourselves to developing a vehicle for every kind of driver.

¹ See www.fueleconomy.gov for EPA estimates. Your mileage will vary, and depends on several factors, including your driving habits and vehicle condition.



Full LED headlights

Completely redesigned, the full LED headlights now form a straighter line while still providing daylight-like illumination. Add to that a new LED daytime running light pattern that forms a precise outline, and it's a brilliant, and unmistakable, combination.



You're not after looks, just exceptionalism.

While being the center of attention may not be your preference, it's clearly inevitable. You see, with the biggest exterior facelift in its history, the new A8 delivers an even sleeker look with the same unrivaled presence that's made it impossible to ignore. Of course, we still strove to satisfy the driver who expects every detail of a vehicle at this level to be well thought out. With us, luxury is elevated to incorporate a powerful idea, imbuing the body with a commanding presence and the interior with the kind of prestige that can't be duplicated. Even the unseen features of the A8 convey our commitment to setting a standard, as opposed to just following in other luxury vehicles' tire tracks. You'll feel it in the way lightweight ASF® aluminum construction and quattro® all-wheel drive work together for dynamic handling, or in the smaller touches, like a power trunk lid with hands-free release or power soft-closing doors. Large and small, these gestures comprehensively cater to your needs while confidently anticipating your wants. As it turns out, your unwillingness to settle will put all eyes on you—like it or not.



Power trunk

For added convenience, a power trunk feature ensures that the trunk lid opens and closes effortlessly, while the hands-free release function operates by simply moving your foot under the rear of the A8.

Power soft-closing doors

Simply pull the door toward you and let it fall lightly into the latch. The Audi A8 does the rest, as power soft-closing doors utilize an electric actuator that closes the door flush automatically.

For those looking to take the gloves off, the available **Sport package** infuses athleticism by providing enhancements such as 20" 5-double-spoke wheels with a Galvano Silver finish, dynamic steering and a sport differential, allowing you to test the limits of this specimen!



¹ Always obey all speed and traffic laws.





↑ ↑

Decorative inlays

Finely crafted wood upper inlays and high-gloss Black or Brushed Aluminum lower inlays adorn the interior of the Audi A8, helping to further embellish the luxurious interior.

Appreciating the finer details of accomplishment.

Spacious design and meticulous craftsmanship are hallmarks of the Audi A8 interior. You feel the space as the curve of the door continues its sweep across the dashboard, helping to frame your driving environment in visual style. You feel the craftsmanship in the highest standards of materials and finishes. Once seated, you'll notice that first-class comfort envelops you on all sides. On your right, the unique design of the gearshifter allows your hand to rest while you control the MMI® system. It's the comprehensive attention to your needs—and the anticipation of them—that changes the definition of style from form to something deeper.

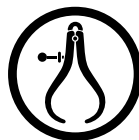

Craftsmanship

We've ensured that every stitch represents the detail that we put into every aspect of an Audi vehicle.



Yacht throttle shifter

Ergonomically designed, the shifter on the A8 is the perfect place to rest your wrist while engaging the MMI, and adds another sophisticated touch to the interior of your Audi A8.

Ambient lighting

Whether dawn or dusk, customizable lighting in your Audi A8 can capture your mood, change it or illuminate the way you really feel. Audi designers meticulously crafted ambient LED interior lighting to provide a comforting glow to the interior of your A8. With three color choices and four zones, you can brighten or dim the interior to create the optimal effect, whether you are looking for relaxation or invigoration. You are, as always, in control of your environment—we'll just help with your mood.

1. Always pay careful attention to the road, and do not drive while distracted. The features and technologies discussed above are optional, may require an additional subscription with separate terms and conditions, and should be used only when it is safe and appropriate. The Wi-Fi® hotspot feature is intended for passenger use only.





Take your rightful seat of power.

Climbing into the Audi A8, you'll first notice the striking driver-centered cockpit and wraparound curve of the dashboard, giving you absolute power over your surroundings. You'll have control at the tips of your fingers with the multifunction leather-wrapped steering wheel. Thanks to 18-way adjustable front seats or the available 22-way front sport/comfort seats, you'll see the payoff of our compulsive dedication to every last detail with the available Nougat Brown Valcona leather with diamond-quilting. Available front seat ventilation cools you, and a soothing massage feature extends the hand of luxury on long commutes. And with legendary Audi craftsmanship creating the perfect atmosphere for any drive, you'll find that you have complete authority over your kingdom.

← Diamond-quilted leather

← One of our most popular interior options is available on A8 models: diamond-quilted Valcona leather. This premium, supple leather captures the essence of Audi—using the kind of materials and finish that show our commitment to luxury craftsmanship along with our passion for performance.

← Ventilated front seats with massage function

← Available front seat ventilation offers multiple levels of cooling, while a customizable massage function helps soothe or invigorate the body during extended drives.

22-way front comfort seats

Adding to the plush interior of the Audi A8 are the available 22-way driver and front passenger comfort seats that offer lumbar support, ventilation and massage functions.



First class without the security hassles.

No matter where you sit, the Audi A8 L with the available Executive Rear Seat package embodies the living image of luxury. Side to side, front to rear, the expansive interior of the A8 L includes the kind of thoughtful details, matchless materials and overall sophistication that define your experience when riding in it. An available panoramic sunroof, the option of an immersive Rear Seat Entertainment system, and handcrafted finish throughout—all create an exclusive atmosphere for a singular sanctuary.



Panoramic sunroof

The available two-panel panoramic sunroof offers both the front and rear passengers a nearly unobstructed view overhead while flooding the cabin with natural light. And when you decide you need to say goodbye to the sun, the power sunshades are there to make it an easy task.



Rear Seat Entertainment

With vibrant dual 10" screens, the available Rear Seat Entertainment system can display a wealth of media choices and information, including navigation. Each rear seat occupant can access their own media controls located on the center armrest.

Rear Seat Comfort package

The available Rear Seat Comfort package adds even more comfort to an already plush environment. Features like power adjustable rear seats with massage function, along with personal climate controls, help make every journey a pampered experience.

Executive Rear Seat package

The available Executive Rear Seat package adds a level of personalized comfort to the benchmark in executive luxury. A passenger-side rear relaxation seat with power footrest immerses you in sumptuous relaxation, while a fixed, leather-covered rear center console and 115-volt power inverter create a mobile business or pleasure center. This package also features a small refrigerator between the rear seats as well as rear-seat ventilation.



S8



Audi Sport
Truth in Engineering



The story doesn't stop here. There's more on the full range of S, RS, and R8 Audi performance models in the **2015 Audi Sport brochure**. See your dealer or go to audiusa.com for details.



It doesn't matter if the world is ready. You are.

Most people may not think that a luxury car should wow their every sense, but this car wasn't built for them. The Audi S8 takes luxury to a thrilling new place.¹ A 4.0-liter turbocharged TFSI[®] V8 engine produces an astonishing 520 hp and 481 lb-ft of torque that delivers power, acceleration and excitement as soon as you climb behind the wheel. When you're the driver of the Audi S8, you become part of an exclusive group of drivers who understand that performance and power are an extension of who you are.



ENGINE // 4.0-liter turbocharged TFSI[®] V8 engine producing 520 hp and 481 lb-ft of torque with S quad exhaust and available sport exhaust system with Black finishers

DRIVETRAIN // quattro[®] all-wheel drive with sport differential, eight-speed Tiptronic[®] automatic transmission

CHASSIS // S8 tuned Audi adaptive air suspension, Audi drive select and dynamic steering

BRAKES // 15.7" ventilated front disc brakes with S8 logo, 14.0" ventilated rear disc brakes

PERFORMANCE // Top track speed of 155 mph²; acceleration from 0 to 60 mph in 3.7 seconds

¹ Always obey all speed and traffic laws. ² Top track speed is electronically limited in the U.S. Always obey all speed and traffic laws.



Torque vectoring

It's a handling feature so quick that it seems to respond to your impulses instead of your steering input. An evolution of cross-axle lock, this system works within quattro® all-wheel drive, utilizing ESC and ABS to help sense traction loss from the inside cornering tire.



Seasonal stability

There is a reason quattro® all-wheel drive is a friend in foul weather!¹ Under normal driving conditions, the center differential splits torque at a ratio of 40:60 front to rear, but as conditions change and become more challenging, the ratio is optimized to help maximize grip.



Power out

Torque vectoring distributes power to the outside wheels when turning, helping give you added control in the corners.

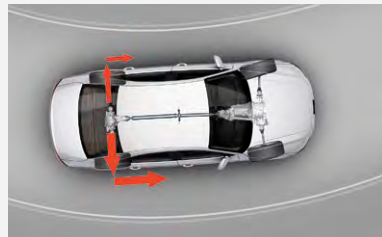

Sport differential

To help ensure high cornering stability, the available sport differential uses torque vectoring, and then adds to that by mechanically applying additional torque to the outside rear cornering wheel. Through an electrohydraulic multiplate clutch pack and gear-set, the outside rear cornering wheel speed is increased by as much as 10%.

85:15

When accelerating, power is shifted to the rear wheels for extra rear traction.



Under normal driving conditions, power slightly favors the rear axle.

¹ When driving during cold, rainy, snowy or icy weather conditions, ensure that your vehicle is equipped with appropriate all-season or winter tires. Even with appropriate tires, you must always drive in a manner appropriate for the weather, visibility and road conditions. ² Always obey all speed and traffic laws.

**A little added confidence
can help powerfully steer
you in the right direction.**

There's an elegant sense of assurance when you are in control. In the case of quattro® all-wheel drive, the elegance is created by a sophisticated system developed by Audi engineers to help you with the ability to gain more control when road and weather conditions aren't their best! Through enhanced grip on twisting mountain roads and powder-dusted streets—to say nothing of the precision you'll feel in taking corners in perfect conditions—quattro® works with drivers who want peace of mind as much as power. Because it was built and honed to transfer the necessary amount of power to the appropriate wheels when accelerating and turning, quattro® helps enhance Audi performance, but the real story just might be how quattro® helps engineer confidence in good drivers.

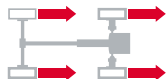

quattro® seamlessly transfers power as needed as driving conditions change.

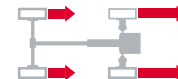

30:70

When traction is limited at either axle, power is shifted to the axle with the most traction.

You can't always choose the road you'll own. Just how you'll drive it.

There are moments when everything feels in perfect sync. You make the green lights. The traffic opens up and the highway is yours.¹ The local road with the sharp turns seems to bend to your will. The next time that happens, notice the driving dynamics of your Audi A8—you'll find that all the systems are in equilibrium, engineered for you to take full advantage of the conditions and to produce a drive that is powerful, exhilarating and balanced. Audi engineers tuned the driving dynamics of the A8 to react to a variety of external forces, all focused on one result: producing the kind of personally adjustable ride and handling that make a driver want to immediately get behind the wheel again.

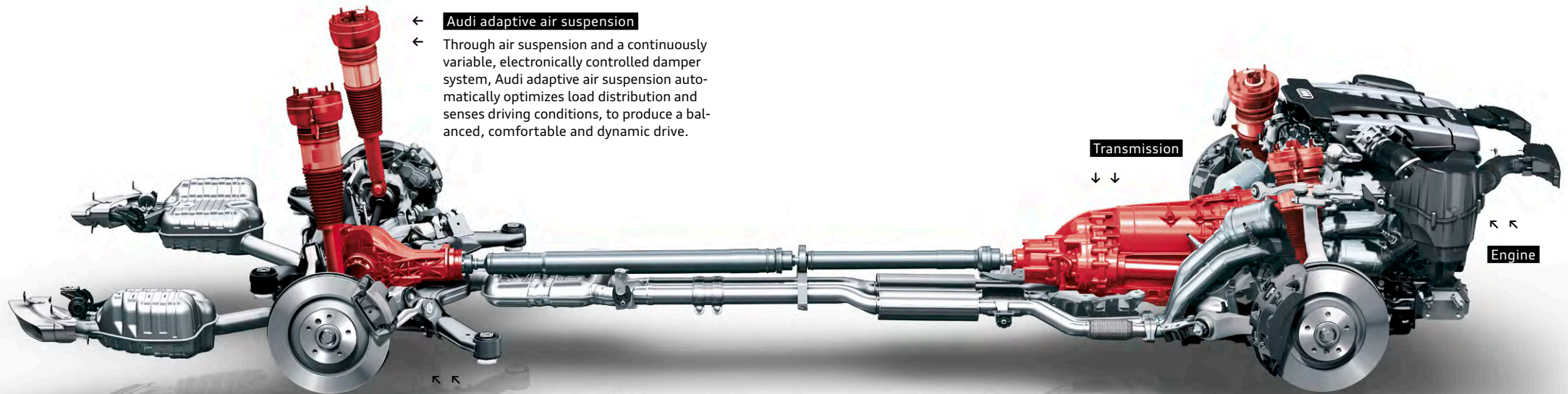

¹ Always obey all speed and traffic laws.

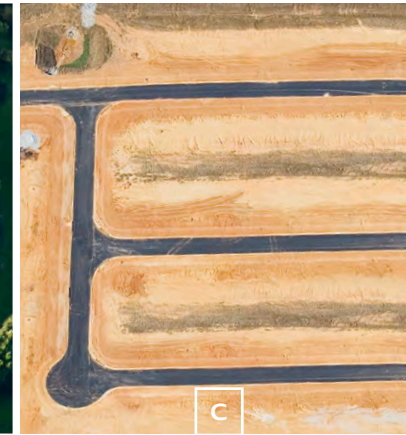
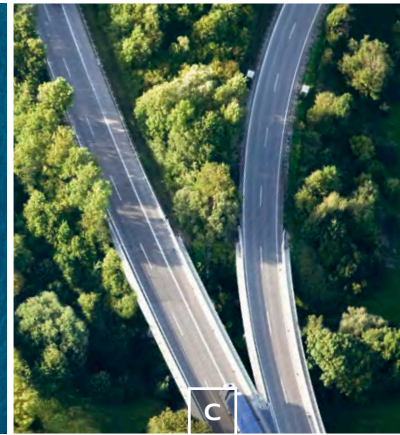
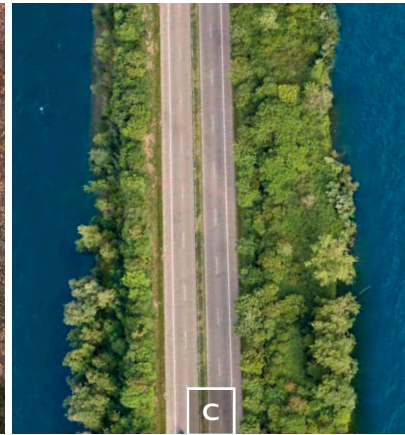
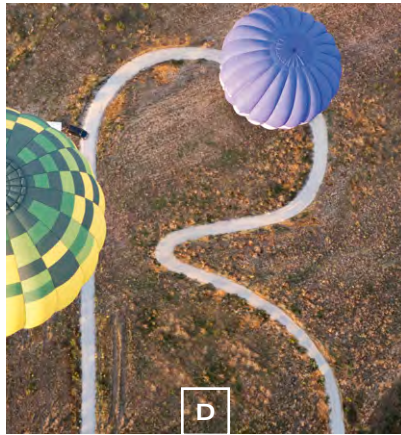

At Audi, we believe you should be the ultimate master of your road-going domain. That's why we created the Audi drive select system. It gives you the ability to adjust the vehicle's steering, throttle response, suspension and transmission shift characteristics with the utmost of ease. And with four modes to choose from, when almost any kind of road comes into question, Audi drive select will let you answer.

C Comfort mode
Perfect for those long highway stretches, this setting adds optimized steering and suspension and a closer shift pattern to help provide a more relaxed drive.

D Dynamic mode
Tighter steering and a more responsive throttle give this setting an aggressive feel and focused performance!

A Auto mode
The best of both worlds, dialed to automatically adjust settings for a seamless combination of comfort and responsiveness based on your driving style and road conditions.

I Individual mode
Take the turn your way—this mode allows you to adjust the steering, suspension, throttle and transmission upshifts to your style.

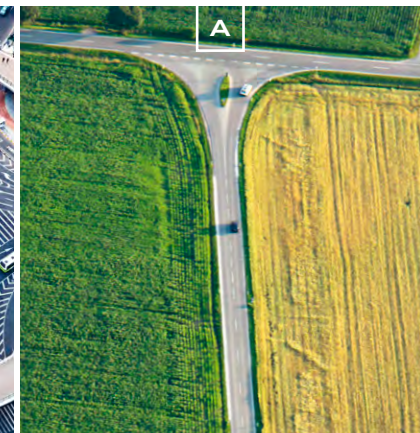
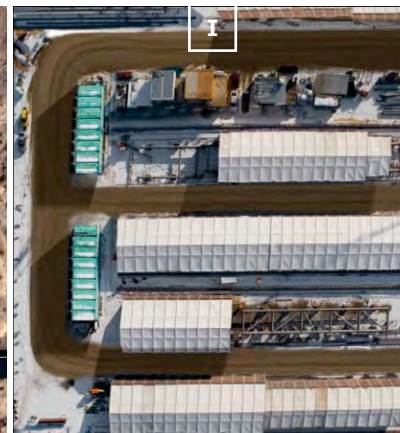



Performance

The adage “good things come in small packages” has never been more true.



3.0 TFSI® V6

The 333 horsepower 3.0-liter TFSI V6 engine is paired with direct injection and a belt-driven supercharger that has counter-rotating four-vane rotors. Spinning at speeds of up to 23,000 rpm, the rotors force air through dual intercoolers, then through the intake runners, at boosted pressures of up to 11.6 psi. It is this combination of engineering achievements that allows for a nearly instantaneous buildup of 325 lb-ft of torque directly off of idle engine speeds. The result? Fuel savings you wouldn't expect, and the kind of performance you should.¹



TDI® clean diesel V6

With 240 hp and 428 lb-ft of torque on tap, the 3.0-liter TDI® clean diesel engine's elasticity in the passing lane is almost as impressive as its ability to take on even the longest road trips. And with features like AdBlue® exhaust after-treatment helping to make every journey a little cleaner, this is a performance win for all sides.



4.0 TFSI V8

Dual twin-scroll turbochargers nestled inside the “V” of the 4.0-liter TFSI engine provide low and high engine speed responsiveness, ultimately supplying you, the driver, with 435 horsepower and a relentless 444 lb-ft of torque across nearly the entire rpm range. But, power aside, this 4.0-liter V8 engine also helps enhance fuel efficiency through the use of cylinder on demand™ technology, with little obstruction to the enjoyment of the drive.¹ This is further refined with active engine mounts and active noise cancellation; both technologies limit the minor vibrations and ambient engine noises inside the cabin normally associated with cylinder deactivation and re-ignition.



6.3 FSI W12

The 6.3-liter W12 engine with FSI® direct injection produces 500 hp and 463 lb-ft of torque. As the pinnacle of what is possible with engine design, this 12-cylinder powerhouse has a compact layout in “W” or offset cylinder formation, making it one of the only vehicles in its class offered with an all-wheel drive system. It also features innovative cylinder on demand engine efficiency programming for increased fuel savings when full power isn't required.¹ And, thanks to a lightweight aluminum-silicon-alloy cylinder block and a large displacement that delivers effortless thrust, the W12 is a poetic response to what's become conventional in an automotive flagship.

Waste not, get more.

When Audi engineers set out to develop four equally impressive powerplants, there was more to their task than just coaxing the most horsepower and torque out of every liter of displacement. They also needed to ensure every stroke of the piston, whether in the responsive TDI® clean diesel engine or in the remarkably powerful 6.3 FSI® W12 engine, was choreographed precisely to help ensure that not a drop of fuel was left unused.¹ As it turns out, meeting this challenge not only resulted in less waste, but also enhanced performance.

¹ See www.fueleconomy.gov for EPA estimates. Your mileage will vary, and depends on several factors, including your driving habits and vehicle condition.

Innovation for the long road ahead.

The Audi A8 is not short on vision. That is to say, when it comes to putting away mile after mile in the most technologically advanced Audi we make, you can expect its advanced powertrain to have the intelligence and foresight to conserve fuel when it matters most.¹

cylinder on demand™

The Audi A8 4.0T and W12 models with cylinder on demand engine efficiency technology helps make your exciting driving experience more efficient. When they're not needed, half of the cylinders stop firing, to help save fuel, and seamlessly reignite when the drive requires all eight or twelve.¹

Eight-speed Tiptronic® automatic transmission

The eight-speed Tiptronic® automatic transmission helps provide impressive performance due to its shift versatility. And with the top two gears helping deliver more efficient highway cruising, it is a perfect companion for almost any road trip.¹

Shift-by-wire

The eight-speed Tiptronic® automatic transmission in the Audi A8 utilizes a shift-by-wire technology, and is fully engaged by the vehicle's onboard computer. Efficient design and computer-managed shift styles add to the vehicle's efficiency.¹

Start-stop efficiency system

It's pretty simple. Under certain driving conditions, the A8 3.0T, TDI® and 4.0T model's engine will shut off when the vehicle is stopped. The engine will restart before you fully take your foot off the brake or if other critical vehicle systems require it, so your performance is not hindered.

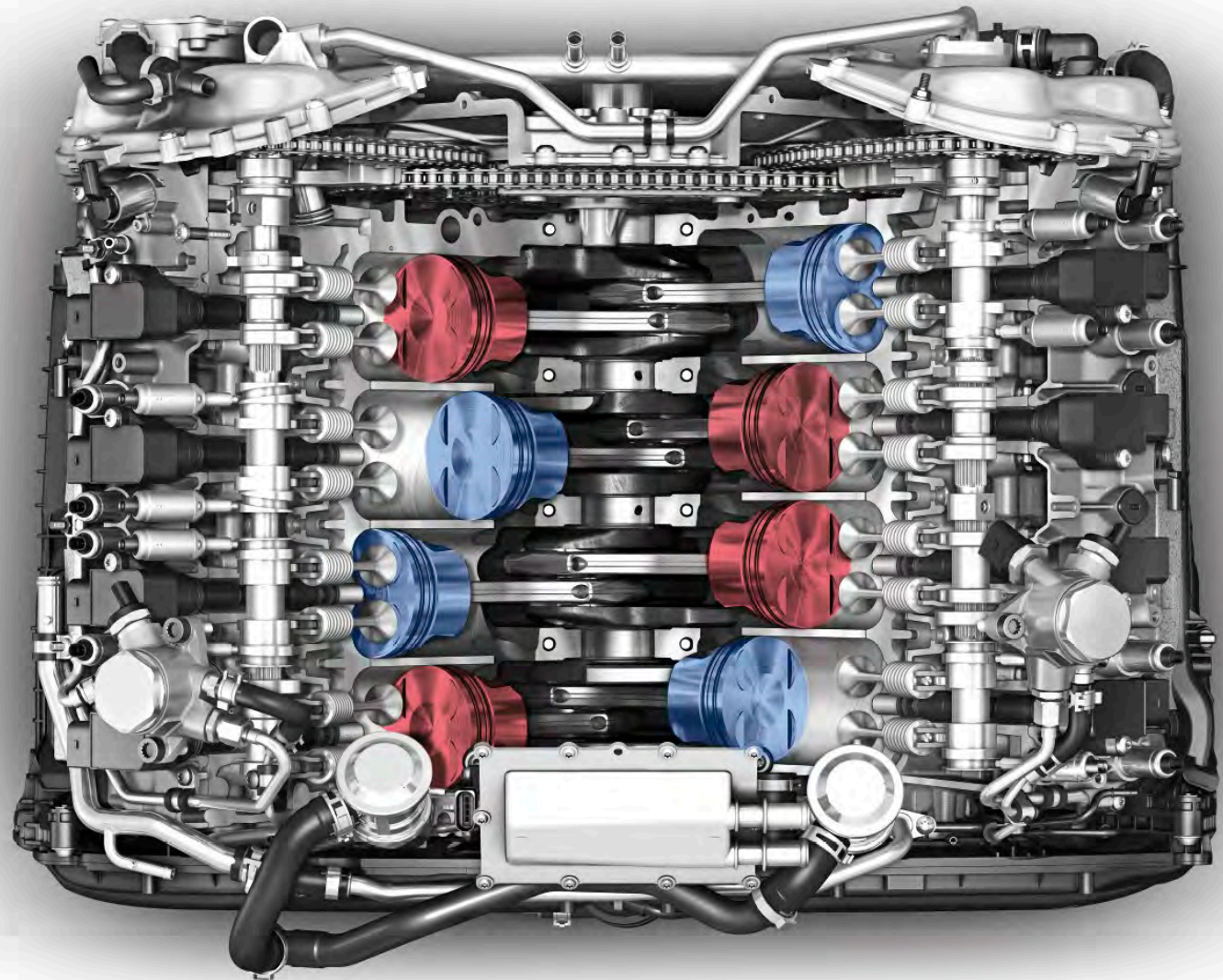

Fuel for thought.

We thought you should know: Diesel sports a greater power density than traditional gasoline, which means that a gallon of diesel fuel has about 15% more energy than a comparable amount of gas, and combusts more efficiently in the engine. The TDI® clean diesel engine available in the A8 has achieved ultra-low emissions vehicle (Bin-5/ULEV II) status in all 50 states while producing approximately 14.3% fewer CO₂ emissions than its comparable gasoline-fueled engine.¹ And the brainy attributes don't hide the brawn—in fact, Audi has dominated the 24 Hours of Le Mans over the years with TDI® prototype race cars. With these facts in mind, maybe you are thinking that a TDI® might be your choice—which goes to show that clean diesel really is fuel for thought.

→ → → **TDI®** clean diesel → → → → →

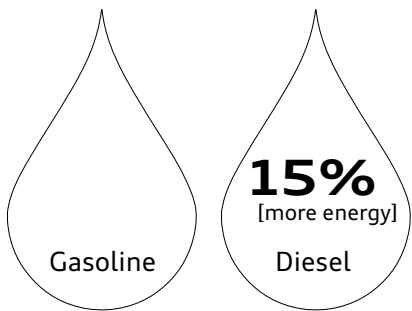

↑ ↑

Diesel packs more energy

On average, one gallon of diesel contains about 147,000 BTUs, versus 125,000 for gasoline.

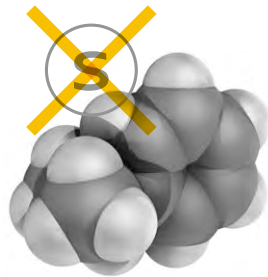

↑ ↑

Making diesel cleaner

A new refinement process has reduced sulfur in diesel fuel by more than 97% in years past.

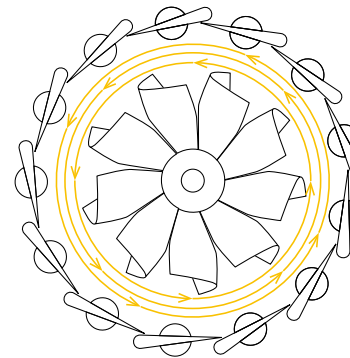

↑ ↑

Variable vane turbocharger

Adding turbo power to clean diesel engines, our variable vane turbocharger produces impressive torque punch at mid-range highway speeds.²

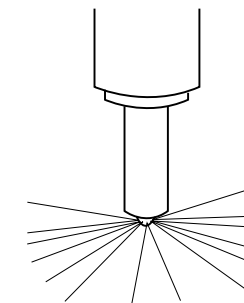

↑ ↑

Piezo direct injection

Precise injections help lower the combustion noise normally associated with diesel engines, while optimizing the distribution of fuel in the combustion chamber, helping to further reduce exhaust emissions.

¹ 14.3% fewer CO₂ emissions based on 2014 EPA emissions data versus its comparable gasoline powered model. See www.fueleconomy.gov for details. Your vehicle emissions will vary and depends on several factors, including your driving habits and vehicle condition. ² Always obey all speed and traffic laws. ³ EPA estimates. Your mileage will vary and depends on several factors, including your vehicle condition and driving habits. See www.fueleconomy.gov for details. ⁴ 2015 A8 L 3.0-liter TDI® clean diesel V6 with eight-speed Tiptronic® automatic transmission and quattro® all-wheel drive. Range based on EPA estimates of 24 city/36 highway mpg and a 21.7-gallon fuel tank. Never allow your vehicle's fuel tank to become completely empty. ⁵ 33% better mileage over comparable gasoline engines is based on 2015 A8 L TDI® model's 28 combined mpg as rated by the EPA vs. the 2014 EPA-rated gasoline-powered equivalent. Your mileage will vary and depends on several factors, including your driving habits and vehicle condition.



mileage

24 city/36 highway/28 combined mpg³



range

Maximum range of up to 520 to 781 miles per tank⁴



torque

428 lb-ft of torque along with 240 hp from the 3.0-liter TDI[®] clean diesel V6

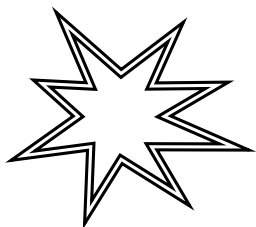

+

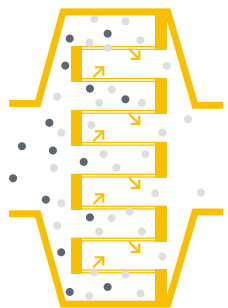

=

up to

33%

better efficiency



Combustion

Combining a high compression ratio with direct injection makes combustion more efficient, and produces emissions cleaner than those of engines with a lower compression ratio.



After-exhaust treatment

With innovative diesel particulate filters and the nontoxic AdBlue[®] reducing agent, we help eliminate up to 95% of diesel NO_x emissions.



Increased fuel efficiency

Another way diesel creates fewer emissions is that it gets better mileage, up to 33% more mpg than comparable gasoline engines, in fact.⁵

There is more information on the TDI[®] clean diesel model line in the 2015 TDI[®] clean diesel brochure. For details, see your dealer, go to audiusa.com or download the digital brochure from the Audi library app.



Driver Assistance

We're solving problems before you even know you have them.

A little insight into the things you cannot see.

Audi strives to constantly up the ante on the driver assistance tools built right into the Audi A8, and they're all designed to work in tandem with you, wherever you go. Whether it's available advanced technologies like night vision assistant that uses infrared technology to help you spot pedestrians and large animals on the road, or radar sensors that Audi side assist utilizes to inform you of vehicles approaching from the side and rear, you'll find that we've developed them to work together to help keep you aware of your surroundings. The whole suite of available driver assistance features can be found in the A8. It's another testament to the effort Audi puts into helping ensure that you're not the only one keeping an eye on the road.

Audi adaptive cruise control with stop & go

Using long range radar and a camera, the available Audi adaptive cruise control with stop & go not only helps retain a preset distance from vehicles ahead, but resumes acceleration when you're ready. It can even bring the vehicle to a full stop before accelerating when traffic flow resumes.

Audi active lane assist

Operating at speeds above 38 mph, this available system helps detect when the vehicle begins to leave the lane without signaling. Then, through gentle, corrective steering efforts, it helps the vehicle remain in the lane and vibrates the steering wheel as an additional warning. This way, Audi active lane assist complements the driver's decision-making process and further solidifies the bond between driver and machine.

Audi pre sense® plus

The available Audi pre sense plus offers comprehensive driving assistance with sensors in the front, side and rear. After visual, physical and aural collision warnings, there are four distinct phases for automatic preparation for the unavoidable: an upsurge of brake pressure, safety belt pretensioning, partial braking, and sunroof and window preparation. In severe cases, Audi pre sense plus will engage full braking and deceleration.



Night vision assistant

Using infrared technology to detect what lies ahead, this available feature uses thermal-imaging technology to help you avoid trouble. Pedestrians and larger animals can be detected over 300 feet in front of the vehicle, while objects can be spotted over 900 feet ahead—all shown on the 7" color driver information system.

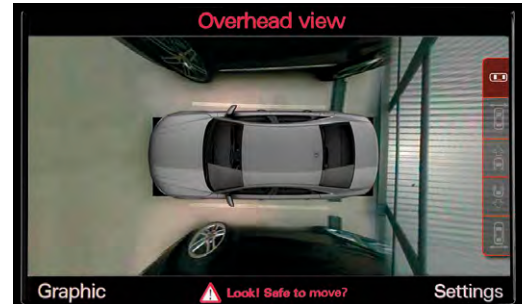

Top and corner view cameras

Four cameras on this available technology allow for an overhead view of your surroundings, making parking just a little easier. The technology shows you where your vehicle is in relation to obstacles nearby, helping give you the confidence to maneuver in practically any environment.



Head-up display

With easy-to-view, accurate visual information right at eye level, this available feature displays important driving information and even pedestrian-detection warnings when equipped with the night vision assistant.

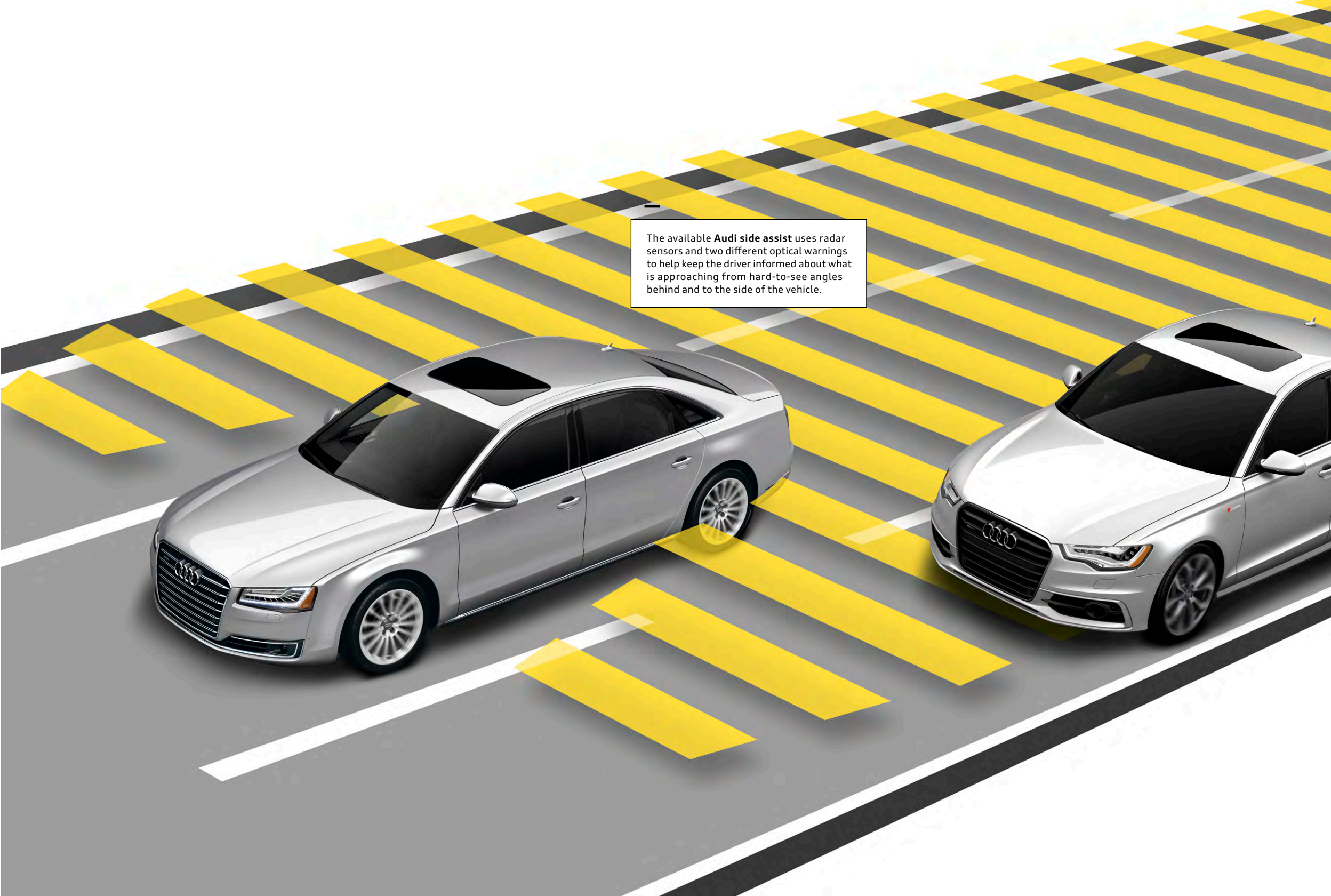

The available **Audi side assist** uses radar sensors and two different optical warnings to help keep the driver informed about what is approaching from hard-to-see angles behind and to the side of the vehicle.



ultra®

Heavy thinking on
lightweight technology.

A little give requires a lot of strength.

Audi engineers don't equate strength with size. Big is just big—strong is a more flexible concept. While you may not think about weight savings when it comes to strength, we'd like you to take a second and think again. The ASF® aluminum construction developed by Audi engineers, and utilized in the Audi A8, is a revolution in lightweight technology. It offers an innovative approach to both weight savings and strength as part of the ultra® lightweight technologies. The ten standard airbags in the A8 rely on a technology that is designed to respond differently based on seat position, and specially constructed crumple zones give way upon impact to help mitigate potential injury in a collision.¹ All of this, combined with the rigidity of laser seam-welded joints that enhance the strength of every Audi we make, helps diminish the impact of an unavoidable event.

ASF® aluminum construction

Lightweight yet unyielding, revolutionary ultra lightweight technology offers an innovative approach to weight savings—a benefit you will notice in the overall efficiency, enhanced performance and remarkable handling of the Audi A8.² These unique characteristics also help to absorb the normal bumps of the road, delivering a smoother ride.

Ten airbags

The A8 is equipped with a full complement of ten airbags to offer additional protection in the event of a collision. Head airbags for both driver and front passenger are designed to specifically target and protect the head during collisions, for added protection.¹

- ▶ driver's head airbag
- ▶ driver's knee airbag
- ▶ driver-side seat-mounted thorax side airbag
- ▶ driver-side Sideguard® head curtain airbag for both rows of seats
- ▶ driver-side rear seat-mounted thorax side airbag
- ▶ front-passenger head airbag
- ▶ front-passenger knee airbag
- ▶ front-passenger seat-mounted thorax side airbag
- ▶ passenger-side Sideguard head curtain airbag for both rows of seats
- ▶ passenger-side rear seat-mounted thorax side airbag

¹ Airbags are supplemental restraints only and will not deploy in all crash circumstances. Always use safety belts and seat children only in the rear, using restraint systems appropriate for their size and age.
² See www.fueleconomy.gov for EPA estimates. Your mileage will vary, and depends on several factors, including your driving habits and vehicle condition.

Passive safety refers to all dedicated measures that help protect the vehicle's occupants against injury. The passive safety measures in the A8 include its safety belt system, ten air-bags, the rigid occupant cell and crumple zones at the front and rear of the vehicle.

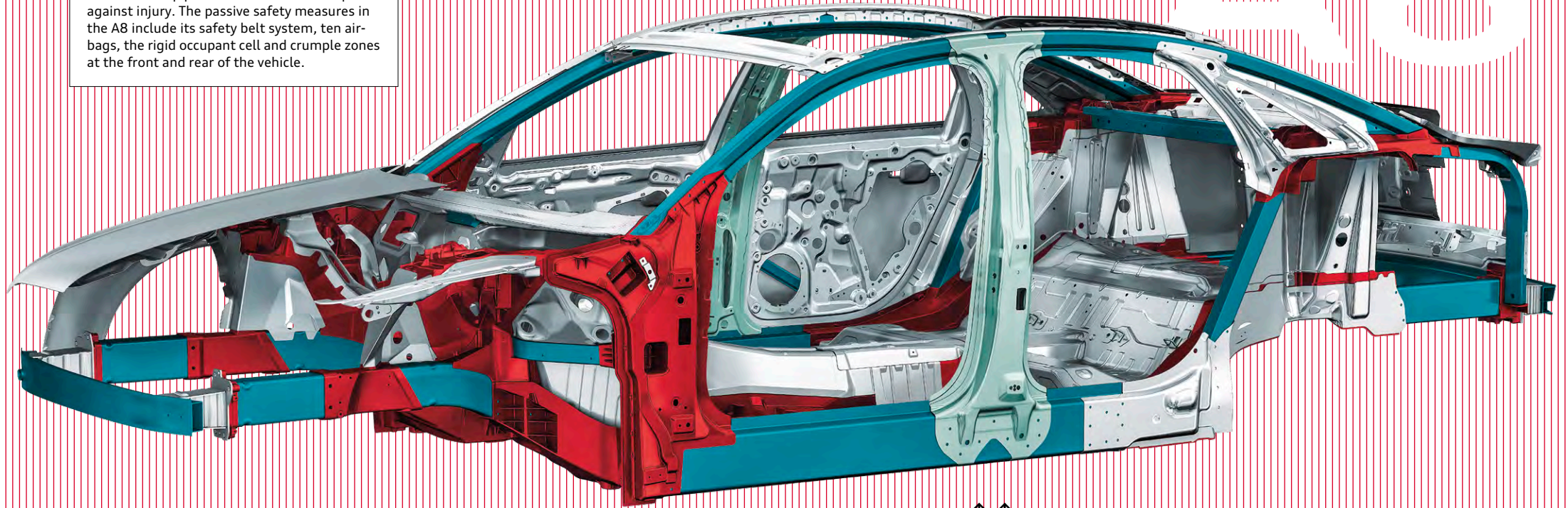





Aluminum castings

Our large aluminum castings are a telling example of ultra® lightweight technology. Primarily used in high-stress areas, these multifunctional castings achieve exceptional rigidity while also allowing for freedom of design, all while remaining extremely lightweight.



B-pillar

The B-pillar is a welded steel assembly. The pillar is manufactured from ultra-high-strength, hot-formed steel while the striker panel is made from advanced, high-strength steel. The assembly is attached to the body using flow drill screws and adhesive bonding to increase strength.

-  extruded aluminum sections
-  cast aluminum
-  ultra-high-strength steel
-  sheet aluminum



MMI System

Putting your needs front and center.

A touch of genius is simplicity itself.

A lot can be said with a simple touch. Case in point, MMI® touch. A revolution in intelligent simplicity, MMI touch with handwriting recognition is a technology that gives you the ability to give commands and retrieve media simply by its recognizing a few strokes of your finger. Access information such as music files, contact information and destinations through the MMI touch—or give input to Audi connect®, an innovative infotainment system infused with the power of Google™ technology.^{1,2} Now staying in touch with your world isn't just a good gesture, it's one simple gesture.^{1,2}

MMI touch

Developed by the Audi Human Machine Interface (HMI) team, MMI touch illustrates why making something simple to use can be so complex. The HMI team designed a system so advanced, it can read almost anyone's handwriting—even if you choose to write with your non-dominant hand.



1. Always pay careful attention to the road, and do not drive while distracted. The features and technologies discussed above are optional, may require an additional subscription with separate terms and conditions, and should be used only when it is safe and appropriate. The Wi-Fi® hotspot feature is intended for passenger use only. 2. See Infotainment/Technology section of the Featured Content page for important information regarding MMI® navigation plus and required SiriusXM® subscriptions.



↑ ↑

MMI touch

- ▶ letter and number entries for destinations and contacts
- ▶ radio preset selection
- ▶ album-cover scrolling
- ▶ map scrolling
- ▶ sound distribution adjustment

Menu button

Choose your path of least resistance.

↓ ↓



↑ ↑

Function buttons

Helping you navigate through the MMI system with ease are four well-placed function buttons. Each button correlates to a command at the corner of the screen and, when pressed, takes you to your desired selection.

SiriusXM® Satellite Radio

Go ahead. Crisscross the country. We assure you, you'll never run out of entertainment options, with over 150 channels of music, talk, sports and news?

↓ ↓



↑ ↑

Tone button

Going beyond the "treble" and "bass" levels, the Tone button allows you to set surround effect levels throughout your cabin, to give you the full experience of your BOSE® Surround Sound System. It also allows you to activate AudioPilot® to deliver dynamic driving noise compensation, adjusting the volume levels automatically to the ambient cabin sounds.

Tell us what you're looking for and we'll deliver you to it.

Don't reach—relax. With Audi connect®, you may never have to reach out again.¹ While touchscreens are seemingly everywhere, they don't need to be in your vehicle. Thanks to Google Voice™ Local Search, Audi connect allows you to quickly search Google™ by simple voice commands (use only when the car is stationary).¹ The crisp display is mounted farther up, closer to the windshield and near your sight line to the road ahead. For those times when you are feeling tactile, we've placed toggle buttons near the gear shifter, where your hand naturally rests when using them. So while other automobile manufacturers still want you to reach out, we've found a few ways for you to make information a lot more accessible while your hands are on the wheel.¹



SiriusXM® Traffic

Get traffic information overlaid onto available 3D satellite imagery to visualize a true aerial view of your route, and let the MMI navigation plus system reconfigure your route to help avoid traffic.^{1,2}

NEWS

News feeds

Stay on top of the news by having headlines and stories delivered right to your MMI® display.¹

POI

Point-of-interest

The point-of-interest search with voice control means that the digital world is with you on every journey.¹

myAudi

myAudi features

Plan travel from your personal computer. Send your desired destinations to your vehicle ahead of time and access your route from your vehicle later.¹



Mobile Wi-Fi® hotspot

Provides high-speed connectivity for up to eight passenger devices through an onboard wireless hub.¹



¹ Always pay careful attention to the road, and do not drive while distracted. The features and technologies discussed above are optional, may require an additional subscription with separate terms and conditions, and should be used only when it is safe and appropriate. The Wi-Fi® hotspot feature is intended for passenger use only. ² See Infotainment/Technology section of the Featured Content page for important information regarding required SiriusXM® subscriptions. ³ Parking feature is not available everywhere and requires participation by parking provider.



Google Earth™ with 3D satellite imagery

With Google Earth™ integration, you'll enjoy 3D satellite imagery, including Google Maps Street View, displayed right on the MMI display.¹



Weather information

Current local conditions and forecasts for your destination can help you prepare for your trip.¹



Google Voice™ Local Search

Simply tell your Audi what you are in the mood for, then let the cloud-processing power of Google™ speech recognition interpret your request and bring up a list of destinations in the area of your choice.¹



Google Maps Street View

With Google Maps Street View, your vehicle can show you a driver's-eye view of your destination right before you arrive so it's easy to recognize.¹



Parking information

Search for parking in your area of interest, check space availability and set your selection as a destination to help navigate directly to the garage entrance.^{1,3}



City events

Get information about current events, exciting locations and places of interest at your travel destination, current location or other chosen location instantly.¹



Travel info

Discover local landmarks in your area of interest, set them as your destinations, and let your vehicle lead the way as you explore the world around you.¹





Sound

Audi is Latin for "listen," so you know we take sound very seriously.

52 Hz

Low note on a kick drum

True bass tones are something you feel more than hear, and when a kick drum hits you with a frequency of 52 Hz, you definitely feel it. Knowing this, Audi sound engineers worked to reproduce sounds at this level for an exceptionally realistic experience.

2,093 Hz

High note on a piano

Even at a frequency of 2,093 Hz, the equivalent of the double high C note found on a piano, the sound system clearly and effortlessly reproduces the sound, giving you front row seats to every symphony.

261 Hz

Singing middle C

At a frequency of around 261 Hz, you'll find middle C. It is around this frequency that much of the brilliantly orchestrated sound is reproduced by the numerous, strategically placed speakers.

Lend us your ear.

It's been said that people only hear what they want to. That what they don't like just goes in one ear and out the other. Well, for those people and everyone else, we offer two sound systems that make every note worthy of your eardrum's full attention. From perfectly sculpted high notes to a crystal clear mid-range to deep-diving lows, the BOSE® and available Bang and Olufsen® sound systems are a veritable orchestra of engineering that fills the cabin with faithfully rendered, thrilling sound. So whether you're the type that wants to be soothed by sound or the type that wants to be inspired by it, we promise, if you take a moment to listen, that what you'll hear will be utterly impossible to ignore.

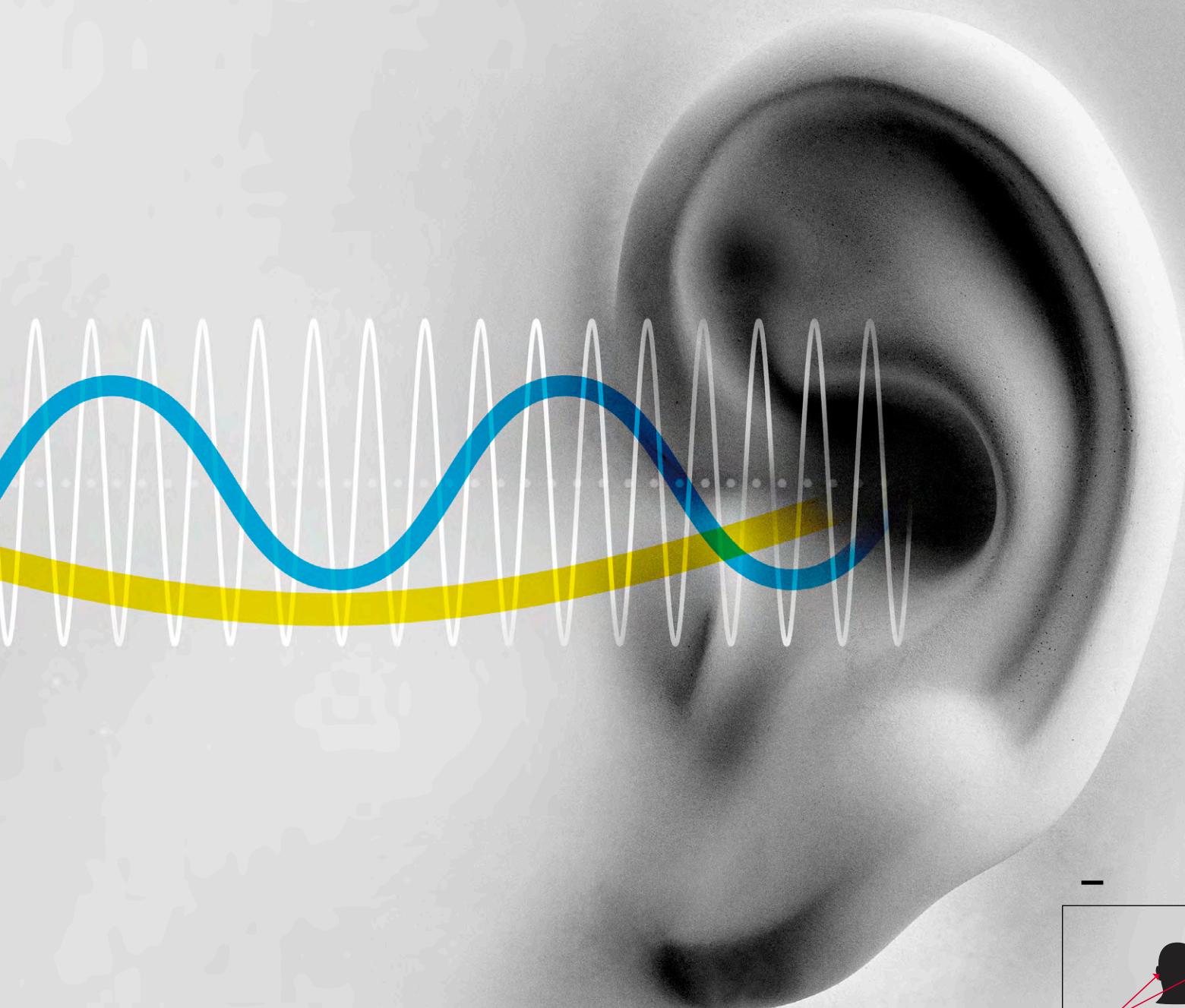

Bang & Olufsen® Advanced Sound System

The passion of Bang & Olufsen® matches well with Audi. By focusing on design and performance together, we bring out the best in outstanding acoustics. Bang & Olufsen® engineers help to sculpt meticulously rendered sound through 19 speakers (including two innovative retractable aluminum acoustic lenses) and an impressive 1,400 watts of pure power.

BOSE® Surround Sound System

Hitting the right note on every drive, the BOSE® Surround Sound System turns your Audi into a 14-speaker powerhouse with the help of innovative sound engineering and optimized speaker placement. Add to that AudioPilot® noise compensation, which helps maintain a consistent volume under varying speeds and road conditions, and you get an acoustic listening environment that rivals any live performance.

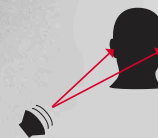

Unlike with high-frequency sounds, the brain cannot detect where low bass frequencies are coming from, making it seem as if the sound is hitting both ears at the same time. Because of this, Bang & Olufsen® sound engineers only had to design one custom-fitted subwoofer to reproduce the kind of deep, cabin-filling bass that brings music to life.



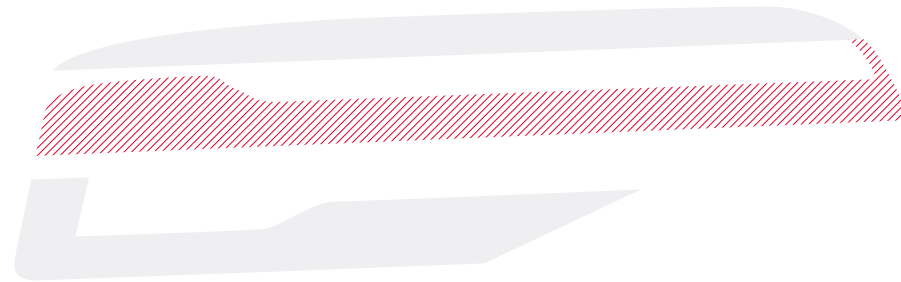

LED taillights

LEDs are among the most luminous taillights available. And, like Audi vehicles, they are efficient, technologically advanced and long-lasting.

Closing the deal with signature brilliance.

We wanted to say goodbye with style—that's the only way we do it. Our flagship Audi A8 exemplifies supreme luxury, from headlights to taillights. We haven't left anything to the imagination, and have insisted on incorporating only the most brilliant features throughout the A8. Attention to every detail inspired us to design LED lighting technology into the taillights, as we did with the full LED headlights, to continue the bold statement we've committed to throughout the vehicle. The LED taillights punctuate our commitment to designing a vehicle that inspires you from end to end. Everyone knows when an Audi is approaching—now it's clearer than ever when one passes you by.

3.0T

A8/A8 L 3.0T featured highlights

- ▶ Full LED headlights
- ▶ Power-adjustable, power-folding, auto-dimming, heated exterior side mirrors with memory
- ▶ Power soft-closing doors
- ▶ Power trunk with hands-free release
- ▶ Four-zone automatic climate control (A8 L)
- ▶ Power tilt and telescopic adjustable steering column with memory
- ▶ Comfort front center armrest with split fore/aft and height adjustment
- ▶ Ambient LED interior lighting plus
- ▶ Power rear sunshade
- ▶ Heated 18-way power front seats, including power lumbar adjustment and memory
- ▶ Front and rear comfort headrests
- ▶ MMI® navigation plus with voice control system¹
- ▶ MMI® touch with handwriting-recognition technology
- ▶ Audi connect® with six-month trial subscription²
- ▶ 7" color driver information system
- ▶ BOSE® Surround Sound System with 14 speakers, AudioPilot® noise-compensation and 630 watts
- ▶ SiriusXM® Satellite Radio with 90-day trial subscription³
- ▶ BLUETOOTH® wireless technology preparation for compatible mobile phone
- ▶ Audi advanced key—keyless start, stop and entry⁴
- ▶ Parking system plus with rear view camera (front and rear acoustic parking sensors)

Available packages and stand-alone options

(For more details see Packages and Options pages)

- ▶ Premium package
- ▶ Luxury package
- ▶ Cold Weather package
- ▶ Warm Weather package (A8)
- ▶ Sport package
- ▶ Driver Assistance package
- ▶ Rear Seat Comfort package (A8 L)
- ▶ Assam Gray Vavona Wood inlays
- ▶ Brown/Silver Poplar Wood inlays
- ▶ Brown/Gold Natural Fine Grain Ash Wood inlays
- ▶ Black cloth headliner
- ▶ Alcantara® headliner (matching interior or Black option)
- ▶ Panoramic sunroof (A8 L)
- ▶ Solar sunroof
- ▶ Rear Seat Entertainment with dual 10" screens and DVD single slot
- ▶ Night vision assistant with pedestrian and larger animal detection
- ▶ 20" 15-spoke design wheels with 265/40 all-season tires⁵
- ▶ 20" 10-parallel-spoke design wheels with 265/40 all-season tires⁵



Four-spoke multifunction steering wheel with shift paddles and 7" color driver information system



Full LED headlights



Integrated twin-trapezoidal exhaust outlets



High-gloss Black lower decorative inlays (A8 L)

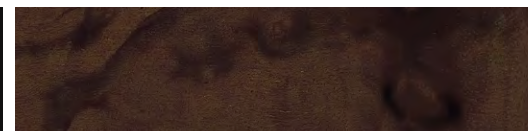

Dark Brown Walnut Wood upper decorative inlays



Brushed Aluminum lower decorative inlays (A8)

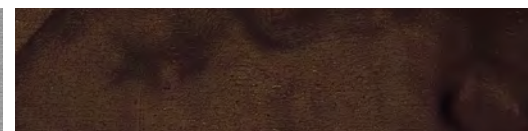

Dark Brown Walnut Wood upper decorative inlays



BOSE® Surround Sound System with 14 speakers, AudioPilot® noise-compensation and 630 watts



MMI® navigation plus with Audi connect®^{1,2}



Leather-wrapped Yacht design shift lever



19" 15-spoke design wheels with 255/45 all-season tires⁵



Comfort head restraints



¹ MMI® navigation plus depends on signals from the worldwide Global Positioning Satellite network. The vehicle's electrical system and existing wireless and satellite technologies must be available and operating properly for the system to function. The system is designed to provide you with suggested routes in locating addresses, destinations and other points of interest. Changes in street names, construction zones, traffic flow, points of interest and other road system changes are beyond the control of Audi of America, Inc. Complete detailed mapping of lanes, roads, streets, toll roads, highways, etc., is not possible, therefore you may encounter discrepancies between the mapping and your actual location. Please rely on your individual judgment in determining whether or not to follow a suggested MMI® navigation plus route. For mapping updates please see your Audi dealer or call 1-800-FOR-AUDI for details. ² Always pay careful attention to the road, and do not drive while distracted. The features and technologies discussed above are optional, may require an additional subscription with separate terms and conditions, and should be used only when it is safe and appropriate. The Wi-Fi® hotspot feature is intended for passenger use only. ³ SiriusXM Satellite Radio and SiriusXM Traffic subscriptions are sold separately or as a package after trial period and are continuous until you call SiriusXM to cancel. See Customer Agreement for complete terms and more information at www.siriusxm.com. SiriusXM Traffic service available in select markets. SiriusXM U.S. Satellite Service available only to those in the 48 contiguous U.S.A., D.C. and Puerto Rico (with coverage limitations). ⁴ Some Audi models are equipped with a keyless ignition feature. The details as to how the system works can vary, and Audi owners should consult their owner's literature or an authorized Audi dealer if they have further questions about the operation of this feature. Please note that Audi warns against leaving the vehicle unattended with the engine running, particularly in enclosed spaces. ⁵ High-performance tires are designed for better performance and handling in warm climates. When driving in cold, snowy or icy weather, you should equip your vehicle with four all-season or winter tires, which offer better traction under those conditions. We suggest you use the Audi-recommended winter or all-season tires specified for your Audi. High-performance tires also have a lower aspect ratio that aids performance and handling. Driving over rough or damaged road surfaces, as well as debris, curbs and other obstacles, can cause serious damage to wheels, tires, vehicle body and suspension parts. Be careful to avoid road hazards and reduce your speed, especially if your vehicle is equipped with low-profile tires. Please also remember when making your selection that, while these tires deliver responsive handling, they may ride less comfortably and make more noise than others. Finally, these tires may wear more quickly than other choices. It is important that the inflation pressure is regularly checked and maintained at recommended levels.

TDI

A8 L TDI® featured highlights

- ▶ Full LED headlights
- ▶ Power-adjustable, power-folding, auto-dimming, heated exterior side mirrors with memory
- ▶ Power soft-closing doors
- ▶ Power trunk with hands-free release
- ▶ Four-zone automatic climate control
- ▶ Power tilt and telescopic adjustable steering column with memory
- ▶ Comfort front center armrest with split fore/aft and height adjustment
- ▶ Ambient LED interior lighting plus
- ▶ Power rear side and rear sunshades
- ▶ Heated 18-way power front seats, including power lumbar adjustment and memory
- ▶ Front and rear comfort headrests
- ▶ MMI® navigation plus with voice control system¹
- ▶ MMI® touch with handwriting-recognition technology
- ▶ Audi connect® with six-month trial subscription²
- ▶ 7" color driver information system
- ▶ BOSE® Surround Sound System with 14 speakers, AudioPilot® noise-compensation and 630 watts
- ▶ SiriusXM® Satellite Radio with 90-day trial subscription³
- ▶ BLUETOOTH® wireless technology preparation for compatible mobile phone
- ▶ Audi advanced key—keyless start, stop and entry⁴
- ▶ Parking system plus with rear view camera (front and rear acoustic parking sensors)

Available packages and stand-alone options

(For more details see Packages and Options pages)

- ▶ Premium package
- ▶ Luxury package
- ▶ Cold Weather package
- ▶ Sport package
- ▶ Driver Assistance package
- ▶ Rear Seat Comfort package
- ▶ Balao Brown Audi design selection package
- ▶ Assam Gray Vavona Wood inlays
- ▶ Brown/Silver Poplar Wood inlays
- ▶ Brown/Gold Natural Fine Grain Ash Wood inlays
- ▶ Black cloth headliner
- ▶ Alcantara® headliner (matching interior or Black option)
- ▶ Panoramic sunroof
- ▶ Solar sunroof
- ▶ Bang & Olufsen® Advanced Sound System with 19 speakers and 1,400 watts
- ▶ Rear Seat Entertainment with dual 10" screens and DVD single slot
- ▶ Night vision assistant with pedestrian and larger animal detection
- ▶ 20" 15-spoke design wheels with 265/40 all-season tires⁵
- ▶ 20" 10-parallel-spoke design wheels with 265/40 all-season tires⁵



Four-spoke multifunction steering wheel with shift paddles and 7" color driver information system



Full LED headlights



Integrated twin-trapezoidal exhaust outlets



High-gloss Black lower decorative inlays

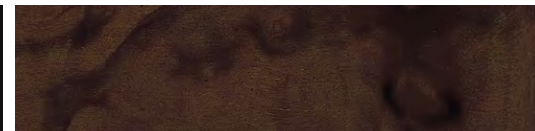

Dark Brown Walnut Wood upper decorative inlays



BOSE® Surround Sound System with 14 speakers, AudioPilot® noise-compensation and 630 watts



MMI® navigation plus with Audi connect®^{1,2}



Leather-wrapped Yacht design shift lever



19" 15-spoke design wheels with 255/45 all-season tires⁵



Comfort head restraints



¹ MMI® navigation plus depends on signals from the worldwide Global Positioning Satellite network. The vehicle's electrical system and existing wireless and satellite technologies must be available and operating properly for the system to function. The system is designed to provide you with suggested routes in locating addresses, destinations and other points of interest. Changes in street names, construction zones, traffic flow, points of interest and other road system changes are beyond the control of Audi of America, Inc. Complete detailed mapping of lanes, roads, streets, toll roads, highways, etc., is not possible, therefore you may encounter discrepancies between the mapping and your actual location. Please rely on your individual judgment in determining whether or not to follow a suggested MMI® navigation plus route. For mapping updates please see your Audi dealer or call 1-800-FOR-AUDI for details. ² Always pay careful attention to the road, and do not drive while distracted. The features and technologies discussed above are optional, may require an additional subscription with separate terms and conditions, and should be used only when it is safe and appropriate. The Wi-Fi® hotspot feature is intended for passenger use only. ³ SiriusXM Satellite Radio and SiriusXM Traffic subscriptions are sold separately or as a package after trial period and are continuous until you call SiriusXM to cancel. See Customer Agreement for complete terms and more information at www.siriusxm.com. SiriusXM Traffic service available in select markets. SiriusXM U.S. Satellite Service available only to those in the 48 contiguous U.S.A., D.C. and Puerto Rico (with coverage limitations). ⁴ Some Audi models are equipped with a keyless ignition feature. The details as to how the system works can vary, and Audi owners should consult their owner's literature or an authorized Audi dealer if they have further questions about the operation of this feature. Please note that Audi warns against leaving the vehicle unattended with the engine running, particularly in enclosed spaces. ⁵ High-performance tires are designed for better performance and handling in warm climates. When driving in cold, snowy or icy weather, you should equip your vehicle with four all-season or winter tires, which offer better traction under those conditions. We suggest you use the Audi-recommended winter or all-season tires specified for your Audi. High-performance tires also have a lower aspect ratio that aids performance and handling. Driving over rough or damaged road surfaces, as well as debris, curbs and other obstacles, can cause serious damage to wheels, tires, vehicle body and suspension parts. Be careful to avoid road hazards and reduce your speed, especially if your vehicle is equipped with low-profile tires. Please also remember when making your selection that, while these tires deliver responsive handling, they may ride less comfortably and make more noise than others. Finally, these tires may wear more quickly than other choices. It is important that the inflation pressure is regularly checked and maintained at recommended levels.

4.0T

A8/A8 L 4.0T featured highlights

- ▶ Full LED headlights
- ▶ Power-adjustable, power-folding, auto-dimming, heated exterior side mirrors with memory
- ▶ Power soft-closing doors
- ▶ Power trunk with hands-free release
- ▶ Four-zone automatic climate control (A8 L)
- ▶ Power tilt and telescopic adjustable steering column with memory
- ▶ Comfort front center armrest with split fore/aft and height adjustment
- ▶ Ambient LED interior lighting plus
- ▶ Power rear sunshade
- ▶ Heated 18-way power front seats, including power lumbar adjustment and memory
- ▶ Front and rear comfort headrests
- ▶ MMI® navigation plus with voice control system¹
- ▶ MMI® touch with handwriting-recognition technology
- ▶ Audi connect® with six-month trial subscription²
- ▶ 7" color driver information system
- ▶ BOSE® Surround Sound System with 14 speakers, AudioPilot® noise-compensation and 630 watts
- ▶ SiriusXM® Satellite Radio with 90-day trial subscription³
- ▶ BLUETOOTH® wireless technology preparation for compatible mobile phone
- ▶ Audi advanced key—keyless start, stop and entry⁴
- ▶ Parking system plus with rear view camera (front and rear acoustic parking sensors)

Available packages and stand-alone options

(For more details see Packages and Options pages)

- ▶ Premium package
- ▶ Luxury package
- ▶ Cold Weather package
- ▶ Warm Weather package (A8)
- ▶ Sport package
- ▶ Driver Assistance package
- ▶ Rear Seat Comfort package (A8 L)
- ▶ Executive Rear Seat package (A8 L)
- ▶ Balao Brown Audi design selection package
- ▶ Assam Gray Vavona Wood inlays
- ▶ Brown/Silver Poplar Wood inlays
- ▶ Brown/Gold Natural Fine Grain Ash Wood inlays
- ▶ Black cloth headliner
- ▶ Alcantara® headliner (matching interior or Black option)
- ▶ Panoramic sunroof (A8 L)
- ▶ Solar sunroof
- ▶ Bang & Olufsen® Advanced Sound System with 19 speakers and 1,400 watts
- ▶ Rear Seat Entertainment with dual 10" screens and DVD single slot
- ▶ Night vision assistant with pedestrian and larger animal detection
- ▶ 20" 15-spoke design wheels with 265/40 all-season tires⁵
- ▶ 20" 10-parallel-spoke design wheels with 265/40 all-season tires⁵



Four-spoke multifunction steering wheel with shift paddles and 7" color driver information system



Full LED headlights



Integrated twin-trapezoidal exhaust outlets



High-gloss Black lower decorative inlays (A8 L)

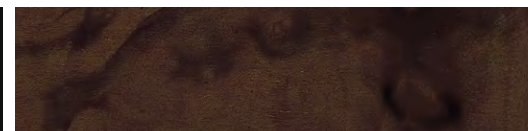

Dark Brown Walnut Wood upper decorative inlays



Brushed Aluminum lower decorative inlays (A8)

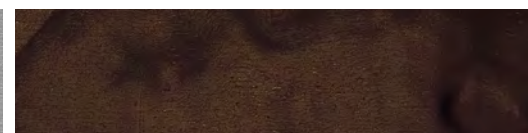

Dark Brown Walnut Wood upper decorative inlays



BOSE® Surround Sound System with 14 speakers, AudioPilot® noise-compensation and 630 watts



MMI® navigation plus with Audi connect®^{1,2}



Leather-wrapped Yacht design shift lever



19" 15-spoke design wheels with 255/45 all-season tires⁵



Comfort head restraints



¹ MMI® navigation plus depends on signals from the worldwide Global Positioning Satellite network. The vehicle's electrical system and existing wireless and satellite technologies must be available and operating properly for the system to function. The system is designed to provide you with suggested routes in locating addresses, destinations and other points of interest. Changes in street names, construction zones, traffic flow, points of interest and other road system changes are beyond the control of Audi of America, Inc. Complete detailed mapping of lanes, roads, streets, toll roads, highways, etc., is not possible, therefore you may encounter discrepancies between the mapping and your actual location. Please rely on your individual judgment in determining whether or not to follow a suggested MMI® navigation plus route. For mapping updates please see your Audi dealer or call 1-800-FOR-AUDI for details. ² Always pay careful attention to the road, and do not drive while distracted. The features and technologies discussed above are optional, may require an additional subscription with separate terms and conditions, and should be used only when it is safe and appropriate. The Wi-Fi® hotspot feature is intended for passenger use only. ³ SiriusXM Satellite Radio and SiriusXM Traffic subscriptions are sold separately or as a package after trial period and are continuous until you call SiriusXM to cancel. See Customer Agreement for complete terms and more information at www.siriusxm.com. SiriusXM Traffic service available in select markets. SiriusXM U.S. Satellite Service available only to those in the 48 contiguous U.S.A., D.C. and Puerto Rico (with coverage limitations). ⁴ Some Audi models are equipped with a keyless ignition feature. The details as to how the system works can vary, and Audi owners should consult their owner's literature or an authorized Audi dealer if they have further questions about the operation of this feature. Please note that Audi warns against leaving the vehicle unattended with the engine running, particularly in enclosed spaces. ⁵ High-performance tires are designed for better performance and handling in warm climates. When driving in cold, snowy or icy weather, you should equip your vehicle with four all-season or winter tires, which offer better traction under those conditions. We suggest you use the Audi-recommended winter or all-season tires specified for your Audi. High-performance tires also have a lower aspect ratio that aids performance and handling. Driving over rough or damaged road surfaces, as well as debris, curbs and other obstacles, can cause serious damage to wheels, tires, vehicle body and suspension parts. Be careful to avoid road hazards and reduce your speed, especially if your vehicle is equipped with low-profile tires. Please also remember when making your selection that, while these tires deliver responsive handling, they may ride less comfortably and make more noise than others. Finally, these tires may wear more quickly than other choices. It is important that the inflation pressure is regularly checked and maintained at recommended levels.

W12

A8 L W12 featured highlights

- ▶ Dynamic steering
- ▶ Singleframe® grille with twin-bar design and diamond-mesh inserts
- ▶ Full LED headlights
- ▶ Power-adjustable, power-folding, auto-dimming, heated exterior side mirrors with memory
- ▶ Power soft-closing doors
- ▶ Power trunk with hands-free release
- ▶ Four-zone automatic climate control
- ▶ Power tilt and telescopic adjustable steering column with memory
- ▶ Comfort front center armrest with split fore/aft and height adjustment
- ▶ Illuminated door sill inlays (with W12 emblem)
- ▶ Ambient LED interior lighting plus
- ▶ Headliner grab handles with decorative wood inlay
- ▶ Dual-pane acoustic glass
- ▶ Power rear side and rear sunshades
- ▶ Panoramic sunroof
- ▶ 22-way power front comfort seats, including power lumbar adjustment, ventilation, massage function and memory
- ▶ Heated power rear seats, including power lumbar adjustment, ventilation and massage function
- ▶ Front and rear comfort headrests
- ▶ MMI® navigation plus with voice control system¹
- ▶ MMI® touch with handwriting-recognition technology
- ▶ Audi connect® with six-month trial subscription²
- ▶ BOSE® Surround Sound System with 14 speakers, AudioPilot® noise-compensation and 630 watts
- ▶ Rear Seat Entertainment with dual 10" screens and DVD single slot
- ▶ Audi side assist with Audi pre sense® rear
- ▶ Head-up display with navigation information
- ▶ Top and corner view camera system

Available packages and stand-alone options

(For more details see Packages and Options pages)

- ▶ Sport package
- ▶ Driver Assistance package
- ▶ Executive Rear Seat package
- ▶ Balao Brown Audi design selection package
- ▶ Assam Gray Vavona Wood inlays
- ▶ Brown/Silver Poplar Wood inlays
- ▶ Brown/Gold Natural Fine Grain Ash Wood inlays
- ▶ Brown Walnut Wood inlays
- ▶ High-gloss Black lower inlays
- ▶ Black Alcantara® headliner
- ▶ Solar sunroof
- ▶ Bang & Olufsen® Advanced Sound System with 19 speakers and 1,400 watts
- ▶ Night vision assistant with pedestrian detection
- ▶ 19" 15-spoke design wheels with 255/45 all-season tires³
- ▶ 20" 10-parallel-spoke design wheels with 265/40 all-season tires³



Four-spoke multifunction steering wheel with shift paddles, 7" color driver information system, and head-up display



Full LED headlights



Audi side assist with Audi pre sense® rear

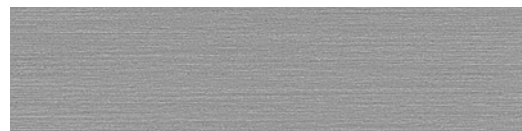

Brushed Aluminum lower decorative inlays



Piano Black Wood upper decorative inlays



BOSE® Surround Sound System with 14 speakers, AudioPilot® noise-compensation and 630 watts



MMI® navigation plus with Audi connect®^{1,2}



Dynamic steering



20" 15-spoke design wheels with 265/40 all-season tires³



Rear Seat Entertainment with dual 10" screens and DVD single slot



Panoramic sunroof



¹ MMI® navigation plus depends on signals from the worldwide Global Positioning Satellite network. The vehicle's electrical system and existing wireless and satellite technologies must be available and operating properly for the system to function. The system is designed to provide you with suggested routes in locating addresses, destinations and other points of interest. Changes in street names, construction zones, traffic flow, points of interest and other road system changes are beyond the control of Audi of America, Inc. Complete detailed mapping of lanes, roads, streets, toll roads, highways, etc., is not possible, therefore you may encounter discrepancies between the mapping and your actual location. Please rely on your individual judgment in determining whether or not to follow a suggested MMI® navigation plus route. For mapping updates please see your Audi dealer or call 1-800-FOR-AUDI for details. ² Always pay careful attention to the road, and do not drive while distracted. The features and technologies discussed above are optional, may require an additional subscription with separate terms and conditions, and should be used only when it is safe and appropriate. The Wi-Fi® hotspot feature is intended for passenger use only. ³ High-performance tires are designed for better performance and handling in warm climates. When driving in cold, snowy or icy weather, you should equip your vehicle with four all-season or winter tires, which offer better traction under those conditions. We suggest you use the Audi-recommended winter or all-season tires specified for your Audi. High-performance tires also have a lower aspect ratio that aids performance and handling. Driving over rough or damaged road surfaces, as well as debris, curbs and other obstacles, can cause serious damage to wheels, tires, vehicle body and suspension parts. Be careful to avoid road hazards and reduce your speed, especially if your vehicle is equipped with low-profile tires. Please also remember when making your selection that, while these tires deliver responsive handling, they may ride less comfortably and make more noise than others. Finally, these tires may wear more quickly than other choices. It is important that the inflation pressure is regularly checked and maintained at recommended levels.

Packages

Analogous to the progressive nature in which all our vehicles are engineered are the technologies and offerings available in a variety of packages to enhance the experience of driving an Audi vehicle. To prove that luxury has progressed, we invite you to explore the package that best outfits your Audi A8.

Audi design selection package, Balao Brown

Available on TDI®, 4.0T and W12 models:

- ▶ Balao Brown Valcona leather seating with contrasting White stitching and piping
- ▶ Full Leather package
- ▶ White Alcantara® headliner
- ▶ Balsamic Brown Natural Fine Grain Ash Wood upper decorative inlays and Brushed Aluminum lower decorative inlays
- ▶ Dual pane acoustic glass (standard on A8 L W12)



Cold Weather package

Available on 3.0T, TDI® and 4.0T models:

- ▶ Rear seat pass-through
- ▶ Heated rear seats
- ▶ Heated steering wheel



Driver Assistance package

Available on all models:

- ▶ High beam assistant (standard on A8 L W12)
- ▶ Audi side assist (standard on A8 L W12)
- ▶ Audi active lane assist
- ▶ Audi adaptive cruise control with stop & go
- ▶ Audi pre sense® plus

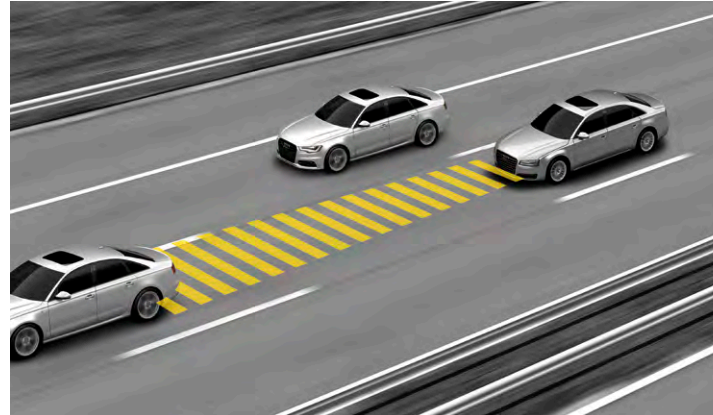

Executive Rear Seat package

Available on A8 L 4.0T and W12 models:

- ▶ Ventilated and heated power rear single seats with power lumbar adjustment, massage function, memory and fixed center console
- ▶ Heated steering wheel (standard on A8 L W12)
- ▶ 12-volt rear power outlet with 115-volt inverter
- ▶ Rear Seat Entertainment system with dual 10" screens and single DVD player (standard on A8 L W12)
- ▶ 10.4-liter capacity refrigerator in center pass-through



Luxury package

Available on 3.0T, TDI® and 4.0T models:

- ▶ Extended Leather package (standard on A8 L)
- ▶ Alcantara® headliner
- ▶ Valcona Leather 22-way power front sport/comfort seats, including power lumbar adjustment, memory and diamond stitch pattern
- ▶ Dual-pane acoustic glass



Packages

Analogous to the progressive nature in which all our vehicles are engineered are the technologies and offerings available in a variety of packages to enhance the experience of driving an Audi vehicle. To prove that luxury has progressed, we invite you to explore the package that best outfits your Audi A8.

Premium package

Available on 3.0T, TDI® and 4.0T models:

- ▶ Audi side assist and Audi pre sense® rear
- ▶ Top and corner view camera system
- ▶ Head up display with navigation information
- ▶ 22-way power front comfort seats, including power lumbar adjustment, ventilation, massage function and memory



Rear Seat Comfort package

Available on A8 L 3.0T, TDI® and 4.0T models:

- ▶ Power rear seats with power lumbar adjustment
- ▶ Rear seat ventilation and massage function



Sport package

Available on all models:

- ▶ Dynamic steering (standard on A8 L W12)
- ▶ Sport differential
- ▶ 20" 5-double-spoke design wheels with 265/40 all season tires¹

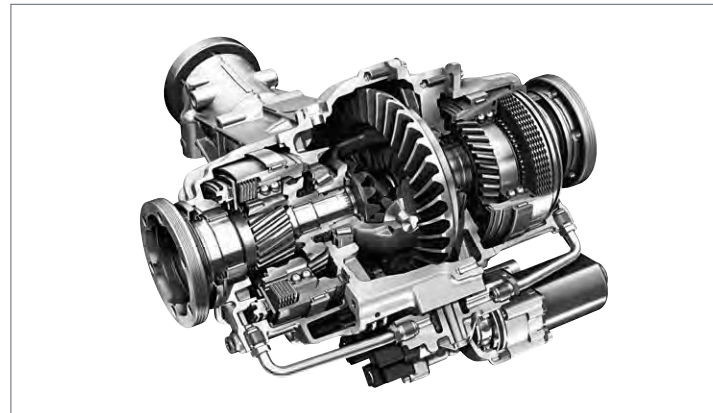

Warm Weather package

Available on A8 3.0T and 4.0T models:

- ▶ Four-zone automatic climate control
- ▶ Power rear side sunshades



¹ High-performance tires are designed for better performance and handling in warm climates. When driving in cold, snowy or icy weather, you should equip your vehicle with four all-season or winter tires, which offer better traction under those conditions. We suggest you use the Audi-recommended winter or all-season tires specified for your Audi. High-performance tires also have a lower aspect ratio that aids performance and handling. Driving over rough or damaged road surfaces, as well as debris, curbs and other obstacles, can cause serious damage to wheels, tires, vehicle body and suspension parts. Be careful to avoid road hazards and reduce your speed, especially if your vehicle is equipped with low-profile tires. Please also remember when making your selection that, while these tires deliver responsive handling, they may ride less comfortably and make more noise than others. Finally, these tires may wear more quickly than other choices. It is important that the inflation pressure is regularly checked and maintained at recommended levels.

Options

In addition to the many packages available for your Audi A8, there are also a host of a la carte options to outfit your vehicle. From a variety of elegant interior trims to technological advancements like the Bang & Olfsen® Advanced Sound System, night vision assistant and a solar sunroof, there's an option to help better complement your lifestyle.



Night vision assistant with pedestrian and large animal detection
(optional on all models)



Alcantara® headliner
(optional on all models)



Black cloth headliner
(optional on 3.0T, TDI® and 4.0T models)



Sunroof with solar power integration
(optional on all models)



Panoramic sunroof
(optional on A8 L 3.0T, TDI® and 4.0T models)



20" 10-parallel-spoke design wheels with 265/40 all-season tires¹
(optional on all models)



20" 15-spoke design wheels with 265/40 all-season tires¹
(optional on 3.0T, TDI® and 4.0T models)



Bang & Olufsen® Advanced Sound System with 19 speakers and 1,400 watts
(optional on TDI®, 4.0T and W12 models)



Rear Seat Entertainment system with dual 10" screens and single DVD player
(optional on 3.0T, TDI® and 4.0T models)



Five-passenger seating configuration
(optional on W12)

¹ High-performance tires are designed for better performance and handling in warm climates. When driving in cold, snowy or icy weather, you should equip your vehicle with four all-season or winter tires, which offer better traction under those conditions. We suggest you use the Audi-recommended winter or all-season tires specified for your Audi. High-performance tires also have a lower aspect ratio that aids performance and handling. Driving over rough or damaged road surfaces, as well as debris, curbs and other obstacles, can cause serious damage to wheels, tires, vehicle body and suspension parts. Be careful to avoid road hazards and reduce your speed, especially if your vehicle is equipped with low-profile tires. Please also remember when making your selection that, while these tires deliver responsive handling, they may ride less comfortably and make more noise than others. Finally, these tires may wear more quickly than other choices. It is important that the inflation pressure is regularly checked and maintained at recommended levels.

Exterior Colors

Brilliant Black



Ibis White

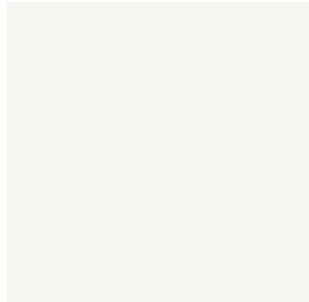

Argus Brown metallic



Cuvée Silver metallic



Florett Silver metallic

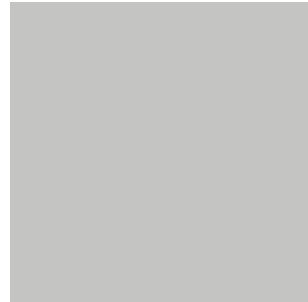

Glacier White metallic

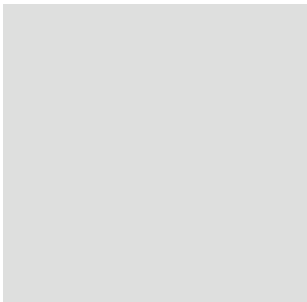

Havanna Black metallic



Monsoon Gray metallic

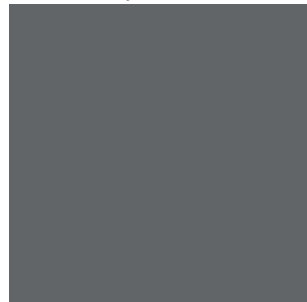

Moonlight Blue metallic



Oolong Gray metallic



Phantom Black pearl

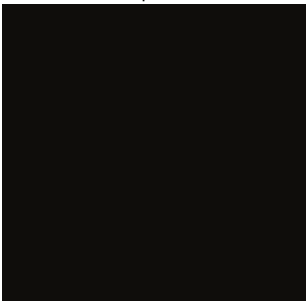

Seat Selections | Interior Colors

Standard Seat



Comfort Seat



Sport/Comfort Seat



Black leather¹

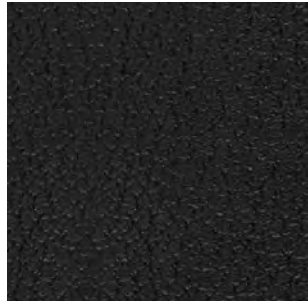

Nougat Brown leather¹



Titanium Gray leather¹

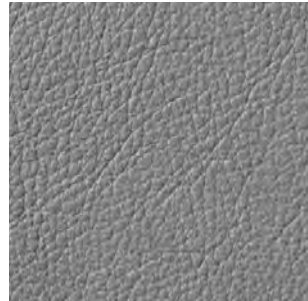

Velvet Beige leather¹



Balao Brown leather¹

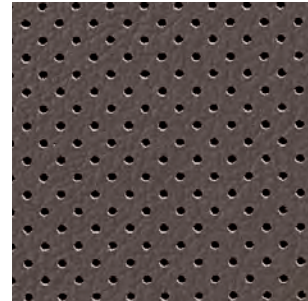

Audi design selection

¹ Interior leathers are available in Valetta or Valcona grains. Each offers the comfort, quality and craftsmanship you would expect from Audi. Not all leather colors are available in all grains. See your dealer for details.

Decorative Inlays



Upper Decorative Inlay Options¹

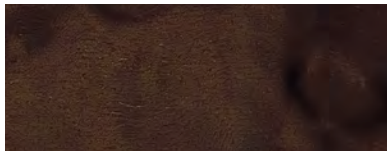

Dark Brown Walnut
Wood inlay



Assam Gray Vavona
Wood inlay

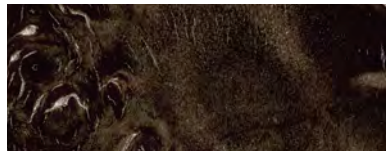

Brown/Silver Poplar Wood inlay



Brown/Gold Natural Fine Grain Wood inlay



Balsamic Brown Natural
Fine Grain Ash Wood inlay (Audi design selection)

¹ Decorative inlay options will vary based on model and interior color combination. See your dealer for details.



Lower Decorative Inlay Options¹



Piano Black Wood inlay
(A8 L W12)

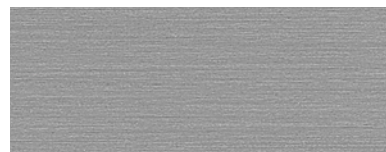

Brushed Aluminum inlay
(A8, A8 L W12, and Audi design selection)



High-gloss Black inlay
(A8 L)

Technical Specifications

Engineering | Performance

	A8 3.0T/A8 L 3.0T	A8 L TDI®	A8 4.0T/A8 L 4.0T	A8 L W12
Engine type	Six-cylinder	Six-cylinder	Eight-cylinder	Twelve-cylinder
Engine block/Cylinder head	Aluminum-alloy	Cast-iron/Aluminum-alloy	Aluminum-alloy	Aluminum-alloy
Displacement (cc)/Bore and stroke (mm)	2,995/84.5 x 89.5	2,967/83.0 x 91.4	3,991/84.5 x 89.5	6,299/86.1 x 90.4
Horsepower (@ rpm)	333 @ 5,300	240 @ 3,500	435 @ 5,100	500 @ 6,200
Torque (lb-ft @ rpm)	325 @ 2,900	428 @ 1,750	444 @ 1,500	463 @ 4,750
Compression ratio	10.3:1	16.3:1	10.1:1	11.8:1
Valvetrain	24-valve DOHC	24-valve DOHC	32-valve DOHC	48-valve DOHC
Induction/Fuel injection	Supercharged/TFSI®	Turbocharged/TDI®	Turbocharged/TFSI®	FSI®
cylinder on demand™ engine efficiency technology/programming ¹	—	—	■	■
Start-stop efficiency system ^{1,2}	■	■	■	—
Acceleration (0–60 mph)	5.4/5.5 seconds	6.3 seconds	4.3/4.4 seconds	4.4 seconds
Top track speed ³	130 mph	130 mph	130 mph	130 mph

Transmission | Drivetrain

Eight-speed Tiptronic® automatic transmission with quattro® all-wheel drive (Gear ratios: 1st: 4.714, 2nd: 3.143, 3rd: 2.106, 4th: 1.667, 5th: 1.285, 6th: 1.000, 7th: 0.839, 8th: 0.667, Reverse: 3.317, Final drive: 3.204 for 3.0T and 4.0T models, 2.624 for TDI® models, 3.076 for W12 models)	■	■	■	■
--	---	---	---	---

Body | Suspension | Chassis

ultra® lightweight technology—ASF® aluminum construction	■	■	■	■
Five-link front suspension	■	■	■	■
Trapezoidal-link rear suspension	■	■	■	■
Audi adaptive air suspension	■	■	■	■
Ventilated front disc/Ventilated rear disc brakes (in)	15.0/14.0	15.0/14.0	15.0/14.0	15.7/14.0
Electromechanical power steering system	■	■	■	■
Dynamic steering	Available	Available	Available	■
Steering ratio	15.1:1	15.1:1	15.1:1	15.1:1
Turning diameter, curb-to-curb (ft)	40.4/41.7	41.7	40.4/41.7	41.7
Sport differential	Available	Available	Available	Available

■ Standard — Not applicable NA Information not available at time of printing

Exterior measurements

	A8 3.0T/A8 L 3.0T	A8 L TDI®	A8 4.0T/A8 L 4.0T	A8 L W12
Wheelbase, A8 (in)	117.8	—	117.8	—
Wheelbase, A8 L (in)	122.9	122.9	122.9	122.9
Length, A8 (in)	202.2	—	202.2	—
Length, A8 L (in)	207.4	207.4	207.4	207.3
Height, A8 (in)	57.5	—	57.5	—
Height, A8 L (in)	57.9	57.9	57.9	57.9
Overall width with mirrors (in)	83.1	83.1	83.1	83.1
Overall width without mirrors (in)	76.7	76.7	76.7	76.7
Track, front/rear (in)	64.7/64.4	64.7/64.4	64.7/64.4	64.7/64.4
Curb weight, A8 (lb)	4,365	—	4,508	—
Curb weight, A8 L (lb)	4,464	4,564	4,619	4,806
Drag coefficient (Cw)	.26	.26	.27	.26

Interior measurements

Head room with sunshade, A8 (in, front/rear)	37.2/38.1	—	37.2/38.1	—
Head room with sunshade, A8 L (in, front/rear)	37.2/39.1	37.2/39.1	37.2/39.1	37.2/38.1
Leg room, A8 (in, front/rear)	41.4/38.7	—	41.4/38.7	—
Leg room, A8 L (in, front/rear)	41.4/42.9	41.4/42.9	41.4/42.9	41.4/42.9
Shoulder room (in, front/rear)	59.1/57.8	59.1/57.8	59.1/57.8	59.1/57.8
Cargo volume (cu ft)	14.2	14.2	14.2	14.2
Seating capacity	5	5	5	4 (5 optional)

EPA mileage estimates | Capacities | Emissions

Tiptronic® automatic transmission, A8 (city/highway/combined)	NA ²	—	18/30/22 ¹	—
Tiptronic® automatic transmission, A8 L (city/highway/combined)	NA ²	24/36/28 ¹	18/29/22 ¹	14/21/17 ¹
Engine oil (qt)	6.3	6.8	8.5	11.8
Fuel (gal)	21.7	21.7	21.7	21.7
Required fuel	Premium	Ultra-low-sulfur diesel	Premium	Premium
Emissions rating	ULEV II	ULEV II	ULEV II	ULEV II

Audi Sport
Truth in Engineering



Technical specifications and featured content for Audi S8 can be found in the **2015 Audi Sport brochure**. See your dealer or go to audiusa.com for details.

Featured Content

Safety | Security

	A8 3.0T/A8 L 3.0T	A8 L TDI®	A8 4.0T/A8 L 4.0T	A8 L W12
Driver and front passenger dual-stage airbags, front thorax side airbags, knee airbags and Sideguard® head curtain airbags ¹	■	■	■	■
Rear-passenger thorax side airbags ¹	■	■	■	■
Front passenger occupant detection for airbags ¹	■	■	■	■
Safety belt reminder for driver and front passenger	■	■	■	■
Lower Anchors and Tethers for CHildren (LATCH) in rear seats	■	■	■	■
Power central locking system with safety unlock feature if airbags deploy	■	■	■	■
Electronic Stability Control (ESC) with traction control (ASR)	■	■	■	■
Anti-lock Brake System (ABS) with secondary collision brake assist and Electronic Brake-pressure Distribution (EBD) and brake assist	■	■	■	■
Tire pressure monitoring system	■	■	■	■
Electromechanical parking brake	■	■	■	■
Anti-theft alarm system with immobilizer	■	■	■	■

Exterior

Singleframe® grille	■	■	■	—
Singleframe® grille with twin-bar design and diamond-mesh inserts	—	—	—	■
Full LED headlights	■	■	■	■
High-beam assistant	Available	Available	Available	■
Headlight washing system	■	■	■	■
Automatic headlights	■	■	■	■
LED taillights and rear fog lights	■	■	■	■
Power-adjustable, power-folding, auto-dimming, heated exterior side mirrors with memory	■	■	■	■
LED turn indicator lights integrated into the exterior side mirrors	■	■	■	■
LED puddle lights	■	■	■	■
Heated windshield washer nozzles	■	■	■	■
Aluminum trim around exterior windows	■	■	■	■
Power soft-closing doors	■	■	■	■
Power trunk with hands-free release	■	■	■	■
Chrome bar integrated into rear bumper	■	■	■	■
Integrated twin-trapezoidal exhaust outlets	■	■	■	■

■ Standard — Not applicable

Interior	A8 3.0T/A8 L 3.0T	A8 L TDI®	A8 4.0T/A8 L 4.0T	A8 L W12
Dual-zone automatic climate control	■/—	—	■/—	—
Four-zone automatic climate control	Available/■	■	Available/■	■
Four-spoke multifunction steering wheel with shift paddles	■	■	■	■
Heated steering wheel	Available	Available	Available	■
Power tilt and telescopic adjustable steering column	■	■	■	■
Leather-wrapped shift lever	■	■	■	■
Decorative interior inlays	■	■	■	■
Ambient LED interior lighting plus	■	■	■	■
Alcantara® headliner (matching interior or Black option)	Available	Available	Available	■
Dual-pane acoustic glass	Available	Available	Available	■
Power rear side sunshades	Available/■	■	Available/■	■
Power rear sunshade	■	■	■	■
Panoramic sunroof	—/Available	Available	—/Available	■
Sunroof (solar power integration optional)	■	■	■	Available

Seating	A8 3.0T/A8 L 3.0T	A8 L TDI®	A8 4.0T/A8 L 4.0T	A8 L W12
18-way power front seats, including power lumbar adjustment and memory	■	■	■	—
22-way power front comfort seats, including power lumbar adjustment, ventilation, massage function and memory	Available	Available	Available	■
22-way power front sport/comfort seats, including power lumbar adjustment, ventilation, massage function memory and diamond-stitch quilting	Available	Available	Available	—
Heated front seats	■	■	■	■
Front and rear comfort headrests	■	■	■	■
Power rear seats with power lumbar adjustment	—/Available	Available	—/Available	Available
Power rear single seats with power lumbar adjustment, memory and fixed center console	—	—	—/Available	■
Heated rear seats	Available	Available	Available	■
Ventilated rear seats with massage function	—/Available	Available	—/Available	■
Passenger-side rear relaxation seat with power footrest (eliminates front passenger seat massage function and limits front passenger seat to 10-way power adjustment)	—	—	—/Available	Available
Refrigerator in center pass-through (10.4-liter capacity, eliminates rear seat pass-through with ski bag)	—	—	—/Available	Available
Rear seat pass-through	Available	Available	Available	■

1 Airbags are supplemental restraints only and will not deploy under all crash circumstances. Always use safety belts and seat children only in the rear, using restraint systems appropriate for their size and age.

Featured Content

Infotainment | Technology

	A8 3.0T/A8 L 3.0T	A8 L TDI®	A8 4.0T/A8 L 4.0T	A8 L W12
MMI® navigation plus with voice control system ¹	■	■	■	■
MMI® touch with handwriting-recognition technology	■	■	■	■
Audi connect® with six-month trial subscription ²	■	■	■	■
7" color driver information system	■	■	■	■
BOSE® Surround Sound System with 14 speakers, AudioPilot® noise-compensation and 630 watts	■	■	■	■
Bang & Olufsen® Advanced Sound System with 19 speakers and 1,400 watts	—	Available	Available	Available
HD Radio™ Technology	■	■	■	■
SiriusXM® Satellite Radio with 90-day trial subscription ³	■	■	■	■
SiriusXM® Traffic with four-year subscription ³	■	■	■	■
SD card slot with 32GB operating capacity (dual slots)	■	■	■	■
Audi music interface with iPod® integration	■	■	■	■
In-dash DVD player	■	■	■	■
Rear Seat Entertainment system with dual 10" screens and single DVD player	Available	Available	Available	■
BLUETOOTH® streaming audio ⁴	■	■	■	■
BLUETOOTH® wireless technology preparation for mobile phone ⁴	■	■	■	■
Two 12-volt power outlets	■	■	■	■
Garage door opener (HomeLink®)	■	■	■	■
Audi advanced key—keyless start, stop and entry ⁵	■	■	■	■
Cruise control with coast, resume and accelerate features	■	■	■	■
Audi adaptive cruise control with stop & go	Available	Available	Available	Available
Audi active lane assist	Available	Available	Available	Available
Audi side assist and Audi pre sense® rear	Available	Available	Available	■
Audi pre sense® plus	Available	Available	Available	Available
Night vision assistant with pedestrian and larger animal detection	Available	Available	Available	Available
Head-up display with navigation information	Available	Available	Available	■
Audi drive select	■	■	■	■
Parking system plus with rear view camera (front and rear acoustic parking sensors)	■	■	■	■
Top and corner view camera system	Available	Available	Available	■
Rain/light sensor for automatic windshield wipers and headlights	■	■	■	■

■ Standard — Not applicable

¹ MMI® navigation plus depends on signals from the worldwide Global Positioning Satellite network. The vehicle's electrical system and existing wireless and satellite technologies must be available and operating properly for the system to function. The system is designed to provide you with suggested routes in locating addresses, destinations and other points of interest. Changes in street names, construction zones, traffic flow, points of interest and other road system changes are beyond the control of Audi of America, Inc. Complete detailed mapping of lanes, roads, streets, toll roads, highways, etc., is not possible, therefore you may encounter discrepancies between the mapping and your actual location. Please rely on your individual judgment in determining whether or not to follow a suggested MMI® navigation plus route. For mapping updates please see your Audi dealer or call 1-800-FOR-AUDI for details. ² See Audi connect® page for important information regarding Audi connect®. ³ SiriusXM Satellite Radio and SiriusXM Traffic subscriptions are sold separately or as a package after trial period and are continuous until you call SiriusXM to cancel. See Customer Agreement for complete terms and more information at www.siriusxm.com. SiriusXM Traffic service available in select markets. SiriusXM U.S. Satellite Service available only to those in the 48 contiguous U.S.A., D.C. and Puerto Rico (with coverage limitations). ⁴ Requires compatible device. ⁵ Some Audi models are equipped with a keyless ignition feature. The details as to how the system works can vary, and Audi owners should consult their owner's literature or an authorized Audi dealer if they have further questions about the operation of this feature. Please note that Audi warns against leaving the vehicle unattended with the engine running, particularly in enclosed spaces.

A masterpiece of your own making.

Experience an even deeper sense of luxury with the Audi design selection package, which features Balao Brown Valcona leather seating along with White seat stitching and piping. We think you'll find that this sensuous pairing brings out the depth of the Balsamic Brown Natural Fine Grain Ash Wood upper inlays and contrasts perfectly with the Brushed Aluminum inlays that lie below. This package, tastefully signified by special badges on the door, is available on select Audi A8 models, giving art aficionados something grand to admire.



Accessories

Add distinction, versatility and the ultimate in self-expression with Audi Genuine Accessories. Whether you load the cargo carrier with climbing gear or add a set of stylish new wheels, we have the accessories that will help enhance every facet of your lifestyle. When purchased from an authorized dealer, all pieces are backed by your vehicle's 4-year/50,000-mile limited warranty or for 12 months/12,000 miles from the accessory purchase date, whichever is greater!¹ If you're looking to personalize or protect the vehicle you love, we have an Audi designed solution that works for you.



Compact cargo carrier

Your gear won't take up valuable trunk space with our aerodynamic carrier that offers a generous 16.95-cu-ft capacity. Size: 81" long, 30" wide, 15" high.²



Aluminum bike rack

This locking holder fits 20- to 80-mm bike frames with both wheels on the bike and helps keep the bike upright as you secure it in place.^{2,3}



Ski and snowboard rack

This rack transports your equipment to the slopes easily and securely. The standard attachment (shown) holds two sets of skis or two snowboards. A deluxe attachment is also available.^{2,3}

Other accessories

Audi Genuine Sport and Design Accessories

Your Audi vehicle features a bold, aggressive stance and strong, stunning lines. Enhance it by adding Audi Genuine Sport and Design Accessories. All are carefully scrutinized in the design and development process. So while they're striking in appearance, they've also passed rigorous quality assessments, including corrosion testing. If you're looking for a bolder appearance or a finishing touch, there is a solution designed by Audi that makes every mile more enjoyable—and more yours.

Audi Guard Comfort and Protection Accessories

Help protect what you love. Audi Guard Comfort and Protection Accessories offer functional, practical items that help keep your Audi in pristine condition. Choose from such useful items as trunk liners that help make clean-up quick and easy, or an easy-to-use storage cover that helps shield the vehicle. Use them all to help reduce wear and tear and keep the vehicle looking like new—inside and out. All are engineered to stringent Audi standards, so you can be assured of their quality and durability.

¹ Audi Genuine Accessories purchased from an authorized Audi dealer are covered for the greater of: (1) the accessory limited warranty period (12 months or 12,000 miles, whichever occurs first) from the time of purchase; or (2) the remainder of the Audi New Vehicle Limited Warranty period (4 years or 50,000 miles, whichever occurs first). See your authorized Audi dealer for details. ² All roof-rack system attachments require the base carrier bars. Base carrier bars are not compatible with the A8 L. All attachments sold separately. ³ Recreational equipment, sporting equipment and luggage not included.



20" 5-arm parabolic wheels

An elegant, open design with five parabolic arms, each described by one thin and one medium blade. The blades and rim edge are machined to a bright finish, and the remaining surfaces are graced by a rich Anthracite tone. Every Audi alloy wheel design is engineered, manufactured and tested to meet rigorous factory and regulatory standards.



Premium textile floor mats

These skid-resistant, precision-fit mats are made of long-life fabric to help protect your vehicle's interior from the elements. Mats are black with silver piping and available in sets of two for front or rear. Rear mats are not available for A8 L.

Indoor car cover

A lightweight, easy-to-use cover helps protect your vehicle's finish. Intended for indoor use only. Includes a storage bag.



A8 all-weather floor mats

Deep-ribbed, channeled design helps protect your vehicle's floor and carpeting from water, mud, sand and snow. Black mats are available in sets of two for front or rear. Front mats feature the A8 logo.

Audi Genuine Electronics Accessories

The illuminating technology that graces each Audi vehicle provides the inspiration for Audi Genuine Electronics Accessories. Similarly, all of these accessories are impressively advanced and inspiring. Our audio options let you enhance your listening pleasure. Other accessory options help promote more convenient travel. All are designed and tested to help ensure compatibility with the vehicle's electrical systems, allowing you to enjoy every aspect of Audi technology with almost all your senses. Demand the best and drive with added confidence.

Audi Genuine Alloy Wheels

Strike the perfect balance between breathtaking design and awe-inspiring performance with Audi Genuine Alloy Wheels. Audi experts have meticulously designed these wheels especially for each Audi model. They're engineered to the highest standards and endure rigorous testing to help ensure long-term quality. Experience eye-catching style that is yours and yours alone. Nothing enhances the bold, dynamic look of your Audi vehicle faster.

Audi TravelSpace Transport Accessories

For every season and every getaway, Audi takes you there. Never leave the necessary gear behind. Be ready for any journey with Audi TravelSpace Transport Accessories. The list includes bike racks, ski racks, a variety of watersports equipment carriers and various sizes of cargo carriers. Wherever you go, make sure almost everything fits with a variety of intelligent and innovative solutions. Accessories designed for your active, passionate lifestyle.

Note: A word about this brochure. Audi of America, Inc., believes the specifications in this brochure to be correct at the time of printing. However, specifications, standard equipment, options, fabrics, and colors are subject to change without notice. Some equipment may be unavailable when your vehicle is built. Please ask your dealer for advice concerning current availability of standard and optional equipment, and your dealer will verify that your vehicle will include the equipment you ordered. Vehicles in this brochure are shown with optional equipment. See your dealer for complete details on the Audi New Vehicle Limited Warranty, twelve-year limited warranty against corrosion perforation, and Audi 24/7 Roadside Assistance. (Roadside assistance coverage provided by Road America in the U.S. Certain conditions apply; see your dealer for details.) Tires supplied by various manufacturers. "Audi," all model names, "ASF," "Audi connect," "Audi pre sense," "cylinder on demand," "e-tron," "FSI," "MMI," "quattro," "Sideguard," "Singleframe," and the Singleframe grille design, "TFSI," "Truth in Engineering," "ultra," and the four rings logo are trademarks or registered trademarks of AUDI AG. "AdBlue" is a registered trademark of the Verband der Automobilindustrie. "Alcantara" is a registered trademark of Alcantara S.p.A. "AudioPilot" is a registered trademark of Bang & Olufsen. The BLUE TOOTH word mark and logos are owned by the Bluetooth SIG, Inc., and any use of such marks by AUDI AG is under license. "BOSE" is a registered trademark of the BOSE Corporation. "Google," "Google Earth," and "Google Voice" are trademarks of Google Inc. "HD Radio" and the HD Radio logo are proprietary trademarks of iBiquity Digital Corporation. "HomeLink" is a registered trademark of Johnson Controls Technology Company. "iPod" is a registered trademark of Apple Inc. "SiriusXM" and all related marks and logos are trademarks of Sirius XM Radio Inc. and its subsidiaries. "TDI" is a registered trademark of Volkswagen AG. "Tiptronic" is a registered trademark of Dr. Ing h.c. F. Porsche AG. "Wi-Fi" is a registered trademark of the Wi-Fi Alliance. All other trademarks are the property of their respective owners. Some European models shown.

2015 | A8 Audi of America

Audiusa.com

Facebook.com/Audi

AoA1515487



© 2014 Audi of America, Inc. Printed in the U.S.A.