

1968 CHEVROLET TRUCKS

PICKUPS

CHASSIS-CABS AND STAKES



Chevrolet FLEETSIDE PICKUPS

**C 10 half-ton and
C 20 three-quarter-ton models**

Chevy pickups for '68 are handsome in appearance, streamlined for efficiency and solidly constructed to give long-lived stamina in all types of service. Time-proven independent front suspension and durable coil springs at all four wheels provide an extremely smooth ride with excellent carrying capacity for work and superior comfort for the driver and passenger.

WIDE POWER CHOICE. Chevrolet power teams are designed to fit a wide range of operating requirements. You can choose Six or V8 power. The standard 6-cylinder 250 offers maximum economy and the 292 Six has more power and greater stamina for the tougher jobs. New for V8 models is a standard 307-cubic-inch engine with a rating of 200 horsepower and an optional 325-horsepower 396

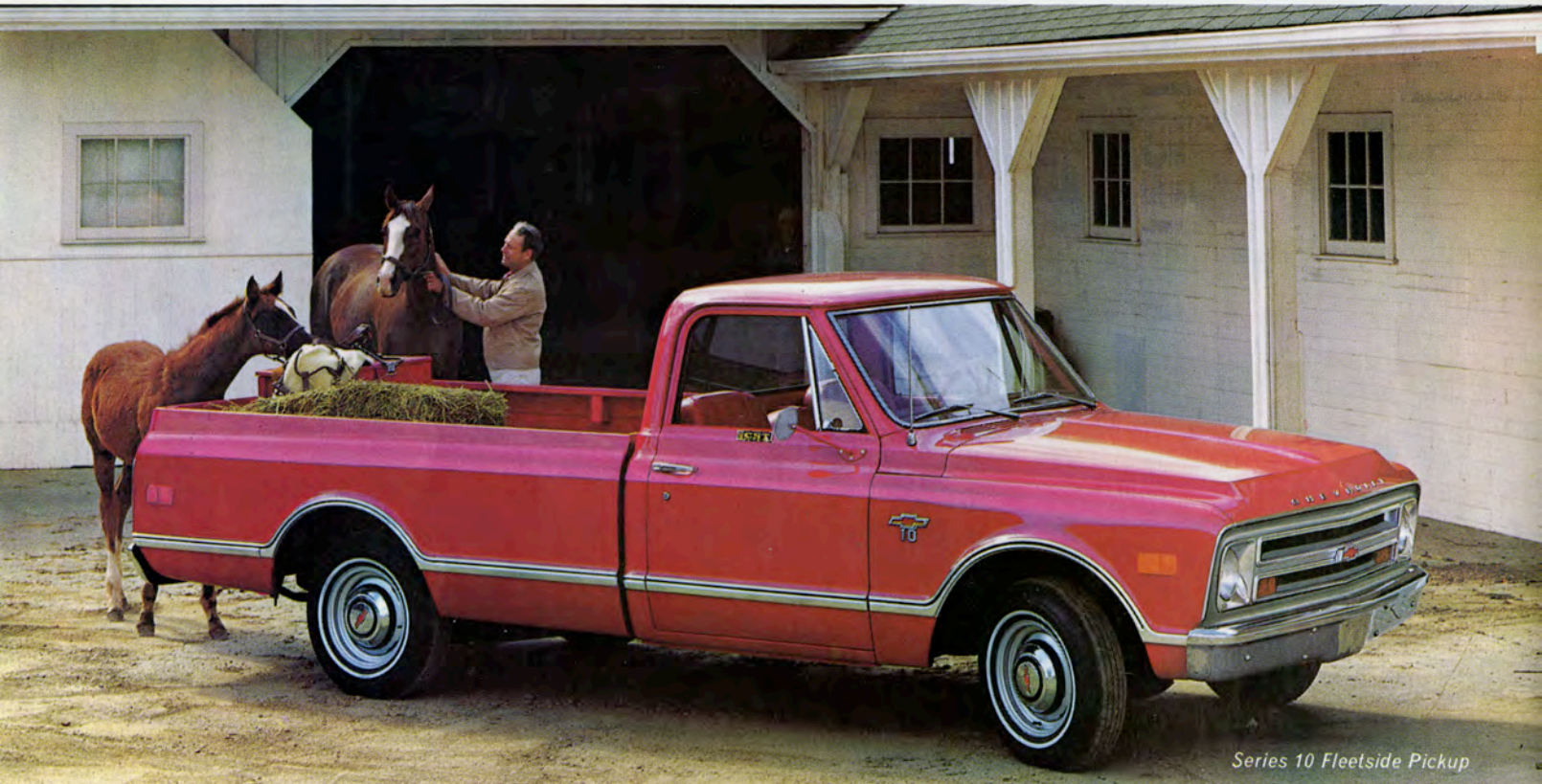

Series 10 Fleetside Pickup

STANDARD EQUIPMENT ON FLEETSIDE PICKUPS INCLUDES:

- 155-hp 250-cu.-in. Chevrolet High Torque six-cylinder engine on CS 10 and CS 20 models
- 200-hp 307-cu.-in. Chevrolet High Torque V8 engine on CE 10 and CE 20 models
- 3-speed transmission, steering column shift lever
- Self-adjusting brakes, all four wheels
- Dual master cylinder brake system with warning light
- Front and rear shock absorbers
- Backup lights
- Side marker reflectors
- Panoramic rear window
- Left-hand and right-hand outside rear view mirrors
- Hazard warning and freeway lane-change switch
- Passenger-guard push-button door locks
- Padded instrument panel and sun visor
- Two push-button-type color coordinated seat belts with retractors
- 2-speed windshield wipers and windshield washers
- Heater and defroster
- Mechanical jack and wheel wrench

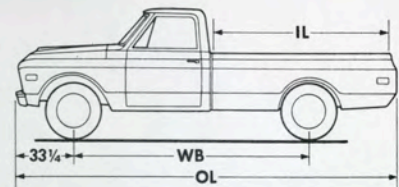

DIMENSIONS			
Series	WB Wheelbase (in.)	OL Overall Length (in.)	IL Inside Length (in.)
CS/CE 10734	115	188½	78⅞
CS/CE 10934 CS/CE 20934	127	207¾	98

V8 for high-performance tasks.

There's greater safety to go along with the increased power. Standard safety equipment additions include large outside rear view mirrors, side marker reflectors, backup lights, panoramic rear window and many cab interior items for increased occupant protection. Every part in a Chevy pickup truck is selected according to its ability to provide safety, reliability and durability.

RUST-DISCOURAGING BUILD. Pickup boxes are offered in 6½- or 8-foot lengths with standard steel or optional wood floors. Both types have been designed to reduce damage from rust and corrosion. One-piece outer body side panels are designed with wrap-around ends, reducing coach joints where corrosion often attacks. Also,

underbody protective coating is applied to the housings and inner portions of the side panels. Special attention is given to the front fender area, too. Contoured liners, formed from a single piece of steel, have a smooth under-surface to reject road splash and prevent mud build-up.

One-hand operation of the tailgate makes Chevy pickup boxes convenient to use. Rugged latching mechanism is contained within the tailgate for maximum protection. Tailgate closes with a minimum of effort and steel support straps hold tailgate flush with floor for easy loading. Double-wall tailgate and body side panels prevent cargo dents to the inner wall from marring the exterior appearance. (Refer to charts below for additional information on specifications and capacities.)

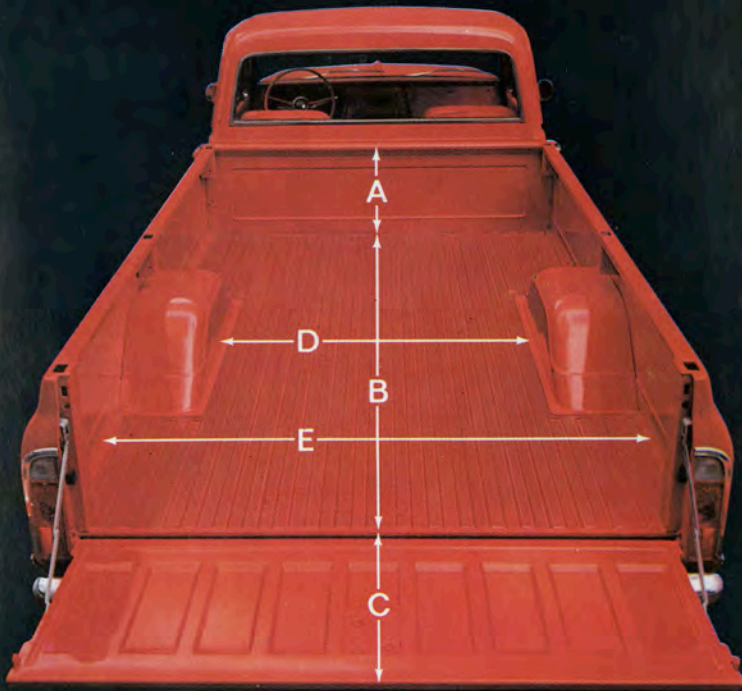

DIMENSIONS

Series	CS/CE 10734	CS/CE 10934 CS/CE 20934
A—Pickup box height from the floor to the top of the box at the front (in.)	19¼	19¼
B—Inside length of the pickup box at the floor (in.)	78⅞	98
C—Tailgate height (in.)	19¼	19¼
D—Width between wheelhousings (in.)	50	50
E—Maximum inside width at the floor (in.)	66	66
Fleetside pickup box capacity (cu. ft.)	58.4	74.3

Chevrolet STEPSIDE PICKUPS

**C 10 half-ton,
C 20 three-quarter-ton and
C 30 one-ton models**

Chevy's Stepside pickups for '68 with the streamlined and highly functional cabs offer users a sturdy box that facilitates loading and unloading from either side. Handy step running boards between cab and rear fenders make it easy to handle items in the hard-to-reach area near the front of the body. Wide flareboards on body sides have a rolled outer edge for greater rigidity, safer loading.

Stepside bodies are contained between the rear fenders to provide smooth interior walls a full 50 inches apart, allowing plenty of room for 4-foot-wide materials. Wood floors have recessed steel skid strips which make it easier to slide cargo in and out from the rear. Wedge-type anti-rattle latches keep tailgate securely closed to minimize leakage of bulk loads such as grain or sand.



Series 10 Stepside Pickup

STANDARD EQUIPMENT ON STEPSIDE PICKUPS INCLUDES:

- 155-hp 250-cu.-in. Chevrolet High Torque six-cylinder engine on CS 10, CS 20 and CS 30 models
- 200-hp 307-cu.-in. Chevrolet High Torque V8 engine on CE 10, CE 20 and CE 30 models
- 3-speed transmission, steering column shift lever on CS/CE 10 and CS/CE 20 models, 4-speed transmission, floor mounted shift on CS/CE 30 models
- Self-adjusting brakes, all four wheels
- Dual master cylinder brake system with warning light
- Front and rear shock absorbers on CS/CE 10 and CS/CE 20 models. Front only on CS/CE 30 models
- Backup lights and direction signals
- Panoramic rear window
- Side marker reflectors
- Left-hand and right-hand outside rearview mirrors
- Hazard warning and freeway lane-change switch
- Passenger-guard push-button door locks
- Padded instrument panel and sun visor
- Two push-button type color coordinated seat belts with retractors
- 2-speed windshield wipers and windshield washers
- Heater and defroster
- Mechanical jack and wheel wrench

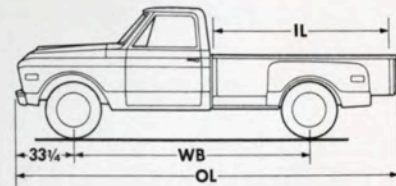

DIMENSIONS			
Series	WB Wheelbase (in.)	OL Overall Length (in.)	IL Inside Length (in.)
CS/CE 10704	115	188½	78⅞
CS/CE 10904 CS/CE 20904	127	207¾	98
CS/CE 31004	133	217¾	108¼

Plastic-covered support chains hold tailgate open to handle long items. Reinforced pockets for the addition of stock racks are provided to permit the hauling of livestock or bulky loads. Refer to specifications below for capacities and additional information.

4-WHEEL DRIVE PICKUPS. Chevrolet's low-silhouette 4 x 4 chassis are available with all 6½- and 8-foot pickup bodies. These models offer higher capacity axles to withstand the punishment of off-road use plus tapered-leaf front and rear springs for a smooth, stable ride under all conditions. The transfer case is attached to the transmission through an adapter providing a low vehicle height without sacrificing ground clearance. **Refer to Chevrolet's 4-wheel drive catalog for more information.**

"CST" CUSTOM SPORT TRUCK OPTION. Available on both Fleetside and Stepside pickups, the CST package customizes both interior and exterior. Exterior items include: a chrome front bumper, distinctive "CST" emblem on doors and extensive use of bright metal around grille openings, headlights, windshield and ventipanes. Inside, the "CST" package provides a full-width vinyl seat for driver and passenger with bucket seats and a center console-type third seat for passengers also available. Other interior features include: full carpeting; ornamentation for clutch, brake and accelerator pedals, control knobs and dispatch box door; full-depth armrests; right-hand padded sunshade; door trim panels; cigarette lighter; cowl insulation and full underbody coating.

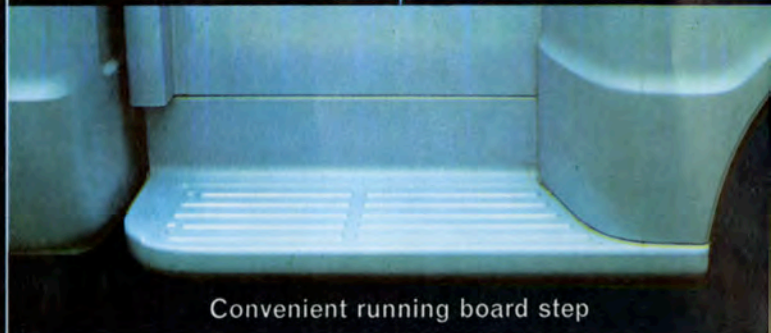
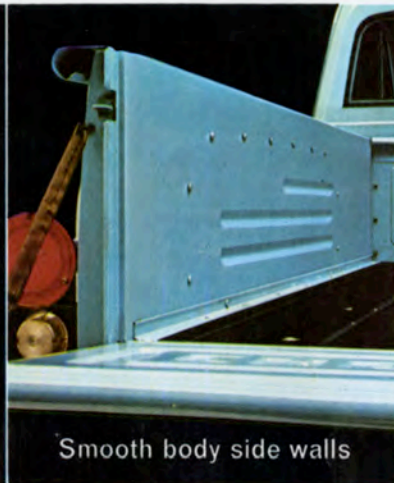
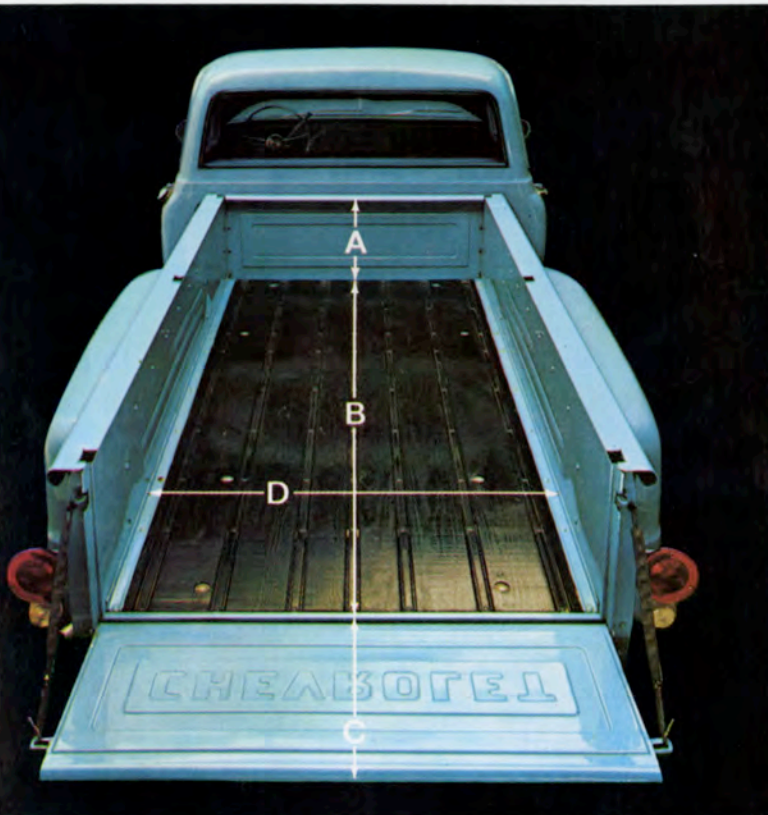

DIMENSIONS			
Series	CS/CE 10704	CS/CE 10904 CS/CE 20904	CS/CE 31004
A—Pickup box height from the floor to the top of the box at the front (in.)	17 ³ / ₈	17 ³ / ₈	17 ³ / ₈
B—Inside length of the pickup box at the floor (in.)	78 ³ / ₈	98	108 ¹ / ₄
C—Tailgate height (in.)	17 ³ / ₈	17 ³ / ₈	17 ³ / ₈
D—Maximum inside width at the floor (in.)	50	50	50
Stepside pickup box capacity (cu. ft.)	39.7	49.8	55

All-purpose
**CHASSIS-CABS
 & STAKES**
 for a wide variety
 of job applications

Chevrolet's conventional Chassis-Cab models are designed to accommodate separate bodies up to 13½ feet long. Four-wheel drive chassis for series 10 and 20 units will handle bodies from 6 to 8½ feet long. Both types feature a panoramic rear window for greater visibility.

Chevy's Stake models are built to haul big and bulky loads with good handling ease and excellent overall economy. They have single rear tires as standard but dual rears may be ordered for use in applications where extra floatation and the ability to carry full payloads are required. Your Chevrolet dealer will be glad to help you select the right model to fit your needs.

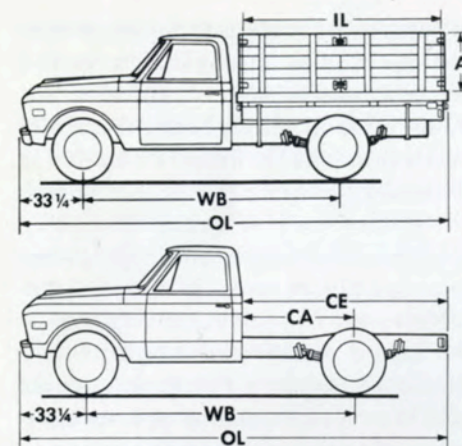

DIMENSIONS				
STAKES	WB (in.) Wheelbase	OL (in.) Overall Length	IL (in.) Inside Length	A (in.) Stake Rack Height
CS/CE 20909	127	212¼	98	28
CS/CE 31009	133	223¼	109	42
CHASSIS-CABS	WB (in.) Wheelbase	OL (in.) Overall Length	CA (in.) Cab-To-Axle	CE (in.) Cab-To-End of Frame
CS/CE 10703	115	181¾	42	75½
CS/CE 10903	127	201¾	54	95½
CS/CE 20903	127	201¾	54	95½
CS/CE 31003	133	213¾	60	107
CS/CE 31403	157	237¼	84	131



Series 30 Chassis-Cab with Utility Body



Series 30 Chassis-Cab with Towing Equipment



Series 30 Stake

CHASSIS-CAB models are offered with GVW ratings up to 14,000 pounds and on four wheelbases up to 157 inches. They have 34" wide frames and will accept platform and stake bodies from 6 to 13½ feet long. Standard cabs are wide enough to seat three comfortably on a single bench-type seat covered with tough easy-to-clean vinyl upholstery. The standard seat on all chassis cab models feature a molded polyurethane foam pad over a long-life foundation of steel springs. A full depth foam cushion is

available as an option or it may be obtained in the Custom Comfort and Convenience Equipment option. Also available are bucket seats which provide individual seats for the driver and passenger plus a console-type center seat for a third person.

The console seat has a padded cushion, which can be raised to utilize storage space underneath, and a padded backrest which can be folded down to provide an armrest for driver and passenger.

CHEVY STAKE models are available in two series: the C 20 Series with an eight-foot body and maximum GVW rating of 7,500 pounds and Series C 30 with a nine-foot body and a maximum GVW rating of 10,000 pounds. Both series benefit from the easy ride and handling provided by Chevrolet's independent front and weight-tailored rear suspensions. Sheet metal and interior appointments include features that have made Chevrolet light-duty trucks the most advanced and popular in the industry.

A single-section front rack extends the full width of the body. Side and rear racks are both in two sections to facilitate loading and unloading. Sturdy 8- and 9-foot platform bodies are available as regular production options for chassis-cab models. Platform floors are of wood and are securely anchored to deep-formed steel cross sills. Recessed steel skid strips cover floor joints for easier loading. Corners are rounded for maximum strength and channel rub rails protect the platform all around.

Bright roomy CABS provide comfort and convenience



Chevy cabs feature double-wall roof and cowl construction for added strength, increased driver comfort. Extensive use of sound-deadening materials is used throughout the cab. In addition to a dash panel insulator, insulation is also used between the double-wall roof panels and under the floor mat. A sound dampener material is applied in other strategic areas. Heavily reinforced pillars make possible a precision fit of doors. The instrument panel is welded in for added structural strength.

STANDARD CHEVY SAFETY FEATURES. Listed below are the major safety items as they apply to Chevy conventional cabs:

- Padded instrument panel with energy-absorption deceleration construction

- Non-glare finish on front compartment metal and non-reflective paint on instrument panel
- Padded sunshades; large radius ash tray edge and ball bearing ash tray track; push-button seat belt buckles; large, low-profile instrument panel control knobs; deflecting window control handles; deflecting door lock remote control handles; smooth, low-profile ventipane latches
- Panoramic rear window; right- and left-hand rear view mirrors, windshield washers, 2-speed electric wipers; windshield defrosters
- Telescoping lower steering shaft; deep-dish energy-absorbing steering wheel; thick-laminate windshield glass, safety door locks and hinges; flexible fuel filler necks

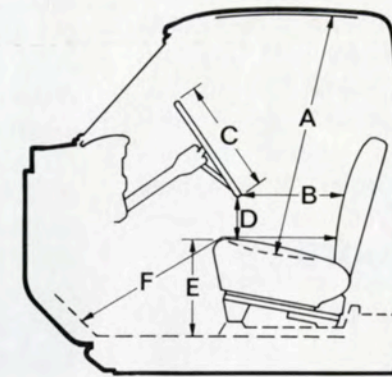

CAB DIMENSIONS (IN.)

• A—Seat to top of cab	39½
• B—Steering wheel to seat (Seat in maximum rear position*)	14⅞
• C—Steering wheel diameter	16½
• D—Bottom of steering wheel to top of seat	6
• E—Seat height (Seat in maximum rear position*)	14
• F—Leg room	53
• Shoulder room	63⅞
• Hip room	64¾
• Seat width	58¾

*Maximum seat travel is four (4) inches



STANDARD CAB is spacious, easy to work in, handsomely styled and built to last. Curved windshield is 1,232 square inches big to provide a clear, unobstructed view ahead. A panoramic rear window provides excellent rear visibility. Soft Ray tinted glass is optional at extra cost for windshield and other windows. The standard three-man seat is adjustable fore and aft. It features a special wire spring foundation covered with a pad of molded polyurethane foam for long-lived comfort. Seat trim is tough, easy-to-clean embossed vinyl in either red, green, blue or fawn. Other standard items include: heater and defroster, dome light above rear window, textured

black rubber floor mat and sunshade for driver. Full-width seat with full-depth foam cushion or bucket seats for driver and passenger are available.

CUSTOM APPEARANCE OPTION includes the following exterior trim applications: • Bright radiator grille moldings, ventipanes and headlight frames • Bright moldings around windshield, rear window, fenders and hood front edges • Custom emblem on doors

Distinctive interior items include: • Color-keyed vinyl-coated rubber floor mat • Inserts for instrument panel control knobs • Chevrolet nameplate on dispatch box door

CUSTOM COMFORT and CONVENIENCE OPTION offers luxury and value in a complete package consisting of the following: • Full-depth foam seat cushion with woven fabric and vinyl trim • Full-depth armrests • Padded sunshade on right side • Cigar lighter • Vinyl trim on doors • Cowl insulation and underbody coating

CUSTOM SPORT TRUCK OPTION includes much more than the interior features shown above. Chrome front bumper plus bright metal around the radiator grille, windshield and headlights add a flair to Chevy's distinctive front-end appearance. Bright ventipanes and taste-

fully designed CST emblem on doors let you know it's something special from the outside. Inside, full-width vinyl seats are standard; bucket seats with center console seat in textured vinyl are also available. Matching carpeting over floor and fuel tank extends well up on toe board. Additional Custom Sport Truck (CST) equipment includes: bright frames for clutch, brake and accelerator pedals, distinctive inserts for instrument panel control knobs, Chevrolet nameplate on dispatch box door, full-depth armrests, vinyl door trim panels, right-hand padded sunshade, cigarette lighter, cowl insulation and underbody coating.

Specially equipped

CUSTOM CAMPERS

offer the best way to
enjoy the great outdoors

Factory installed equipment to make Chevy pickups and chassis-cab units more suitable for camper service is another way that Chevrolet brings greater efficiency to the American motoring public. The availability of such items as heavy-duty springs, high capacity tires and front stabilizers makes it possible to move your camper with greater driving ease and keeps repairs at a minimum.

The characteristic that makes a Chevy pickup stand out in camper service is the remarkable way it combines truck toughness with a smooth ride. If you want to keep going when the roads stop, order a low-silhouette 4-wheel drive pickup. Chevrolet offers many variations to fit different camping applications. The right model for you will be determined largely by the size and type of slide-in camper



Series C 20 with cab-over camper body

body you desire, the amount of equipment and the number of people you expect to carry.

Chevy's chassis-cab models, available in either C 20 ¾- or C30 1-ton capacity, make solid foundations for frame-mounted camper bodies. Optional dual rear tires for these models and low center of gravity provide increased traction, contribute to overall handling ease.

If you like to travel in luxurious style and comfort, be sure to order the Chevrolet Custom Sport Truck Option. Deep foam-cushioned vinyl seats make long trips seem shorter. Bucket seats with center console which doubles as a third seat also available.

Series C 10 (½-ton) Custom Camper pickup—Special Custom Nameplate; Front Stabilizer Bar; 2000-lb. Rear

Springs or 500-lb. Auxiliary Rear Springs; HD Shock Absorbers; Choice of tires: 7.00-15, 6.50-16, 8-16.5.

Series C 20 (¾-ton) Custom Camper pickup or chassis-cab—Special Custom Camper Nameplate; Front Stabilizer Bar; 3000-lb. Rear Springs or 500-lb. Auxiliary Springs; HD Shock Absorbers; Choice of tires: 6.50-16 Dual Rears, 7.50-16, 7.00-17, 7.50-17, 8-16.5, 8.75-16.5, 9.50-16.5, 10-16.5.

Series C 30 (1-ton) Custom Camper chassis-cab—Special Custom Camper Nameplate; Front Stabilizer Bar; 3100-lb. or 4150-lb. Rear Springs; HD Shock Absorbers; Choice of tires: 7.00-16 or 7.50-16 Dual Rears, 7.00-18 Dual Rears, 8-16.5 Single or Dual Rears, 8.75-16.5, 9.50-16.5, 10-16.5.

RECOMMENDED MINIMUM EQUIPMENT FOR CAMPER BODIES

Series	CS/CE 10 (½ Ton)				CS/CE 20 (¾ Ton)			CS/CE 30 (1 Ton)		
	Shell				Cab Over Without Rear Overhang	Cab Over With Rear Overhang	Frame Mounted	Cab Over With Rear Overhang	Frame Mounted	
GVW Ratings (lbs.)	4400	4400	5000	5000	7000	7500	7500	7800	7800	10,000
Max. Body Length (ft.)	6	8	6	8	9	10½	11	12	12	14
Approx. Body Weight (lbs.)	200	300	200	300	1200	1600	1900	1800	2300	2800
Passenger & Equipment Weight (lbs.)	600	600	1200	1100	1400	1400	1500	1500	1500	1800
Total Body, Passenger & Equipment Weight (lbs.)	800	900	1400	1400	2600	3000	3400	3300	3800	4600
Recommended Chevrolet Models	CS/CE 10734 CS/CE 10704 Pickups	CS/CE 10934 Pickups	CS/CE 10734 CS/CE 10704 Pickups	CS/CE 10934 Pickups	CS/CE 20934 CS/CE 20904 Pickups		CS/CE 20903 Chassis-Cab	CS/CE 31004 Pickup	CS/CE 31003 Chassis-Cab	CE 31403 Chassis-Cab
Engines	*250 Six **307 V8		292 Six-Opt. **307 V8	292 Six-Opt. **307 V8	292 Six-Opt. 327 V8-Opt.	292 Six-Opt. 327 V8-Opt.	292 Six-Opt. 327 V8-Opt.	292 Six-Opt. 327 V8-Opt.	292 Six-Opt. 327 V8-Opt.	327 V8-Opt.
Transmissions	3-Spd.-Std. Powerglide-Opt.		3-Spd.-Std. Turbo Hydra-Matic-Opt.	3-Spd.-Std. Turbo Hydra-Matic-Opt.	4-Spd.-Opt. Turbo Hydra-Matic-Opt.	4-Spd.-Opt. Turbo Hydra-Matic-Opt.	4-Spd.-Opt. Turbo Hydra-Matic-Opt.	4-Spd.-Std. Turbo Hydra-Matic-Opt.	4-Spd.-Std. Turbo Hydra-Matic-Opt.	4-Spd.-Std. Turbo Hydra-Matic-Opt.
Rear Axle—Cap. (lbs.) —Ratio	3500-Std. 3.73-Std.		3500-Std. 3.73-Std.	5200-Std. 4.11-Opt.	5200-Std. 4.11-Opt.	5200-Std. 4.11-Opt.	7200-Std. 4.57-Opt.	7200-Std. 4.57-Opt.	7200-Std. 4.57-Opt.	7200-Std. 5.14-Std.
Front Suspension Stabilizer Bar Springs—Cap. (lbs.) Shock Absorbers	— 1250-Std. Std.		Recommended-Opt. 1250-Std. Std.	Recommended-Opt. 1350-Std. Std.	Recommended-Opt. 1350-Std. Heavy Duty-Opt.	Recommended-Opt. 1350-Std. Heavy Duty-Opt.	Recommended-Opt. 1500-Std. Heavy Duty-Opt.	Recommended-Opt. 1500-Std. Heavy Duty-Opt.	Recommended-Opt. 1750-Opt. Heavy Duty-Opt.	Recommended-Opt. 1750-Opt. Heavy Duty-Opt.
Rear Suspension Springs—Cap. (lbs.) Aux. Springs—Cap. (lbs.) Shock Absorbers	1250-Std. — Std.		2000-Opt. — 500-Opt. Heavy Duty-Opt.	2000-Std. 500-Opt. Std.	3000-Opt. 500-Opt. Heavy Duty-Opt.	3000-Opt. 500-Opt. Heavy Duty-Opt.	3100-Opt. — Heavy Duty-Opt.	3100-Opt. — Heavy Duty-Opt.	4150-Opt. — Heavy Duty-Opt.	4150-Opt. — Heavy Duty-Opt.
Tires Front	8.15-15 4pr.-Std.		8.00-16.5 6pr.-Opt.	7.00-15 6pr.-Opt.	7.50-16 8pr.-Opt. 8.75-16.5 8pr.-Opt.	#7.50-17 8pr.-Opt. #9.50-16.5 8pr.-Opt.	6.50-16 6pr.-Opt. 8.00-16.5 6pr.-Opt.	7.50-17 8pr.-Opt. 9.50-16.5 8pr.-Opt.	6.50-16 6pr.-Opt. 8.00-16.5 6pr.-Opt.	7.50-16 6pr.-Opt. 8.00-16.5 6pr.-Opt.
Tires Rear	8.15-15 4pr.-Std.		8.00-16.5 6pr.-Opt.	7.00-15 6pr.-Opt.	7.50-16 8pr.-Opt. 8.75-16.5 8pr.-Opt.	#7.50-17 8pr.-Opt. #9.50-16.5 8pr.-Opt.	6.50-16 6pr.-Opt. 8.00-16.5 6pr.-Opt. Dual Rears	7.50-17 8pr.-Opt. 9.50-16.5 8pr.-Opt. Dual Rears	6.50-16 6pr.-Opt. 8.00-16.5 6pr.-Opt. Dual Rears	7.50-16 6pr.-Opt. 8.00-16.5 6pr.-Opt. Dual Rears
Power Steering	—		—	—	Recommended-Opt.	Recommended-Opt.	Recommended-Opt.	Recommended-Opt.	Recommended-Opt.	Recommended-Opt.
Power Brakes	—		—	Recommended-Opt.	Recommended-Opt.	Recommended-Opt.	Recommended-Opt.	Recommended-Opt.	Recommended-Opt.	Recommended-Opt.
HD Cooling System	—		—	Recommended-Opt.	Recommended-Opt.	Recommended-Opt.	Recommended-Opt.	Recommended-Opt.	Recommended-Opt.	Recommended-Opt.
Electrical	—		—	42 Amp. Delcotron-Opt.	42 Amp. Delcotron-Opt.	42 Amp. Delcotron-Opt.	42 Amp. Delcotron-Opt.	42 Amp. Delcotron-Opt.	42 Amp. Delcotron-Opt.	42 Amp. Delcotron-Opt.

Equipment shown in blue optional at extra cost. *Standard on 6-cylinder models. **Standard on V8 models.

#7.50-16 8 pr. or 8.75-16.5 8 pr. tires may be used if the GVW does not exceed 7000 lbs.



Series C 10 with shell-type camper body



Series C 30 with frame-mounted camper body

Here's how a tough Chevrolet TRUCK CHASSIS looks and works

1 FRAME

Ladder-type frame is formed by heavy-gauge channel side rails securely riveted to alligator jaw crossmembers. Frame has a drop-center design to allow lower cab mounting for easier entry and exit. Maximum width is maintained at rear axle for stability.

2 FRONT SUSPENSION

Coil-spring independent front suspension features friction-free coil springs that automatically increase spring capacity as load increases to provide a smooth ride and easy handling under all conditions. Front wheels operate independently to prevent transfer of road shock from one to the other. Double-acting shock absorbers soak up vibrations.

3 TRANSMISSIONS

Manual transmissions include 3-speed and 4-speed units—3-speed transmissions have gear shift lever mounted on steering column, 4-speed boxes have shift lever mounted on floor. There are also automatics—the popular 2-speed Powerglide and the high-performance

3-speed Turbo Hydra-Matic. See specifications chart, page 15, for transmission availability in each truck series.

4 DRIVE SHAFTS

One- and two-piece drive shafts are of top-quality steel tubing, precision balanced to run true and smooth. Two-piece drive shafts employ a rubber-cushioned self-aligning ball center bearing. High capacity universal joints are balanced and permanently sealed to simplify servicing requirements.

5 REAR AXLE

All axles feature quiet hypoid gearing for greater tooth contact, extra strength. Axle shafts are semi-floating design for Series 10, full-floating for Series 20 and 30. Wide choice of axle ratios, see chart on page 15, permits most efficient use of engine power characteristics. Maximum-traction differentials are available to keep your truck moving over all types of roads and terrain.

6 REAR SUSPENSION

Coil-spring rear suspension for Series 10 and 20 trucks employs two-stage springs to give a soft ride when empty and firm support when fully loaded. Axle movement is controlled by two trailing arms pivoted at a frame cross-member, plus a transverse arm connecting the axle to the left frame side rail. Single-stage leaf springs are used to provide the increased capacity required by Series 30 trucks. Shock absorbers are standard on Series 10 and 20 trucks, optional on Series 30. High-capacity two-stage semi-elliptic springs are available for Series 30 trucks. Single-stage leaf type rear springs are optional for Series 10 and 20 trucks.

HERE'S THE SECRET OF CHEVY'S SMOOTH RIDE

Deep-coil independent front suspension is designed to prevent road shock from being passed back and forth between the front wheels or back through the frame and cab. It contributes to good stability when cornering. For added comfort, double-acting shock absorbers are strategically located for maximum control under rebound. Add it all up and you've got what it takes for a truly smooth truck ride. Smoother than some cars!

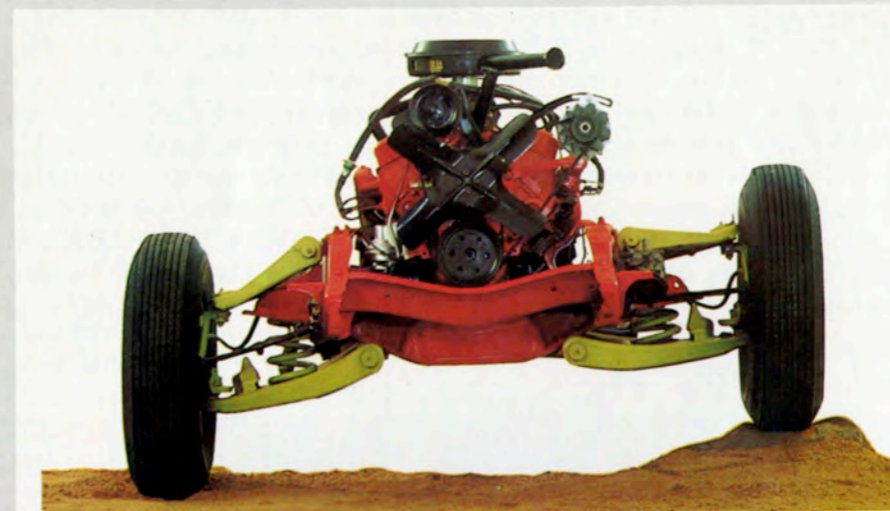

7 BRAKES

Front and rear brake hydraulic systems are separate but operate from a dual master cylinder connected directly to the brake pedal. If hydraulic pressure loss should occur in one system, the other remains operative. A warning light in the instrument panel signals the driver when the pedal is applied if either system malfunctions. Brakes are self-adjusting. Power brakes are also available.

8 AUXILIARY REAR SPRINGS

A single tapered-leaf auxiliary rear spring may be ordered for Series C10 and C20 trucks. Cantilever mounting permits spring to contact axle only after the base spring is compressed to design load condition. The net result is extra support and control with maximum payloads or on very rough roads.

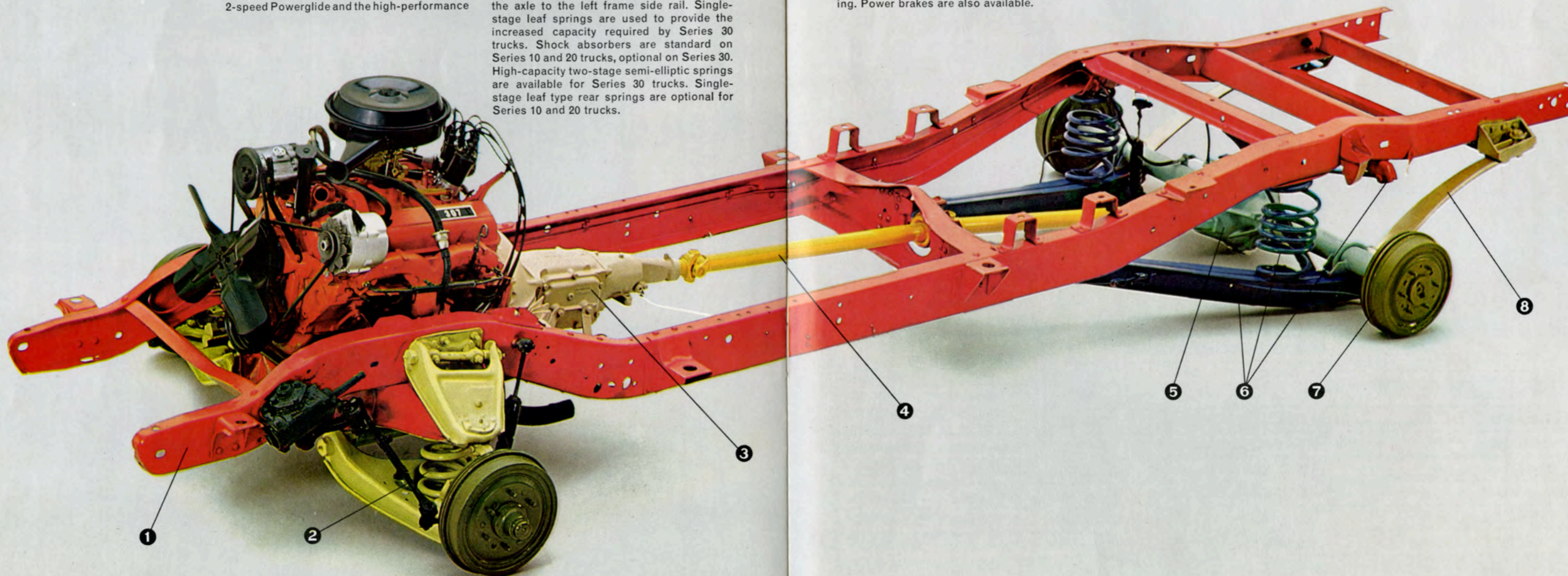

High-torque ENGINES for every job

Two Sixes and three V8s are available to help you meet your particular power needs. And each is designed to deliver maximum performance while keeping operating costs down low. Precision molded head and block castings give maximum rigidity with a minimum of dead weight. Free-breathing valve-in-head design with big valves and smooth porting allows full fuel charge to enter cylinders. Hydraulic valve lifters and individual rockers provide quiet valve action at all speeds. Low-inertia aluminum pistons have cast-in steel struts to control expansion. Precision-balanced crankshafts have main bearings flanking each throw to keep engine running smoothly. Closed positive crankcase ventilation removes and neutralizes harmful fumes. And all engines except the 396 V8 operate on regular gas.

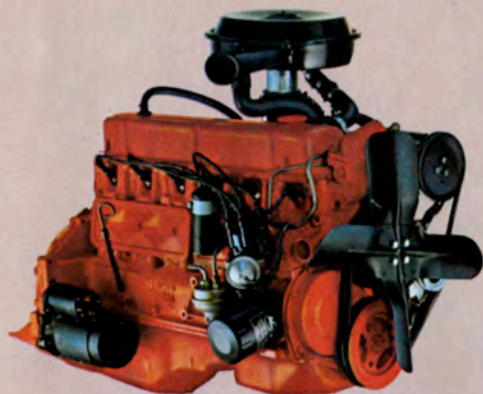

250 SIX

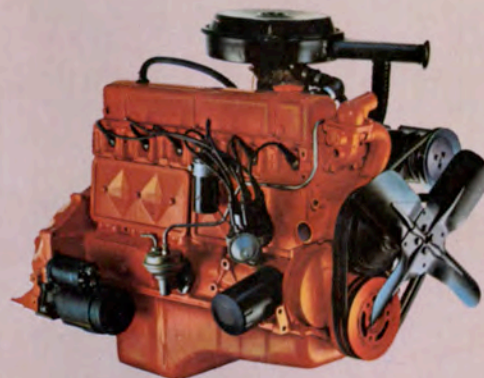

292 SIX

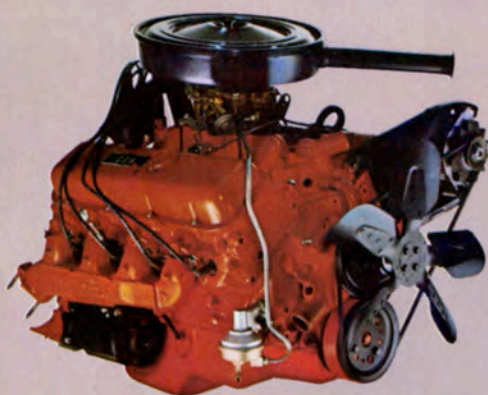

396 V8

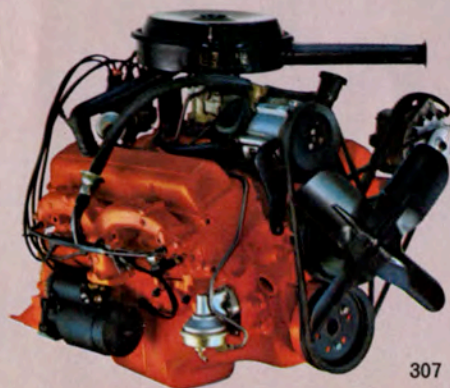

307 V8

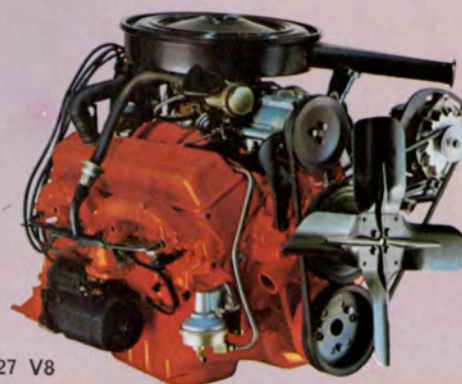

327 V8

ENGINE SPECIFICATIONS

	250 Six	292 Six	307 V8	327 V8	396 V8
Displacement (cu. in.)	250	292	307	327	396
Bore & Stroke (in.)	3 $\frac{7}{8}$ x 3 $\frac{1}{2}$	3 $\frac{7}{8}$ x 4 $\frac{1}{8}$	3 $\frac{7}{8}$ x 3 $\frac{1}{4}$	4 x 3 $\frac{1}{4}$	4 x 3 $\frac{3}{4}$
Compression Ratio	8.5 to 1	8.0 to 1	9.0 to 1	8.5 to 1	10.25 to 1
Gross Horsepower @ rpm	155 @ 4200	170 @ 4000	200 @ 4400	240 @ 4400	325 @ 4800
Net Horsepower @ rpm	125 @ 3800	153 @ 3600	150 @ 4000	187 @ 4000	220 @ 4200
Gross Torque (lbs.-ft.) @ rpm	235 @ 1600	275 @ 1600	300 @ 2400	330 @ 3000	410 @ 3200
Net Torque (lbs.-ft.) @ rpm	220 @ 1600	255 @ 2400	255 @ 2000	290 @ 2400	320 @ 2400

250 and 292 SIXES

Chevy's standard 250-cubic-inch Six has a rating of 155 horsepower. The 292 engine is available for those truck users with heavier service requirements. Both are exceptionally smooth thanks to Chevy's 12-counterweight crankshaft and torsional dampener. Camshafts are contoured for best performance and economy with aluminum drive gear for quietness. Full-length water jackets provide uniform cooling of cylinder walls to minimize distortion, improve engine efficiency. The 292 engine is fitted with Rotocoil exhaust valve rotators.

307 and 327 V8s

Big new 307-cubic-inch V8, standard in Chevrolet's V8 models, is rated at 200 horsepower. This engine and the optional 327 V8 operate on regular fuel and feature full-jacket cylinder cooling which circulates coolant completely around cylinder walls for uniform temperatures throughout the block. Long-life exhaust valves have special coating on heads to slow the formation of deposits. Rotocoil rotators on the 327 V8 reduce deposits still further. Five main bearings contribute to exceptional crankshaft rigidity.

396 V8

New high-performance 396 V8 is rated at 325 horsepower. Compression ratio of 10.25 to 1 permits high power output for maximum efficiency with premium fuel. High capacity water pump maintains proper water temperatures throughout the block.

SPECIFICATIONS

Series	CS/CE 10 (½ Ton)		CS/CE 20 (¾ Ton)		CS/CE 30 (1 Ton)			
GVW Ratings (lbs.)	4400 to 5000		5500 to 7500		6700 to 14,000			
Front Suspension	Type	Standard	Optional	Standard	Optional	Standard	Optional	
		Independent with Coil Springs						
	—cap. (lbs.)	2500		3000		3500	■ 4000	
	Springs—Type	Coil						
	—cap. (lbs.)	1250	1350	1350	1500	1500	1750	
	—cap. (lbs.)						■ 2000	
	Shock Absorbers	Standard	H.D. Opt.	Standard	H.D. Opt.	Standard	H.D. Opt.	
	Stabilizer Bar	Optional						
	Rear Suspension	Axle—Type	Semi-Floating		Full-Floating			
		—cap. (lbs.)	†3500		††5200		††7200	■ 11,000
—Ratios		3.73	3.07, 4.11	4.57	4.11	5.14	4.57, ■ 6.17	
—Ratios			3.54		3.54		4.11	
Springs—Type		Coil			Leaf			
—cap. (lbs.)		1250	2000	2000	3000	2400	3100	
—cap. (lbs.)							4150	
—cap. (lbs.)							■ 5900	
Springs—Type		Leaf						
—cap. (lbs.)			1750		2750			
Auxiliary Springs—Type		Tapered Leaf						
—cap. (lbs.)			500		500			
Shock Absorbers		Standard	H.D. Opt.	Standard	H.D. Opt.		H.D. Opt.	
Engines		*250 Six	292 Six	*250 Six	292 Six	*250 Six	292 Six	
		**307 V8	327 V8	**307 V8	327 V8	**307 V8	327 V8	
			396 V8		396 V8		396 V8	
Clutch	Dia. (in.)	*10	11	*10	11	11	12	
	Area (sq. in.)	*100	124	*100	124	124	150	
	Dia. (in.)	**11	12	**11	12			
	Area (sq. in.)	**124	150	**124	150			
Fuel Tank	Cap. (gal.)	21		21		21		
Transmissions		3-spd.	▲ 3-spd.	3-spd.	H.D. 3-spd.	4-spd.	4-spd. CR	
			H.D. 3-spd.		4-spd.			
			3-spd. OD		4-spd. CR		Turbo Hyd.	
			4-spd.		Powerglide			
			4-spd. CR		Turbo Hyd.			
			Powerglide					
			Turbo Hyd.					
Brakes		Hydraulic	Power	Hydraulic	Power	Hydraulic	Power	
Frame	Section Modulus	2.98		3.71		5.05 (310)	7.29 (314)	
Steering		Manual	Power	Manual	Power	Manual	Power	
Wheels & Tires	Disc Wheels—Type	6-stud		8-stud		8-stud		
	—rim width (in.)	5.50	5.0, 5.25	5.25	5.0, 6.0	5.25	5.0, 5.5, 6.0	
	—rim width (in.)		6.0		6.75, 8.25		6.75, 8.25	
	Tubeless Tires—sizes	8.15-15	6.50-16	7-17.5	8.17-5	8-17.5	7-17.5	
	—sizes		7-17.5		8-19.5		8-19.5	
	—sizes		7.75-15		8.0-16.5		8.0-16.5	
	—sizes		8-16.5		8.75-16.5		8.75-16.5	
	—sizes				9.50-16.5		9.50-16.5	
	—sizes				10-16.5		10-16.5	
	Tube-Type Tires—sizes		7.75-15		6.50-16		6.50-16	
	—sizes		8.15-15		7.00-16		7.00-16	
	—sizes		7.00-15		7.50-16		7.50-16	
	—sizes		6.50-16		7.00-17		7.00-17	
	—sizes				7.50-17		7.50-17	
	—sizes						7.00-18	

Equipment shown in blue optional at extra cost. †Also available with Positraction differential. ††Also available with NoSPIN differential. *Standard on 6-cylinder models. **Standard on V8 models. ■157" WB models only. ▲Fully-synchronized 3-speed for CS10 models only.

Whatever your pickup needs—Chevrolet has the answer!



Double-wall side panels on Fleetside

One-hand tailgate control handle on Fleetside

Contoured fender liners

Chain tailgate support on Stepside

Smooth inner-body side walls on Stepside

New 307-cubic-inch V8

Convenient running board step on Stepside

Work-proved independent front wheel suspension

Chevrolet New Vehicle Warranty

1968 Model Series 10, 20, 30 Trucks and Chassis

There are no warranties, expressed or implied, made by either the selling dealer or Chevrolet Motor Division, General Motors Corporation, on new Chevrolet passenger cars, chassis, and 10, 20, 30 Series trucks except the warranty against defects in material or workmanship set out below:

Chevrolet Motor Division, General Motors Corporation (hereinafter referred to as Chevrolet), warrants each new Chevrolet passenger car, chassis, and 10, 20, 30 Series truck (each being hereinafter referred to as a Vehicle) including all equipment and accessories thereon (except tires and tubes), manufactured or supplied by Chevrolet and delivered to the original retail purchaser by an authorized Chevrolet Dealer, to be free from defects in material or workmanship under normal use and service for 24 months or until it has been driven for 24,000 miles after such delivery, whichever occurs first; and further warrants the power train components specifically described as the cylinder block and head and all internal engine parts, intake manifold, transmission case and all internal parts, torque converter, propeller shaft and universal joints, differential, axle shafts and rear wheel bearings on any such Vehicle, manufactured or supplied by it to be free from defects in material and workmanship under normal use and service for 5 years or until it has been driven for 50,000 miles after such delivery, whichever occurs first.

As an express condition of this warranty, once every 6 months the owner is required to furnish an authorized Chevrolet Dealer evidence that the engine oil, oil filter, carburetor air filter, and positive crankcase ventilator valve (and automatic transmission oil and transmission band if so equipped) have been serviced in accordance with Chevrolet's required maintenance schedule as stated in the applicable Chevrolet Owner Protection Plan booklet, and have the Dealer certify

in such booklet (i) that he has received such evidence, and (ii) the then current indicated mileage on the odometer.

Chevrolet's obligation under this warranty is limited to repairing or replacing any part or parts which are returned to an authorized Chevrolet Dealer at such Dealer's place of business and which examination shall disclose to Chevrolet's reasonable satisfaction to have been thus defective. The repair or replacement of defective parts under this warranty will be made by such Dealer without charge for parts and labor. The provisions of this warranty shall not apply to any Vehicle which has been subject to misuse, negligence, alteration or accident, or which shall have been repaired outside of an authorized Chevrolet Dealer's place of business in any way so as, in the reasonable judgment of Chevrolet, to affect adversely its performance and reliability, nor to normal maintenance services (such as engine tune up, fuel system cleaning, carbon or sludge removal, brake and clutch adjustments and wheel alignment and balancing) and the replacement of service items (such as spark plugs, ignition points, positive crankcase ventilator valves, filters and brake and clutch lining) made in connection with such services, nor to normal deterioration of soft trim and appearance items due to wear and exposure.

This warranty is expressly in lieu of any other warranties, expressed or implied, including any implied warranty of merchantability or fitness for a particular purpose, and of any other obligations or liability on the part of Chevrolet, and Chevrolet neither assumes nor authorizes any other person to assume for it any other liability in connection with such Vehicle.

All illustrations and specifications contained in this literature are based on the latest product information available at the time of publication. The right is reserved to make changes at any time in prices, colors, materials, equipment, specifications and models, and also to discontinue models. CHEVROLET MOTOR DIVISION OF GENERAL MOTORS CORPORATION, DETROIT, MICHIGAN. LITHO IN U.S.A.