

The new Panamera



European model shown. Some options may not be available.



Porsche Cars North America, Inc.
One Porsche Drive
Atlanta, Georgia 30354-1654



Dr. Ing. h.c. F. Porsche AG is the owner of numerous trademarks, both registered and unregistered, including without limitation the Porsche Crest, Porsche, Boxster, Carrera, Cayenne, Cayman, Macan, Panamera, Spyder, Tiptronic, VarioCam, PCM, PDK, 911, 718, RS, 4S, 918 Spyder, FOUR UNCOMPROMISED, and the model numbers and distinctive shapes of the Porsche automobiles such as, the federally registered 911 and Boxster automobiles. The third party trademarks contained herein are the properties of their respective owners. All text, images, and other content in this publication are protected by copyright. No part of this publication may be reproduced in any form or by any means without prior written permission of Porsche Cars North America, Inc. Porsche Cars North America, Inc. believes the specifications to be correct at the time of printing. However, specifications, standard equipment, and options are subject to change without notice. Some options may be unavailable when a car is built. Some vehicles may be shown with non-U.S. equipment. Please ask your authorized Porsche dealer for advice concerning the current availability of options and verify the optional equipment that you ordered. Porsche recommends seat belt usage and observance of traffic laws at all times.

© 2017 Porsche Cars North America, Inc.

MKT 001 006 17

porscheusa.com

1-800-PORSCHE



The new Panamera
Courage changes everything



## Contents

<b>Sports car fascination</b>	2
<b>Panamera concept</b>	6
<b>Design</b>	10
<b>Drive and chassis</b>	26
<b>Comfort and infotainment</b>	54
<b>Porsche Connect</b>	72
<b>Lights and vision</b>	76
<b>Assistance systems</b>	78
<b>Personalization</b>	86
<b>Porsche Exclusive</b>	90
<b>Panorama</b>	130
<b>Porsche Experience Centers</b>	132
<b>Technical data</b>	134
<b>Index</b>	142
<b>Justify It</b>	144

European model shown. Some options may not be available.



**“In the beginning I looked around and could not find quite the car I dreamed of. So I decided to build it myself.”**

–Dr. Ferry Porsche

### **The dream of the sports car.**

You have to fight for a big dream. And bold vision. The next victory? Rarely will it simply fall into your lap. Often though, there are innate factors you must fight against: resistance, conventions, and rigid patterns of thinking.

Whatever your dream is, nothing is achieved without passion, grit, and determination. Dr. Ferry Porsche gave his all to create the sports car of his dreams. His dream came true. Not because he hesitated, dwelled, or got lucky. It was because he went the extra mile.

This attitude is in every Porsche we've created since 1948. It's there in the smallest part and in every race we've won. Because we fight. We fight for one more crucial percentage point more. For the one second that means the difference between triumph and defeat. For the “Dr. Ing.” in our company name and for the chance to stir passion for the sports car, time and time again.

To us, it's never been about extra horsepower alone. It's about engines that are more efficient, not bigger.

It's about a design that follows principles, not trends. It's about sports cars that can be driven day in, day out.

It's only when all these things come together that we can talk of Intelligent Performance—the core of the Porsche brand and its future. That is what we fight for. Just as we did on day one. We are fighting for a dream that will forever be in our heart.

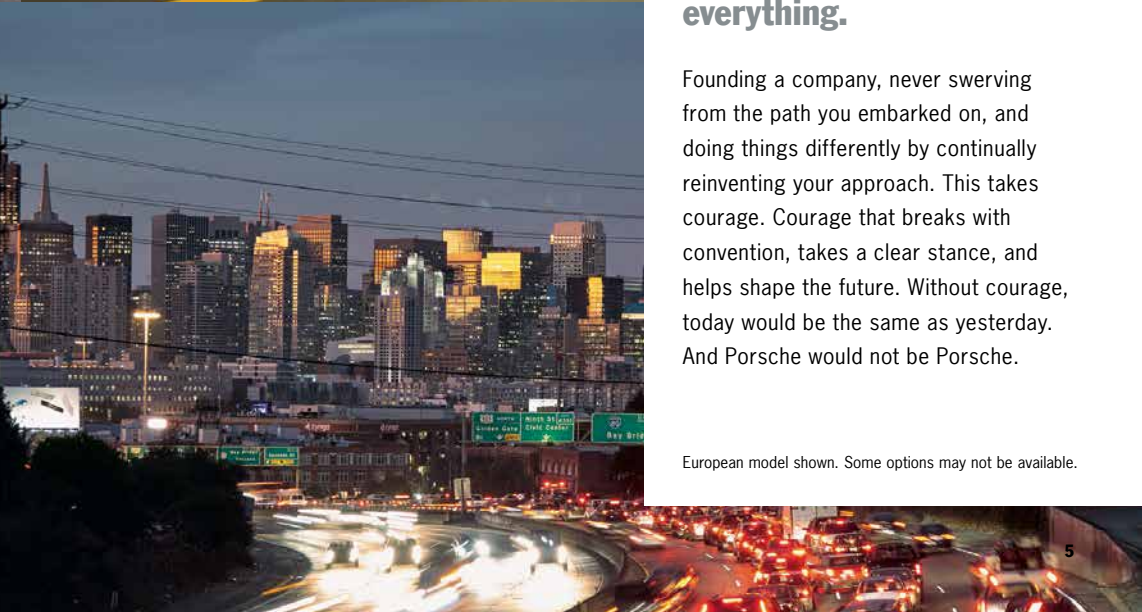

## Courage changes everything.

Founding a company, never swerving from the path you embarked on, and doing things differently by continually reinventing your approach. This takes courage. Courage that breaks with convention, takes a clear stance, and helps shape the future. Without courage, today would be the same as yesterday. And Porsche would not be Porsche.

European model shown. Some options may not be available.



**Courage takes many forms.  
We've opted for that of a sports car.**

**Panamera concept.**

A few years ago, everything to do with the sedan suddenly changed. Large, cumbersome, and thickly padded instantly seemed like outdated qualities. And on the road, something fast and dynamic began happening: a sports car came along. A sports car with four seats, an unmistakable silhouette, and performance figures associated only with a Porsche.

Now the change continues forward. On the road, something is happening again. For sporty drivers—and their sporty companions—our engineers and designers have created the next Panamera. With the courage of a new generation.

The new Panamera.  
Courage changes everything.

The Panamera. It changed everything. For drivers of sedans first and foremost. Sporting spirit—in business and in personal life—found its automotive counterpart. The courage to perform found a matching performer.





Our engineers have demonstrated courage with the Panamera concept. By continually re-evaluating and reinventing. By reconciling apparent contradictions: performance and efficiency, dynamics and comfort, career and family. And by forever remaining true to our roots, with shared traits like the ignition on the left and the tachometer in the middle. In short, using Porsche DNA.

The new generation of the Panamera is ideally equipped for the road. And for your vision of a modern-day sports car. The new Panamera Executive models, with even more space and comfort in the rear compartment, provide greater freedom to relax or work.

Chassis control systems, such as Porsche 4D Chassis Control, available three-chamber air suspension, rear axle steering, and Porsche Dynamic Chassis Control Sport (PDCC Sport), intensify the driving experience. Assistance systems,

such as Porsche InnoDrive, make it more efficient. Available thanks to Porsche Connect, all new models are connected to the digital world. Just what you need when you're on a journey to the future.

The way ahead is illuminated by LED headlights—fitted to all Panamera models. LED headlights with Matrix Design including Porsche Dynamic Light System Plus (PDLS Plus) are available as an option.

The new generation of the Panamera includes the following models:

**Panamera**  
3.0-liter turbocharged V6, 330 hp;  
rear-wheel drive.

**Panamera 4 and Panamera 4 Executive**  
3.0-liter turbocharged V6, 330 hp;  
all-wheel drive.

**Panamera 4 E-Hybrid and Panamera 4 E-Hybrid Executive**  
2.9-liter twin-turbo V6, 330 hp;  
electric motor, 136 hp;  
total system power, 462 hp;  
all-wheel drive.

**Panamera 4S and Panamera 4S Executive**  
2.9-liter twin-turbo V6, 440 hp;  
all-wheel drive.

**Panamera Turbo and Panamera Turbo Executive**  
4.0-liter twin-turbo V8, 550 hp;  
all-wheel drive.

**Panamera Turbo S E-Hybrid and Panamera Turbo S E-Hybrid Executive**  
4.0-liter twin-turbo V8, 550 hp;  
electric motor, 136 hp;  
total system power, 680 hp;  
all-wheel drive.

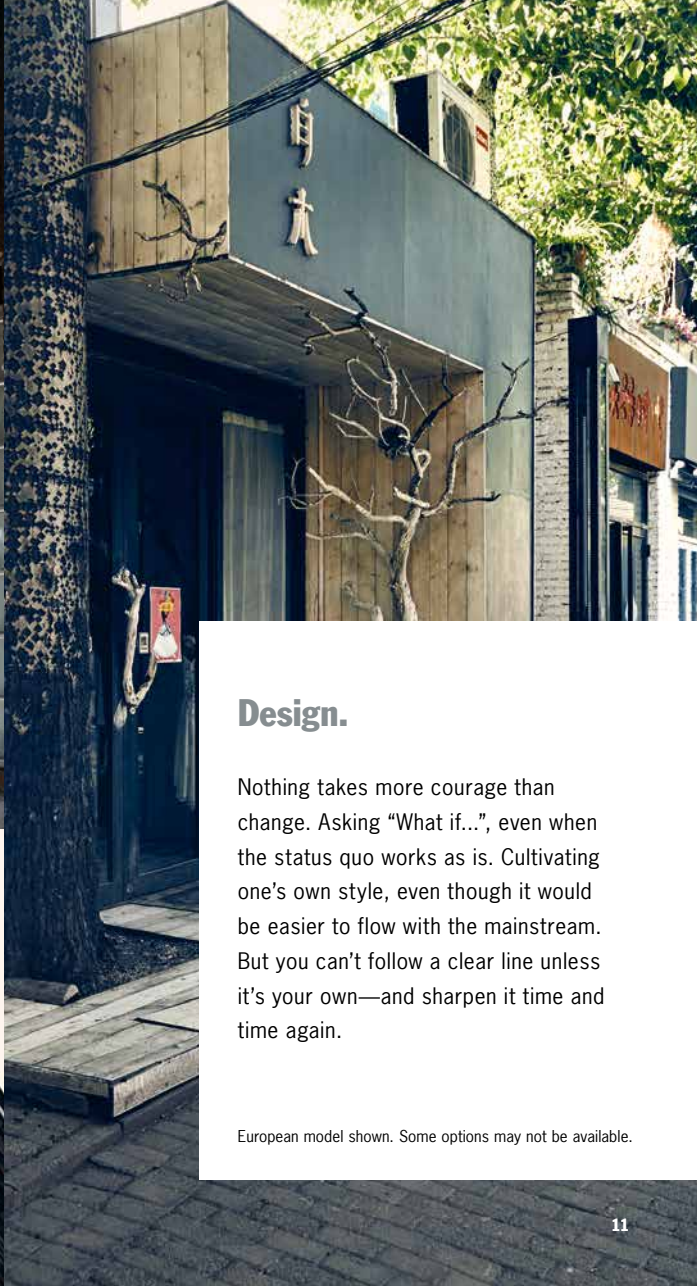

## Design.

Nothing takes more courage than change. Asking “What if...”, even when the status quo works as is. Cultivating one’s own style, even though it would be easier to flow with the mainstream. But you can’t follow a clear line unless it’s your own—and sharpen it time and time again.

European model shown. Some options may not be available.

## Porsche DNA consistently realized.

Does a sporty sedan really have to look like a sedan? Or can it look rather more athletic? With a taut roof line, for example, that displays a sleek and harmonious contour more likely to be associated with a two-seater?

The silhouette and proportions of the new Panamera models are more Porsche than ever. Clearly perceived rounded transitions, powerful muscles, and a sharpened sports car silhouette emphasize the precision of the new design.

The wheelbase is a little more than an inch longer than that of its predecessor—the shorter overhang at the front and the longer overhang at the rear lend visual dynamism. The more prominent sculpting of the side profile creates the customary Porsche waistline and sense of lightness.

The Porsche Dynamic Light System (PDLS) on the Panamera Turbo includes LED headlights with 4-point daytime running lights as a stunning identifying feature.







The Panamera, the Panamera 4 models, and the Panamera 4 E-Hybrid models are equipped with 19-inch Panamera wheels with high-performance summer tires. Their respective exhaust systems feature two tailpipes in brushed stainless steel.

Telltale feature of the E-Hybrid models: Acid Green brake calipers and model designated with Acid Green highlights.

The tremendous tractive power of the two all-wheel drive 4S models is transmitted to the road by 19-inch Panamera S wheels with high-performance summer tires. Wheels of up to 21 inches in size are available as an option. Behind them: brake calipers in Titanium Grey. Twin-tube tailpipes are fitted left and right.

The light strip on the rear and the slimline three-dimensional LED taillights with 4-point brake lights are characteristic features of all Panamera models. The extending rear spoiler integrated into the body reduces lift at the rear axle at high speeds.

European model shown. Some options may not be available.



The Panamera Turbo models aim to explore the extremes of feasibility. An ambition that's obvious at first glance: from the dominant front end and distinctive front lights. The side air outlets in the front fenders are finished in the exterior color of the vehicle, and in silver color on the Panamera Turbo Executive. The twin tailpipes on both models are specific to the Turbo, and the brake calipers behind the 20-inch Panamera Turbo wheels are finished in red. The rear spoiler splits at full deployment for a significant gain in width—in line with the higher power output of the Turbo models.





The new Panamera Executive models combine sporty driving with a comfortable rear compartment—thanks to nearly 6 extra inches added to the length of the body.

Silver-colored slats in the front air intakes and above the side skirts, and the high-gloss silver-colored air outlets behind the front fenders are just a few of the Executive model visual highlights.

The standard specification includes adaptive air suspension, a panoramic roof, and a rear roll-up sunblind. Particularly pleasant: power seats in the rear compartment with heated seats and comfort headrests.

Panamera 4S Executive and Turbo Executive models are also equipped with rear axle steering and soft-close doors. In addition, a 4-zone climate control is standard in the Panamera Turbo Executive.





The design of the Panamera Turbo S E-Hybrid is that of a precise, muscular sports car. Underlining the athletic appearance are 21-inch 911 Turbo Design wheels, while the extending rear spoiler integrated into the body splits on deployment and reduces lift at the rear axle at high speeds.

The upgraded standard specification of the Panamera Turbo S E-Hybrid Executive includes, among other features, rear axle steering, soft-close doors, a panoramic roof, 4-zone climate control, power seats in the rear compartment, and ambient lighting with rear compartment interior lighting.





#### **Panoramic roof**

The tinted glass panels of the new panoramic roof on the Panamera models create particularly bright and pleasant lighting.

The two-piece panoramic roof can be electrically tilted and opened at the front, while the rear section is a fixed glass roof. Both glass surfaces feature individual retractable shades.

For added privacy and protection against direct sunlight, the Panamera Executive models feature power sunblinds in the rear compartment, and the Panamera 4S Executive variants and up include the power sunblinds for the rear side windows as well. The rear windshield sunblind can be configured to roll down automatically when reverse gear is selected.

The interior has been completely restyled—and nevertheless remains typically Porsche. The center console ascends towards the front. The dashboard is flat and conspicuously wide. The analog tachometer is positioned in the middle of the instrument cluster.

Also new is the control concept: Porsche Advanced Cockpit. The center console with Direct Touch Control has a glass-like surface, featuring touch-sensitive buttons for direct access to the most important functions. The compact gear selector of the 8-speed Porsche Doppelkupplung (PDK) is between the driver and front passenger buttons on the center console. A high-resolution 12-inch touchscreen display is integrated into the dashboard. Two high-resolution screens, one to the right and one to left of the tachometer, display virtual instruments, maps, and a range of other information.

European model shown. Some options may not be available.

In conjunction with optional 4-zone climate control, the passengers in the rear also have a touchscreen display of their own.

Thanks to the nearly 6 inch longer wheelbase, Panamera Executive models offer even more space and comfort in the rear compartment.

Optional personalization items, such as the large rear center console or Porsche Rear Seat Entertainment, help you to work or relax.

Above all, though, there is plenty of space and comfort. Not so typical of a sports car. Absolutely typical of the new Panamera.



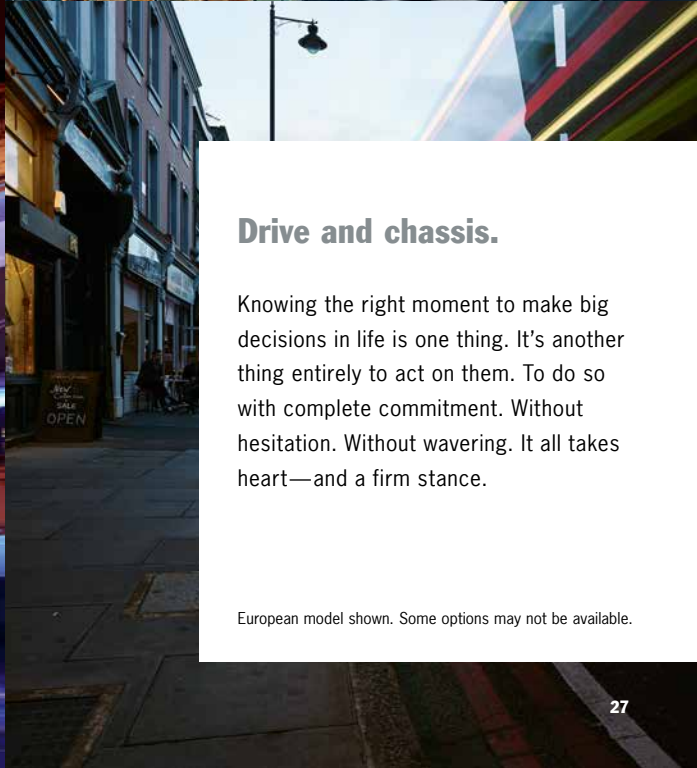

### Drive and chassis.

Knowing the right moment to make big decisions in life is one thing. It's another thing entirely to act on them. To do so with complete commitment. Without hesitation. Without wavering. It all takes heart—and a firm stance.

European model shown. Some options may not be available.



**Whether it's in the office, at home, or on the road, change needs force.**

### Engines.

"That's the way we've always done it." Not really a sentence to inspire change. Except at Porsche. That's because we've always made each new generation of engines higher-performing, more dynamic, and more efficient than the last. The new engine generation of the Panamera models now takes the next significant step forward.

The all-new turbocharged V6 engines in the Panamera and Panamera 4, the twin-turbo V6 engines in the Panamera 4 E-Hybrid and Panamera 4S, and the twin-turbo V8 engine in the Panamera Turbo and the Panamera Turbo S E-Hybrid are equipped with VarioCam Plus: a system that adjusts the camshaft timing and valve lift. The turbochargers are positioned between the cylinder banks.

This reduces the distance that the exhaust stream has to travel to reach the respective turbo—delivering a more rapid response.

Both the turbocharged V6 engines in Panamera and Panamera 4 and the twin-turbo V8 engine in the Panamera Turbo and the Panamera Turbo S E-Hybrid are further optimized with twin-scroll turbines. The exhaust gasses arrive at the turbine wheel through physically separate channels—for optimized gas cycles. The result: high torque even in the low rpm range.

The adaptive cylinder control of the twin-turbo V8 engine activates cylinders on demand. As an example, you're driving in town and have little need for

power, your car will now operate on only four cylinders instead of eight. Once you demand greater power output again, all cylinders will immediately activate.

The Direct Fuel Injection (DFI) in the new generation of engines is realized by a central injector inside the combustion chamber. This optimizes both the mixture injection and combustion—for greater efficiency and increased power delivery.

All engines are purposefully equipped with electrical system recuperation, thermal management, Auto Start Stop with coasting function, and active air intake flaps.

And driving pleasure? Greater than ever.

European model shown. Some options may not be available.



**The 4.0-liter twin-turbo V8 engine in the Panamera Turbo and Panamera Turbo S E-Hybrid**

With a power output of 550 hp, the new 4.0-liter twin-turbo V8 engine, featuring twin-scroll turbochargers, VarioCam Plus, and adaptive cylinder control, produces 30 hp more than the engine in the predecessor model. The maximum torque of 567 lb.-ft. is achieved between 1960 and 4500 rpm. The Panamera Turbo with short wheelbase accelerates from 0 to 60 mph in just 3.6 seconds and has a top track speed of 190 mph.

In the Panamera Turbo S E-Hybrid, the V8 combustion engine works in unison with the electric motor, producing 680 total hp, and accelerating from 0 to 60 in a mere 3.2 seconds.

**The 2.9-liter twin-turbo V6 engine in the Panamera 4S and Panamera 4 E-Hybrid**

The newly developed 2.9-liter twin-turbo V6 engine in the Panamera 4S produces

440 hp, which makes it 20 hp more powerful than its counterpart in the predecessor model. Maximum torque is 405 lb.-ft. between 1750 and 5500 rpm.

In the Panamera 4 E-Hybrid, the combustion engine is fine-tuned to work in interaction with the electric motor, and together they produce 462 hp and 516 lb.-ft. of torque. Find out more on the following pages.

**The 3.0-liter turbocharged V6 engine in the Panamera and Panamera 4**

The efficient 3.0-liter turbocharged V6 engine in the Panamera and Panamera 4 is equipped with a twin-scroll turbocharger positioned between the cylinder banks, and produces 330 hp. The maximum torque of 331 lb.-ft. is achieved between 1,340 and 4,900 rpm.

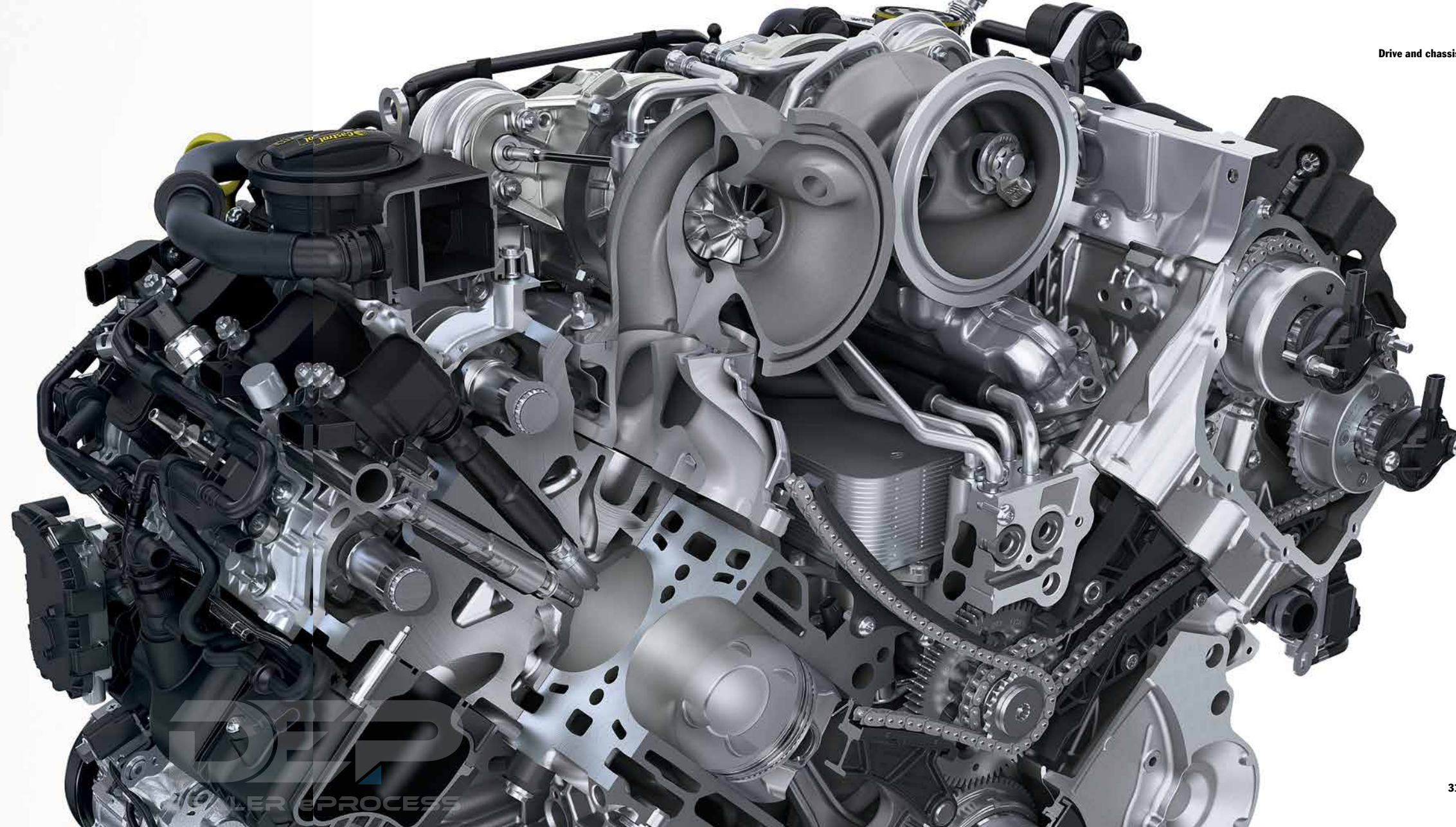

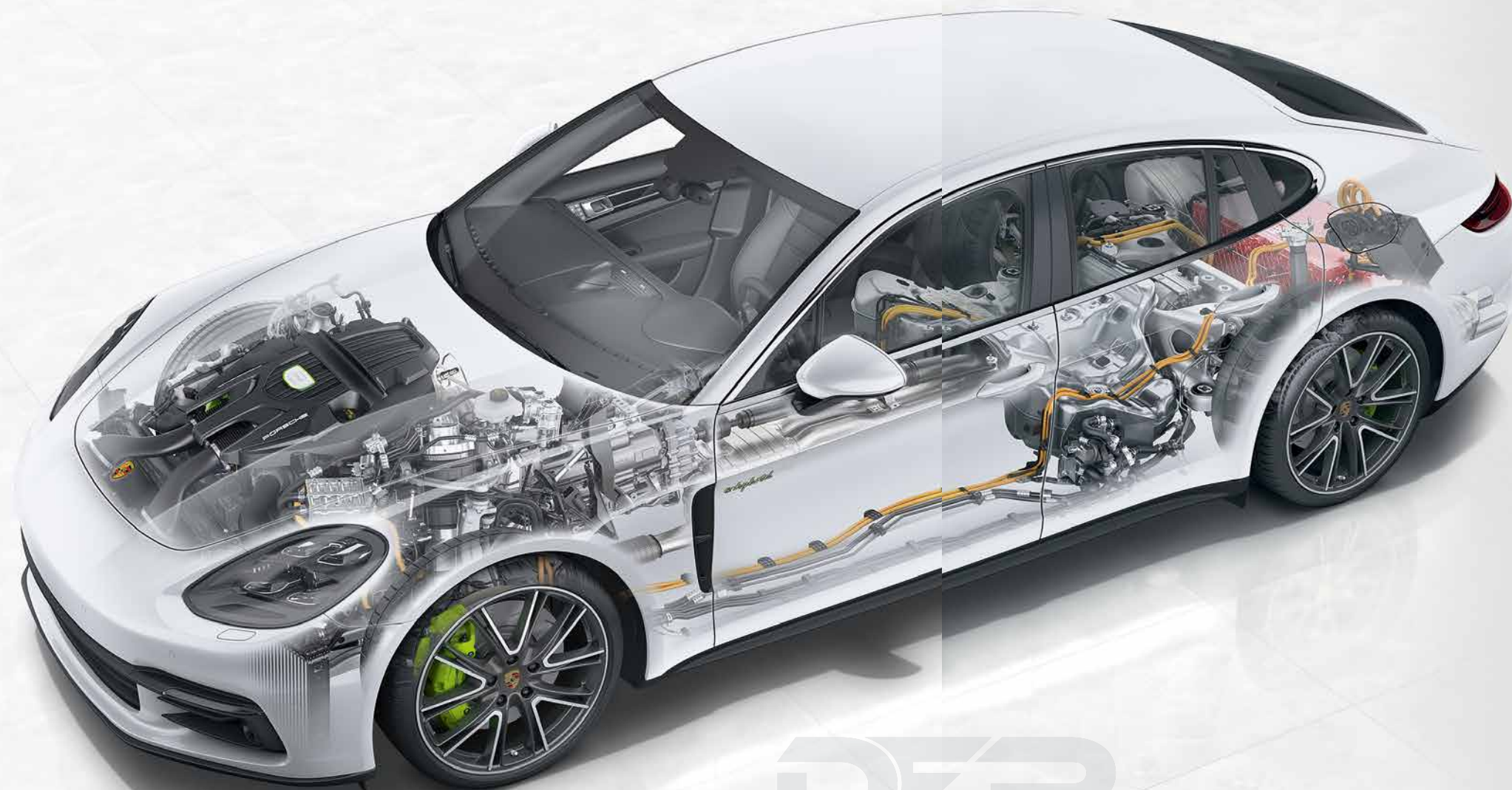

## Courage changes the sports car of the future. And the future of the sports car.

### The Panamera 4 E-Hybrid.

It takes courage to tread new paths. We are discovering them with the new Panamera 4 E-Hybrid—and it's going to change your perception of hybrid technology. Just as it will your everyday life. With a maximum total system power of 462 hp. Sounds good? Read on.

The crucial factor behind the performance of the hybrid drive concept is the interaction between combustion engine and electric motor. The combustion engine builds power output and torque with increasing rpm, while the maximum torque of the electric motor is available at any instant. The result is a tremendous torque of 516 lb.-ft.—for incomparable acceleration from a standing start and a new maximum limit for your adrenaline level.

Pure sports car performance, in other words. The figures speak for themselves: acceleration from 0 to 60 mph in only 4.4 seconds and a top track speed of 172 mph.

The total system power is achieved by combining the 330 hp output of the 2.9-liter twin-turbo V6 engine with the 136 hp output of the electric motor. But a high-performance electric motor also needs a powerful energy store—and this task is handled by the 14 kWh lithium-ion high-voltage battery. And a top track speed of 86 mph on electric power alone.

The new Panamera 4 E-Hybrid.  
A courageous next step?  
More like a leap. Towards the future.

European model shown. Some options may not be available.



**Those who take the lead must keep going. Here's the proof.**

### **The Panamera Turbo S E-Hybrid.**

The crucial factor is the interaction between combustion engine and electric motor: two propulsion units that complement each other perfectly. The combustion engine builds power output and torque with increasing rpm. The maximum torque of the electric motor is available instantly. Result: the total system torque of 626 lb.-ft is available from as low as 1400 rpm. The 4.0 liter twin-turbo V8 engine with twin-scroll turbo charging produces 550 hp. The electric motor generates 136 hp. Working together, they deliver an impressive total system power output of 680 hp.

The Panamera Turbo S E-Hybrid accelerates from 0 to 60 mph in 3.2 seconds and breaks barriers to a new dimension with a top track speed of 192 mph.

Meanwhile, the Panamera Turbo S E-Hybrid Executive offers the freedom to flourish: extra legroom and greater comfort in the rear compartment. Business class in fact—on the way to the airport or a meeting.

Both models combine intelligent hybrid technology with comprehensive connectivity and an ultra modern standard specification. They transform excitement into electrifying thrills. And power into superlative performance.

## Faster. Towards the future. Porsche E-Performance.

### Six driving modes

With Porsche Communication Management (PCM) and the mode switch on the steering wheel, derived from the 918 Spyder, you can choose from up to six driving modes—as well as the Sport Response function for maximum responsiveness.

#### 1. E-Power

In E-Power mode, the vehicle operates on electric power alone. If the accelerator pedal is depressed beyond the resistance point, the combustion engine switches on, allowing you to demand the maximum available total system power output at any time.

#### 2. Hybrid Auto

The intelligent Hybrid Auto mode offers the greatest operating efficiency for trips around town and across the country.

In this mode, the Panamera 4 E-Hybrid is driven by the electric motor, the combustion engine, or by both as the situation demands. For the best possible combination of the two drive systems, the optimum operating strategy is derived from information relating to driving profile, state of charge, road topography, and speed.

#### 3. E-Hold

In E-Hold mode, high-voltage battery charge is maintained at the current level. This means that the energy of the battery can be used at a later time, e.g., for all-electric driving or boosting.

#### 4. E-Charge

When the vehicle is driven in E-Charge mode, the high-voltage battery is charged by the combustion engine. This is useful

if activated, for example, on a section of highway before a drive through town on electric power alone.

#### 5. Sport

In Sport mode, the combustion engine is activated by default and accelerates the Panamera 4 E-Hybrid by interacting with the electric motor. The drivetrain and chassis adopt a sporty setup. In addition, all the energy of the high-voltage battery is made available for boosting.

#### 6. Sport Plus

In Sport Plus mode, the drivetrain and chassis are tuned for maximum performance, the top track speed is made available, and the performance reserves of the combustion engine are used to charge the battery. The energy

produced can then be used for boosting as required.

### Display concept

The centrally positioned power meter on the instrument cluster shows the real-time power demand, has separate arcs for boost and recovery, and displays the vehicle's operating state. Hybrid screens show, among other data, electric range and battery charge.

From the 12-inch touchscreen display of Porsche Communication Management (PCM), you can access Porsche Connect services, and call up information, such as the energy flow display and various vehicle and hybrid functions.

European model shown. Some options may not be available.





**Those who want power must not only demand it, they must also pass it on.**

### **Transmission.**

#### **New 8-speed Porsche Doppelkupplung (PDK)**

Getting more power from an engine is worthwhile only when you know where it needs to go. And how quickly and effectively. The latest Panamera models are equipped with a newly developed 8-speed Porsche Doppelkupplung (PDK),

which translates the tremendous drive force of the engine into the acceleration expected of a sports car.

Gears 1 to 6 have sporty ratios, and top track speed is reached in 6th gear. The 7th and 8th gears have longer ratios, which helps keep the engine speed low

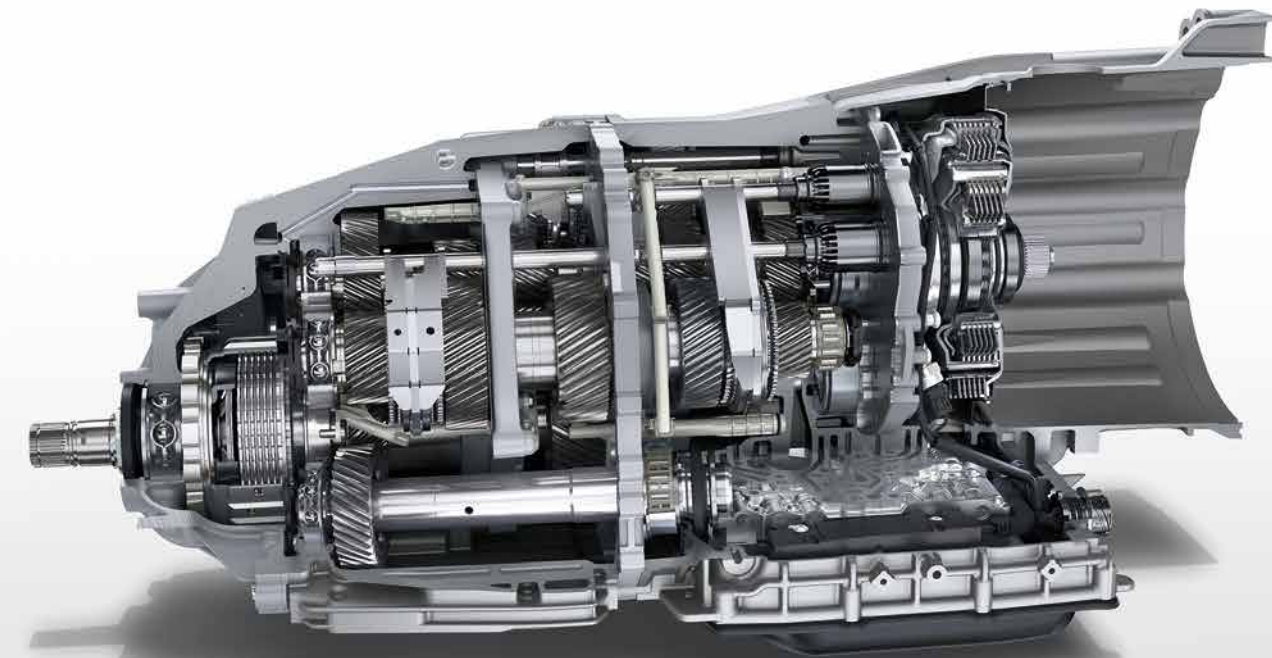

even at high track speeds—for efficient and comfortable driving over long distances. The precise gearshifts take place in milliseconds with no discernible interruption in the flow of power—as you would expect from a Porsche.



**Porsche Traction Management (PTM) all-wheel drive**

All Panamera models—except the rear wheel drive Panamera—are equipped with Porsche Traction Management (PTM). This active all-wheel drive with electronic and map-controlled multiplate clutch ensures the optimum distribution of drive force for excellent acceleration power on long straights, through tight corners, and on road surfaces with varying grip.

The multiplate clutch regulates the power distribution between the front and rear axles. Driving conditions are constantly monitored, enabling the system to respond to a variety of situations. Sensors check the rotation speeds of all four wheels, the longitudinal and lateral acceleration of the vehicle, the steering angle, and more.

If the rear wheels threaten to spin under acceleration, a greater proportion of drive force is distributed to the front by a more powerful engagement of the multiplate clutch.



## The main thing is to follow your own path. But in a consistent way.

### Chassis.

In a Porsche, whether you're behind the wheel or occupying a passenger seat in the front or rear, every drive should feel like sport, not transport.

The chassis of the new Panamera models performs this balancing act between sport and comfort effortlessly—and in the most masterful way possible—with further-developed, optional chassis technologies. Examples include the adaptive air suspension with three-chamber technology boasting a 60 percent greater air capacity than that of the predecessor, new Porsche Dynamic Chassis Control Sport (PDCC Sport) and rear axle steering. What's also new is the standard integrated Porsche 4D Chassis Control system, which centrally analyzes the driving situation in all three spatial dimensions, e.g. pitch, roll, and

yaw, computes optimum driving states from these data, and synchronizes all chassis systems in real time: the fourth dimension. The objective is to optimize overall performance, and to make the middle ground between sporty driving and comfort as expansive as possible.

#### **Porsche Active Suspension Management (PASM)**

Porsche Active Suspension Management (PASM) is an electronic damping control system. It actively and continuously adjusts the damping force on each wheel, based on current road conditions and driving style. The effect is to reduce vehicle body movement and thereby improve comfort in all four seats.

Three modes are available: "Normal," "Sport," and "Sport Plus." Sensors record the body movements as they occur during powerful acceleration, braking, fast cornering, or on uneven road surfaces. From this data, the control unit of the Porsche 4D Chassis Control system determines the effect on the actual driving state of the car and modifies the damping force on each wheel in accordance with the selected mode. The results are tangible: increased driving stability, improved comfort, and enhanced performance.

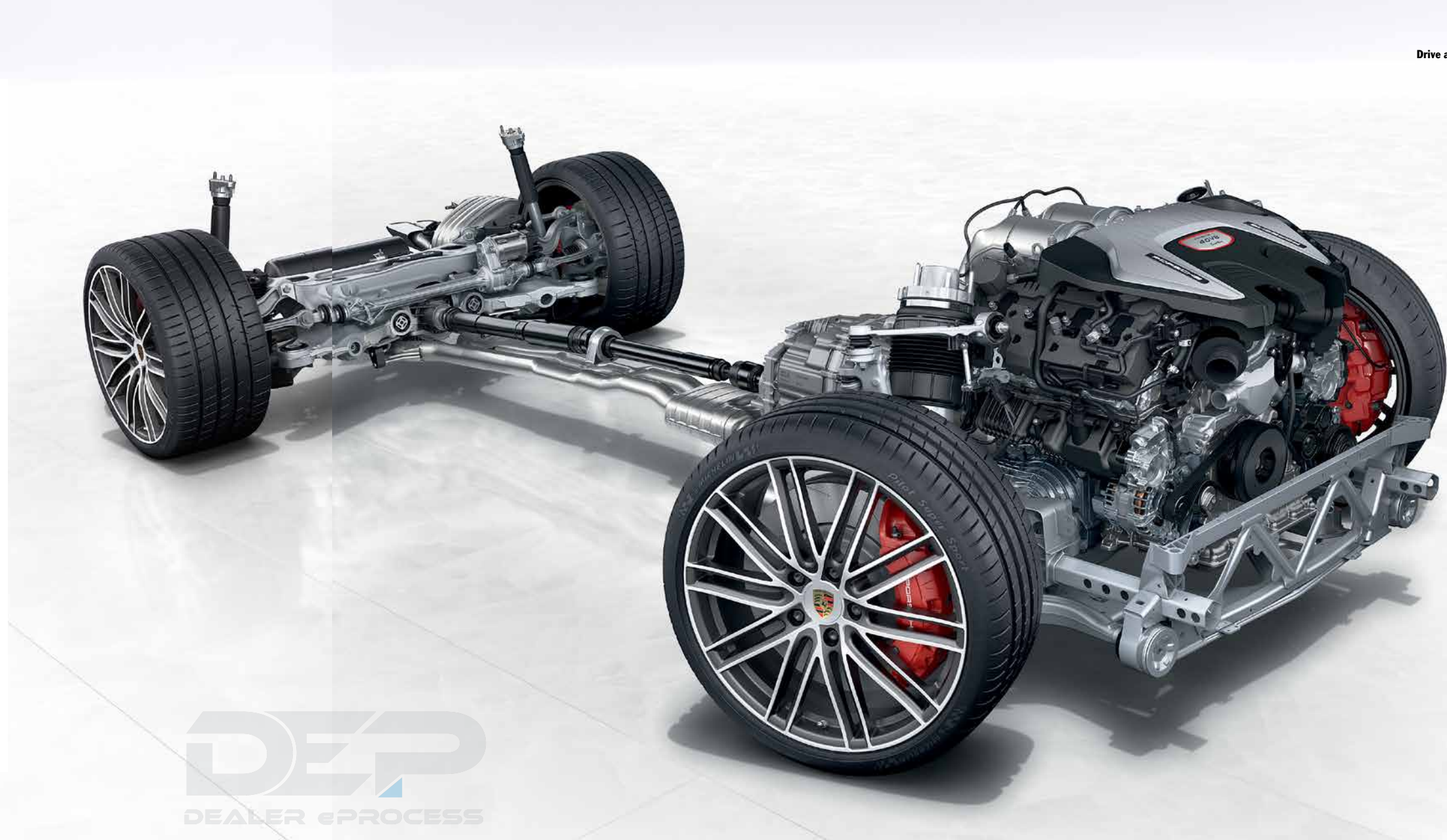



#### Rear axle steering

Optional rear axle steering is available in Panamera models for the first time (standard in the Panamera 4S Executive, Panamera Turbo Executive, and Panamera Turbo S E-Hybrid Executive). It enhances performance and everyday driveability in equal measure. During low-speed maneuvers, the system steers the rear wheels in the opposite direction to that of the front wheels. This has the virtual effect of shortening the wheelbase. The turning circle is reduced, agility is increased, and parking becomes noticeably easier to manage.

During high-speed maneuvers, the system steers the rear wheels in the same direction as that of the front wheels. This virtual extension of the wheelbase increases driving stability.

Rear axle steering makes it clear that there is no contradiction between stability

and agility or performance and everyday driveability. The result: greater maneuverability and driving safety in everyday use—and a significant increase in maximum driving performance.

#### Porsche Dynamic Chassis Control Sport (PDCC Sport) with Porsche Torque Vectoring Plus (PTV Plus)

New Porsche Dynamic Chassis Control Sport (standard on Panamera Turbo S E-Hybrid) is an active roll stabilization system with an ultra sporty setup. It registers the lateral inclination of the body induced by cornering from the very outset and acts to suppress it. The system also reduces the lateral instability of the vehicle on uneven ground.

The new system introduces active electromechanical anti-roll bars that provide a much faster response and are tuned for sporty driving. The result is improved performance.

In combination with new PDCC Sport, Porsche Torque Vectoring Plus (PTV Plus) enhances driving dynamics and stability. As a function of steering angle and steering speed, accelerator pedal position, yaw rate, and vehicle speed, it improves steering response and precision by strategic braking of the right or left rear wheel. At high speeds and when accelerating out of corners, the electronically controlled rear differential lock with fully variable torque distribution also acts to provide greater driving stability and traction.

The overall result? Strong resistance to destabilizing side forces for self-assured poise. Excellent traction. Agility at every speed—with precise turn-in and well-balanced load transfer characteristics. And, as you would expect, even more fun in the corners.



### Brakes

For over 60 years, we've been working on being faster. Even when it comes to slowing down. That's why the new Panamera models are equipped with a brake system having 6-piston aluminum monobloc fixed brake calipers at the front, and 4-piston equivalents at the rear. The brake discs are internally vented and slotted. This improves braking behavior even under extreme conditions, and heat is dissipated more effectively. The one-piece brake calipers have an enclosed construction. This makes them lighter, yet highly resistant to deformation. Pedal travel is tight, the pressure point precise, the braking distance impressively short.

### Porsche Ceramic Composite Brake (PCCB)

Proven in motorsport, Porsche Ceramic Composite Brake (PCCB) is available as an option. For the new Panamera models, the cross-drilled ceramic brake

discs of PCCB now have a diameter of 420 mm at the front and 390 mm at the rear—for even more formidable braking performance. PCCB features 10-piston aluminum monobloc fixed brake calipers on the front axle and 4-piston units at the rear—all painted in yellow—to provide braking forces that are considerably more powerful and exceptionally consistent. PCCB enables shorter braking distances in even the toughest road and race conditions. Safety under high-speed braking is also improved thanks to its excellent fade resistance. Another advantage of PCCB is the extremely low weight of the ceramic brake discs, which are approximately 50 percent lighter than standard discs of a similar design and size. This results in better roadholding and increased comfort, particularly on uneven roads, as well as greater agility and further improvement in handling.





1



2



3



4



5



6



7

### Wheels

We rise to the challenge we're given. The same applies to the wheel dimensions of the new Panamera. The tires are wider and the contact surface is larger for enhanced performance under acceleration and braking. As of now,

optional sizes of up to 21 inches are available for a range of wheel designs, assuring a grand appearance. All new Panamera models are standard equipped with 19-inch wheels, and the Panamera Turbo with 20-inch wheels. The material? Alloy, of course. The design? Classic and

sporty. A choice of other 19-inch, 20-inch, and 21-inch wheels is available on request.

- 1 21-inch 911 Turbo Design wheel
- 2 21-inch Exclusive Design wheel in high-gloss black
- 3 21-inch Panamera SportDesign wheel
- 4 20-inch Panamera Design wheel
- 5 20-inch Panamera Turbo wheel
- 6 19-inch Panamera S wheel
- 7 19-inch Panamera wheel



### Sport mode

With Sport mode, you can swap from comfort tuning to a sporty setup. The electronic engine management system demands a sharper response. Engine dynamics become more direct. In Sport mode, PDK shifts up later and shifts down

sooner. Porsche Active Suspension Management (PASM) and optional Porsche Dynamic Chassis Control Sport (PDCC Sport) and rear axle steering also switch to Sport mode, delivering harder damping, more direct turn-in, and even greater agility through corners.

### Sport Chrono Package with mode switch

Adrenaline at the push of a button. The optional Sport Chrono Package offers an even sportier tuning of the chassis, engine, and transmission. The kit includes a digital and analog stopwatch, a graphic in the instrument cluster showing longitudinal

and lateral acceleration, and a performance display for viewing lap times in Porsche Communication Management (PCM).

What's new is the mode switch on the steering wheel with a Sport Response button, derived from the 918 Spyder.

Four driving modes are available to choose from: "Normal," "Sport," "Sport Plus," and "Individual"—for an even more personalized driving style.

In the Panamera 4 E-Hybrid, the Sport Chrono Package is included as standard. Unlike models powered by combustion engine alone, it has been specially tuned for E-Performance.

Using the hybrid-specific mode switch, you can select the modes "E-Power," "Hybrid Auto," "Sport," and "Sport Plus," while "E-Hold," "E-Charge," and "Individual" are accessible from PCM.



**Sport Plus mode**

In Sport mode alone, the new Panamera delivers increased dynamics and more direct handling. In Sport Plus mode, the engine becomes even more responsive. Porsche Active Suspension Management (PASM) and Porsche Dynamic Chassis

Control Sport (PDCC Sport) are re-tuned for harder damping and more direct turn-in. The adaptive air suspension drops to Low Level and firms the spring rate. The rear axle steering acts to provide even greater agility. And Launch

Control provides optimum acceleration from a standing start.

The Sport Chrono stopwatch mounted on the dashboard displays recorded driving time or can be used as a conventional clock. Porsche

Communication Management (PCM) is upgraded to include a performance display, allowing you to view, store, and evaluate laps or other driving times.

European model shown. Some options may not be available.

**Sport Response**

Pressing the button in the center of the mode switch primes the engine and transmission for the fastest possible unleashing of power (e.g., for overtaking). In other words, maximum responsiveness for a period of approximately 20 seconds.

**PSM Sport**

In conjunction with the Sport Chrono Package, Porsche Stability Management (PSM) is supplemented by a Sport mode. It allows a significantly more sporty driving style, with PSM remaining active in the background. For a further enhancement to your driving experience.





**Comfort and infotainment.**

There's leaning back in comfort. And then there's resting on your laurels. We have always preferred the former. Because the best way to overcome a challenge is with a relaxed approach. For only those who know how to move forward calmly will ultimately stay the course.



**Feel at home.  
Especially on the home straight.**

**Interior.**

Sporty for an outing on the racetrack. Comfortable for a long journey with a party of four. There is no “either-or.” That’s the Panamera. Its ingenious sports car ergonomics are centered on the driver and on performance—with additional regard for the well-being of passengers.

Here are just a few examples. Ascending center console: enabling swift hand movements from the steering wheel to the gear console. New control and display concept: Porsche Advanced Cockpit with newly styled center console featuring a glass-like surface and touch-sensitive buttons arranged in logical groups. High-resolution 12-inch touchscreen display. Instrument cluster with analog tachometer positioned in the

middle, flanked on the left and right by two high-resolution displays.

In the new Panamera Executive models, you have even more legroom. Power seats with specially contoured comfort headrests are included in the standard specification. Optional additions, such as a large rear center console, make the rear compartment an even more agreeable working environment.

And what else? You decide: seat variants, leather or two-tone interior schemes? Fine woods, Aluminum, or Carbon Fiber? More sporty? More luxurious? Both? Thanks to our extensive range of personalization options, your possibilities are virtually boundless.

European model shown. Some options may not be available.

**Instrument cluster**

Analog meets digital: the new instrument cluster of the Panamera models is reminiscent of Porsche motorsport history—and, at the same time, it is as modern as it can be.

In the middle and in direct view of the driver sits the analog tachometer, its needle integral to its truly classic design. To the left and right, two high-resolution displays provide you with a variety of information such as the navigation map or Night Vision Assist.

The speedometer is on the left-hand side of the tachometer and in the center, you can see data relating to adaptive cruise control. In the display field on the outside left, you can choose to show the speed limit indicator, traffic sign recognition, or the outside temperature.

On the right-hand side, the possibilities are even more varied. The inside display field is occupied by information from the on-board computer, the fuel gauge, or the residual range. In the field on the outside right, you can see the time. And there's also an option to view the map of the navigation system.



European model shown. Some options may not be available.

**Front seats**

The front seats offer a high level of comfort and provide support in fast corners without restricting freedom of movement. The seat height, cushion and backrest angles, and fore/aft position are electrically adjustable.

**Power seats**

The Panamera Turbo and Panamera Turbo S E-Hybrid are equipped with 14-way power seats with comfort memory package\* in the front. These allow seat cushion length adjustment and 4-way lumbar support for the driver and front passenger. The comfort memory function stores settings for seats, steering column, both exterior mirrors, and other personalized in-car settings.

**Adaptive Sport Seats**

Available as an option, 18-way Front Adaptive Sports Seats with comfort memory package provide even better lateral support—thanks to the elevated side bolsters on the seat cushion and

backrest. Electrically adjustable, they offer comfort on long journeys and made-to-measure lateral support in the corners.

**Rear seats**

The most striking feature of the rear seats is that there are two separate seats offering plenty of leg- and headroom and excellent lateral support. In any Panamera model, 8-way power seats are available as an option in the rear. In addition to being able to adjust the electric backrest, seat cushion length, and lumbar support, a rear seat passenger can adjust the front passenger seat from the rear compartment (depending on equipment specification). When equipped with Adaptive Sport Seats in the front, the rear features Sport seats with elevated side bolsters.

The Panamera Executive models are equipped with power seats in the rear as standard, featuring heated seat

and comfort headrests with specially contoured side bolsters.

**Seat heating and ventilation**

The front seats of all new Panamera models—and the rear seats of the Panamera Turbo—come equipped with seat heating to warm the cushion and backrest. Optional seat ventilation incorporates active aeration of the perforated seat center and backrest to provide a pleasant seating environment—even in hot weather.

**Massage function**

On request, the 14-way power seats are exclusively available with a massage function—front and rear. With five programs and five intensity levels to choose from, 10 air cushions in each backrest provide a relaxing treat for the back muscles, and offer improved seating and long-distance comfort.

\*Optional on all other models.  
European model shown. Some options may not be available.





**Ambient lighting with rear interior lighting**

Optional ambient lighting is an indirect concept designed to enhance passenger comfort. You can choose from seven lighting colors and customize their intensity.

**Ionizer**

A new ionization function is available as an option for improved air stream quality. Before it reaches the cabin, the air in the automatic climate control system is passed through an ionizer. Airborne viruses, bacteria, and spores are reduced, and the interior air is appreciably refreshed for an even more pleasant cabin environment.

European model shown. Some options may not be available.

#### 4-zone climate control with touchscreen display in rear compartment

Welcome to your personal climate zone. Optional 4-zone climate control features individual temperature setting controls for the driver and front passenger, and separate zones for each seat in the rear, too. The system also comes with a dedicated touchscreen display for the rear compartment. In addition to the air conditioning, this can be used to operate a range of comfort and entertainment functions (depending on equipment specification).

An active carbon filter traps particles, pollen, and odors, and thoroughly filters fine dust from the outside air before it can reach the interior.

European model shown. Some options may not be available.



#### Large rear center console

Available as an option for the Panamera Executive models, the large center console for the rear compartment provides not only extra storage space, but also additional USB interfaces as well as a 12-V and a 120V socket.

#### New Porsche Rear Seat Entertainment System

A cinematic experience enjoyed in the second row: the optional new Porsche Rear Seat Entertainment System has been specially developed to appeal to the discerning Porsche passenger, and offers a fully integrated and networked infotainment system. Both units are removable, making them convenient to use outside the vehicle, too.

The Porsche Rear Seat Entertainment System connects to Porsche Communication Management (PCM) via Wi-Fi to provide access media, navigation system, and vehicle functions of your

Panamera. A wealth of entertainment awaits, thanks to two separate 10-inch touchscreen displays on the front seat backrests, an internal 32-GB memory, micro SD card slot, micro USB interface, Bluetooth®, and NFC (near field communication). Through the connection to the Wi-Fi router of the Connect Plus module, you also have access to the Internet and the Google® Play Store, offering up to one million apps, games, movies, music, audiobooks, e-books, and productivity applications.

For an unrestricted listening experience, you can output the sound from the integrated loudspeakers, the in-car sound system, or the wireless Bluetooth® headphones.

European model shown. Some options may not be available.

**We love to break barriers.  
Sonic ones included.**

**Sound systems.**

**Bose® Surround Sound System\***

The Bose® Surround Sound System features 14 amplifier channels and offers a total output of 710 watts. Fourteen loudspeakers, including a 160-watt passive subwoofer box, ensure a balanced, faithfully reproduced acoustic pattern. The patented AudioPilot® Noise Compensation Technology continuously measures the ambient noise inside the vehicle and adapts music playback instantly and automatically so that a consistent sound is maintained—whatever the driving conditions. In real time. The result is a captivating 360° acoustic experience delivered to all four seat positions. At all times.

\*Standard on Panamera Turbo, Panamera Turbo Executive, Panamera Turbo S E-Hybrid, and Turbo S E-Hybrid Executive. Optional on all models below.



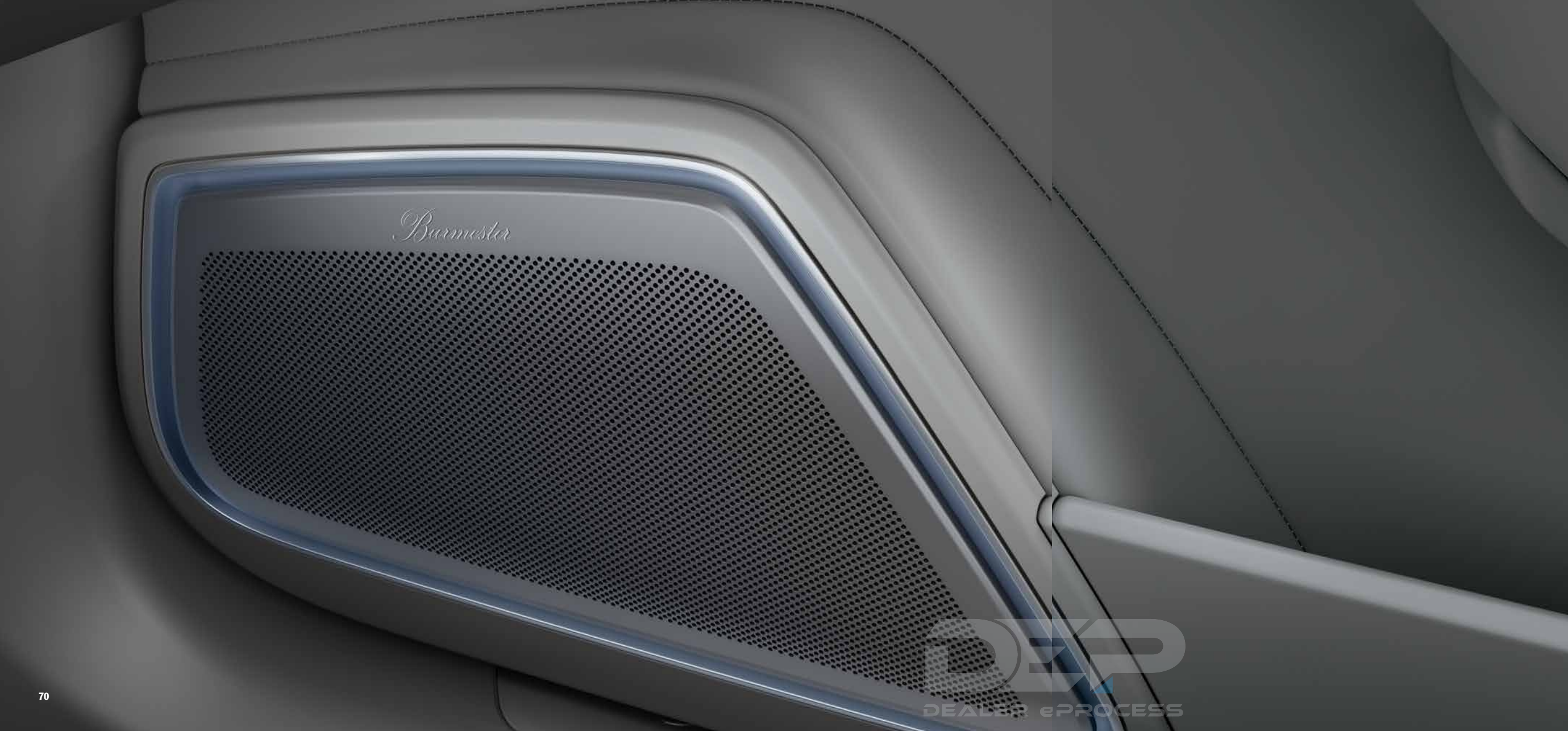

**Burmester® High-End 3D Surround Sound System**

A concert hall with the four best seats around? Panamera. The optional Burmester® High-End 3D Surround Sound System delivers an acoustic performance worthy of the best concert halls in the world, where every audience member can enjoy the full breadth of the stage thanks to the perceived spatial distribution of the sound source.

Quiet, please, as we introduce a total output of 1455 watts, 21 individually controlled loudspeakers, including an active subwoofer with 400-watt class D digital amplifier, 2-way center system and a total diaphragm surface area of more than 2500 cm<sup>2</sup>. Ribbon tweeters have been used for unmistakably fine, clear, and undistorted high-frequency sound reproduction with excellent level stability. All loudspeaker housings are perfectly matched and deliver superior bass foundation, definition and impulse accuracy. The result is a natural and

richly textured spatial sound, even at top volume. Particularly impressive is the new 3D sound experience, created by the loudspeakers integrated into the roof pillars and by the use of a special 3D algorithm.

A superlative visual performance, too. The speaker covers are outlined by white LED lighting or—in conjunction with optional ambient lighting—a choice of seven colors. Uncompromising in sound and design.



## Get more day out of every day.

### Porsche Connect.

Sports car driving has always relied on the relationship between driver and vehicle being as in tune as possible. And now, this relationship becomes even more intimate, helping you overcome day-to-day challenges quickly and easily—with Porsche Connect.

The enhanced Porsche Communication Management (PCM) serves as your control center for audio, communication, and navigation functions. Fitted as standard in all models, it features a high-resolution touchscreen display with integrated proximity sensors for user-friendly ease of operation.

#### Connect Plus

The Connect Plus module consists of Car Connect services that allow you to control various vehicle functions

remotely via an app. It also features Apple CarPlay™ which allows you to use your iPhone® apps while driving and yet still concentrate on the road.

In short, with Porsche Connect\* you get more out of every single day. And that gives you more time for the essential things in life. For family, friends, leisure—and driving your Porsche.

#### Connect App Services

Using the Porsche Connect app for your smartphone or Apple Watch®, you can transfer navigation destinations and calendar events to your Porsche.

In addition, with the real-time traffic information feature, you can plan when and where to indulge in Porsche driving, and have access to various music services along the way.

\*Functionality depends on configuration of each individual vehicle. Some functions require voice control, Porsche Comfort Access, which cannot be installed after production. Some features and services are available with a subscription and may or may not provide a free trial period. For more information please visit: <http://www.porsche.com/usa/connect/facts/> European model shown. Some options may not be available.



**Apple CarPlay™\***

Enjoy a range of iPhone® apps in your Porsche, and with the Siri® voice recognition interface, you can conveniently use your apps on the move. Apple CarPlay™ helps minimize distractions and allows you to keep your full concentration on the road.

**Navigation and Infotainment Services\*\***

Find out in real-time what's going on in the world—whether it's in traffic, on the way to your destination, in the daily news, or on your Twitter timeline. During route guidance, this is made possible by real-time traffic information and Google® Search. What's more, you can also get up-to-date information on weather, flight connections, events, and gas station locations. News reports and tweets are selected based on your interests and can be read aloud by the system.

**Car Connect Services\*\*\***

Retrieve stats and data from your car using your smartphone or Apple Watch®, and control vehicle and hybrid functions

remotely. Benefit from greater safety with emergency and breakdown calls that include location information and protect your Porsche with Security Services.

**Hybrid-specific Connect services\*\* ,\*\*\***

You also have access to a range of extra functions tailored specifically to your E-Hybrid model. The Car Connect app for your smartphone or Apple Watch® lets you collect important information about your E-Hybrid, including all-electric and combined range, the current charge status of the lithium-ion battery, and remaining charge time.

In addition, you can remotely control hybrid-specific functions of your Porsche at your convenience. For example, you can decide the latest time by which the charging process should finish. Even the air conditioning can be optimally configured to suit your daily routine. So you're always ready to go when it matters. Of course, that doesn't mean you can't act on the spur of the moment—you can remotely start the

charging process or air conditioning at any time.

Need a charging point somewhere on your route? With the "Charging pedestals" service of Porsche Connect, you can find charging stations nearby or at your destination. The results can be sorted easily by distance.

For further information, visit [www.porsche.com/connect](http://www.porsche.com/connect) or consult your authorized Porsche dealer.

\*For more details and available apps through Apple CarPlay™, please visit <http://www.apple.com/ios/carplay/>

\*\*Functionality depends on configuration of each individual vehicle. Some functions require voice control, which cannot be installed after production. Sim card and a separate, valid subscription to a mobile network provider (subject to charge) are required for use of Porsche Connect Services. Some features and services are available with a subscription and may or may not provide a free trial period. For more information please visit: <http://www.porsche.com/usa/connect/facts/>

\*\*\*Porsche Car Connect Services (excluding safety and Security Services) include an initial free trial period, the length of which may vary by services package and country. For further information on free trial periods, subscription, and availability of individual services in your country, please visit [www.porsche.com/connect](http://www.porsche.com/connect) or consult your authorized Porsche dealer.



## The courageous always did look far ahead.

### Lights and vision.

The better way to reach your destination is by knowing what's up ahead. When driving, that's true more than ever. All Panamera models are therefore equipped with LED headlights and distinctly Porsche 4-point daytime running lights, 4-point brake lights, and 3D taillights with characteristic light strip.

#### **LED headlights, with Porsche Dynamic Light System (PDLS)**

Fitted as standard to the Panamera Turbo and Turbo S E-Hybrid variants, available as an option for all other Panamera models: LED headlights, with Porsche Dynamic Light System (PDLS) with dynamic range adjustment; dynamic cornering lights. All of these lighting features enhance close-range, side, and distance illumination.

#### **LED headlights with Matrix Design, and Porsche Dynamic Light System Plus (PDLS Plus)**

Even greater foresight is achieved with LED headlights featuring Matrix Design. The optional Matrix Design features a unique look with 84 LEDs and PDLS Plus. PDLS Plus uniformly switches between low and high beam utilizing a camera that monitors up-coming and on-coming traffic for enhanced illumination when available as well as minimizing blinding other vehicles around you.

#### **Night Vision Assist**

The optional Night Vision Assist provides the driver with information even beyond the range of the headlights. An infrared camera detects pedestrians or large wildlife before they are illuminated by the headlights. A thermal image in the

instrument cluster warns the driver, highlighting the detected person or animal in yellow or red, and gives an audible signal if the driver is within the critical range.

European model shown. Some options may not be available.







**Even in leading positions, it's nice to know you don't have to do everything on your own.**

### **Assistance systems.**

Porsche assistance systems are geared toward sporty, active driving, and afford you the driving pleasure you expect of a Porsche.

cruise control will reduce your speed accordingly—even down to a halt. When road conditions allow, your vehicle will accelerate back up to the cruising speed originally set.

#### **Adaptive cruise control (ACC)**

This optional system regulates the speed of your Panamera in line with the speed of the vehicle in front. Radar sensors inside the front end scan the road ahead. Imagine you've selected a cruising speed but begin to gain on the vehicle in front because it is driving slower—the system reduces the speed of your vehicle by restricting throttle or gently applying the brakes until your chosen distance from the vehicle in front is restored.

Your Panamera now continues to maintain this distance from the vehicle ahead. If it slows even more, adaptive

European model shown. Some options may not be available.

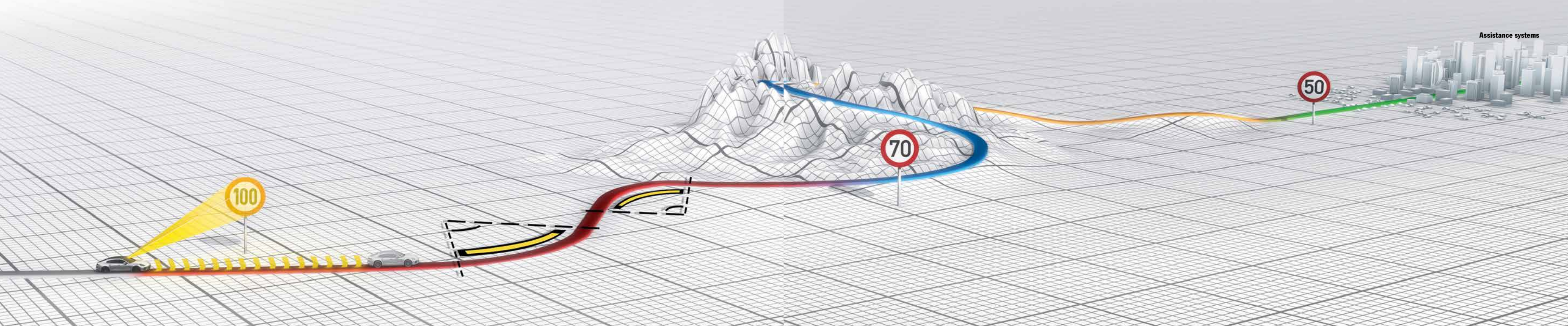

**Porsche InnoDrive\* with adaptive cruise control**

Those who drive a Porsche want to drive. The more sporty, more comfortable and, more efficient the drive—the better. Porsche InnoDrive assists you in a completely new way. The system enhances adaptive cruise control with additional, innovative functions.

It predictively optimizes your speed. With the aid of high-resolution navigation data and information supplied by the radar and video sensors, Porsche InnoDrive determines speed limits and topographical road features, such as gradients or corner radius, along your route even before you reach them—and modifies the gearshift

strategy and speed of the Panamera accordingly. You can adapt the driving feel by pressing the Sport button. Depending on the mode, the system selects the optimum parameters for engine management and gear selection, including coasting and deceleration.

Implemented for the first time at Porsche in the Panamera, the system uses the knowledge gained from its prediction horizon of up to 1.8 miles to formulate the optimum timing for acceleration, constant speed driving, and deceleration phases to provide a intelligent, efficient driving experience.

For example, if a speed restriction is in force along a route but the traffic sign is not yet in sight of the driver, the system already knows that deceleration will be required and initiates a fuel-saving coasting maneuver.

Porsche InnoDrive represents the typical Porsche realization of efficient driving—

for greater comfort and greater driving pleasure.

Porsche InnoDrive also includes Traffic Jam Assist. It eases the burden on the driver when congestion is encountered on major city roads and highways.

At speeds of up to approximately 37 mph, the system uses gentle steering inputs to keep the vehicle in the middle of the lane, regulates the distance from vehicles in front, and follows the traffic ahead where system limitations allow.

To do this, Traffic Jam Assist tracks roadway markings and other vehicles

on the road. The benefit? Appreciable stress relief and greater comfort on long journeys.

\* The assistance provided by Porsche InnoDrive is subject to system limitations. The driver must monitor driving style at all times and intervene in cases of doubt. The system can be overridden at any time by use of the brake or accelerator pedal.

Porsche InnoDrive is not available in some countries.



#### Lane Change Assist

Lane Change Assist uses radar sensors to monitor the areas to the rear of the vehicle and the blind spots on both sides. As you move to change lanes, the system issues a visual warning signal in the exterior mirrors if another vehicle is rapidly approaching your vehicle from behind, or is residing in one of your blind spots. The optional function can be activated in PCM as required for greater comfort especially on the highway.

boundary signs.) Information is displayed in the instrument cluster. The advantage over information stored in the navigation database is that even temporary speed restrictions can be detected.

How do you benefit? Increased comfort. And reduced stress, especially on long cross-country journeys.

#### Lane Keep Assist with traffic sign recognition

Lane Keep Assist is an optional camera-based system for automatic detection of divider line markings on the road. The system eases the burden on the driver by providing steering assistance, helping to keep the vehicle in its lane.

Integrated traffic sign recognition uses a camera and navigation data to detect speed limits and no passing zones, and to infer local traffic codes (e.g., from

European model shown. Some options may not be available.



**ParkAssist with reversing camera and Surround View**

ParkAssist is fitted in all Panamera models and audibly alerts the driver to the presence of obstacles detected to the front and rear of the vehicle. The audible alert is supplemented by a visual warning on the central display screen.

The standard reversing camera facilitates precise reverse parking and maneuvering. Help is provided in the form of the camera image and the dynamic, superimposed guidelines on the PCM screen which illustrate the predicted course of the vehicle given the current position of the steering wheel.

The optional Surround View system supplements the reversing camera with three more high-resolution cameras—one in the front fascia and one in each lower trim of the exterior mirrors. Based on the information supplied by all four cameras, the system generates a virtual bird's eye view of the car and displays it

on the PCM screen. It is also possible to switch between various camera views to improve visibility, e.g., at narrow exits.





### Personalization.

We make decisions day in and day out. In our jobs. In our private lives. In our hearts. Every decision takes courage. What does it come down to? The fact that we make ourselves part of those decisions. And remain true to ourselves. It's how we avoid any notion of compromise—and build character instead.

**We believe in passion for the sports car.  
And for every detail.**

### **Personalization.**

Just imagine if everything were possible. If you could create the sports car of your dreams. Without restriction. With a diverse range of colors. With extra personality and performance. Like Ferry Porsche did with the first ever Porsche: the 356 No.1.

On the pages that follow, we will show you how a dream car becomes a reality. For a clear overview, all available options have been organized by category. With the extensive color palette and wide range of optional equipment, you can give personality to your Panamera. Let the following pages fill you with inspiration—and let your creativity run wild.

European model shown. Some options may not be available.

The possibilities are many. The limits are few and far between. Take Porsche Exclusive as an example, where you can have your Panamera personalized the way you envisioned. Directly on the shop floor. To the ultimate level. And for the most part, by hand.

You can find out more about the ultimate form of personalization on the following pages. We have taken special care to point out all the personalization options available from Porsche Exclusive. You'll be amazed at what we can do.





## The transition from handicraft to craftsmanship is a fluid one. Porsche Exclusive Manufaktur.

Our wealth of experience goes back a long way. Since the very beginning, Porsche has been dedicated to giving customers the opportunity to personalize their vehicle as part of our special request service. Known until 1986 as the Porsche Sonderwunschprogramm, today we call it Porsche Exclusive Manufaktur. But the philosophy has remained the same.

We love what we do. We love our work. Every seam, every square inch of leather, and every fine detail receives the same devotion. It's how we bring dreams to life. And how we create something unique. Directly from the Manufaktur.

None of this would be possible without originality, inspiration, and enthusiasm, beginning as early as the consultation stage. That's because we keep in mind

one thing above all else: your particular wishes and requirements. We fulfill them with meticulous care, by means of precision handcrafting and the use of exquisite materials such as Leather, Alcantara®, Carbon Fiber, Mahogany, and Aluminum.

Added value is achieved with dedication and finesse. In other words, we handcraft a product that blends sporty performance, comfort, and style to reflect your own personal taste. A Porsche with your signature touch.

We offer a wide range of personalization options, with visual and technical enhancements for the interior and exterior, from a single alteration to extensive modifications. For your inspiration, select examples of our unique accomplishments are showcased on the following pages.



## Strong personality development is an inner drive.

### The Panamera Turbo in GT Silver Metallic.

Never settling. Forever raising the bar. That mindset is encoded in an athlete's genes. It embodies the inner attitude given outward expression. The same is true for the Panamera Turbo in GT Silver Metallic.

same time. Even the exterior mirrors painted in high-gloss black and the model designation on the rear reinforce this sports star's commanding outward appearance.

The overall impression is athletic, innovative and individual. The details include a SportDesign package that makes your Panamera appear even sportier thanks to the distinctive front fascia, side skirts, and rear fascia; a Sport exhaust system that impresses audibly and visually—thanks to the Sport tailpipes painted in black and 21-inch Panamera SportDesign wheels, which are both individual and dynamic at the

And the inside is equally impressive. New Porsche Rear Seat Entertainment means that the best seats in the house are not necessarily in the front row. Details like the Porsche Crest embossed on the headrests and the seat belts in Bordeaux Red refine the car's individual character.

Sportiness and individuality are words we interpret literally. No wonder there's so much inner drive.



- 1 Porsche Rear Seat Entertainment, model logo on center console armrests, leather interior package, Sport Chrono stopwatch instrument dial in Bordeaux Red
- 2 SportDesign package painted in high-gloss black, Sport exhaust system with Sport tailpipes in black, tinted LED taillights with light strip, painted model designation, door handles painted in high-gloss black, 21-inch SportDesign wheels painted in high-gloss black, air outlet grilles painted in high-gloss black
- 3 SportDesign package painted in high-gloss black, exterior mirrors painted in high-gloss black
- 4 Porsche Crest embossed on headrests, seat belts in Bordeaux Red

European model shown. Some options may not be available.



**Fashion is transient.  
Elegance is timeless.**

### **The Panamera 4S in black.**

True elegance is not a passing trend. It is timeless. Combine it with sportiness and individuality, as embodied by the Panamera 4S in black, and you witness the emergence of a sports car. Full of emotions, free of conventions.

The outward appearance is dominated by classy black. While the SportDesign package and the Sport exhaust system with black tailpipes make a stunning statement of their own, selected details —such as painted exterior mirrors and the model designation painted on the rear—underline the exclusive look of this Panamera 4S. Classy 21-inch Exclusive Design wheels painted in high-gloss

black and tinted LED taillights complete the elegant overall impression.

Inside, the two-tone leather interior and the new Paldao wooden decor refines the exclusive design of the cabin. The warm tone and color gradient create stylish accents for the interior package and the multifunction Sport steering wheel. The Porsche Crest embossed on the center console armrests and on the headrests add the finishing touches.

- 1 Porsche Crest embossed on center console armrests
- 2 SportDesign package, 21-inch Exclusive Design wheels painted in high-gloss black, painted exterior mirrors
- 3 SportDesign package, Sport exhaust system with Sport tailpipes in black, 21-inch Exclusive Design wheels painted in high-gloss black, tinted LED taillights with light strip, painted model designation
- 4 Paldao interior package, multifunction sport steering wheel in Paldao, Porsche Rear Seat Entertainment, Porsche Crest embossed on center console armrests, Porsche Crest embossed on headrests, steering column casing in leather and instrument surround upper section in leather

European model shown. Some options may not be available.



1



2



3

Personalization | Porsche Exclusive



4

**Our art of engineering. Your power of imagination.  
A unique combination.**

**The Panamera Turbo Executive in Carmine Red.**

The principle of the Panamera Turbo Executive calls for lots of room to maneuver and plenty of freedom to flourish.

The proof? This unique example in Carmine Red—a work of art. The SportDesign package painted in high-gloss black lends the sedan an athletic appearance. This image is powerfully reinforced by 21-inch Exclusive Design wheels painted in high-gloss black and Sport tailpipes in silver color. The LED taillights and the light strip are tinted—for a masterful finish.

Inside, high-quality leather meets richly contrasting Carmine Red. The painted interior package ensures a stunning sporty look and, at the same time, harmonizes perfectly with the car's exterior. The armrests of the leather-lined center console are embossed with the model logo. Even the casing of the steering column and the surround of the instrument cluster are lined in leather as a mark of exclusivity. Another highlight: the illuminated door-sill guards in Brushed Aluminum. A vehicle key and key pouch in matching color give this masterpiece a finishing touch and emphasize your excellent taste.

- 1 Interior package painted, Sport Chrono stopwatch instrument dial in Bordeaux Red, model logo embossed on center console armrests, steering column casing and instrument surround in leather
- 2 21-inch Exclusive Design wheels painted in high-gloss black, painted exterior mirrors and air outlet grilles
- 3 SportDesign package painted in high-gloss black, Sport tailpipes in silver, tinted LED taillights
- 4 Vehicle key painted key pouch in leather
- 5 Door-sill guards in Brushed Aluminum, illuminated

European model shown. Some options may not be available.



1



2



**High performance—  
also where the personalization is concerned.**

**The Panamera Turbo S E-Hybrid in Night Blue Metallic.**

The best tradition: stay courageous and innovative. Not least when it comes to personalization. Only then can you shape the future in extraordinary fashion.

exterior color so that attention is drawn to a particular highlight in the area of E-Performance: the brake calipers in Acid Green.

And it's the only way to turn an exceptional sports car into a genuine one of a kind. A unique example like this one. With the SportDesign package painted in high-gloss black, tinted LED taillights—and a Sport exhaust system that catches not only the ear with its special sound, but also the eye thanks to the Sport tailpipes in black. In keeping, we opted for 21-inch Panamera SportDesign wheels painted in the

The interior is another masterpiece of personalization. Complementing some exquisite Porsche Exclusive leather finishes and embossed details, the interior package with deviated stitching and deviated seat centers adds, above all, color contrasts in Chalk that are both extraordinary and individual at the same time.

There may be many pathways to the future. The best is still the one chosen by you.

3



4



5



- 1 SportDesign package painted in high-gloss black, painted 21-inch Panamera SportDesign wheels, Sport exhaust system with Sport tailpipes in black, tinted LED taillights, painted model designation, door handles painted in high-gloss black, air outlet grilles painted in high-gloss black, painted exterior mirrors
- 2 Leather interior package, interior trim package with deviated stitching and seat centers in leather in contrasting color (Chalk), steering column casing and instrument surround in leather
- 3 SportDesign package painted in high-gloss black, Sport exhaust system with Sport tailpipes in black, tinted LED taillights with light strip, painted model designation
- 4 Interior trim package with deviated stitching and seat centers in leather in contrasting color (Chalk), model logo embossed on center console armrests, Porsche Crest embossed on headrests, seat belts in Chalk
- 5 Personalized floor mats in Carbon Fiber with leather edging, and door-sill guards in Carbon Fiber, illuminated

European model shown. Some options may not be available.

Solid exterior colors

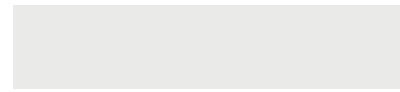

White



Black



Metallic exterior colors



Carrara White Metallic



Rhodium Silver Metallic



Sapphire Blue Metallic



Burgundy Red Metallic<sup>1</sup>



Ristretto Brown Metallic<sup>1</sup>



Mahogany Metallic



Night Blue Metallic



Agate Grey Metallic



Volcano Grey Metallic



Jet Black Metallic



Special exterior colors



GT Silver Metallic



Chalk



Carmine Red



Amethyst Metallic



<sup>1</sup>Available from 08/2017 at the earliest.

**Standard interior colors**  
**Partial leather interior**  
**Dashboard/trim/seats**

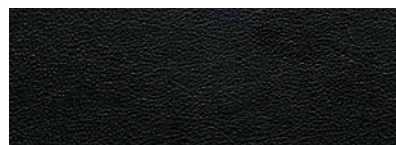

Black  
 (Roof lining: Black. Carpet: Black)



Agate Grey  
 (Roof lining: Agate Grey. Carpet: Agate Grey)

**Standard two-tone interior colors**  
**Partial leather interior**  
**Dashboard/trim/seats**

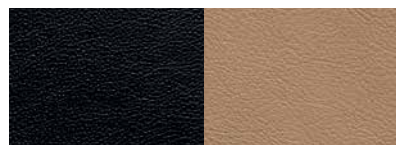

Black and Luxor Beige  
 (Roof lining: Luxor Beige. Carpet: Black)

**Standard interior colors**  
**Leather interior**  
**Dashboard/trim/seats**

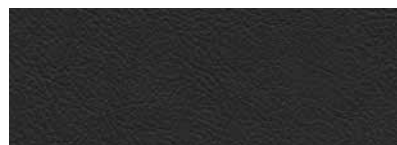

Black  
 (Roof lining: Black. Carpet: Black)



Agate Grey  
 (Roof lining: Agate Grey. Carpet: Agate Grey)

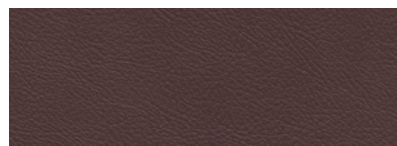

Marsala  
 (Roof lining: Black. Carpet: Marsala)

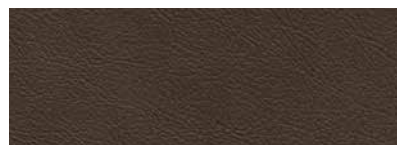

Saddle Brown  
 (Roof lining: Black. Carpet: Saddle Brown)

**Two-tone interior colors**  
**Leather interior**  
**Dashboard/trim/seats**



Black and Chalk  
 (Roof lining: Chalk. Carpet: Black)



Marsala and Cream  
 (Roof lining: Cream. Carpet: Marsala)

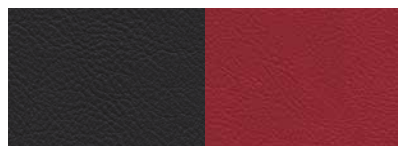

Black and Bordeaux Red  
 (Roof lining: Black. Carpet: Black)

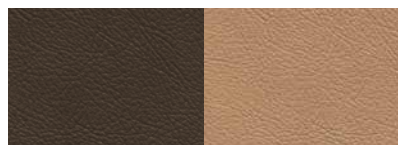

Saddle Brown and Luxor Beige  
 (Roof lining: Luxor Beige. Carpet: Saddle Brown)

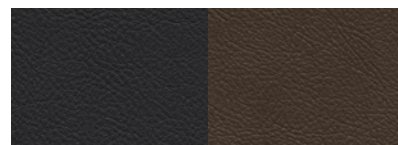

Black and Saddle Brown  
 (Roof lining: Black. Carpet: Black)



Black and Luxor Beige  
 (Roof lining: Luxor Beige. Carpet: Black)

**Club leather**

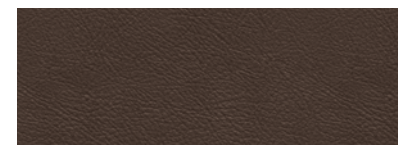

Truffle Brown Club Leather<sup>1</sup>  
 (Roof lining: Truffle Brown. Carpet: Truffle Brown)

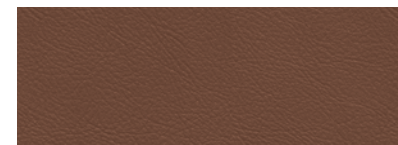

Cohiba Brown Club Leather<sup>1</sup>  
 (Roof lining: Cohiba Brown. Carpet: Cohiba Brown)

**Interior packages**

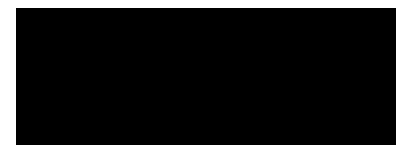

High-Gloss Black



Brushed Aluminum

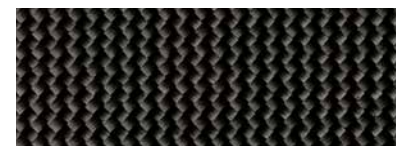

Carbon Fiber



Dark Walnut<sup>2</sup>



Anthracite Birch<sup>2</sup>



Sweetgum<sup>2</sup>



Paldao<sup>2</sup>

Exclusive



Leather

Exclusive



Painted

Exclusive

<sup>1</sup> Club leather is a very high-quality, new Napa leather that creates a particularly luxurious feel thanks to the natural light and dark contrasts and high-quality feel.

<sup>2</sup> Since wood is a natural product, there may be variations in color and grain.



Black



Marsala



Black and Chalk



Saddle Brown and Luxor Beige



Agate Grey



Saddle Brown



Marsala and Cream



Black and Saddle Brown



Black and Luxor Beige



Black and Bordeaux Red



European model shown. Some options may not be available.

In essence, even the details of your Porsche are a highlight.



Adaptive air suspension with three-chamber technology



Porsche Ceramic Composite Brake (PCCB)



Ambient lighting with rear interior lighting



LED Headlights with Matrix Design including PDLs Plus



18-way, Adaptive Sport Seats in front with memory package



4-zone climate control



Rear axle steering

European model shown. Some options may not be available.

# How do we make the extraordinary even more extraordinary? With Porsche Exclusive.



SportDesign package, SportDesign package painted in high-gloss black

Exclusive



21-inch Exclusive Design wheel painted in Satin Platinum

Exclusive



Porsche Crest embossed on headrests and seat belts in Bordeaux Red

Exclusive



Porsche Rear Seat Entertainment

Exclusive



Sport tailpipes in silver

Exclusive



21-inch Panamera SportDesign wheel painted in Jet Black Metallic

Exclusive



Model logo embossed on center console armrests

Exclusive



Painted Model Designation

Exclusive

European model shown. Some options may not be available.





Sport Chrono Package



Sport Exhaust System with Sport Tailpipes in Brushed Stainless Steel **Exclusive**



Sport Exhaust System with Sport Tailpipes in High-Gloss Black **Exclusive**

Option	Panamera	Panamera 4	Panamera 4 E-Hybrid	Panamera 4S	Panamera Turbo	Panamera Turbo S E-Hybrid	Panamera 4 Executive	Panamera 4 E-Hybrid Executive	Panamera 4S Executive	Panamera Turbo Executive	Panamera Turbo S E-Hybrid Executive	I no.
<b>Engine</b>												
Sport Chrono Package	○	○	●	○	○	●	○	○	○	○	●	QR5
Sport Exhaust System with Sport Tailpipes in Brushed Stainless Steel	○	○	○	○	○	○	○	○	○	○	○	OP8
<b>Exclusive</b>												
Sport Exhaust System with Sport Tailpipes in High-Gloss Black	○	○	○	○	○	○	○	○	○	○	○	OP9
<b>Exclusive</b>												
Sport Tailpipes in Silver	○	○	○	○	○	○	○	○	○	○	○	OP3
<b>Exclusive</b>												
Sport Tailpipes in Black	○	○	○	○	○	○	○	○	○	○	○	OP6
<b>Exclusive</b>												

Option	Panamera	Panamera 4	Panamera 4 E-Hybrid	Panamera 4S	Panamera Turbo	Panamera Turbo S E-Hybrid	Panamera 4 Executive	Panamera 4 E-Hybrid Executive	Panamera 4S Executive	Panamera Turbo Executive	Panamera Turbo S E-Hybrid Executive	I no.
<b>Chassis</b>												
Power Steering Plus	○	○	○	○	○	○	○	○	○	○	○	1N3
Adaptive Air Suspension with Porsche Active Suspension Management (PASM)	○	○	●	○	○	○	○	○	○	○	○	1BK
Porsche Dynamic Chassis Control Sport (PDCC Sport) with Porsche Torque Vectoring Plus (PTV Plus)	-	-	-	○	○	○	○	○	○	○	○	1P7
Rear Axle Steering with Power Steering Plus	○	○	○	○	○	○	○	○	○	○	○	0N5
Porsche Ceramic Composite Brake (PCCB)	○	○	○	○	○	○	○	○	○	○	○	1ZQ



Rear Axle Steering



Porsche Ceramic Composite Brake (PCCB)



- Not available   ○ Optional/extra-cost option   ● Standard   □ Available at no extra cost  
 For more information on the options featured in this brochure, please refer to the separate price list.



21-inch Exclusive Design wheel

Exclusive



21-inch Exclusive Design wheel painted in high-gloss black

Exclusive



21-inch Exclusive Design wheel painted

Exclusive

**Option**

**Wheels**

Option	Panamera	Panamera 4	Panamera 4 E-Hybrid	Panamera 4S	Panamera Turbo	Panamera Turbo S E-Hybrid	Panamera 4 Executive	Panamera 4 E-Hybrid Executive	Panamera 4S Executive	Panamera Turbo Executive	Panamera Turbo S E-Hybrid Executive	I no.
19-inch Panamera Wheels	●	●	●	○	–	–	●	●	○	–	–	V57
19-inch Panamera S Wheels	○	○	○	●	–	–	○	○	●	–	–	V58
20-inch Panamera Turbo Wheels	○	○	○	○	●	○	○	○	○	●	○	44G
20-inch Panamera Design Wheels	○	○	○	○	○	–	○	○	○	○	–	44H
21-inch 911 Turbo Design Wheels	○	○	○	○	○	●	○	○	○	○	○	44E
21-inch Exclusive Design Wheels	○	○	○	○	○	○	○	○	○	○	○	44F
21-inch Exclusive Design Wheels Painted in High-Gloss Black	○	○	○	○	○	○	○	○	○	○	○	44A
21-inch Exclusive Design Wheels Painted in Satin Platinum	○	○	○	○	○	○	○	○	○	○	○	44C
21-inch Exclusive Design Wheels Painted <sup>1</sup>	○	○	○	○	○	○	○	○	○	○	○	43W
21-inch Exclusive Design Wheels Painted in Jet Black Metallic <sup>1</sup>	○	○	○	○	○	○	○	○	○	○	○	44B

**Option**

**Wheels**

Option	Panamera	Panamera 4	Panamera 4 E-Hybrid	Panamera 4S	Panamera Turbo	Panamera Turbo S E-Hybrid	Panamera 4 Executive	Panamera 4 E-Hybrid Executive	Panamera 4S Executive	Panamera Turbo Executive	Panamera Turbo S E-Hybrid Executive	I no.
21-inch Panamera SportDesign Wheels	○	○	○	○	○	○	○	○	○	○	○	44D
21-inch Panamera SportDesign Wheels Painted in High-Gloss Black	○	○	○	○	○	○	○	○	○	○	○	43S
21-inch Panamera SportDesign Wheels Painted in Satin Black	○	○	○	○	○	○	○	○	○	○	○	43T
21-inch Panamera SportDesign Wheels Painted <sup>1</sup>	○	○	○	○	○	○	○	○	○	○	○	43V
21-inch Panamera SportDesign Wheels Painted in Jet Black Metallic	○	○	○	○	○	○	○	○	○	○	○	43U
All-Season Tires for 20-inch Alloy Wheels	○	○	○	○	○	–	○	○	○	○	–	Q04
All-Season Tires for 21-inch Alloy Wheels	○	○	○	○	○	●	○	○	○	○	○	Q02
Summer Tires for 19-inch Alloy Wheels	●	●	●	●	–	–	●	●	–	–	–	
Wheel Centers with Full-Color Porsche Crest	○	○	○	○	○	○	○	○	○	○	○	1NP



21-inch Panamera SportDesign Wheel Painted in High-Gloss Black

Exclusive



21-inch Panamera SportDesign Wheel Painted

Exclusive



21-inch Panamera SportDesign Wheel Painted in Satin Platinum

Exclusive



<sup>1</sup>Paint finish in exterior color.

– Not available   ○ Optional/extra-cost option   ● Standard   □ Available at no extra cost  
For more information on the options featured in this brochure, please refer to the separate price list.



Exterior Mirrors Painted

Exclusive



Exterior Mirrors Painted in High-Gloss Black

Exclusive



SportDesign Side Skirts

Exclusive

Option	Panamera	Panamera 4	Panamera 4 E-Hybrid	Panamera 4S	Panamera Turbo	Panamera Turbo S E-Hybrid	Panamera 4 Executive	Panamera 4 E-Hybrid Executive	Panamera 4S Executive	Panamera Turbo Executive	Panamera Turbo S E-Hybrid Executive	I no.
<b>Exterior</b>												
Metallic Paint	o	o	o	o	o	o	o	o	o	o	o	Code
Special Colors	o	o	o	o	o	o	o	o	o	o	o	Code
Paint to Sample <sup>1</sup>	o	o	o	o	o	o	o	o	o	o	o	Code
Window Trim in High-Gloss Black	o	o	o	o	o	o	o	o	o	o	o	QJ4
SportDesign Package <sup>2</sup>	o	o	o	o	o	o	o	o	o	o	o	2D1
<b>Exclusive</b>												
SportDesign Package Painted in High-Gloss Black <sup>3</sup>	o	o	o	o	o	o	o	o	o	o	o	2D5
<b>Exclusive</b>												
SportDesign Side Skirts <sup>4</sup>	o	o	o	o	o	o	o	o	o	o	o	VR4
<b>Exclusive</b>												
Exterior Mirrors Painted <sup>4</sup>	o	o	o	o	o	o	o	o	o	o	o	6FU
<b>Exclusive</b>												
Air Outlets Painted <sup>4</sup>	o	o	o	o	o	o	o	o	o	o	o	VK5
<b>Exclusive</b>												
Exterior Mirrors Painted in High-Gloss Black	o	o	o	o	o	o	o	o	o	o	o	6FH
<b>Exclusive</b>												
Air Outlets Painted in High-Gloss Black	o	o	o	o	o	o	o	o	o	o	o	VK4
<b>Exclusive</b>												

Option	Panamera	Panamera 4	Panamera 4 E-Hybrid	Panamera 4S	Panamera Turbo	Panamera Turbo S E-Hybrid	Panamera 4 Executive	Panamera 4 E-Hybrid Executive	Panamera 4S Executive	Panamera Turbo Executive	Panamera Turbo S E-Hybrid Executive	I no.
<b>Exterior</b>												
Door Handles in High-Gloss Black	o	o	o	o	o	o	o	o	o	o	o	6JA
<b>Exclusive</b>												
Model Designation Painted <sup>5</sup>	o	o	o	o	o	o	o	o	o	o	o	AAV
<b>Exclusive</b>												
Deletion of Model Designation	o	o	o	o	o	o	o	o	o	o	o	0NA
Roof Transport System <sup>6</sup>	o	o	o	o	o	o	o	o	o	o	o	3S8
Rear Wiper	o	o	o	o	o	o	o	o	o	o	o	8M1
<b>Lights and vision</b>												
LED Headlights with PDLS	o	o	o	o	o	o	o	o	o	o	o	8IS
LED Headlights with Matrix Design including PDLS Plus	o	o	o	o	o	o	o	o	o	o	o	8IU
Tinted LED Taillights with Light Strip	o	o	o	o	o	o	o	o	o	o	o	8SB
<b>Exclusive</b>												
Ambient Lighting <sup>6</sup>	o	o	o	o	o	o	o	o	o	o	o	QQ1
Ambient Lighting with Rear Interior Lighting <sup>3</sup>	o	o	o	o	o	o	o	o	o	o	o	QQ2

<sup>1</sup>Provisionally available from 08/2017.

<sup>2</sup>Paint finish in exterior color. Front fascia air intake grille slats, front fascia C-blades and rear fascia diffuser in Satin Black.

<sup>3</sup>Paint finish in exterior color. Front fascia air intake grille slats, front fascia C-blades and rear fascia diffuser in high-gloss black.

<sup>4</sup>Paint finish in exterior color.

<sup>5</sup>Paint finish in exterior color or in high-gloss black.

<sup>6</sup>Provisionally available from 01/2017.

o Optional/extra-cost option • Standard □ Available at no extra cost  
 For more information on the options featured in this brochure, please refer to the separate price list.



LED Headlights with Matrix Design including PDLS Plus



Tinted LED Taillights

Exclusive



Door Handles Painted in High-Gloss Black

Exclusive





Panoramic Roof System



Power Sunblind for rear compartment

**Option**

**Cabin conditioning**

Option	Panamera	Panamera 4	Panamera 4 E-Hybrid	Panamera 4S	Panamera Turbo	Panamera Turbo S E-Hybrid	Panamera 4 Executive	Panamera 4 E-Hybrid Executive	Panamera 4S Executive	Panamera Turbo Executive	Panamera Turbo S E-Hybrid Executive	I no.
4-Zone Climate Control	○	○	○	○	○	○	○	○	○	●	●	9AH
Panoramic Roof System	●	●	●	●	●	●	●	●	●	●	●	
Thermally and Noise Insulated Glass	○	○	○	○	○	○	○	○	○	○	○	VW5
Power Sunblind for Rear Side Windows	○	○	○	○	○	○	○	○	○	○	○	3Y7
Power Sunblind for Rear Compartment	-	-	-	-	-	-	●	●	-	-	-	3Y2
Power Sunblind for Rear Compartment and Side Windows	-	-	-	-	-	-	-	●	●	●	●	3Y8
Parking Pre-Climatization	-	-	●	-	●	-	●	-	-	-	●	

**Option**

**Seats**

Option	Panamera	Panamera 4	Panamera 4 E-Hybrid	Panamera 4S	Panamera Turbo	Panamera Turbo S E-Hybrid	Panamera 4 Executive	Panamera 4 E-Hybrid Executive	Panamera 4S Executive	Panamera Turbo Executive	Panamera Turbo S E-Hybrid Executive	I no.
Driver Memory Package	●	●	●	●	-	-	●	●	-	-	-	3L4
14-Way Power Seats (Front) with Comfort Memory Package	○	○	○	○	●	●	○	○	○	○	○	Q2J
18-Way Adaptive Sport Seats with Comfort Memory Package	○	○	○	○	○	○	-	-	-	-	○	Q1J
8-Way Power Seats (Rear) with Memory Package	○	○	○	○	○	○	●	●	●	●	●	3KK
8-Way Power Seats (Rear) with Memory Package (in Conjunction with Adaptive Sport Seats)	○	○	○	○	○	○	-	-	-	-	-	3KL
Seat Heating (Front)	●	●	●	●	-	-	-	-	-	-	-	4A3
Seat Heating (Front and Rear)	○	○	○	○	●	●	●	●	●	●	●	4A4
Seat Ventilation (Front)	○	○	○	○	○	○	○	○	○	○	○	4D3
Seat Ventilation (Front and Rear)	○	○	○	○	○	○	○	○	○	○	○	4D1
Massage Function (Front)	○	○	○	○	○	○	○	○	○	○	○	4D7
Massage Function (Front) with Seat Ventilation (Front)	○	○	○	○	○	○	○	○	○	○	○	4D5
Massage Function (Front) with Seat Ventilation (Front and Rear)	○	○	○	○	○	○	○	○	○	○	○	4D9
Massage Function (Front and Rear) with Seat Ventilation (Front and Rear)	○	○	○	○	○	○	○	○	○	○	○	4D2



8-Way Power Seats (Rear) with Memory Package



14-Way Power Seats (Front) with Comfort Memory Package



- Not available   ○ Optional/extra-cost option   ● Standard   □ Available at no extra cost  
 For more information on the options featured in this brochure, please refer to the separate price list.  
 European model shown. Some options may not be available.

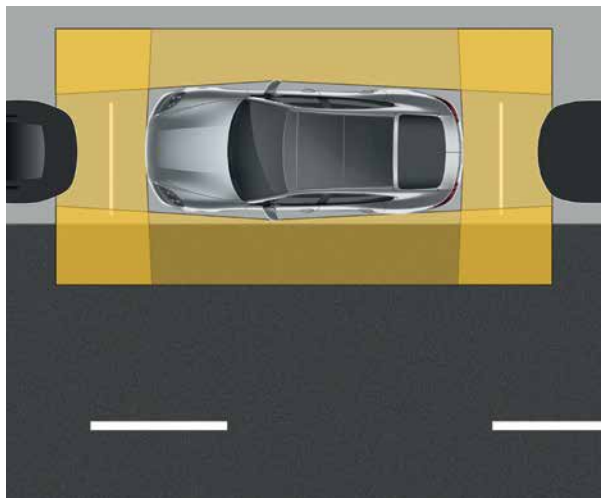

ParkAssist with Surround View



Lane Keep Assist with Traffic Sign Recognition

**Option**

**Comfort and assistance systems**

Option	Panamera	Panamera 4	Panamera 4 E-Hybrid	Panamera 4S	Panamera Turbo	Panamera Turbo S E-Hybrid	Panamera 4 Executive	Panamera 4 E-Hybrid Executive	Panamera 4S Executive	Panamera Turbo Executive	Panamera Turbo S E-Hybrid Executive	I no.
ParkAssist with Reversing Camera	•	•	•	•	•	•	•	•	•	•	•	7X8
ParkAssist with Surround View	◦	◦	◦	◦	◦	◦	◦	◦	◦	◦	◦	8A4
Lane Change Assist	◦	◦	◦	◦	◦	◦	◦	◦	◦	◦	◦	7Y1
Lane Keep Assist with Traffic Sign Recognition	◦	◦	◦	◦	◦	◦	◦	◦	◦	◦	◦	P8A
Adaptive Cruise Control	◦	◦	◦	◦	◦	◦	◦	◦	◦	◦	◦	8T3
Porsche InnoDrive with Adaptive Cruise Control <sup>1</sup>	◦	◦	◦	◦	◦	◦	◦	◦	◦	◦	◦	P8D
Night Vision Assist	◦	◦	◦	◦	◦	◦	◦	◦	◦	◦	◦	9R1
Comfort Access	◦	◦	◦	◦	•	•	◦	◦	◦	•	•	4F2
Soft-Close Doors	◦	◦	◦	◦	◦	◦	◦	◦	•	•	•	GZ2

**Option**

**Interior**

Option	Panamera	Panamera 4	Panamera 4S	Panamera 4 E-Hybrid	Panamera Turbo	Panamera Turbo S E-Hybrid	Panamera 4 Executive	Panamera 4S Executive	Panamera Turbo Executive	Panamera Turbo S E-Hybrid Executive	I no.	
Ionizer	◦	◦	◦	◦	◦	◦	◦	◦	◦	◦	2V4	
Steering Wheel Heating	◦	◦	◦	◦	◦	◦	◦	◦	◦	◦	2Z4	
Storage Package	◻	◻	◻	◻	◻	◻	◻	◻	◻	◻	QE1	
Ski Bag	◦	◦	◦	◦	◦	◦	◦	◦	◦	◦	3X1	
Smoking Package	◻	◻	◻	◻	◻	◻	◻	◻	◻	◻	9JB	
Interior Package in High-Gloss Black	•	•	•	◻	◻	•	•	•	◻	◻	5TL	
Interior Package Painted <sup>1</sup>												
<b>Exclusive</b>												
– in Exterior Color	◦	◦	◦	◦	◦	◦	◦	◦	◦	◦	◦	7TL
– in Contrasting Exterior Color <sup>2</sup>	◦	◦	◦	◦	◦	◦	◦	◦	◦	◦	◦	APC
Seat Belts Colored <sup>1</sup>												
<b>Exclusive</b>												
– in Chalk	◦	◦	◦	◦	◦	◦	◦	◦	◦	◦	◦	FI8
– in Bordeaux Red	◦	◦	◦	◦	◦	◦	◦	◦	◦	◦	◦	FI6

<sup>1</sup>Provisionally available from 07/2017.

<sup>2</sup>Choice of color from all available standard and special colors.

◦ Not available   ◻ Optional/extra-cost option   • Standard   ◻ Available at no extra cost  
For more information on the options featured in this brochure, please refer to the separate price list.

European model shown. Some options may not be available.



Interior Package Painted

Exclusive



Seat Belts in Chalk

Exclusive





Sport Chrono Stopwatch Instrument Dial in White

Exclusive



Sport Chrono Stopwatch Instrument Dial in Bordeaux Red

Exclusive



Leather Interior Package

Exclusive

**Option**

**Interior**

Option	Panamera	Panamera 4	Panamera 4 E-Hybrid	Panamera 4S	Panamera Turbo	Panamera Turbo S E-Hybrid	Panamera 4 Executive	Panamera 4 E-Hybrid Executive	Panamera 4S Executive	Panamera Turbo Executive	Panamera Turbo S E-Hybrid Executive	I no.
Large Rear Center Console	-	-	-	-	-	-	o	o	o	o	o	3Z7
Fixed Luggage Compartment Cover	o	o	o	o	o	o	o	o	o	o	o	3U7
Vehicle Key Painted with Key Pouch in Leather <sup>1</sup>	o	o	o	o	o	o	o	o	o	o	o	BFL
Sport Chrono Stopwatch Instrument Dial Colored												
<b>Exclusive</b>												
- White	o	o	o	o	o	o	o	o	o	o	o	UP3
- Luxor Beige	o	o	o	o	o	o	o	o	o	o	o	UP4
- Bordeaux Red	o	o	o	o	o	o	o	o	o	o	o	UP6
<b>Interior: Leather</b>												
Standard Interior	•	•	•	•	-	-	•	•	•	-	-	Standard
Standard Interior, Two-Tone	o	o	o	o	-	-	o	o	o	-	-	Code
Leather Interior	o	o	o	o	•	•	o	o	o	•	•	Code
Leather Interior, Two-Tone	o	o	o	o	o	o	o	o	o	o	o	Code
Leather Interior, Club Leather	o	o	o	o	o	o	o	o	o	o	o	Code

**Option**

**Interior: Leather**

Option	Panamera	Panamera 4	Panamera 4 E-Hybrid	Panamera 4S	Panamera Turbo	Panamera Turbo S E-Hybrid	Panamera 4 Executive	Panamera 4 E-Hybrid Executive	Panamera 4S Executive	Panamera Turbo Executive	Panamera Turbo S E-Hybrid Executive	I no.
Leather Interior Package												
<b>Exclusive</b>												
- in Interior Color	o	o	o	o	o	o	o	o	o	o	o	7TM
- in Contrasting Interior Color <sup>2</sup>	o	o	o	o	o	o	o	o	o	o	o	APL
Porsche Crest Embossed on Headrests	o	o	o	o	o	o	o	o	o	o	o	5ZF
<b>Exclusive</b>												
Porsche Crest Embossed on Center Console Armrests	o	o	o	o	o	o	o	o	o	o	o	6E2
<b>Exclusive</b>												
Model Logo Embossed on Center Console Armrests	o	o	o	o	o	o	o	o	o	o	o	6E3
<b>Exclusive</b>												
Steering Column Casing and Instrument Surround in Leather <sup>3</sup>	o	o	o	o	o	o	o	o	o	o	o	ALK
<b>Exclusive</b>												



Porsche Crest Embossed on Headrests

Exclusive



Model Logo Embossed on Center Console Armrests



Steering Column Casing and Instrument Surround in Leather

Exclusive

<sup>1</sup>Paint finish in exterior color, leather in interior color.

<sup>2</sup>Choice of color from all available standard and special colors.

<sup>3</sup>Lined with leather in interior color.

- Not available    o Optional/extra-cost option    • Standard    □ Available at no extra cost  
For more information on the options featured in this brochure, please refer to the separate price list.

European model shown. Some options may not be available.





Brushed Aluminum Interior Package



Carbon Fiber Interior Package



Door-Sill Guards in Carbon Fiber

Exclusive

Option	Panamera	Panamera 4	Panamera 4 E-Hybrid	Panamera 4S	Panamera Turbo	Panamera Turbo S E-Hybrid	Panamera 4 Executive	Panamera 4 E-Hybrid Executive	Panamera 4S Executive	Panamera Turbo Executive	Panamera Turbo S E-Hybrid Executive	I no.
<b>Interior: Alcantara®</b>												
Roof lining in Alcantara®	<input type="radio"/>	<input type="radio"/>	<input type="radio"/>	<input type="radio"/>	<input checked="" type="radio"/>	<input checked="" type="radio"/>	<input type="radio"/>	<input type="radio"/>	<input type="radio"/>	<input checked="" type="radio"/>	<input checked="" type="radio"/>	6NN
<b>Interior: Brushed Aluminum</b>												
Brushed Aluminum Interior Package	<input type="radio"/>	<input type="radio"/>	<input type="radio"/>	<input type="radio"/>	<input type="checkbox"/>	<input type="checkbox"/>	<input type="radio"/>	<input type="radio"/>	<input type="radio"/>	<input type="checkbox"/>	<input type="checkbox"/>	5TE
Door-Sill Guards in Brushed Aluminum, Illuminated Exclusive	<input type="radio"/>	<input type="radio"/>	<input type="radio"/>	<input type="radio"/>	<input type="radio"/>	<input type="radio"/>	<input type="radio"/>	<input type="radio"/>	<input type="radio"/>	<input type="radio"/>	<input type="radio"/>	VT2
<b>Interior: Carbon Fiber</b>												
Carbon Fiber Interior Package	<input type="radio"/>	<input type="radio"/>	<input type="radio"/>	<input type="radio"/>	<input type="radio"/>	<input type="radio"/>	<input type="radio"/>	<input type="radio"/>	<input type="radio"/>	<input type="radio"/>	<input type="radio"/>	5MH
Heated Multifunction Steering Wheel in Carbon Fiber with Gearshift Paddles	<input type="radio"/>	<input type="radio"/>	<input type="radio"/>	<input type="radio"/>	<input type="radio"/>	<input type="radio"/>	<input type="radio"/>	<input type="radio"/>	<input type="radio"/>	<input type="radio"/>	<input type="radio"/>	2FX
Door-Sill Guards in Carbon Fiber Exclusive	<input type="radio"/>	<input type="radio"/>	<input type="radio"/>	<input type="radio"/>	<input type="radio"/>	<input type="radio"/>	<input type="radio"/>	<input type="radio"/>	<input type="radio"/>	<input type="radio"/>	<input type="radio"/>	7M3
Door-Sill Guards in Carbon Fiber, Illuminated Exclusive	<input type="radio"/>	<input type="radio"/>	<input type="radio"/>	<input type="radio"/>	<input type="radio"/>	<input type="radio"/>	<input type="radio"/>	<input type="radio"/>	<input type="radio"/>	<input type="radio"/>	<input type="radio"/>	7M8
Personalized Floor Mats in Carbon Fiber with Leather Edging¹ Exclusive	<input type="radio"/>	<input type="radio"/>	<input type="radio"/>	<input type="radio"/>	<input type="radio"/>	<input type="radio"/>	<input type="radio"/>	<input type="radio"/>	<input type="radio"/>	<input type="radio"/>	<input type="radio"/>	ACJ

Option	Panamera	Panamera 4	Panamera 4 E-Hybrid	Panamera 4S	Panamera Turbo	Panamera Turbo S E-Hybrid	Panamera 4 Executive	Panamera 4 E-Hybrid Executive	Panamera 4S Executive	Panamera Turbo Executive	Panamera Turbo S E-Hybrid Executive	I no.
<b>Interior: Wood²</b>												
Dark Walnut Interior Package	<input type="radio"/>	<input type="radio"/>	<input type="radio"/>	<input type="radio"/>	<input checked="" type="radio"/>	<input checked="" type="radio"/>	<input type="radio"/>	<input type="radio"/>	<input type="radio"/>	<input type="radio"/>	<input type="radio"/>	5MP
Heated Multifunction Steering Wheel in Dark Walnut with Gearshift Paddles	<input type="radio"/>	<input type="radio"/>	<input type="radio"/>	<input type="radio"/>	<input type="radio"/>	<input type="radio"/>	<input type="radio"/>	<input type="radio"/>	<input type="radio"/>	<input type="radio"/>	<input type="radio"/>	1XG
Anthracite Birch Interior Package	<input type="radio"/>	<input type="radio"/>	<input type="radio"/>	<input type="radio"/>	<input type="checkbox"/>	<input type="checkbox"/>	<input type="radio"/>	<input type="radio"/>	<input type="radio"/>	<input type="checkbox"/>	<input type="checkbox"/>	5MB
Heated Multifunction Steering Wheel in Anthracite Birch with Gearshift Paddles	<input type="radio"/>	<input type="radio"/>	<input type="radio"/>	<input type="radio"/>	<input type="radio"/>	<input type="radio"/>	<input type="radio"/>	<input type="radio"/>	<input type="radio"/>	<input type="radio"/>	<input type="radio"/>	1XE
Sweetgum Interior Package	<input type="radio"/>	<input type="radio"/>	<input type="radio"/>	<input type="radio"/>	<input type="checkbox"/>	<input type="checkbox"/>	<input type="radio"/>	<input type="radio"/>	<input type="radio"/>	<input type="checkbox"/>	<input type="checkbox"/>	7TD
Heated Multifunction Steering Wheel in Sweetgum with Gearshift Paddles	<input type="radio"/>	<input type="radio"/>	<input type="radio"/>	<input type="radio"/>	<input type="radio"/>	<input type="radio"/>	<input type="radio"/>	<input type="radio"/>	<input type="radio"/>	<input type="radio"/>	<input type="radio"/>	2FF
Paldao Interior Package³ Exclusive	<input type="radio"/>	<input type="radio"/>	<input type="radio"/>	<input type="radio"/>	<input type="radio"/>	<input type="radio"/>	<input type="radio"/>	<input type="radio"/>	<input type="radio"/>	<input type="radio"/>	<input type="radio"/>	7TC
Heated Multifunction Steering Wheel in Paldao¹ with Gearshift Paddles Exclusive	<input type="radio"/>	<input type="radio"/>	<input type="radio"/>	<input type="radio"/>	<input type="radio"/>	<input type="radio"/>	<input type="radio"/>	<input type="radio"/>	<input type="radio"/>	<input type="radio"/>	<input type="radio"/>	2FG

¹Leather edging and stitching available in all standard colors.

²Since wood is a natural product, there may be variations in color and grain.

³Provisionally available from 07/2017.

– Not available    ◯ Optional/extra-cost option    ● Standard    □ Available at no extra cost  
For more information on the options featured in this brochure, please refer to the separate price list.

European model shown. Some options may not be available.



Sweetgum Interior Package



Paldao Interior Package and Multifunction Steering Wheel in Paldao

Exclusive



Connect Plus



Porsche Rear Seat Entertainment

**Option**

**Audio and communication**

Option	Panamera	Panamera 4	Panamera 4 E-Hybrid	Panamera 4S	Panamera Turbo	Panamera Turbo S E-Hybrid	Panamera 4 Executive	Panamera 4 E-Hybrid Executive	Panamera 4S Executive	Panamera Turbo Executive	Panamera Turbo S E-Hybrid Executive	I no.
Porsche Communication Management (PCM) with Navigation	•	•	•	•	•	•	•	•	•	•	•	Standard
Connect Plus	•	•	•	•	•	•	•	•	•	•	•	Standard
Bose® Surround Sound System	◦	◦	◦	◦	•	•	◦	◦	◦	•	•	9VL
Burmester® High-End 3D Surround Sound System	◦	◦	◦	◦	◦	◦	◦	◦	◦	◦	◦	9VJ
6-disc CD/DVD Changer	◦	◦	◦	◦	◦	◦	◦	◦	◦	◦	◦	6G2
Porsche Rear Seat Entertainment <b>Exclusive</b>	◦	◦	◦	◦	◦	◦	◦	◦	◦	◦	◦	9WY
USB Interface in Rear	◦	◦	◦	◦	◦	◦	◦	◦	◦	◦	◦	UI2

**Option**

**Porsche European Delivery**

Option	Panamera	Panamera 4	Panamera 4 E-Hybrid	Panamera 4S	Panamera Turbo	Panamera Turbo S E-Hybrid	Panamera 4 Executive	Panamera 4 E-Hybrid Executive	Panamera 4S Executive	Panamera Turbo Executive	Panamera Turbo S E-Hybrid Executive	I no.
Porsche European Delivery in Zuffenhausen	◦	◦	◦	◦	◦	◦	◦	◦	◦	◦	◦	SZ8
Porsche European Delivery in Leipzig including intensive driving experience	◦	◦	◦	◦	◦	◦	◦	◦	◦	◦	◦	S9Y

**Porsche North America Delivery**

Option	Panamera	Panamera 4	Panamera 4 E-Hybrid	Panamera 4S	Panamera Turbo	Panamera Turbo S E-Hybrid	Panamera 4 Executive	Panamera 4 E-Hybrid Executive	Panamera 4S Executive	Panamera Turbo Executive	Panamera Turbo S E-Hybrid Executive	I no.
Porsche Delivery in Atlanta	◦	◦	◦	◦	◦	◦	◦	◦	◦	◦	◦	
Porsche Delivery in Los Angeles	◦	◦	◦	◦	◦	◦	◦	◦	◦	◦	◦	

**E-Performance**

Option	Panamera	Panamera 4	Panamera 4 E-Hybrid	Panamera 4S	Panamera Turbo	Panamera Turbo S E-Hybrid	Panamera 4 Executive	Panamera 4 E-Hybrid Executive	Panamera 4S Executive	Panamera Turbo Executive	Panamera Turbo S E-Hybrid Executive	I no.
On-board Charger with 7.2 kW Charging Output	-	◦	◦	-	-	◦	-	◦	-	-	◦	KB2
Porsche Charging Dock for Docking the Porsche Universal Charger (AC)	-	-	◦	-	-	◦	-	◦	-	-	◦	NJ1
Level 1 Charging, 120v	-	-	•	-	-	•	-	•	-	-	•	Standard
Level 2 Charging, 240v	-	-	•	-	-	•	-	•	-	-	•	Standard



Charging cable



Charging pedestal with Porsche Charging Dock



- Not available ◦ Optional/extra-cost option • Standard □ Available at no extra cost  
 For more information on the options featured in this brochure, please refer to the separate price list.  
 European model shown. Some options may not be available.



## Porsche Tequipment — accessories developed for 365 days full of life.

With the Porsche Tequipment range of accessories developed specifically for your Panamera, you can style your car to your own preference. From the start, the same rules that apply to our vehicles also apply to the products of Porsche Tequipment: developed, tested, and proven at the Development Center in Weissach, by the same Porsche engineers and designers who made your car. Designed with the complete vehicle in mind and precisely tailored to your Porsche.

And your original car warranty? It will remain completely intact, whichever Tequipment products you ask your authorized Porsche dealer to fit.

To discover more about Porsche Tequipment, please consult your authorized Porsche dealer. Alternatively, all Tequipment products can be found online at [www.porscheusa.com/tequipment](http://www.porscheusa.com/tequipment) using our “Tequipment accessories finder.”

### [1] Car Care Sets

Interior and exterior care products optimally selected and formulated for your Porsche.

### [2] Child Seats

Distinctively designed, and specially tested and approved for Porsche cars.

### [3] Porsche Charge-o-mat Pro

Reduces battery charging time thanks to its increased charging power.

### [4] Roof Boxes

Lockable plastic roof boxes in high-gloss black or platinum look, with a capacity of approximately 11.30 or 18.36 cu ft.

### [5] Winter Wheel and Tire Sets

For enhanced individuality, agility, and safety. And even greater driving pleasure.

### [6] Car Cover

Tailored indoor or outdoor cover with Porsche Crest.



1



2



3



4



5



6

## Porsche Car Configurator.

Taste, personality, and style. You decide how to refine the Panamera to your personal preference. With the Porsche Car Configurator, you can see the result instantly on your computer, following four simple steps.

It's as simple as selecting or deselecting the options you want. The price is recalculated automatically with each click. It looks stunning, too, because all features are rendered in 3D. So you can view your configuration from any angle, save it, and print it.

Visit [www.porscheusa.com](http://www.porscheusa.com) to find the Porsche Car Configurator and discover much more about the fascination of Porsche.

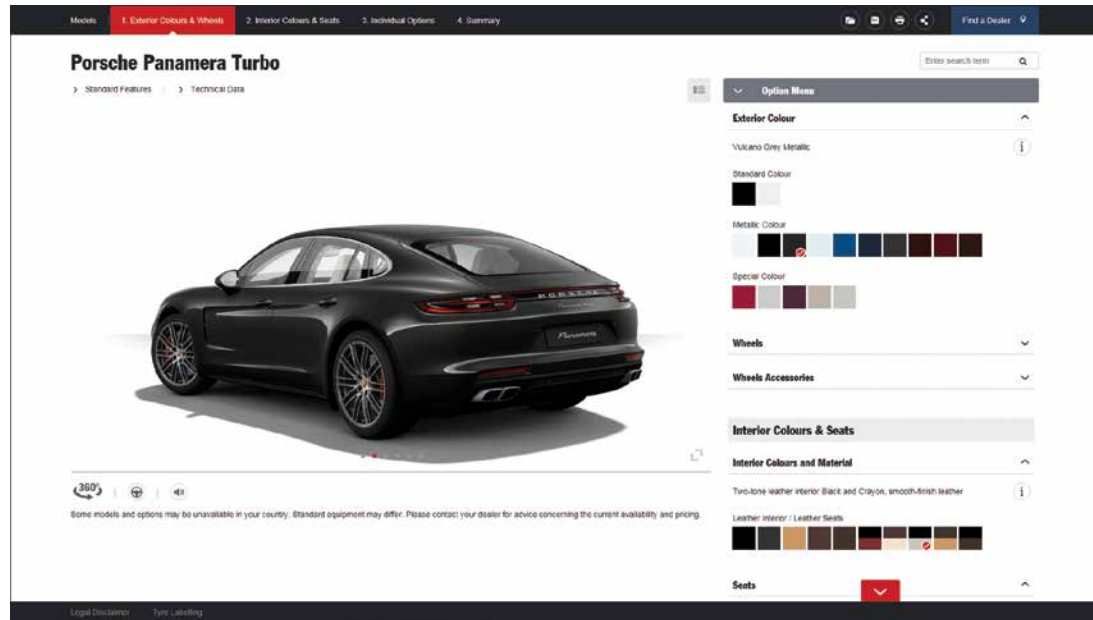

## Designing your Porsche.

### Consultation.

At your authorized Porsche dealer, we're on hand to answer all your questions about your new Porsche. Of course, the same applies to the personalization options of Porsche Exclusive.

In our Customer Centers in Stuttgart-Zuffenhausen and Leipzig, and in our Porsche Exclusive – Personal Design Studios in Atlanta, Georgia, and Los Angeles, California, we will show you what else can be done. You can select

your materials and paint colors and plan your vehicle in detail using the Porsche Car Configurator.

### Porsche delivery.

After the planning comes the thrill of anticipation as the day of delivery approaches.

In Stuttgart-Zuffenhausen, you can experience and learn about every aspect of the legendary Porsche brand. In addition to receiving a detailed

description of your car, you will also gain insight into the entire history of Porsche with a visit to the Porsche Museum.

The new Porsche Experience Centers in Atlanta and Los Angeles offer new vehicle delivery with a complete immersion into Porsche experience. Please visit [www.porschedriving.com](http://www.porschedriving.com) to learn more.

At our Leipzig location, you're going to take to the starting grid – in a Porsche

model identical to the one you purchased and under the expert supervision of one of our instructors. During the drive, they will demonstrate all the functions of your new Porsche and the potential that lies within. On-road on the racetrack or on our very own off-road track.

Whichever location you choose includes the moment you've been waiting for: taking delivery of your Porsche.

To arrange a date for your Porsche delivery experience, please consult your authorized Porsche dealer.





**The Porsche Experience Center Atlanta\***  
The Porsche Experience Center Atlanta offers guests an opportunity to increase their driving prowess with challenging test tracks and training facilities. Visit [www.porschedriving.com](http://www.porschedriving.com) or call 1-800-Porsche to learn more.



**Porsche European Delivery**  
Imagine touring the factory and then being handed the keys for an even more gratifying opportunity—touring Europe in your brand new Porsche vehicle. What happens next is up to you. Contact your authorized Porsche dealer for more information.



**Porsche Exclusive\***  
Realize your vision of the perfect Porsche with our factory customization program. From styling enhancements to performance upgrades, all modifications are uniquely handcrafted for your Porsche vehicle. Please visit [www.porscheusa.com/exclusive](http://www.porscheusa.com/exclusive) for more information.



**Porsche Tequipment\***  
Personalize your Porsche vehicle at any time with our range of aftermarket accessories. You will also find all our available products online at [www.porscheusa.com/tequipment](http://www.porscheusa.com/tequipment).



**Porsche Driver's Selection\***  
With products ranging from fashion and accessories to tailored luggage, this unique collection combines quality and style with everyday practicality. Visit your authorized Porsche dealer or shop online at [www.porscheusa.com/shop](http://www.porscheusa.com/shop).



**Porsche Travel Club**  
Embark on a thrilling adventure and feel the power of Porsche. Stay in top-class hotels and dine in five-star restaurants worldwide. Visit [www.porscheusa.com/travelclub](http://www.porscheusa.com/travelclub) for more information.



**Porsche Sport Driving School-USA\***  
At the PSDS-USA it's all about practice. There's no better place to hone your driving skills than in the cockpit of the latest Porsche models. For both Porsche owners and enthusiasts we offer introductory level through race licensing courses. Please call 770-290-7000 or visit [www.porschedriving.com](http://www.porschedriving.com).



**Porsche Clubs**  
Since the first Porsche Club was founded in 1952, its number has grown to 660 chapters, with a total of 195,000 members worldwide. To find out more, go to [www.porscheusa.com/porscheclub](http://www.porscheusa.com/porscheclub).

**The Porsche Experience Center Los Angeles\***  
At the new Porsche Experience Center Los Angeles, guests can navigate through our electrifying circuit, off-road courses, Ice Hill, and other performance modules. Visit [www.porschedriving.com](http://www.porschedriving.com) or call 1-800-Porsche to learn more.

**Porsche Roadside Assistance**  
Enjoy peace of mind with our exclusive breakdown and accident recovery service. Membership is free when you buy a new Porsche vehicle.



**Porsche Approved Certified Pre-Owned**  
Only the best Porsche cars earn the right to be called "Certified." A meticulous 111-point inspection, a 2-year or 50,000-mile Limited Warranty, and 24-hour Roadside Assistance make this program one-of-a-kind. Contact your authorized Porsche dealer for details.

**Porsche Financial Services**  
Our range of financial services is innovative and specially tailored to the needs of Porsche owners. If you dream Porsche, Porsche Financial Services offers you the perfect financing solution to attain your dream. For more information visit [www.porscheusa.com/financialservices](http://www.porscheusa.com/financialservices) or your authorized Porsche dealer.

**Christophorus**  
Our magazine for Porsche owners has news, interviews, and a wide variety of features from the world of Porsche.

**Porsche Classic**  
Your specialized source for genuine Porsche parts as well as restoration services for all Porsche classics. Visit [www.porscheusa.com/classic](http://www.porscheusa.com/classic) to find out more.

**Porsche Museum**  
More than 80 vehicles at our headquarters in Stuttgart-Zuffenhausen await to take you on a journey through Porsche history. See icons such as the 356, 911, and 917 presented in an atmosphere you can't experience anywhere else.

**Porsche Online**  
Go to [www.porscheusa.com](http://www.porscheusa.com) for all the latest news and information from Porsche. Follow us on:   



\*You can obtain the latest brochures for Porsche Exclusive, Porsche Tequipment, Porsche Driver's Selection, Porsche Experience Center Atlanta, Porsche Experience Center Los Angeles, and Porsche Sport Driving School-USA from your authorized Porsche dealer.



**It can do things you  
wouldn't believe.**

**Until you actually do them.**

Three places where you can blissfully explore the full depth of a Porsche vehicle's capabilities. Three unforgettable driving experiences taught by some of the world's top driving instructors. All designed to provide you with a whole new understanding of our vehicles.

**Porsche Experience Center, Atlanta, Georgia**

**Porsche Experience Center, Los Angeles, California**

**Porsche Sport Driving School at  
Barber Motorsports Park, Birmingham, Alabama**

**Visit [www.porschedriving.com](http://www.porschedriving.com) for more information.**



**PORSCHE**

## Technical data

	Panamera/Panamera 4/Panamera 4 Executive	Panamera 4S/Panamera 4S Executive
<b>Engine</b>		
Type	V6 mono-turbo	V6 twin-turbo
Cylinders	6	6
Displacement	3.0 liters	2.9 liters
Max. power (DIN) at rpm	330 hp between 5400–6400	440 hp between 5650–6600
Max. torque at rpm	331 lb.-ft. between 1340–4900	405 lb.-ft. between 1750–5500
<b>Transmission</b>		
Layout	Rear-wheel drive/all-wheel drive/all-wheel drive	All-wheel drive
8-speed PDK	Standard	Standard
<b>Chassis</b>		
Front axle	Aluminum double-wishbone, independent wheel suspension	Aluminum double-wishbone, independent wheel suspension
Rear axle	Aluminum multi-link axle with subframe, independent wheel suspension	Aluminum multi-link axle with subframe, independent wheel suspension
Steering	Electromechanical power steering	Electromechanical power steering
Brakes	Front: Six-piston aluminum monobloc fixed brake calipers; Rear: Four-piston fixed, finished in Black	Front: Six-piston aluminum monobloc fixed brake calipers; Rear: Four-piston fixed, finished in Titanium Grey
Standard wheels	Front: 9J x 19 ET64 Rear: 10.5J x 19 ET62	Front: 9J x 19 ET64 Rear: 10.5J x 19 ET62
Standard tires	Front: 265/45 ZR 19 Rear: 295/40 ZR 19	Front: 265/45 ZR 19 Rear: 295/40 ZR 19

	Panamera Turbo/Panamera Turbo Executive
<b>Engine</b>	
Type	V8 twin-turbo
Cylinders	8
Displacement	4.0 liters
Max. power (DIN) at rpm	550 hp between 5750–6000
Max. torque at rpm	567 lb.-ft. between 1960–4500
<b>Transmission</b>	
Layout	All-wheel drive
8-speed PDK	Standard
<b>Chassis</b>	
Front axle	Aluminum double-wishbone, independent wheel suspension
Rear axle	Aluminum multi-link axle with subframe, independent wheel suspension
Steering	Electromechanical power steering
Brakes	Front: Six-piston aluminum monobloc fixed brake calipers; Rear: Four-piston fixed, finished in Red
Standard wheels	Front: 9.5J x 20 ET71 Rear: 11.5J x 20 ET68
Standard tires	Front: 275/40 R 20 Rear: 315/35 R 20

## Technical data

	Panamera 4 E-Hybrid/Panamera 4 E-Hybrid Executive	Panamera Turbo S E-Hybrid/Panamera Turbo S E-Hybrid Executive
<b>Engine</b>		
Type	V6 twin-turbo	V8 twin-turbo
Cylinders	6	8
Displacement	2.9 liters	4.0 liters
Max. power (DIN) at rpm	330 hp between 5250–6500	550 hp between 5750–6000
Max. torque at rpm	331 lb.-ft. between 1750–5000	567 lb.-ft. between 1960–4500
Max. power (electric motor) at rpm	136 hp at 2800	136 hp at 2800
Max. torque (electric motor) at rpm	295 lb.-ft. between 100–2300	295 lb.-ft. between 100–2300
Max. total system power at rpm	462 hp at 6000	680 hp between 5750–6000
Max. total system torque at rpm	516 lb.-ft. between 1100–4500	626 lb.-ft. between 1400–5500
<b>Transmission</b>		
Layout	All-wheel drive	All-wheel drive
8-speed PDK	Standard	Standard
<b>Chassis</b>		
Front axle	Aluminum double-wishbone, independent wheel suspension	Aluminum double-wishbone, independent wheel suspension
Rear axle	Aluminum multi-link axle with subframe, independent wheel suspension	Aluminum multi-link axle with subframe, independent wheel suspension
Steering	Electromechanical power steering	Electromechanical power steering
Brakes	Front: Six-piston aluminum monobloc fixed brake calipers; Rear: Four-piston fixed, finished in Acid Green	Front: Ten-piston aluminum monobloc fixed brake calipers; Rear: Four-piston fixed, finished in Acid Green
Standard wheels	Front: 9J x 19 ET64 Rear: 10.5J x 19 ET62	Front: 9.5J x 21 ET71 Rear: 11.5J x 21 ET69
Standard tires	Front: 265/45 ZR 19 Rear: 295/40 ZR 19	Front: 275/35 R 21 Rear: 325/30 R 21

	Panamera	Panamera 4	Panamera 4 Executive
<b>Weights</b>			
Curb weight (lbs.)	4001	4079	4266
Gross weight (lbs.)	5269	5357	5445
<b>Performance</b>			
Top track speed (mph)	164	162	162
0–60 mph (seconds)	5.4	5.2	5.3
Sport Chrono Package (in conjunction with PDK) 0–60 mph w/ Launch Control (seconds)	5.2	5.0	5.1
<b>Fuel consumption<sup>1</sup></b>			
City (mpg)	21	21	21
Highway (mpg)	28	27	27
Combined (mpg)	24	23	23
<b>Dimensions/aerodynamics</b>			
Length (in.)	198.8	198.8	204.7
Width (including exterior mirrors) (in.)	85.2	85.2	85.2
Height (in.)	56.0	56.0	56.2
Wheelbase (in.)	116.1	116.1	122.0
Tank capacity (gal.)	23.7	23.7	23.7
Drag coefficient (Cd)	0.28	0.28	0.28

<sup>1</sup>EPA estimates. Actual mileage may vary.



## Technical data

	Panamera 4S	Panamera 4S Executive
<b>Weights</b>		
Curb weight (lbs.)	4123	4365
Gross weight (lbs.)	5500	5610
<b>Performance</b>		
Top track speed (mph)	179	179
0-60 mph (seconds)	4.2	4.3
Sport Chrono Package (in conjunction with PDK) 0-60 mph w/ Launch Control (seconds)	4.0	4.1
<b>Fuel consumption<sup>1</sup></b>		
City (mpg)	21	21
Highway (mpg)	28	28
Combined (mpg)	23	23
<b>Dimensions/aerodynamics</b>		
Length (in.)	198.8	204.7
Width (including exterior mirrors) (in.)	85.2	85.2
Height (in.)	56.0	56.2
Wheelbase (in.)	116.1	122.0
Tank capacity (gal.)	23.7	23.7
Drag coefficient (Cd)	0.29	0.29

	Panamera Turbo	Panamera Turbo Executive
<b>Weights</b>		
Curb weight (lbs.)	4398	4630
Gross weight (lbs.)	5698	5809
<b>Performance</b>		
Top track speed (mph)	190	190
0-60 mph (seconds)	3.6	3.7
Sport Chrono Package (in conjunction with PDK) 0-60 mph w/ Launch Control (seconds)	3.4	3.5
<b>Fuel consumption<sup>1</sup></b>		
City (mpg)	18	18
Highway (mpg)	25	25
Combined (mpg)	21	21
<b>Dimensions/aerodynamics</b>		
Length (in.)	198.8	204.7
Width (including exterior mirrors) (in.)	85.2	85.2
Height (in.)	56.1	56.4
Wheelbase (in.)	116.1	122.0
Tank capacity (gal.)	23.7	23.7
Drag coefficient (Cd)	0.30	0.29



<sup>1</sup>EPA estimates. Actual mileage may vary.

## Technical data

	Panamera 4 E-Hybrid	Panamera 4 E-Hybrid Executive
<b>Weights</b>		
Curb weight (lbs.)	4784	4960
Gross weight (lbs.)	5974	6117
<b>Performance</b>		
Top track speed (mph)	172	172
0–60 mph (seconds)	-	-
Sport Chrono Package (in conjunction with PDK) 0–60 mph w/ Launch Control (seconds)	4.4	4.5
<b>Fuel consumption<sup>1</sup></b>		
EPA rated Fuel Economy (MPGe)	TBD	TBD
EPA rated electric range (miles)	TBD	TBD
<b>Dimensions/aerodynamics</b>		
Length (in.)	198.8	204.7
Width (including exterior mirrors) (in.)	85.2	85.2
Height (in.)	56.2	56.2
Wheelbase (in.)	116.1	122.0
Tank capacity (gal.)	21.1	21.1
Drag coefficient (Cd)	0.28	0.28

	Panamera Turbo S E-Hybrid	Panamera Turbo S E-Hybrid Executive
<b>Weights</b>		
Curb weight (lbs.)	5093	5313
Gross weight (lbs.)	6162	6360
<b>Performance</b>		
Top track speed (mph)	192	192
0–60 mph (seconds)	-	-
Sport Chrono Package (in conjunction with PDK) 0–60 mph w/ Launch Control (seconds)	3.2	3.3
<b>Fuel consumption<sup>1</sup></b>		
EPA rated Fuel Economy (MPGe)	TBD	TBD
EPA rated electric range (miles)	TBD	TBD
<b>Dimensions/aerodynamics</b>		
Length (in.)	198.8	204.7
Width (including exterior mirrors) (in.)	85.2	85.2
Height (in.)	56.2	56.4
Wheelbase (in.)	116.1	122.0
Tank capacity (gal.)	21.1	21.1
Drag coefficient (Cd)	0.29	0.29



<sup>1</sup>EPA estimates. Your mileage and range may vary. As of the time of printing, the 2017 EPA numbers are yet to be determined. Please see your authorized Porsche dealer or visit [www.porscheusa.com](http://www.porscheusa.com) for the latest information



## Index

<b>A</b>	Chassis	27, 42	<b>F</b>	LED headlights with Matrix Design including Porsche Dynamic Light System Plus (PDLS Plus)	76, 115	Porsche Active Suspension Management (PASM)	42, 111	Porsche Stability Management Sport (PSM Sport)	53	Sport Response	53	
Adaptive air suspension	Colors	100	Fuel	137	Porsche Advanced Cockpit	24, 57	Porsche Torque Vectoring Plus (PTV Plus)	45, 111	Surround View	84, 118	<b>T</b>	
Adaptive Cruise Control (ACC)	Comfort	55, 118	<b>H</b>	Headlights	76, 115	Porsche Car Configurator	128	Porsche Traction Management (PTM)	40	Technical data	134	
Adaptive cylinder control	Connect app	72	Hybrid Auto Mode	36	<b>M</b>	Porsche Car Connect	74	Power output	29, 30, 33, 36	Touchscreen display	24, 36, 57, 65, 72	
Air conditioning	Connect Plus module	72, 124	<b>I</b>	Infotainment	54, 74	Porsche Ceramic Composite Brake (PCCB)	46, 106, 111	<b>R</b>	Real-time traffic information	72	Traffic Jam Assist	81
All-wheel drive	<b>D</b>	Design	10	Instrument cluster	58	Porsche Communication Management (PCM)	36, 50, 67, 72, 124	Rear axle steering	45, 107, 111	Traffic sign recognition	83	
Ambient lighting	Direct Fuel Injection (DFI)	29	Interior	67, 102, 119	<b>N</b>	Porsche Connect	72	Reversing camera	84, 118	Transmission	38	
Apple CarPlay™	Direct Touch Control	24	Interior lighting	63	Navigation	58, 72, 74	Porsche Doppelkupplung (PDK)	38	<b>S</b>	Twin tailpipes	16	
Assistance systems	Drive and chassis	27	Interior packages	103	Night Vision Assist	76, 118	Porsche Dynamic Chassis Control Sport (PDCC Sport)	42, 50, 111	Seat heating and ventilation	60, 117	Twin-scroll turbocharger	30, 35
Audio interface	Driving modes	36, 50	Ionizer	63, 119	<b>O</b>	On-board computer	58	Seats	60, 117	<b>V</b>	VarioCam Plus	29
Audio systems	<b>E</b>	E-Charge mode	36	<b>L</b>	<b>P</b>	Panoramic roof	23, 116	Sound systems	68, 124	<b>W</b>	Wheels	48, 112
Auto Start Stop function	E-Hold mode	36	Lane Change Assist	83, 118	ParkAssist	84, 118	Porsche Dynamic Light System Plus (PDLS Plus)	76, 115	Speed limit indicator	58		
<b>B</b>	E-Power mode	36	Lane Keep Assist	83, 118	Performance display	50	Porsche Dynamic Light System (PDLS)	76, 115	Sport Chrono Package with mode switch	50, 110		
Bose® Surround Sound System	Engines	29	Launch Control	52	Personalization	86	Porsche European Delivery	125, 130	Sport mode	36, 50, 52		
Brakes	Exterior	114	LED headlights with Porsche Dynamic Light System (PDLS)	76, 115	Porsche 4D Chassis Control	42	Porsche InnoDrive	80, 118	Sport Plus mode	36, 52		
Burmester® High-End 3D Surround Sound System							Porsche Rear Seat Entertainment	24, 67, 124				
Car Connect Services												
CD/DVD drive												



**Which side of your brain still needs convincing?**

**Introducing Justify It.**

You've been dreaming about it for years. You've done your research. You've taken test drives. You've even picked up this brochure. Now you just need that extra nudge to help inform and inspire your decision.

We understand that buying a Porsche is as much a rational decision as it is an emotional one. So don't just take our word for it. Visit [porschejustifyit.com](https://www.porschejustifyit.com) and discover a world of owner input, reviews, specs, facts, inspiration, and other content—all designed to arm you with as much justification as you need.

**PORSCHE**

