

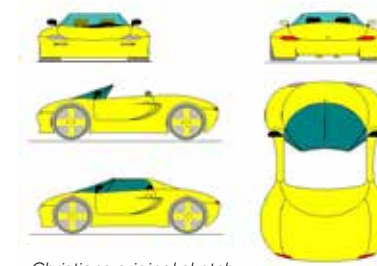

**Koenigsegg**

# Koenigsegg

celebrating 20 years



Christians original sketch

The journey of Koenigsegg is truly incredible. It all started on August 12th 1994 when a young man, aged 22, set out to realize his childhood dream. A young man fuelled by passion, ingenuity and mind-bending will.

Christian von Koenigsegg had just made up his mind to live his dream and start his own car company. The odds were stacked against him. It was a now or never moment.

His idea was to create a sports car that he felt did not currently exist and one which he believed would be desired – two essential necessities for success, Christian felt.

The concept: A lightweight mid-engined car, with a detachable, stowable hardtop. A wrap-around screen for good visibility and aerodynamics. Short overhangs with two large intercooler intakes on the side of the car, behind the mass center to aid high speed stability.

A car that looked and felt good with the top up, as well as in roadster guise, transformed in minutes with the hard top neatly tucked away inside the car. A car with a timeless efficient appearance that ages like good wine.

This was a mid-engine car concept that did not exist at the time. The CC8S was born. Every Koenigsegg created since includes this simple but effective DNA and stay true to Christian's original vision.

It has been an amazing ride. From boyhood dream to a shining, all-conquering and powerful reality. It's awe-inspiring stuff that dreams are made of.

Five production models with as many Guinness production car records later – it is a fact, Koenigsegg has exploded on to the scene and is here to stay.

When Christian is asked what his greatest achievement is – he says without hesitation: -Living the dream!

Just imagine what the next 20 years will hold.

Time for the One:1





## A HANDCRAFTED MASTERPIECE

For those who truly appreciate a masterpiece that perfectly combines technology and design and morph them into the most exhilarating driving experience available. A Koenigsegg is their choice.

Seven stages of production occur over three months at the production facility in Ängelholm. Just a few pairs of hands - belonging to specialized automotive artisans - spend 4500 hours to bring each Koenigsegg to life.

Meticulous attention to detail ensures that over 4000 custom parts come together in a perfect harmony of high tech and classical craftsmanship.



## THE DESIGN

Over the past 20 years Koenigsegg has become an instantly identifiable icon synonymous with style, performance, and exclusivity. The cars honors their predecessors and stays true to Swedish functionalist design.

By strictly adhering to the minimalistic “less is more” philosophy Christian von Koenigsegg ensures that all Koenigsegg’s are purposefully beautiful.

Koenigsegg cars are perfect representation of modern advances in aerodynamics merged seamlessly with contemporary aesthetics.



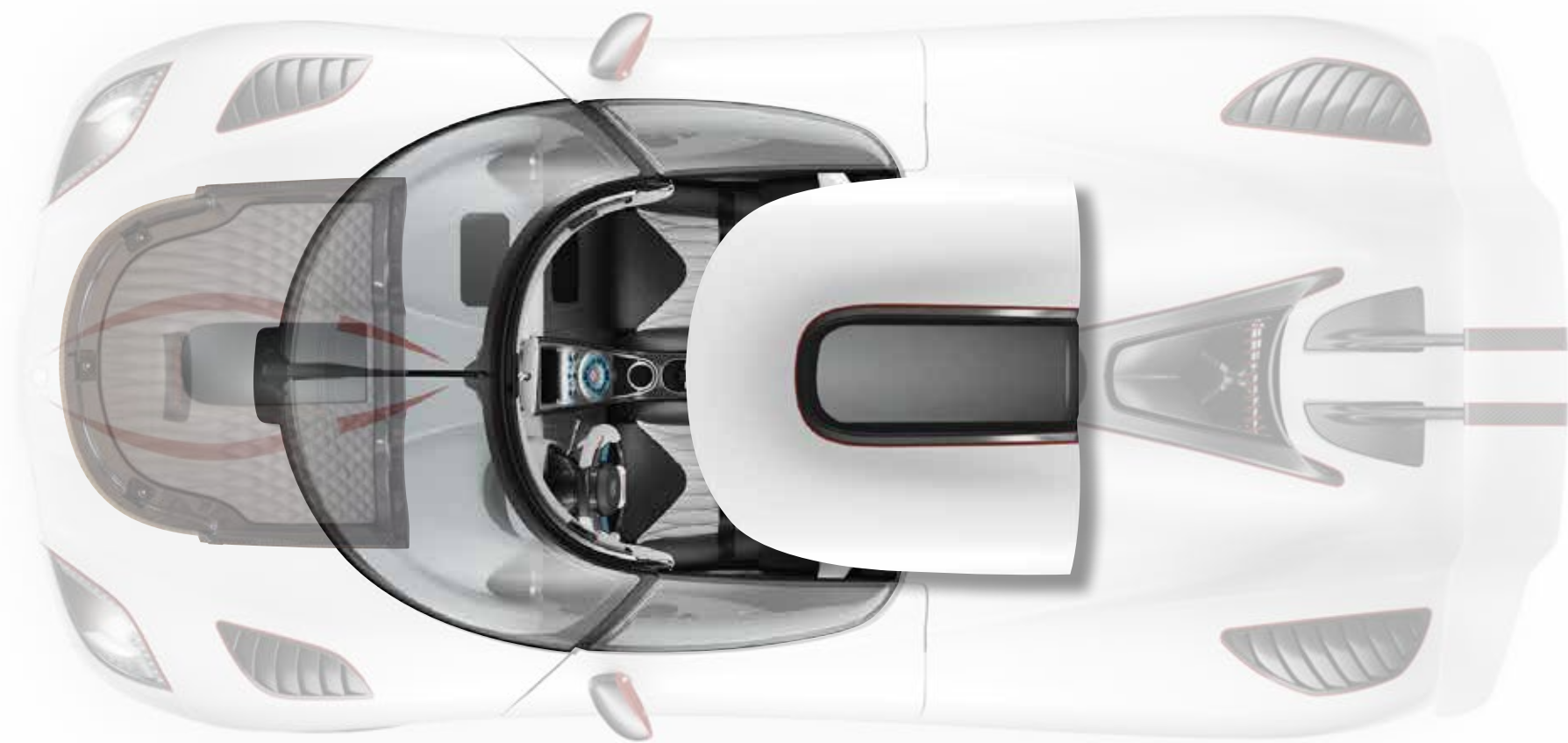

The roof is easily removed and is designed to stow away perfectly in the front luggage compartment. This unique and practical feature sets the Koenigsegg cars apart from all others.

The roof is also equipped with a roof lock warning system to alert the driver if the roof is not securely fastened when the car is in motion.

## PACK YOUR BAGS

A 180 liter (> 6 cubic feet) luggage capacity eclipses every other car in the class. Pack your bags for a week.



*Agera 2012*



## DIHEDRAL SYNCHROHELIX DOORS

The awe-inspiring, elegantly smooth movement of the Dihedral Synchrohelix doors defies convention.

Following Koenigsegg's functional design mantra, this trademark feature has minimal door swing with a more spacious opening.





Photo: Casper Blom

## A HIGHLY SOPHISTICATED MACHINE

Genetically dissimilar from the rest of the automotive world, the Agera truly stands out. Patents and countless bespoke programs, methods, and technologies protect it as a unique masterpiece.

In a world of cross pollination between vehicle manufacturers, Koenigsegg's engineers rebel by developing the Agera's systems internally to preserve technological integrity and superiority.

From the bespoke powerplant to the world's quickest electronic differential, each component is designed and qualified in Ångelholm, Sweden.





**Performance**

Power output using pump gas - 0,809 MW at 7400 rpm - redline at 8000 rpm  
 Power output Agera R (using E85) - 0,900 MW at 7600 rpm - redline at 8300 rpm  
 Torque: over 1000 Nm from 2700 to 6170 rpm  
 Max torque petrol - 1200 Nm at 5300 rpm (1300 Nm @ 5300 rpm – R version using E85)  
 Acceleration: 0-100 km/h (0-62 mph) 2.8 sec (both S and R version)  
 Agera S: 0-200 km/h = 6,8 sec, 0-200-0 km/h = 10,5 sec, 0-300-0 km/h = 21 sec  
 Agera R: (using E85) 0-200 km/h = 6,5 sec, 0-200-0 km/h = 9,85 sec, 0-300-0 km/h = 19,2 sec  
 Braking distance: 100-0 km/h = 29,5m with optional active Aero package  
 Lateral g-force: 1.65 G on Michelin Supersport, 1.8G on optional Michelin Sport Cup 2  
 Active aero and active chassis package gives 1,75 G on Michelin Supersport and 1,9G on optional Michelin Cup 2 tires.  
 Fuel consumption - Highway travel: 12,5 l/100km - Combined: 14,7/100km  
 Weight distribution - 44% front, 56% rear  
 Emission levels - Euro VI and LEV 3

**Aerodynamics**

Cd. 0.33 to 0,37 with adaptable rear wing.  
 Frontal Area: 1.873 m2  
 Total Downforce at 250 km/h - 330 kg  
 Total downforce at 250Km/h with optional active chassis and active aero package - 450Kg

**Dimensions**

Total length: 4293 mm (169")  
 Total width: 1996 mm (78.6")  
 Total height: 1120 mm (44.1")  
 Ground clearance: Rear: 100 mm (3.94") Front: 100 mm (3.94")  
 Wheelbase: 2662 mm.  
 Front track: 1700 mm. Rear track: 1650 mm.  
 Front overhang: 885mm Rear overhang: 752mm  
 Fuel capacity: 82 litres  
 Luggage compartment: 120 litres (31.7 US gallons)  
 Dry weight: 1290 kg  
 Curb weight 1385 kg (all fluids plus 50% fuel)  
 Maximum laden weight: 1650 kg (full tank, two passengers, full luggage)

**Chassis**

Carbon fibre with aluminium honeycomb and integrated fuel tanks for optimal weight distribution and safety.  
 Monocoque torsional rigidity: 65,000 Nm/degree.  
 Weight including tanks: 92 kg.  
 Front and rear suspension - Double wishbones, two-way adjustable gas-hydraulic shock absorbers, pushrod operated Triplex damper in the rear  
 Electronically adjustable ride height  
 Front - Cro-Mo subframe, with integrated crash members  
 Rear - Semi-stressed engine and gearbox with support struts, for needle bearings and o-ringed wishbone bushings optimal rigidity and no engine inertia movements  
 Fully machined aerospace grade uprights, with LeMans specification 150mm angle contact ball bearings  
 Hollow/gun-drilled driveshafts  
 Koenigsegg Z-style progressive and lightweight anti-roll bars front and rear  
 Optional Koenigsegg active and selfleveling chassis including selfsteering rear chassis

**Engine**

Koenigsegg aluminum 5.0L V8, 4 valves per cylinder, double overhead camshafts with optional Flexfuel capability  
 Compression: 9.0:1  
 Bore: 92 mm Stroke: 95 mm  
 Sequential, multipoint fuel injection  
 Twin ceramic ball bearing turbo chargers with Koenigsegg patented back pressure reduction system.  
 1.4 bar (1.6 with E85) boost pressure.  
 Dry sump lubrication  
 Carbon fibre intake manifold with optimised intake tracts  
 Tig-welded ceramic coated 0.8 mm wall thickness inconel exhaust system manifold with merge collector  
 Total engine weight: 197 kg

**Engine Management**

Koenigsegg Engine Control Module with full OBD II and Flexfuel capacity ( KECM )  
 High Power coil on plug ignition system

**Transmission**

Specially developed 7-speed dual clutch, 1 input shaft transmission with paddle-shift  
 Koenigsegg Electronic Differential - KED  
 Koenigsegg Gearbox Control Module - KGCM

**Steering**

Rack and pinion power assisted steering. 2.7 turns lock-to-lock  
 Turning circle: 11 metres

**Brakes**

Front brakes - Ventilated ceramic discs Ø 397 mm, 40 mm wide 6-piston Koenigsegg calipers with ceramic pistons. Power-assisted  
 Rear brakes - Ventilated ceramic discs Ø 380 mm, 34 mm wide 4-piston Koenigsegg calipers  
 Power-assisted

**Traction Control**

F1-style for optimal performance with 3 different handling modes

**Electronic Stability System**

KES – Koenigsegg Electronic Stability Control with 3 different handling modes

**Wheels**

Koenigsegg Aircore™ Super light carbon fibre wheels with centre locking  
 Front: 19" x 9.5"  
 Rear: 20" x 12.5"

**Tires**

Dedicated Michelin Supersport  
 Unidirectional with asymmetric thread pattern  
 Front: 265/35 – 19" (Y)  
 Rear: 345/30 – 20" (Y)  
 Speed rating: 415 km/h  
 Optional dedicated Michelin Pilot Sport Cup2 – Speed Rating: 440 km/h

**Body**

Two-door, two seater with removable hardtop stowable under the front hood  
 Body made from pre-impregnated carbonfibre/kevlar and lightweight sandwich reinforcements  
 Carbon vents over wheels

**Electrical System**

Solid state digital semi-conductors, minamizing need for physical fuses or relays  
 Can bus operated and fully programmable functionality

**Equipment**

Dual airbags, detachable storable hardtop with glass roof, power windows, adaptive rear wing, adjustable pedals and steering column, Agera stitching, adjustable seats in rake and length, carbon ceramic brakes with Sport ABS, KES, hydraulic lifting system, power steering, power brakes, Satnav, Intelligent LifePo4 battery, MP3 player, USB connection, climate control, digital warning and info system, G sensor, alarm, tire monitoring system, Koenigsegg shield alarm fob with integrated USB stick, leather carpets, roof storage bag, car cover, Inconel exhaust system, front winglets, aero exhaust, Aircore Carbon fiber Wheels

**Options**

Partial clear carbon body  
 Full clear carbon body  
 Matte exterior paint  
 Two color body  
 Complete custom interior leather and exterior paint scheme  
 1 MW power upgrade  
 Koenigsegg variable turbo geometry  
 KAA - Koenigsegg active aerodynamics  
 KADAC - Koenigsegg active dampers and chassis  
 KASS - Koenigsegg anti sound seats  
 One piece carbon racing bucket seats - with memory foam  
 Sabelt 6 point racing harness  
 Color seat belts  
 Track biased fixed roof and vented front hood package  
 Rear view camera  
 Rear parking sensors  
 Lightweight titanium exhaust outlet  
 Fitted luggage  
 Custom color brake calipers  
 Personalized logo on sides of rear bonnet  
 Black anodized interior trimming  
 Custom diamond encrusted Koenigsegg sheild remote fob  
 Colormatched 300 liter aero carbon soft lined roof box  
 Premium Tärnsjö analin leather interior  
 Upgraded sound system  
 Winter wheel package, including tires and wheels  
 3G connectivity  
 Predictive active track setup  
 2 years extended warranty

**Warranty**

3 Year mechanical warranty

Vents over the wheel arches reduce drag and increase downforce.

Panoramic windshield.

Dynamically movable wing - changes rake depending on air pressure and speed.



Cut out in splitter to ensure the airflow reaches the rear diffusor during braking.

Front splitter promoting constant down force.

Aircore™ carbon fiber wheels. An industry first. Reduces unsprung mass and increase performance. The worlds lightest and strongest road car wheels.

Large side intakes ensure that the pressure point of the car is behind the mass center. This adds directional stability with increasing speed and massive airflow to the inter coolers and oil coolers.

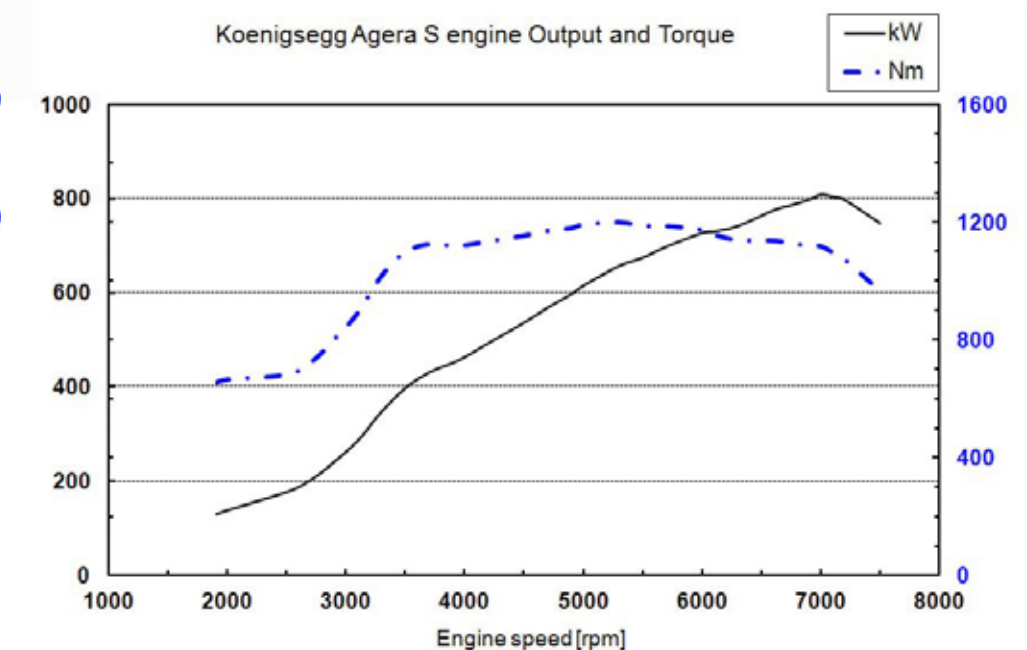
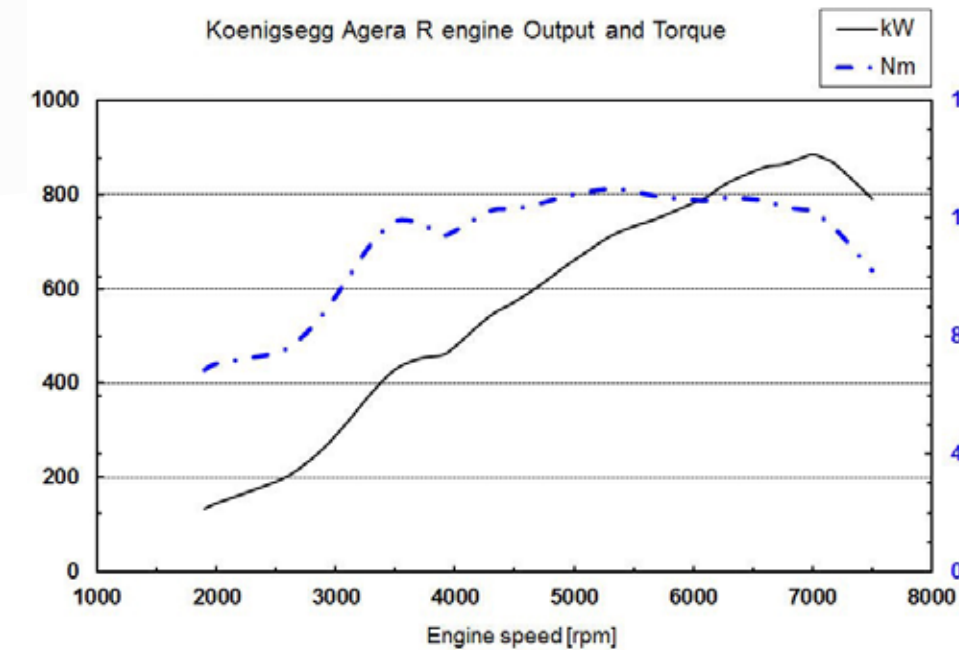



## UNIQUE

Koenigseggs cars are truly unique in every aspect. Virtually every part in the car is custom designed, made by and for Koenigsegg. There are good reasons for all this uniqueness. It is the only way to create a superior performance experience as all parts work together.

The unique Agera R piston for example is just as extreme as everything else in the car. It is both anti friction and ceramic coated. It can take cylinder pressure up to 35 bar Bmep, yet only weighs 276 grams. Truly extreme. Truly unique.

## POWERTRAIN

Koenigsegg is the only limited volume manufacturer to develop its entire powertrain in-house, even with bespoke casting and moving parts.

Koenigsegg's heart is a bi-turbo DOHC 8 cylinder engine producing up to 1 MW. A symphony of innovative technology transfers the power to the road, yielding the world's fastest accelerating production car.

The colossal power and earth moving torque is unmatched and holds several world records.

Koenigsegg's highly qualified engineering team relentlessly developed the engine for power, drivability, and longevity.

Each engine is hand assembled in Ångelholm by a master engine builder to ensure exact tolerances and unprecedented quality.

The engine package is the lightest, most compact performance engine in the world. Complete with clutch, flywheel, dry sump system, and Inconel manifold system (with turbos) it weighs less than 200 kg (440 lbs).

The class leading fuel consumption of around 20 mpg and 80 litres (21 gallons) fuel tank provide excellent range.

Large air-to-air intercoolers keep the engine cool even during extended performance driving, and by eliminating the need for water in the intercooling system, saving a significant amount of weight.

Koenigsegg's patented variable turbo geometry and response/backpressure reduction system provides instantaneous response and seamless power.

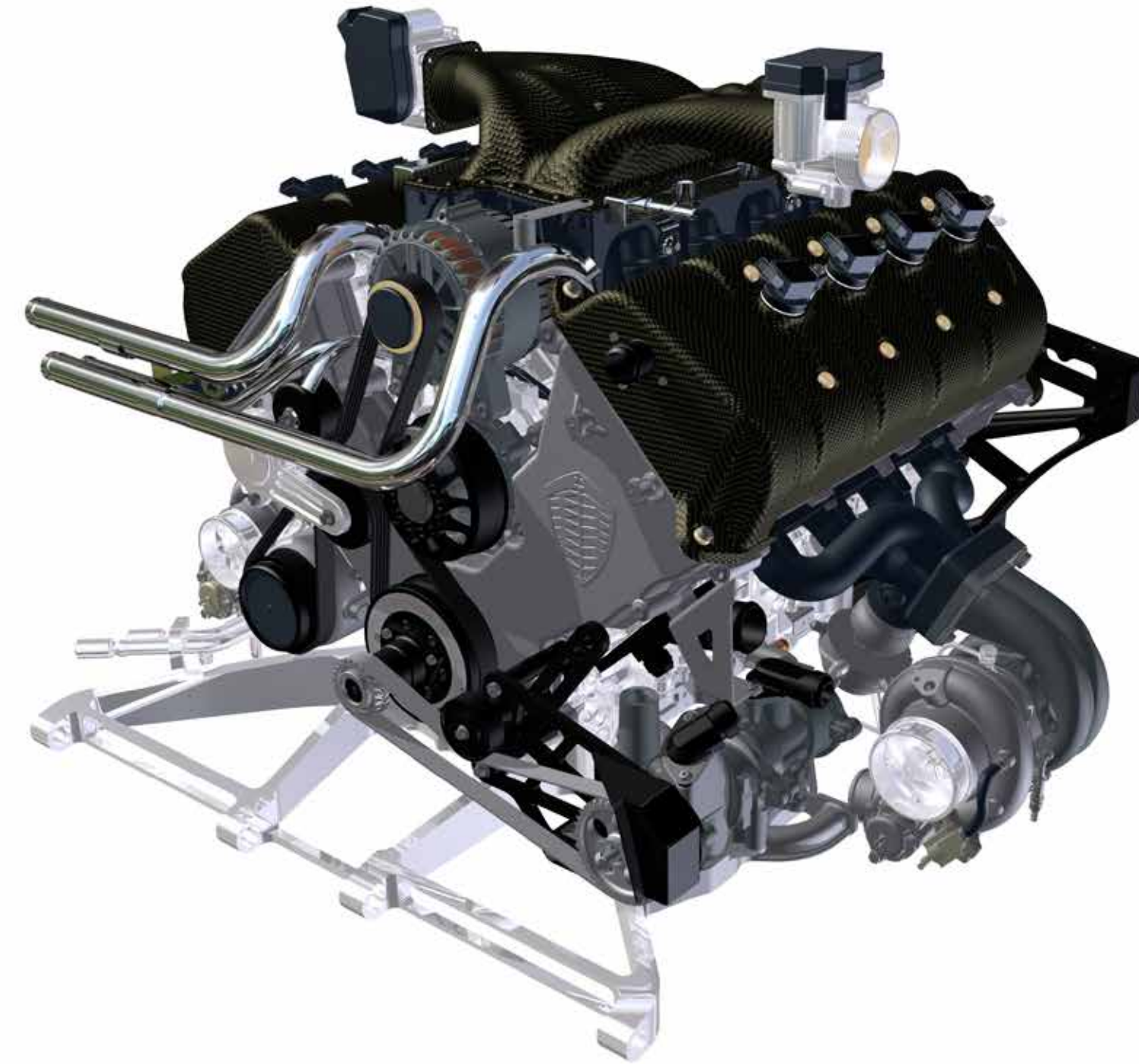

The Beauty and detailing of the engine bay compares favourably to Basilica di San Pietro

## TRANSMISSION

While providing extremely fast and smooth shifts, the 7-speed paddleshift gearbox is lighter and more compact than any other comparable transmission – weighing a mere 81 kg. It uses Formula 1 spec materials for both gears and shafts in order to cope with over 1300 Nm of torque and has carbon fiber synchros.

## WET CLUTCH SYSTEM

The transmission features the world's first dual clutch system designed for a single input shaft gearbox.

During each upshift a hydraulic wet clutch inside the gearbox is engaged to slow down the input shaft. This pre-synchronization cuts the shift time by two thirds. Despite its immense capabilities, this sophisticated system can seamlessly change from fully automatic mode to paddleshift AMT at a push of a button.

## ELECTRONIC DIFFERENTIAL

Koenigsegg's E-Differential is an industry first. It combines a traditional limited slip differential with a revolutionary, active digital system to minimize both weight and reaction time.

The digital system is programmed with algorithms, designed by Koenigsegg, to analyze multiple inputs including throttle angle, g-force, steering wheel angle, car speed, yaw angle, engine rpm, selected gear, and weather conditions to command the E-Diff.

The transmission is excellent

- Auto Motor Sport

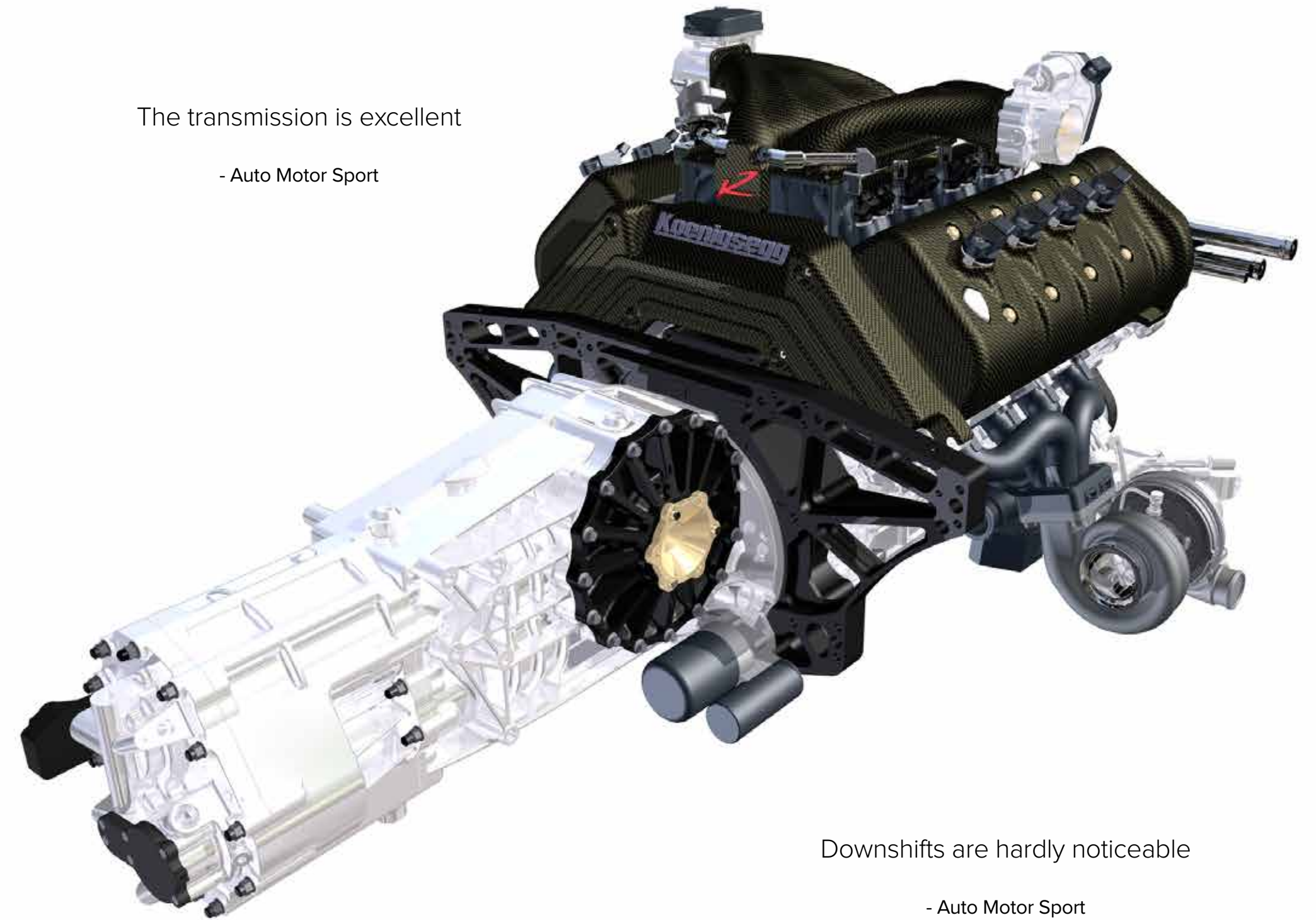

Downshifts are hardly noticeable

- Auto Motor Sport

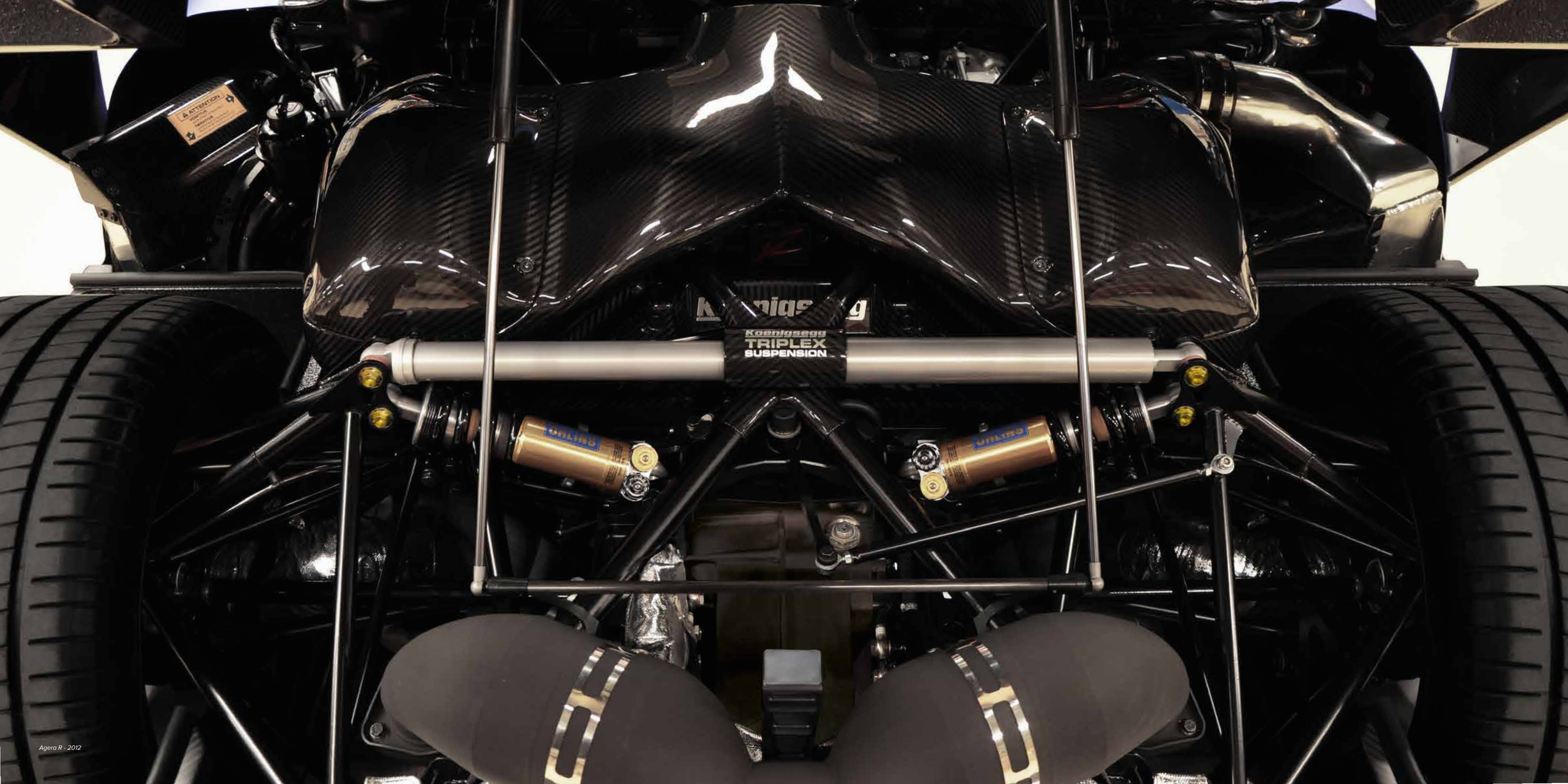

ATTENTION  
PROHIBIT  
REACTIVE

Koenigsegg

TRIPLEX  
SUSPENSION

UNLTD

UNLTD



Agera R 2012 - Photo: Dennis Notén



Agera 2013 - Photo: Pieter Kiveron



The Koenigsegg crest design is based on the Koenigsegg family coat of arms from the 12th century.





“The wealth of information coming from engine, steering and chassis makes you feel like you’re right at the mechanical heart of the car and better able to read what’s going on”

- EVO Magazine



## CI-CONFIGURABLE INSTRUMENTS

The configurable dash enables various display layouts designed to meet the driver's specific demands.

Track driving mode prioritizes RPM, pressures, temperatures, lap times, and g-forces. GT driving mode focuses on speed, satellite navigation, and music.

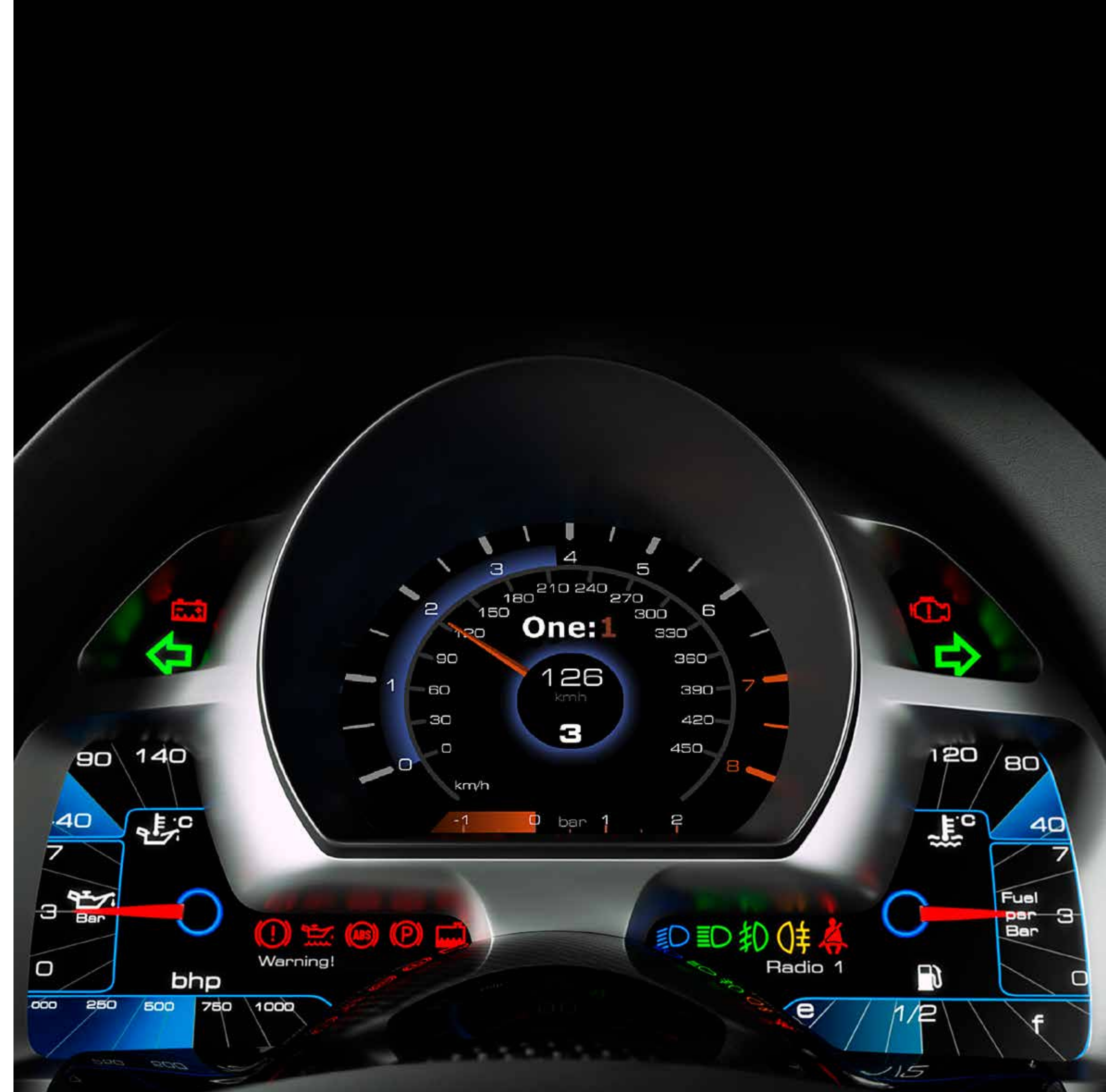



## TRANSFORMER

Only four panels are permanently affixed to the car: the front/rear bumper and the left/right door sills.

The extensive amount of movable surfaces transform the car and give great access to all areas.



Photo: Oskar Bekke

## THE COCKPIT

Koenigsegg's interior is like no other.

Innovative technology such as the multifunctional infotainment system and configurable instruments provide unsurpassed functionality. The uniquely designed steering wheel and seats are prime examples of Swedish ergonomics; they are the perfect combination of comfort and support. Only the finest materials are deemed worthy for use in Koenigsegg's interiors. Everything between the headliner and carpet is adorned in either carbon fiber, precious metals, alcantara, billet aluminum, or aniline leather.

Koenigsegg relentlessly pursue the ultimate in performance. This applies to the interiors as much as it does to the engines, aerodynamics or suspension systems.

The interior design follows Koenigsegg's less-is-more philosophy. Everything serves a functional purpose; there is no distracting visual drama. At Koenigsegg, this is the essence of beauty.



## COMMAND CENTER

The 7 inch high-definition touch screen is a hub for all vehicle information and the command center for controlling all elements of the vehicle. From accessing your phonebook via Bluetooth and playing your favorite song to changing drive mode and tracking your performance – it's all there.

While featuring auto-adapt functionality, the traction control system also allows manual settings for racetrack performance.





## HANDS-ON CONTROL

Gripping the all carbon steering wheel puts world record performance in your hands. The flat-bottom design incorporates vital functions and raised thumb rests.

Paddle shifters are mounted directly on the back of the steering wheel enabling shifting without taking your hands off the steering wheel while cornering.

The driver has direct access to primary functions and is illuminated by way of Ghost Light.

The entire steering wheel and dash telescopes in unison in order to ensure clear visibility of instrumentation and forward vision.

## GHOST LIGHT

Another unique feature is the Koenigsegg Ghost Light solution.

The Ghost Light is a world's first in the car industry. The LED illumination shines through the billet aluminum buttons and surfaces out of nowhere, by way of almost invisible micro holes. It creates excellent visibility of the symbols as well as being very clean and stylish.





Koenigsegg

## AIRCORE™ CARBON FIBER WHEELS

The world's lightest and strongest wheels - developed and produced by Koenigsegg. What makes this wheel truly unique is that the spokes and centre parts are completely hollow and made out of carbon, in one piece, together with the rest of the wheel. The 19" front wheel weighs only 5950 grams and the 20" rear wheel a mere 6572 grams, making them the lightest production car wheels for their size in the world.

250 Nm

OFF

ON

250 Nm





## Guinness World Records

0 - 300 - 0 km/h World Record (21,19 sec)  
**Koenigsegg Agera R, 2011**

The Fastest Production Car  
**CCR, Nardo Prototipo, Italy, 2005**

World's Most Powerful Production Car  
**CCR - 2005**

Most powerful production car  
**CC8S, 2002**

## Other Records and Awards

Plastovationer - New thinking and innovation  
in the polymer field  
**Revolutionary Aircore Hollow Carbon Wheel, 2013**

Top 100 Brand  
**World Luxury Association confirm the world's most  
valuable luxury brands, 2012**

0 - 200 - 0 mph World Record (24,96 sec)  
**Koenigsegg Agera R, 2011**

0 - 300 km/h World Record (14,53 sec)  
**Koenigsegg Agera R, 2011**

0 - 200 mph World Record (17,68sec)  
**Koenigsegg Agera R, 2011**

300 - 0 km/h World Record (6,66 sec)  
**Koenigsegg Agera R, 2011**

200 - 0 mph World Record (7,28 sec)  
**Koenigsegg Agera R, 2011**

GTspirit Hypercar of the Year  
**Koenigsegg Agera R, 2011**

Top Gear Hypercar of The Year Award,  
**2010 Koenigsegg Agera, 2010**

Entrepreneur of The Year Award  
**Christian von Koenigsegg, 2005**

The Red Dot Design Award  
**By the Design Zentrum of Nordrhein - Westfalen, 2001**





## DYNAMIC REAR WING SYSTEM

The lightweight Dynamic Rear Wing adjusts its angle of attack with actual wind pressure. It compensates for headwind or tailwind making it naturally reactive.

The dual carbon fiber pylons act as engine heat channels. Hot engine bay air rushes past the pylons causing a Venturi effect which increases the flow of cool air through the side intercoolers.

## REAR DIFFUSER

The rear diffuser is specifically developed and evaluated to provide substantial allround down force even at wide yaw angles.

## SUSPENSION

The suspension combines proven Koenigsegg geometry and innovative advances in suspension technology. It features F1 style wishbones, uprights, record setting brakes, and industry leading active control systems.

The Koenigsegg exclusive triplex rear suspension further enhances body control and agility. A truly unique system envisioned by Christian von Koenigsegg.

## WISHBONES

The wishbones are inspired by F1 design and are the longest of all production performance cars. While allowing for less track width deviation during wheel movement and cornering, they improve geometry over a longer wheel stroke. Minimizing weight and maximizing stiffness and strength by utilizing aeronautical chromium molybdenum tubing.





## KOENIGSEGG PRE OWNED CERTIFICATION PROGRAM

The program is designed and structured to offer warranty and a level of service close to what is offered on a new Koenigsegg vehicle.

The Koenigsegg Pre Owned Certification Program is exclusively offered by official Koenigsegg representatives.

The pre-owned program offers up to 2 years factory warranty and free service and is only available for vehicles purchased from an official Koenigsegg representative.



Agera



CCX



CCR



CC8S



**One:1**  
MW

# One:1<sub>MW</sub>

## WORLD'S FIRST MEGACAR

Koenigsegg is creating a limited series uniquely developed and designed production cars - the One:1 program. This is one of the most exclusive production car programs ever envisaged.

The hp to kg curb weight ratio is an astonishing 1:1. This is the "dream" equation previously thought impossible. On top of this, the One:1 is the first homologated production car in the world with one Megawatt of power, thereby making it the world's first series produced Megacar.

These are the reasons for naming the car One:1.

The 2014 One:1 truly raises the bar of performance.

The One:1 features new and unique solutions to enhance track performance without compromising top speed or everyday usability, with a stunning visual appearance to go with it.

Examples of features; unique track optimized aero winglets, extended venturi tunnels and side splitters, Le-Mans inspired active wing configuration and optimized active undertrim air management. Large air vents for improved cooling, roof air scoop to support the 1 Megawatt of power, 8250 RPM rev limit, complemented with Custom made Michelin Cup Tires, upgraded rear triplex suspension with carbon bevel springs and active shock absorbers and ride height, combined with upgraded revolutionary Koenigsegg Aircore carbon fiber wheels.

Koenigsegg was the first extreme car manufacturer to take steps toward green technology with the release of the biofuel CCXR in 2007. The One:1, a sibling of the highly competitive Agera R, follows in the footsteps of the CCXR as it also runs on E85 biofuel, Race fuel or normal gasoline.

In order to give the One:1 maximum flexibility when it comes to power delivery, Koenigsegg has implemented its patented variable turbo geometry technology in the One:1 program. This technology gives improved response and more low-end torque than otherwise possible. As an example the One:1 engine has over 1000 Nm of torque between 3000 to 7500 rpm, which is truly unheard of.

The Koenigsegg One:1 is here.

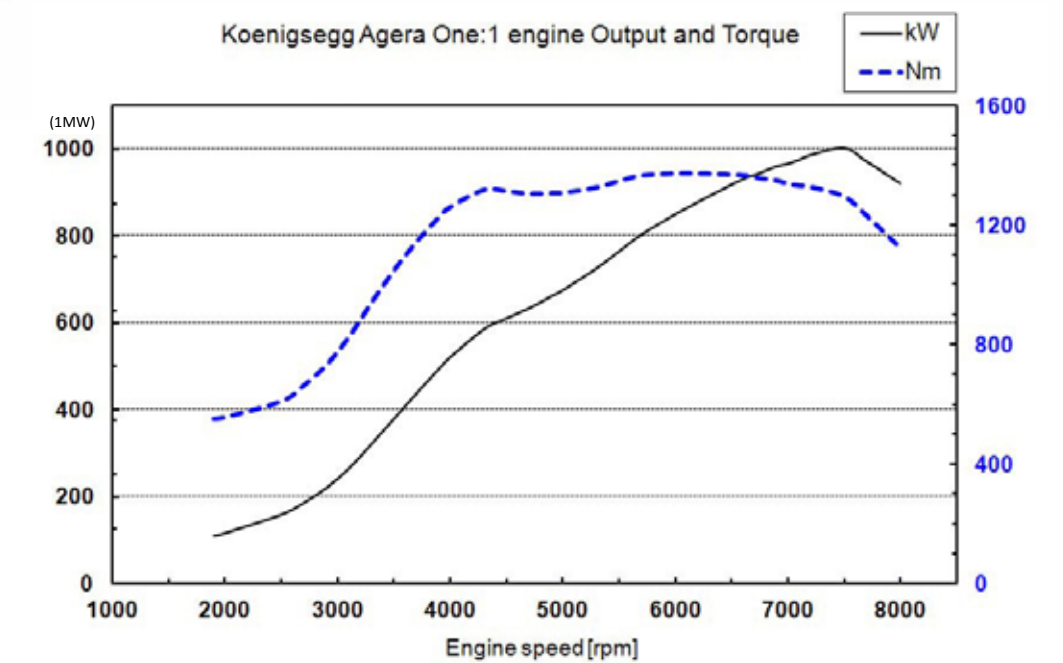

Illustrations and information includes various options.

**Performance**

Power output: 1 MW at 7500 rpm - rpm limiter @ 8250 rpm  
 Torque: over 1000 Nm from 3000 to 8000 rpm  
 Max torque: 1371 Nm at 6000 rpm  
 0 - 400 km/h approx. 20 sec  
 400 - 0 km/h approx. 10 sec  
 Braking distance: 28 m (100-0 km/h)  
 Max lateral g-force: 2.0 g  
 Emission levels: Euro VI

**Aerodynamics**

Cd 0.45-0.50 with adaptable rear wings  
 Frontal Area: 1.910 m<sup>2</sup>  
 Total Downforce at 260km/h: 610kg at 440km/h: 830kg  
 Flat underside of chassis. Venturi tunnels at front & rear of chassis/body  
 Active aero front and rear underside  
 Active triplex suspension  
 Maximized intercooler flow

**Dimensions**

Total length: 4500 mm  
 Total width: 2060 mm  
 Total height: 1150 mm  
 Ground clearance: Rear: 74-90 mm Front: 59-100 mm plus 50 mm lift system  
 Wheelbase: 2662 mm.  
 Front track: 1700 mm. Rear track: 1650 mm.  
 Front overhang: 944 mm Rear overhang: 900 mm  
 Fuel capacity: 74 litres  
 Curb weight 1360 kg (complete car ready to drive with 50% fuel, 100% fluids)  
 Weight distribution: 44% front, 56% rear

**Transmission**

Specially developed 7-speed dual clutch, 1 input shaft transmission with paddle-shift.  
 Electronic differential.

**Chassis**

Advanced high modulus carbon fibre chassis with F1 style honeycomb core and integrated fuel tanks for optimal weight distribution and safety. Monocoque torsional rigidity: 65,000 Nm/degree.  
 Weight: 72kg.  
 Double wishbones, active ride height control and bevel carbon fibre springs with variable spring ratio.  
 Triplex damper in the rear.  
 Needle bearings and o-ringed wishbone bushings.  
 Fully machined aerospace grade aluminium uprights with SKF LeMans specification 150mm angle contact ball bearings.  
 GKN hollow/gun-drilled driveshafts.  
 Koenigsegg Z-style progressive and lightweight anti-roll bars front and rear.

**Engine**

Koenigsegg aluminum 5.0L V8, 4 valves per cylinder, double overhead camshafts with flex-fuel capability.  
 Compression: 9.0:1  
 Bore: 92 mm Stroke: 95.25 mm  
 Sequential, multipoint fuel injection.  
 Variable geometry twin turbo chargers.  
 1.8 bar boost pressure.  
 Dry sump lubrication.  
 Carbon fibre intake manifold with optimized intake tracts.  
 Tig-welded ceramic coated Inconel exhaust system manifold with merge collector.  
 Weight: 197 kg

**Brakes**

Front brakes: Ventilated ceramic discs Ø 397 mm, 40 mm wide.  
 6 ceramic piston calipers.  
 Rear brakes: Ventilated ceramic discs Ø 380 mm, 34 mm wide.  
 4-piston calipers.  
 Traction Control.  
 F1-style for optimal performance with 5 different handling modes.

**Steering**

Rack and pinion power assisted steering. 2.7 turns lock-to-lock.  
 Turning circle: 11 metres. Electro-hydraulic power-assisted.

**Wheels**

Koenigsegg Aicore™ carbon wheels with centre locking.  
 Front: 19" x 9.5"  
 Rear: 20" x 12.5"

**Tires**

Specially developed Michelin Cup 2 tires.  
 Front: 265/35 – 19" (Y)  
 Rear: 345/30 – 20" (Y)  
 Speed rating: 440 km/h

**Body**

Two-door, two-seater with fixed roof. Body made from pre-impregnated carbon fibre/ kevlar and lightweight sandwich reinforcements.

**Electrical System**

Unique Koenigsegg developed electronic control systems including: body, engine, transmission, traction and stability control and power management. Solid state digital semiconductors - minimizing need for physical fuses or relays. CAN bus operated and fully programmable functionality.

**Equipment**

Lightweight glass system, power windows, adjustable pedals and steering column, One:1 stitching, adjustable light weight race seats, carbon ceramic brakes, Sport ABS, ESC, active ride height, power steering, power brakes, 6 point racing seatbelts, intelligent LifePo4 battery, USB connection, climate control, digital warning and info system, G sensor, alarm, tyre monitoring system, proximity key, car cover, rear view camera.

**Optional Extras**

One piece racing bucket seats, active shock absorber settings, full clear carbon body, custom body striping, upgraded audio system, painted calipers, personalized logo on rear hood, anodized black aluminium interior, custom leather One:1 custom luggage set, custom diamond encrusted key, titanium exhaust outlet, active noise cancellation, 3G telematics system, variable turbo geometry.

**3 Year Warranty**

# One:1

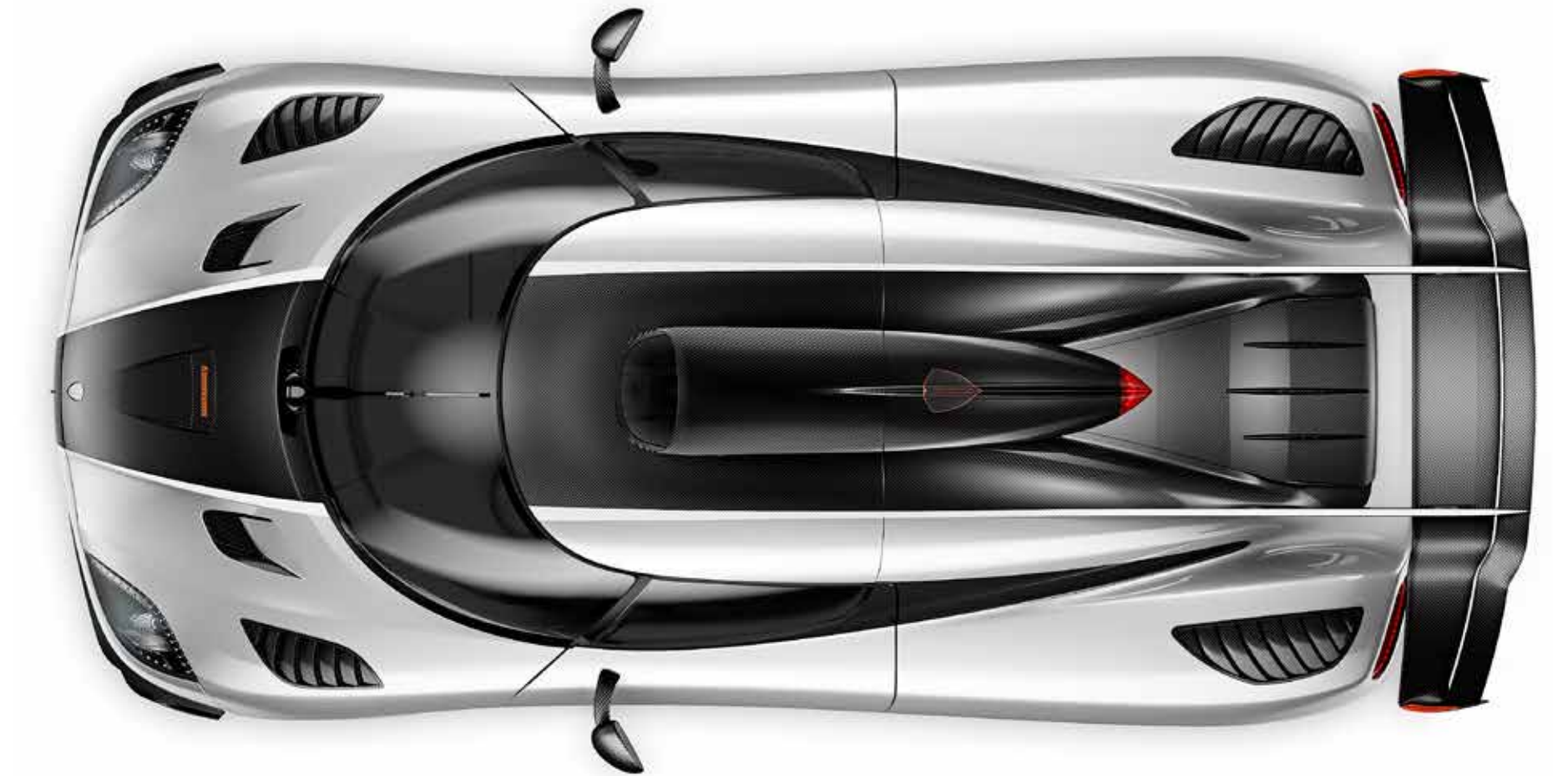

*All information correct at time of printing, and subject to change.*





*Illustrations and information includes various options.*

# One:1

## AERODYNAMIC DEVELOPMENT

### Topside Development

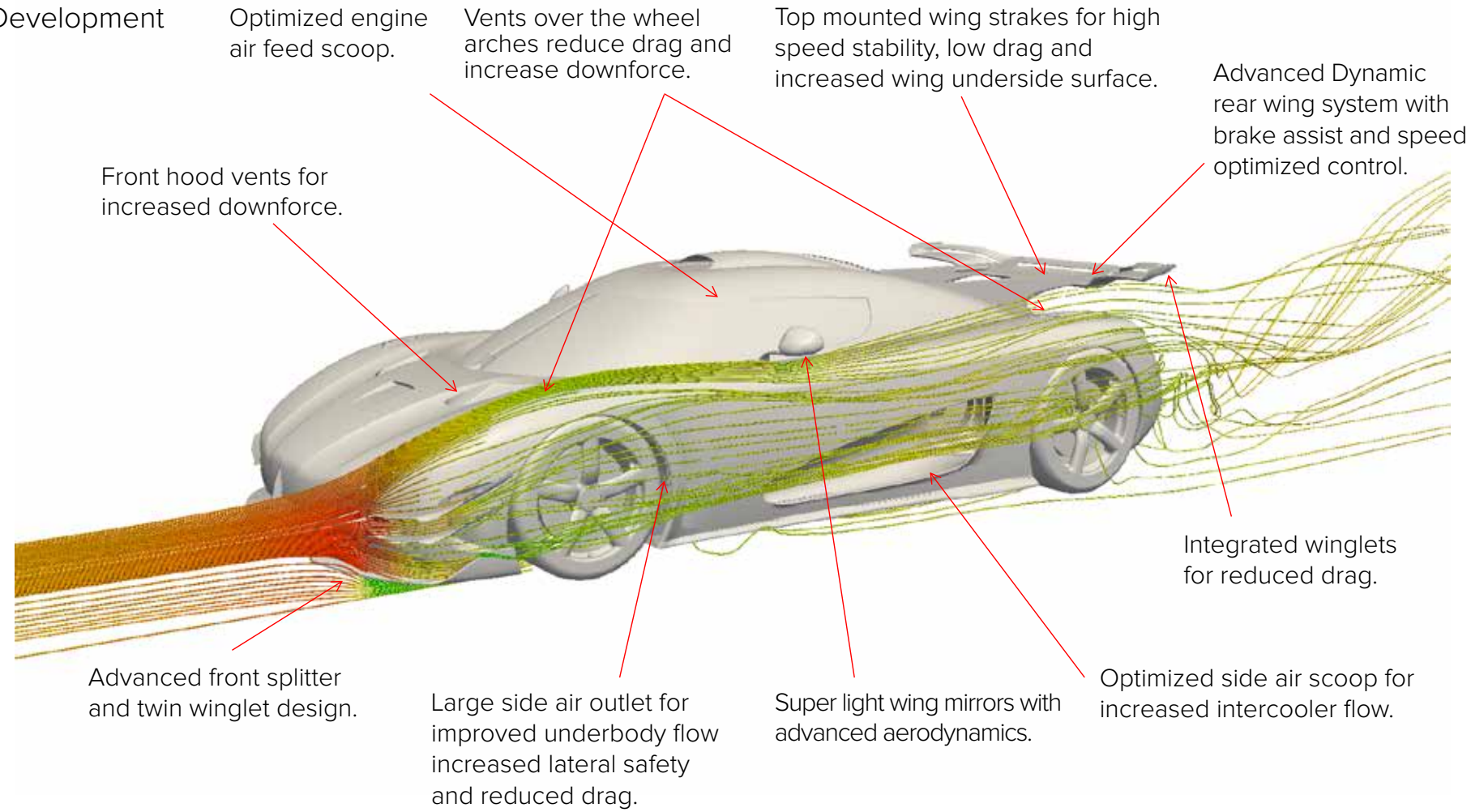

### Ground Effect Development:

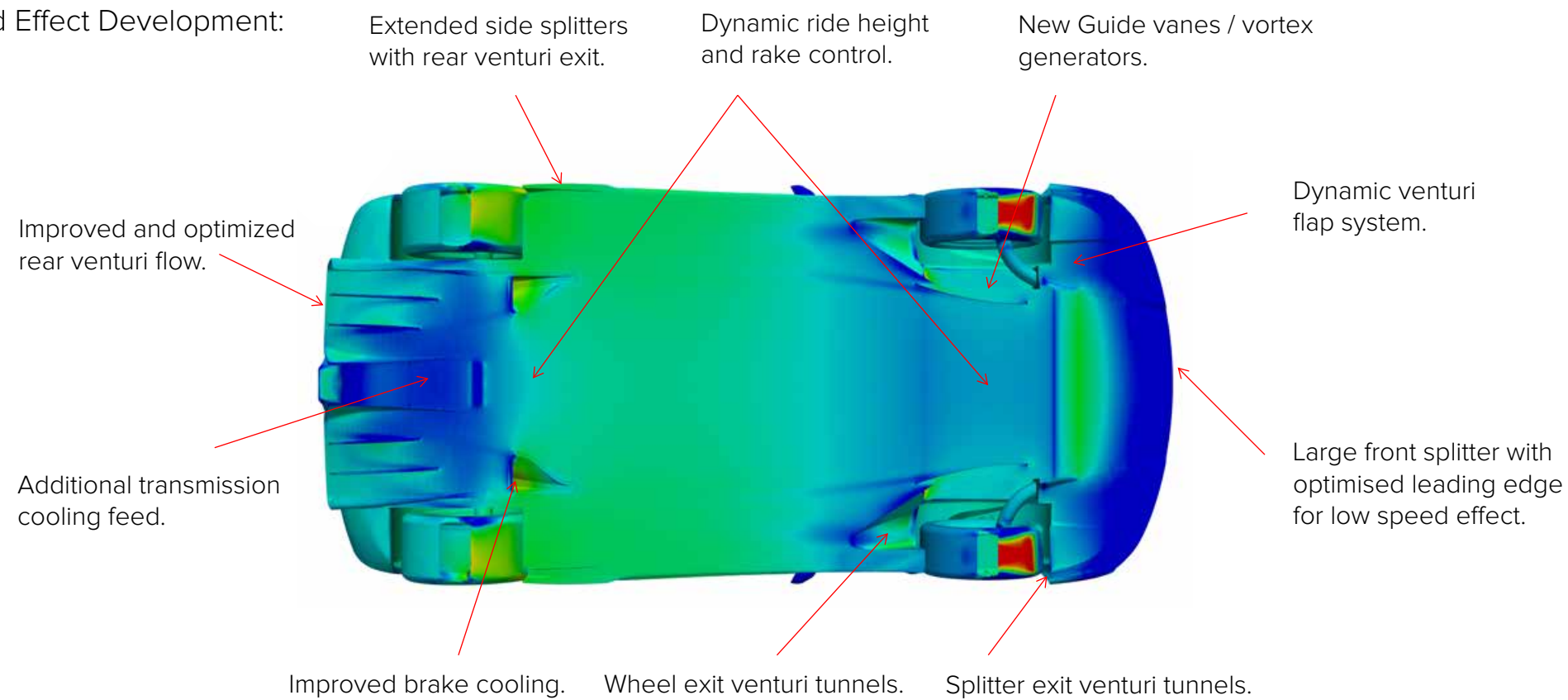

### Dynamic front venturi flap

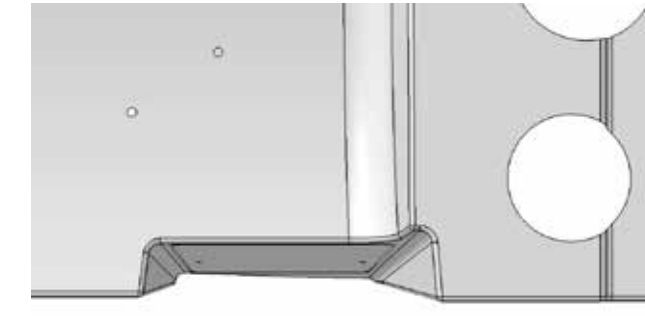
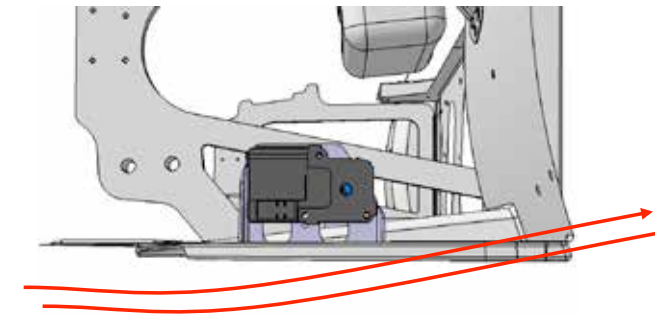

At speeds up to 250 km/h, the flap is retracted, allowing the venturi to generate increased ground effect downforce at the front of the underbody.

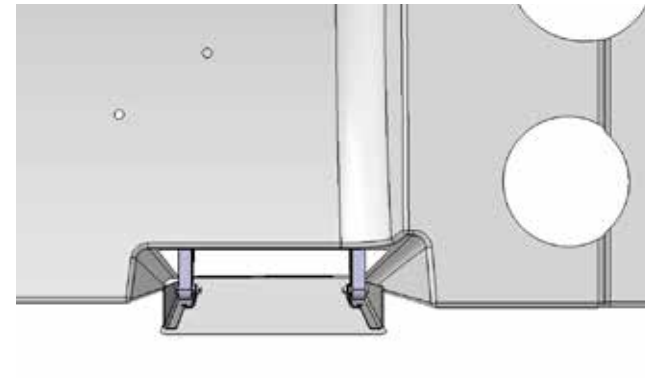
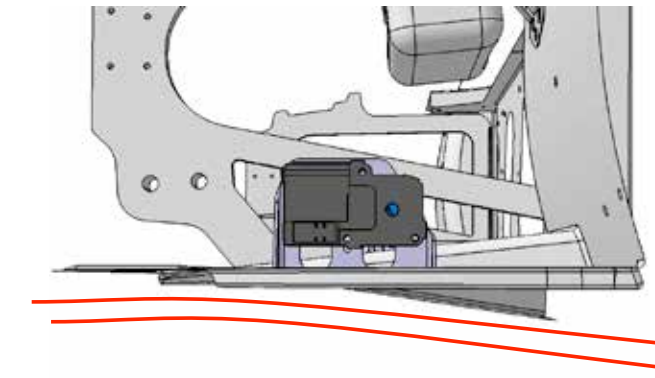

At speeds above 250 km/h, the flap is extended, closing the venturi, which reduces the further escalation of downforce at top speeds.

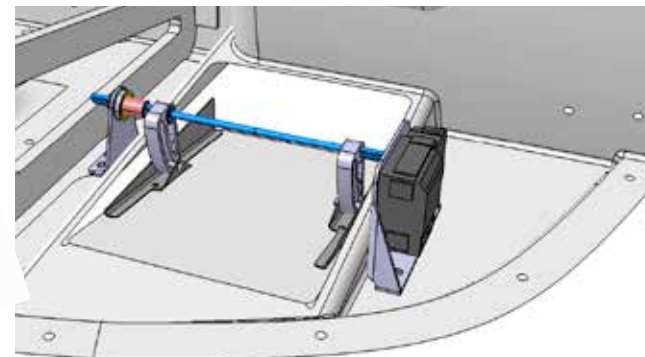
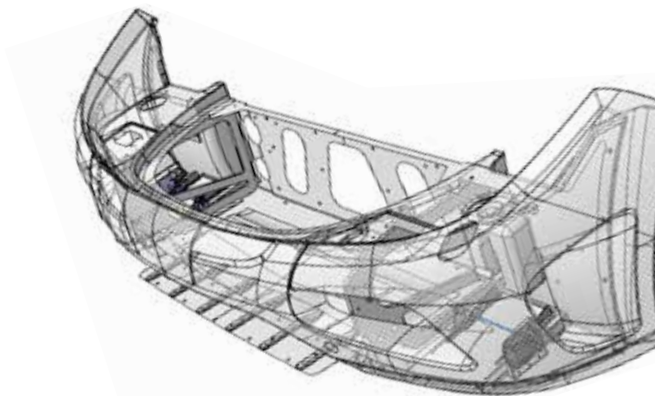

The dynamic venturi flaps utilize a unique flex carbon "hingeless" concept eliminating the need for mechanical hinges. Dual motorized cam systems actuate the active surfaces when commanded by the on-board aero computer system.

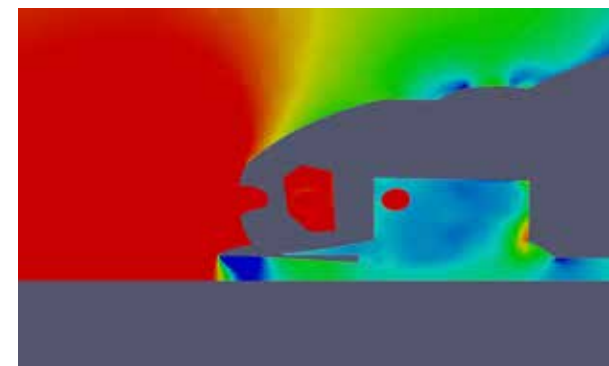

At speeds up to 250 km/h, the flap is retracted, allowing the venturi to generate increased ground effect downforce along the underbody.

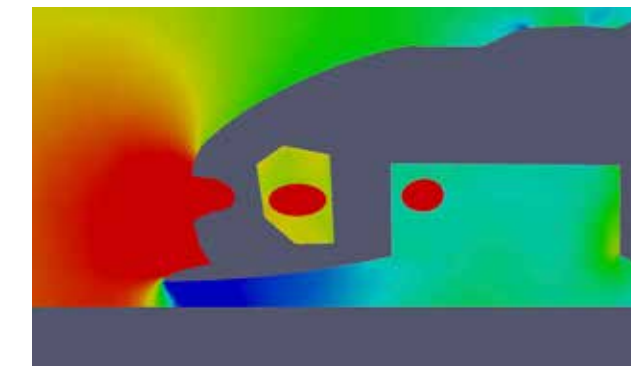

At speeds above 250 km/h, the flap is extended, closing the venturi, which reduces the further escalation of downforce at elevated speeds.

Dynamic rear wing system

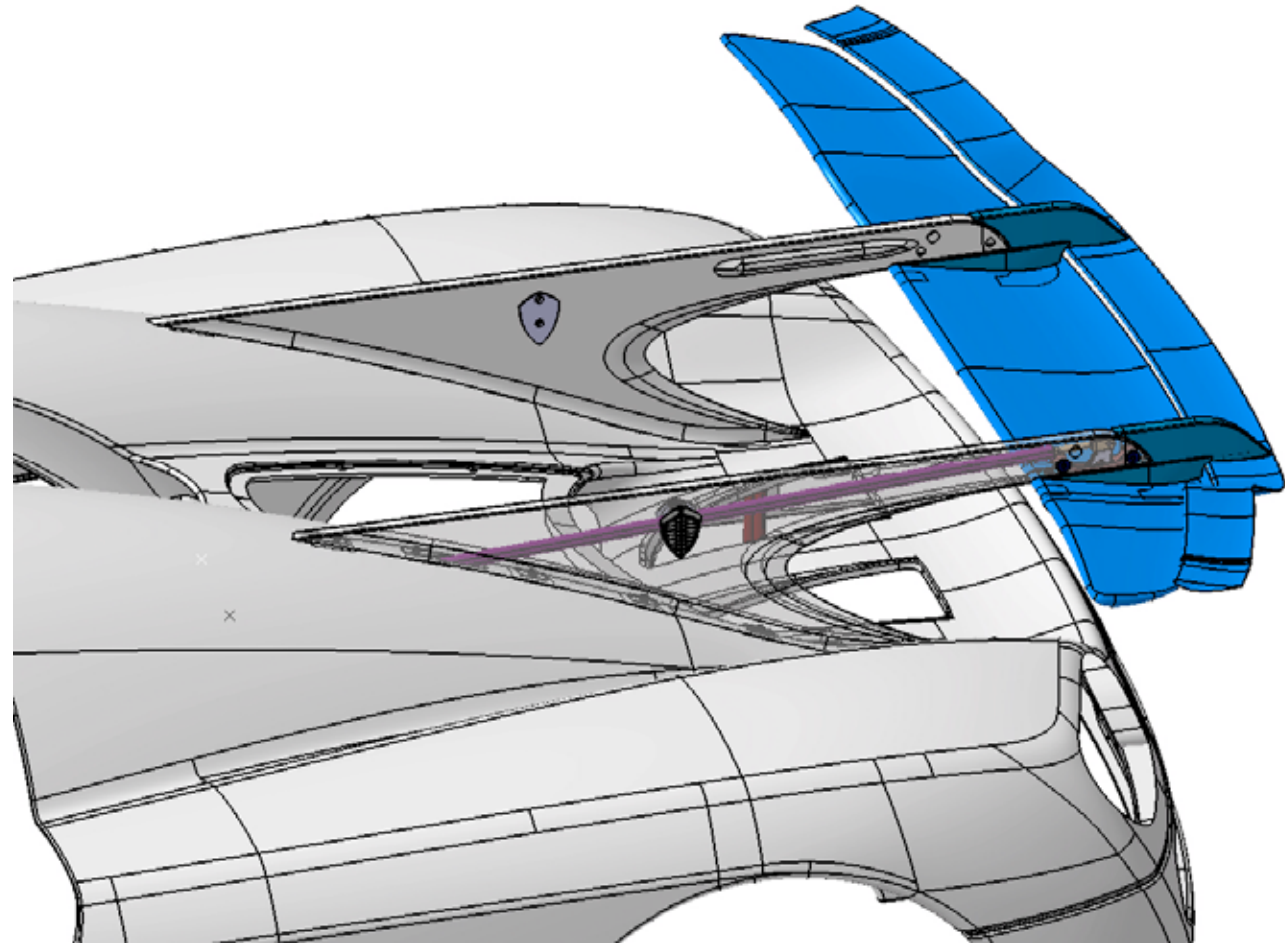

The electronically controlled & hydraulically actuated rear wing auto adjusts from high downforce, to minimum drag in real time, depending on vehicle speed and g-force. Extreme braking effect is also generated by wing brake deployment. The whole wing assembly including hydraulic units only weigh 9 kg, which by far is the lightest active wing system available.

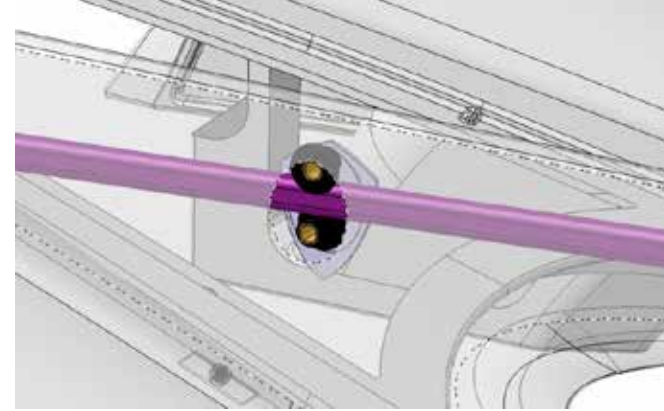

A specially developed carbon pushrod system with low frequency dampers is used to control the wing assy. This allows the hydraulics to be placed closer to the vehicles C of G.

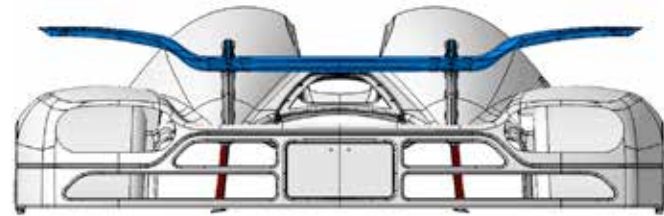

Top wing mounting system to optimize under wing performance. The wing does not need to fold down as it is used for high speed stability with a minimal drag setting.

Internal airflow optimization

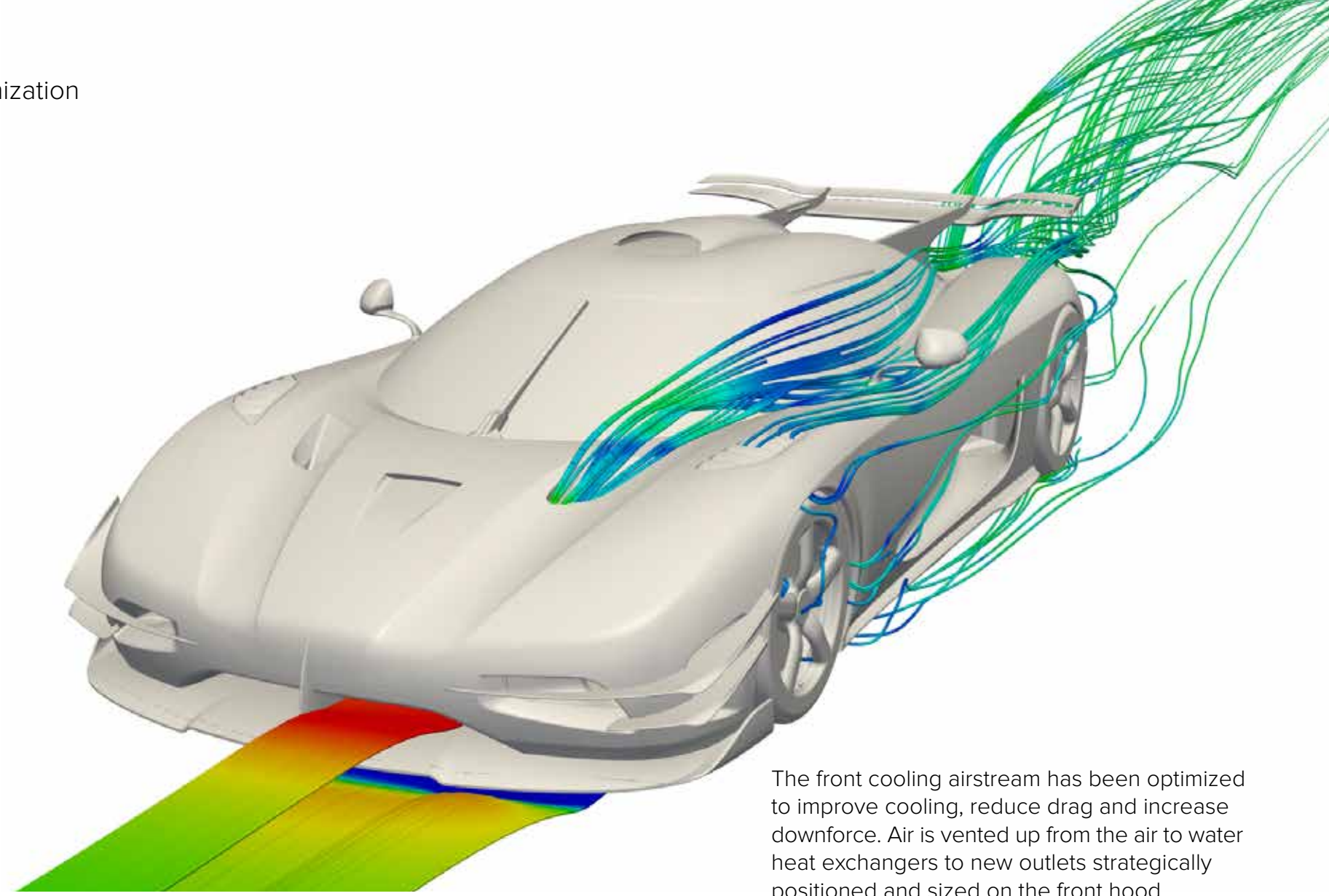

The front cooling airstream has been optimized to improve cooling, reduce drag and increase downforce. Air is vented up from the air to water heat exchangers to new outlets strategically positioned and sized on the front hood.

Dynamic rear wing system

-6 Deg

25 Deg

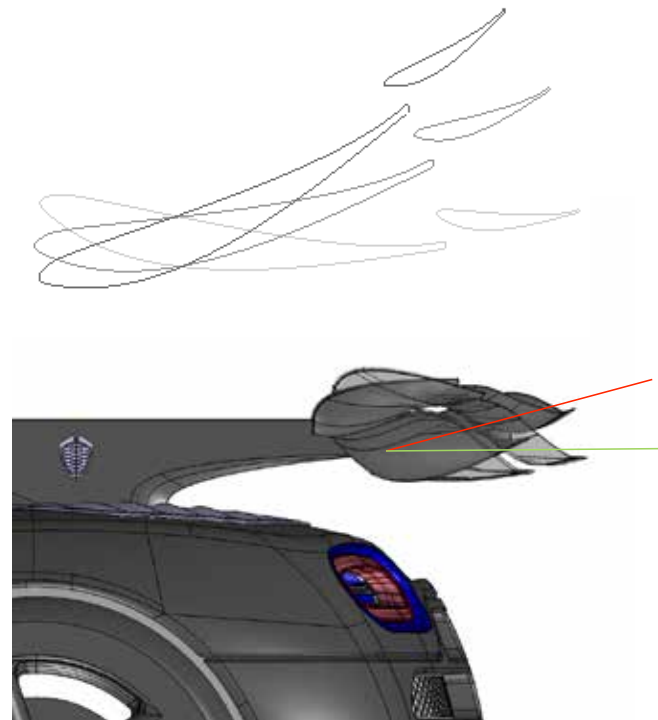
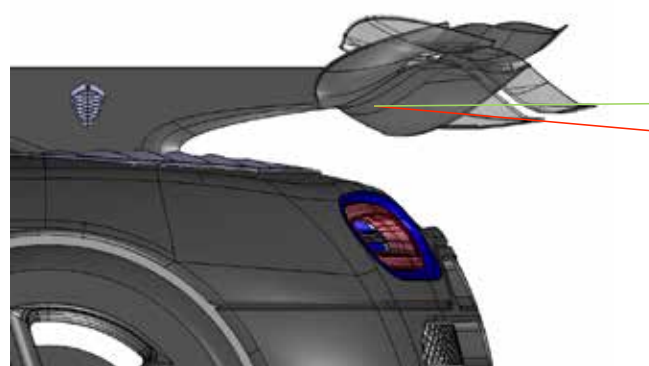
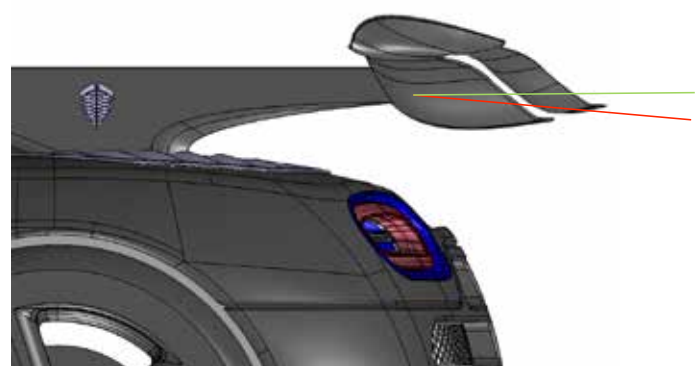

Parked position & High speed / Low drag setting

Braking setting

High downforce setting

Internal airflow optimization

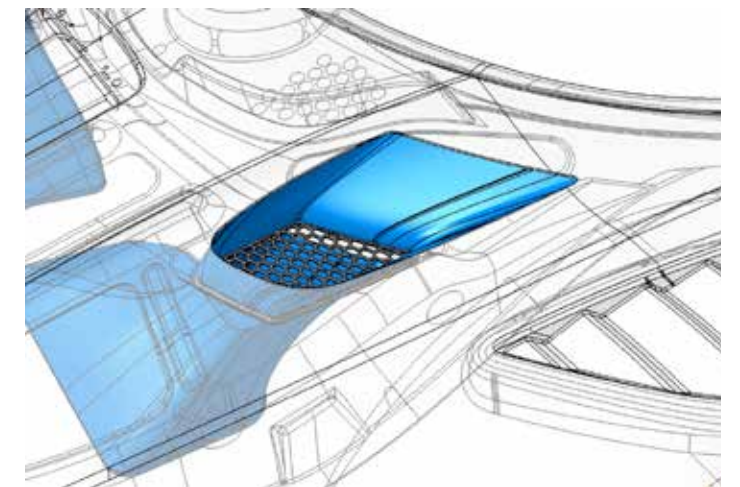
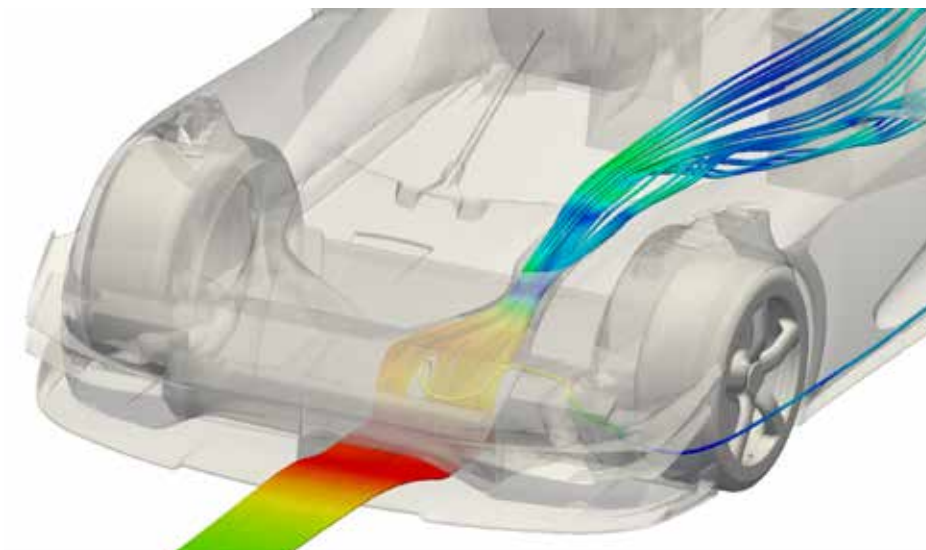

A multi piece duct assembly is integrated into the front hood area to optimize cooling flow and reduce drag.

Internal airflow optimization



The rear engine bay internal flow is optimized in conjunction with external improvements to get a greatly improved intercooler flow and heat ejection.

Dynamic rake control

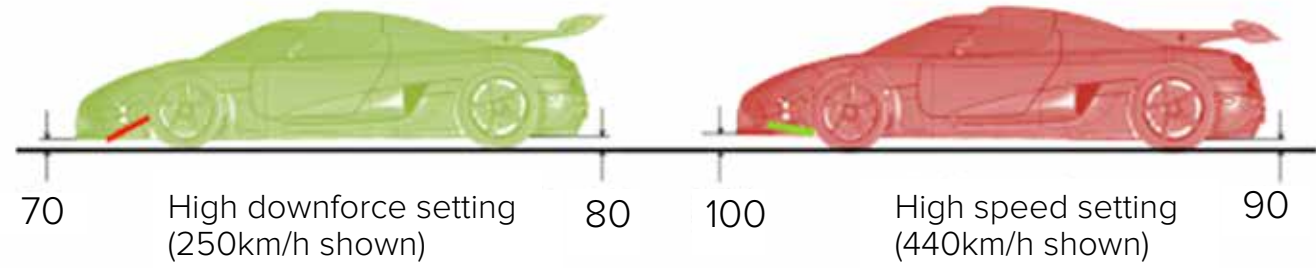

An advanced active ride height system has been developed to give optimal vehicle rake across the speed register.

Composites optimization

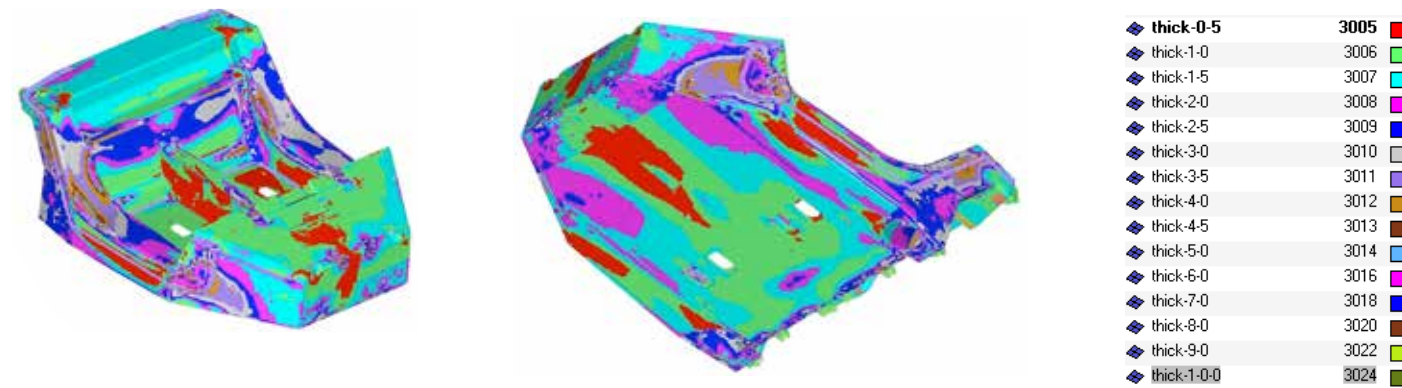

Optimization run with Modal, Torsional stiffness, Front and rear crash displacement. Non symmetrical loading caused by non symmetrical tunnel load path.

Advanced software has been utilized to optimize all of the chassis and body systems for the One:1 vehicle. From an "ideal" thickness simulation, we develop a robust physical lay-up that can be made utilizing a blend of the latest advanced high modulus composites.

Composites optimization:



Optimisation run with Modal and pressure constraints.

All major components have been run optimized, using ideal thickness and high modulus materials, which has resulted in average weight saving of 25% for these parts.

Aerodynamic mirrors

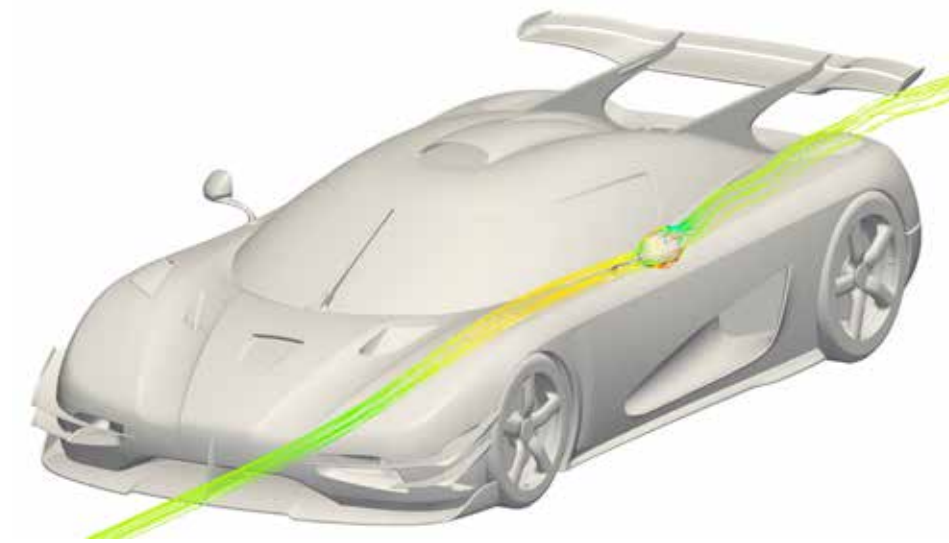

The One:1 is the first Koenigsegg to utilize the new aero mirror concept, designed to improve overall vehicle downforce and visibility without increasing drag.

Adjustable racing pedal assembly

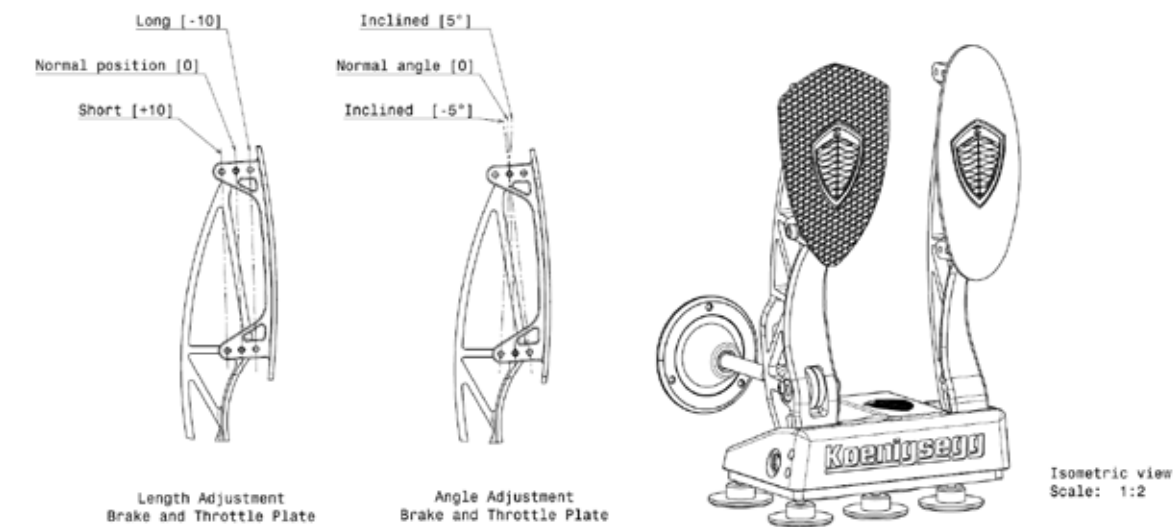

A new lightweight drive by wire pedal assembly with improved ergonomics & adjustable reach is developed for the One:1.













## SPIRIT OF PERFORMANCE

When I started developing the first Koenigsegg cars in 1994, I knew we had to be different and excel in all areas, in order to become what we are today.

At Koenigsegg, good is never enough. We strive for perfection and the moving target of ultimate performance, in every aspect. Whether it is beauty, speed, elegance, comfort or drivability – we make sure to raise the bar.

All available time, emotion, and resources have been spent. Nothing has been spared – everything has been ventured and sacrificed – in order to create a being beyond imagination.

I truly feel that our creations have souls. We have poured our hearts into them.

You will feel it when driving one.



Christian v. Koenigsegg

