



1990 CARAVAN C/V





Caravan C/V: leader of a new era.

Caravan C/V paves the way into a new decade with proven performance. Featuring the stability and traction of front-wheel drive, Caravan C/V continues to offer an outstanding ride coupled with versatile weight-carrying efficiency.

With enough room to handle just about any work or recreational cargo demand, Caravan C/V accommodates you in style and comfort. It's easy to see why it remains one of the most popular

carriers in its class with two sizes and a variety of payload capacities and options to choose from.

Peak performance. Performance comes alive this year with a host of power train options. You can choose the advanced four-speed Ultradrive automatic transaxle with the new 3.3-liter OHV MPI V-6 engine, both standard on the Extended Caravan C/V. Or go for the turbo power of the optional 2.5-liter SOHC SMPI Turbo engine, which is part of the Turbo Sport Package on Caravan C/V. They're both built to go the distance in town or across country miles.

Outstanding drivability.

Whatever your destination, Caravan C/V is an exceptional way to get there. You can maneuver through traffic with ease, thanks to agile and responsive handling. Plus, its compact design makes parking and garageability a snap.

Added versatility. Caravan C/V's innovative features can fulfill every transportation need with strength, durability and versatility. The optional dual rear cargo doors shown here offer convenient loading and unloading. The standard side sliding cargo door also



allows easy access to the spacious interior. Other standard features include a 5-speed manual overdrive transaxle, power-assisted steering and brakes, and the 7/70 Power Train Limited Warranty.*

Extended Caravan C/V, shown above in Claret Red Pearl Coat. Caravan C/V, shown on cover and at left in Radiant Silver.

Some of the equipment shown or described throughout this catalog is available at extra cost.

About this catalog. Since the time of printing, some of the information you'll find in this catalog may have been updated. Ask your dealer for details.

*See back cover for details.

SELECTED CARAVAN C/V PACKAGES

Royal Decor Package*—all models.

- Additional sound insulation
 - Carpeting, front compartment
 - Cloth-covered sun visors with map pockets and non-illuminated visor vanity mirrors, right and left sides
 - Cloth headliner, front compartment
 - Cloth trim applique on door trim panels
 - Lower carpet insert on front door trim panels
 - Molded armrests with integral door pulls on front door trim panels
 - Dual-note horns
 - Electronic speed control
 - High-back reclining bucket seats with inboard armrests, driver and passenger, in luxury cloth trim
 - Leaping Ram plaque with Royal name on front door
 - Lights: ash receiver, front map/reading, headlight switch callout with time delay, ignition switch with time delay, instrumentation panel door ajar warning, instrumentation panel low fuel warning, liftgate-mounted dual flood, low washer fluid warning, passenger seat storage drawer, rear cargo dome, side door and liftgate switches for cargo compartment dome
 - Map pocket on back of passenger bucket seat
 - Power liftgate release
 - Sport steering wheel
 - Tilt steering column
 - Underseat storage drawer
 - Underslung spare tire carrier
- *All items available in package only.

Turbo Sport Package.*

(Available on Caravan C/V model only.)

- 2.5-liter SOHC turbocharged four-cylinder engine with heavy-duty manual transaxle
 - 15-inch by 6-inch cast aluminum road wheels (set of four)
 - P205/70R15 steel-belted radial all-season blackwall tires (set of four)
 - T145/90D16 compact spare tire
 - Dual bright exhaust tip
 - 4,590-lb. G.V.W. Package
 - Heavy-duty brakes
 - Turbo decal on front fenders
- *All items available in package only.

Heavy-Duty Trailer Tow Preparation Package.*

(Extended Caravan C/V models only. See the Dodge Truck and Car Trailer Towing Guide for complete details and recommendations.)

- 120-ampere alternator
 - 625-ampere battery
 - Heavy-duty automatic transaxle oil cooler
 - Heavy-duty radiator—maximum cooling
 - Heavy-duty variable load turn signal flasher
 - Special trailer tow wiring harness
 - 15-inch by 6-inch styled-steel road wheels (set of four)
- *All items available in package only.

Deluxe Convenience Package— all models.

- Electronic speed control
- Tilt steering column

Power Convenience Package

(Requires Royal Decor Package, not available with dual rear cargo doors)

- Power door locks
- Power windows (front door windows only)

Certain models, packages and options are subject to specific restrictions, requirements, or late availability. See your dealer for the latest ordering information.

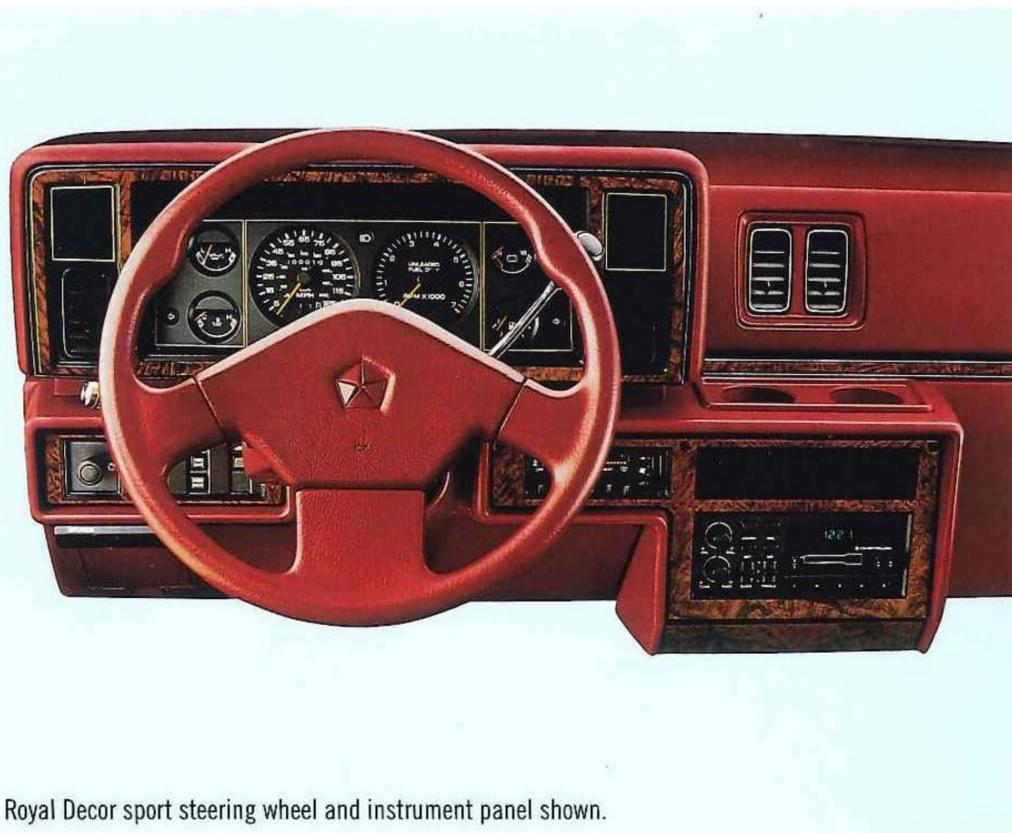

Royal Decor sport steering wheel and instrument panel shown.

Basic Group Package	Caravan C/V	Extended Caravan C/V
0-125 mph speedometer	•*	Standard
625-amp maintenance-free battery	•*	•*
Cable-type fuel filler door release	•*	•*
"Check Gauges" warning light	•*	Standard
Engine coolant temperature gauge	•*	Standard
Engine oil pressure gauge	•*	Standard
Maximum GVW Package	•	Standard
Rear cargo dome light with side door and liftgate switches	•*	•*
Rear window wiper/washer (not available with dual rear doors)	•*	•*
Tachometer	•*	Standard
Trip odometer with pushbutton reset	•*	Standard
Underslung spare tire carrier	•*	•*

*Available in package only.

Van Conversion Package	Caravan C/V	Extended Caravan C/V
Accessory wire harness	•*	•*
Aero-type single halogen headlights	•*	•*
Bright bumpers with color-keyed end caps	•*	•*
Chrome/argent finish grille	•*	•*
Driver and Passenger Seating Package ¹	•	•
4,590-Pound GVW Package	•*	—
Underslung spare tire carrier	•*	•*

*Available in package only. ¹Temporary plastic driver's seat trim with driver and passenger seat risers, riser covers, and seat belts may be substituted for seating package. (Not available when Royal Decor Package is ordered.)



Extended Caravan C/V shown in Claret Red Pearl Coat.



Caravan C/V conversion van, shown in Black.

POPULAR CARAVAN C/V OPTIONS

Capacity Options.

The spacious interior of Caravan C/V, shown at right, offers 133 cubic feet of cargo space, while the extended model lends itself to a roomy 160 cubic feet. Both can handle a rugged 2,000-pound payload with first-class efficiency, and can be outfitted with a variety of options for increased workability.

Wheels and Wheel Covers.

1. 15-inch cast aluminum road wheel, set of four; available only in Turbo Sport Package on Caravan C/V
2. Styled-steel wheel with bright trim ring, hub cover and lug nuts, set of four; optional on all models. 15-inch Extended Caravan C/V wheel shown
3. Steel road wheel, set of four; standard on all models. 15-inch Extended Caravan C/V wheel shown

AM Stereo*/FM Stereo Radio with Cassette Player.

Enjoy premium stereo-quality audio: electronic tuning, bass/treble slide controls, Dynamic Noise Reduction,** cassette tape player with automatic reverse, and integral digital clock.

*Some AM stereo broadcasting may not be compatible with this radio.

**Dynamic Noise Reduction is a trademark of National Semiconductor Corporation.

MOPAR Running Boards.

Sharp-looking black or bright Anodized aluminum running boards lend a custom look and a convenient step-up to your van.

Electric Rear Window Defroster.

Keep the view behind you clear from snow, ice, or fog with this practical, safety-conscious feature.

2.5-Liter SOHC SMPI Turbo-charged Engine.

New engineering refinements harness exceptional power on demand. Generates 150 horsepower at 4,800 rpm. Available in the optional Turbo Sport Package only on Caravan C/V.

3.0-Liter OHC MPI V-6 Engine.

A redesigned intake manifold and other modifications allow superb power and torque from this efficient engine. Available on Caravan C/V only.

Tilt Steering Wheel.

Six adjustable positions make getting in and out easier and allow for individual driving preferences.



Caravan C/V interior shown in Silver/Charcoal.

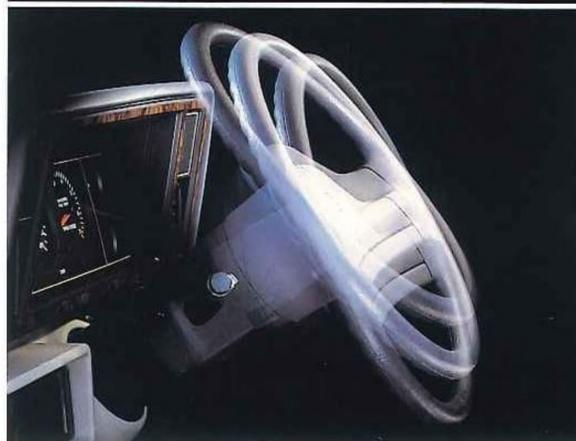
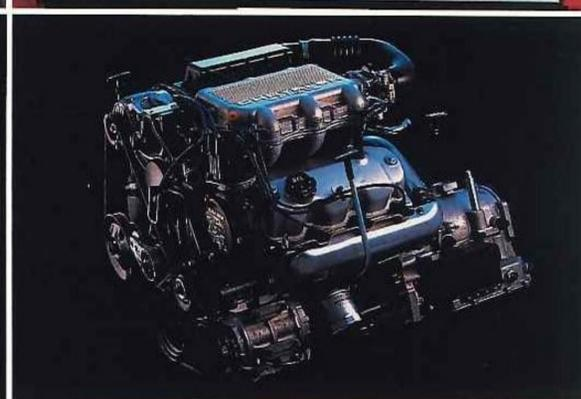
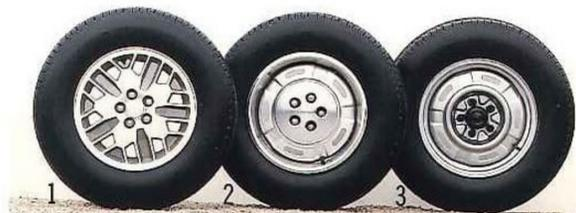

Interior Trim.



Optional Royal Decor Package. Sentry/Classic cloth trim reclining high-back bucket seats with integral head restraints and inboard folding armrests. Available on all models. Choose from Almond, Bordeaux Red, Silver/Charcoal or Twilight Blue.



Optional decor. Jordan cloth and vinyl trim low-back bucket seats available with choice of driver seat only or driver and passenger Seating Package. Available on all models. Select from Almond or Silver/Charcoal.



Standard trim. Saddle Grain all-vinyl low-back bucket seat. Choice of standard driver seat only or driver and passenger Seating Package. Available in Almond or Silver/Charcoal.

Dual Rear Cargo Doors.

Handy rear doors make loading and unloading more convenient. Available with or without glass.

STANDARD/OPTIONAL EQUIPMENT AND SPECIFICATIONS

EXTENDED CARAVAN C/V		
CARAVAN C/V		
EXTERIOR		
Bumpers—Front and rear: bright; with protective rub strips and end caps	S	S
Door—Cargo compartment: sliding right side with no glass; outside key lock	S	S
Doors—Cargo compartment: dual, rear hinged with fixed glass	E	E
Doors—Cargo compartment: dual, rear hinged with no glass	E	E
Fuel Tank—20-gallon	S	S
Glass—All windows: tinted	S	S
Glass—Sunscreen: all windows except windshield and front doors (vented glass in sliding door required at extra cost; not available with dual rear doors with fixed glass)	E	E
Glass—Vented sliding side door: tinted	E	E
Grille—Argent finish	S	S
Headlights—Halogen	S	S
Liftgate—With fixed glass and outside key lock	S	S
Mirrors—Exterior, dual oversize foldaway type	S	S
Moldings—Rear window and windshield: black	S	S
Wheels—Steel: argent with black hub cover and lug nut covers (set of four)	S	S
Wheels—Styled road-type: with bright trim ring, hub cover and nuts (set of four)	E	E
INTERIOR		
Air Conditioning ¹	E	E
Cigar Lighter	S	S
Clock—Electronic digital, integral with radio	S	S
Cup Holders—Instrument panel	S	S
Floor Mat—Front compartment: black, with underlayment	S	S
Headliner—Front compartment: softboard	S	S
Heater—Bi-level ventilation	S	S
Hood Release—Inside	S	S
Instrumentation—Fuel gauge, high engine coolant temperature and low engine oil pressure warning lights; speedometer; voltmeter	S	NA
Instrumentation—Fuel gauge, high engine coolant temperature and low engine oil pressure gauges; speedometer; voltmeter; tachometer; trip odometer with reset	P	S
Light—Dome: driver's compartment	S	S
Mirror—Interior, day/night	S	S
Power Door Locks—Not available with dual rear cargo door	E	E
Radio—AM stereo ² /FM stereo: electronic tuning; two speakers; integral digital clock ³	S	S
Radio—AM stereo ² /FM stereo with cassette tape player: electronic tuning; four speakers; integral digital clock	E	E
Steering Column—Tilt	E	E
Steering Wheel—Deluxe two-spoke: vinyl	S	S
Tire Carrier—Spare: inside mounted	S	S
FUNCTIONAL		
Alternator—12-volt, 90-ampere	S	S
Battery—500-ampere: maintenance-free	S	S
Brakes—Vented front disc/rear drum with height-sensing proportioning valve: power-assisted	S	S
Chimes—Warning: fasten seat belts, headlights on, key in ignition	S	S
Coolant Overflow Reservoir	S	S
Corrosion Protection—Urethane protective coating on lower bodyside panels; extensive use of galvanized steel	S	S
Defroster—Liftgate window: electric (not available with dual rear doors)	E	E
Demisters—Front door windows	S	S
Electronic Ignition and Voltage Regulator	S	S
Emissions—High altitude	E	E
Emissions Controls—California (required at extra cost on all vehicles registered in California: not available otherwise)	E	E
Exhaust System—Stainless steel	S	S
Power-Assisted Steering	S	S
Shock Absorbers—Front and rear (heavy-duty on Extended model)	S	S
Stabilizer—front	S	S
Tire—Spare: compact (T125/70D15 limited service)	S	NA
Tire—Spare: conventional	E	S
Tires—LT195/75R14 steel-belted radial black sidewall (set of four)	P	NA
Tires—LT195/75R15 steel-belted radial black sidewall (set of five)	NA	S
Tires—P195/75R14 steel-belted radial black sidewall (set of four)	S	NA
Tires—P205/70R15 steel-belted radial black sidewall (set of four)	P	NA
Tires—P205/70R15 steel-belted radial black sidewall ASP ⁴ (set of four)	E	NA
Windshield Wipers—Deluxe: intermittent wipe	S	S

S—Standard. E—Extra cost. NA—Not available. P—Available in package only.

¹There are special engine cooling requirements for field-installed air conditioning. Failure to follow these requirements may invalidate warranty. See your dealer for details. ²Some AM stereo broadcasting may not be compatible with this radio. ³May be deleted on factory orders for credit. ⁴All Season Performance.

SPECIFICATIONS	Caravan C/V	Extended Caravan C/V
Wheelbase	112.0"	119.0"
Overall Length	175.9"	190.5"
Overall Width	72.2"	72.2"
Overall Height	64.4"	64.7"
Length—Cargo compartment at floor	81.8"	96.4"
Length—Cargo compartment to seatback	75.6"	90.2"
Width—Cargo compartment between wheelhousings	49.2"	49.2"
Maximum Interior Height	48.8"	48.8"
Maximum Interior Width	69.6"	69.6"
Cargo Volume	133 cu ft	160 cu ft
Maximum GVW Rating	4,910 lb	5,090 lb
Maximum Payload Rating	2,000 lb	2,000 lb

ENGINES AND TRANSAXLES	Caravan C/V	Extended Caravan C/V
2.5-liter EFI engine with five-speed manual trans-axle (includes shift indicator light)	S	NA
2.5-liter EFI engine with three-speed automatic transaxle	E	NA
2.5-liter SMPI turbocharged engine with heavy-duty five-speed manual transaxle*	P	NA
2.5-liter SMPI turbocharged engine with three-speed automatic transaxle*	PR	NA
3.0-liter MPI V-6 engine† with three-speed automatic transaxle (includes transaxle oil cooler)	E	NA
3.0-liter MPI V-6 engine† with four-speed overdrive automatic transaxle (includes transaxle oil cooler)	E	NA
3.3-liter MPI V-6 engine with direct ignition system and four-speed overdrive automatic transaxle (includes transaxle oil cooler)	NA	S

S—Standard. E—Extra cost. NA—Not available. P—Available in package only. PR—Optional Package required. *Turbocharged engine not recommended for trailer towing, and such use may damage engine and invalidate warranty. See dealer for details. †Built by Mitsubishi Motors Corporation.

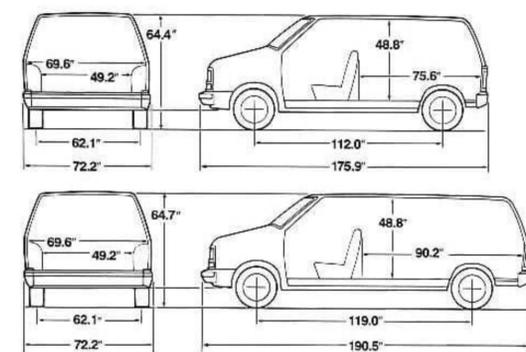

Standard Safety Features.

- Backup lights
- Brake system warning light
- Dual braking system with separate brake fluid reservoirs in the master cylinder
- Energy-absorbing steering column
- Fade-resistant front disc brakes
- Glare reduction measures for instrument panel, steering wheel, and windshield wipers
- Ignition and steering column lock
- Inside hood release
- Padded instrument panel and sun visors
- Recessed inside door release
- Side marker lights and reflectors
- Traffic hazard warning flasher system
- Unibelt restraint system

Caravan C/V Exterior Colors.



Black*



Bright White



Dark Suede*



Twilight Blue Pearl Coat†



Claret Red Pearl Coat**



Medium Suede*



Charcoal Pearl Coat*



Black Cherry Pearl Coat*



Radiant Silver

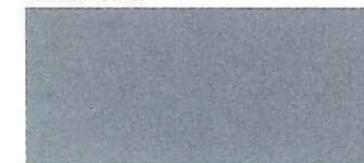

Ice Blue

Note: Due to printing limitations, the colors shown will vary slightly from actual hues. See your Dodge dealer for accurate color chips.

*Not available with dual rear hinged doors.

†Extra cost.



MOPAR parts are engineered by Chrysler Motors for use in your new Dodge Caravan C/V. When replacement is necessary, be sure to specify MOPAR parts. Used by professional mechanics all over the world.

Dodge and MOPAR are registered trademarks, and Caravan C/V is a trademark of Chrysler Motors Corporation.



Chrysler Credit Financing.

Chrysler Credit offers a variety of finance programs that will help make your new Caravan C/V even more affordable. These special finance and leasing programs are designed to meet the needs of today's automotive buyer. They include Gold Key Lease, America's Choice Payment Plan, College Graduate Plans, Retail Financing, and more. Ask your salesperson for details.

Consider Leasing.

Many of today's new truck prospects are wisely considering leasing as an alternative to buying. Leasing a new Dodge Caravan C/V usually involves a small security deposit and a first month's lease payment. Monthly payments are usually less than financing a new car purchase. Ask your dealer for details.

7/70 Power Train Limited Warranty.

Upon expiration of the basic 12-month or 12,000-mile limited warranty, coverage is extended on power train components to seven years or 70,000 miles. A deductible applies. See your dealer for a copy of the warranty.

7/100 Anticorrosion Limited Warranty.

Your dealer will repair or replace at no charge outer body sheet metal panels found to have developed perforation (rust-through) in normal use up to seven years or 100,000 miles. See your dealer for a copy of the limited warranty.

Optional Service Contract Coverage.

Chrysler Service Contracts provide you with additional peace of mind protection for your new vehicle. Chrysler Motors offers a variety of plans to meet your needs. Plan coverage begins after your vehicle's basic warranty expires. A deductible applies. Allowances for car rental and towing are also included.

Chrysler Purchase Assistance Program for the Physically Challenged.

Cash reimbursements of up to \$500 are available for qualified adaptive driving devices on 1990 Chrysler Motors cars and trucks. For further information, contact your dealer or the PHYSICALLY CHALLENGED RESOURCE CENTER AT 1-800-255-9877.

Specifications, descriptions, and illustrative materials contained herein are as accurate as known at the time this publication was approved for printing. Chrysler Motors reserves the right to discontinue models or options at any time or change specifications and materials, equipment, and design without notice and without incurring obligation. All options and accessories illustrated or referred to as optional or available in this publication are at extra cost. Some options are required in combination with other options. For the price of the model with the equipment you desire, or verification of specifications contained here, see your Dodge Truck dealer.

BUCKLE UP FOR SAFETY.



POPULAR CARAVAN C/V OPTIONS

Capacity Options.

The spacious interior of Caravan C/V, shown at right, offers 133 cubic feet of cargo space, while the extended model lends itself to a roomy 160 cubic feet. Both can handle a rugged 2,000-pound payload with first-class efficiency, and can be outfitted with a variety of options for increased workability.

Wheels and Wheel Covers.

- 15-inch cast aluminum road wheel, set of four; available only in Turbo Sport Package on Caravan C/V
- Styled-steel wheel with bright trim ring, hub cover and lug nuts, set of four; optional on all models. 15-inch Extended Caravan C/V wheel shown
- Steel road wheel, set of four; standard on all models. 15-inch Extended Caravan C/V wheel shown

AM Stereo*/FM Stereo Radio with Cassette Player.

Enjoy premium stereo-quality audio: electronic tuning, bass/treble slide controls, Dynamic Noise Reduction,** cassette tape player with automatic reverse, and integral digital clock.

*Some AM stereo broadcasting may not be compatible with this radio.
**Dynamic Noise Reduction is a trademark of National Semiconductor Corporation.

MOPAR Running Boards.

Sharp-looking black or bright Anodized aluminum running boards lend a custom look and a convenient step-up to your van.

Electric Rear Window Defroster.

Keep the view behind you clear from snow, ice, or fog with this practical, safety-conscious feature.

2.5-Liter SOHC SMPI Turbo-charged Engine.

New engineering refinements harness exceptional power on demand. Generates 150 horsepower at 4,800 rpm. Available in the optional Turbo Sport Package only on Caravan C/V.

3.0-Liter OHC MPI V-6 Engine.

A redesigned intake manifold and other modifications allow superb power and torque from this efficient engine. Available on Caravan C/V only.

Tilt Steering Wheel.

Six adjustable positions make getting in and out easier and allow for individual driving preferences.



Caravan C/V interior shown in Silver/Charcoal.

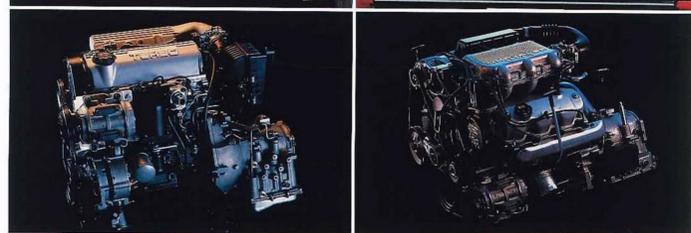

Interior Trim.



Optional Royal Decor Package. Sentry/Classic cloth trim reclining high-back bucket seats with integral head restraints and inboard folding armrests. Available on all models. Choose from Almond, Bordeaux Red, Silver/Charcoal or Twilight Blue.



Optional decor. Jordan cloth and vinyl trim low-back bucket seats available with choice of driver seat only or driver and passenger Seating Package. Available on all models. Select from Almond or Silver/Charcoal.



Standard trim. Saddle Grain all-vinyl low-back bucket seat. Choice of standard driver seat only or driver and passenger Seating Package. Available in Almond or Silver/Charcoal.

Dual Rear Cargo Doors.

Handy rear doors make loading and unloading more convenient. Available with or without glass.

STANDARD/OPTIONAL EQUIPMENT AND SPECIFICATIONS

EXTENDED CARAVAN C/V		CARAVAN C/V	
EXTERIOR			
Bumpers—Front and rear; bright; with protective rub strips and end caps	S	S	
Door—Cargo compartment: sliding right side with no glass; outside key lock	S	S	
Doors—Cargo compartment: dual, rear hinged with fixed glass	E	E	
Doors—Cargo compartment: dual, rear hinged with no glass	E	E	
Fuel Tank—20-gallon	S	S	
Glass—All windows: tinted	S	S	
Glass—Sunscreen: all windows except windshield and front doors (vented glass in sliding door required at extra cost; not available with dual rear doors with fixed glass)	E	E	
Glass—Vented sliding side door: tinted	E	E	
Grille—Argent finish	S	S	
Headlights—Halogen	S	S	
Liftgate—With fixed glass and outside key lock	S	S	
Mirrors—Exterior, dual, oversized foldaway type	S	S	
Moldings—Rear window and windshield: black	S	S	
Wheels—Steel: argent with black hub cover and lug nut covers (set of four)	S	S	
Wheels—Styled road-type: with bright trim ring, hub cover and nuts (set of four)	E	E	
INTERIOR			
Air Conditioning ¹	E	E	
Cigar Lighter	S	S	
Clock—Electronic digital, integral with radio	S	S	
Cup Holders—Instrument panel	S	S	
Floor Mat—Front compartment: black, with underlayment	S	S	
Headliner—Front compartment: softboard	S	S	
Heater—Bi-level ventilation	S	S	
Hood Release—Inside	S	S	
Instrumentation—Fuel gauge, high engine coolant temperature and low engine oil pressure warning lights; speedometer; voltmeter	S	NA	
Instrumentation—Fuel gauge, high engine coolant temperature and low engine oil pressure gauges; speedometer; voltmeter; tachometer; trip odometer with reset	P	S	
Light—Dome, driver's compartment	S	S	
Mirror—Interior, day/night	S	S	
Power Door Locks—Not available with dual rear cargo door	E	E	
Radio—AM stereo ² /FM stereo: electronic tuning; two speakers; integral digital clock ³	S	S	
Radio—AM stereo ² /FM stereo with cassette tape player: electronic tuning; four speakers; integral digital clock	E	E	
Steering Column—Tilt	E	E	
Steering Wheel—Deluxe two-spoke: vinyl	S	S	
Tire Carrier—Spare: inside mounted	S	S	
FUNCTIONAL			
Alternator—12-volt, 90-ampere	S	S	
Battery—500-ampere; maintenance-free	S	S	
Brakes—Vented front disc/rear drum with height-sensing proportioning valve; power-assisted	S	S	
Chimes—Warning: fasten seat belts, headlights on, key in ignition	S	S	
Coolant Overflow Reservoir	S	S	
Corrosion Protection—Urethane protective coating on lower bodyside panels; extensive use of galvanized steel	S	S	
Defroster—Liftgate window: electric (not available with dual rear doors)	E	E	
Demisters—Front door windows	S	S	
Electronic Ignition and Voltage Regulator	S	S	
Emissions—High altitude	E	E	
Emissions Controls—California (required at extra cost on all vehicles registered in California; not available otherwise)	E	E	
Exhaust System—Stainless steel	S	S	
Power-Assisted Steering	S	S	
Shock Absorbers—Front and rear (heavy-duty on Extended model)	S	S	
Stabilizer—front	S	S	
Tire—Spare: compact (T125/70D15 limited service)	S	NA	
Tire—Spare: conventional	E	S	
Tires—T195/75R14 steel-belted radial black sidewall (set of four)	P	NA	
Tires—T195/75R15 steel-belted radial black sidewall (set of five)	NA	S	
Tires—P195/75R14 steel-belted radial black sidewall (set of four)	S	NA	
Tires—P205/70R15 steel-belted radial black sidewall (set of four)	P	NA	
Tires—P205/70R15 steel-belted radial black sidewall ASP ⁴ (set of four)	E	NA	
Windshield Wipers—Deluxe: intermittent wipe	S	S	

S—Standard. E—Extra cost. NA—Not available. P—Available in package only.
¹There are special engine cooling requirements for field-installed air conditioning. Failure to follow these requirements may invalidate warranty. See your dealer for details. ²Some AM stereo broadcasting may not be compatible with this radio. ³May be deleted on factory orders for credit. ⁴All Season Performance.

SPECIFICATIONS	Caravan C/V	Extended Caravan C/V
Wheelbase	112.0"	119.0"
Overall Length	175.9"	190.5"
Overall Width	72.2"	72.2"
Overall Height	64.4"	64.7"
Length—Cargo compartment at floor	81.8"	96.4"
Length—Cargo compartment to seatback	75.6"	90.2"
Width—Cargo compartment between wheelhousings	49.2"	49.2"
Maximum Interior Height	48.8"	48.8"
Maximum Interior Width	69.6"	69.6"
Cargo Volume	133 cu ft	160 cu ft
Maximum GVW Rating	4,910 lb	5,090 lb
Maximum Payload Rating	2,000 lb	2,000 lb

ENGINES AND TRANSEXLES	Caravan C/V	Extended Caravan C/V
2.5-liter EFI engine with five-speed manual transaxle (includes shift indicator light)	S	NA
2.5-liter EFI engine with three-speed automatic transaxle	E	NA
2.5-liter SMPI turbocharged engine with heavy-duty five-speed manual transaxle*	P	NA
2.5-liter SMPI turbocharged engine with three-speed automatic transaxle*	PR	NA
3.0-liter MPI V-6 engine ¹ with three-speed automatic transaxle (includes transaxle oil cooler)	E	NA
3.0-liter MPI V-6 engine ¹ with four-speed overdrive automatic transaxle (includes transaxle oil cooler)	E	NA
3.3-liter MPI V-6 engine with direct ignition system and four-speed overdrive automatic transaxle (includes transaxle oil cooler)	NA	S

S—Standard. E—Extra cost. NA—Not available. P—Available in package only. PR—Optional Package required. *Turbocharged engine not recommended for trailer towing, and such use may damage engine and invalidate warranty. See dealer for details. ¹Built by Mitsubishi Motors Corporation.

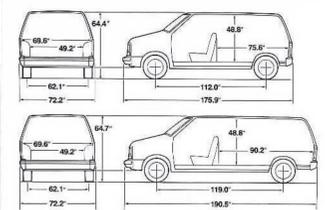

Standard Safety Features.

- Backup lights
- Brake system warning light
- Dual braking system with separate brake fluid reservoirs in the master cylinder
- Energy-absorbing steering column
- Fade-resistant front disc brakes
- Glare reduction measures for instrument panel, steering wheel, and windshield wipers
- Ignition and steering column lock
- Inside hood release
- Padded instrument panel and sun visors
- Recessed inside door release
- Side marker lights and reflectors
- Traffic hazard warning flasher system
- Unibelt restraint system

Caravan C/V Exterior Colors.



Note: Due to printing limitations, the colors shown will vary slightly from actual hues. See your Dodge dealer for accurate color chips.
*Not available with dual rear hinged doors.
†Extra cost.



MOPAR parts are engineered by Chrysler Motors for use in your new Dodge Caravan C/V. When replacement is necessary, be sure to specify MOPAR parts. Used by professional mechanics all over the world. Dodge and MOPAR are registered trademarks, and Caravan C/V is a trademark of Chrysler Motors Corporation.



Chrysler Credit Financing. Chrysler Credit offers a variety of finance programs that will help make your new Caravan C/V even more affordable. These special finance and leasing programs are designed to meet the needs of today's automotive buyer. They include Gold Key Lease, America's Choice Payment Plan, College Graduate Plans, Retail Financing, and more. Ask your salesperson for details.

Consider Leasing.

Many of today's new truck prospects are wisely considering leasing as an alternative to buying. Leasing a new Dodge Caravan C/V usually involves a small security deposit and a first month's lease payment. Monthly payments are usually less than financing a new car purchase. Ask your dealer for details.

7/70 Power Train Limited Warranty.

Upon expiration of the basic 12-month or 12,000-mile limited warranty, coverage is extended on power train components to seven years or 70,000 miles. A deductible applies. See your dealer for a copy of the warranty.

7/100 Anticorrosion Limited Warranty.

Your dealer will repair or replace at no charge outer body sheet metal panels found to have developed perforation (rust-through) in normal use up to seven years or 100,000 miles. See your dealer for a copy of the limited warranty.

Optional Service Contract Coverage.

Chrysler Service Contracts provide you with additional peace of mind protection for your new vehicle. Chrysler Motors offers a variety of plans to meet your needs. Plan coverage begins after your vehicle's basic warranty expires. A deductible applies. Allowances for car rental and towing are also included.

Chrysler Purchase Assistance Program for the Physically Challenged.

Cash reimbursements of up to \$500 are available for qualified adaptive driving devices on 1990 Chrysler Motors cars and trucks. For further information, contact your dealer or the PHYSICALLY CHALLENGED RESOURCE CENTER AT 1-800-255-9877.

Specifications, descriptions, and illustrative materials contained herein are as accurate as known at the time this publication was approved for printing. Chrysler Motors reserves the right to discontinue models or options at any time or change specifications and materials, equipment, and design without notice and without incurring obligation. All options and accessories illustrated or referred to as optional or available in this publication are at extra cost. Some options are required in combination with other options. For the price of the model with the equipment you desire, or verification of specifications contained here, see your Dodge Truck dealer.

BUCKLE UP FOR SAFETY.

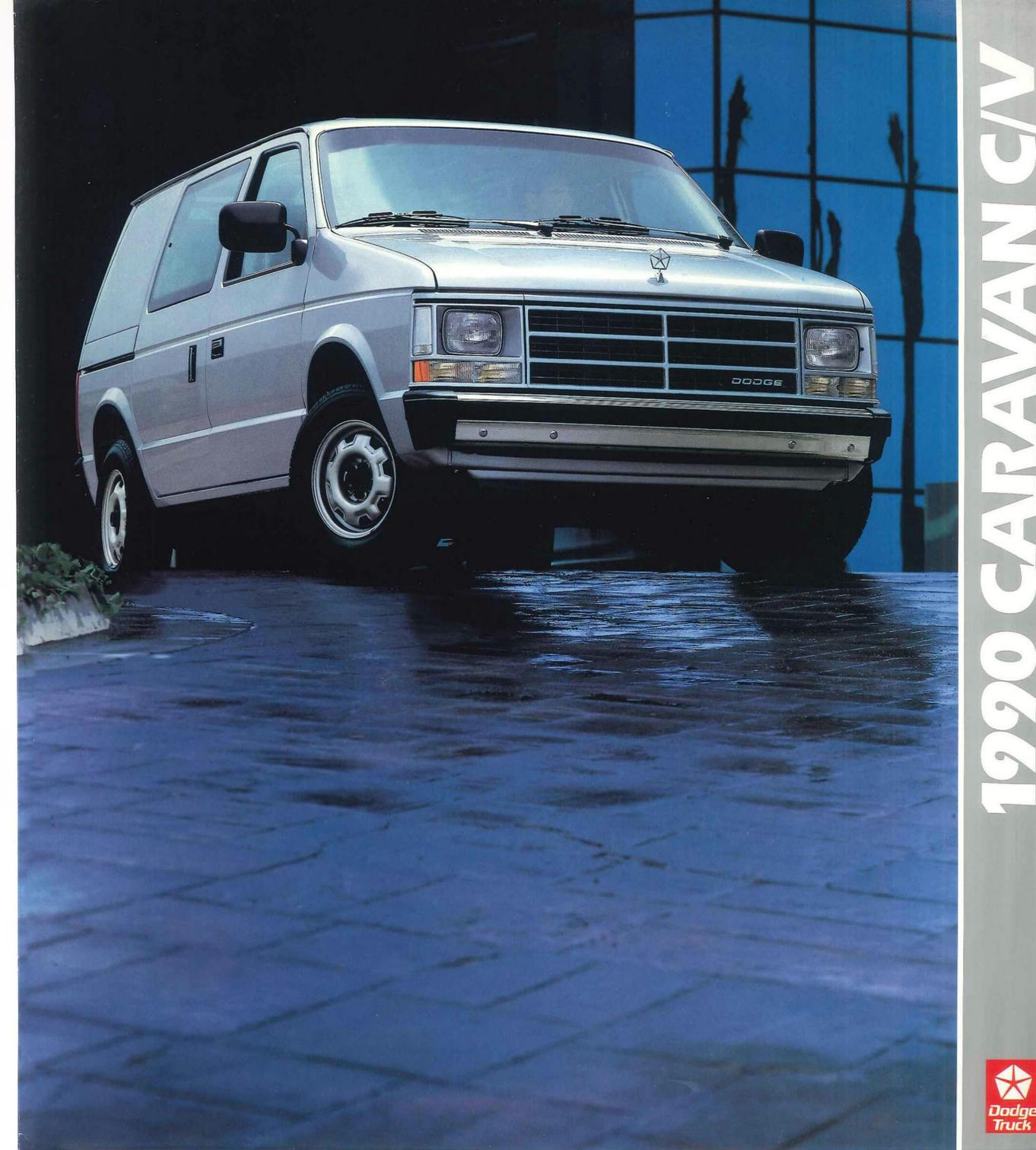

1990 CARAVAN C/V



Form No. 81-305-0032 9/89 (200M) Litho in USA



Caravan C/V: leader of a new era.

Caravan C/V paves the way into a new decade with proven performance. Featuring the stability and traction of front-wheel drive, Caravan C/V continues to offer an outstanding ride coupled with versatile weight-carrying efficiency.

With enough room to handle just about any work or recreational cargo demand, Caravan C/V accommodates you in style and comfort. It's easy to see why it remains one of the most popular

carriers in its class with two sizes and a variety of payload capacities and options to choose from.

Peak performance. Performance comes alive this year with a host of power train options. You can choose the advanced four-speed Ultradrive automatic transaxle with the new 3.3-liter OHV MPI V-6 engine, both standard on the Extended Caravan C/V. Or go for the turbo power of the optional 2.5-liter SOHC SMPI Turbo engine, which is part of the Turbo Sport Package on Caravan C/V. They're both built to go the distance in town or across country miles.

Outstanding drivability. Whatever your destination, Caravan C/V is an exceptional way to get there. You can maneuver through traffic with ease, thanks to agile and responsive handling. Plus, its compact design makes parking and garageability a snap.

Added versatility. Caravan C/V's innovative features can fulfill every transportation need with strength, durability and versatility. The optional dual rear cargo doors shown here offer convenient loading and unloading. The standard side sliding cargo door also



allows easy access to the spacious interior. Other standard features include a 5-speed manual overdrive transaxle, power-assisted steering and brakes, and the 7/70 Power Train Limited Warranty.*

Extended Caravan C/V, shown above in Claret Red Pearl Coat. Caravan C/V, shown on cover and at left in Radiant Silver.

Some of the equipment shown or described throughout this catalog is available at extra cost.

About this catalog. Since the time of printing, some of the information you'll find in this catalog may have been updated. Ask your dealer for details.

*See back cover for details.

Royal Decor Package*—all models.

- Additional sound insulation
 - Carpeting, front compartment
 - Cloth-covered sun visors with map pockets and non-illuminated visor vanity mirrors, right and left sides
 - Cloth headliner, front compartment
 - Cloth trim applique on door trim panels
 - Lower carpet insert on front door trim panels
 - Molded armrests with integral door pulls on front door trim panels
 - Dual-note horns
 - Electronic speed control
 - High-back reclining bucket seats with inboard armrests, driver and passenger, in luxury cloth trim
 - Leaping Ram plaque with Royal name on front door
 - Lights: ash receiver, front map/reading, headlight switch callout with time delay, ignition switch with time delay, instrument panel door ajar warning, instrument panel low fuel warning, liftgate-mounted dual flood, low washer, liftgate warning, passenger seat storage drawer, rear cargo dome, side door and liftgate switches for cargo compartment dome
 - Map pocket on back of passenger bucket seat
 - Power liftgate release
 - Sport steering wheel
 - Tilt steering column
 - Underseat storage drawer
 - Underslung spare tire carrier
- *All items available in package only.

Turbo Sport Package*

- (Available on Caravan C/V model only.)
- 2.5-liter SOHC turbocharged four-cylinder engine with heavy-duty manual transaxle
 - 15-inch by 6-inch cast aluminum road wheels (set of four)
 - P205/70R15 steel-belted radial all-season blackwall tires (set of four)
 - T145/90D16 compact spare tire
 - Dual bright exhaust tip
 - 4,590-lb. G.V.W. Package
 - Heavy-duty brakes
 - Turbo decal on front fenders
- *All items available in package only.

Heavy-Duty Trailer Tow Preparation Package*

- (Extended Caravan C/V models only. See the Dodge Truck and Car Trailer Towing Guide for complete details and recommendations.)
- 120-ampere alternator
 - 625-ampere battery
 - Heavy-duty automatic transaxle oil cooler
 - Heavy-duty radiator—maximum cooling
 - Heavy-duty variable load turn signal flasher
 - Special trailer tow wiring harness
 - 15-inch by 6-inch styled-steel road wheels (set of four)
- *All items available in package only.

Deluxe Convenience Package—all models.

- Electronic speed control
 - Tilt steering column
- Power Convenience Package**
(Requires Royal Decor Package, not available with dual rear cargo doors.)
- Power door locks
 - Power windows (front door windows only)

Certain models, packages and options are subject to specific restrictions, requirements, or late availability. See your dealer for the latest ordering information.

SELECTED CARAVAN C/V PACKAGES



Royal Decor sport steering wheel and instrument panel shown.

Basic Group Package	Caravan C/V	Extended Caravan C/V
0-125 mph speedometer	•*	Standard
625-amp maintenance-free battery	•*	•*
Cable-type fuel filler door release	•*	•*
"Check Gauges" warning light	•*	Standard
Engine coolant temperature gauge	•*	Standard
Engine oil pressure gauge	•*	Standard
Maximum GVW Package	•	Standard
Rear cargo dome light with side door and liftgate switches	•*	•*
Rear window wiper/washer (not available with dual rear doors)	•*	•*
Tachometer	•*	Standard
Trip odometer with pushbutton reset	•*	Standard
Underslung spare tire carrier	•*	•*

*Available in package only.

Van Conversion Package	Caravan C/V	Extended Caravan C/V
Accessory wire harness	•*	•*
Aero-type single halogen headlights	•*	•*
Bright bumpers with color-keyed end caps	•*	•*
Chrome/argent finish grille	•*	•*
Driver and Passenger Seating Package ¹	•	•
4,590-Pound GVW Package	•*	—
Underslung spare tire carrier	•*	•*

*Available in package only. ¹Temporary plastic driver's seat trim with driver and passenger seat risers, riser covers, and seat belts may be substituted for seating package. (Not available when Royal Decor Package is ordered.)



Extended Caravan C/V shown in Claret Red Pearl Coat.



Caravan C/V conversion van, shown in Black.