

CHEVROLET TRUCKS

1961

Corvaair 95 Models





Totally new

CONCEPT *in light-duty trucking*

For 1961, Chevrolet brings you a precedent-shattering new idea in light-duty trucks—a completely new series engineered and built around a new high in payload potential. *Three new Corvair*

95 models, a panel and two pickups, offer more cargo capacity for their size and weight than anything that ever came down the road. Light-duty truck users in every line of work will benefit from scores of new ideas. For example, efficient proportions on a space-saving 95-inch wheelbase that spells new ease of operation in congested areas—parking, docking and turn-around versatility no other truck can match. Or, low basic truck weight that makes possible outstanding fuel economy, and—combined with rugged construction—also results in exceptional cargo capacity.

Corvan panel and Rampside pickup models offer two-level loading convenience, with walk-in, side-door access to a load floor *less* than 14 inches off the ground.





There's the extra-efficient Corvair 95 power package, mounted in the rear to leave engine heat and noise behind—an engine that lets you forget about anti-freeze, water pump, radiator and hose troubles. This new arrangement also puts the driver up front for a better-than-ever command of the road. And it carries the bulk of the cargo amidships for ideal weight distribution. Handling and steering are consistently sure and crisp, whether empty or loaded to capacity. The list of new Corvair 95 design advantages goes on and on. They all add up to just one thing: Chevrolet's Corvair 95 offers a better, faster, easier, more economical way to do just about any light-duty job!

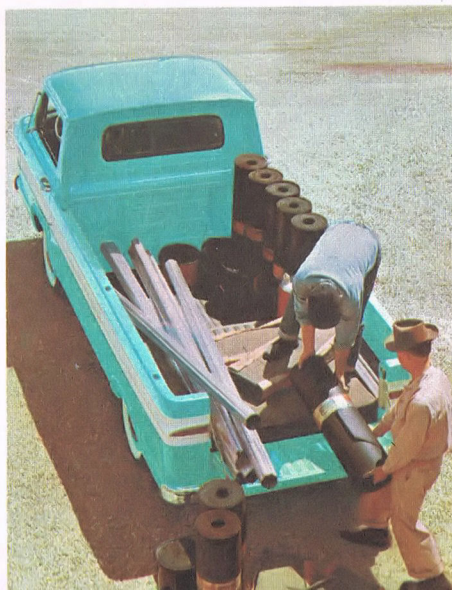

New ways to save space—key to the new trend in trucks

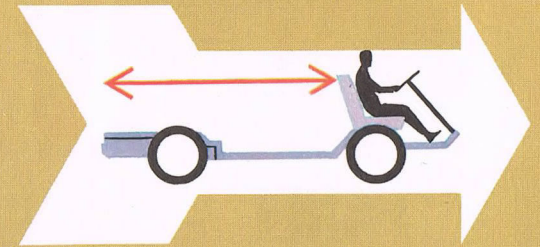

Never before has a truck design utilized space so efficiently, or been so completely engineered around the concept of maximum load-carrying ability. It took a major design breakthrough to make the Corvair 95 possible: the precedent-shattering Unipack power package. Combining engine, transmission and rear axle gearing in one unit, it's small enough to fit between the rear wheels and below a conventional-height load platform. It's light enough in weight to combine rear installation with superior vehicle balance and weight distribution. And it's efficient enough to deliver performance that more than meets high American standards.

With the complete power train unitized and occupying a space that is largely unusable in conventional trucks, the major portion of the chassis need accommodate only cargo and cab. The roomy Corvair 95 cab takes up little more than one-third of it . . . AND ALL THE REST IS LOADSPACE!

■ Over 8½ feet of inside cargo length at pick-up tailgate level takes extra-long loads handily, and there's over five feet of inside width for bulky cargo. ■ With 80 cubic feet of cargo space, the Corvair 95 offers **the biggest pickup box in the business**, in both Rampside and Loadside models. ■ Nearly 9 feet of full-width load length and 191 cubic feet of space accommodate king-size cargoes inside the Corvair 95 Corvan, with 4½ feet of head room for easy cargo handling.

**DRIVER'S UP FRONT...
ENGINE'S IN THE REAR...**

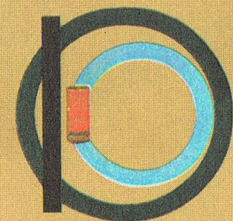
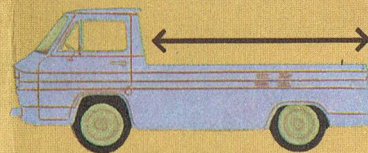
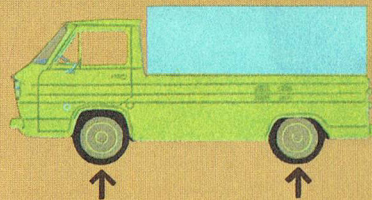
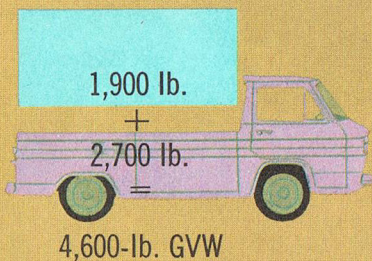
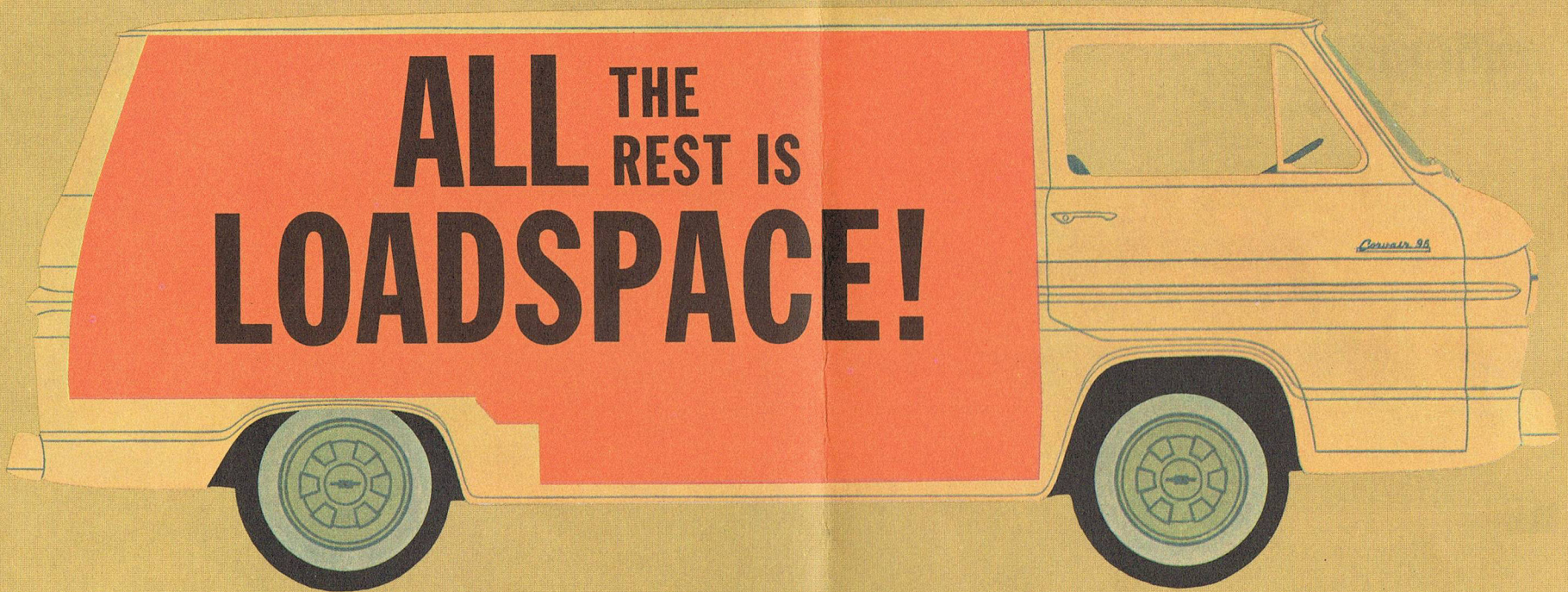

Exceptional payload capacity stems from rugged lightweight construction, with a tough build that carries a full 4,600-lb. GVW rating and a curb weight of only 2,700 to 2,800 lbs. The difference is all payload allowance, 1,900 lbs. in Corvair 95 pickups, 1,800 in the Corvan.

Near-ideal weight distribution boosts payload capacity and keeps ride and handling always at their best. With the bulk of the cargo space approximately centered over the wheelbase, vehicle weight stays nearly equally divided between front and rear, regardless of load.

Efficient forward-control design means maximum loadspace with minimum overall size, for easier handling and extra maneuverability. On an overall-length basis, the Corvair 95 is nearly 60% cargo space, a proportion without precedent in light-duty trucks.

Extra-short 95-inch wheelbase gets the Corvair 95 in and out of tight spots easily, lets you maneuver in feet less space than conventional trucks require. With its turning radius of only 19.5 feet, you can turn around in a 40-foot street and miss the curb by a foot.

CORVAIR 95

LOADSIDE

PICKUP

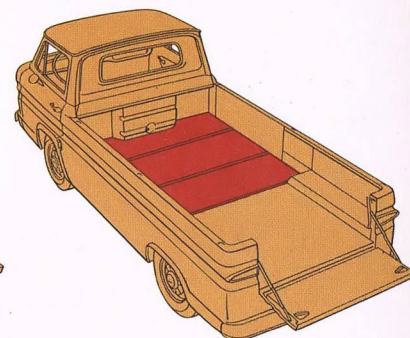
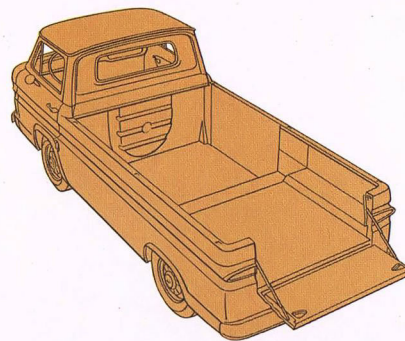

Nearly 28 inches deep, the Loadside's deep-well cargo area accommodates tall, bulky loads with ease. Weight is carried low and amidships for superior handling over the road.

Optional* level load floor extends versatility of deep cargo well, offers tailgate-level loading ease and protected stowage. Sectionalized construction permits partial use for special purposes.

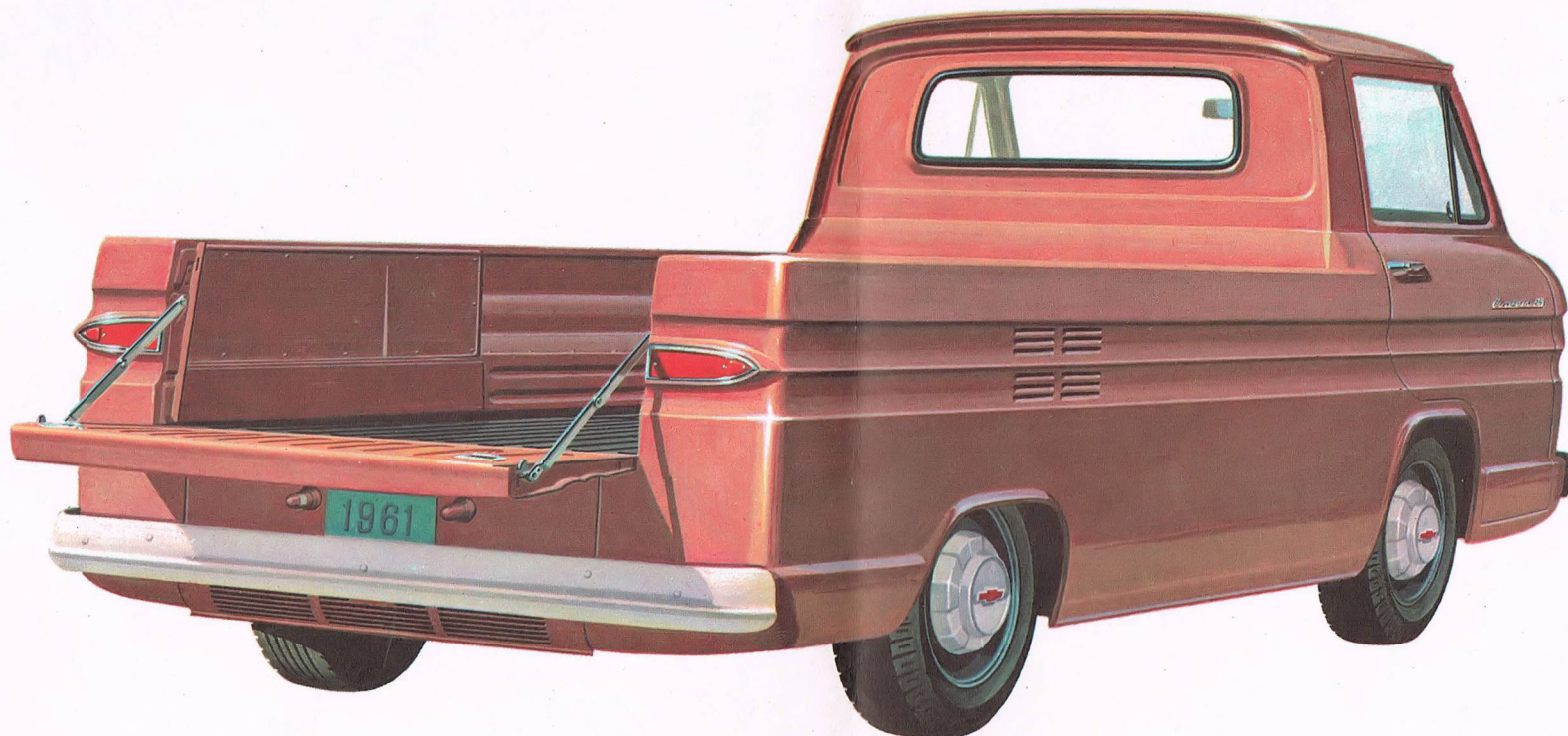

Here's Corvaire 95 convenience and payload performance at lowest cost. The trim-lined Loadside features a roomy, full-width pickup box with 80 cubic feet of cargo space. The deep-well cargo area amidships boosts overall cubic capacity and is extra-handy for hauling bulky objects. *For full-length level load-*

space, an optional three-section floor is available at extra cost. It covers the deep-well cargo space, forming a concealed, protected stowage area. Sections of the floor are individually removable for a variety of special arrangements, including partial use of the cargo well, crew seating accommodations and many more.

CORVAIR 95

CORVAN

PANEL

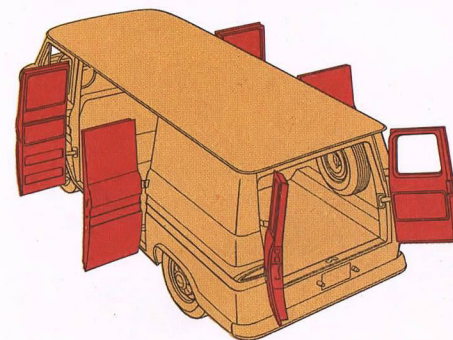

With optional* left-side cargo doors matching those on the right, the Corvan offers outstanding curbside loading and unloading ease on either side of any street.

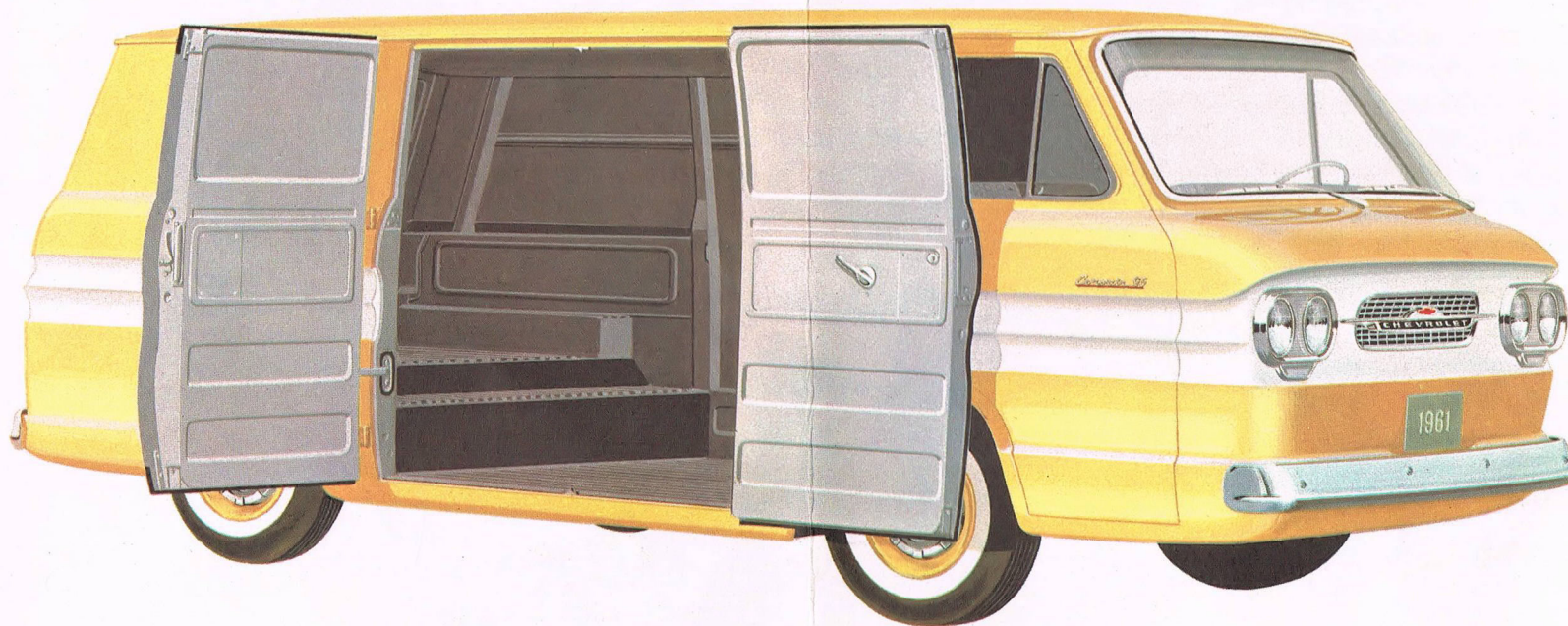

Easy-handling, good-looking and remarkably roomy inside, the Corvan is good news for light-duty delivery van operators everywhere. With 191 cubic feet of cargo space and an unparalleled 1,800-lb. payload capacity, it will outwork most panel trucks with ease and economy. Big right-side double doors

open on a capacious, curb-level load compartment, with 4½ feet of head room for easy cargo handling. Wide-opening double rear doors add still more convenience, plus adaptability to a wide variety of cargoes and handling procedures. Optional* left-side doors make loadspace even more accessible.

CORVAIR 95

RAMP SIDE

PICKUP

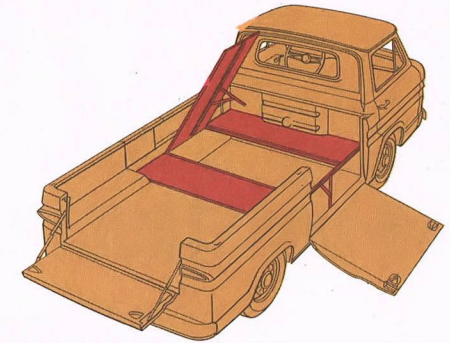

Optional* level load floor is also available for Rampside models, with ramp door offering convenient access to protected sub-floor stowage space.



Here's something new and exclusive in pickups—*cargo-handling ease without precedent in the field!* A rugged-built cargo ramp swings down flush with the floor of the deep-well load compartment, leaving a gateway nearly four feet wide to get big loads in and out without lifting. With the floor less than 14 inches

off the ground, the ramp forms an easy slope when lowered, particularly at curbside. Hand trucks and wheeled equipment can be rolled right aboard, and even objects that can't be rolled are far easier to handle. When closed, the ramp fits flush with the body side, secured by double spring locks plus a safety latch.

UNITIZED

BODY CONSTRUCTION...

*Smaller outside,
bigger inside,
stronger throughout*

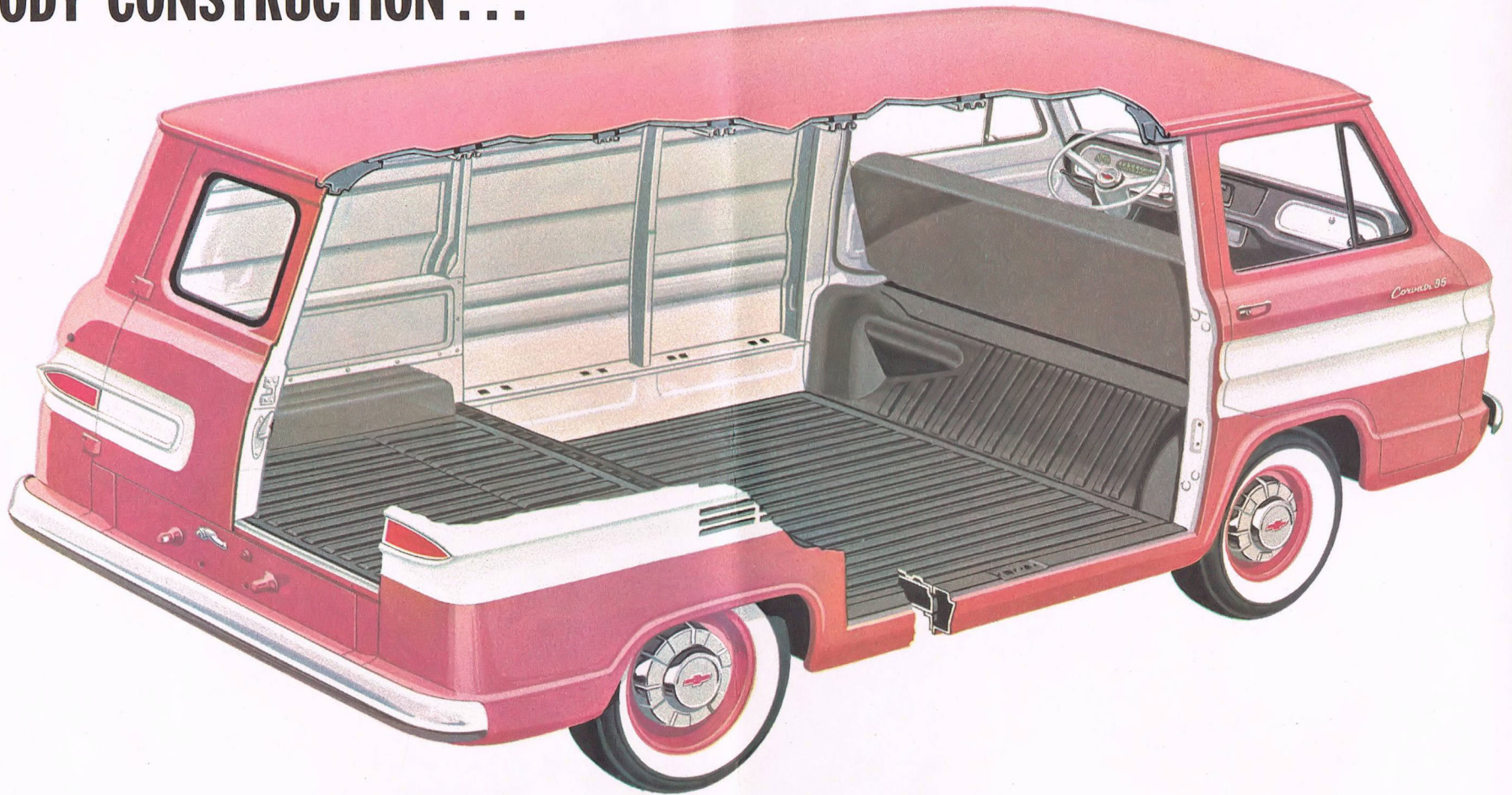

Here's the most efficient package that top cargo capacity ever came in—with high-strength, low-weight construction making the most of the space inside. A super-rigid frame-floor assembly replaces and out-performs the traditional combination of separate chassis frame and body floor. It eliminates the major part of a separate frame's weight and occupies only a fraction of the depth required by the frame-plus-floor combination. Thus, the Corvair 95's drop-center load platform is *less than 14 inches*

off the ground, yet there's plenty of clearance below for excellent all-around maneuverability. All-steel, all-welded front, side and roof panels complete and strengthen the structure. Maximum strength is engineered into minimum depth for extra space inside. The big saving in weight that results from unit construction is passed along as extra cargo capacity. It's one of the major reasons the Corvair 95's payload capacity exceeds 40% of gross vehicle weight—a proportion without precedent in this weight class!

FOUR-WHEEL INDEPENDENT SUSPENSION

Heavy-gauge boxed-hat-section crossmembers form rigid foundations for front and rear suspension assemblies. Assemblies are unit-built and structurally self-contained for lasting precision and maximum shock isolation. Four-point mounting of rear suspension unit on body-frame is completely rubber cushioned.

Each rear wheel is carried on an individual control arm, with its axle shaft universal-jointed to the final drive of the Unipack power team. Swept-back control arm mounting results in controlled toe-in action for extra stability on the road.

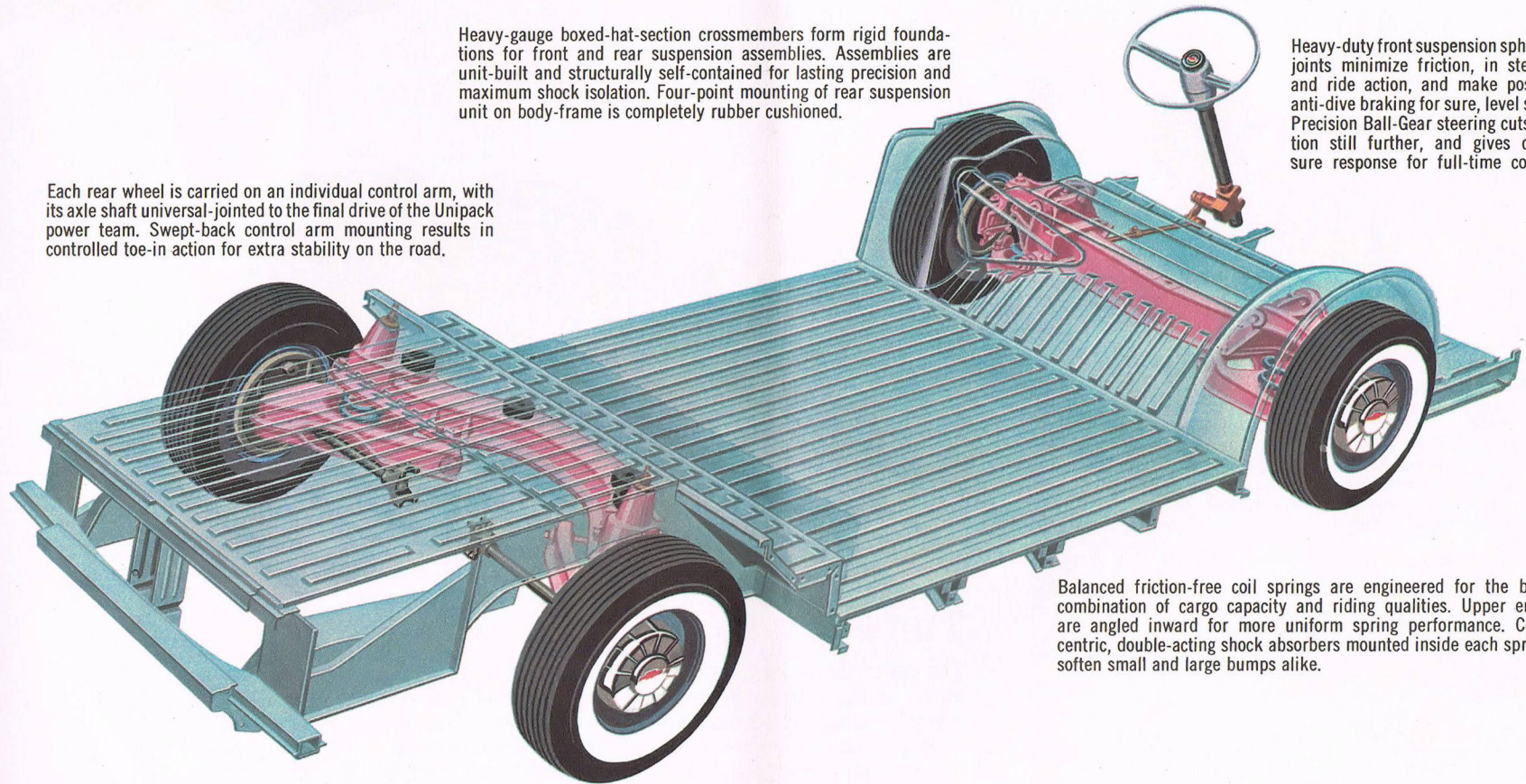

Heavy-duty front suspension spherical joints minimize friction, in steering and ride action, and make possible anti-dive braking for sure, level stops. Precision Ball-Gear steering cuts friction still further, and gives quick, sure response for full-time control.

Balanced friction-free coil springs are engineered for the best combination of cargo capacity and riding qualities. Upper ends are angled inward for more uniform spring performance. Concentric, double-acting shock absorbers mounted inside each spring soften small and large bumps alike.

The Corvair 95 fully independent suspension system brings matchless ride and handling to light-duty truck design, coupled with truck-engineered load capacity and durability. Precise control of each wheel's action results in exceptional engineered-in roadability, for sure-footed performance on any road. Front and rear suspension assemblies are built up on rugged boxed-hat-section beams, which give broad-based support to the body frame-floor assembly. Friction-free coil springs at all four

wheels feature top load capacity plus smooth, easy ride.

Independent rear suspension eliminates much of the weight of a conventional rear axle. Short, universal-jointed axle shafts, needing no heavy housing, connect the wheels with the final drive gearing. With the final drive itself forming a part of the Unipack power team, its weight is carried by the springs rather than adding to the unsprung weight of the wheels, so it helps to smooth out the bumps of the road instead of magnifying them.

CORVAIR 95

UNIPACK

POWER TEAM

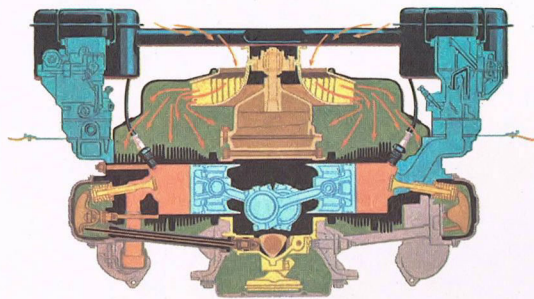

FORCED-AIR COOLING controls engine temperature efficiently and directly, without the intermediate stage of a liquid coolant which must be air-cooled in a radiator. A high-capacity blower blasts cooling air between cylinder barrels and through passages in the heads, where it picks up heat directly from deep, efficient cooling fins. A thermostatically controlled ring damper governs the air supply to the blower, speeding engine warmup and stabilizing operating temperature automatically.

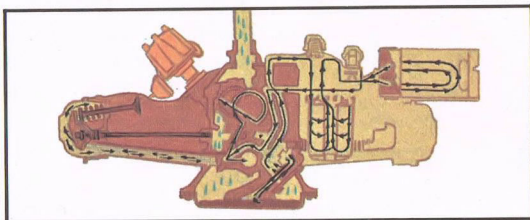

FULL-PRESSURE LUBRICATION SYSTEM includes full-flow oil filter and oil cooler as standard equipment. An automatic filter bypass valve assures full oil circulation under all conditions, and the cooler is bypassed at low temperatures for faster warmup. Oil refill capacity is an economical four quarts.

PRECISION-CAST ALUMINUM ALLOY CYLINDER HEADS cap each bank of cylinders, with deep, integral fins for efficient cooling. Alloy-steel valve seat inserts, steel exhaust ports and cast iron valve guides prolong engine life. Wedge-type combustion chambers with 8.0 to 1 compression ratio develop full power on regular-grade fuel.

It's the most dramatic automotive development in decades, combining a totally new engine and transaxle drive unit into a remarkably compact, lightweight power package! Never has power been developed and delivered to the wheels more efficiently and directly. It's the final result of an all-out engineering effort to create new dimensions in efficiency, economy, compactness and low weight. And it's the key element in the Corvaire 95's totally new approach to truck design.

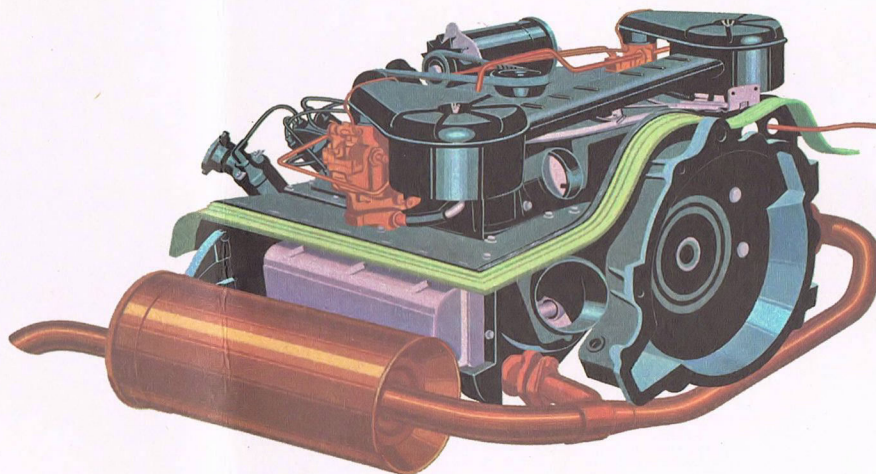
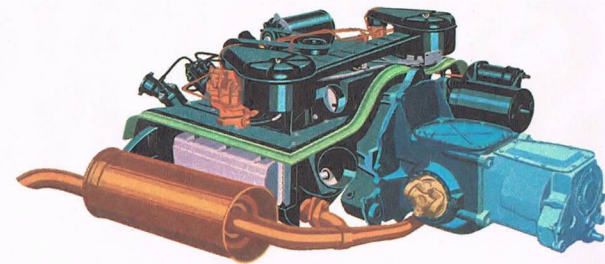

Turbo-Air 6

The years-ahead Turbo-Air 6 was developed expressly to meet the requirements of the Corvaire 95 concept, with a totally new size and shape plus many unprecedented design features. The horizontally opposed cylinder arrangement minimizes both height and length—results in ideal proportions for mounting behind the rear axle and below the load floor. It's also an inherently *balanced* design, saving much of the weight of external balancers and crankshaft counterweights. Rugged aluminum crankcase and head castings, and cast iron cylinder barrels, form an extremely rigid structure of minimum weight. Iron and steel are also used at other stress and wear points for maximum durability.

Forced-air cooling plays a major part in the engine's low-weight design, eliminating water jacketing, radiator, water pump, hoses and coolant. Eliminated, also, are the leaking, boiling, and freezing problems of liquid cooling. Highly developed short-stroke valve-in-head design delivers 80 hp. and 128 ft.-lb. of torque—ample for the Corvaire 95's gross vehicle weight, though the Turbo-Air 6 weighs little more than half as much as a conventional 6-cylinder engine.



Drive coupling

Power is delivered to the Corvair 95 gear train through a clutch or Powerglide torque converter at the front end of the engine. The clutch, included with Synchro-Mesh transmissions, is a 9-inch diaphragm-spring unit, tailored to handle the peak torque of the Turbo-Air 6. The torque converter of the special Corvair 95 Powerglide unit fits into the same space as the conventional clutch and flywheel.

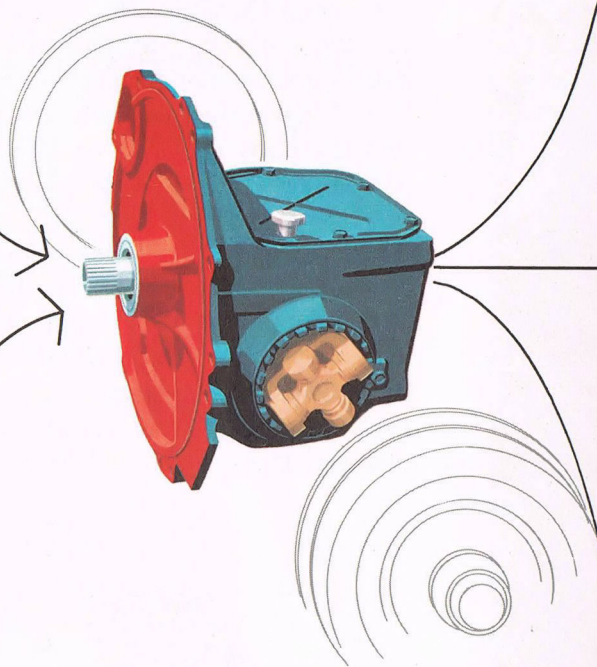

Final drive

The Corvair 95 final drive unit, located between clutch and transmission, houses rear axle gears and delivers power to the axle shafts on either side. The final drive pinion features deep-offset hypoid mounting, straddle-supported in the big bearings at each end of the case. The pinion shaft is hollow, allowing coaxial transmission input shafts to pass through from clutch or torque converter to gear train.

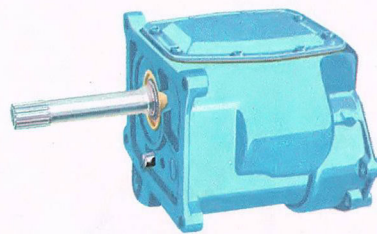

3-speed synchro-mesh

The standard Corvair 95 transmission combines exceptional compactness with quiet operation and long life. Input and output shafts are coaxial, and the output connected directly to the final drive pinion. High gear is therefore direct-coupled, eliminating gear noise and tooth wear. Crisp, positive floor shift lever puts sure control at the driver's fingertips.

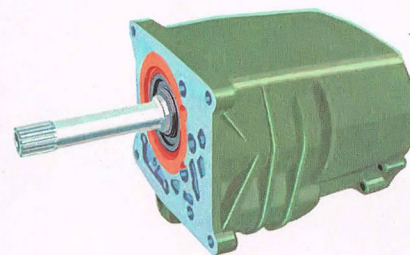

4-speed synchro-mesh

For wide-range versatility to meet all types of driving situations, Corvair 95 models are available with a super-smooth Chevrolet 4-speed Synchro-Mesh transmission, optional at extra cost. All forward speeds are synchronized for quiet, clash-free shifting. Input and output shafts are coaxial and high gear direct-coupled, for long life and minimum gear noise.

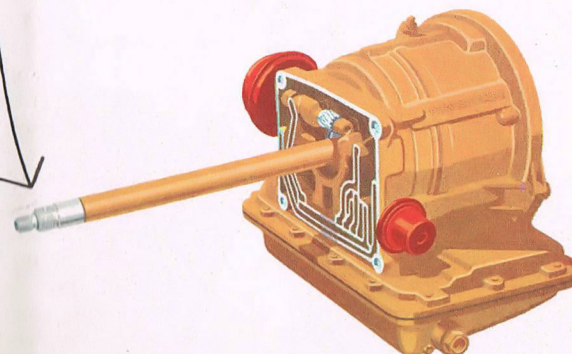

Powerglide

Also available at extra cost in all Corvair 95 models is a special version of the famous Chevrolet Powerglide automatic transmission, tailored to rigid size and weight limits for the Corvair 95 installation. Power flow through coaxial shafts results in maximum compactness plus direct-drive coupling advantages. Range selector quadrant is mounted on instrument panel.

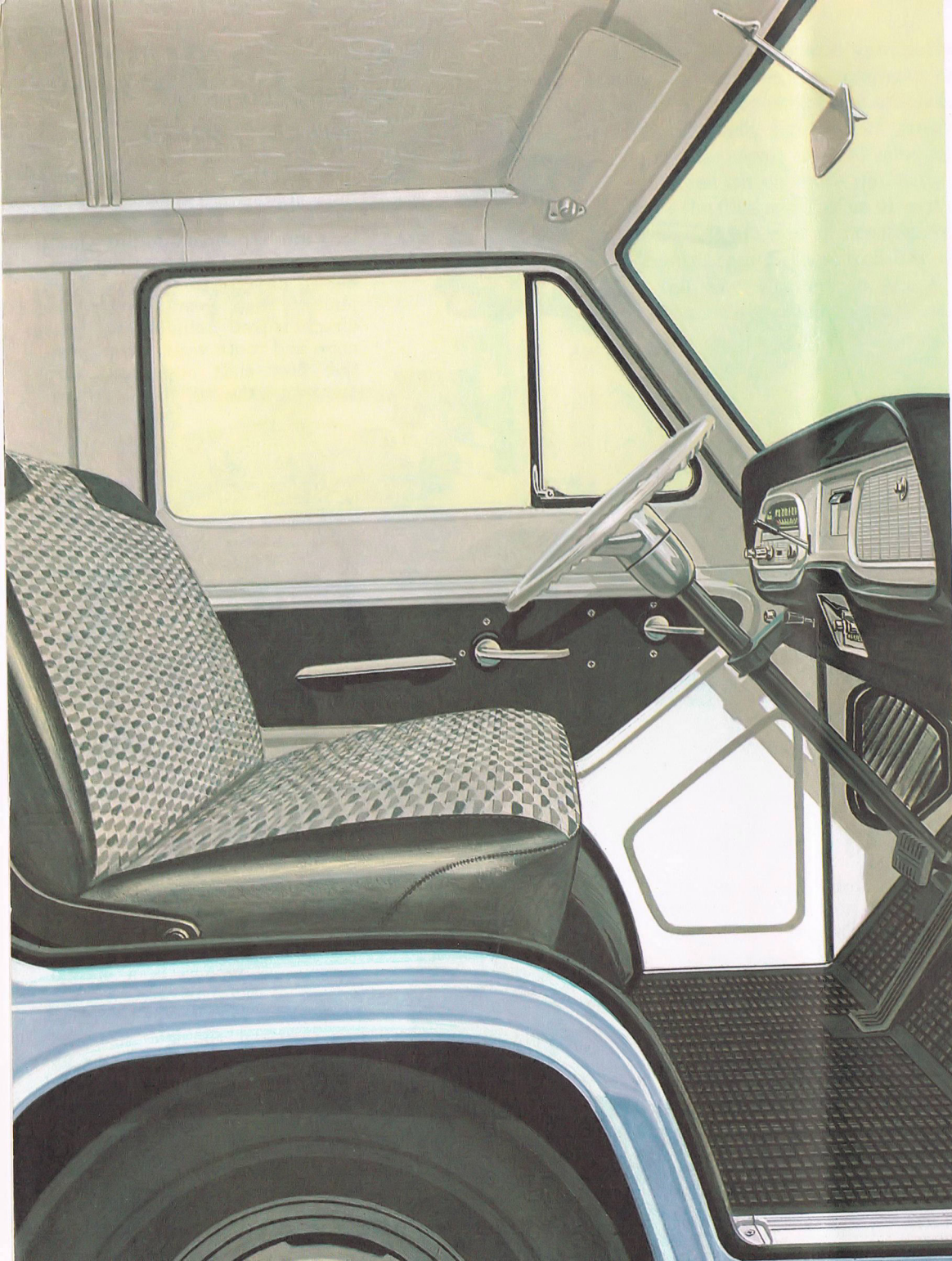

THE CORVAIRE 95 CAB

Long hours on tough delivery schedules are easier in a Corvaire 95, thanks to roomy cab dimensions, flat, full-width floor and absence of engine heat and noise. Big doorways are proportioned for easy entry and exit. Deep-cushioned seats are thickly foam padded and trimmed in long-wearing, good-looking fabrics and vinyls. Custom interior equipment* (illustrated), includes contrasting upholstery with tough nylon-faced fabric over extra-thick foam cushions, plus two-tone door and instrument panels, right-hand sunshade, left-hand armrest, cigar lighter and bright instrument panel trim. Exterior accents, consisting of bright metal windshield reveal moldings and tailgate or rear door ornamental inserts, are also included in the Custom Equipment option.



Corvaire 95 seats are built on Chevrolet's steady-riding combination spring frame design, with S-wire, coil and flat spring elements combined to bring out the best features of each type. Thick foam cushions top the springs in the De Luxe seat (illustrated) and an extra-thick foam seat cushion plus a foam backrest cushion are included with the Custom option.* Standard seat in the Corvan is single-width, for driver only, with a full-width seat optional at extra cost.

*Optional at extra cost.

DIMENSIONS

PANEL MODEL

Side Door Opening
Height 49
Width 53½

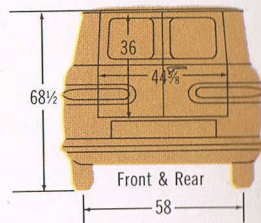
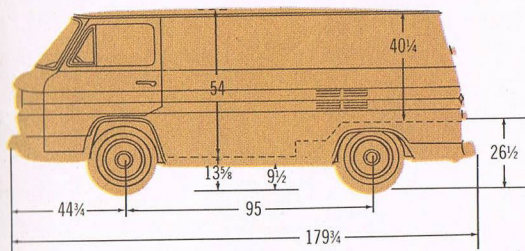
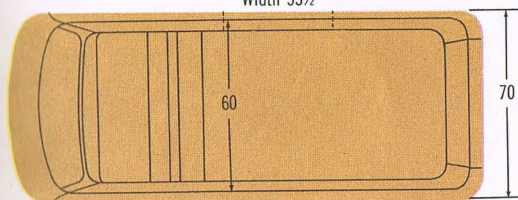

PICKUP MODELS

Ramp Door Opening
47½

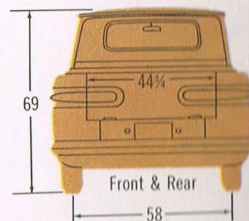
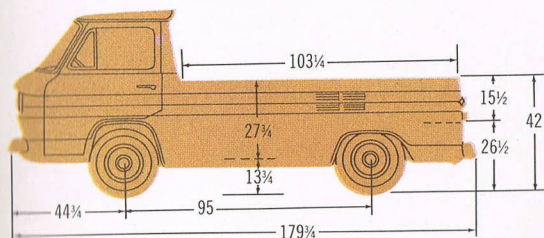
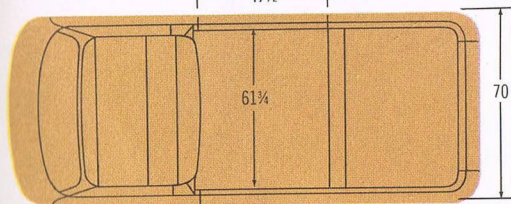

SPECIFICATIONS

STANDARD EQUIPMENT

AXLE, REAR: Ratio 3.89.
BRAKES: Hydraulic, front & rear 11" x 2"; lining area 167 sq. in.
CLUTCH: 9½" diameter.
DIRECTIONAL SIGNALS: Front & rear.
ENGINE: Turbo-Air Six; 80 hp; 145-cu-in displacement.
FUEL TANK: Capacity 18½ gallons.
GVW: 4,600 lb. maximum.
SPRINGS, FRONT: Coil, capacity 1,150 lb. each.
SPRINGS, REAR: Coil, capacity 1,150 lb. each.
STEERING: Ball-gear, ratio 20.0.
SUSPENSION, FRONT: Independent, capacity 2,500 lb.
SUSPENSION, REAR: Independent, capacity 2,500 lb.
TIRES: Five tubeless 7.00-14/4PR.
TRANSMISSION: 3-speed synchro-mesh.
WINDSHIELD WIPERS: Dual electric; single-speed.

OPTIONAL EQUIPMENT*

BUMPERS, CHROMED: Front & rear.
CUSTOM EQUIPMENT: Interior and exterior appearance, comfort and convenience features.
DOORS, BODY: Left side for Corvan model.
FLOOR, LEVEL PICKUP BOX: Pickups only.
HEATER & DEFROSTER: Gasoline operated or direct air.
HUB CAPS, CHROMED.
PAINT, TWO-TONE EXTERIOR: Choice of 14 combinations.
RADIO: Manual.
SEAT: Full-width front for Corvan model.
TIRES: 7.00-14/4PR whitewall; 7.00-14/6PR blackwall or whitewall.
TRANSMISSIONS: 4-speed synchro-mesh (includes 3.27 rear axle ratio); Powerglide.
WINDSHIELD WIPERS: 2-speed electric (includes washers).

*Extra cost.

CHEVROLET DEALER INSTALLED CUSTOM FEATURES

In addition to the many factory options available, Chevy also offers a full line of dealer installed custom features for extra comfort, convenience, and safety on the job. Here is a list of some of these high-quality custom features:

Bumper guards	Heaters	Radio	Sun visors
Cigar lighter	Mirrors	Reflectors	Tool kit
Clock	Parking brake	Seat belts	Windshield
Compass	signal	Spot lamp	washers

All illustrations and specifications contained in this literature are based on the latest product information available at the time of publication. The right is reserved to make changes at any time in prices, colors, materials, equipment, specifications and models, and also to discontinue models. **CHEVROLET MOTOR DIVISION OF GENERAL MOTORS CORPORATION, DETROIT 2, MICHIGAN**

CHEVROLET TRUCKS

1961

worth more because they work more!

