

# CHEVROLET TRUCKS FOR



1

TOUGH

9

LEAN

6

BUILT FOR BUSINESS

3



# FOREWORD

Chevrolet again paces the field with its 1963 line-up of *tough, lean and built-for-business* trucks.

From the good-looking but hard-working Corvair 95's, with their improved efficiency and performance, to the *Trimline Styling* of the mediums and heavies, Chevrolet maintains its long tradition of building trucks that are best matched to America's trucking needs.

Two brand-new engines, maintenance-saving refinements on Corvair 95's, I-beam, variable-rate front suspensions on medium- and heavy-duties, plus narrower sheet metal and front tread are but a few of the features of a truck line-up that's *built for business!*

This book contains information about all important 1963 Chevrolet Truck features and improvements —from styling to specifications. It is designed to provide valuable sales information at a glance.



**CHEVROLET**

## CONTENTS

Model Line-up .....	1	MEDIUM- AND HEAVY-DUTY FEATURES .....	11
STYLING — EXTERIOR		Frames .....	12
General .....	2	Suspensions .....	12
Trimline Styling .....	3	Steering .....	13
Convenience Features .....	3	Engines .....	13
Corvair 95's .....	4	Transmissions .....	15
STYLING — INTERIOR .....	4	Brakes (Bus) .....	16
LIGHT-DUTY FEATURES .....	5	OPTION IDENTIFICATION SYSTEM .....	16
Engines .....	5	THE CHEVROLET DIESEL STORY .....	17
Transmissions and Rear Axles .....	7	Diesel Load-Pulling Chart .....	17
Frames .....	8	Diesel Load-Carrying Chart .....	17
Suspensions .....	8	Load-Carrying Chart (Light-Duty) .....	18
Steering .....	9	Load-Carrying Chart (Medium- and Heavy-Duty) .....	19
Brakes .....	9	Load-Pulling Chart (Gasoline Engines) .....	20
Corvair 95's .....	9	Custom Feature Accessories .....	21
Step-Vans .....	10		

# 1963 CHEVROLET TRUCKS... TOUGH, LEAN — BUILT FOR BUSINESS



## LIGHT-DUTIES

There are 59 light-duties—regular pickups, chassis-cabs, panels, Four-Wheel-Drive models, stakes, Step-Vans and the Corvair 95 Rampside Pickup and Corvan. Here is a line-up designed to meet every conceivable need of America's light-duty operators.



## MEDIUM-DUTIES

For medium-duty work, 73 models are available in Series 50 and 60, including conventional, LCF and tilt cabs, stakes and cowl models. The former 40 and 50 Series have been combined into a new Series 50 featuring ladder-type frames and 20-inch wheels. Three new Series 60 LCF models with 169-inch wheelbases have been added for broader market coverage.



## HEAVY-DUTIES

For the best in the bigger truck business, 46 heavy-duty models are available in Series 60-H and 80. Each model fills an important need in the fast-growing heavy-duty market. Each model is a real sales opportunity for every Chevrolet salesman.

# EXTERIOR STYLING



Distinctive, new radiator grilles for Series 10 through 30 regular light-duty trucks have a business look with real prospect appeal. The Cameo White grille assembly and Jet Black lettering highlight an attractive, practical grille design.



The new Custom Grille is made of corrosion-resistant silver-anodized aluminum. Neither weather nor wear can affect its beauty and durability.



Regular truck models feature brand-new relocated series plates. Distinctive satin, bright chrome and red-paint finishes accent the series number and emblem.



All light-duty models come equipped with new contrasting amber front parking and directional signal light lenses. These new lenses provide greater visibility, day or night.

# NEW TRIMLINE STYLING



The ruggedness and brawn of Chevrolet's trucks for 1963 are highlighted by the "Trimline Styling" of the medium- and heavy-duties. On most 50 through 80 Series models, Trimline Styling provides the improved tight-spot handling requested by Chevrolet dealers, salesmen and truck operators. In congested traffic, in woods or wherever clearance is measured in inches, new Trimline Styling means greater maneuverability and easier handling. This is a result of *7.2 inches narrower front width* for Series 50 through 80 conventional, diesel and tandem models equipped with regular-production 4,000- through 7,000-pound front suspensions. Nearly all medium- and heavy-duty prospects will profit from this service as, *last year, conventional cab models accounted for 91% of all Chevrolet sales in Series 50 through 80 models.* Tilt cabs, LCF cabs and models equipped with optional 9,000- or 11,000-pound front suspensions have unchanged front dimensions. Still another benefit from new Trimline Styling is *narrower front tread width.* Front treads are up to 7 inches narrower on conventional models with 4,000- through 7,000-pound front suspensions. This feature provides substantial tracking advantages. This is important off the highway or wherever heavy truck travel is restricted to narrow, rutty roads.

## DRIVER CONVENIENCE

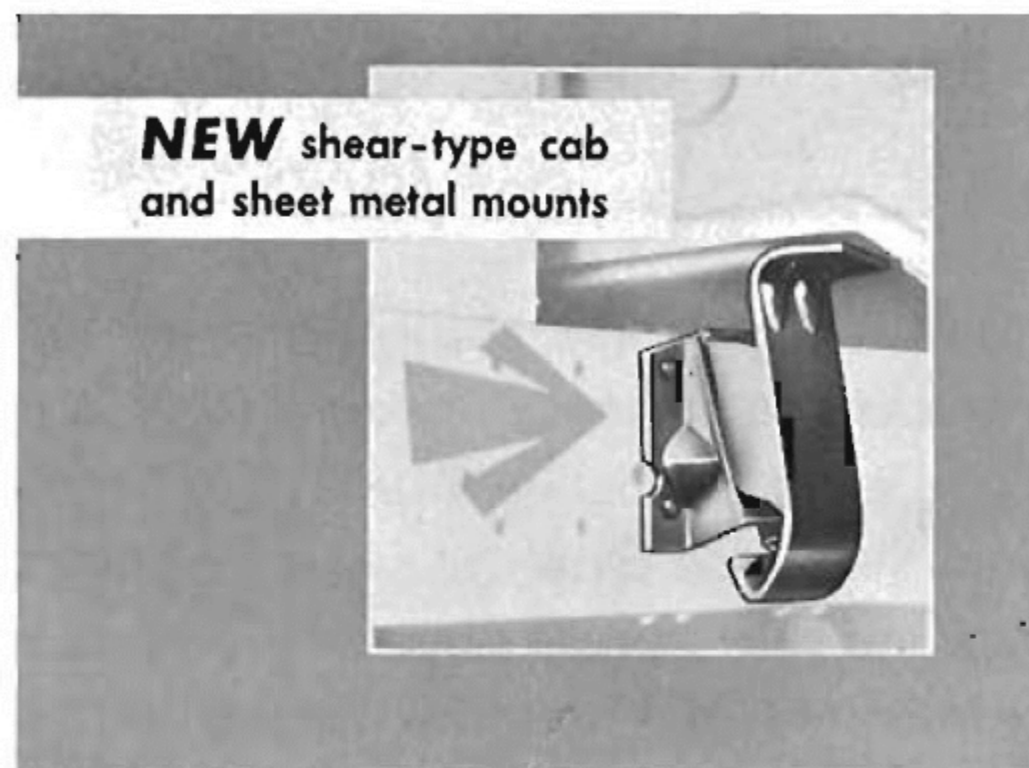

For more comfort, Chevrolet Trucks are first in the industry with new *shear-type rear cab and front sheet metal mounts* which cushion the cab and driver from fatiguing and destructive vibrations. On E80 Diesels, cab improvements include the addition of 20 body reinforcements, plus new shackle-type rear cab mounts and a flexible hood panel mounting.

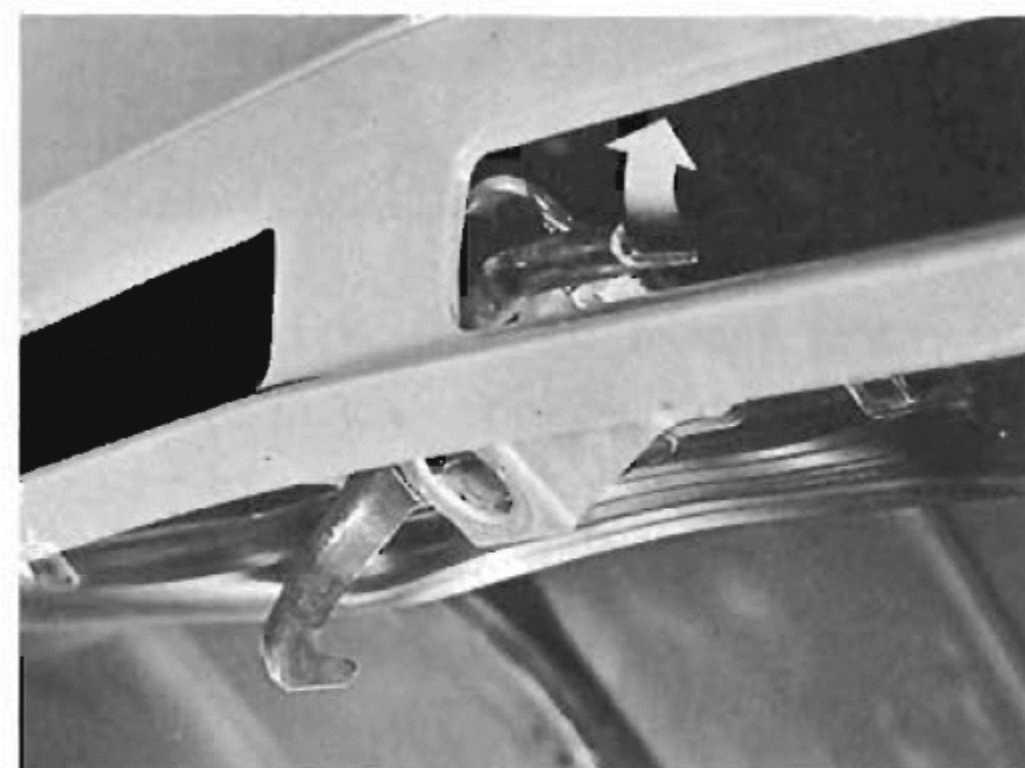

Hoods open easier than ever. On conventional models, a new hood lock releases the hood with one simple outward pull. This is but one of many examples of why Chevrolet leads in safety and convenience, as well as comfort.

**DELCO TRON**—A Delcotron diode-rectified alternating-current generator is standard this year on every Chevrolet Truck, except Corvair 95's and Four-Wheel-Drive models. Delcotrons provide battery-charging current even at idling speeds. Their extra reliability will prove especially valuable in stop-and-go work which involves extended idling time, in night operations or in tough off-road jobs.

# CORVAIR 95



Corvair 95 Series plates are new but their location is unchanged. Bright chrome plus black and red paint emphasize the practical, distinctive look which characterizes all Corvair 95 models.

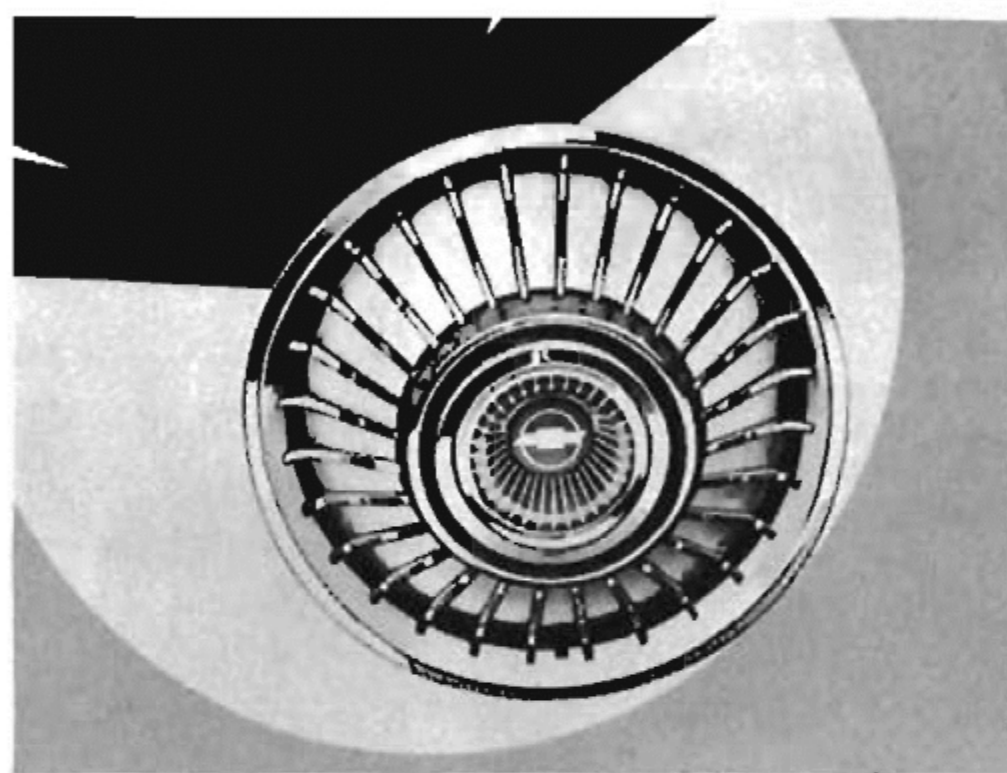

New optional wheel trim discs add eye appeal to the glamorous but hard-working Corvair 95's — spunky lightweights that are saving owners money day in and day out.

## INTERIOR STYLING

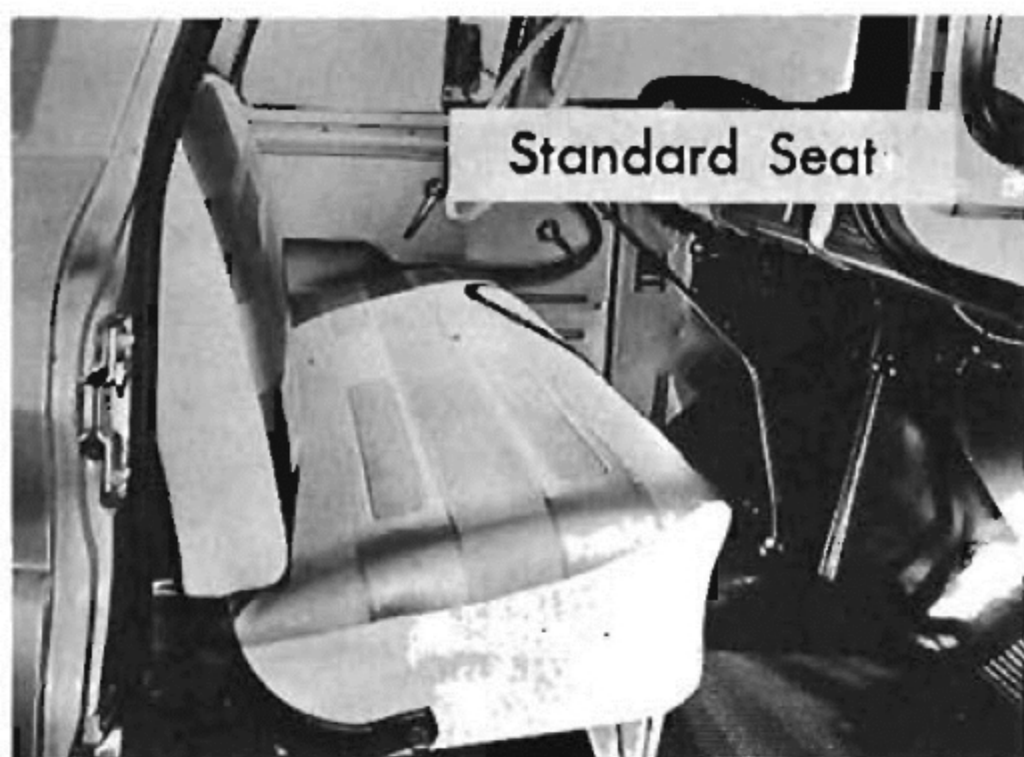

In all Chevrolet Trucks for '63, extra-comfort features remain. Inside the cab, all models have the extra *head-, hip- and shoulder-room* for which Chevrolet Trucks are famous. *Standard seats* in regular and Corvair 95 models are wide, comfortable, practical and more attractive than ever. They feature tough, durable, all-vinyl trim with a distinctive new design. They are available in a combination of medium- and light-fawn colors. Tilt cabs have new fawn interior panel, sunshade and seat trim. *Custom seat trim* for all models again matches and complements the exterior colors. Red facings and bolsters are used with red, gray and white exteriors. Medium fawn facings and bolsters are used with all other exterior colors.

New interior design includes ammeter and oil pressure gauges as standard in all Series 50 and 60 models. These features keep drivers constantly alert to vital operational functions.

The Corvair 95 interior features a new silver-anodized instrument cluster trim plate which enhances practical, standout beauty.

# LIGHT-DUTY PROFIT- AND SALES-MAKERS



Whether it's a chassis-cab, a regular pickup, a panel, a van, a stake, a Four-Wheel-Drive model, a Corvair 95 or a Step-Van, Chevrolet's light-duty truck line-up for 1963 is designed and built to make profit for its owner. Altogether they add up to 59 different models, each providing the utmost in economy, durability, comfort, convenience and styling. It's a line that's solid through and through with performance-packed, thrifty, *new power teams, rugged new frames, husky new suspensions, and new comfort and conveniences.*

## LIGHT-DUTY ENGINES — 4, 6 AND V8 POWER

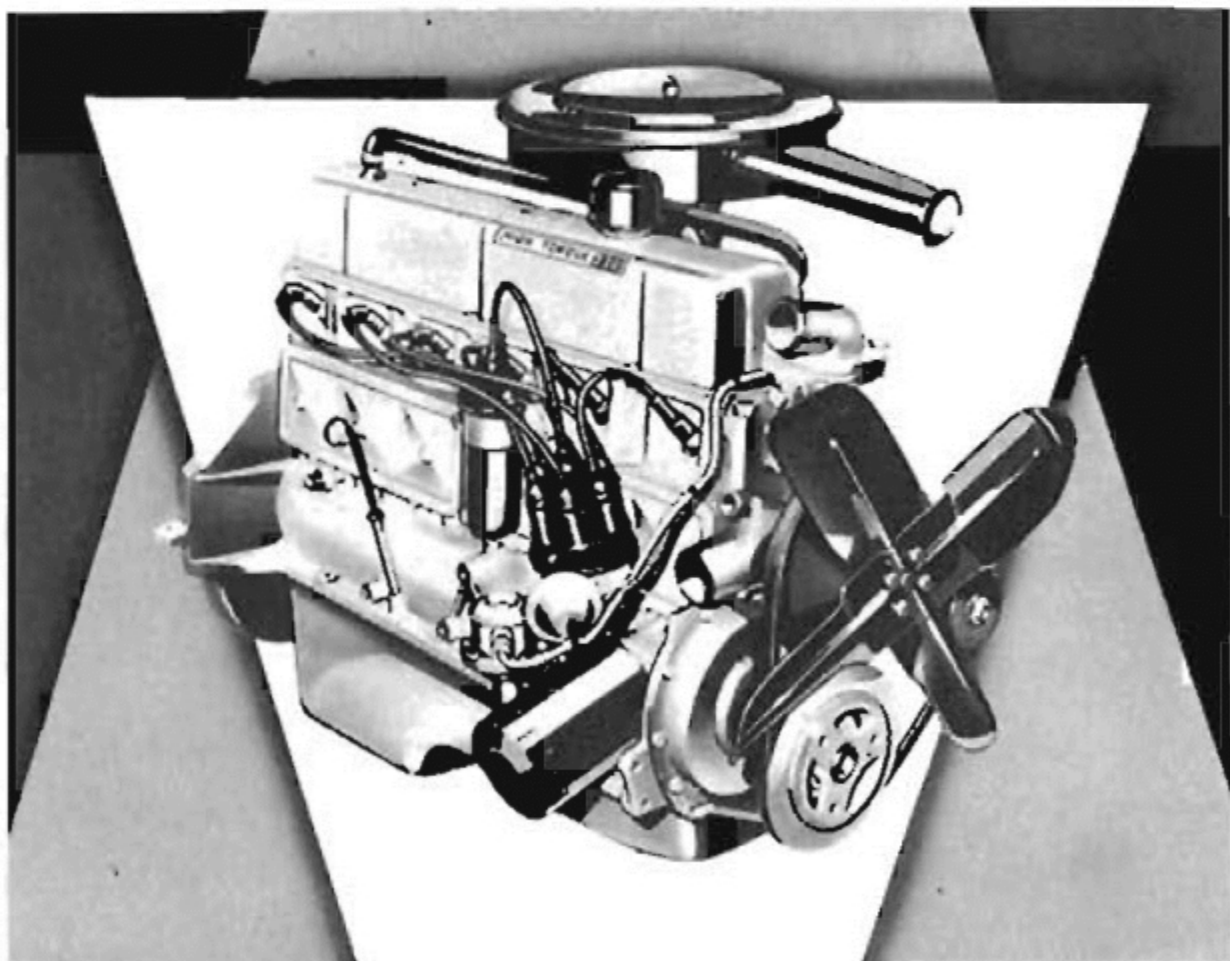

Chevrolet has long been famous for tough, dependable, economical, six-cylinder truck engines which have hauled more loads than any other truck engine in the history of hauling. Now comes a brilliant new 230-cubic inch, six-cylinder engine with all the truck-tough qualities Chevy Sixes have long been noted for. It's new and modern through and through, with extra measures of dependability and economy. It has a maximum 140 h.p. and 220 foot-pounds of torque and is standard in all light-duty, Two-Wheel-Drive models, except Corvair 95's and Step-Van Sevens. The 235-cubic inch six-cylinder is standard on Four-Wheel-Drive models. It, also, is a truck engine through and through.

# LIGHT-DUTIES

Seven main bearings provide extreme crankshaft rigidity and engine durability plus smoother operation and reduced engine noise. Precision steel-backed Babbitt main bearings, tough nodular cast-iron crankshaft, and forged-steel connecting rods are other important truck engine features which contribute to durability and reliability.

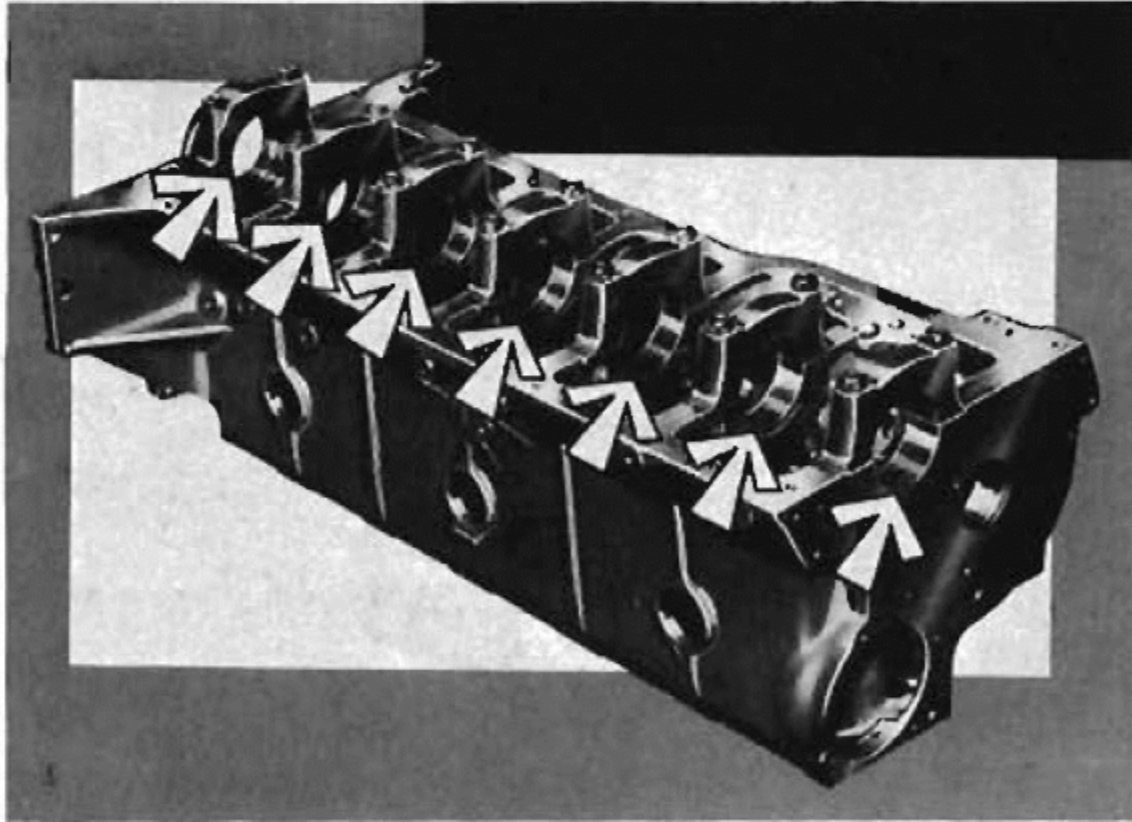

Overhead valve design means positive engine breathing. Hydraulic valve lifters make valve adjustments unnecessary and further contribute to engine quietness. Wedge-shaped combustion chambers provide optimum turbulence for peak operating performance and efficiency. Large inlet valves and short exhaust ports get the fuel-air mixture into, and the exhaust gases out of, the combustion chamber quickly and efficiently. These new design features make this new engine cooler-running while providing better performance and economy.

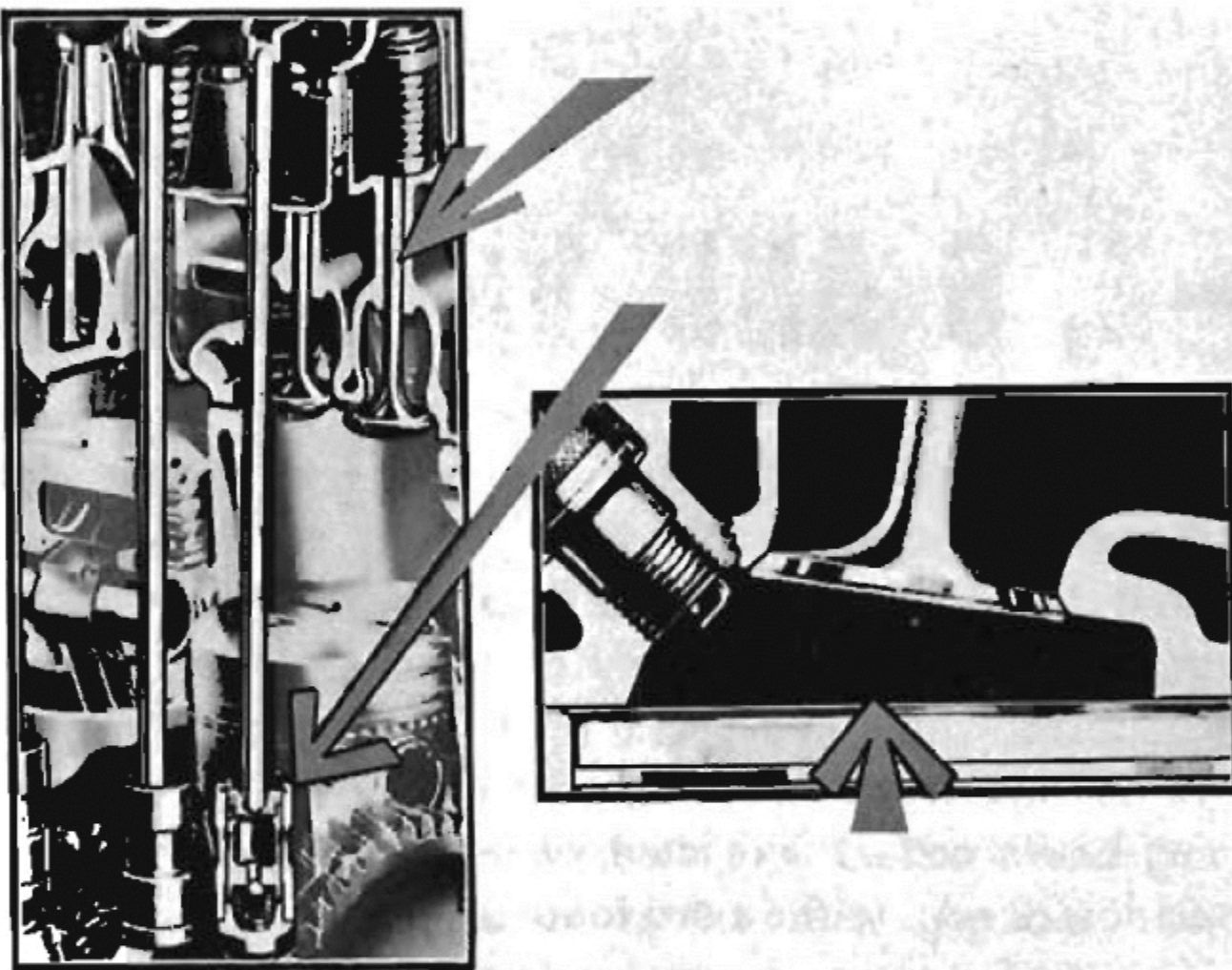

Inlet and exhaust valves are made of high-alloy steel for durability. Integral valve guides make for easy, efficient valve cooling. Full-circle cooling keeps spark plugs operating efficiently and effectively, even at peak loads. Coolant circulates throughout the cast-alloy-iron block. New precision engine-block castings provide faster heat transfer for better cooling. A full-flow throwaway oil filter is standard equipment. It requires less time to replace and filters every drop of engine oil. Dead weight is gone. Only money-making muscle, which can haul extra payload for increased earning potential, is left.

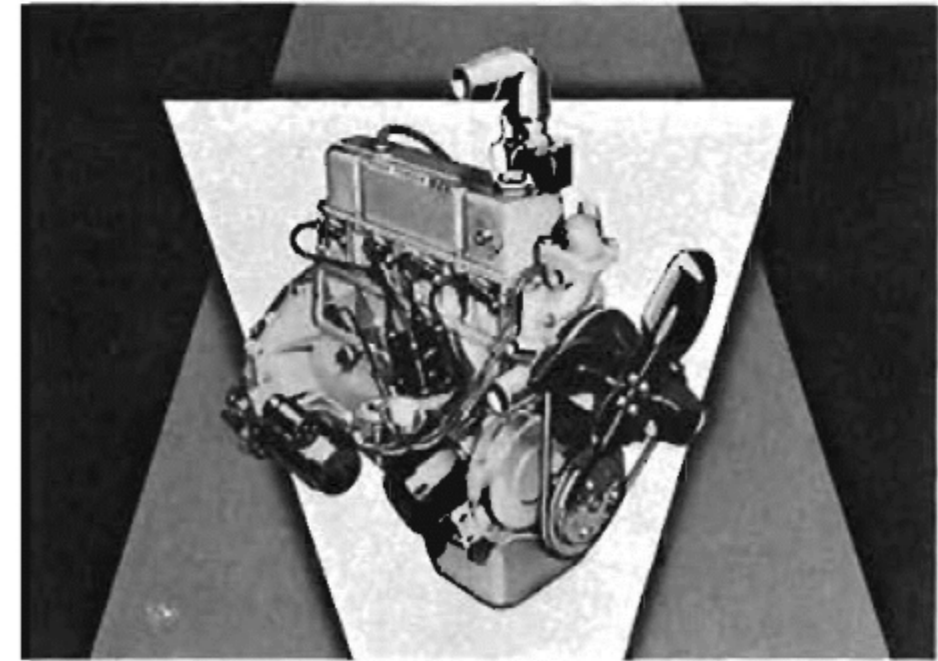

Also new is the 153-cubic inch Four, which develops 90 maximum h.p. and 152 foot-pounds of torque. It is standard, and available only, on the Step-Van Seven. It has nearly all of the features of the 230 Six.

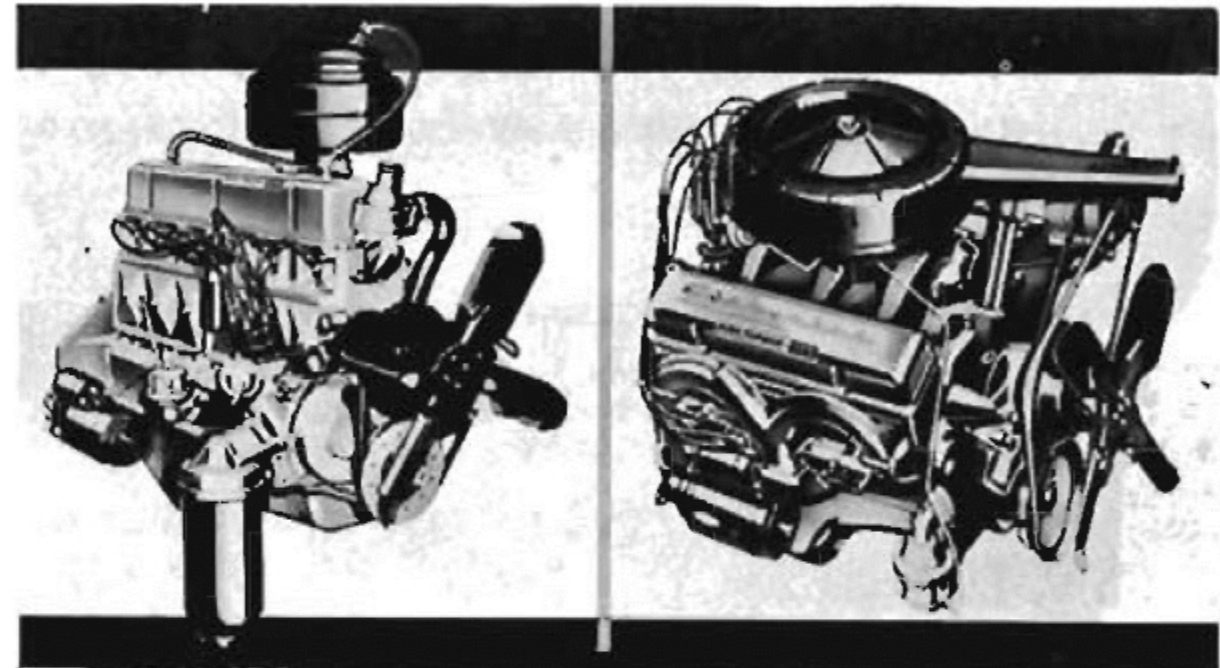

Two optional engines are available on regular light-duty trucks. They are the new 292-cubic inch Six, standard on Series 60 and 60-H, and the improved 283-cubic inch V8 which, with redesigned cylinder heads and increased compression ratio, delivers more horsepower on regular gas.

Improved exhaust systems are standard on all 1963 truck models. They add importantly to durability.



# LIGHT-DUTIES

## POWER TRAINS

Light-duty power trains also have been improved. For example, there's a new mechanical clutch linkage on six-cylinder models, except in Step-Vans and Four-Wheel-Drive models.

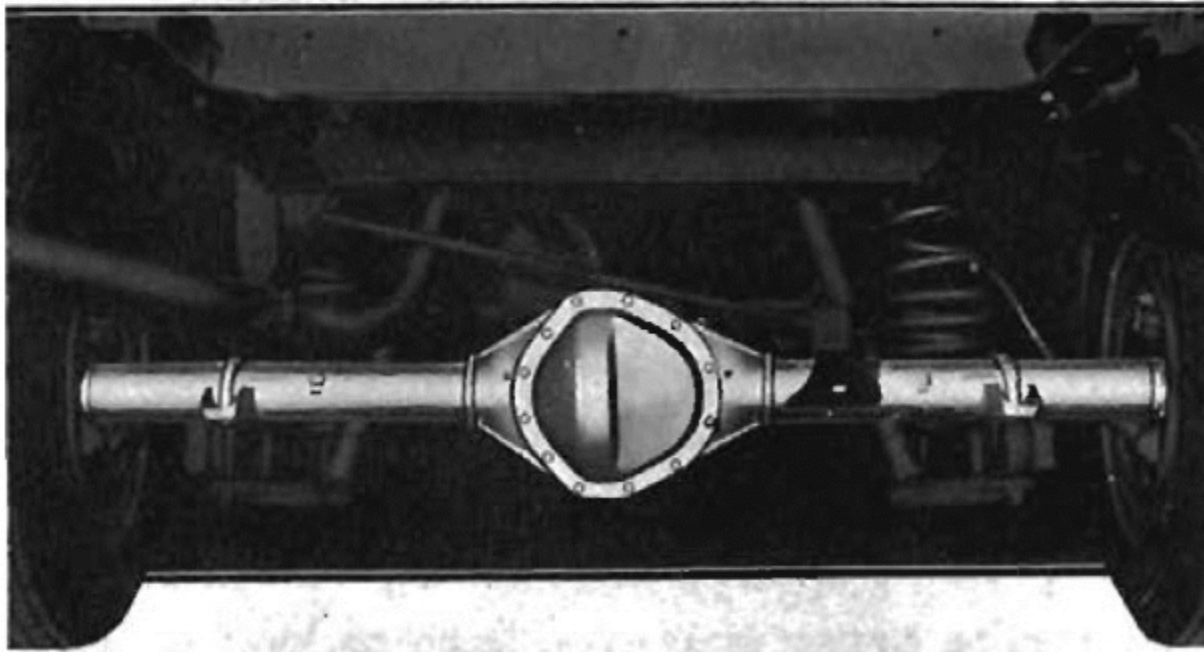

Stronger, quieter *Salisbury-type rear axles* for Two-Wheel-Drive Series 10 models also are new this year. Built-in ribs on the cast differential carriers, combined with steel tube axle shaft housings, provide new rear-end strength and durability.



The Positraction differential is again optional on Two-Wheel-Drive Series 10 and Corvair 95 models. Its *limited-slip* design means sure going in snow or mud, on ice, or any off-road operation where the going is tough or rough. The No-Spin differential is again available optionally on Series C and P, 20 and 30 vehicles. This *full-locking* type differential provides the utmost in rear-wheel traction.

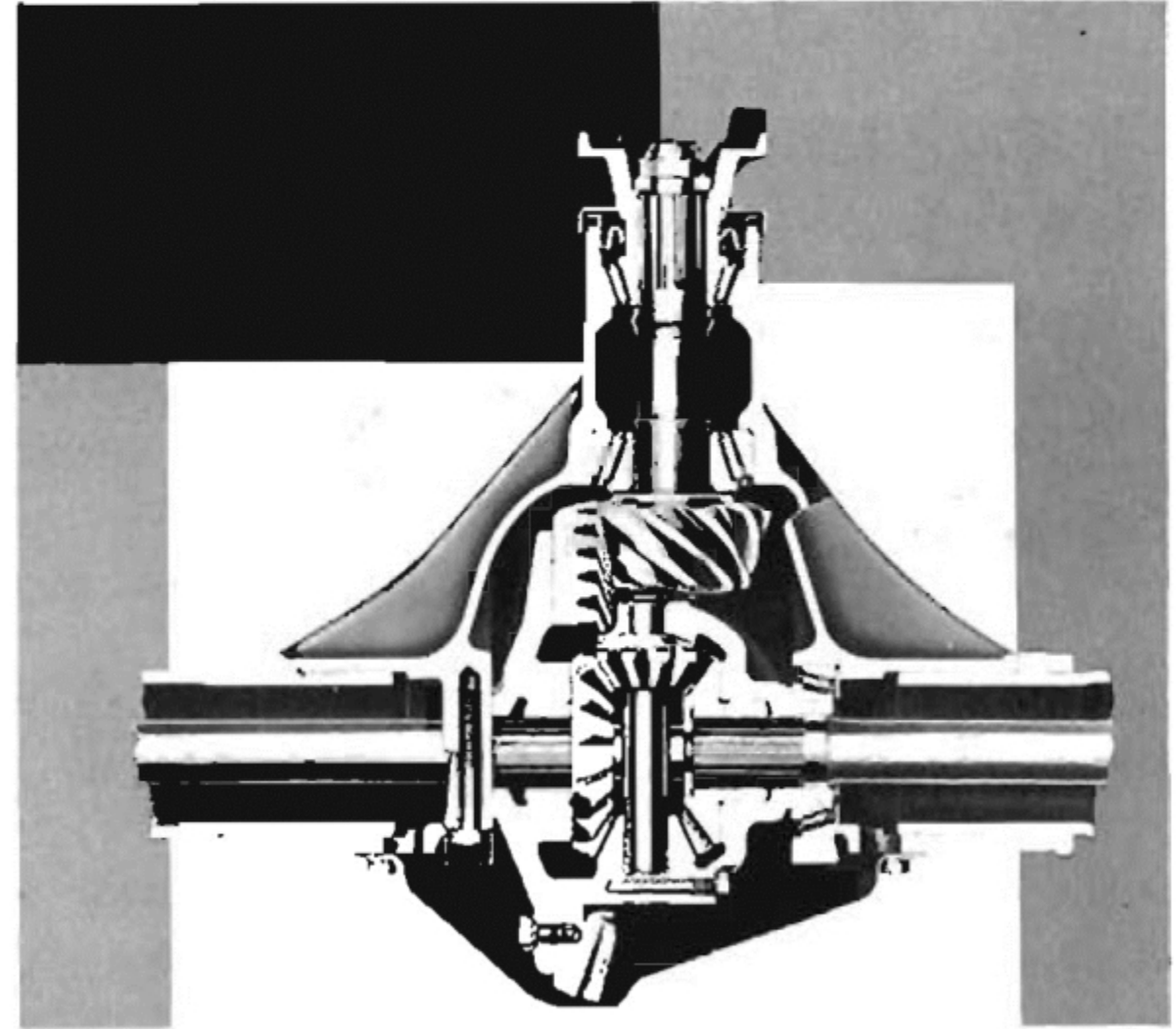

Lower rear axle gear ratios on Two-Wheel-Drive Series 10 models are keyed to the operating characteristics of the new engines, for maximum fuel economy and performance. The standard gear ratio for C10 models is 3.73:1. P10 models use a 4.11:1 ratio.

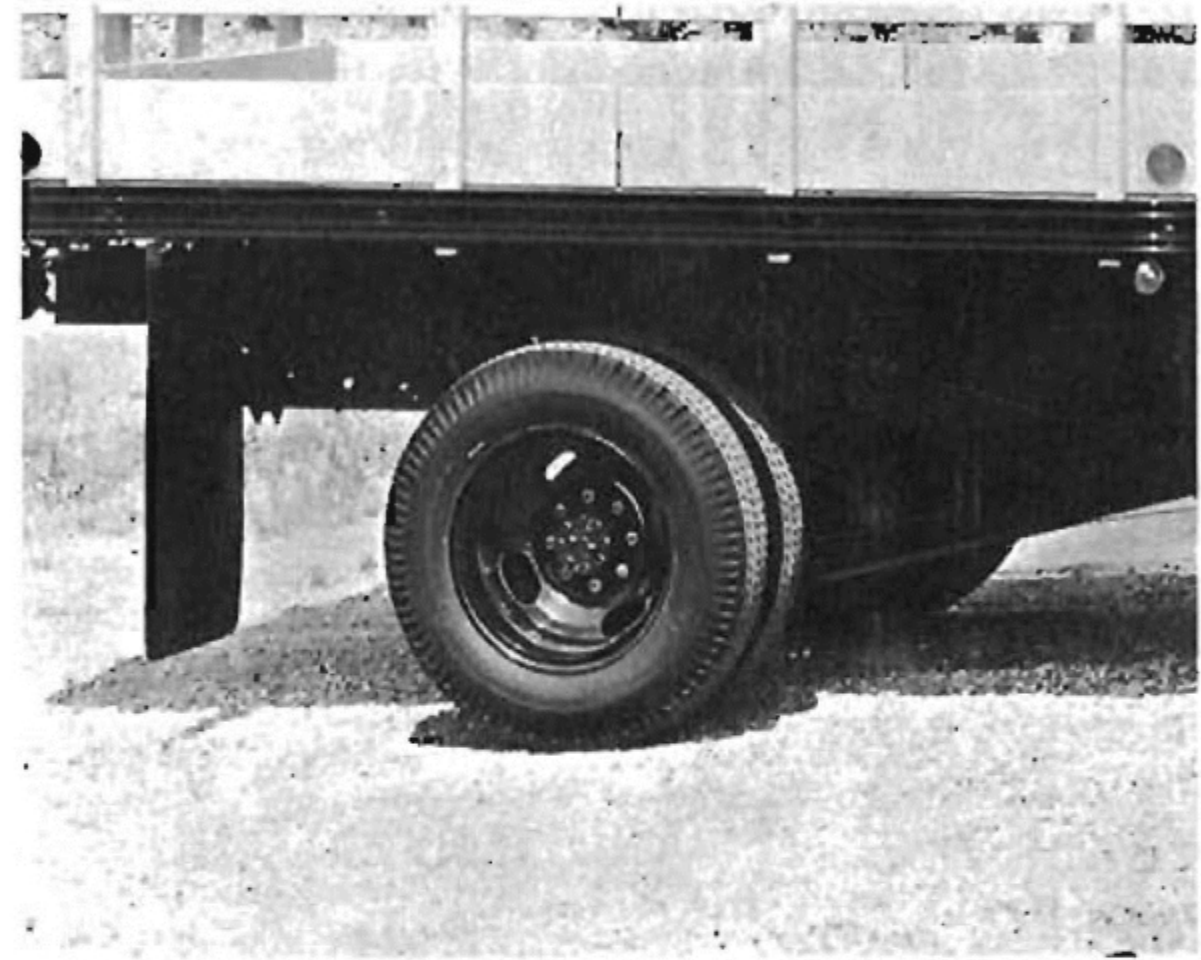

For the first time, 16-inch dual wheels are available on Series 20 models for extra load-carrying capacity, traction, flotation and lower loading height.

# LIGHT-DUTIES

## FRAMES

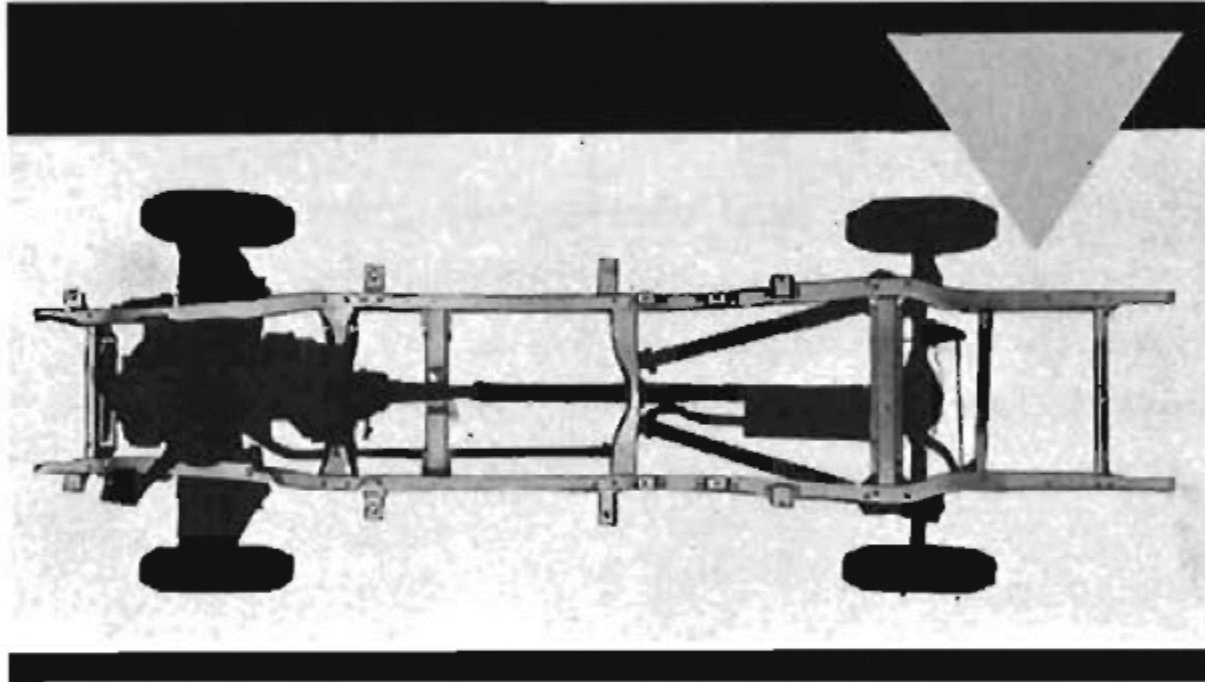

Chevrolet light-duties also have rugged, new frames which provide greater-than-ever strength and durability. More cross members make these new ladder-type frames extra strong and durable. They're riveted together, a feature providing the flexibility required for long, trouble-free life. Heavier-gauge metal makes the siderails stronger. Modified front ends provide a more rigid bumper attachment. Light-duty frames have a uniform 34-inch width. Bodies can now be moved conveniently from one chassis to another. This is a most important sales feature.

## SUSPENSIONS

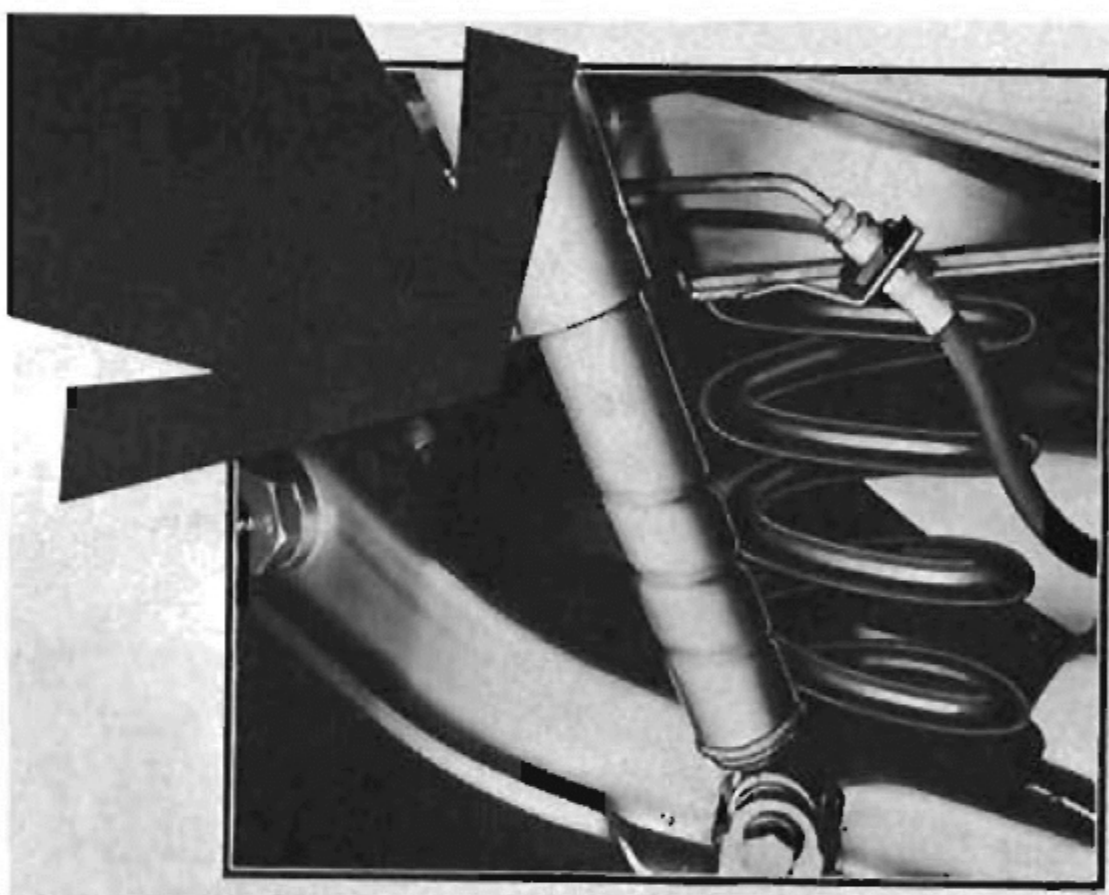

FRONT—Independent front coil springs feature the industry's most advanced light-duty front suspensions, providing top comfort plus increased durability and reduced maintenance. Caster and camber adjustments are made easier. With the improved upper control arm pivot shaft attachment, adjustments also last longer.

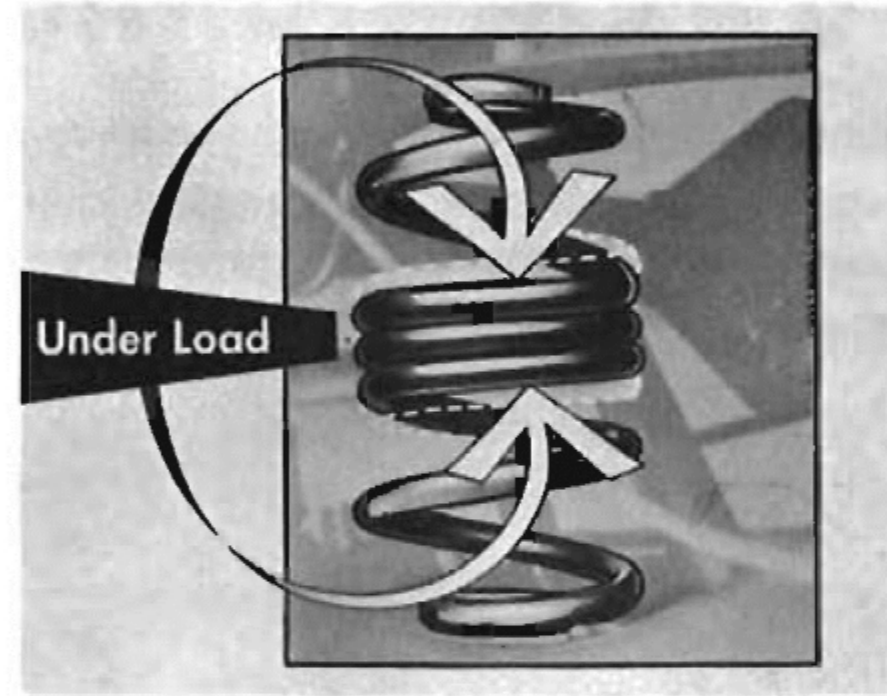

REAR—Light-duty rear suspensions also are new this year—with new, advanced-design two-stage coil springs, standard in Series 10 and 20 Two-Wheel-Drive models. Chevrolet's coil rear springs have proved their outstanding ride, ruggedness and load-carrying ability on the job. Now, with two-stage design, they're better than ever. With no load or light loads, smooth coil-spring action protects driver and cargo, providing a soft ride. Under load, spring characteristics change. The center coils, on coming in contact with each other, become inactive. Spring stiffness increases at an accelerated rate as the load increases, providing increased support, comfort and load-carrying capacity.

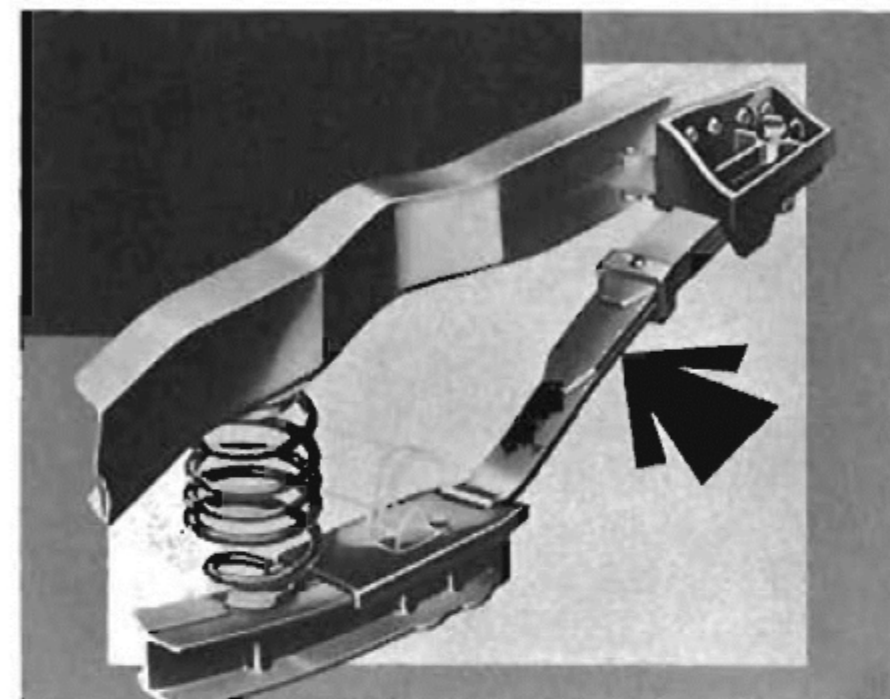

New three-leaf auxiliary springs are available optionally on Series 10 and 20 models. These auxiliary springs do not affect ride and handling characteristics under light loads. Under heavy loads each spring adds 500 lbs. carrying capacity and rear-end stability is improved.

# LIGHT-DUTIES

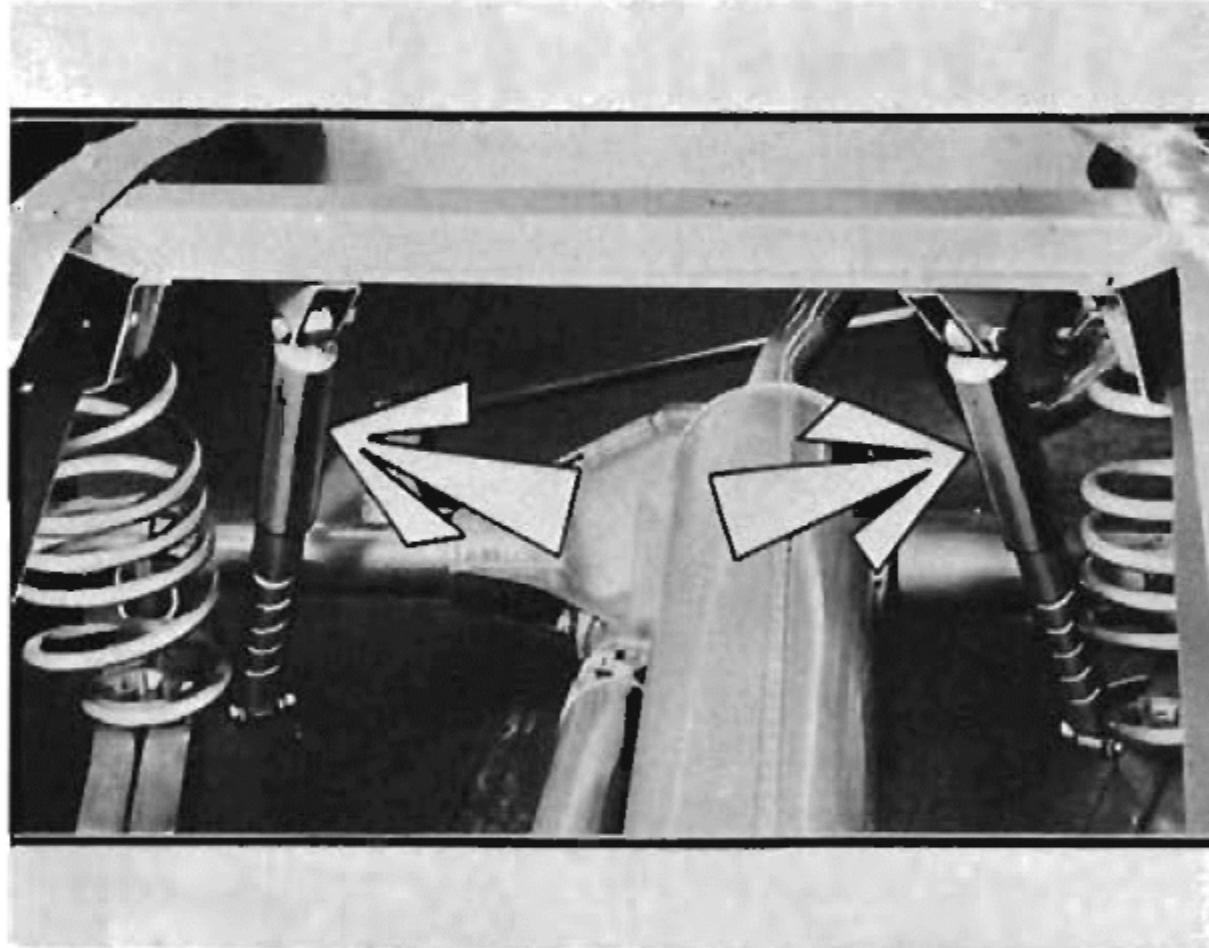

On light-duty models, rear shocks have been repositioned for more positive ride control. Rear shock absorbers are now attached to the frame ahead of the rear axle. At this location, body motion transmitted to the shocks is more easily absorbed.

## EXTRA-QUALITY, LIGHT-DUTY FEATURES

**POWERGLIDE**—The new, aluminum, water-cooled Powerglide transmission is available on Series 10 and 20 Two-Wheel-Drive models, including P20 Step-Vans. Aluminum reduces excess weight and contributes to ease of cooling.

**Greater  
Steering  
Gear  
Durability**

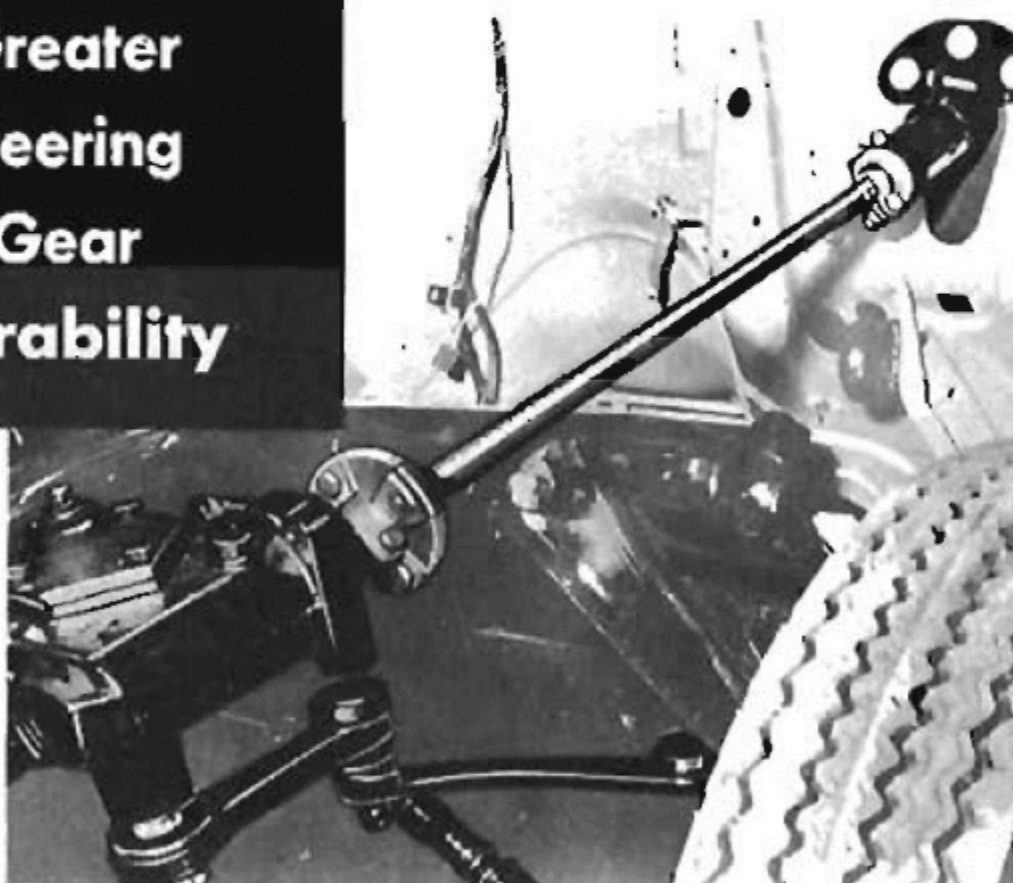

**STEERING**—A new single-piece steering gear shaft replaces the multiple-piece type formerly used. Steering gear linkage has also been simplified for maximum durability and optimum steering characteristics.

**POWER BRAKES**—For the first time, power brakes are available as options on regular Series 10 and 20 vehicles. Power Steering is available as a dealer installation. A full measure of driving convenience is now available for the most demanding customer.

## THE CORVAIR 95's

More comfort and convenience also are built into the Corvan and Rampside Pickup. Both Corvaire 95 models have new, self-adjusting brakes. When applied while backing up, the brakes automatically compensate for wear. In addition, periodic maintenance has been reduced. Lubrication of regular lube points has been extended to six months or 6,000 miles—whichever comes first. The rear-engine design of these vehicles, with nearly equal weight distribution, front and rear, provides better traction and superlative steering and handling.

They are powered with time- and job-proved, air-cooled, aluminum High Torque Engines available with one of three transmissions—three-speed or four-speed manual, or Powerglide. Positraction is also available. Combined with rear-engine location, it provides outstanding traction under difficult road conditions.

No one else can offer the exclusive ramp feature of the Rampside which provides convenient loading or unloading for heavy or bulky objects.

# LIGHT-DUTIES



The Corvan has wide, low doors for easy loading and unloading. Left-hand doors are available for operations in crowded areas. Loading doors have new, strap-type, two-position door checks. Optional equipment for Corvans includes rear-door windows.



On the inside, huge, unobstructed load space provides more payload, *plus* greater ease in loading or unloading. They are quality-built throughout. Every Corvair 95 has double-wall construction. This feature provides extra strength and durability, extended body life, and high resale value.

## STEP-VAN 7's

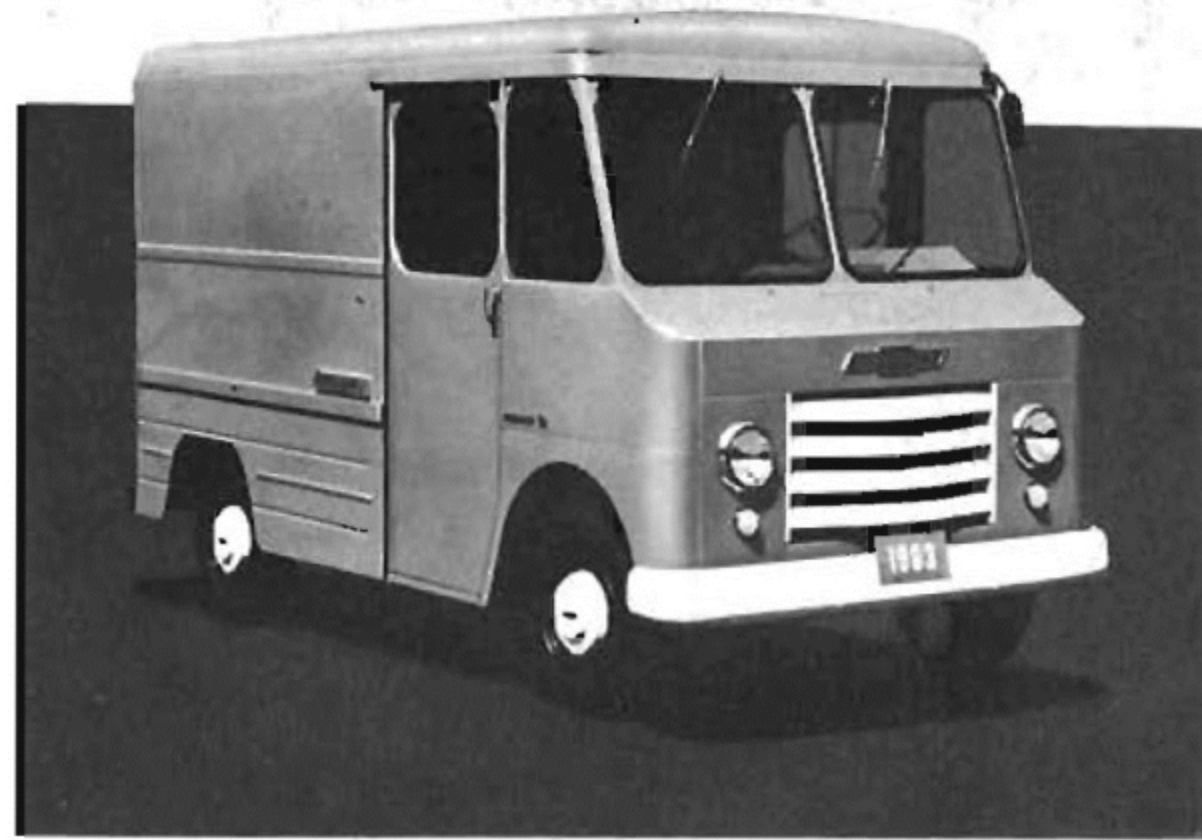

Step-Van Sevens, with their new, four-cylinder engine, get light-duty delivery work done with maximum fuel economy. The six other Step-Vans are powered by the new 230 Six Engine, which is optional on the Step-Van Seven. They haul heavier loads with proportionate savings and unmatched dependability. New Step-Van engines feature downdraft carburetion.

For any light-duty job, Chevrolet offers new profit-making models with . . .

- **New Power Trains**
- **New Rugged Frames**
- **New Husky Suspensions**
- **New Convenience and Driving Ease**
- **New Economy**
- **New Dependability**

# MEDIUM- AND HEAVY-DUTIES TAILORED TOUGH FOR THE BIG JOBS



## NEW MODEL LINE-UP

**NEW FRAMES**  
**NEW SUSPENSIONS**

**NEW TRIMLINE STYLING**  
**NEW POWER TRAINS**

Chevrolet medium- and heavy-duty trucks are tailored tough for the big jobs—for more heavier-duty business. This year, Chevrolet offers matched-to-the-market vehicles with a new model line-up. Solid new frames, rugged new suspensions, new Trimline Styling and new power teams contribute to greater-than-ever dependability, durability, performance and economy. There are 73 medium-duty conventional, LCF, tilt cab and cowl models in Series 50 and 60. Series 40 and 50 are combined into a new Series 50 with GVW's from 10,000 to 16,000 pounds.

There are 46 heavy-duty conventional, LCF, tilt cab and tandem models in Series 60-H and 80, including two new 60-H school bus models. GVW's range from 15,000 lbs. to a maximum of 36,000 lbs. for tandems. Medium- or heavy-duty, every model is built solid and rugged.

# MEDIUMS AND HEAVIES

## FRAMES

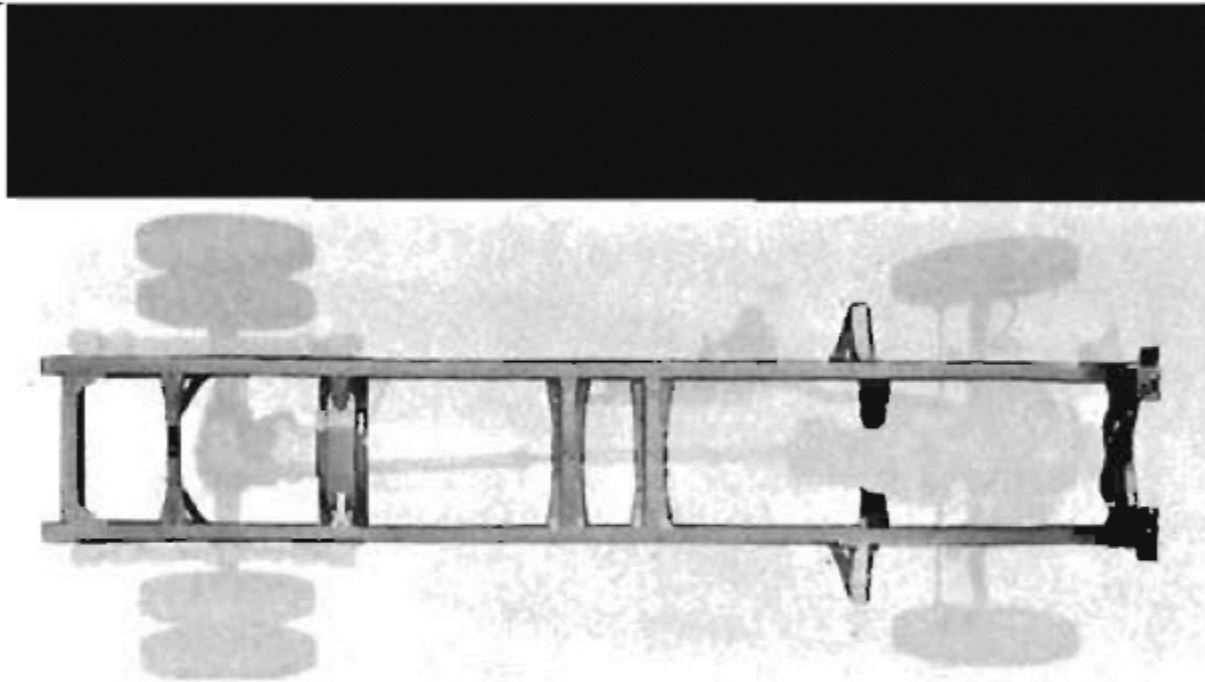

Medium- and heavy-duty models feature new, full, ladder-type, channel-section frames. Heavier-gauge siderails and improved cross member design make these new frames stronger than ever. On most models, siderail metal is substantially thicker—.093 of an inch thicker. This new frame strength provides increased load support and greater durability.

## I-BEAM FRONT SUSPENSION

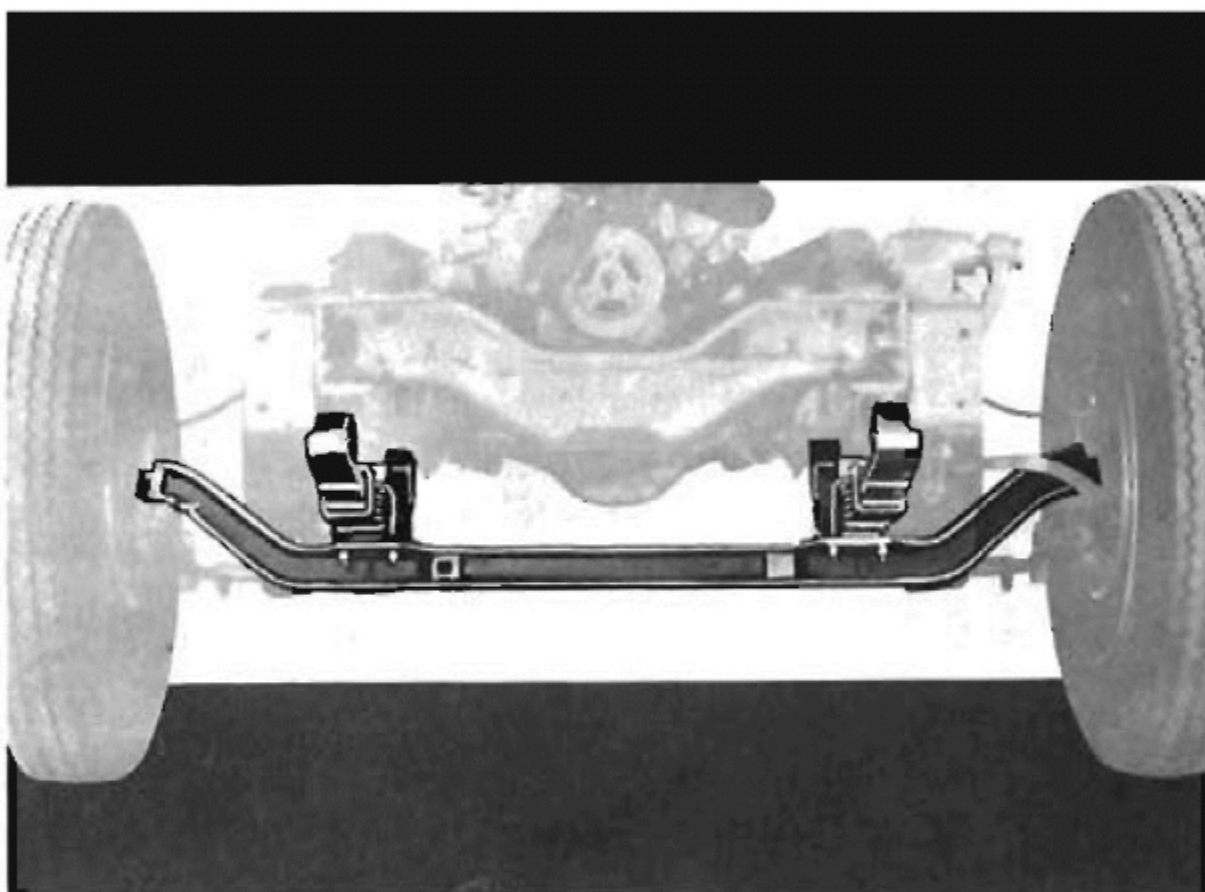

The new frames are supported by the newest and best suspensions in the business. I-beam axles with variable-rate front springs are standard equipment. Variable-rate springs have been proved over millions of miles on rear suspensions. Now, for the first time, they are available on front suspensions. They provide reduced maintenance, better tracking and superlative ride and handling qualities.

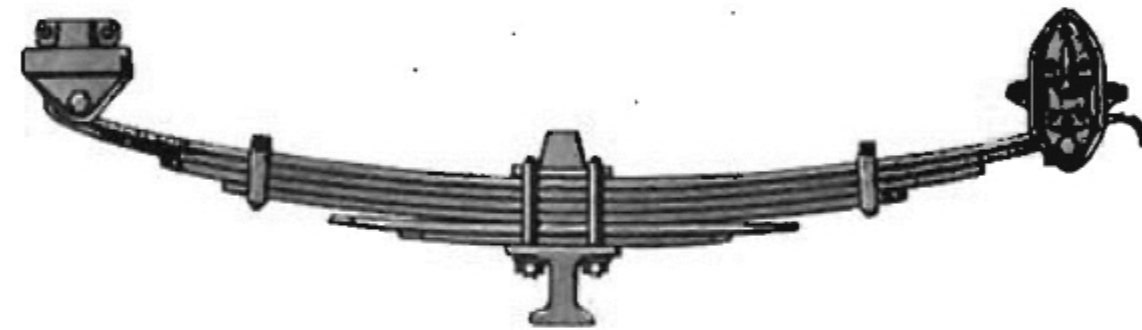

The top leaf of the variable-rate spring is "pinned" at the front and rides against a specially hardened cam surface at the rear. This feature permits spring length to adjust with the load. The second leaf has a safety wrap to back up the number-one leaf. These new variable-rate springs are keyed to comfort and capacity regardless of load or operating conditions. Riding qualities are far better than those obtained with ordinary leaf springs. Empty or with light loads, the full length of the top leaf provides support along with reduced inner-leaf friction.



With heavier loads, the top leaf shortens, providing increased load support plus comfort. Engineering and on-the-road tests prove this to be the most ideal suspension ever offered on heavier-duty trucks.

Standard front-spring capacities range from 4,000 lbs. for Series 50's to 9,000 lbs. for M80 Tandems. Optional springs run up to 14,000 lbs., a new high for Chevrolet. I-beam axle capacities range from 4,000 to 11,000 lbs.

## REAR SUSPENSIONS

With variable-rate springs, front and rear, Chevrolet again provides a new concept in truck design. The job-proved, variable-rate rear springs can shoulder huge loads while providing comfortable riding qualities for load and driver, empty or loaded.

# MEDIUMS AND HEAVIES

## STEERING



Every medium- and heavy-duty model has better-than-ever steering and handling. Steering linkage for 1963 has been simplified. The new steering gear has a single-piece steering shaft with flexible couplings. This simplified design provides good steering and handling characteristics and greater durability. Engineering and road tests indicate many times longer life. Power steering continues to be available.

## ENGINES

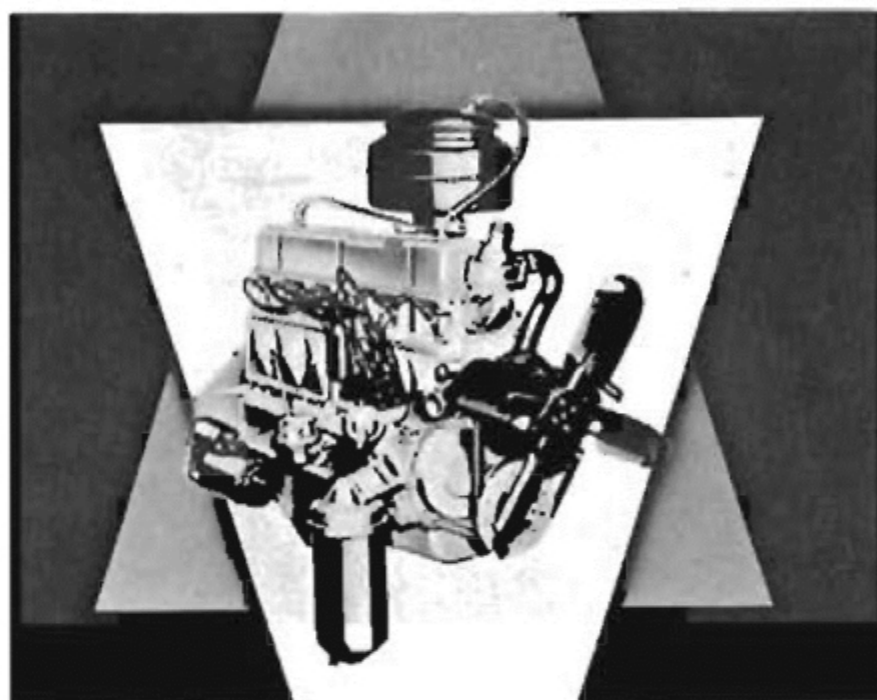

The 1963 heavier-duty trucks also have new go-ahead six-cylinder power. The all-new 292-cubic inch six-cylinder engine delivers 165 maximum horsepower and 280 ft. lbs. of torque. It is standard equipment for 60 and 60-H models. Optional on light-duties, with an 8.0:1 compression ratio, this brilliant, new Six delivers top performance on regular gas.

- Hardened Exhaust Valve Seats
- Positive Valve Rotation
- Wedge-Shaped Combustion Chamber
- Full-Flow Oil Filter, Std.

Short exhaust ports and unobstructed inlet valving provide good breathing and top engine efficiency. Valves are made of heat-resistant alloy steel, with aluminized inlet and stellite-faced exhaust valves. These premium metals contribute to long, trouble-free engine life. Specially hardened exhaust valve seats increase valve life. Positive valve rotation reduces wear caused by carbon build-up. The wedge-shaped combustion chamber provides optimum turbulence for better fuel combustion. A full-flow oil filter is standard.

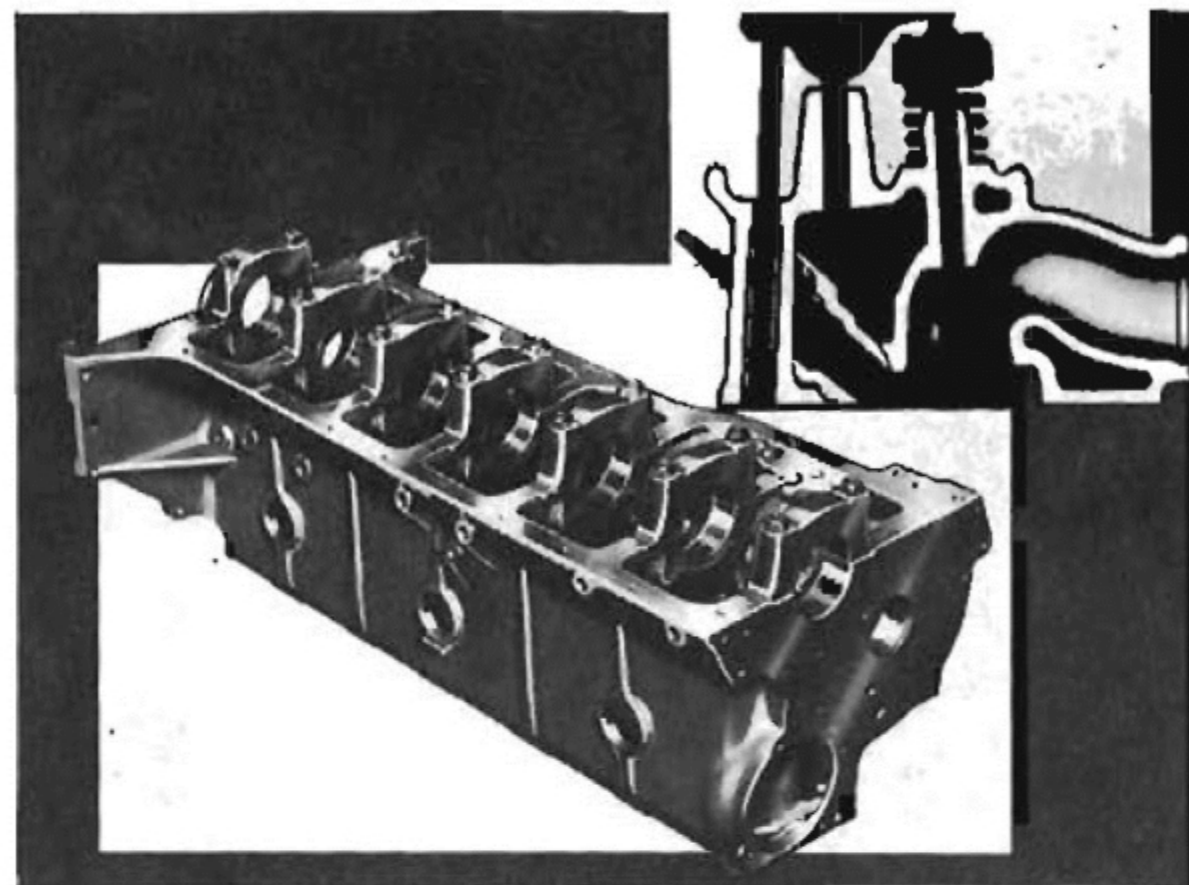

Solid engine strength and rigidity are obtained by use of a high-chrome alloy cylinder head and cast-alloy iron block. Its forged-steel crankshaft and seven tough, durable Moraine 400 main bearings provide inherent strength and rigidity—important durability features which will keep this truck engine operating long after others are down for repairs.

# MEDIUMS AND HEAVIES

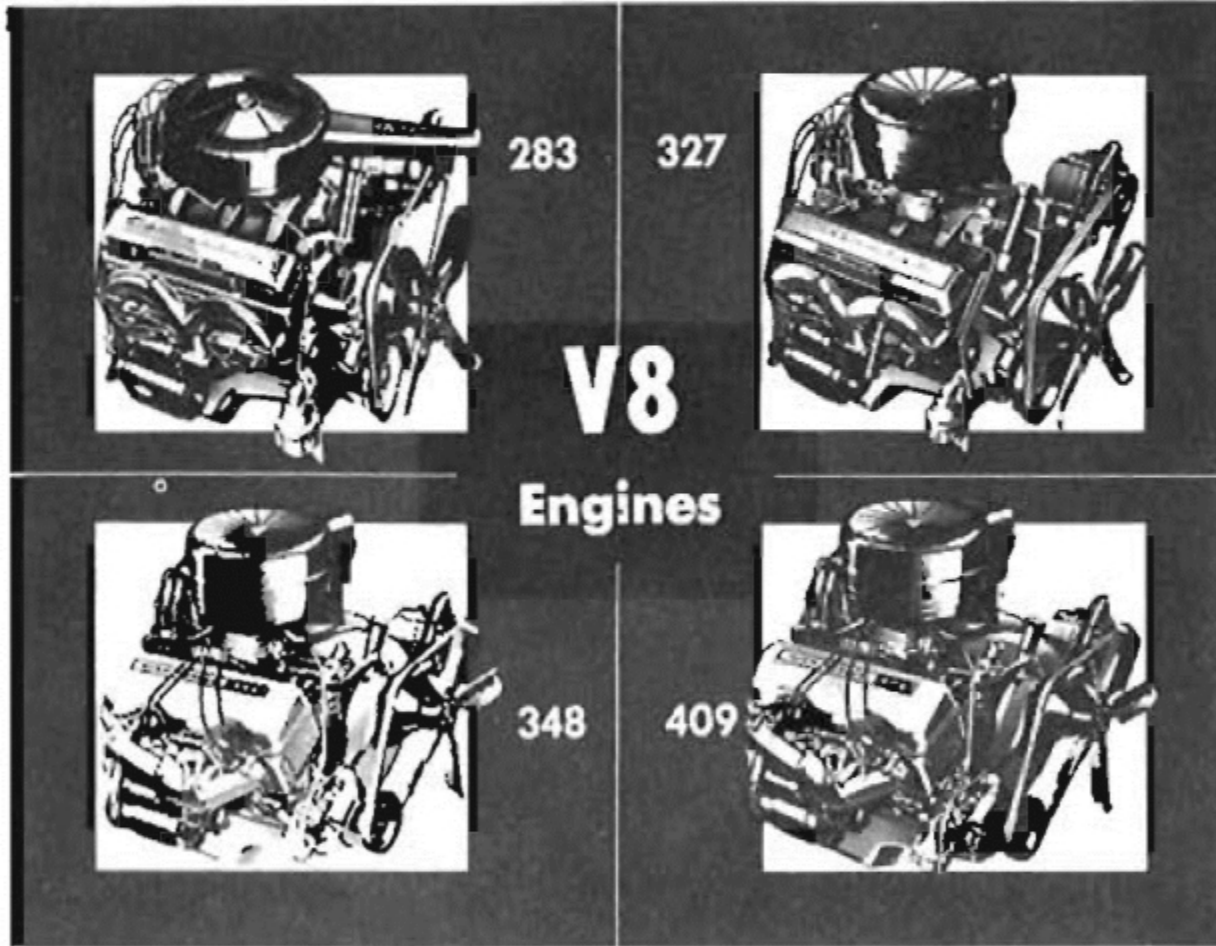

Optional engines this year again include the 283-V8, 327-V8, 348-V8 and 409-V8. All are top performers with established reputations earned on the job.

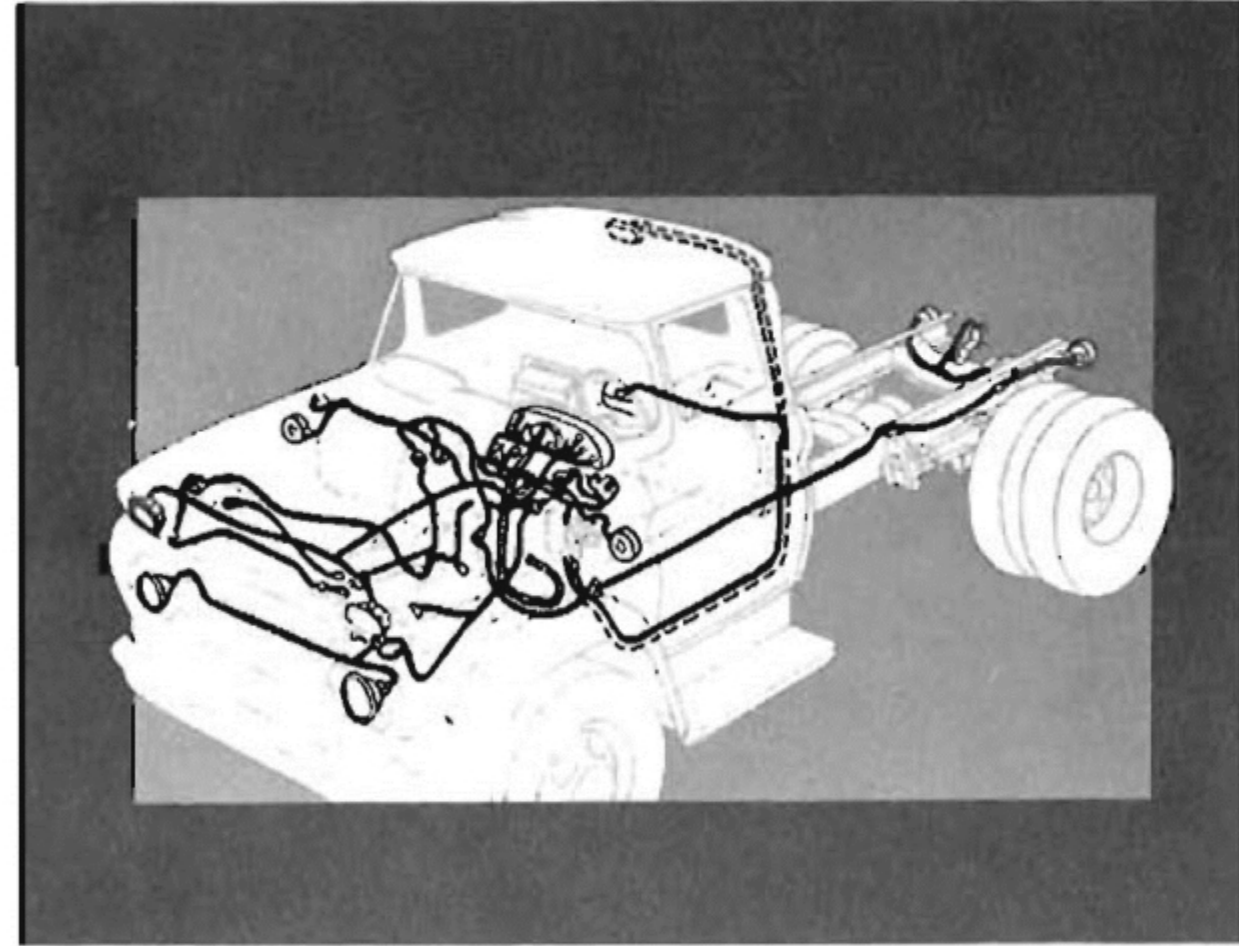

Engine wiring subject to overloading or abuse is protected by a special nonmelting synthetic rubber insulation. It is used on chassis and engine wiring harnesses on D60, 60-H and 80 Series models. Wiring failure is a frequent cause of truck down time.



Chevrolet's 1963 engine line-up is completed by the 4-53 Diesel, available on ten D60 and five D60-H models and the 6V-53 Diesel, available on two LCF and two tilt cab models in the 80 Series. More and more truckers are cashing in on diesel advantages, for high-idling time or high mileage. Sold right, these vehicles are the ideal answer to the profit-pinch of competition.



Radiator shutters are available as an option for D60 models this year.\* They keep engine temperatures in the most efficient range under a wide variety of operating conditions.

\*Available after Announcement.



# MEDIUMS AND HEAVIES

## TRANSMISSIONS

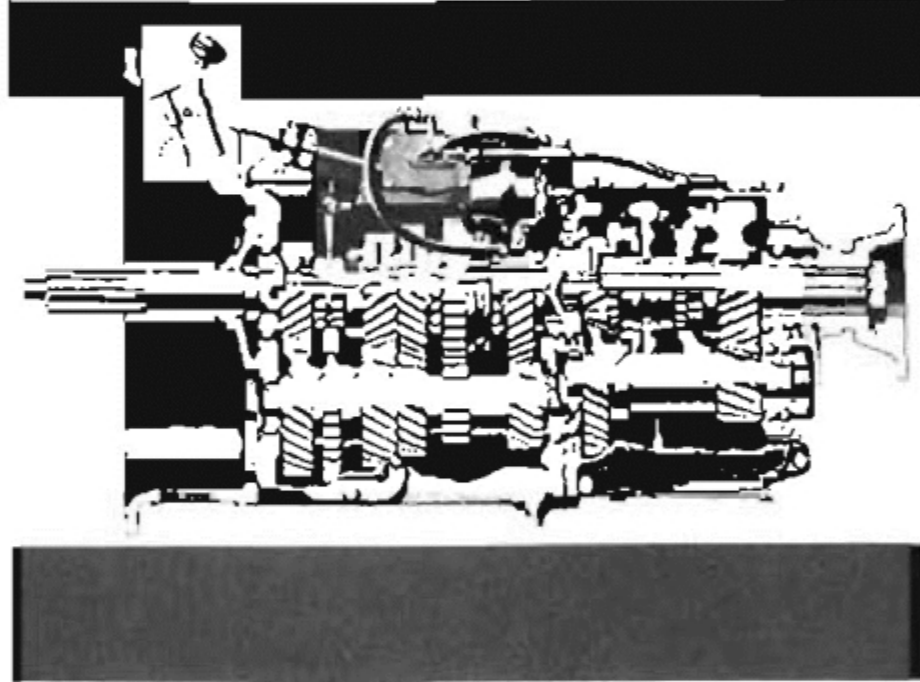

Chevy performance-packed power teams also include 12 main and two auxiliary transmissions which put High Torque power to work effectively, efficiently, and economically. New this year is the Fuller Roadranger eight-speed manual transmission. It is available with the 409-V8 gasoline engine or 6V-53 Diesel engine on Series 80 models. While new to Chevrolet, this high-torque-capacity transmission is time-proved and well accepted by heavy-duty operators. Eight forward gear ratios, evenly and progressively spaced, are obtained by using a simple four-step shift pattern—twice. With this tough, durable transmission, a two-speed rear axle is unnecessary.



Also new in 1963 is the heavy-duty, normal ratio, five-speed Spicer 5652B, available on tandem, conventional and LCF Series 80's. This high-torque capacity Synchro-Mesh transmission is easy to shift.

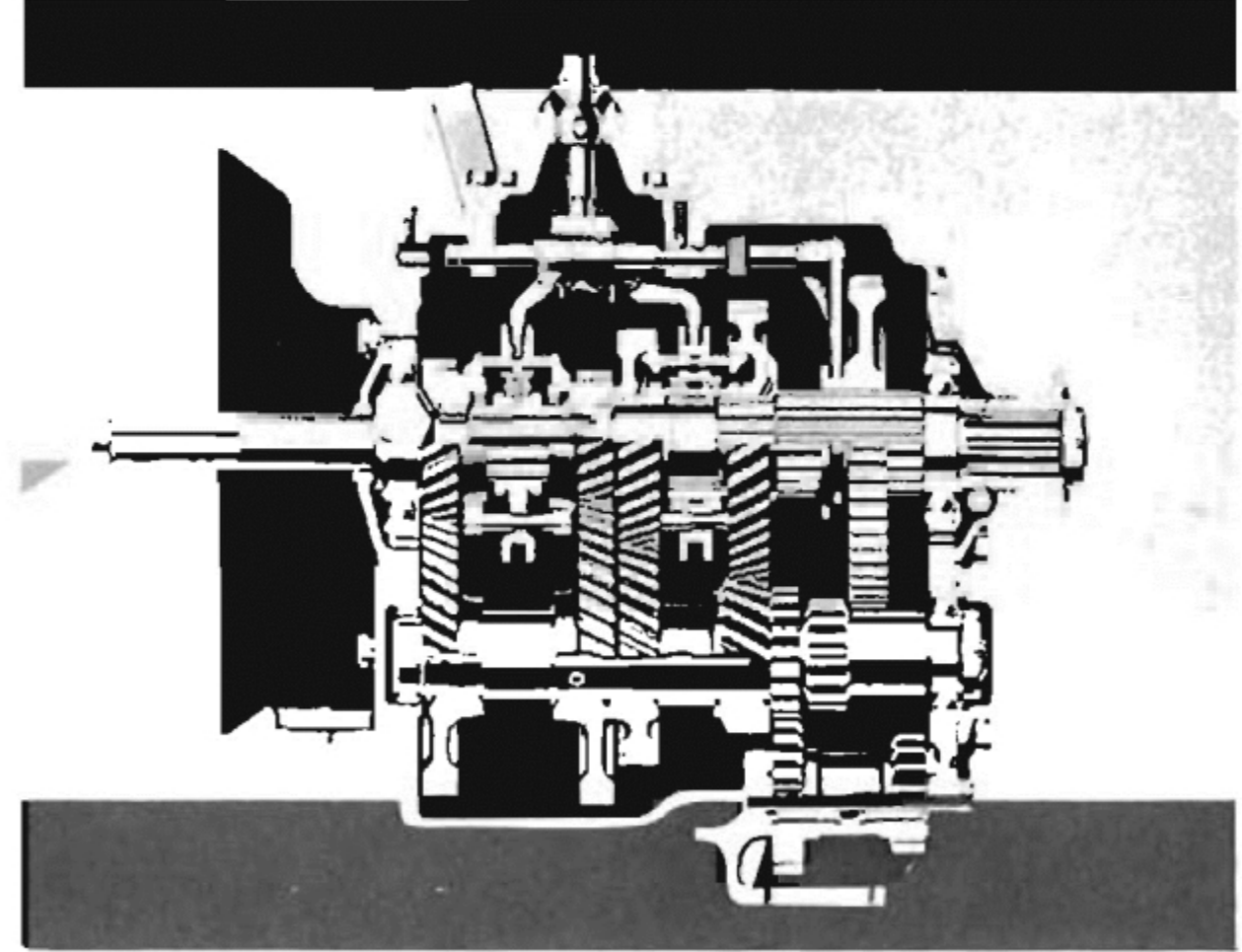

In addition, the Spicer five-speed, close-ratio 5756B transmission, formerly offered only with Series 80 Diesels, is now available on conventional, LCF and Tilt Cab Series 80's, when used with the 409-V8 gasoline engine or 6V-53 Diesel.

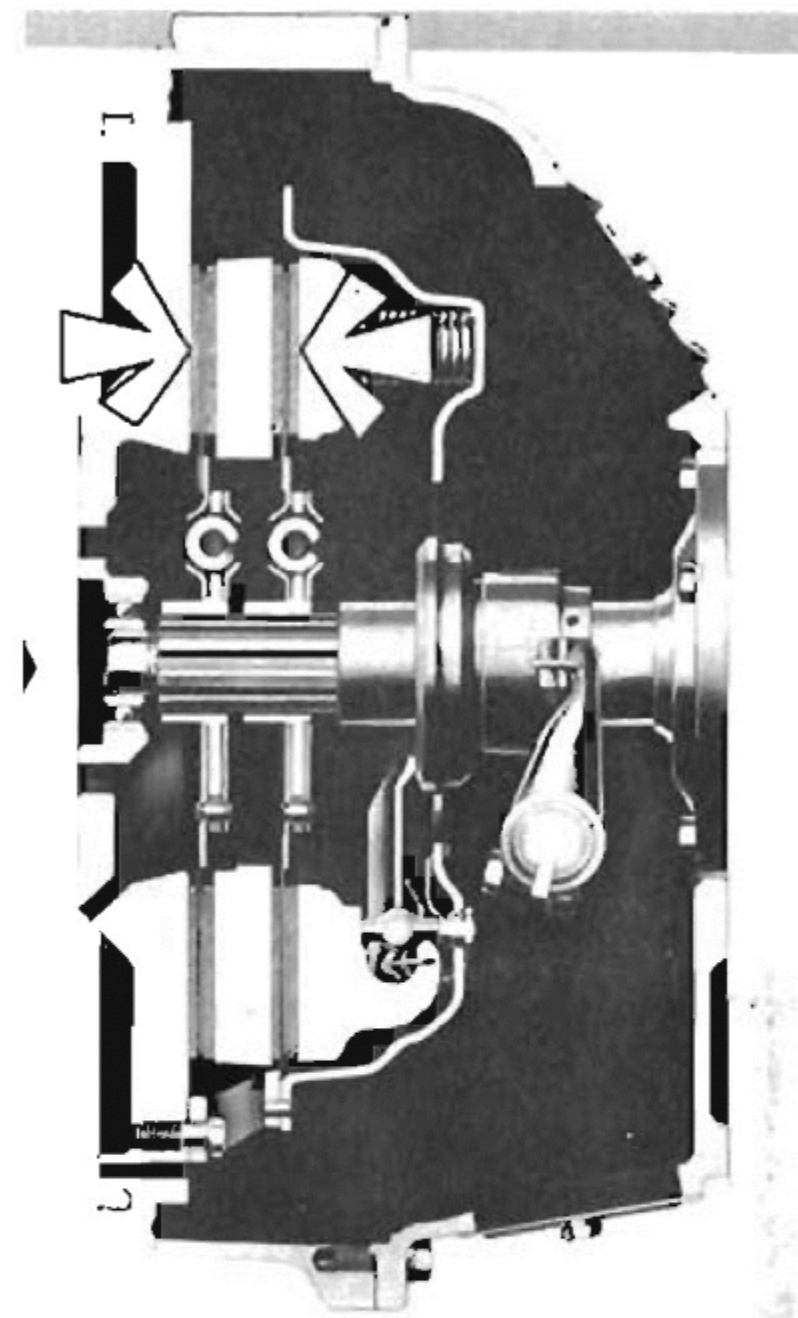

A new, two-plate, 12-inch clutch provides a perfect match for the 409-V8's High Torque power output.

# MEDIUMS AND HEAVIES

## BRAKES

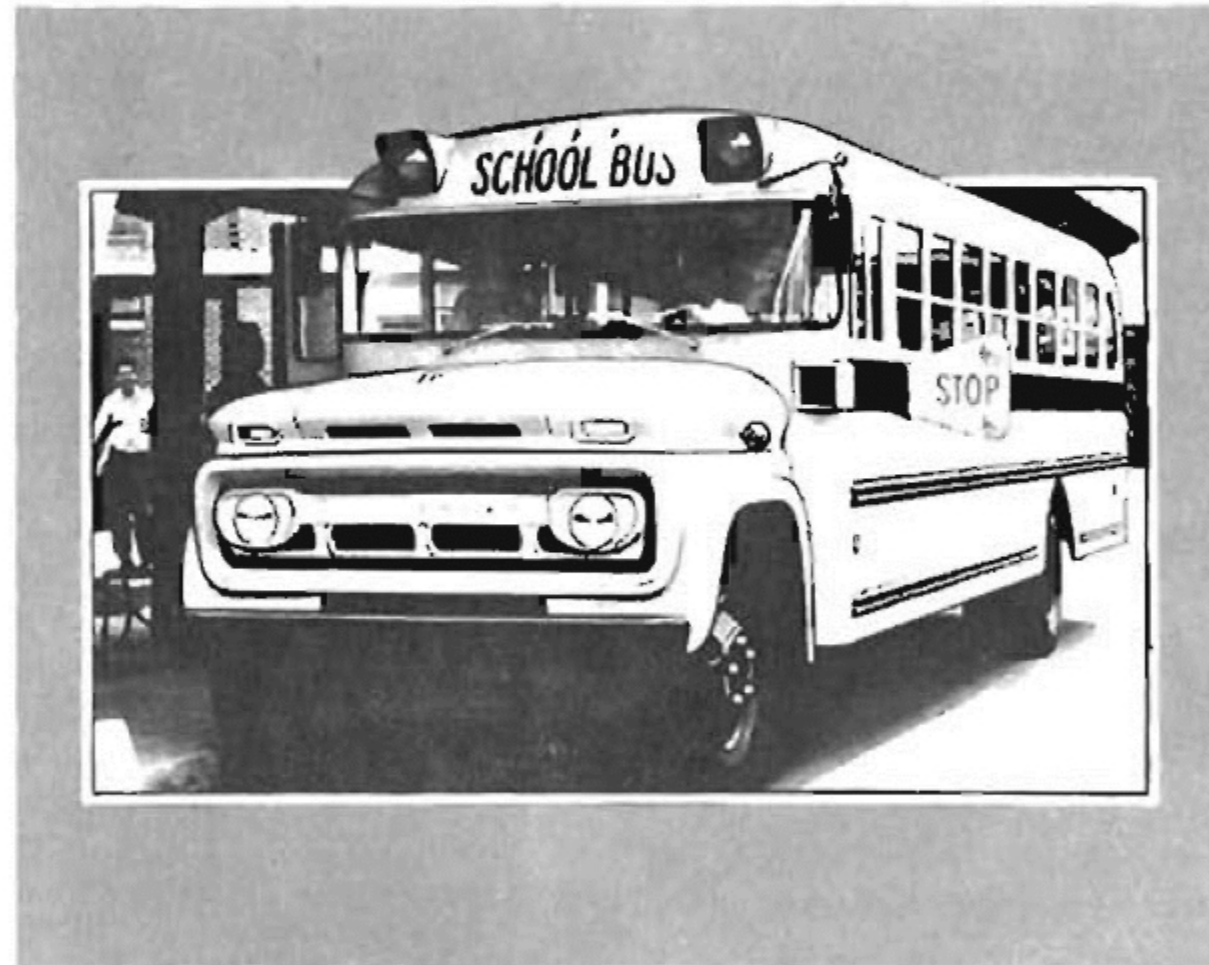

For the first time, independent front and rear braking systems are available as COPO's on school bus models. This option is designed to provide effective braking, even if one of the two systems should fail.

## OPTION IDENTIFICATION SYSTEM

A new Option Identification System, used by all GM automotive divisions, is introduced by Chevrolet for 1963. In this system, RPO's (Regular Production Options) and FOA's (Factory Optional Accessories) are defined collectively as options. The new system is designed to simplify liaison between the GM automotive divisions and their manufacturing and assembly plants by providing a uniform classification for options similar to the existing Uniform Parts Classification groups.

The new Option Identification System consists of a code comprised of a letter of the alphabet and a number from 01 to 100. The prefix letter identifies the general equipment group, and the suffix number identifies the item in the group. As an example, the Code A37 denotes seat belts (the number 37 in Body Equipment Group A). Any GM automotive division offering them will use this code to identify seat belts. The next column contains a general listing of the various letter prefixes for the different equipment groups. The new Option Identification System does not apply to paint and Interior Trim Options, which remain identified with a three-digit number.

ABCDE	Body Equipment	N	Gasoline Tank, Exhaust and Steering Equipment
F	Front Axle and Suspension Equipment	PQRS	Wheel and Tire Equipment
GH	Rear Axle and Suspension Equipment	T	Sheet Metal, Battery and Lamp Equipment
J	Brake Equipment	U	Speedometer and Miscellaneous Electrical Equipment
KL	Engine Equipment	VZ	Radiator, Bumper and Miscellaneous Final Assembly Equipment
M	Clutch and Transmission Equipment		

# THE CHEVROLET DIESEL STORY

In 1962, Chevrolet introduced diesel power to its heavier-duty truck line-up. During this time, the highly efficient design of the GM two-cycle diesel has more than proved itself. The straight Four, used in D60 and D60-H models, and the V-Six engine, used in E80 and U80 models, have provided truck operators with more work per gallon, more ton-miles per fuel dollar.

In addition to their economy, these engines also provide near-maximum torque over a wide range of engine r.p.m. Almost full torque is delivered from 1,000 r.p.m. to 2,000 r.p.m., providing powerful pulling ability at low and medium engine and road speeds.

Because of their rugged and precise construction, diesel engines last longer, require less maintenance and provide greater dependability.

For 1963, Chevrolet Trucks will meet 93% of America's trucking needs, confirming once again Chevrolet's reputation as the most complete truck line in the business.

## LOAD-PULLING CHART

### Power-Team Combinations

<b>Engine</b> 4-53 212-Cu. In. Disp. H.P.: 130 @ 2,800 TOR.: 271 Ft. Lbs. @ 1,500	<b>Engine</b> 6V-53 318-Cu. In. Disp. H.P.: 195 @ 2,800 TOR.: 423 Ft. Lbs. @ 1,500
<b>Models</b> Std. on D60, D60-H	<b>Models</b> Std. on EU80
<b>Transmissions</b> 5-Speed Clark 267V (Std. on D60-H) 5-Speed Clark 264VO (Std. on D60) 5-Speed Spicer 3152A (Opt. on D60-H) 5-Speed Spicer 3153 (Opt. on D60)	<b>Transmissions</b> 5-Speed Spicer 5756B (Std. on EU80) 8-Speed Fuller R46 (Opt. on EU80)

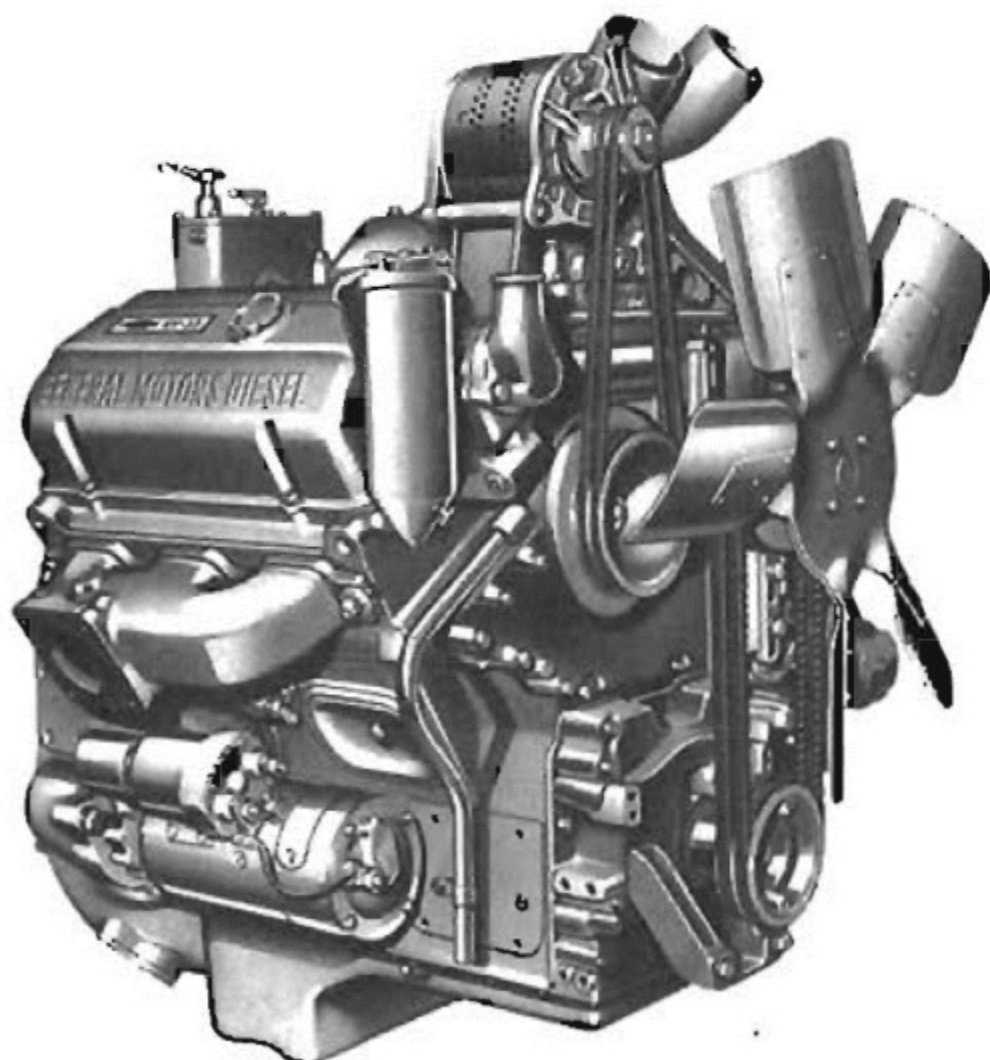

## DIESEL LOAD-CARRYING CHART

SERIES	D60	D60-H	EU80
Front Axle Capacity	5,000 <u>7,000</u>	7,000	7,000 <u>9,000</u> 11,000
Spring Capacity @ Ground Each Front	3,000 <u>3,500</u> 4,000 <u>4,500</u>	3,500 <u>4,500</u> 7,000	3,500 <u>4,500</u> <u>5,500</u> <u>7,000</u>
Capacity @ Pad	2,700 <u>3,150</u> <u>3,650</u> <u>4,100</u>	3,150 N.A.	3,150 <u>4,100</u> <u>5,050</u> <u>6,500</u>
Rear Axle Capacity	15,000 S-S <u>15,000 2-S</u>	17,000 2-S	18,500 2-S <u>18,500 S-S*</u>
Spring Capacity @ Ground Each Rear	9,200 <u>10,400</u> <u>11,500</u>	10,400 <u>11,500</u>	10,400 <u>11,500</u>
Capacity @ Pad	8,075 <u>9,275</u> <u>10,375</u>	9,275 <u>10,375</u>	9,275 <u>10,375</u>
Frame Section Modulus	11.80 <u>15.86 @</u>	11.80	11.80 E80 14.69 U80†

Underline means optional equipment.

@With optional 1/4-inch outer frame reinforcement.

†Outer frame reinforcement is base equipment on this model.

\*Standard when 8-Speed Roadranger transmission option is used.

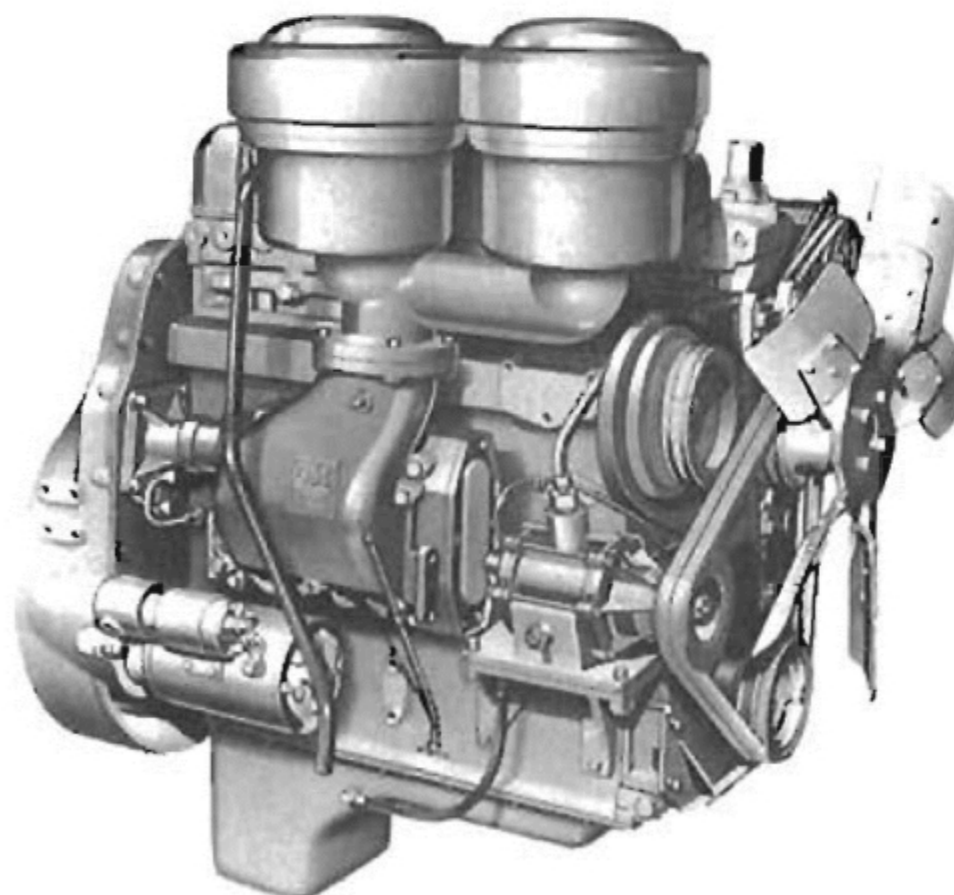

# ● LIGHT-DUTY LOAD-CARRYING CHART (Gasoline Engines)

SERIES	C10	K10	P10	R10	C20	K20	P20	C30	P30	CLS50
<b>FRONT AXLE CAPACITY</b>	2,500	3,300	2,500	2,500	3,000	3,500	4,000 I-Beam	3,500	4,000 I-Beam	4,000 <u>5,000</u>
<b>FRONT SPRING CAPACITY @ GROUND EA.</b>	1,250 Coil	1,650	1,250 Coil	1,150 Coil	1,250 Coil <u>1,500</u> Coil	1,750	2,000	1,500 Coil <u>1,750</u> Coil	2,000 <u>2,500</u>	2,000 <u>3,000</u>
<b>@ PAD</b>	N.A.	1,350	1,080 Coil	1,040 Coil	N.A.	1,390	1,700	N.A.	1,700 <u>2,200</u>	1,750 <u>2,700</u>
<b>REAR AXLE CAPACITY</b>	3,500 Posi- tract.	3,300	3,500	2,500	5,200 No-Spin	5,200	5,200 <u>5,200</u> No-Spin	7,200 No-Spin	7,200	11,000 S-S <u>15,000 S-S</u> <u>15,000 2-S</u>
<b>REAR SPRING CAPACITY @ GROUND EA.</b>	1,250 Coil <u>2,000</u> Coil	1,900	1,250 Coil <u>2,000</u> Coil	1,150 Coil <u>2,000</u> Coil	2,000 Coil <u>3,000</u> Coil	1,900 <u>3,150</u>	2,400	2,400 <u>3,100</u> <u>4,150</u>	2,400 <u>3,400 M&amp;A</u>	5,500 <u>7,500</u> <u>8,750</u>
<b>@ PAD</b>	1,080 Coil <u>1,650</u> Coil	1,640	1,080 Coil <u>1,650</u> Coil	1,050 Coil <u>1,650</u> Coil	1,650 <u>2,650</u>	1,640 <u>2,785</u>	2,050	1,920 <u>2,750</u> <u>3,670</u>	2,050 N.A.	<u>6,650</u>
<b>FRAME SECTION MODULUS</b>	2.98	5.09	2.98		3.71	5.09	5.17	5.14	5.17	9.38

# MEDIUM- AND HEAVY-DUTY LOAD-CARRYING CHART (Gasoline Engines)

SERIES	CLS60	S69	T60	CLT60-H	CL80	M80	T80
<b>FRONT AXLE CAPACITY</b>							
	5,000* <u>7,000*</u>	7,000	7,000	7,000	7,000 <u>9,000</u> <u>11,000</u>	7,000 <u>9,000</u> <u>11,000</u>	7,000 <u>9,000</u> <u>11,000</u>
<b>FRONT SPRING CAPACITY @ GROUND EA.</b>							
	3,000 <u>3,500</u> <u>4,000*</u> <u>4,500</u>	3,500	3,500 <u>4,500</u>	3,500 <u>4,000</u>	3,500 <u>4,500</u> <u>5,500</u> <u>7,000</u>	4,500 <u>5,500</u> <u>7,000</u>	3,500 <u>4,500</u> <u>5,500</u> <u>7,000</u>
<b>@ PAD</b>							
	2,700 <u>3,150</u> <u>3,650*</u> <u>4,100</u>	3,150	3,150 <u>4,100</u>	3,150	3,150 <u>4,100</u> <u>5,050</u> <u>6,500</u>	4,100 <u>5,050</u> <u>6,500</u>	3,150 <u>4,100</u> <u>5,050</u> <u>6,500</u>
<b>REAR AXLE CAPACITY</b>							
	15,000 S-S <u>15,000 2-S</u> <u>17,000 S-S</u> <u>17,000 2-S</u> (17,000 with S67, 69 only)	15,000 S-S <u>15,000 2-S</u> <u>17,000 S-S</u> <u>17,000 2-S</u>	15,000 S-S <u>15,000 2-S</u> <u>17,000 S-S</u> <u>17,000 2-S</u>	17,000 S-S <u>17,000 2-S</u>	18,500 S-S <u>18,500 2-S</u>	30,000 Bogie	18,500 S-S <u>18,500 2-S</u>
<b>REAR SPRING CAPACITY @ GROUND EA.</b>							
	7,500 <u>8,750</u> <u>9,200***</u> <u>10,400</u> <u>11,500</u>	7,500 <u>8,750</u> <u>9,200</u> <u>10,400</u> <u>11,500</u>	7,500 <u>8,750</u> <u>9,200</u> <u>11,500</u>	10,400 <u>11,500</u>	9,200 <u>10,400</u> <u>11,500</u>	17,250 <u>19,500</u>	9,200 <u>10,400</u> <u>11,500</u>
<b>@ PAD</b>							
	6,650 N.A. <u>8,075</u> <u>9,275</u> <u>10,375</u>	6,650 N.A. <u>8,075</u> <u>9,275</u> <u>10,375</u>	6,650 N.A. <u>8,075</u> <u>10,375</u>	9,275 <u>10,375</u>	8,075 <u>9,275</u> <u>10,375</u>	15,440 <u>17,540</u>	8,075 <u>9,275</u> <u>10,375</u>
<b>FRAME SECTION MODULUS</b>							
	9.38 10.59	11.80	10.59	11.80	11.80	23.34†	10.59

\*Except S69.

\*\*K15.

\*\*\*Except S62, 64.

†Outer frame reinforcement is base equipment on these models.

# LOAD-PULLING CHART

## POWER TEAM COMBINATIONS (GASOLINE ENGINES)

HIGH TORQUE ENGINES	STD.	OPT.	TRANSMISSIONS	COMBINATION AND APPLICATION
145 HO 6 145-Cu. In. Disp. H.P.: 80 @ 4,400 TOR.: 128 Ft. Lbs. @ 2,300	R10		3-Speed 4-Speed Powerglide	Std.: R10 Opt.: R10 Opt.: R10
153-4 153-Cu. In. Disp. H.P.: 90 @ 4,000 TOR.: 152 Ft. Lbs. @ 2,400	P10		3-Speed 3-Speed H-D 4-Speed Powerglide	Std.: P10 Opt.: P10 Opt.: P10 Opt.: P10
230-6 230-Cu. In. Disp. H.P.: 140 @ 4,400 TOR.: 220 Ft. Lbs. @ 1,600	CK10, 20 C30 CLS50 P20, 30	P10	3-Speed 3-Speed H-D 4-Speed  Powerglide	Std.: C10, 20; P20 Opt.: CP10, 20, 30 Std.: CP30; CLS50 Opt.: C10; CP20 Opt.: CP10, 20
230-6 (Econocarb) 230-Cu. In. Disp. H.P.: 125 @ 3,400 TOR.: 210 Ft. Lbs. @ 1,600		C10	3-Speed 3-Speed H-D 4-Speed Powerglide	Std.: C10 Opt.: C10 Opt.: C10 Opt.: C10
292-6 292-Cu. In. Disp. H.P.: 165 @ 3,800 TOR.: 280 Ft. Lbs. @ 1,600	CLT60, 60-H; S62, 64, 67	C10, 20; C30; CLS50	3-Speed 3-Speed H-D 4-Speed  5-Speed New Process 540C 2-Speed Transfer Case	Std.: C10, 20 Opt.: C10, 20, 30 Std.: C30; CLS50; CLT60, 60-H; S62, 64, 67 Opt.: C10, 20 Opt.: CLT60, 60-H; S62, 64, 67 Std.: K10, 20
283-V8 283-Cu. In. Disp. H.P.: 175 @ 4,400 TOR.: 275 Ft. Lbs. @ 2,400		CK10, 20; C30; CLS50	3-Speed 3-Speed H-D 4-Speed  Powerglide 2-Speed Transfer Case	Std.: CK10, 20 Opt.: C10, 20, 30 Std.: C30; CLS50 Opt.: CK10, 20 Opt.: C10, 20 Std.: K10, 20
327-V8 327-Cu. In. Disp. H.P.: 158 @ 4,000 TOR.: 305 Ft. Lbs. @ 2,000	S69	CLT60, 60-H; S62, 64, 67	4-Speed 5-Speed Clark 265V Powermatic	Std.: CLT60, 60-H; S62, 67, 69 Opt.: CLT60, 60-H; S62, 64, 67, 69 Opt.: CS60, 60-H
348-V8 348-Cu. In. Disp. H.P.: 220 @ 4,400 TOR.: 325 Ft. Lbs. @ 2,600	CLMT80		5-Speed Spicer 3152 5-Speed Spicer 3152A 3-Speed Spicer Auxiliary 4-Speed Spicer Auxiliary Powermatic	Std.: CLMT80 Opt.: CLT80 Opt.: M80 Opt.: M80 Opt.: CLMT80
409-V8 409-Cu. In. Disp. H.P.: 252 @ 4,000 TOR.: 390 Ft. Lbs. @ 2,400		CLMT80	5-Speed Spicer 5652B 5-Speed Spicer 5756B 8-Speed Fuller R46 4-Speed Spicer Auxiliary	Opt.: CLMT80 Opt.: CLT80 Opt.: CLMT80 Opt.: M80

# CHEVROLET TRUCKS FOR 1963

## ● ARE BUILT FOR BUSINESS *with . . .*

- ***New High Torque Power***
- ***Diesel Economy and Efficiency***
- ***New Frames***
- ***New Suspensions***
- ***New Trimline Styling***
- ***New Model Line-up***

Chevrolet Trucks for 1963 *mean business*—sales business for Chevrolet salesmen and profit-making business for owners and operators. With new and improved power plants and components, Chevrolet Trucks on the move are working harder and earning more, because they're tough, lean and *built for business*.

## BRIGHT, NEW STARS IN 1963 TRUCK

### CUSTOM FEATURE ACCESSORIES



#### SLIDING CAB WINDOW

The dealer-installed Sliding Cab Window improves ventilation, makes it easier for the driver to talk to people from his cab while on the job.



#### LOW PEDAL POWER BRAKE FOR SERIES C AND K

These new power brakes mean surer, safer stops—are easier to use. The driver just "rocks" his foot from the accelerator to the brake in one easy motion!



#### GM FIRE EXTINGUISHER

This well-styled Custom Feature Accessory exceeds ICC requirements and meets United States Coast Guard regulations for boats. It can also be used in homes. A safety-zone gauge shows that the extinguisher is ready for immediate use.



**CHEVROLET**

**TRUCKS**

**LIGHT-DUTY**

**MEDIUM- AND  
HEAVY-DUTY**