

**1965**



**TRUCKS**

**MEDIUM AND HEAVY DUTY MODELS**







## CONVENTIONAL CHASSIS-CAB MODELS

**Low cost conventional-cab models are offered in a wide choice of wheelbases in the 12,000 to 29,000 lb. GVW range. These are Chevrolet's most popular haulers and include models just right for almost every big trucking job. All models**

**feature Chevrolet's advanced chassis design with variable rate suspension at front and rear axles — the proven suspension system which provides load protection and extra durability. Money-saving High Torque engines are available for every job requirement in medium and heavy-duty service. Chevrolet's range of medium and extra-heavy-duty transmissions and rugged rear axles allow a choice of power train components which assures you of a truck designed and built to do your job better. Chevrolet chassis-cabs are your profitable answer to big payload savings on any job.**

**C-60 Series (GVW Rating 19,500 lbs. to 25,500 lbs.)  
(GCW Rating 32,000 lbs. to 42,000 lbs.)**

Chevrolet's preferred haulers are offered in a choice of five wheelbases from 133" to 197". Standard power train for these popular models includes the High Torque 292 six, with smooth shifting 4-speed Synchro-Mesh transmission and a 15,000 lb. capacity rear axle with 7.20 to 1 ratio. \*Big V8 power, \*5-speed transmission and \*single or two-speed rear axles up to 18,500 lbs. are optional.

\*optional at extra cost



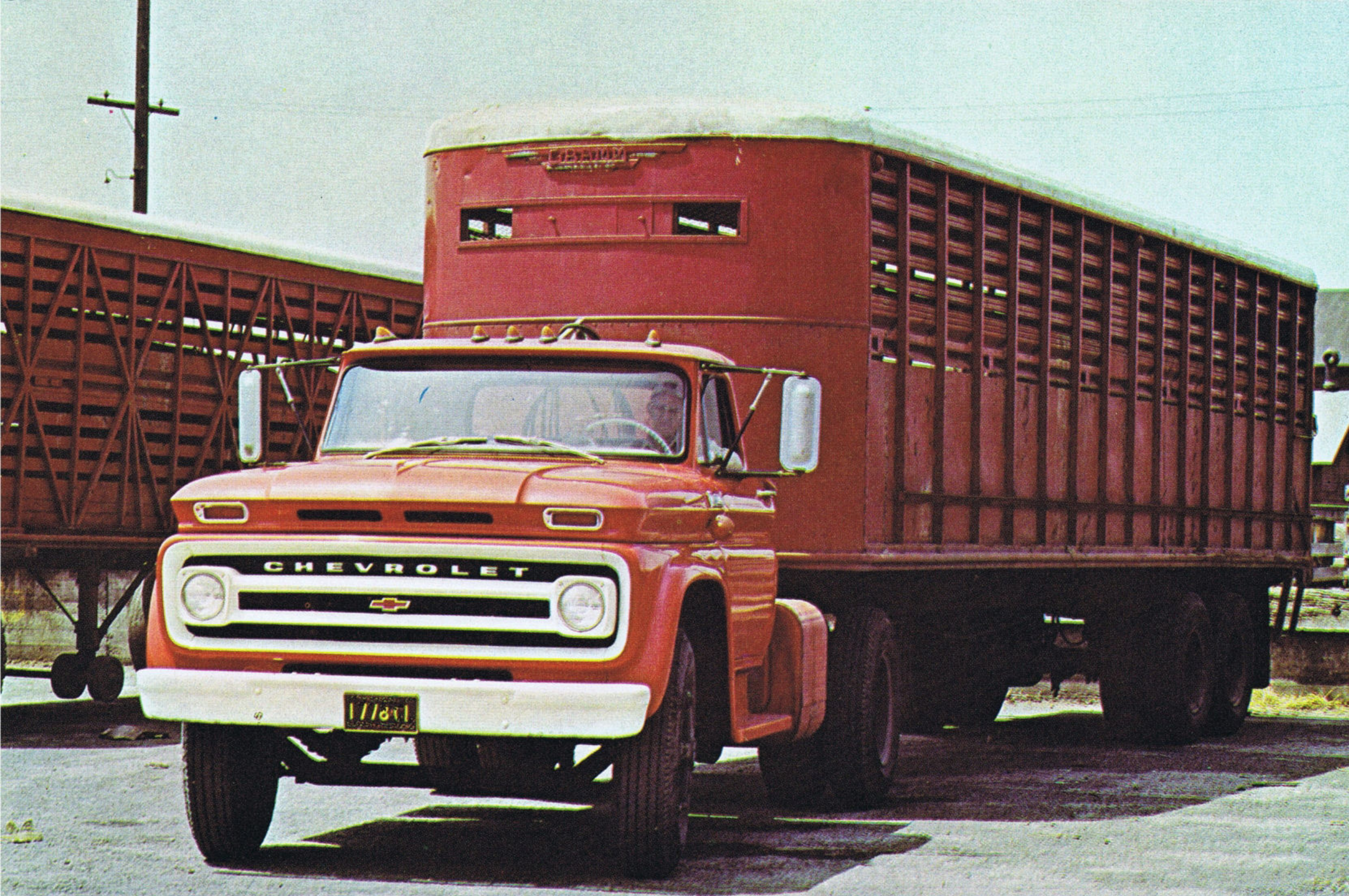

**C-80 Series (GVW Rating 25,000 lbs. to 29,000 lbs.)  
(GCW Rating 51,000 lbs.)**

Chevrolet's C-80 heavy duty chassis cabs are equipped for long, hard service. You have a choice of five wheelbases — 133", 145", 157", 175" and 197". Standard power is the High Torque 348-V8 driving through a 5-speed Spicer transmission and 18,500 lb. rear axle. A wide choice of optional equipment is available and includes a \*409-V8 engine, \*high capacity transmissions and \*23,000 lb. single and two-speed rear axles.

**SPECIFICATIONS**

Model	Wheelbase	Maximum Rated Body-Payload Weight
C5103	133"	11,050 lb.
C5203	145"	11,000 lb.
C5303	157"	11,000 lb.
C5503	175"	10,900 lb.
C6103	133"	18,300 lb.
C6203	145"	18,250 lb.
C6303	157"	18,200 lb.
C6503	175"	18,150 lb.
C6803	197"	17,900 lb.
C8103	133"	21,450 lb.
C8203	145"	21,450 lb.
C8303	157"	21,350 lb.
C8503	175"	21,200 lb.
C8803	197"	21,000 lb.



**C-50 Series (GVW Rating 12,000 lbs. to 20,000 lbs.)  
(GCW Rating 25,000 lbs.)**

Designed for low-cost general hauling, C-50 chassis-cabs are available in a choice of four wheelbase sizes — 133", 145", 157" and 175". Standard equipment includes the High Torque 230 six-cylinder engine, Chevrolet 4-speed Synchro-Mesh transmission, 5,000 lb. front axle and 11,000 lb. capacity rear axle with hypoid gears. Parallel 34" frame allows easy mounting of any type of body.

\*optional at extra cost





**T50, T60 and T80 Series (GVW Rating 12,000 lbs. to 29,000 lbs.)  
(GCW Rating 25,000 lbs. to 51,000 lbs.)**

## TILT CAB MODELS

New Series T50 tilt cab models extend the choice for 1965. Now you can choose Chevrolet tilt cab models with GVW ratings from 12,000 lbs. to 29,000 lbs.

Chevrolet tilt cab models give you the best of cab-forward design — the most compact on the road for the ultimate in high load-space efficiency. Length from bumper to back of cab is only 72". Front wheels are set well back giving you the best in visibility, manoeuvrability and weight distribution plus easy engine accessibility. Triple-safe locking system anchors the cab down securely, or releases it quickly, completely exposing engine and front end components for servicing. A big, adjustable, torsion-bar counter-balance spring makes cab tilting easy. Access panels inside the cab permit routine oil and water checking without tilting the cab. Best of all, gear shift and other control linkages are mounted on a stationary central control island which is unaffected by cab tilting.

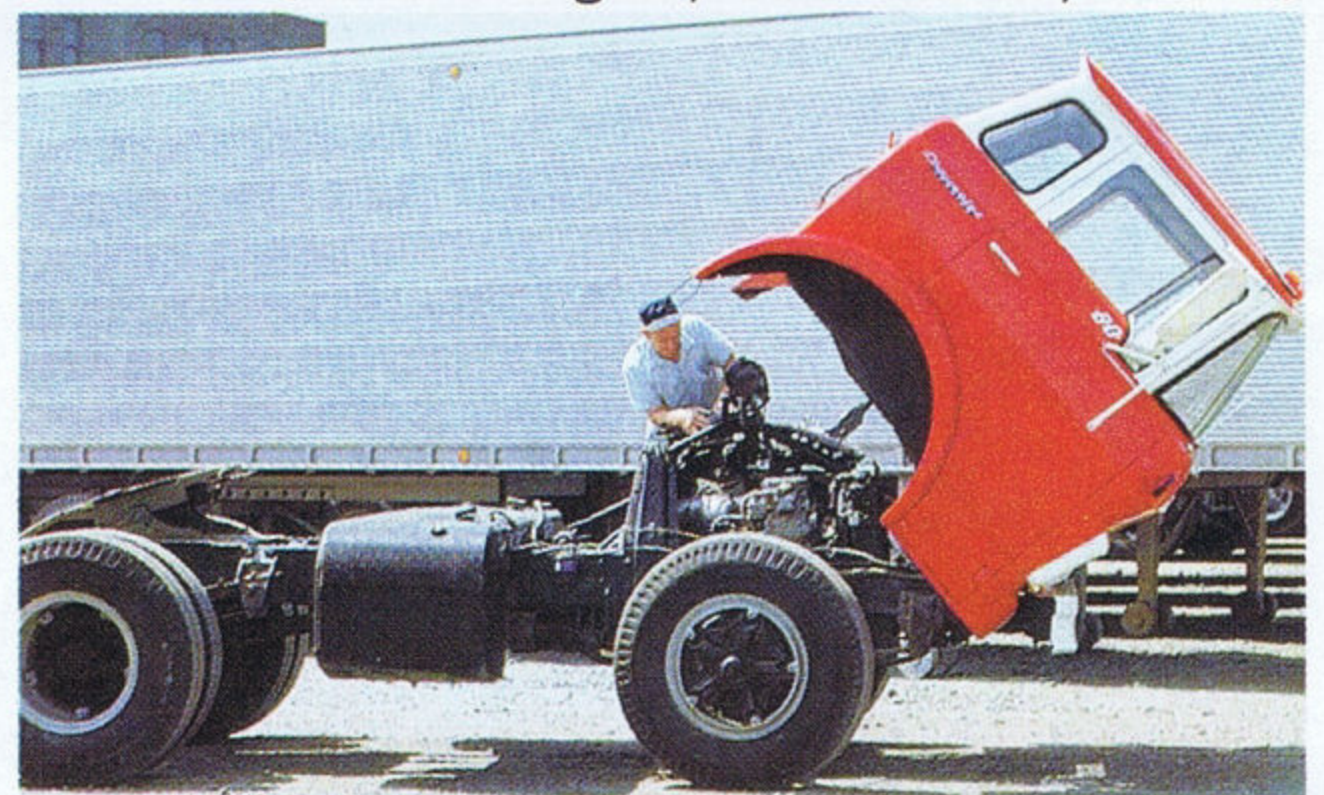

Model	Wheelbase	Maximum Rated Body Payload Weight
T5203	97"	14,750 lb.
T5303	109"	14,700 lb.
T5603	133"	14,600 lb.
T5803	145"	14,550 lb.
T5903	175"	14,350 lb.
T6203	97"	18,250 lb.
T6303	109"	18,200 lb.
T6603	133"	18,150 lb.
T6803	145"	18,000 lb.
T6903	175"	17,600 lb.
T8203	97"	21,250 lb.
T8303	109"	21,200 lb.
T8603	133"	21,150 lb.
T8803	145"	20,950 lb.





**M60 and M80 Series (GVW Rating 30,000 lbs. to 43,000 lbs.)  
(GCW Rating 35,000 lbs. to 51,000 lbs.)**

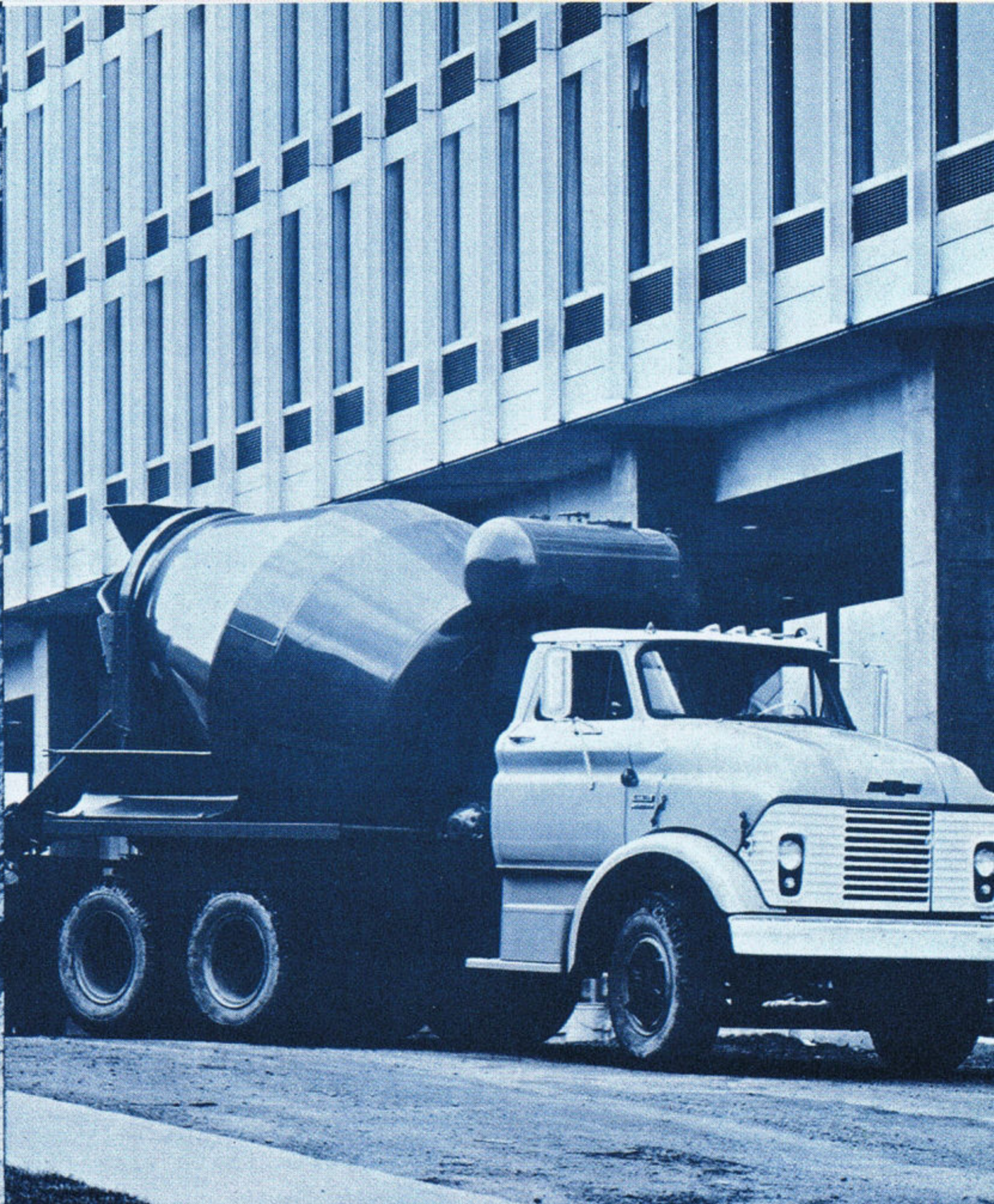

**W80 Series (GVW Rating 36,000 lbs. to 43,000 lbs.)  
(GCW Rating 51,000 lbs.)**

## TANDEM MODELS

**Chevrolet's 1965 line of tandem models meets the demands of off-road and construction industry operators everywhere. From the trailing axle Model M60 to the big diesel-powered W80 they all offer a full range of extra-heavy-duty components to handle bigger-than-ever jobs.**

In each series, models are available in 7', 8½' and 10' C.A. sizes, all built on extra-tough tandem frames. Tandem bogies range from 28,000 to 34,000 lbs. capacity, with front axle ratings up to 11,000 lbs. Drive line options include a two-speed rear axle for M60's, 3- and 4-speed auxiliary transmissions for M80's, plus extra-heavy-duty 5-speed and 8-speed main transmissions. Tandem power is big-truck all the way. From the 292 Big Six to the 409-V8 and 6V-53N Diesel — they're all built to do the job better!

Whatever your job needs in the way of a tandem truck, Chevrolet will build it for you best.

### TANDEM MODELS

Model	Wheelbase	Maximum Body and Payload Weight
M6303	157"	22,250 lb.
M6503	175"	22,100 lb.
M6803	193"	21,900 lb.
M8303	157"	31,900 lb.
M8503	175"	31,650 lb.
M8803	93"	31,500 lb.
W8303	145"	30,900 lb.
W8503	163"	30,750 lb.
W8803	181"	30,500 lb.



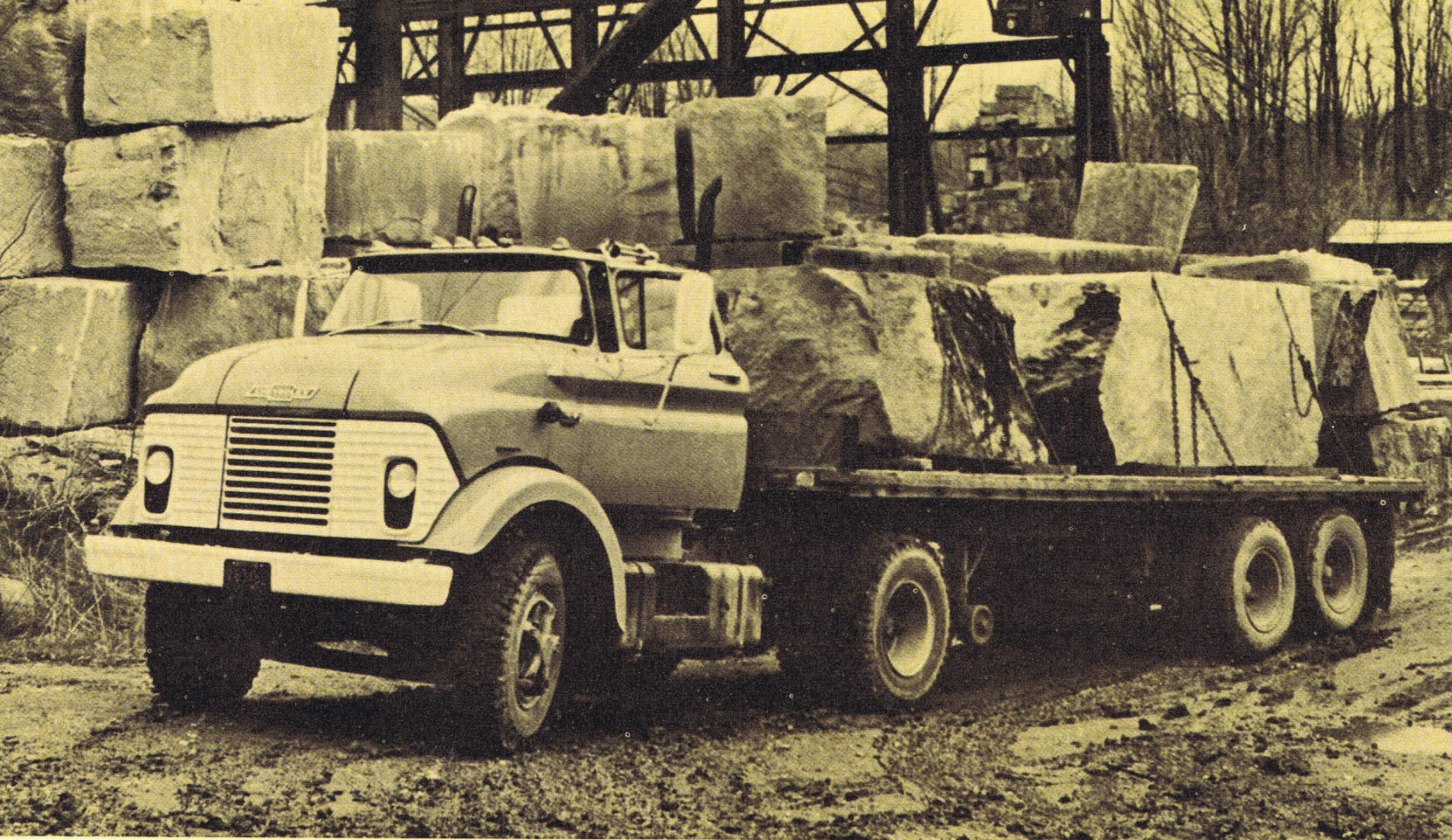

## DIESEL MODELS

**WHY DIESEL?** — Diesel's high torque and efficiency have always made it a natural as a truck power plant. In the past, only weight and bulk were against it, limiting road applications of early diesel engines to the biggest heavy-duty trucks. Continuing development in the field has led to engines small enough, light enough and versatile enough for trucks in much lower GVW classes. In this area GM Diesel has traditionally pioneered and led the field, and it is the GM Diesel 53N engines that have made the breakthrough a reality.

All the benefits of diesel power are delivered in full by these engines. Fuel consumption substantially less than gasoline engines in the same duty; long life and low maintenance costs thanks to the ruggedness and mechanical simplicity inherent in GM Diesel engine design.

Diesels cost more to build and command a premium in purchase price . . . but their operating cost savings pay it back fast from the minute they hit the road. On jobs that can keep a diesel busy, the break-even point comes up quickly. Fully utilized, a 6V-53N GM Diesel is a gilt-edged investment bound to brighten up any balance sheet.

### E80 SERIES

**GVW Rating - 25,000 lbs. to 29,000 lbs.**  
**GCW Rating - 51,000 lbs.**

#### UNIT INJECTION FUEL SYSTEM —

This exclusive GM Diesel feature times and meters fuel precisely. High pressures are confined to the injector. Supply pump circulates surplus fuel to help cool the injectors during operation.

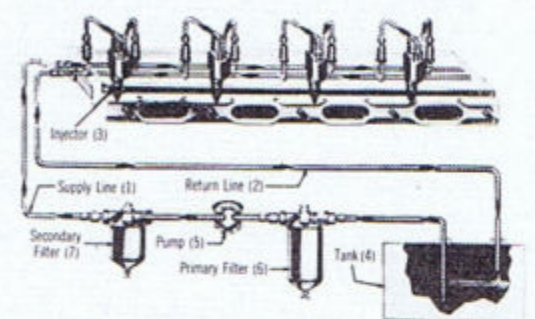

**UNIT INJECTORS** — A high-pressure pump activated by the camshaft meters exact quantities of fuel and forces it, thoroughly atomized, into each cylinder for quick, complete combustion.

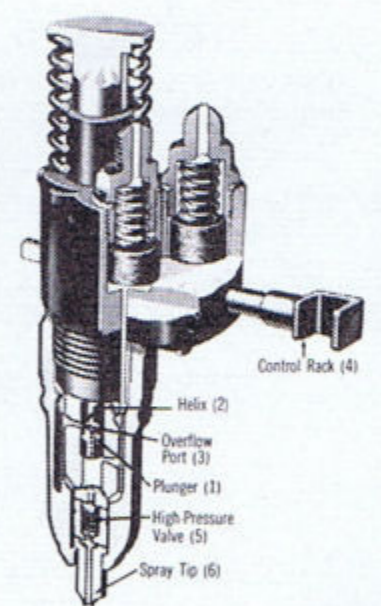

#### UNIFLOW AIR SYSTEM —

The GM diesel design uses both ends of the working portion of the cylinder. Intake ports are uncovered by the piston near the end of its down-stroke, admitting air for scavenging action. Four valves in the head let the exhaust escape freely with minimum back pressure.

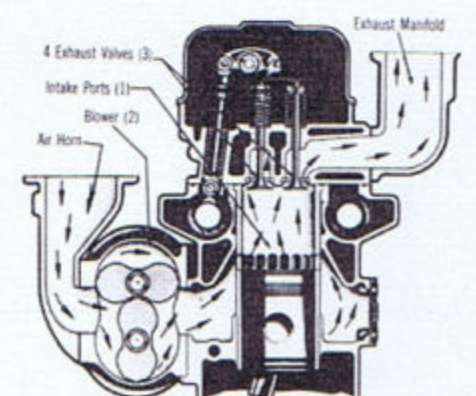



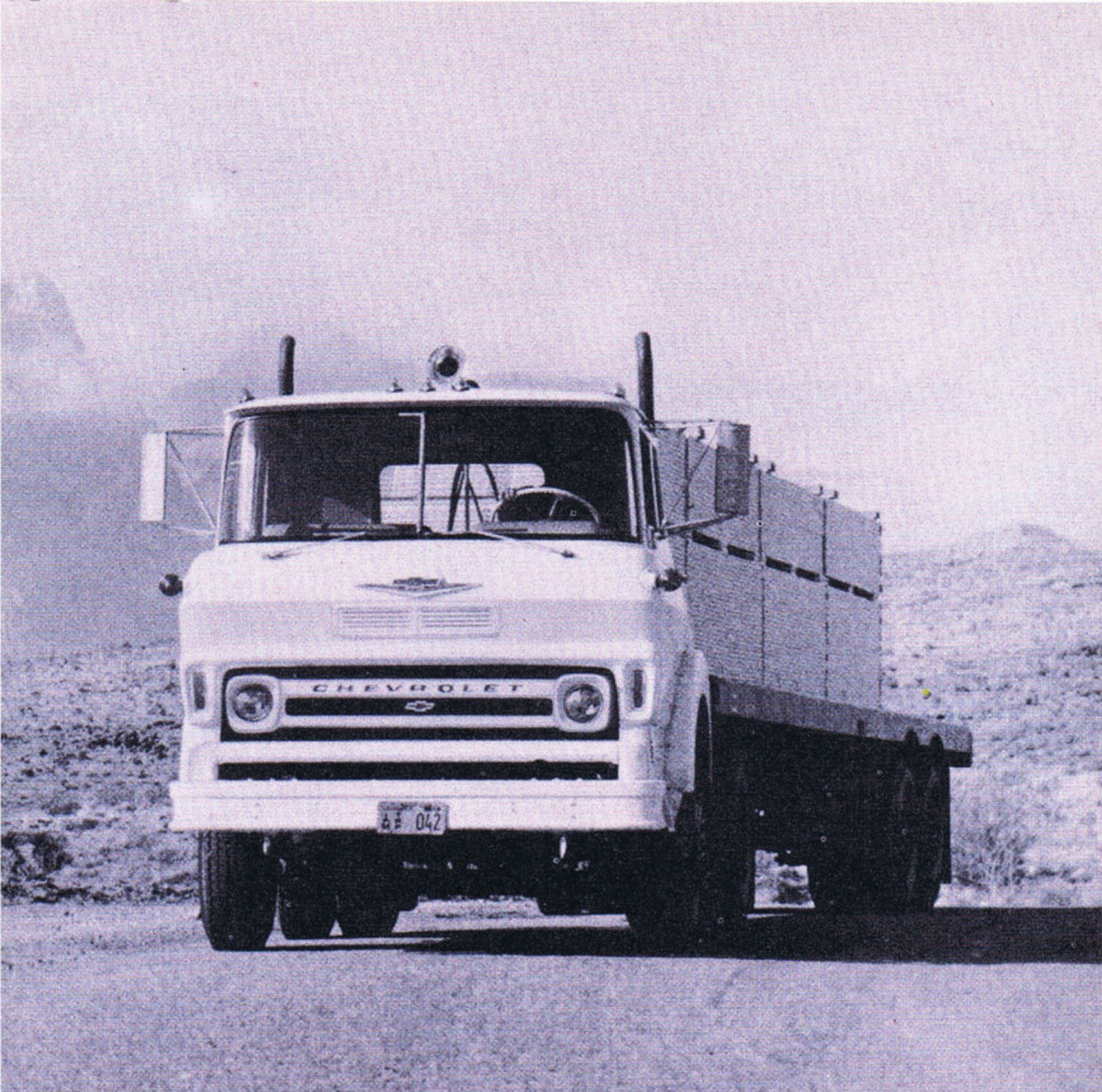

**U80 SERIES — 72" cab tilt models**  
GVW Rating - 25,000 lbs. to 29,000 lbs.  
GCW Rating - 51,000 lbs.

**Team a tough truck chassis with hard-driving profit-making power — and what more could anyone ask for in a truck? The results are yours to enjoy when you turn a Chevy Diesel loose on your job. With drive-line components custom-tailored to the diesel's special brand of horsepower, you get a package engineered from the ground up to deliver the goods — all the fuel savings, durability, dependability and long life that diesels are famous for.**

**Chevrolet makes them to match just about any job in the 25,000 lb. to 43,000 lb. GVW range — including tandem models in the W80 Series. Extra-heavy-duty rear axle options for both single and tandem-axle models round out a full line of extra-heavy-duty drive line components for big-job versatility.**

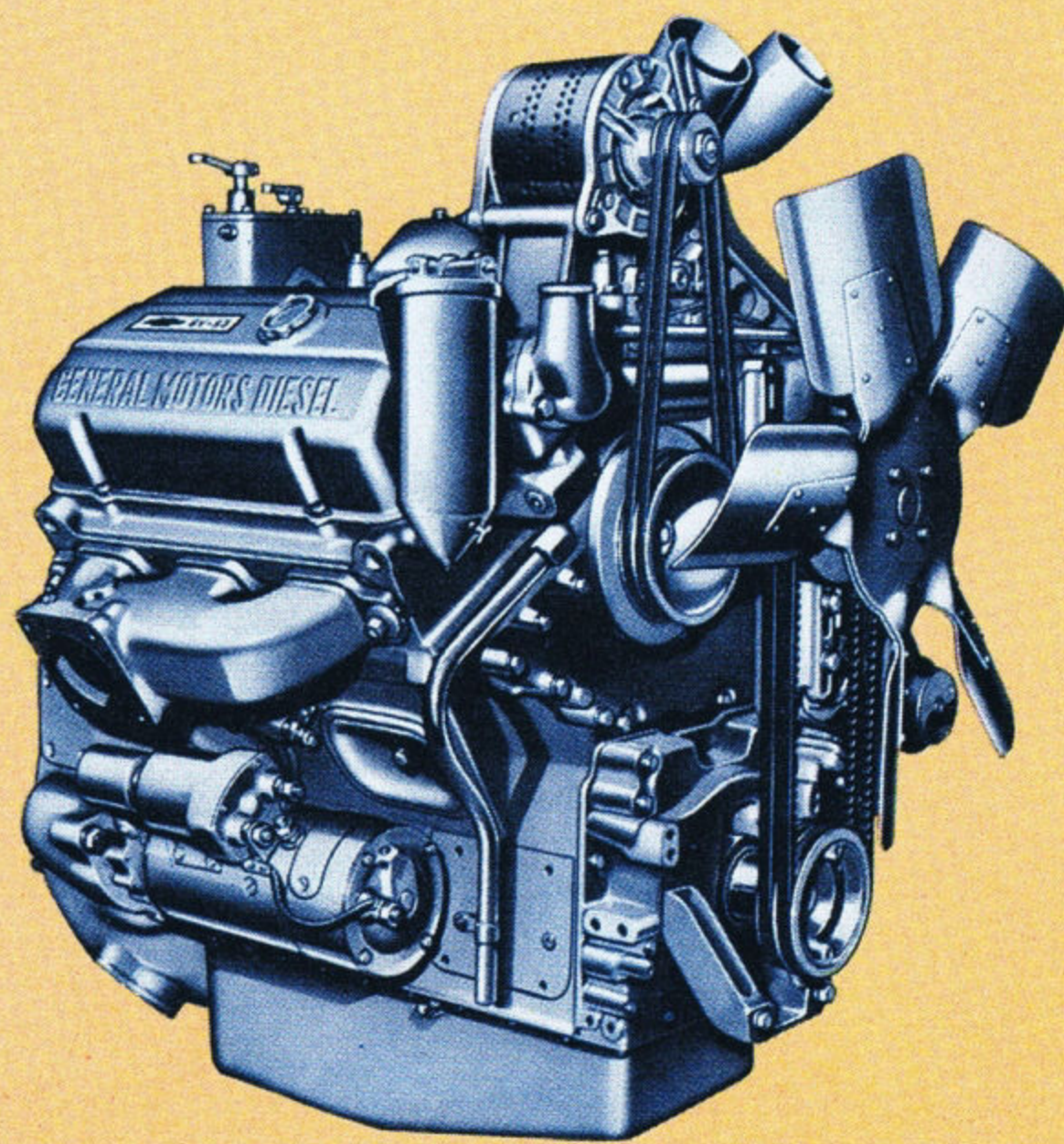

## **6V-53N DIESEL**

**6V-53N GM DIESEL ENGINE** — Economical, durable power is provided for Chevrolet 80 series diesels by the most advanced design engine in the diesel industry... the 6V-53N. Its two-stroke cycle design means that every downstroke is a power stroke. High compression is the chief reason for diesel high efficiency . . . and the 6V-53N diesel features an extra-high compression ratio for a brand of horsepower at low rpms that gets big loads moving fast . . . and handles the steepest grades without a fuss.



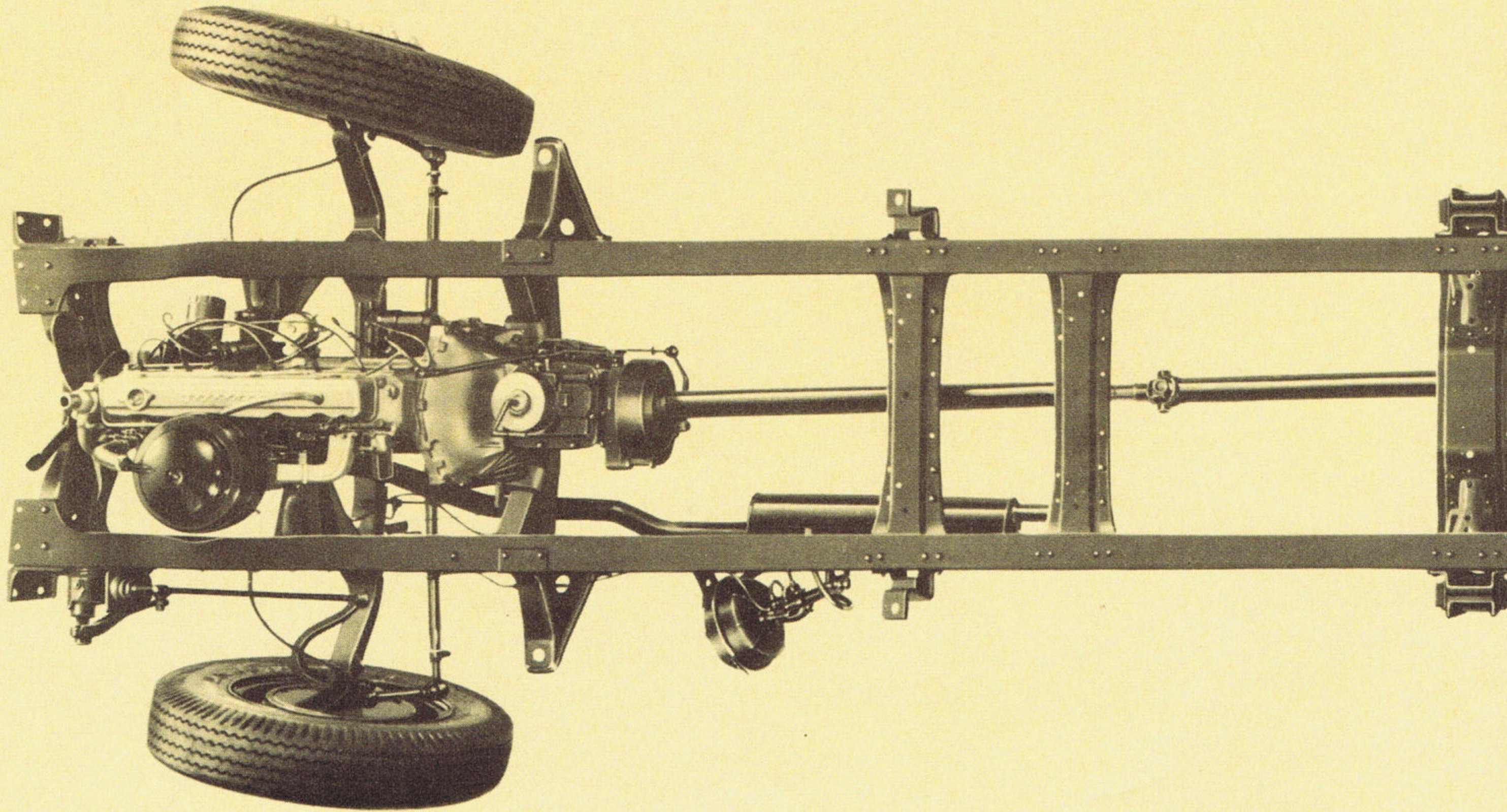

## CHASSIS FEATURES

Chevrolet's '65 big-truck chassis give you more of the features that keep a truck on the job, working better and costing less. There's extra strength where it counts in the tough ladder-type frames plus built-in resilience to shrug off the roughest shocks on or off the road. Sure-control steering is matched to suspension action and cushioned against shock and vibration. The all-around variable-rate suspension is work-proved to give the ultimate in ride, stability and durability. \*Extra-heavy-duty options in job-tailored springs and axles will match any of your job needs better than ever. In Chevrolet's chassis, dead weight is designed out and extra durability built in to give you a trim tough chassis for pure working toughness to stay longer and save you more on your roughest jobs.

\*optional at extra cost

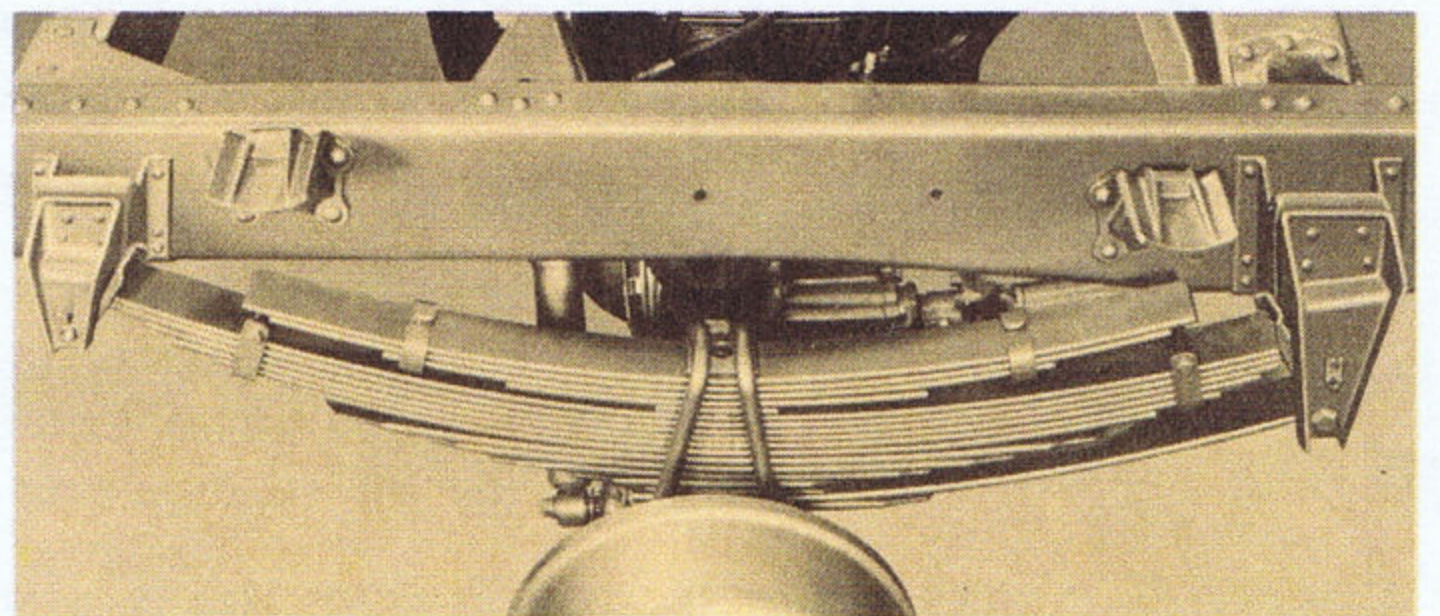
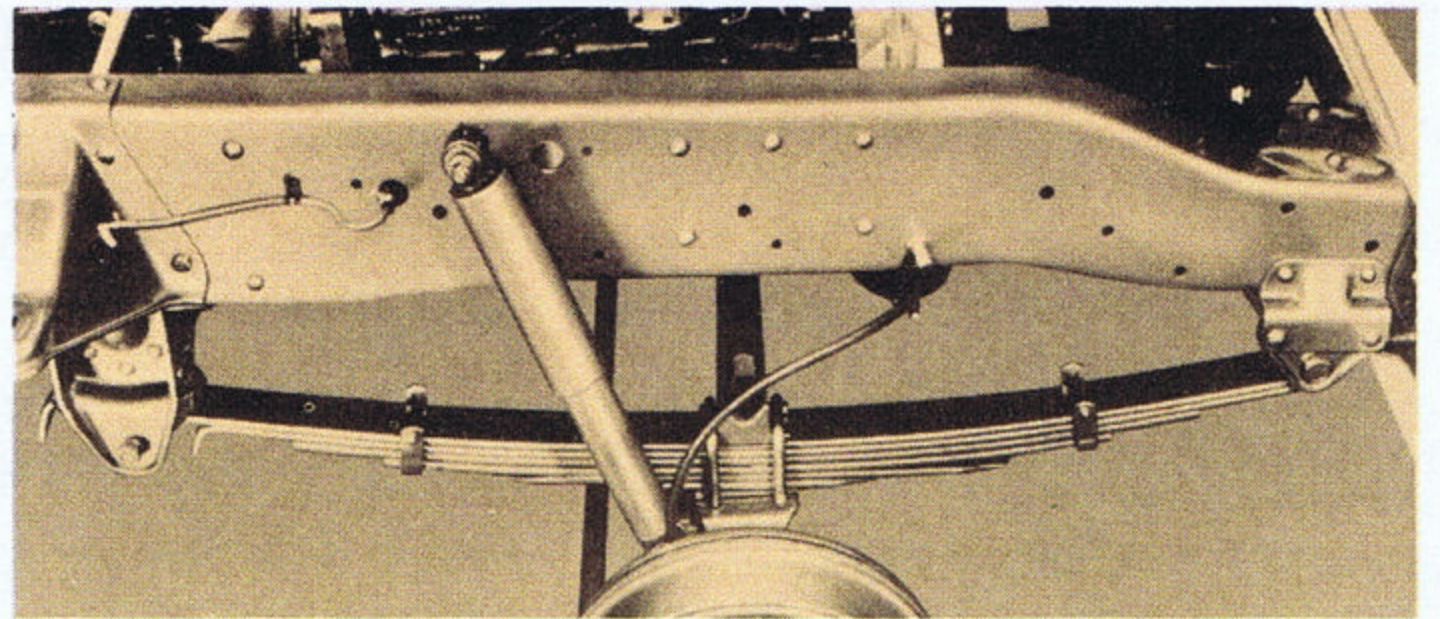

**VARIABLE-RATE SPRINGS** — Give you the best in ride and reserve load capacity. Since the load on truck springs varies from curb weight to maximum GVW, this principle is about the ultimate in truck suspension systems. Spring stiffness increases automatically with increased loads and decreases with lesser loads, giving an easy ride under any load conditions.



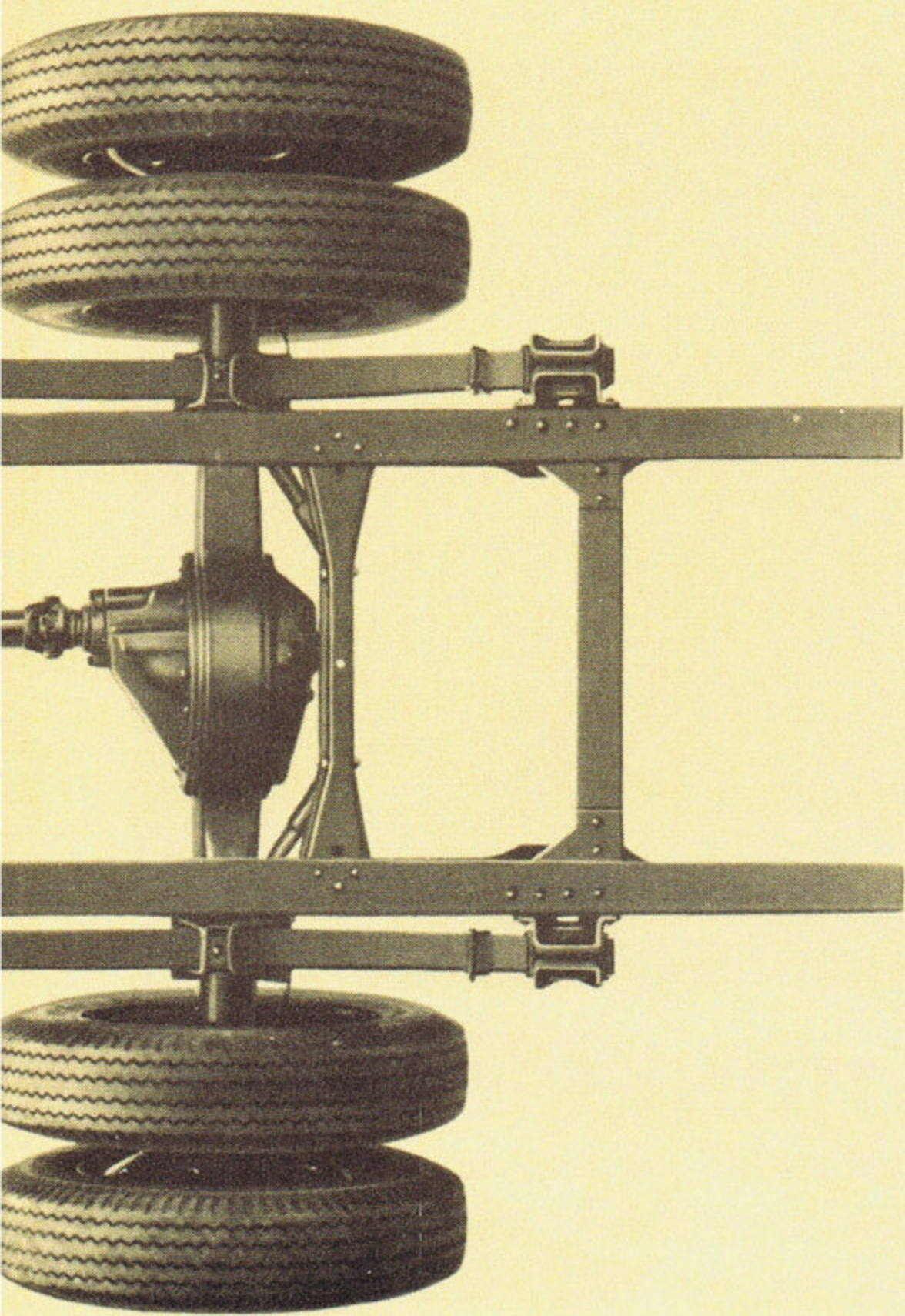

## TANDEM CHASSIS

All Chevrolet tandem chassis are designed to put durability and dependability foremost, to stand up to the rugged working conditions common to most tandem applications. Chevrolet-Hendrickson trailing-axle bogie for Series M60 models combines 15,000 lb. Chevrolet drive and trailing axles with the Hendrickson suspension giving a 28,000 lb. capacity rating. Standard equipment in both gasoline and diesel powered Series 80 tandems is the Eaton-Hendrickson bogie with capacities up to 34,000 lbs. True-tracking Hendrickson bogie rear suspensions feature four-point mounting to spread the load and prolong frame life, plus equalizing action that "walks" the rear wheels over the roughest terrain.

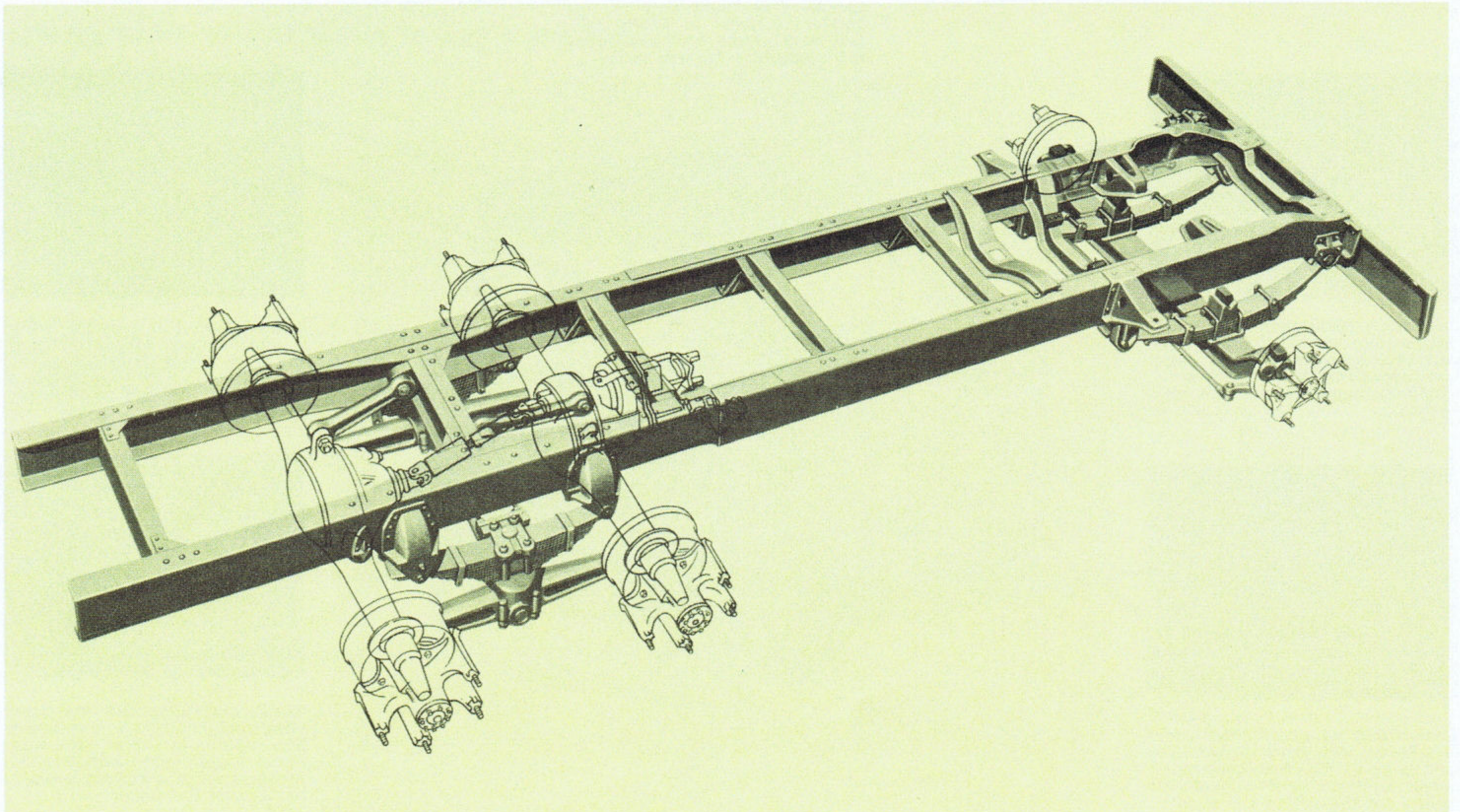



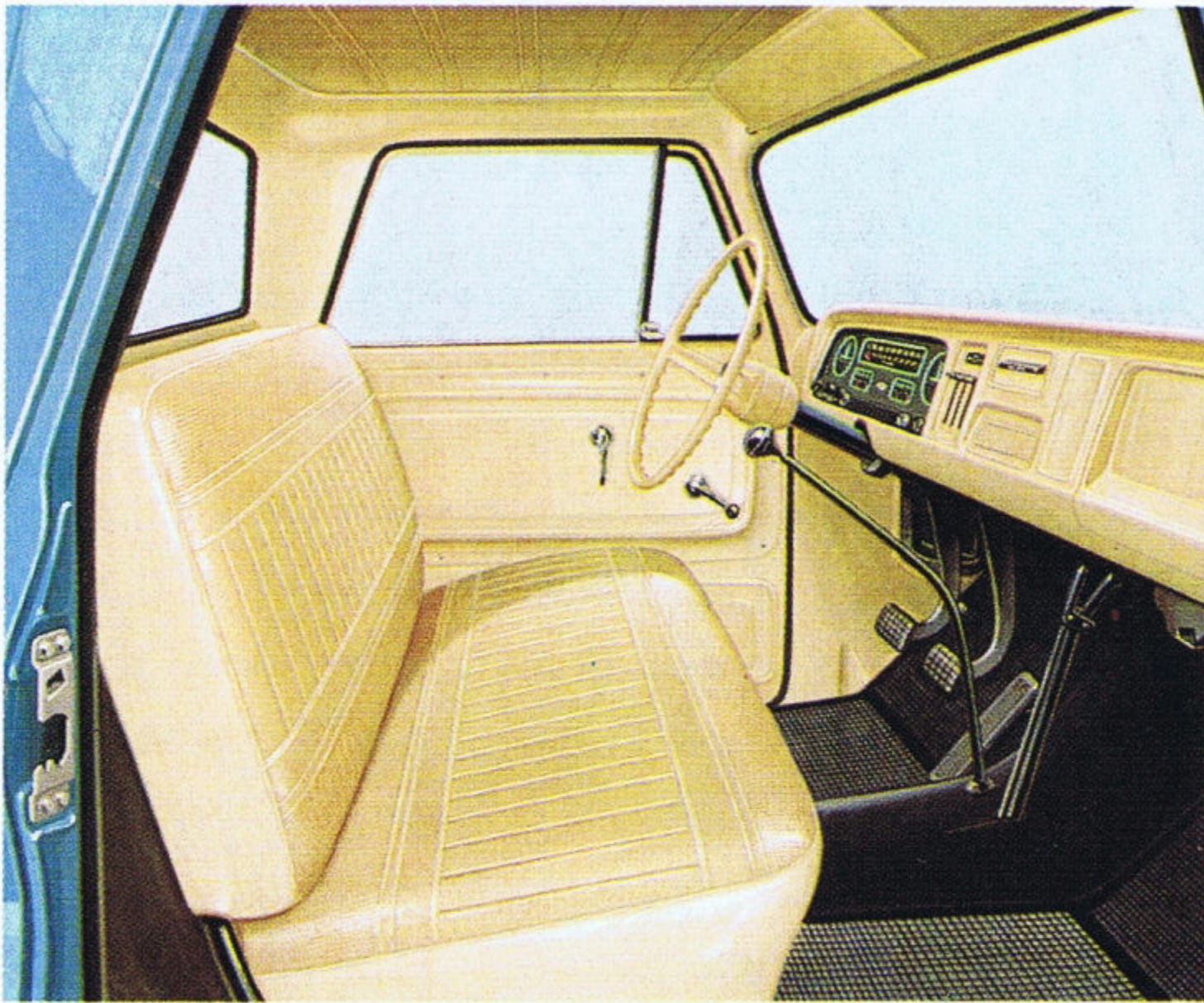

## CAB FEATURES / CONVENTIONAL

A standard feature of every Chevrolet cab is the extra comfort and convenience, designed to make long hours at the wheel as easy as possible. You find it in improved insulation and in deep-cushioned seats with durable all-vinyl upholstery—or nylon fabric and vinyl trim with Custom Comfort



\*Full-depth foam seat cushion is also available as a separate option in standard all-vinyl upholstery (except in diesel models and series M80 equipped with auxiliary transmission).

equipment. It shows, too, in well-placed controls, easy-to-see instruments, and generous all-around visibility. In addition to eye appeal, the \*Custom Comfort option includes a full-depth foam seat cushion, left armrest, right sunshade, right door lock, cigar lighter and extra insulation.

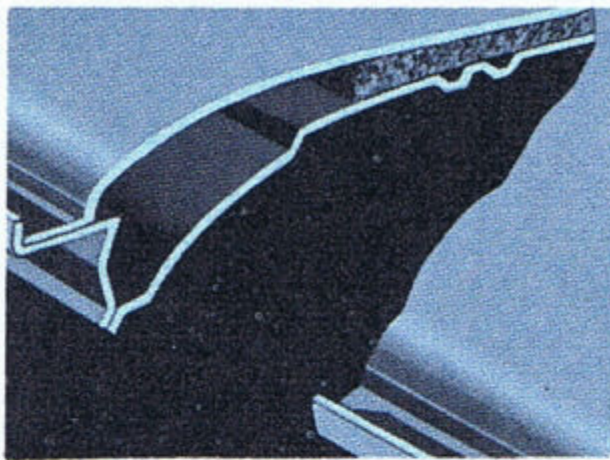

Deep-sculptured, heavily insulated and reinforced roof panels add rigidity to the entire cab structure and prolong cab life—also help keep out noise, heat and cold.

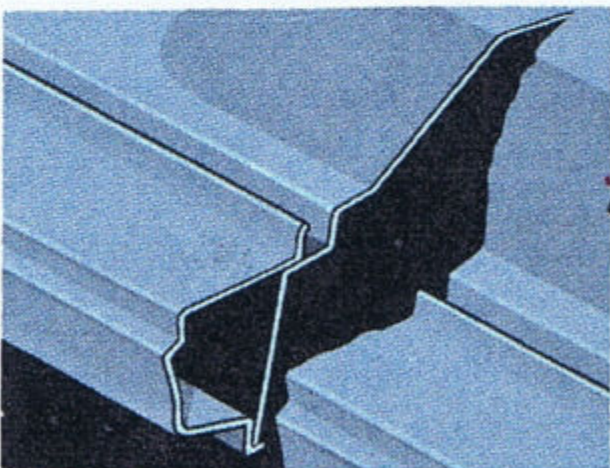

Box-section pillars support roof and frame doorways in permanent alignment — help keep cab doors working smoothly, sealing tightly for the life of the truck.

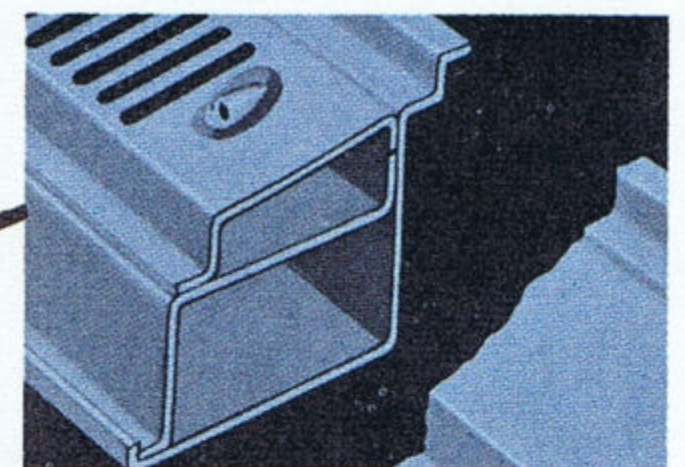
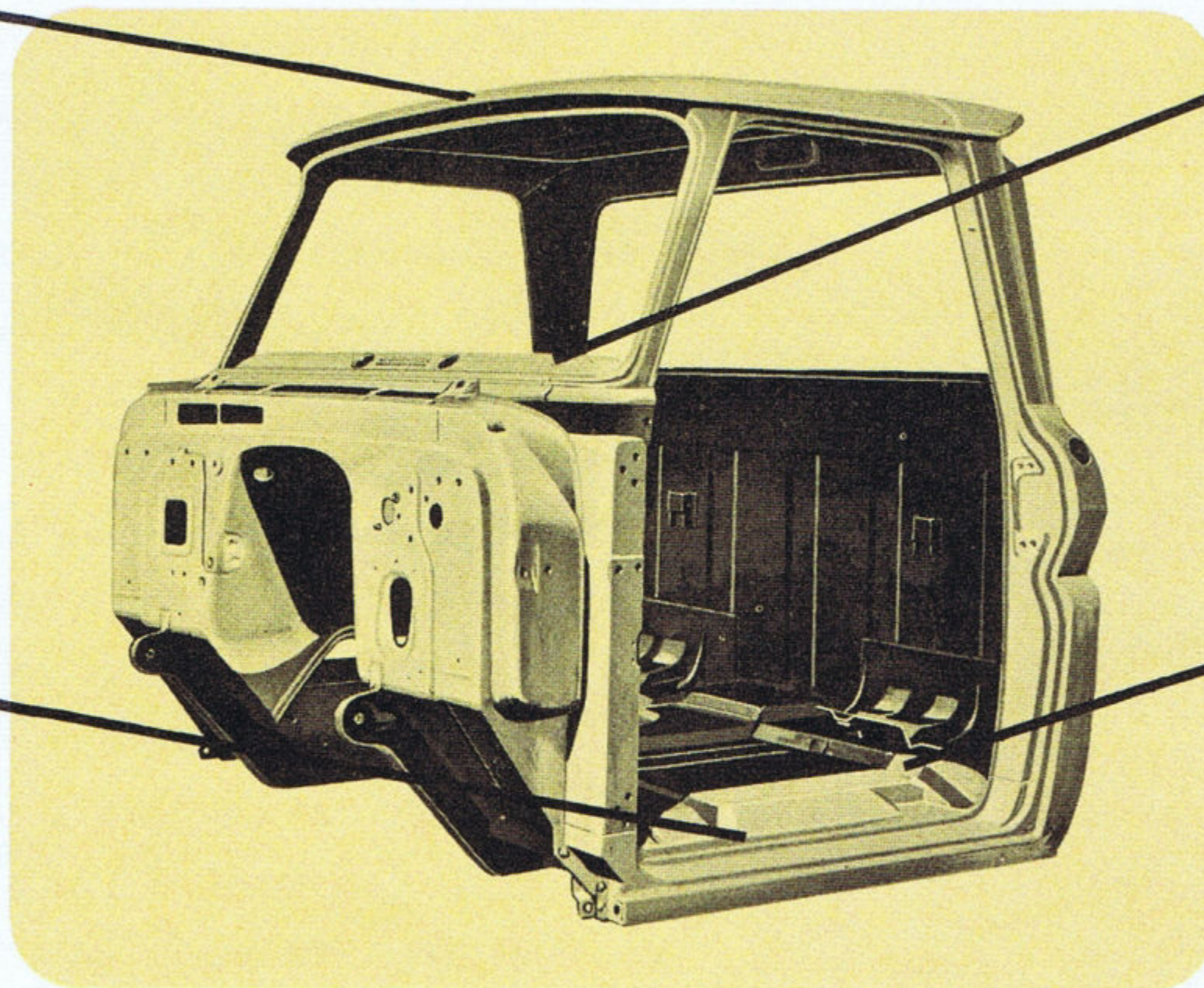

Double-walled cowl arch forms a massive box girder bridging the front of the cab — gives extra rigidity to cab structure and forms efficient High-Level ventilation plenum.

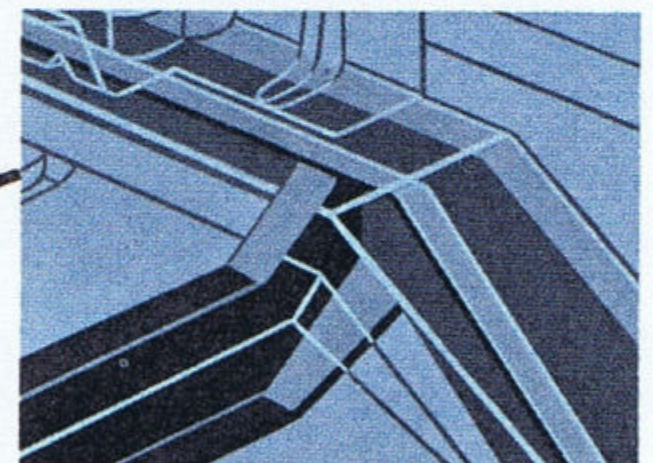

Reinforced floor and toeboard structure is solidly built and thoroughly insulated to stay quiet. Rigid crossmembers plus fore-and-aft sills extend forward to support toeboard.

\*optional at extra cost



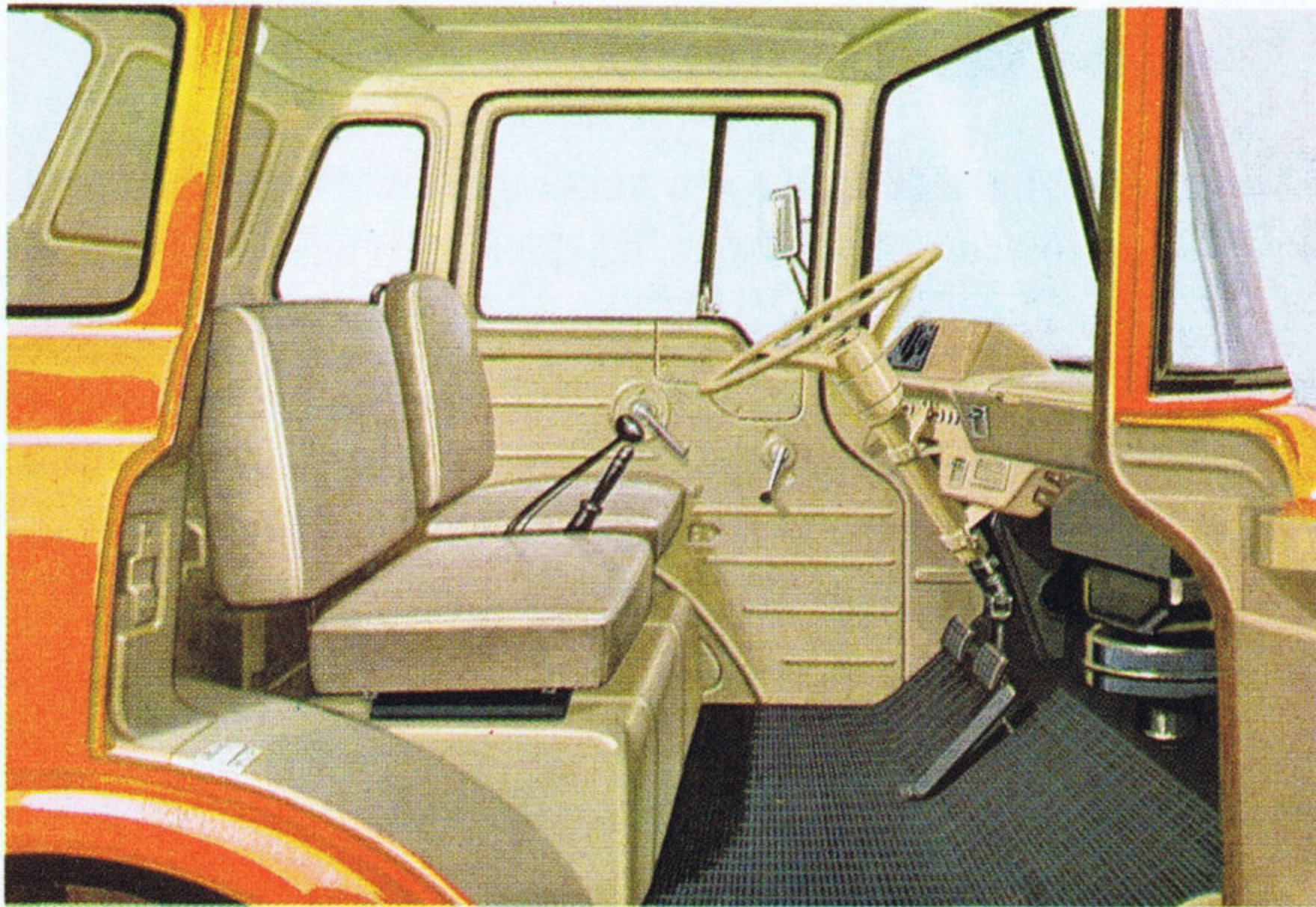

## TILT CABS

The ultra-compact Chevrolet tilt cab featured in Series T50, T60 and T80 models is exceptionally roomy inside with head and leg room to spare for the biggest drivers. A comfortable all-vinyl driver's seat is standard, with a 2-man companion seat available as an extra-cost option. A giant 2-piece windshield gives an unsurpassed view of the road, and features powerful 18-inch electric wipers. High-Level ventilation is built in for all-weather comfort, aided by precision-built doors and doorways that seal tight and stay right. Anti-glare-finished instrument panel is easy to read under all conditions, with a raised cluster centering all instruments directly in front of the driver.

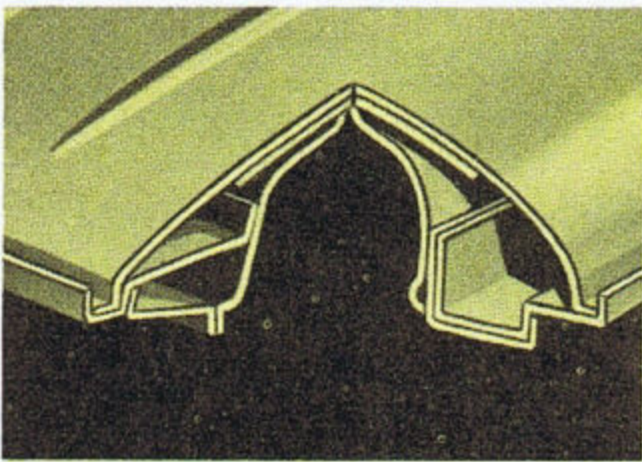

Sculptured roof panel is extra rigid with reinforced headers forming halo-type inner support. Heavy insulation helps keep out noise and weather for extra comfort.

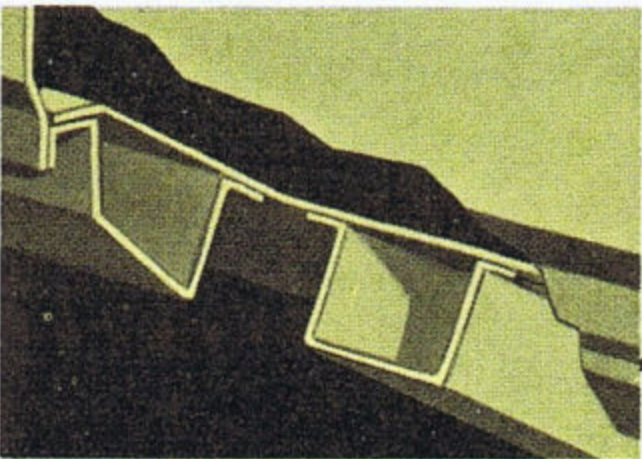

High-strength cab framing, with heavy-gauge hat-section sills at front, rear and sides, reinforces entire structure and forms a solid foundation for mounting cab.

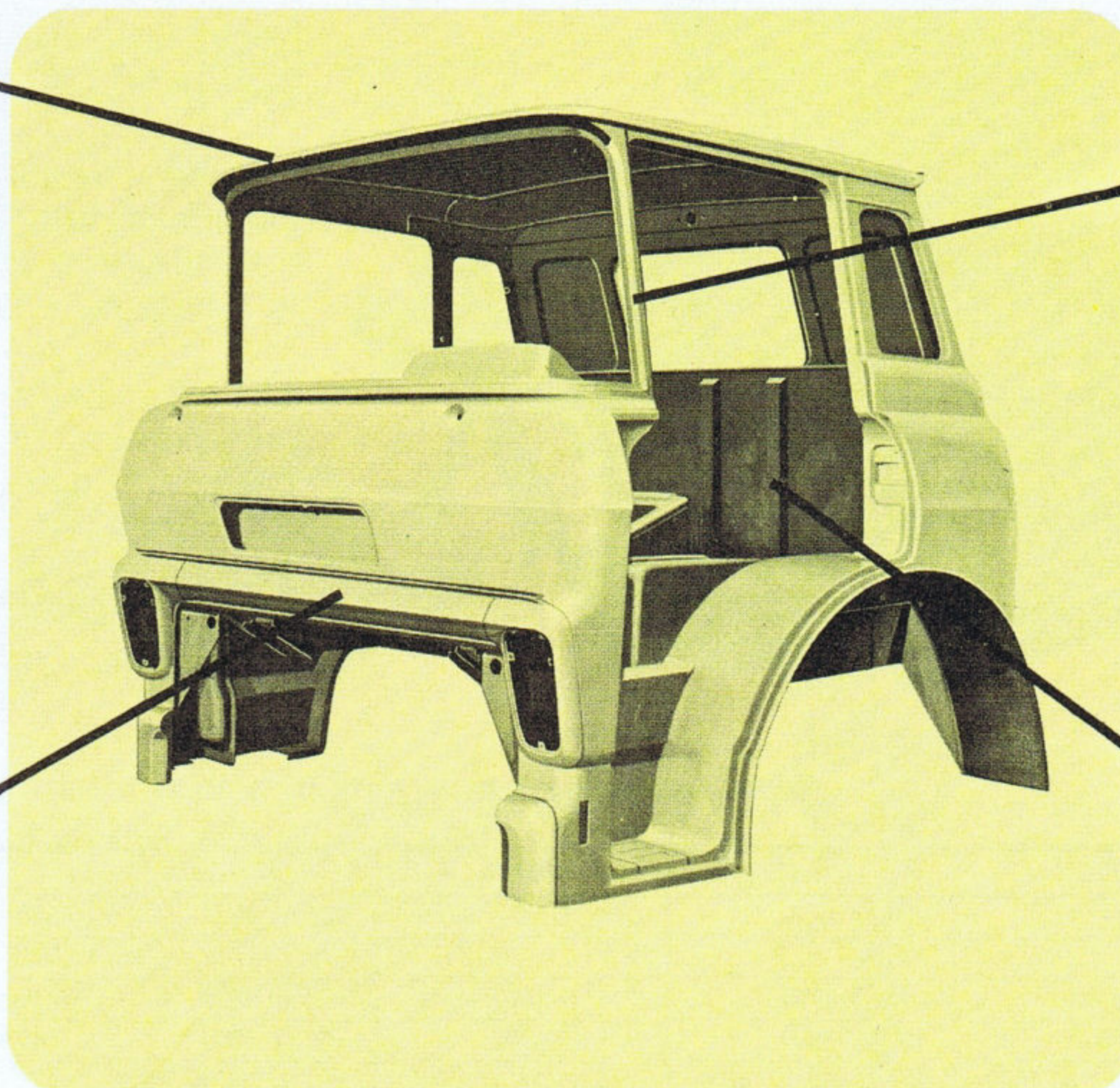

Reinforced box-section roof pillars are slim-styled for extra visibility. Doorways are framed precisely and permanently to keep doors working smoothly and sealing tight.

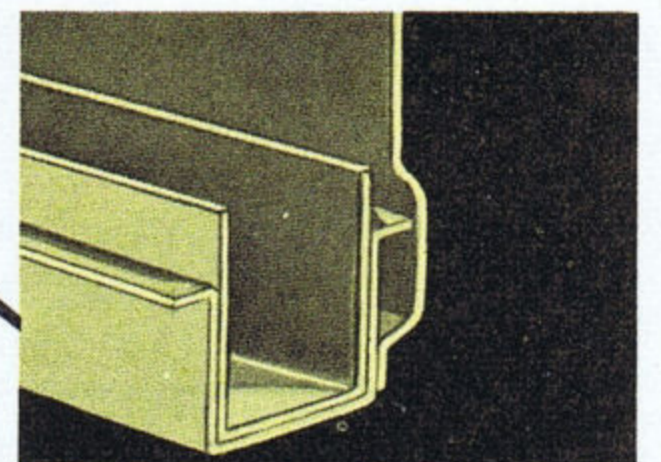

Double-reinforced centre section houses locking mechanism for securing cab in driving position. A rear crossmember arches over engine to support rear of cab.

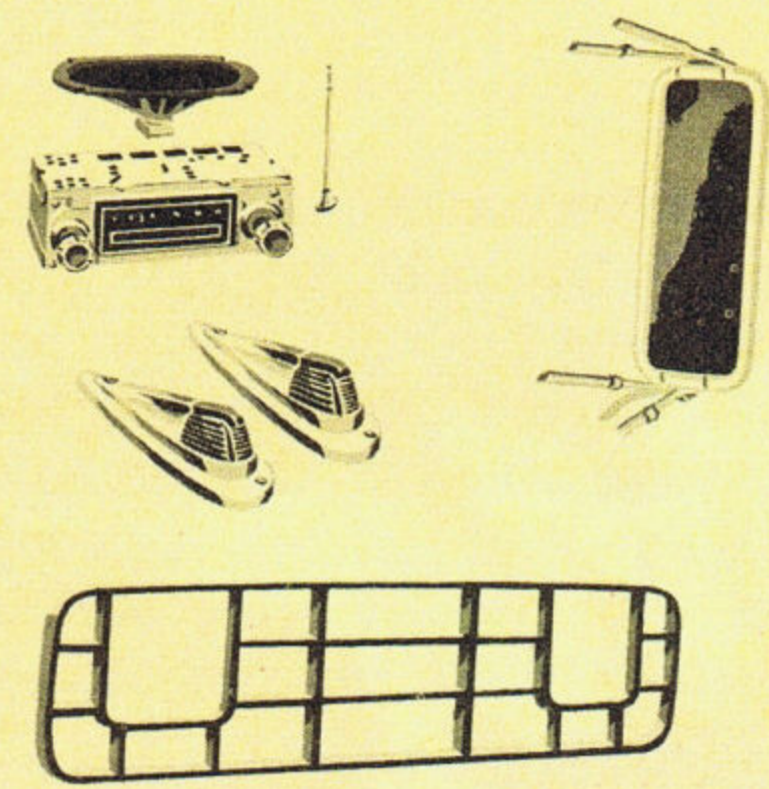

## CUSTOM FEATURE ACCESSORIES

A wide variety of dealer-installed Custom Feature Accessories is available to add extra comfort, convenience and safety to your truck. It's easy to custom-tailor your truck to your own special needs by choosing from items such as grille guards, clearance lights, special mirrors, mud flaps and seat belts. Ask your Chevrolet dealer for full details about the many Custom Feature Accessories he offers for every model.



# HIGH TORQUE ENGINES

The truck industry's most advanced engine lineup powers the Chevrolet medium- and heavy-duty truck line, including the right kind of power for every big-truck job. There's top efficiency and economy in the standard-equipment Sixes in Series 50 and 60 models, plus extra payload performance and durability in a line of \*five lean-muscled V8s, available optionally for medium-duty trucks and furnished as standard equipment in the big ones.

All are designed and built to the most exacting standards, employing the finest materials and the latest in manufacturing technology. The result is top efficiency, performance and durability with minimum bulk and weight. For long life at lowest cost, extra-duty design features are incorporated according to class of service, making each engine a job-tailored performer you can count on to deliver the goods without letting you down.

6

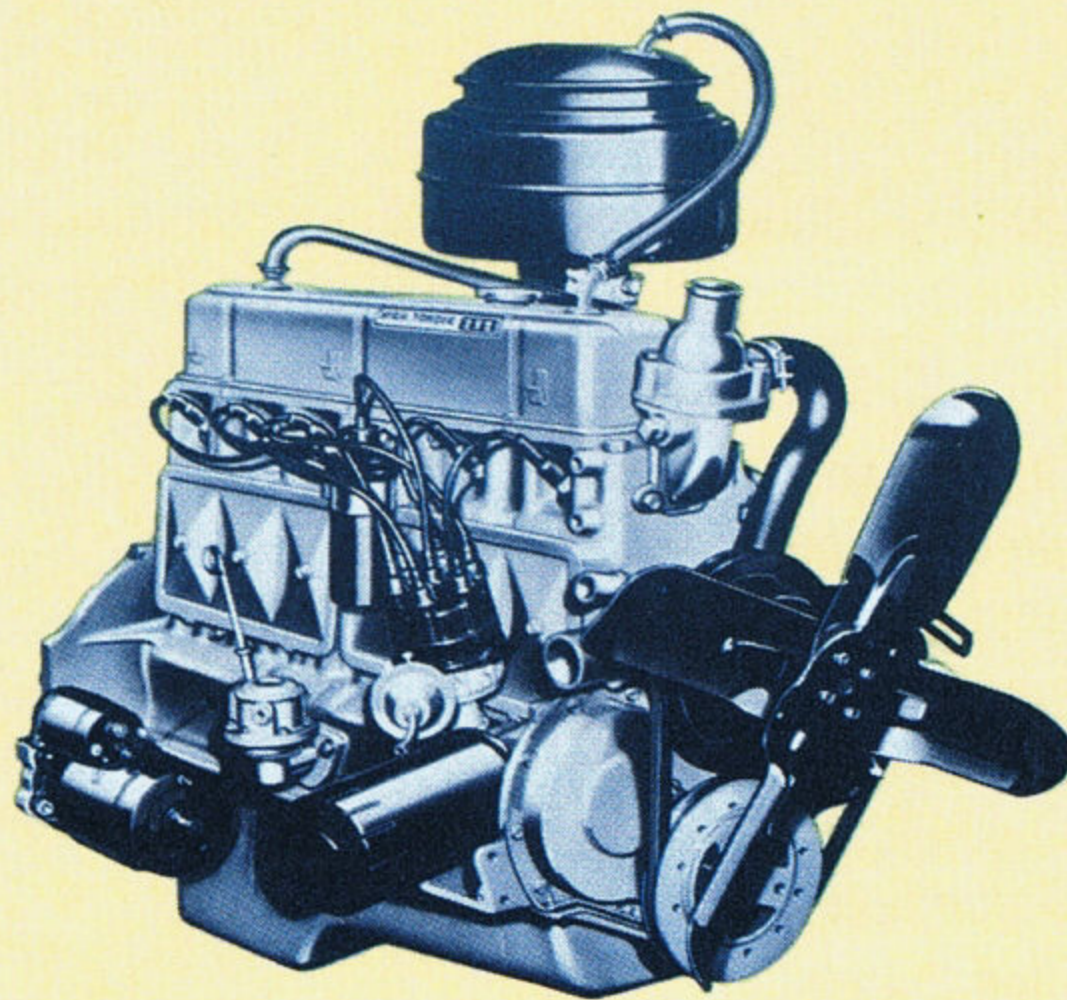

**292 SIX** — Standard big-sized engine in Series 60, \*heavy-duty option in Series 50. Heavy duty equipped throughout with extra rugged components.

**230 SIX** — High-efficiency engine standard in Series 50 models. Free-breathing valve-in-head design plus basic features designed for long life and low upkeep.

V8

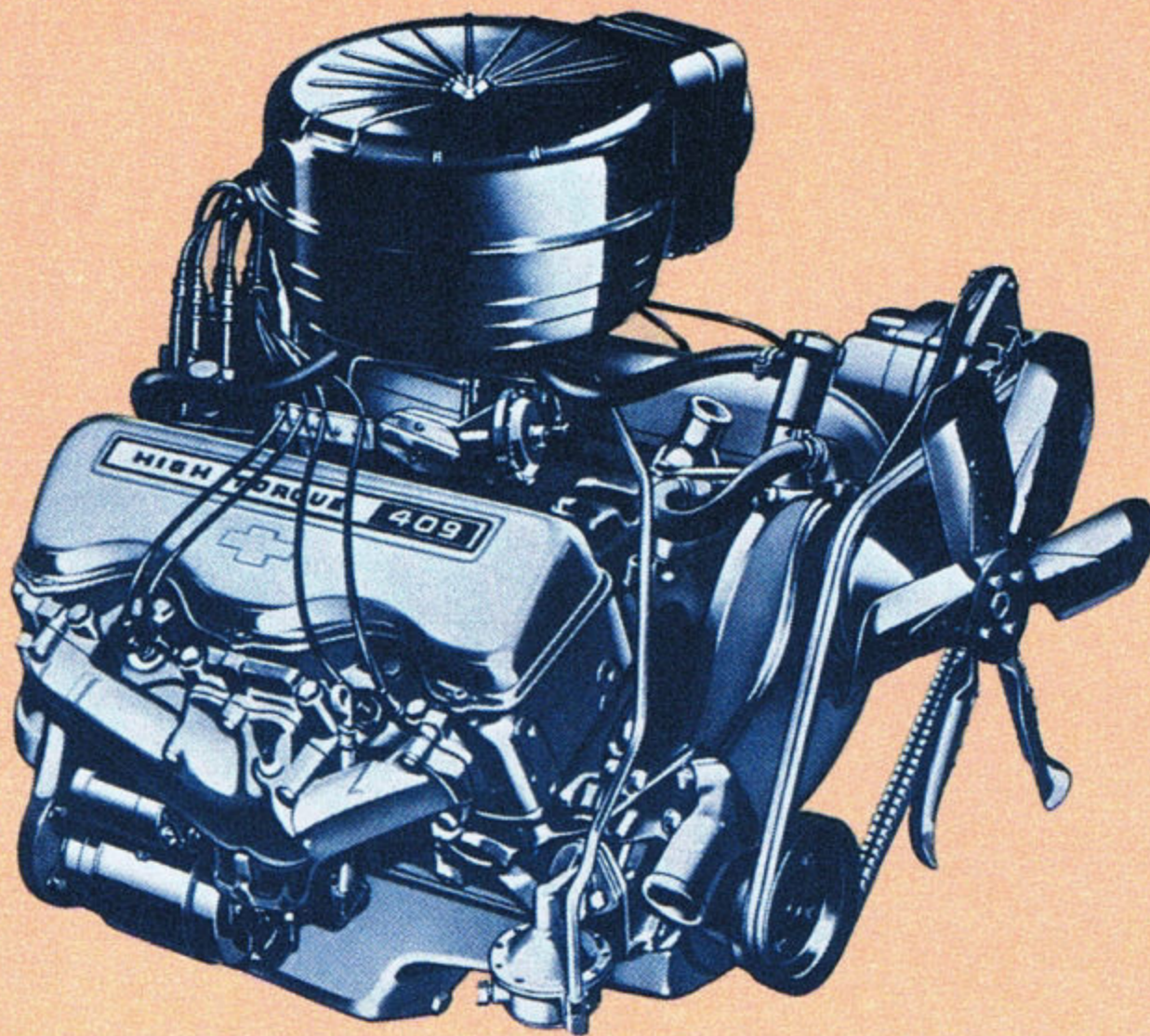

**348 V8** — Big-Truck power plant standard in Series 80 gasoline-powered models. Heavy duty equipped throughout including four-barrel carburetor for top performance.

**\*409V8** — Includes all the features for maximum durability and performance, as the top-power option for the toughest jobs, in Series 80.

**327 V8** — Extra Power \*option in Series 60 incorporates highest quality features for peak performance, efficiency and durability.

**283 V8** — \*Optional high-performance engine in Series 50. High efficiency design for long, dependable service.

## PERFORMANCE DATA

Performance Data	230 Six	292 Six	283 V8	327 V8	348 V8	409 V8
Piston Displacement	230 cu. in.	292 cu. in.	283 cu. in.	327 cu. in.	348 cu. in.	409 cu. in.
Compression Ratio	8.5	8.0	8.5	8.0	7.75	7.75
Gross HP @ rpm	140 @ 4400	170 @ 4000	175 @ 4400	185 @ 4400	220 @ 4400	252 @ 4000
Net HP @ rpm	120 @ 3600	153 @ 3600	145 @ 4200	158 @ 4000	180 @ 4000	215 @ 4000
Gross Torque @ rpm	220 ft.-lbs. @ 1600	275 ft.-lbs. @ 1600	275 ft.-lbs. @ 2400	305 ft.-lbs. @ 2000	325 ft.-lbs. @ 2600	390 ft.-lbs. @ 2400
Net Torque @ rpm	205 ft.-lbs. @ 1600	255 ft.-lbs. @ 2400	245 ft.-lbs. @ 2000	280 ft.-lbs. @ 2000	300 ft.-lbs. @ 2400	352 ft.-lbs. @ 2400

\*optional at extra cost



# DESIGN FEATURES

Efficient, uniform cooling results from the accurate control of internal water jacket wall thickness made possible by precision casting techniques — with head and block castings designed and fabricated to eliminate “hot spots”. Also, water jacketing completely surrounds the cylinder barrels over their full length, and cored passages in the heads assure thorough, efficient cooling of spark plugs, valve guides and exhaust ports. In all heavy duty engines, thermostatically controlled bypass cooling permits fast, uniform warm-up under load with maximum engine protection.

Positive full-pressure lubrication maintains a protective oil film between critical moving parts even under the toughest operating conditions. And full-flow filters on all engines make sure it's clean oil at all times with automatic bypass valves to prevent oil starvation in the event of filter clogging. Positive gear-type pumps are designed to deliver a healthy surplus of oil even in hard-pressed low-speed operation.

Job-matched Power-jet carburetors regulate fuel mixture according to load for top economy at all times consistent with extra performance when it's needed. Positive crankcase ventilation is standard in all engines.

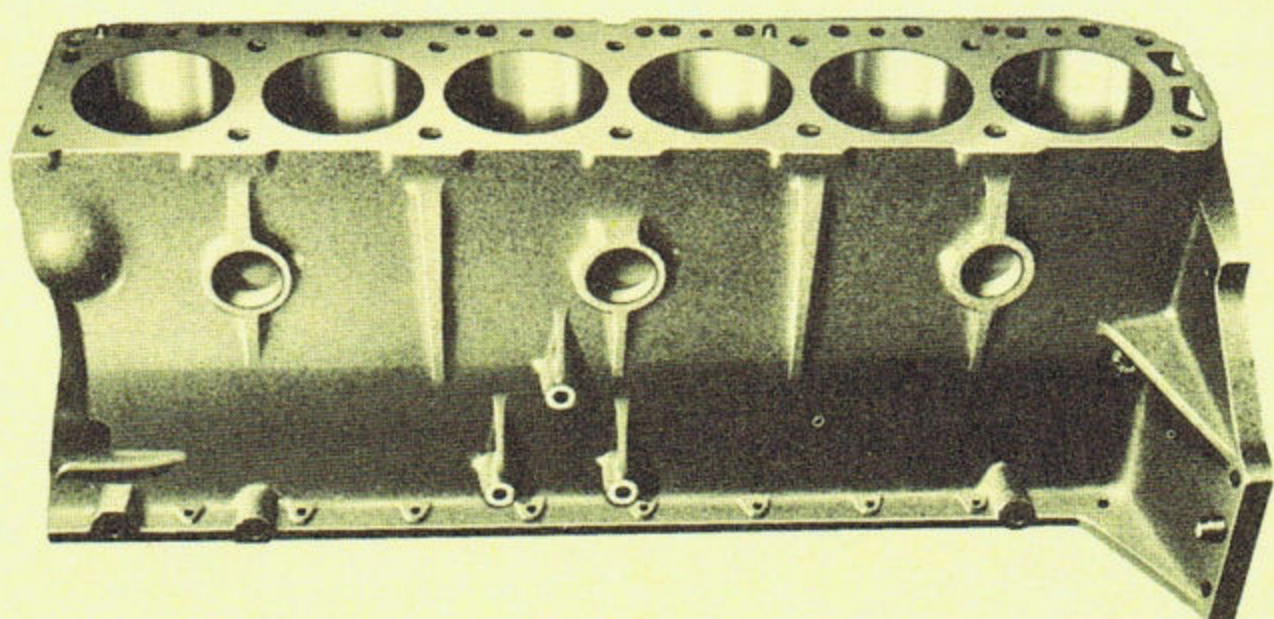

Precision-cast heads and blocks feature accurately controlled uniform-thickness wall sections, stiffened with integral-cast reinforcements for top rigidity with minimum weight. Efficient water jacketing and exhaust port design minimize demands on cooling system.

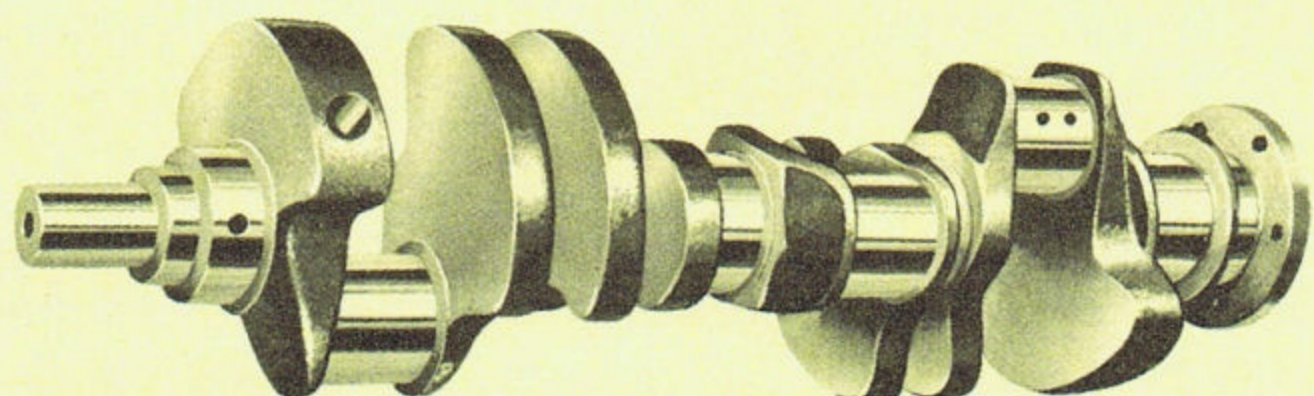

Six-cylinder crankshafts feature seven-main-bearing design for extra bearing area and rigidity, and top rigidity comes naturally in the extra-short five-bearing V8 crankshafts. Precision-type main bearings feature bearing alloys job-tailored to duty class from high-quality babbitt in the 230 Six to aluminum in the heavier duty engines.

Free-breathing valve-in-head design features big valves tailored to displacement and smooth-contoured low-restriction porting for top efficiency in each engine — a must if both performance and fuel economy are to be at their best. Modified wedge-type combustion chambers promote top combustion efficiency, permitting the use of high compression ratios to get the most out of regular-grade fuel.

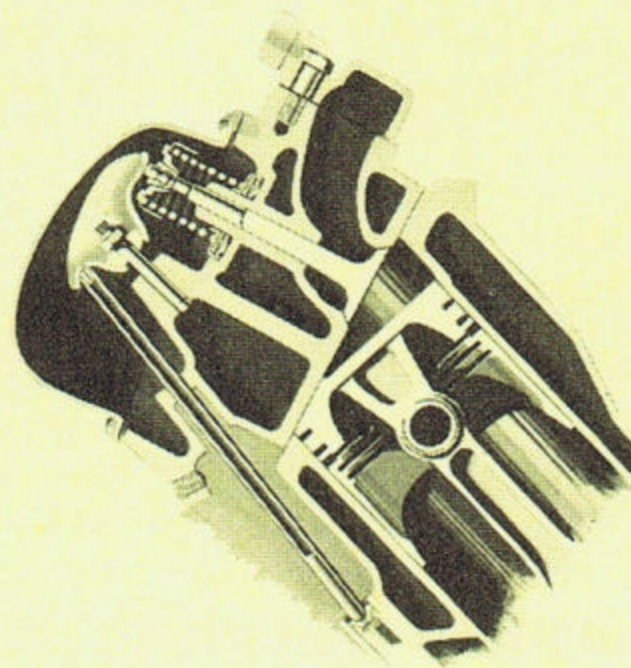

Long-life valving is specially designed to withstand the high temperatures big-truck service imposes, with heat-resistant alloy steels and the better cooling efficiency of integral valve guides. Additional extra-duty features are incorporated in all heavy-duty engines from the 292 Six up, including aluminized coating on all intake valves, (except on 283 in Series 50) stellite exhaust valve facings, (except on 283 in Series 50) and exhaust valve rotators. All engines feature zero-lash hydraulic valve lifters plus light-weight aero-type rocker arms for efficient valve action.



Long-lasting lightweight pistons are of cast aluminum alloy with cast-in steel struts, and top rings are full-chrome-faced for minimum wear. Short, stiff connecting rods feature precision-shell bearings of alloys tailored to duty class.



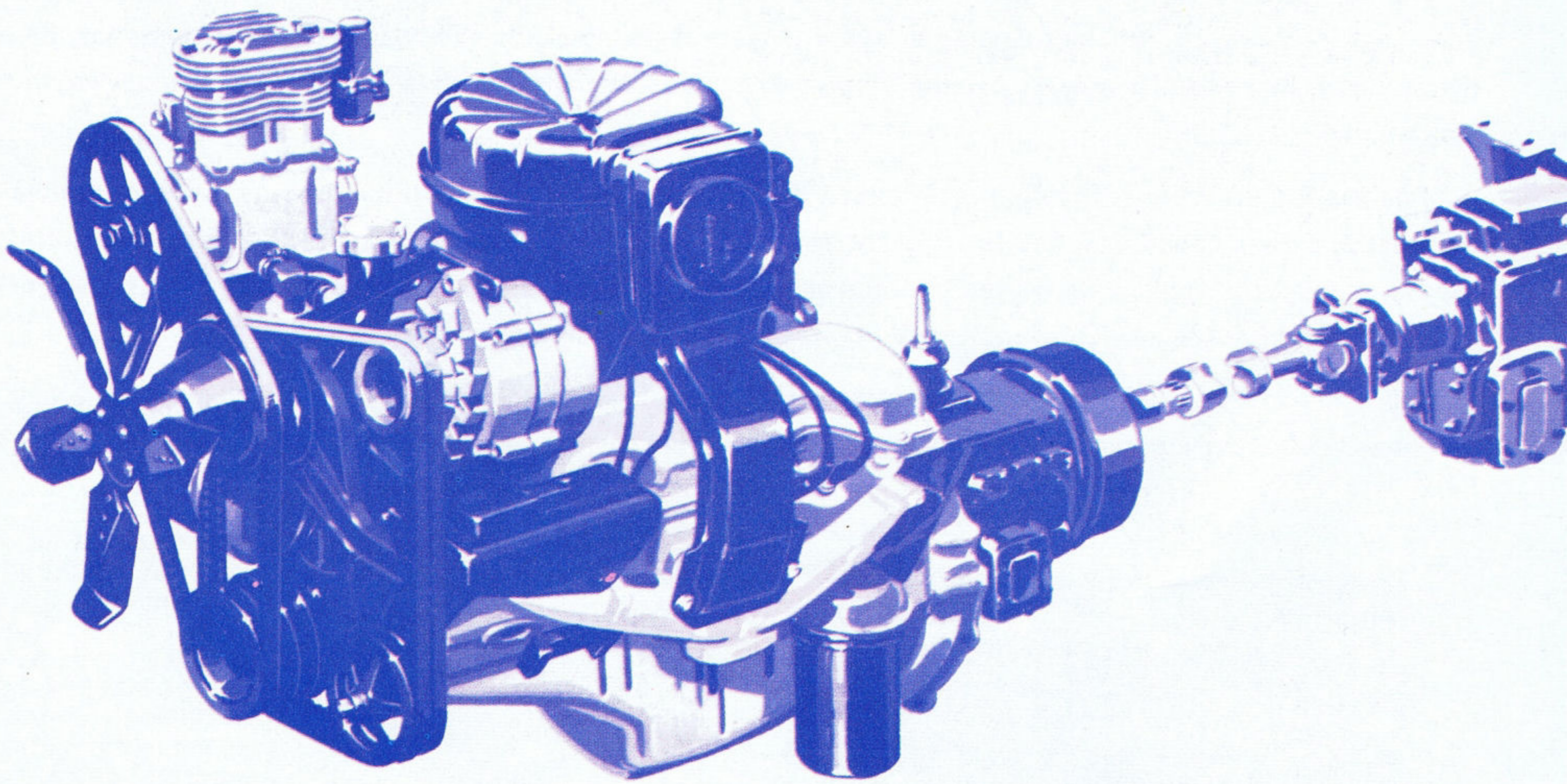

## POWER TRAIN COMPONENTS

All Chevrolet's power train components are designed and constructed to stand up to high power output under the toughest conditions. Extra-duty equipment from engines to rear axles provides you with the right truck for dependable, profitable operations. Big-truck Six or V8 gasoline engines and proven diesel power plants can be teamed with job-matched transmissions and rear axles to give the best in heavy duty power trains. Advanced engineering in design and quality control in manufacture ensure Chevrolet's built-in reliability.

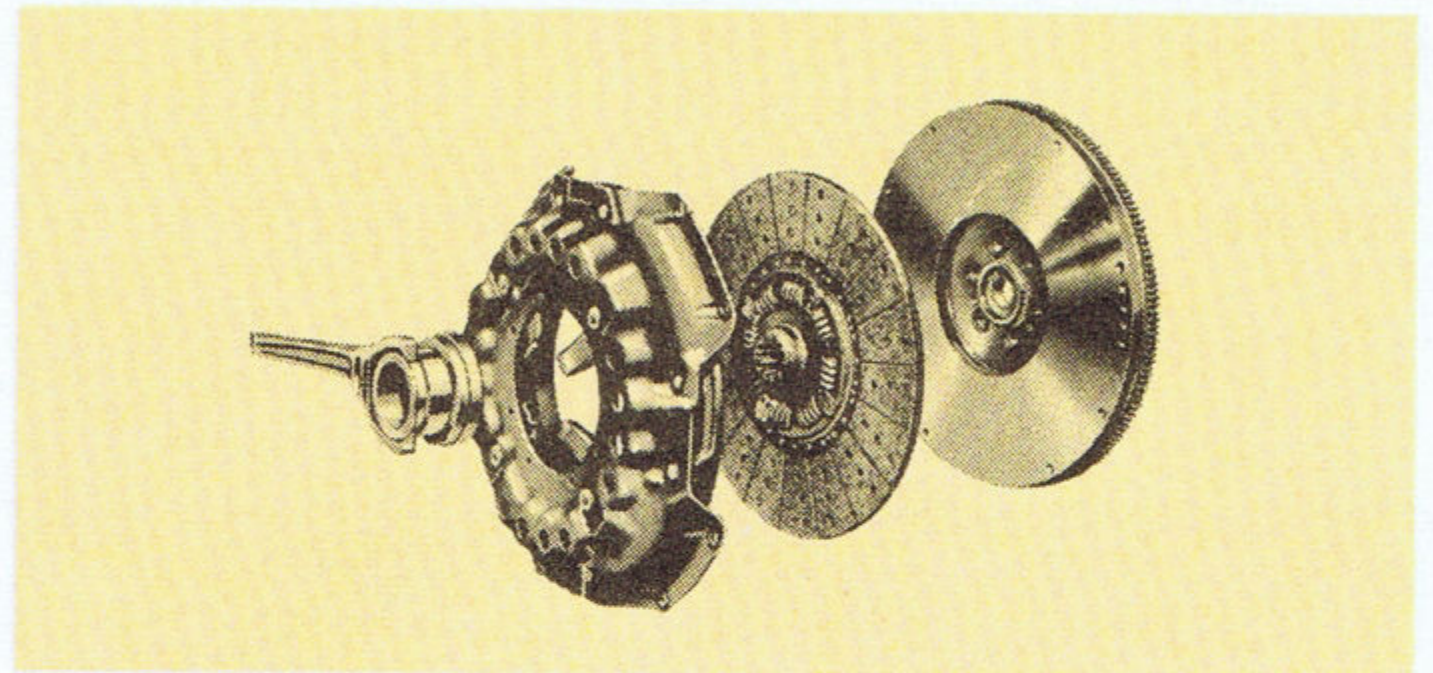

**CLUTCHES** — High capacity clutches are torque-matched to each engine in the medium and heavy-duty truck line. In the Series 50, diaphragm-spring 11-inch clutch is used. A 12-inch clutch backs up the 292 Six in the 60 Series, while the 327 and 348 carry 13-inch units and a 14-inch handles the extra-high torque of the 6V-53N Diesel. The 409 V8 clutch is a special 12-inch two-plate unit.



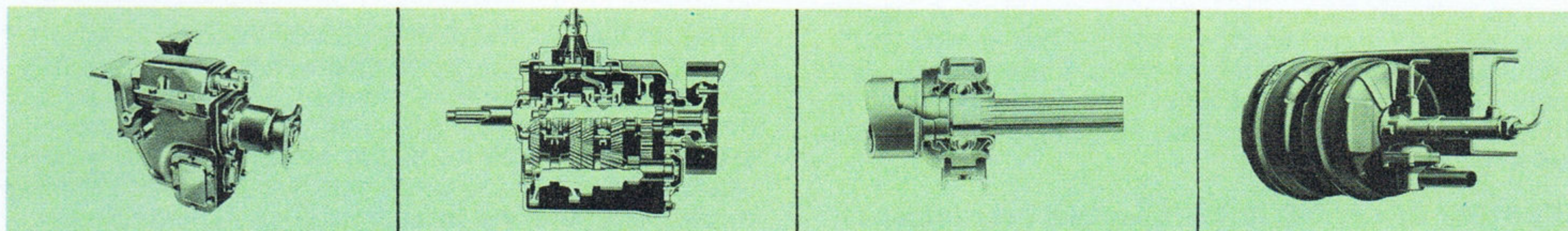
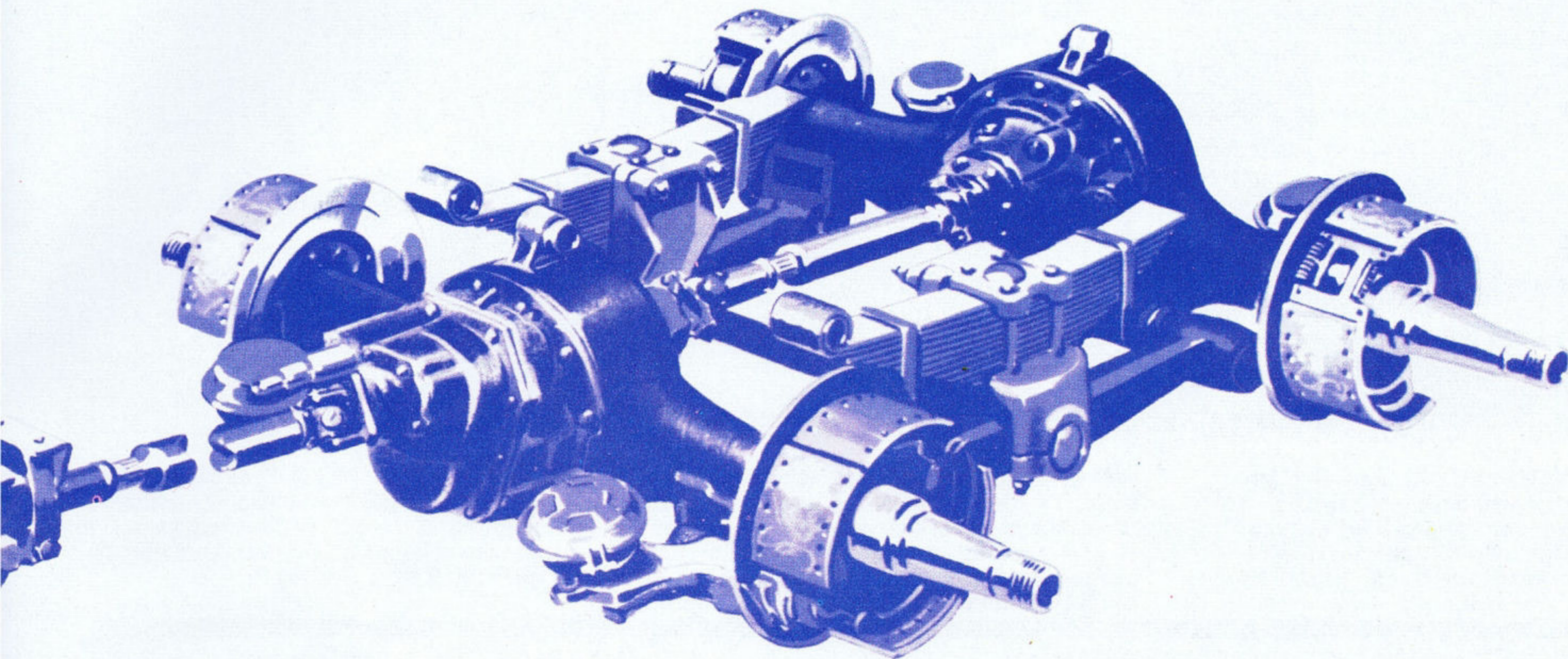

**TRANSMISSIONS** — Standard M60 tandem equipment includes a 4-speed Synchro-Mesh transmission, with \*5-speeds available as an option. The Standard M80 transmission is a 5-speed Spicer #3152, but with the optional \*409 V8, an extra-heavy-duty 5-speed Spicer #5652B is required. Series M80 options include \*3- or \*4-speed auxiliary transmissions (4-speed only with the 409 V8 or in diesel models). Also available at extra cost for Series M80 is the 8-speed Fuller R46 Roadranger.

**DRIVE SHAFTS** — Precision-balanced drive shafts are fitted with efficient needle bearing universal joints. Shaft sections are short and rigid with cushion-mounted self-aligning ball intermediate bearings.

**REAR AXLES** — Tandem axles start with the Chevrolet-built Series M60 standard drive axle, geared 7.20 to 1 and available as an option in \*2-speed form. Eaton axles furnished on Series 80 tandems are single-speed only. With the \*optional 34,000-lb. bogie, a 5.57 to 1 ratio is furnished with the W80, 7.17 to 1 for M80's. All Series 80 tandem models feature inter-axle differentials with a lockup feature for maximum traction when needed.

**BRAKES** — Vacuum-hydraulic brake systems with big 12¾-inch double-diaphragm boosters are standard on Series M60 and M80 models, while W80 Diesels include full-air brake equipment.

\*optional at extra cost



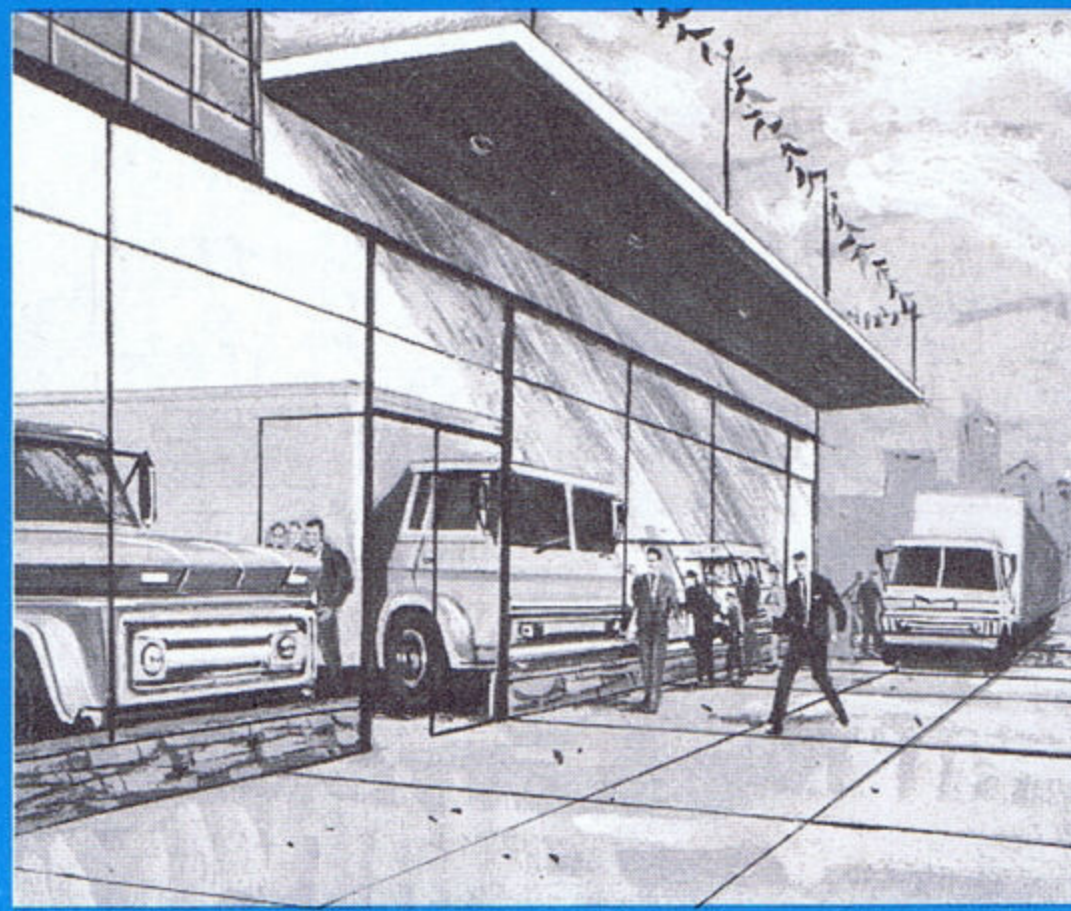
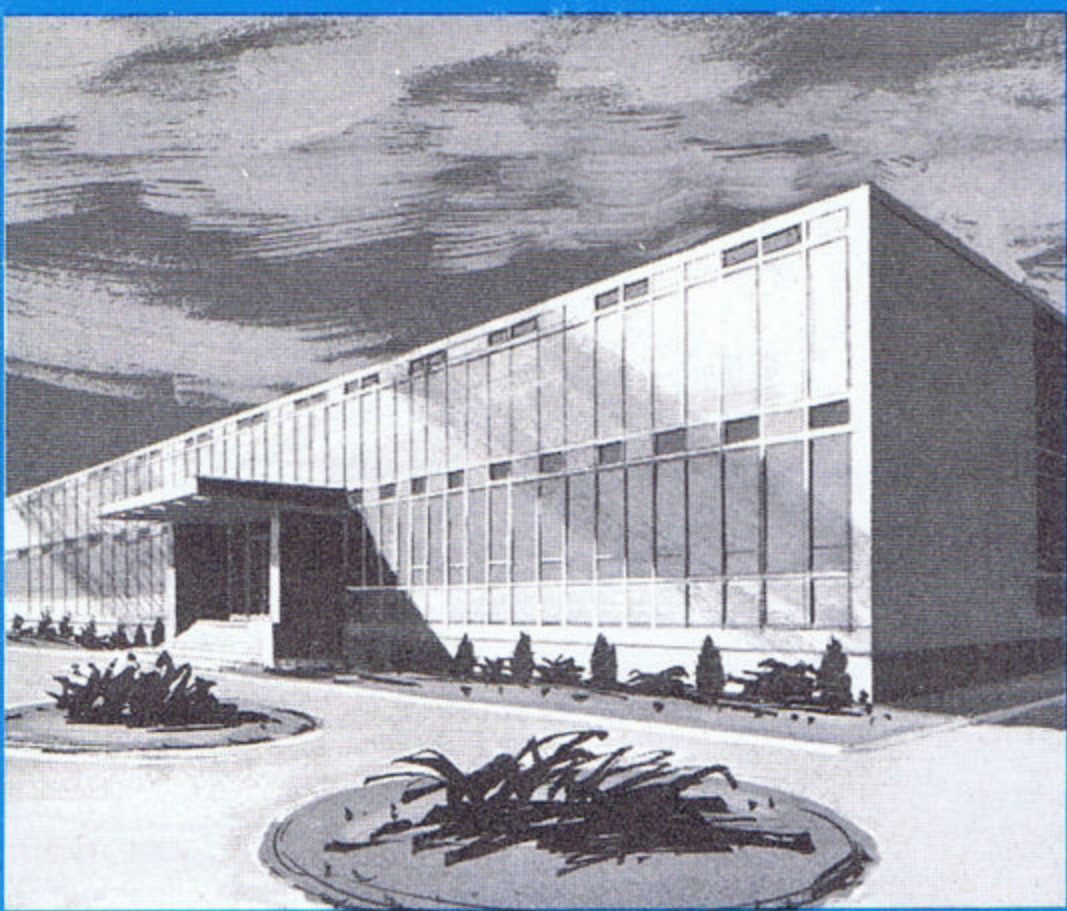

**GM PARTS WAREHOUSES** strategically located at ten points across Canada and efficiently staffed by experienced General Motors personnel, ensure prompt availability of replacement parts for Chevrolet Trucks.

**GM ENGINEERED PARTS OF ORIGINAL QUALITY AND DESIGN** are also stocked by Chevrolet dealers everywhere. This system of fast accurate supply is your protection against costly down time and your assurance of long-lasting satisfaction.

**TECHNICIANS FROM CHEVROLET DEALERSHIPS** regularly attend General Motors Training Centres for the advanced skill and knowledge to service competently all General Motors Products.

## CHEVROLET TRUCKS KEEP COSTS LOW

Chevrolet truck owners enjoy four important advantages that combine to keep hauling costs low. These advantages extend beyond traditionally low Chevrolet truck first cost. They are: Product Durability... Economy of Operation... Unmatched Parts and Service availability... and Consistently Highest Resale Value.

**PRODUCT DURABILITY** — Chevrolet design puts every part to work at top efficiency with the built-in toughness needed for real truck durability. This is why you'll find more older Chevrolet trucks still working on the road. This is evidence of Chevrolet durability, paying off for owners year after year, keeping hauling costs low and satisfaction high.

**ECONOMY OF OPERATION** — Chevrolet's reputation for economical performance, day in and day out, is the finest in the industry. No one is more experienced than Chevrolet in designing and building truck power plants... engines that perform at less cost, mile after mile. This means savings, money in your pocket, as long as you use your Chevrolet trucks.

**UNMATCHED PARTS AND SERVICE AVAILABILITY** — Chevrolet's parts and service availability offers unequalled advantages. A network of dealer parts and service facilities coast-to-coast, backed by modern

parts warehouses and well-equipped training centres for servicemen, make it possible for you to get quick, efficient service for your Chevrolet trucks anywhere in the country. This means you can keep your Chevrolet trucks on the road, paying their way, with less time lost for service or repairs. Every hour of downtime costs you money and Chevrolet's nearby parts and service helps cut these costs to the bone.

**CONSISTENTLY HIGHER RESALE VALUE** — Another Chevrolet advantage you'll appreciate, when it comes time to trade, is the consistently higher resale value of Chevrolet trucks. You'll find an important measure of a truck's overall value is the price it can bring as a used vehicle. And the average prices of used Chevrolet trucks, as published in authoritative industry sources, are consistently higher than those of other competitive makes.

No matter what Chevrolet truck model you select, you'll be money ahead. And in the 1965 Chevrolet line there are models for nearly every hauling need. You'll find chassis-cabs in every weight class up to 43,000 lbs. GVW... and a large selection of chassis for the installation of virtually any type of body. No matter what your requirements, you'll find that Chevrolet is the first choice for keeping truck costs low!



**GENERAL MOTORS PRODUCTS  
OF CANADA, LIMITED**  
**OSHAWA, ONTARIO**

The illustrations in this catalogue do not necessarily show standard colors, materials and equipment. General Motors Products of Canada Limited, reserves the right to make changes at any time, without notice, in prices, colors, materials, equipment, specifications and models, and also to discontinue models. This right may be exercised without incurring any responsibility with regard to trucks previously sold.