

SUBURBANS and PANELS

Series 1000-2500

GMC

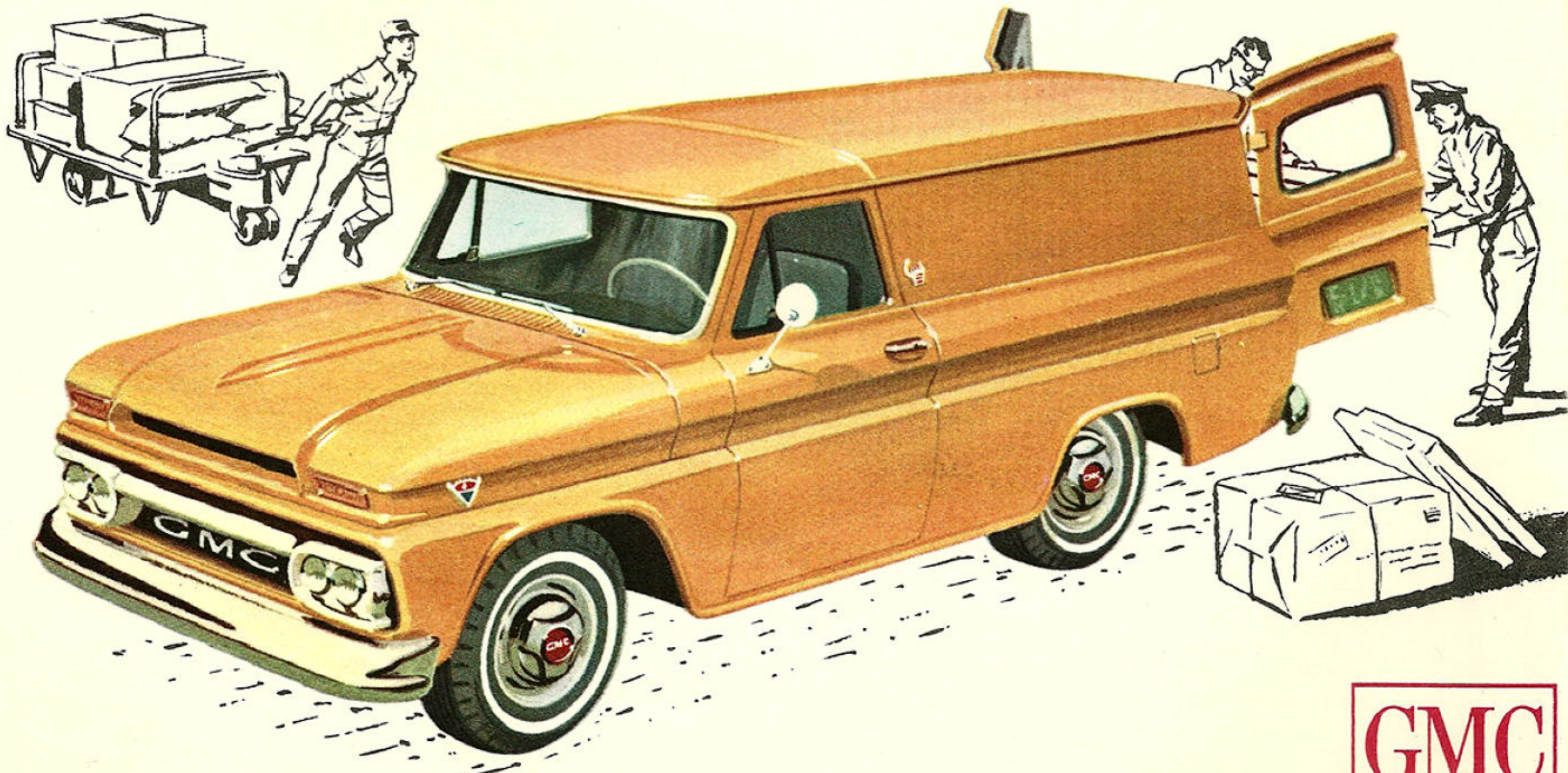
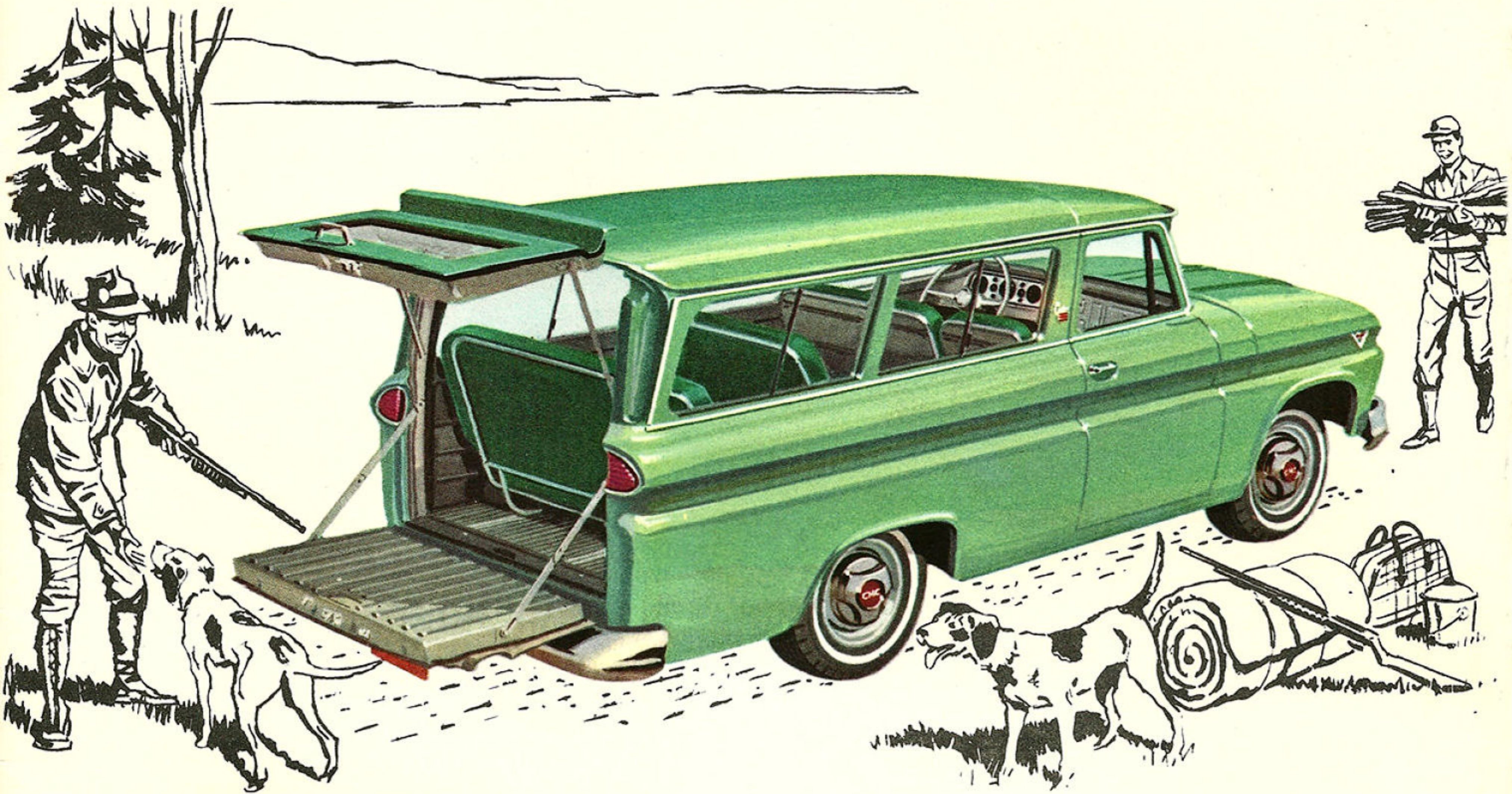

GMC
GENERAL MOTORS
CORPORATION
TRUCKS

Suburban

with lift and tailgate

MODEL 1001 GVW Ratings, 4600 Lbs.—5200 Lbs.
 MODEL I 1001 GVW Ratings, 4400 Lbs.—5000 Lbs.
 MODEL K1001 GVW Ratings, 4600 Lbs.—5600 Lbs.

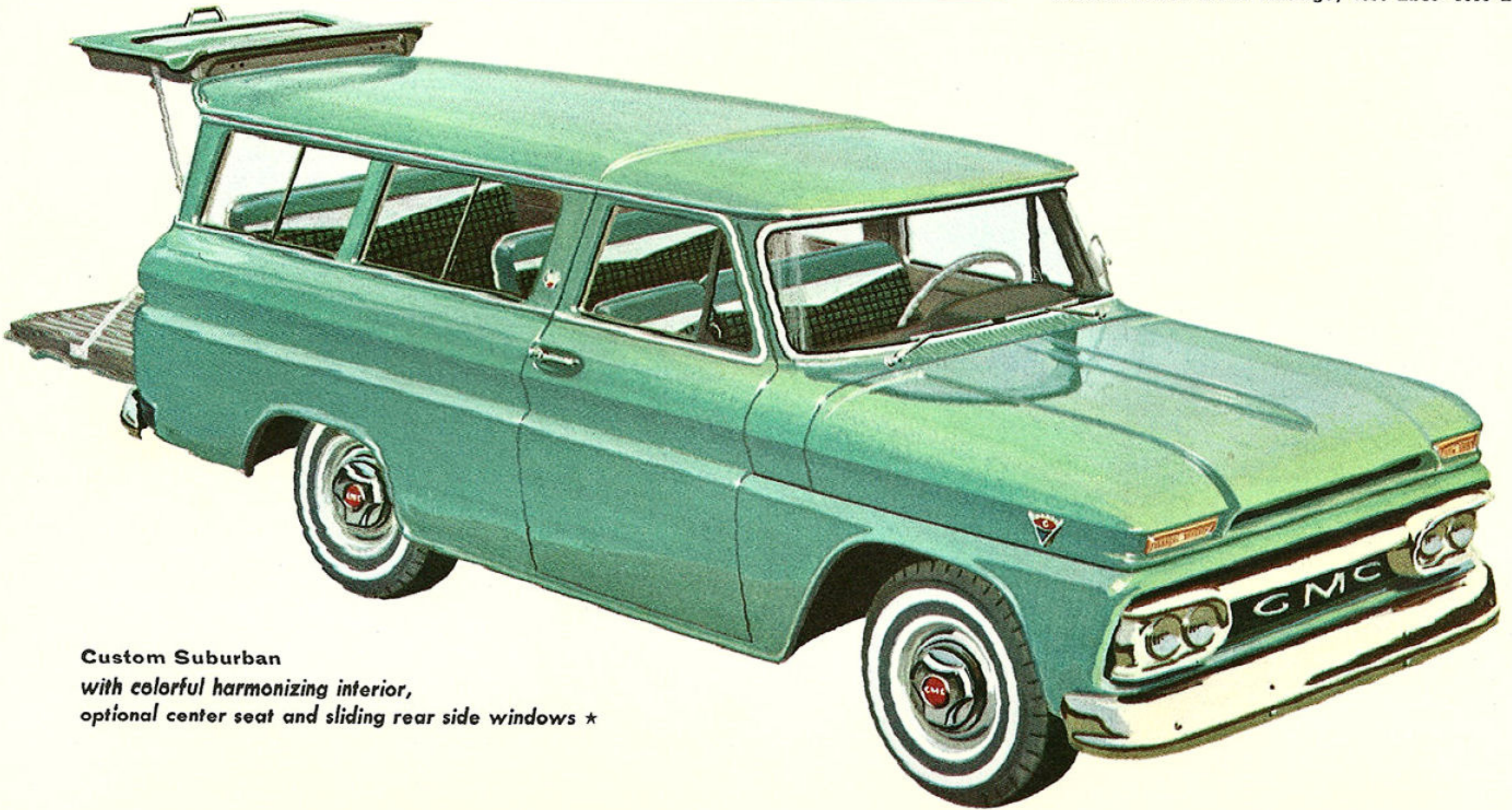

Custom Suburban
 with colorful harmonizing interior,
 optional center seat and sliding rear side windows *

IN WORK OR PLEASURE, YOU GET MORE DONE



Deluxe Suburban
 with two-tone harmonizing fawn interior

These handsome Deluxe or Custom GMC Suburbans with lift and tail gate are as equally at home on a boulevard as they are on a hunting or fishing trip. They're as rugged as a truck...as comfortable as a station wagon.

Fashionable-Dependable-Economical!—that's the versatile GMC Suburban. They're double-duty vehicles that feature station wagon styling, comfort, and ease of handling plus the workhorse ability of a husky truck for hauling both cargo and passengers.

Look at what you get:

- Slim-lined, low styled with luxurious interiors—the smartest looking suburban on the road. It's lower—fits in your garage with ease.
- 165 horsepower truck-built 6-cylinder engine with exclusive 60° "V" type design . . . a smooth, quiet responsive power plant . . . a pleasure to drive. Or, if your needs are less demanding, a 140 horsepower, lightweight, advanced-design In-line-6 will give you the ultimate in economy.
- Big, suspended-pedal clutch lets you slip easily and quietly through the gears of your dependable GMC 3-speed synchromesh transmission to get where you're going with a minimum of driving effort. Heavy-duty 3-speed synchromesh, 4-speed synchromesh, or POW-R-FLO automatic transmissions are optional.*
- Rugged, hypoid rear axle with engineered ratios to give you the best in all-round performance. Fast-cruising ratios, standard with

Suburban

with rear doors

MODEL 1001 GVW Ratings, 4600 Lbs.—5200 Lbs.
MODEL I1001 GVW Ratings, 4400 Lbs.—5000 Lbs.
MODEL K1001 GVW Ratings, 4600 Lbs.—5600 Lbs.

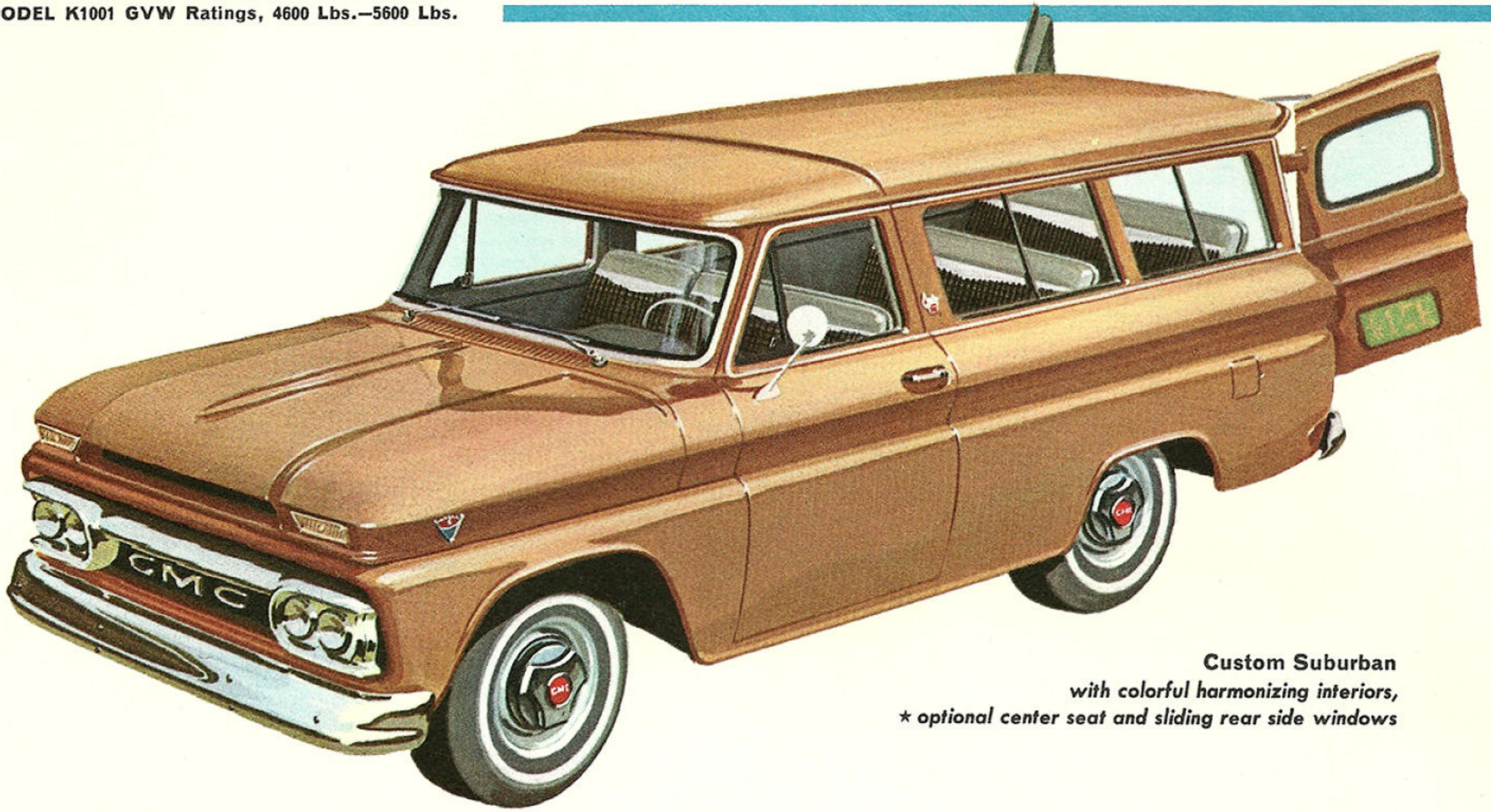

Custom Suburban
with colorful harmonizing interiors,
* optional center seat and sliding rear side windows

...HAVE MORE FUN WITH A GMC SUBURBAN!

V-6 engine, give overdrive economy without the extra cost of an overdrive transmission.

- Modern independent front wheel suspension and long, two-stage, leaf-type rear springs, with shock absorbers both front and rear . . . you experience the easiest ride—loaded or empty. Heavy-duty rear springs are available for your heavy loads.*

If you hunt, fish, prospect, pull a house trailer, own a lodge, haul cargo or passengers, you'll find that a GMC Suburban meets your needs better . . . costs less to operate and maintain.

FOUR DRIVING WHEELS TO GO—anywhere! Designed as 4 x 4's from the ground up, GMC's 4-wheel-drive pickups give you many plus value features such as:

- 165 horsepower truck-built V-6 engine.
- 11-inch spring-cushioned clutch.
- 3-speed synchromesh transmission with handy steering column shift. (Heavy-duty 3-speed or 4-speed synchromesh optional*)
- 2-speed, single-shift-lever transfer case.
- Husky hypoid front and rear driving axles.
- Extra-sturdy front and rear leaf-type springs.

In Deluxe or Custom models these are the Suburbans to take you where the going is rough.



Deluxe Suburban
with two-tone harmonizing fawn interior

These fashionable Deluxe or Custom GMC Suburbans handle tough on-the-job chores with ease, yet give you tops in pleasure trip comfort. Two big rear doors open wide for easy, convenient loading and unloading.

* Optional at extra cost.

Luxurious Suburban Interiors

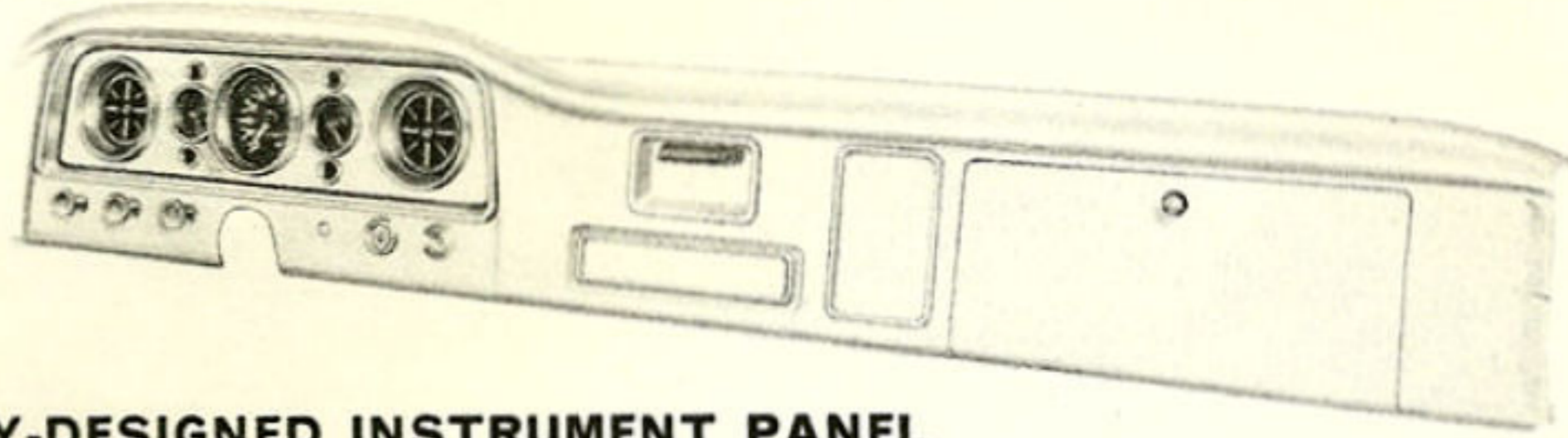

CONVENIENT, SAFETY-DESIGNED INSTRUMENT PANEL

Every inch of a GMC instrument panel is carefully planned for your greatest driving convenience and safety.

Check these plus features:

- Attractive yet functional instrument panel . . . matches cab interior in color.
- Hooded instruments to keep away bothersome reflections.
- Extra-large glove box . . . door stays open or closed.
- Printed instrument circuits are enclosed in "Mylar" plastic . . . wires can't be mixed . . . eliminates short circuits.
- Handy ash tray for smokers . . . takes litter too.

Two-passenger center seat and sliding rear side windows optional at extra cost.

LONG-LIFE SEAT CONSTRUCTION

Thick molded-foam pad, teams with strong yet flexible steel springs to give lasting comfort and durability. Upholstery features "French" seams—triple-stitched to eliminate protruding welts . . . give greater comfort . . . longer wear.

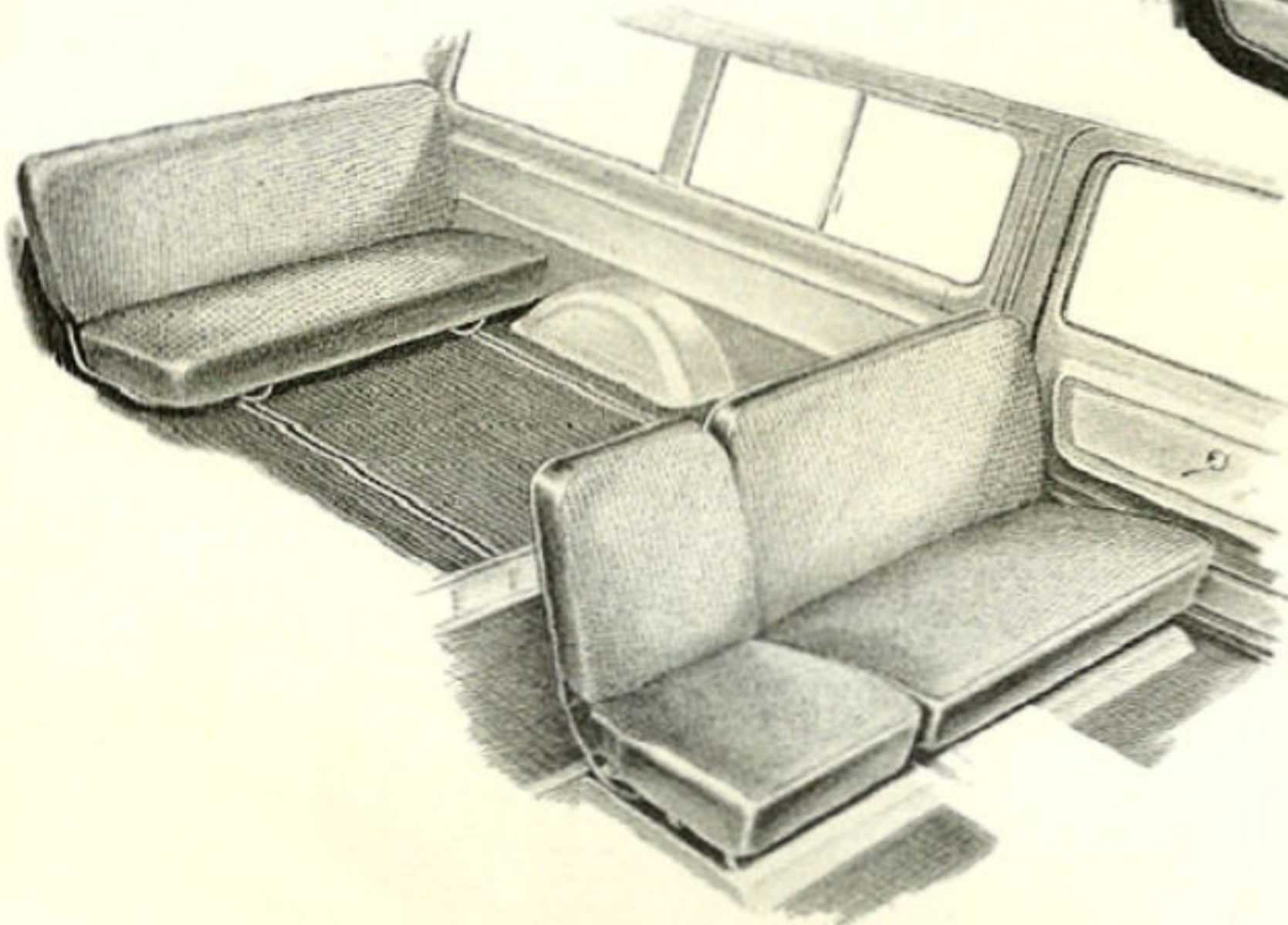
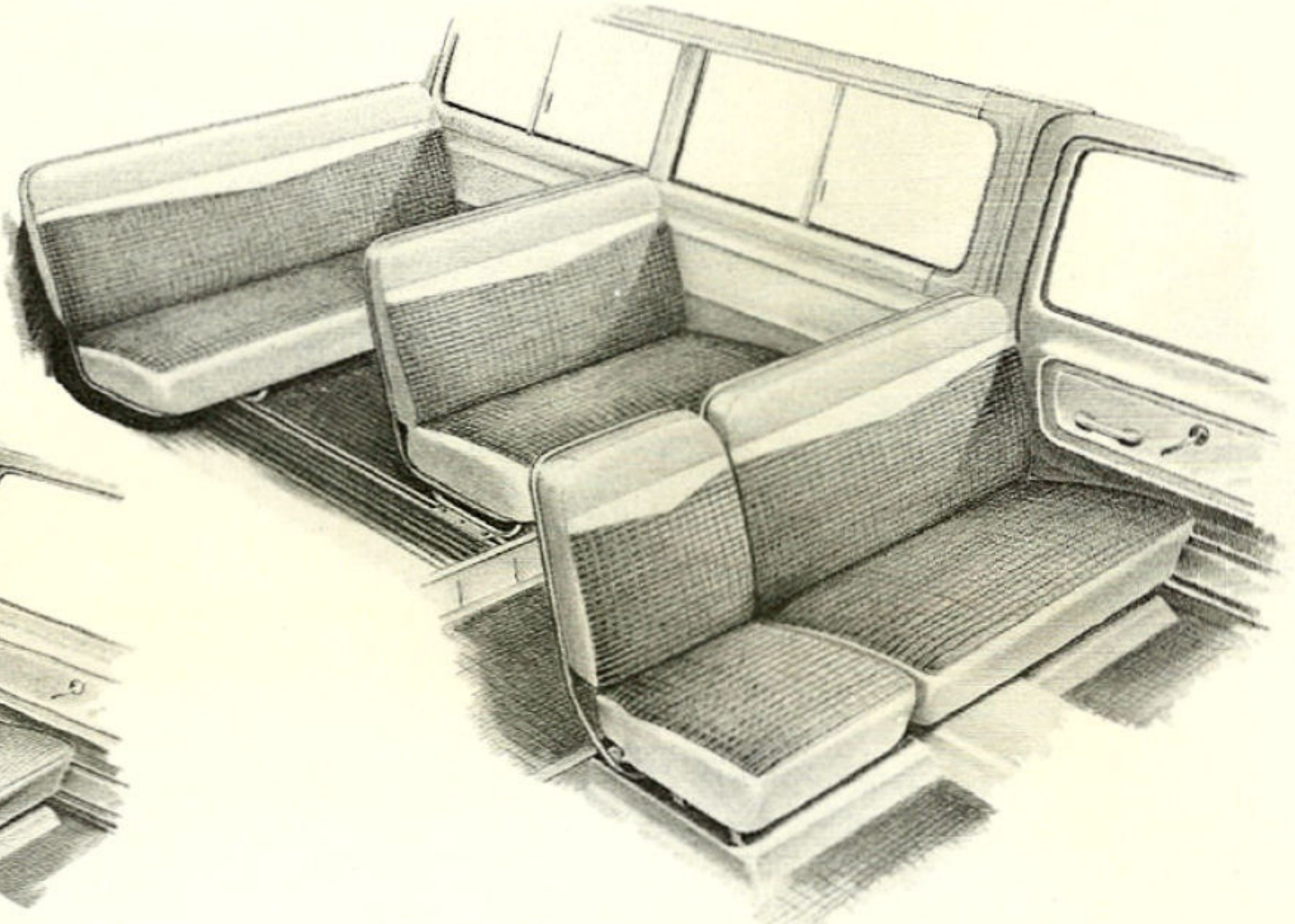

ATTRACTIVE DELUXE SUBURBAN INTERIOR

Good-looking, long-lasting GMC Deluxe interior provides such quality and comfort features as:

- Richly toned medium-fawn interior . . . blends perfectly with all exterior colors.
- Richly embossed light medium-fawn vinyl upholstery with charcoal-fawn trim . . . it's washable . . . it wears longer.
- Medium-fawn left hand sun visor for greater driving safety . . . reduced eye fatigue.
- Easy adjustable drivers seat for just the right support and maximum comfort.

On the job . . . on the open highway, you enjoy driving in a GMC Deluxe Suburban.

LUXURY-TYPE CUSTOM SUBURBAN INTERIORS *

GMC colorful custom interiors combine beauty, service and comfort. Look at these extra-quality features:

- Richly-toned medium-fawn interior blends perfectly with all exterior colors.
- Beautiful, two-tone, long-wearing nylon upholstery smartly tailored with complementing Solid-Color Vinyl . . . It's easy to keep clean. There are four colors . . . Green, Blue, Turquoise and Fawn each matched with harmonizing exteriors.
- Two big sun visors eliminate annoying glare for driver and passengers.
- L.H. arm rest—in color—for additional driving comfort.
- Easily adjustable drivers seat for the most relaxing support and comfort.

In work or pleasure, you're sure to take special pride in a GMC Custom Suburban.

OTHER EXTRA VALUE CAB FEATURES AT NO EXTRA COST

- Large one-piece windshield for a full panoramic view. Door ventilating windows. Dual electric wipers.
- Big, comfort-positioned, safety steering wheel for easier, more relaxing driving.
- Dome lamp for safe entrance and exit at night . . . controlled by master light switch on instrument panel.
- All-weather rubber door seals stop drafts, dust, water.
- Locking side windows for added security.

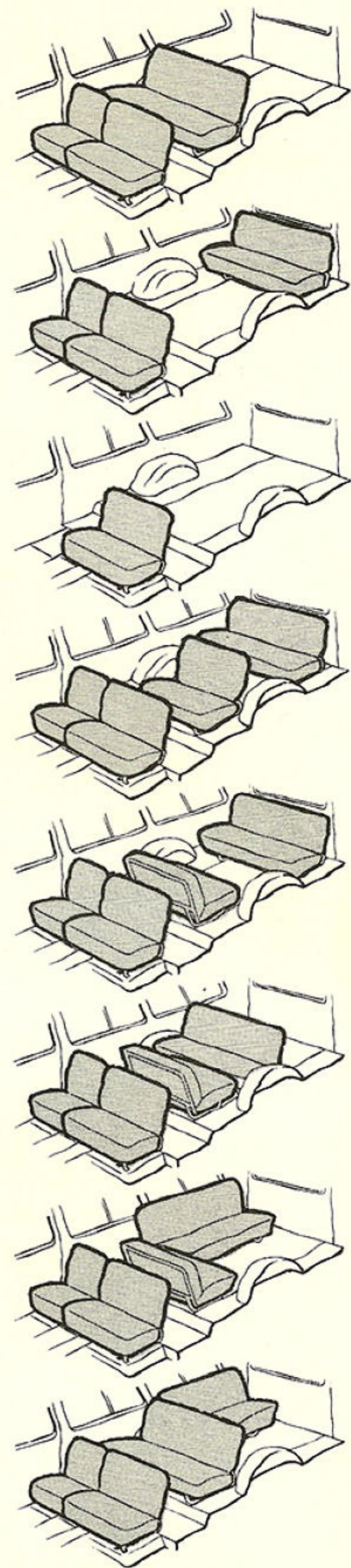
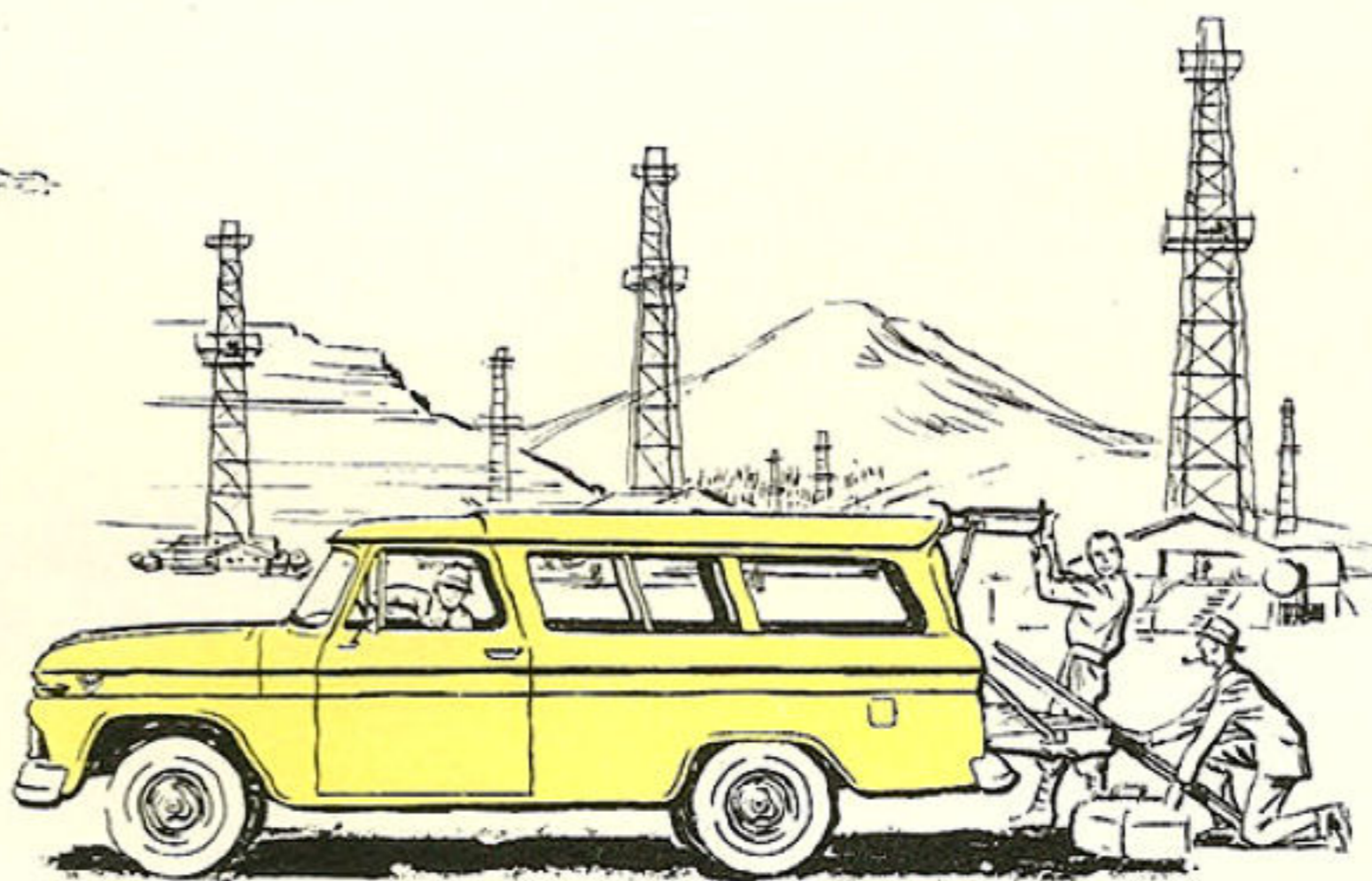
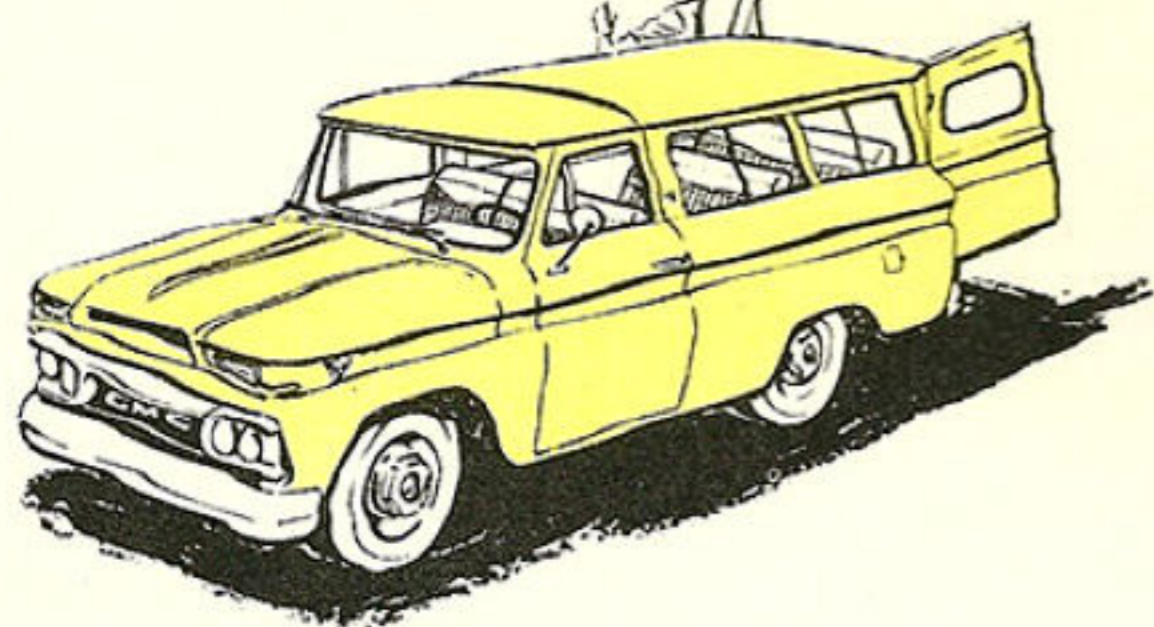
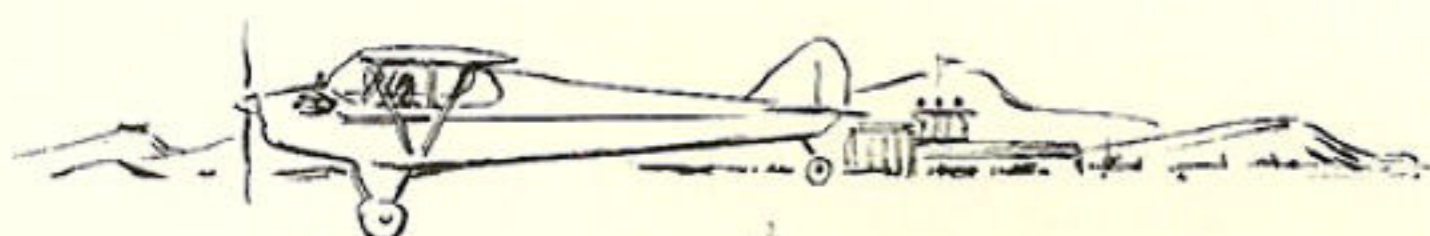
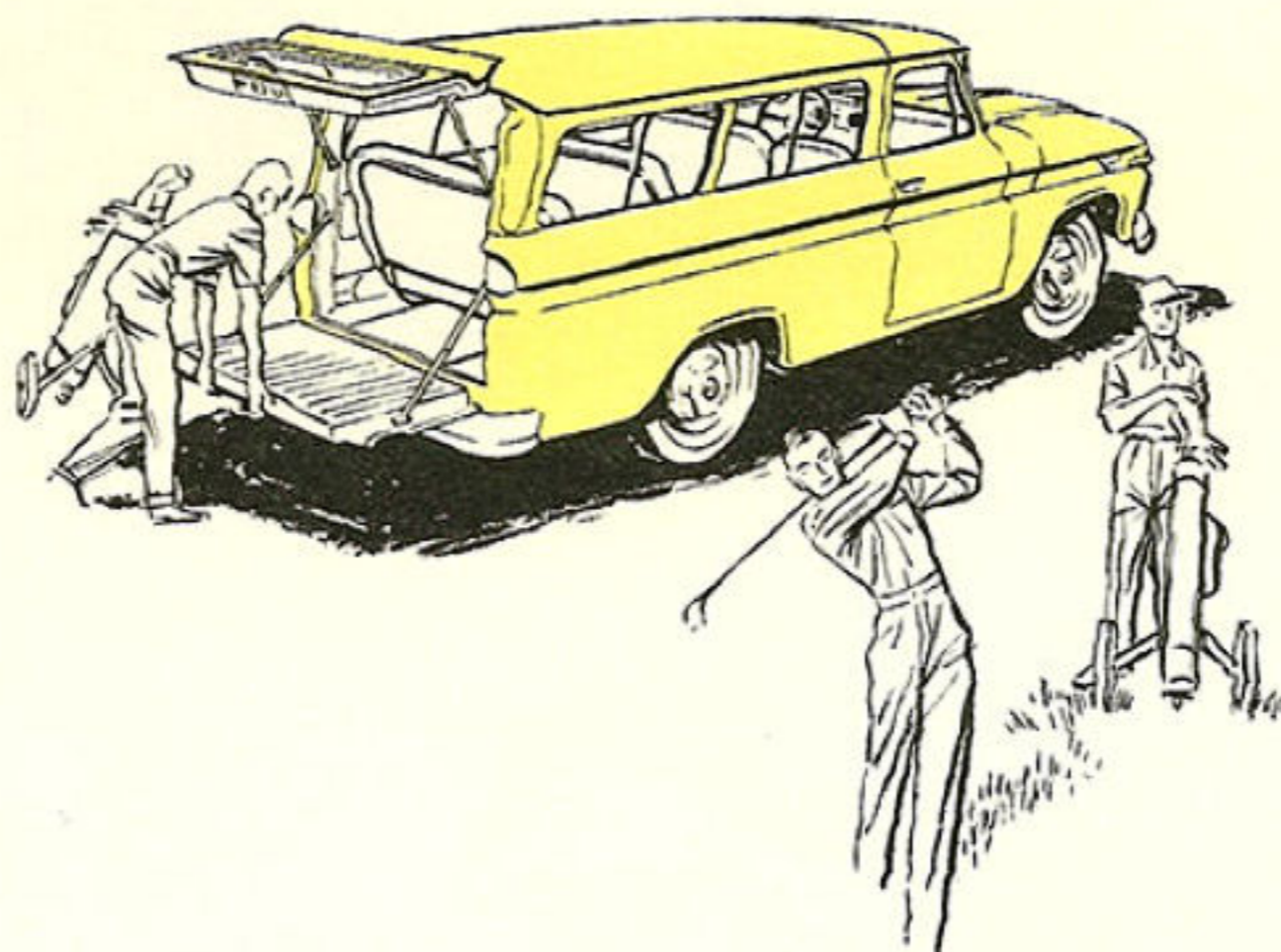
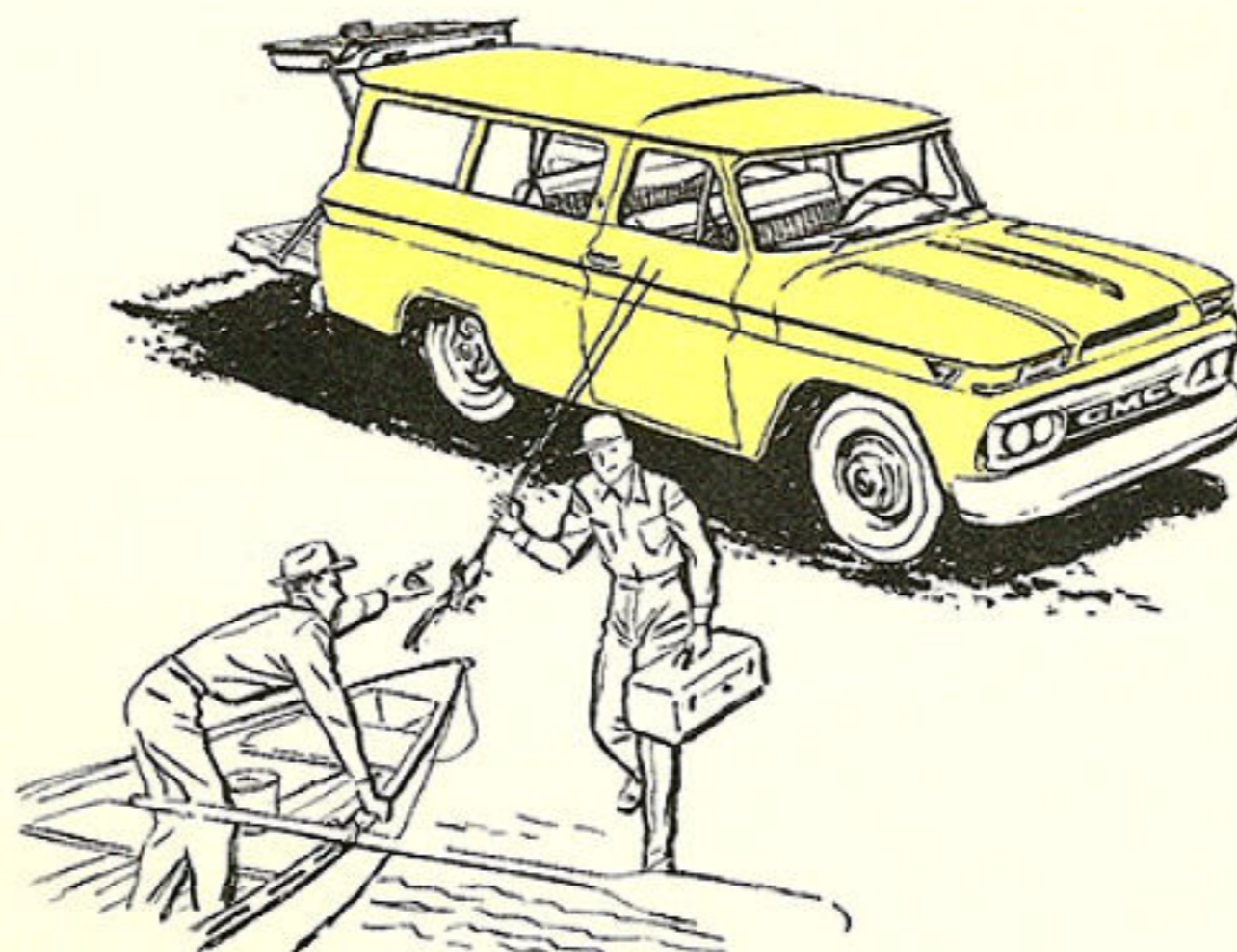
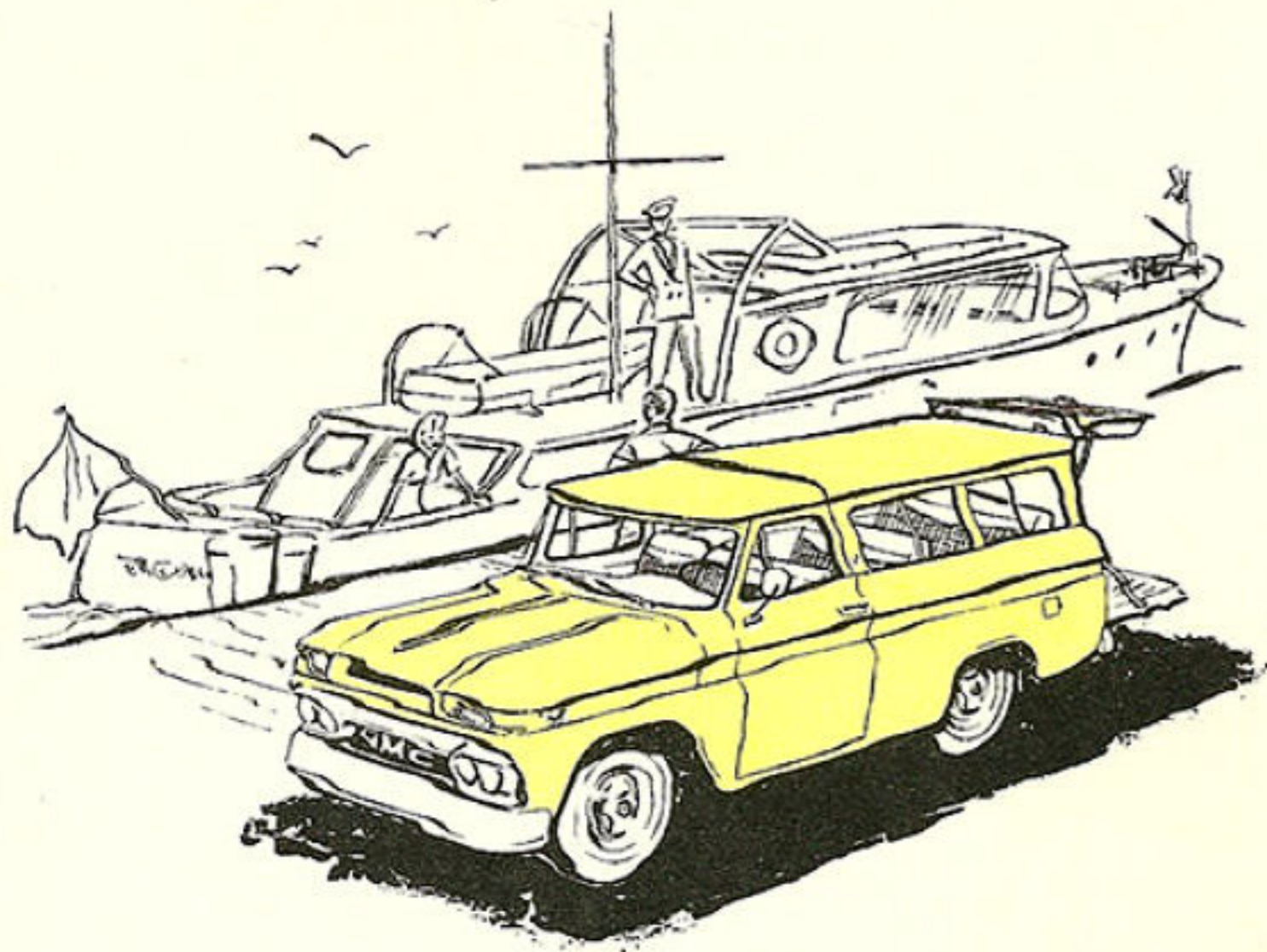

Seats up to 8 adults comfortably

Seat arrangement is another example of the flexibility of GMC Suburbans. Seats can be easily and quickly arranged to suit any passenger or cargo needs. Rear seat and optional* center seat run in a track and may be spaced to your wishes, turned around or placed along the side. And—to convert it to a full-length cargo carrier, simply remove the rear seats. Right front seat moves all the way forward to provide a clear path to rear seats.

Wider than a double bed

There's plenty of room in GMC Suburbans to sleep two comfortably . . . plenty of cargo space. You'll enjoy camping more than ever . . . haul more load with a GMC Suburban.

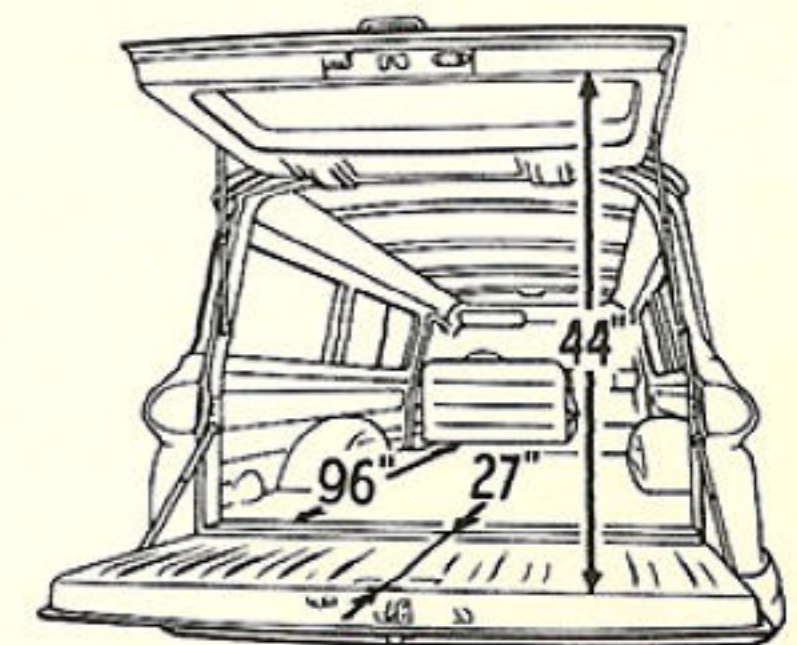

* Optional at extra cost.

7½ ft. Panel

MODEL 1001 GVW Ratings, 4600 Lbs.—5200 Lbs.
MODEL 11001 GVW Ratings, 4100 Lbs.—5000 Lbs.

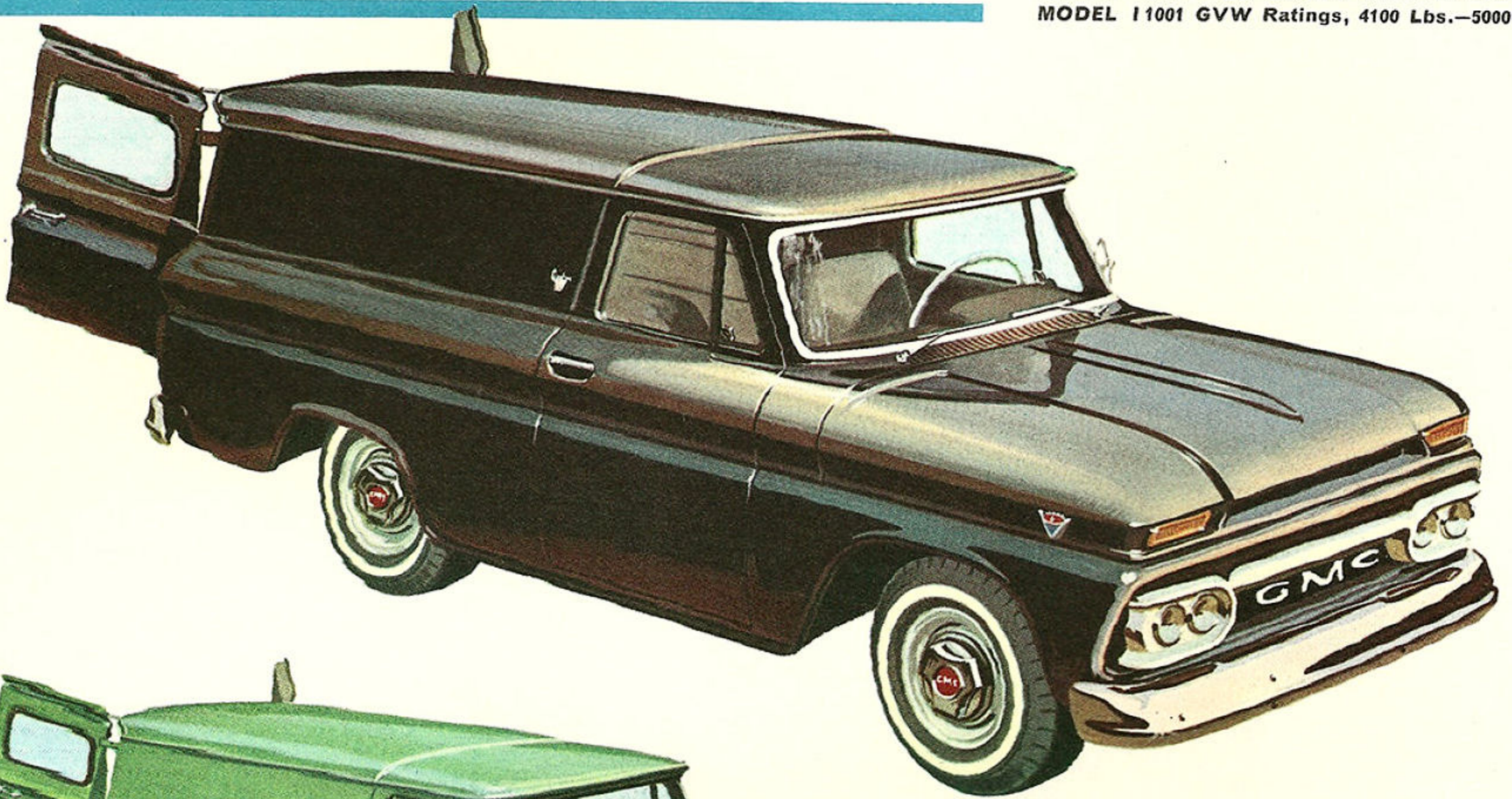

Custom 7½-Ft. Panel
with two-tone harmonizing fawn interior

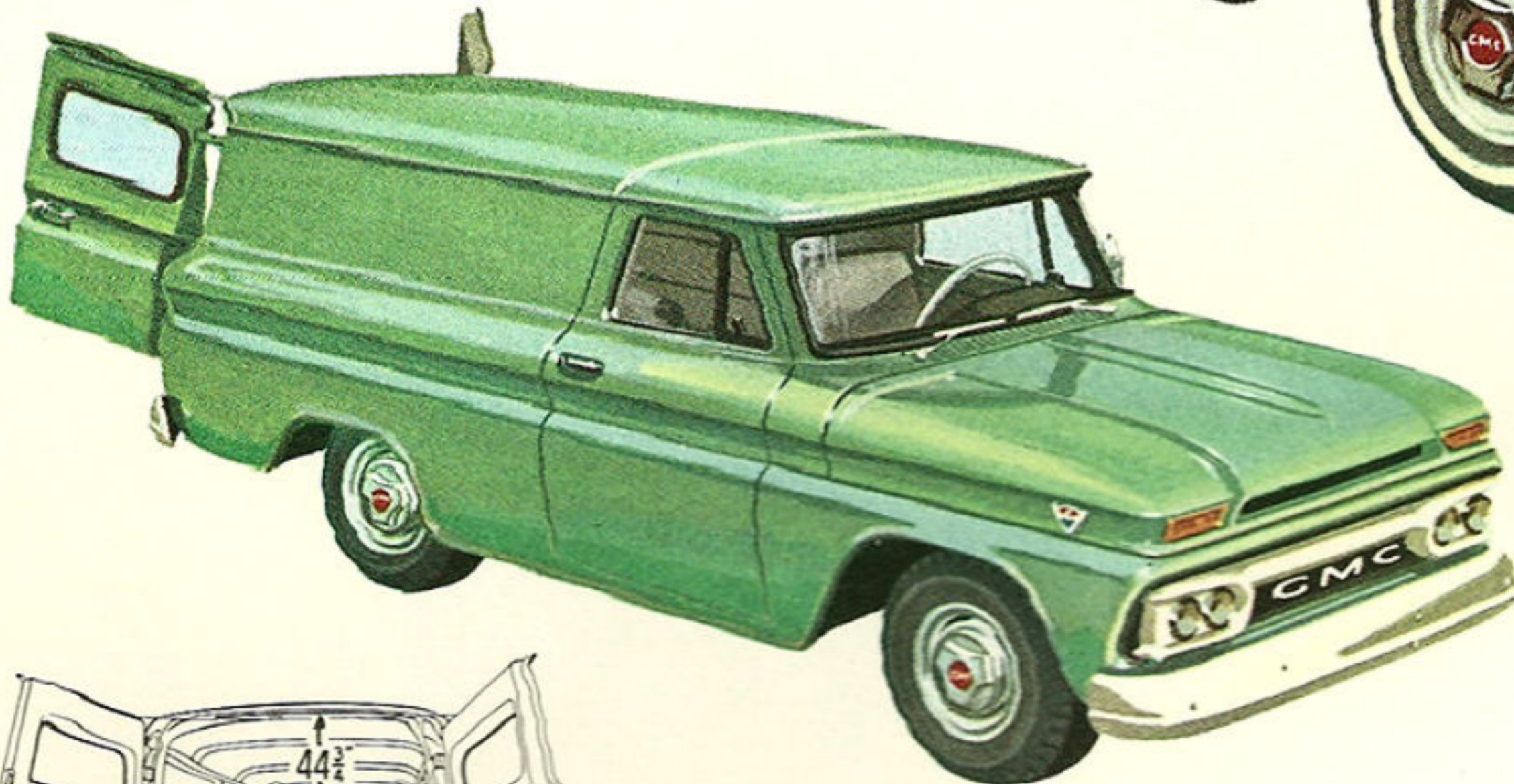

Deluxe 7½-Ft. Panel
with two-tone harmonizing fawn interior

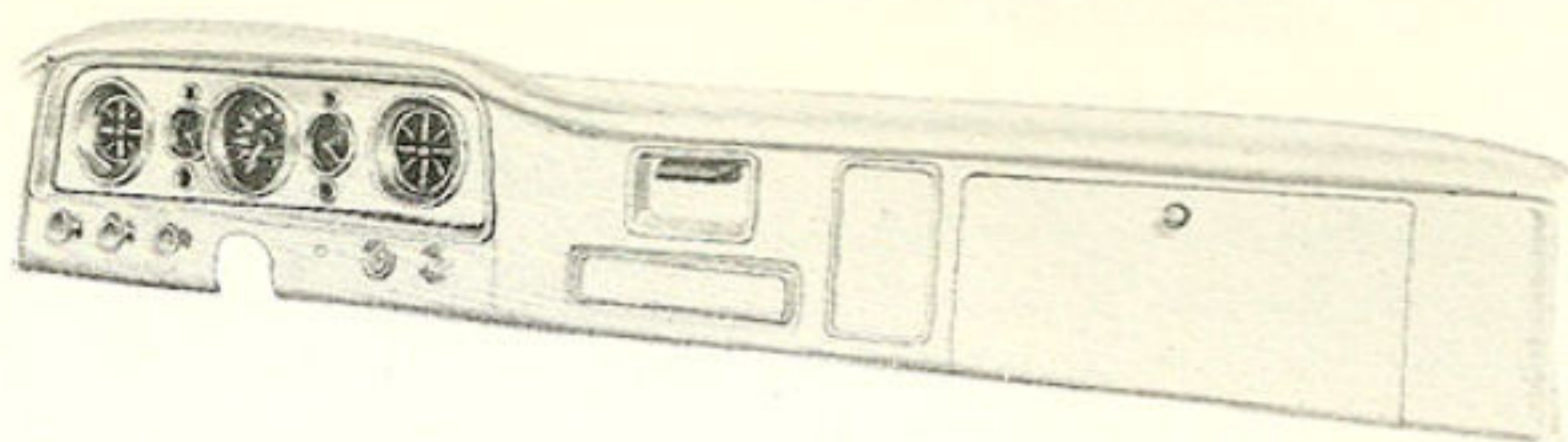
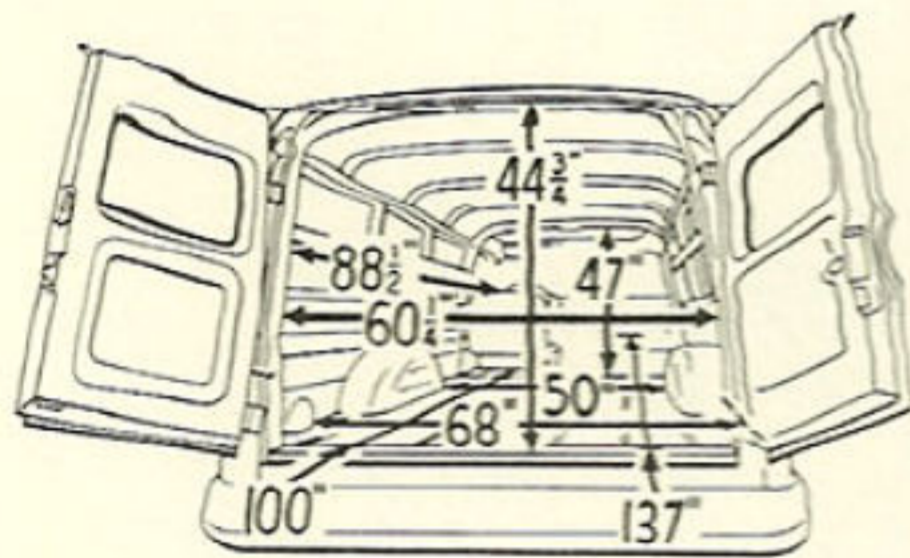

CONVENIENCE-DESIGNED INSTRUMENT PANEL

Every inch of a GMC instrument panel is carefully planned for your greatest driving convenience and safety.

Check these plus features:

- Attractive yet functional instrument panel . . . matches cab interior in color.
- Hooded instruments to keep away bothersome reflections.
- Extra-large glove box . . . door stays open or closed.
- Printed instrument circuits are enclosed in "Mylar" plastic . . . wires can't be mixed . . . eliminates short circuits.
- Handy ash tray for smokers . . . takes litter too.

GMC PANELS SPEED UP SCHEDULES

GMC panels have always had an outstanding reputation among contractors, florists, dry cleaners, plumbers, carpenters and many other aggressive businessmen who demand a vehicle that will carry big under-roof loads dependably . . . with low operating and maintenance expense.

Here are some plus features of GMC panel trucks that prove they meet your requirements best:

- Low silhouette, eye-catching style adds prestige to your business.
- Attractive medium-fawn interior . . . well appointed with quality hardware and trim, long-lasting washable vinyl upholstery.
- 165 horsepower truck-built V-6 engine with exclusive 60° "V" design . . . a smooth, quiet, responsive power-plant . . . a pleasure to drive. Or, if your performance needs are less, a 140 horsepower, lightweight, advanced-design In-line-6 brings you savings at purchase time.

10¹/₂ ft. Panel

MODEL 2503 GVW Ratings, 6700 Lbs.—8800 Lbs.
MODEL 12503 GVW Ratings, 6700 Lbs.—8800 Lbs.

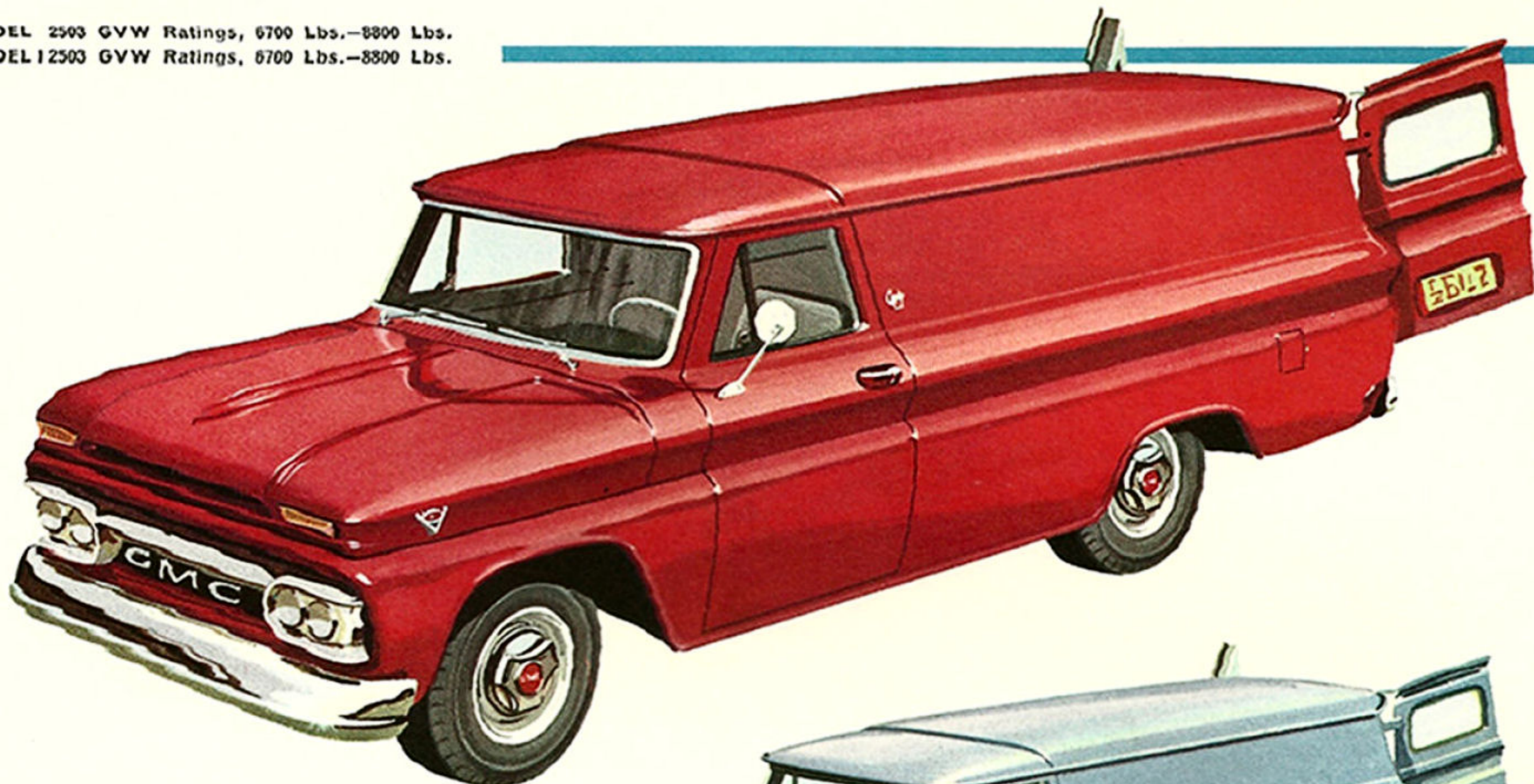

Custom 10¹/₂ Ft. Panel
with two-tone harmonizing fawn interior

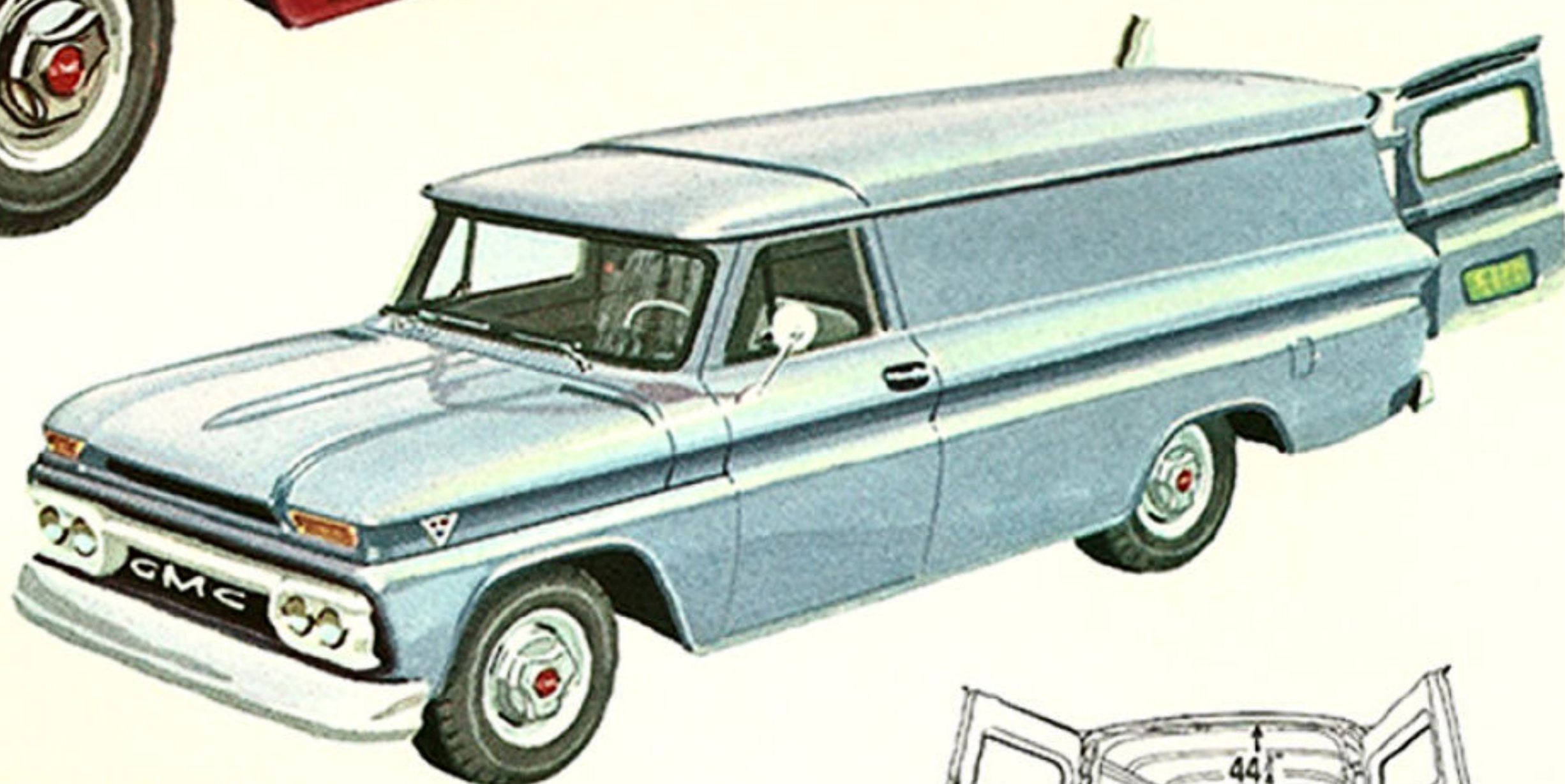

Deluxe 10¹/₂ Ft. Panel
with two-tone harmonizing fawn interior

... COST LESS TO OPERATE!

- Big, suspended-pedal clutch . . . it's easy to operate.
- Independent front wheel suspension with double-acting shock absorbers smooth out the bumps.
- Long, durable leaf-type rear springs handle light or heavy loads safely and dependably. Double-acting shock absorbers, standard model 1001, optional model 2503*, assure the smoothest ride. Extra spring capacity is available for the big jobs.*
- Reliable GMC 3-speed synchromesh transmission, model 1001, 4-speed synchromesh, model 2503, shifts easily and quietly. Heavy-duty 3-speed or 4-speed synchromesh optional on model 1001*.
- Rugged, hypoid rear axle with engineered ratios to give you the best in all-round performance. Fast-cruising ratios, standard with V-6 engine, gives overdrive economy without the extra cost of an overdrive transmission.

Before you buy your next panel, be sure to drive a GMC—you won't be satisfied with anything less.

* Optional at extra cost.

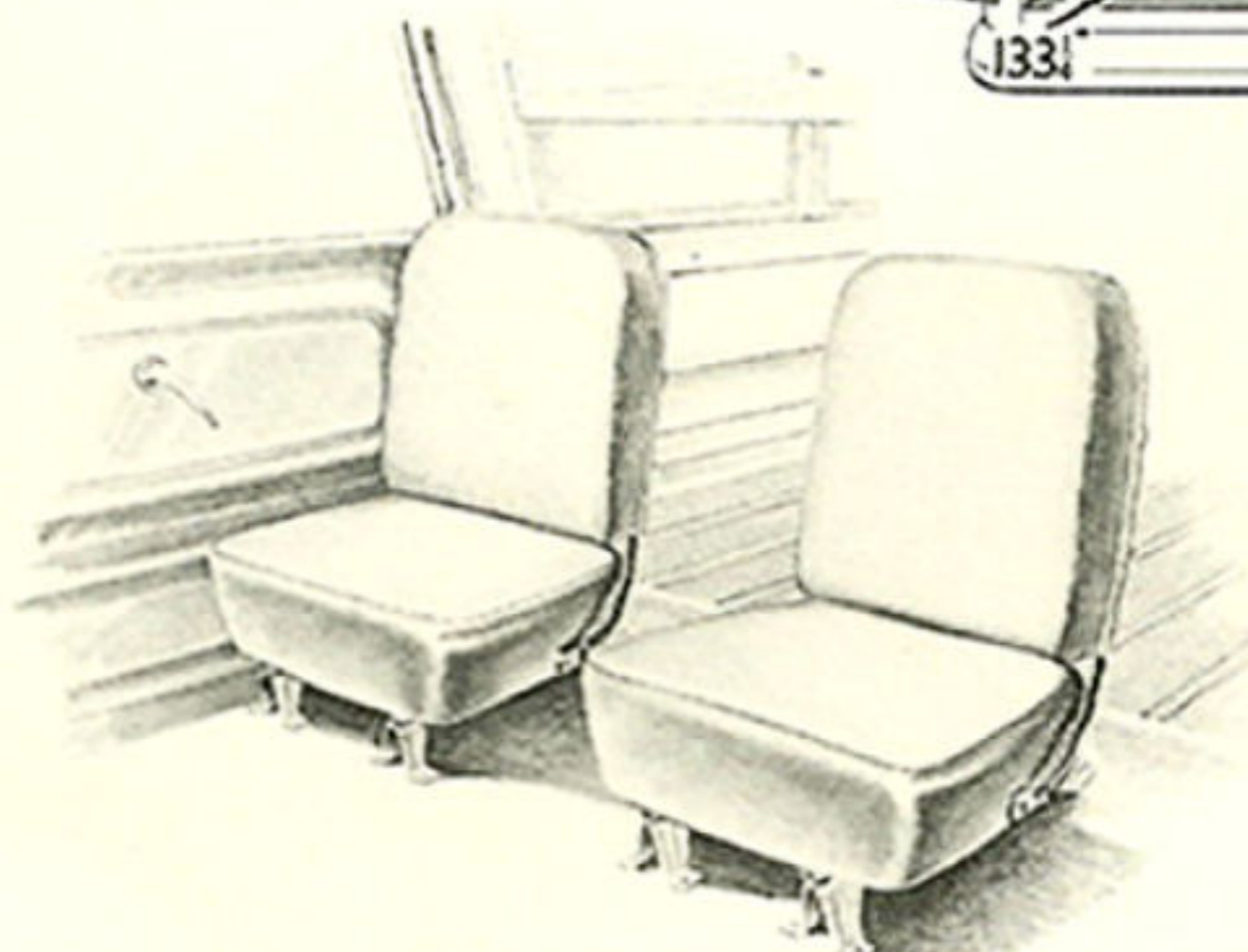
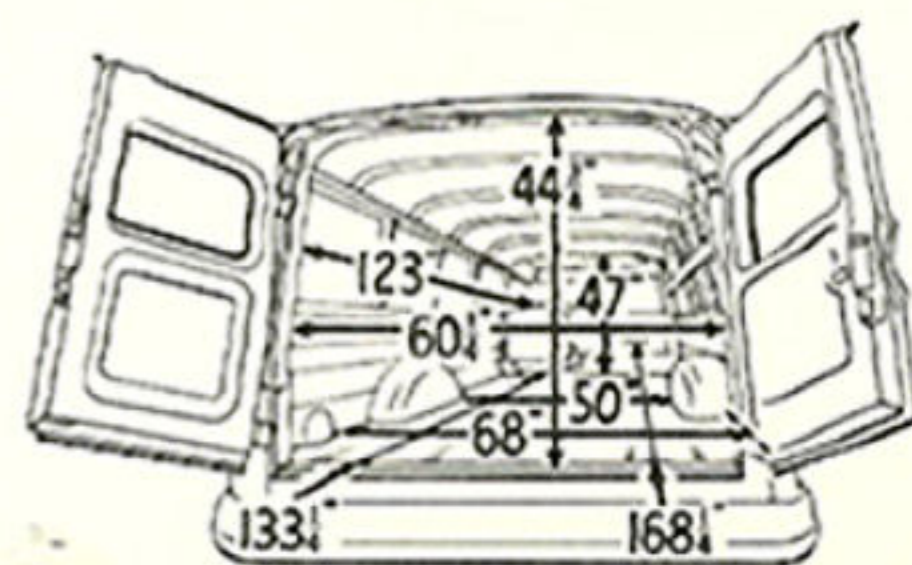

COMFORT-RIDE BUCKET SEATS

GMC panels with attractive metallic-fawn interior feature a bucket-type driver's seat for maximum comfort. It's upholstered with attractive, washable medium-fawn and charcoal-fawn vinyl . . . noted for its long life. Seat backs have heavy gauge steel sheathing to protect seat from shifting cargo. Passenger seat is available at extra cost.

GMC bodies are built to last longer!

GMC SUBURBANS HAVE PASSENGER CAR INTERIORS

GMC Suburban interiors are finished in the finest passenger car style—no exposed rough edges or seams detract from other good-looking appointments. The roof is lined with heavy, compressed jute for maximum sound deadening and insulation. Sturdy cross bows increase roof and side rigidity and each side has two large windows of non-shatterable glass. Front window opening has a two-piece sliding glass enclosed in individual sash to eliminate dirt, wind and water seepage. Contoured wheel houses, with rounded edges, permit easiest loading and they're permanently sealed against dirt and water leaks. Large rubber seals extend around entire front door openings for maximum all-weather sealing and to check door rattles. Passenger car ride and truck stamina are yours with a GMC Suburban.

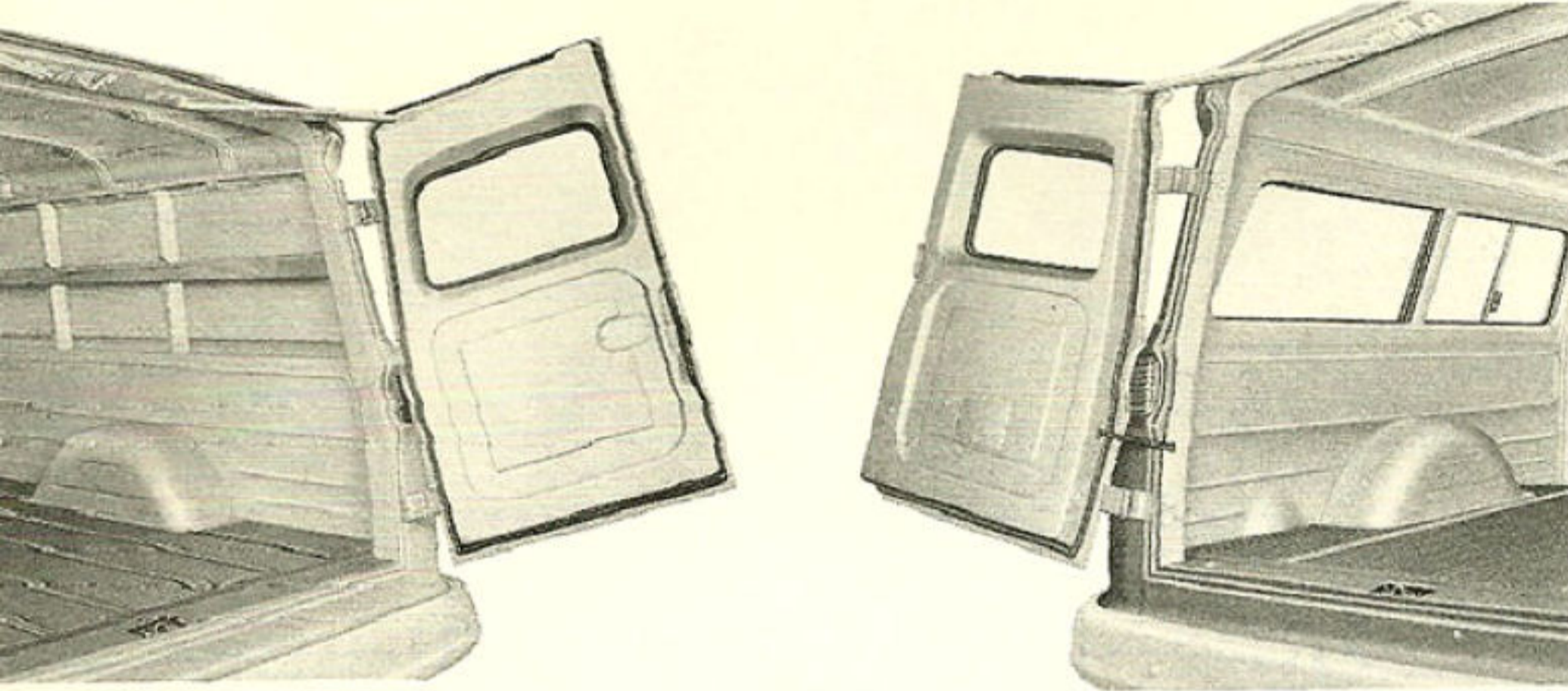
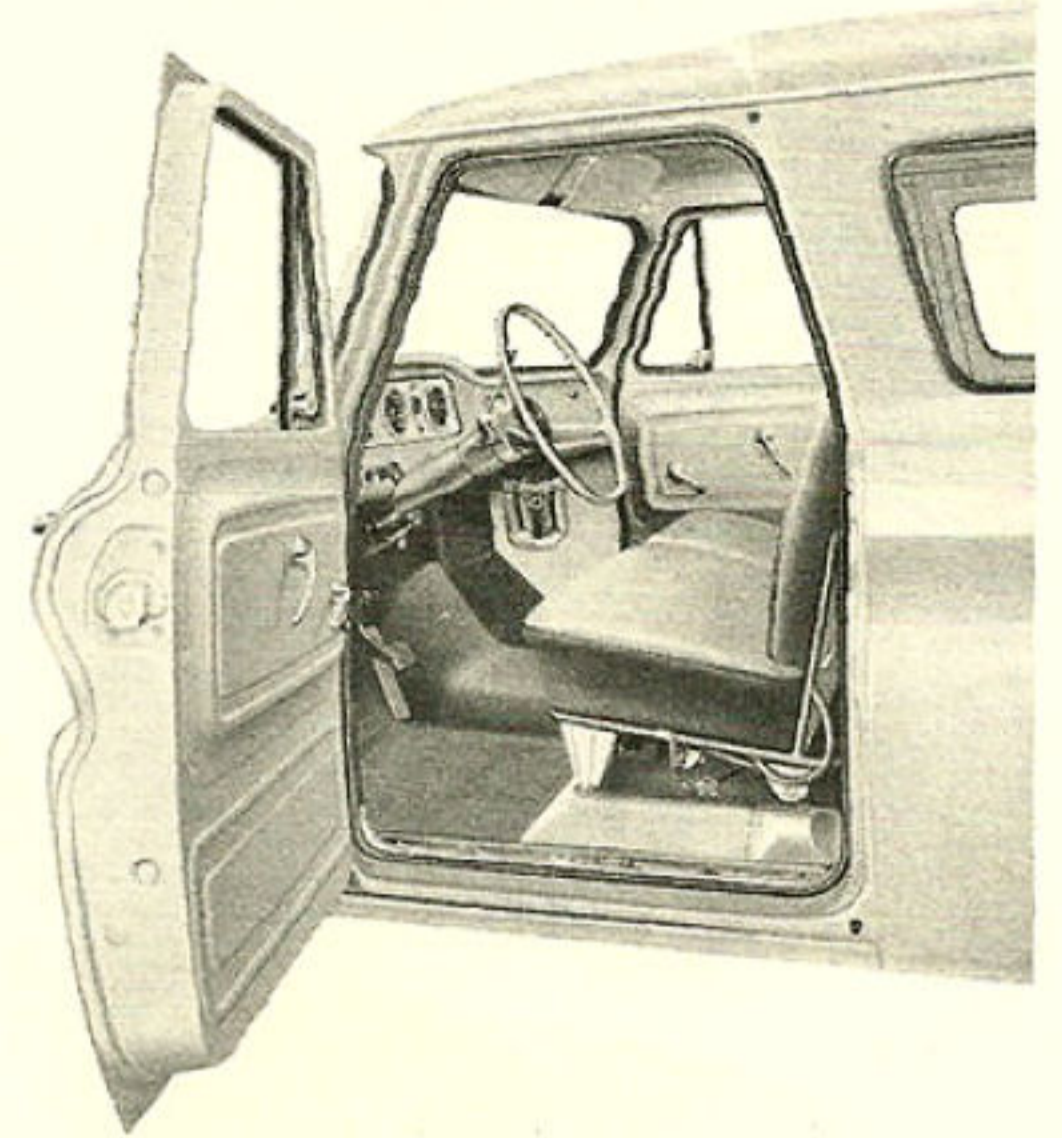

ALL STEEL REAR DOORS

GMC Panel and Suburban all steel rear doors swing on heavy-duty truck hinges. Concealed door latches hold doors safely closed . . . and don't mar the smoothline exterior appearance. Other exceptional features include: spring-type locks, outside safety locks with key matching front door . . . and, two-position check links on each door to hold doors open for the most convenient loading and unloading. Large rubber seals provide weather-tight protection.



QUALITY WHERE IT COUNTS

- GMC Panels offer such extra quality features as:
- One-piece steel roof supported by heavy, steel cross bows for added strength and rigidity.
 - Roof interior of driver's compartment covered with heavy composition panel for greater insulation and maximum sound deadening. (Also available in load compartment at slight extra cost.)
 - Husky wooden slats reinforce load compartment side walls . . . makes handling bulky cargo easy.
 - Wheel houses are contoured with rounded edges to minimize load interference—they're permanently sealed against dust and water leaks.
 - Longer floor life and easier loading are assured by heavy, full-length metal skid strips.
 - Large rubber seals extend around all doors to provide weather-tight sealing and to eliminate rattles.

ALL STEEL LIFT AND TAILGATE

The all steel tailgates of GMC Suburbans swing on heavy-duty hinges and have a safety lock keyed with front door safety lock. Tailgates are flush with the floor when down for easiest loading. The heavy plywood floor is covered with ribbed pattern heavy-duty floor covering securely cemented to the plywood floor. It's long-lasting . . . good-looking, too. Liftgate swings high for convenient loading of bulky cargo . . . and has a large, one-piece, curved safety glass rear window for safe, clear rear vision when parking or backing up to loading docks. Large rubber seals provide weather-tight protection.

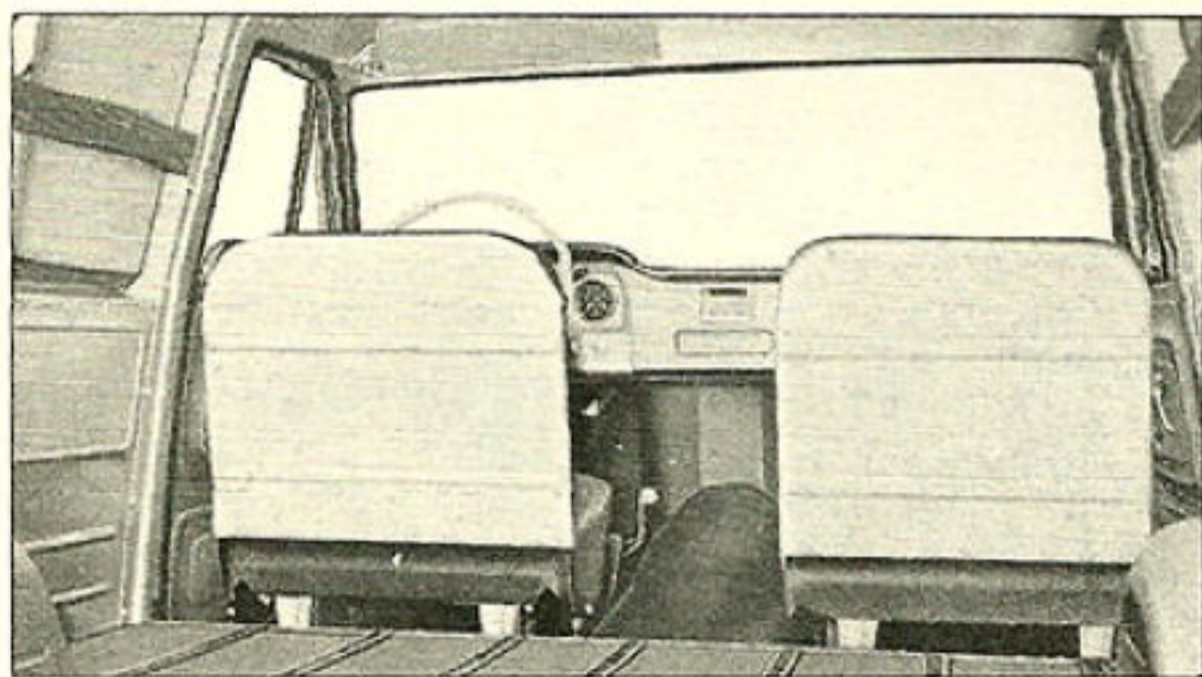

DRIVER AND SEAT PROTECTION

Backs of both driver and passenger seats in GMC Panels are sheathed with heavy-gauge steel for greater driver and seat protection against shifting loads.

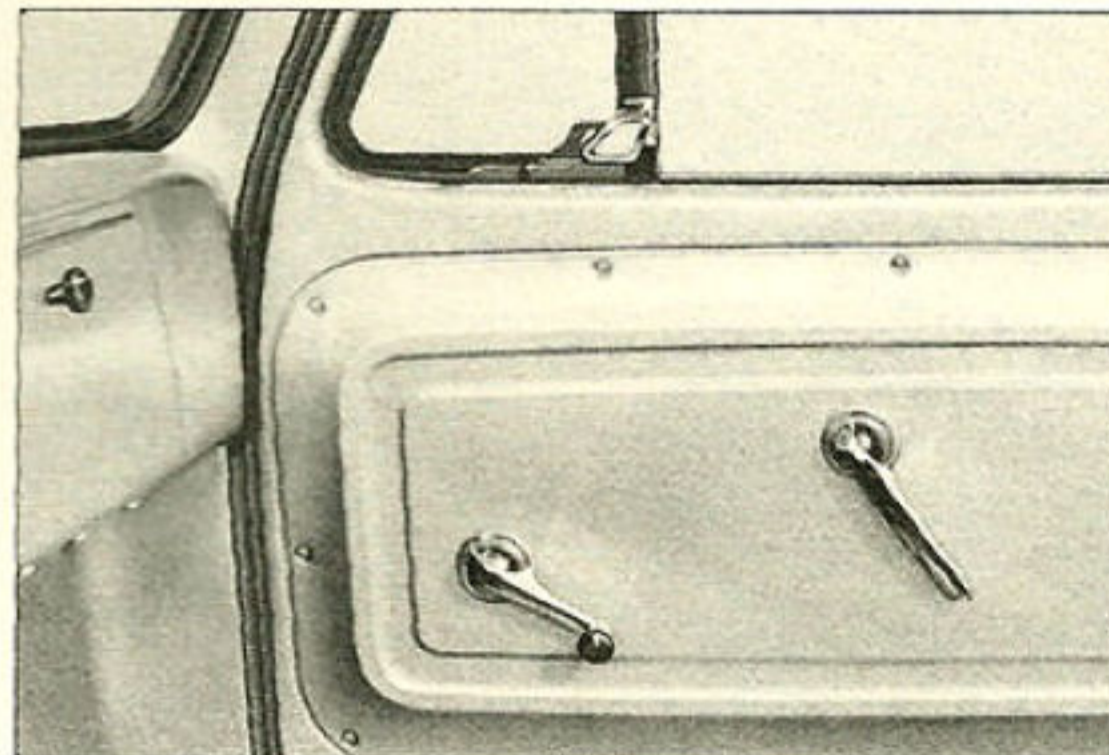

TOP QUALITY HARDWARE

Proof of GMC's attention to quality and detail is found in Suburban and Panel hardware. For instance, exterior and interior door handles, window cranks and vent locks are heavy chrome-plated metal (not plastic). They're not only big and easy to operate, but they're good-looking and last longer, too.

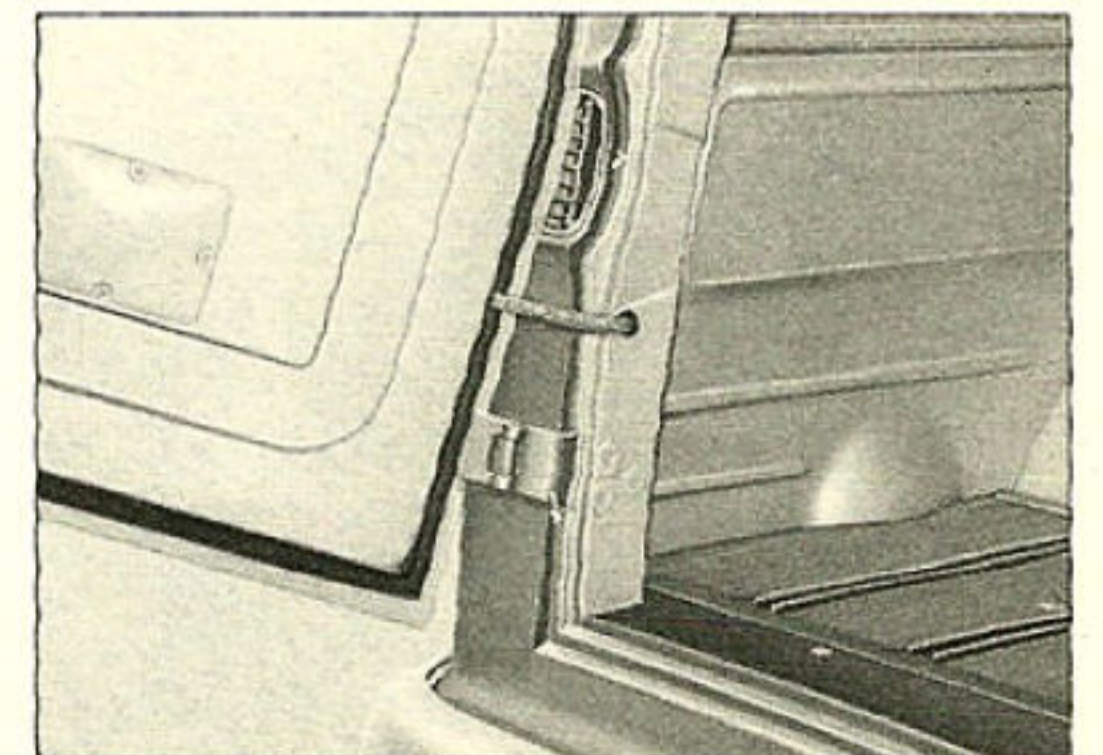

LICENSE PLATE LIGHT WIRES LAST LONGER

GMC Panel and Suburban license plate light wires are spring-wrapped to eliminate undue wear and eventual shorting out caused by excessive crimping with opening and closing of door. Another GMC extra value feature you get at no extra cost.

GMC'S LIGHTWEIGHT ADVANCED-DESIGN IN-LINE-6

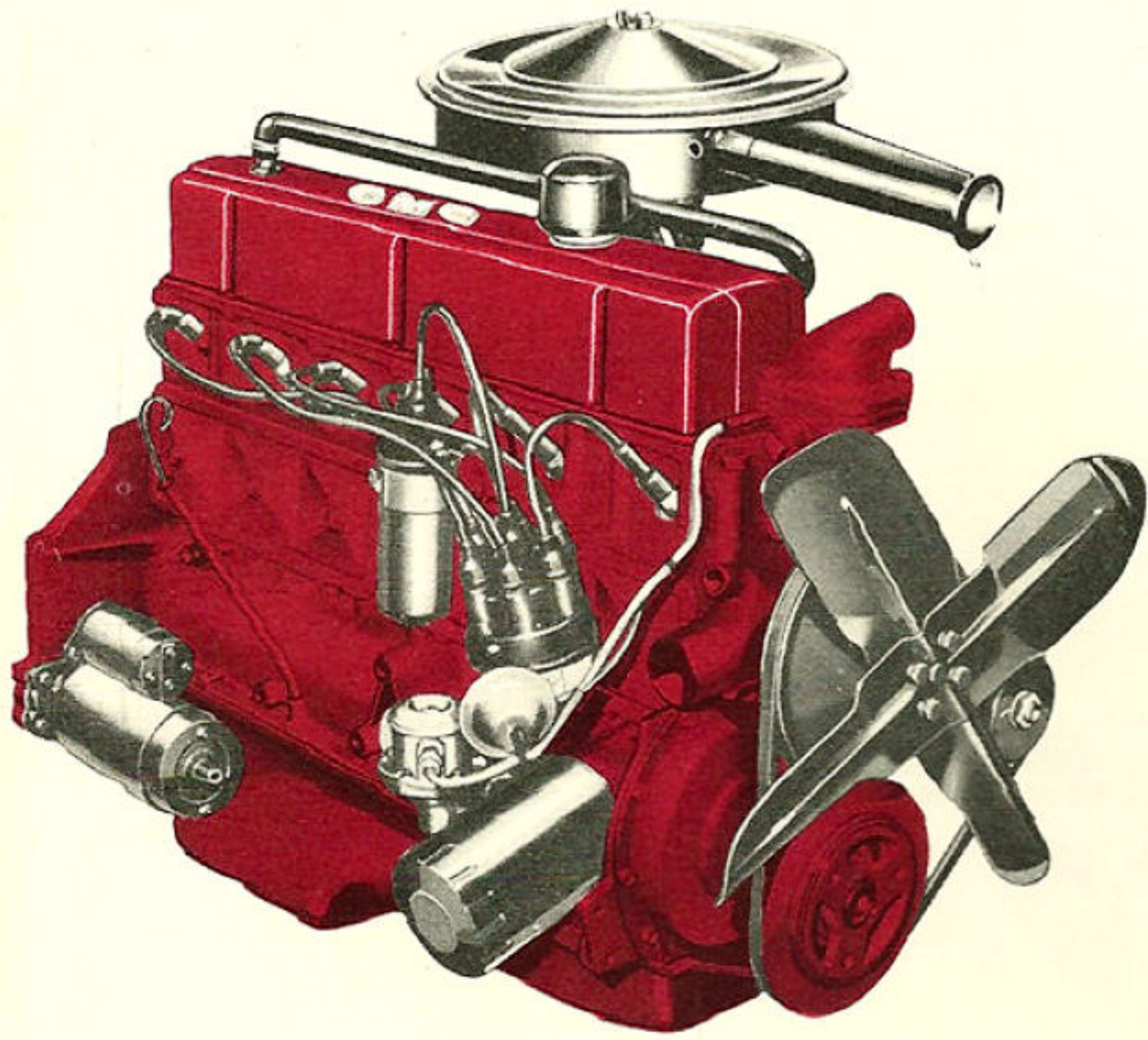

The GMC 230 In-line-6 engine brings economy, efficiency and low initial cost to the light-duty trucking industry. Advanced precision-casting trims dead weight yet supplies extra strength in high-stress areas throughout the engine. Positive crankcase ventilation extends engine life and increases oil economy. It frees the engine of acid crankcase fumes, which tend to corrode metal and dilute oil. Valve-in-head design combines with free-breathing efficiency to give peak power with the least fuel. This extra-strength engine with accurately controlled thinner wall sections provides you with power-plus to carry your profit-making payloads with great dependability at low operating cost.

GMC 230 ENGINE

Max. gross B.H.P.....140 @ 4400 r.p.m.
 Max. net B.H.P.....120 @ 3600 r.p.m.
 Max. gross torque (lbs. ft.).....220 @ 1600 r.p.m.
 Max. net torque (lbs. ft.).....205 @ 1600 r.p.m.
 Bore, 3.875 in.....Stroke, 3.25 in.
 Displacement.....230 cu. in.
 Compression ratio.....8.5 to 1

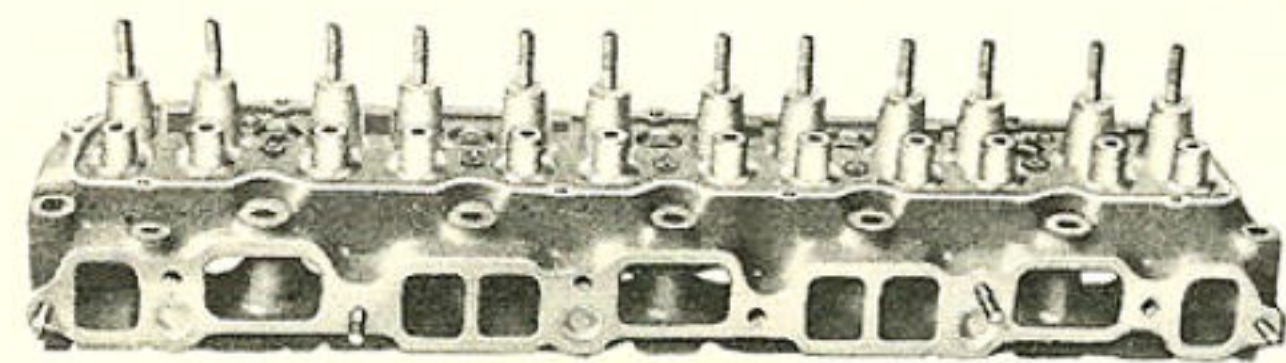

2

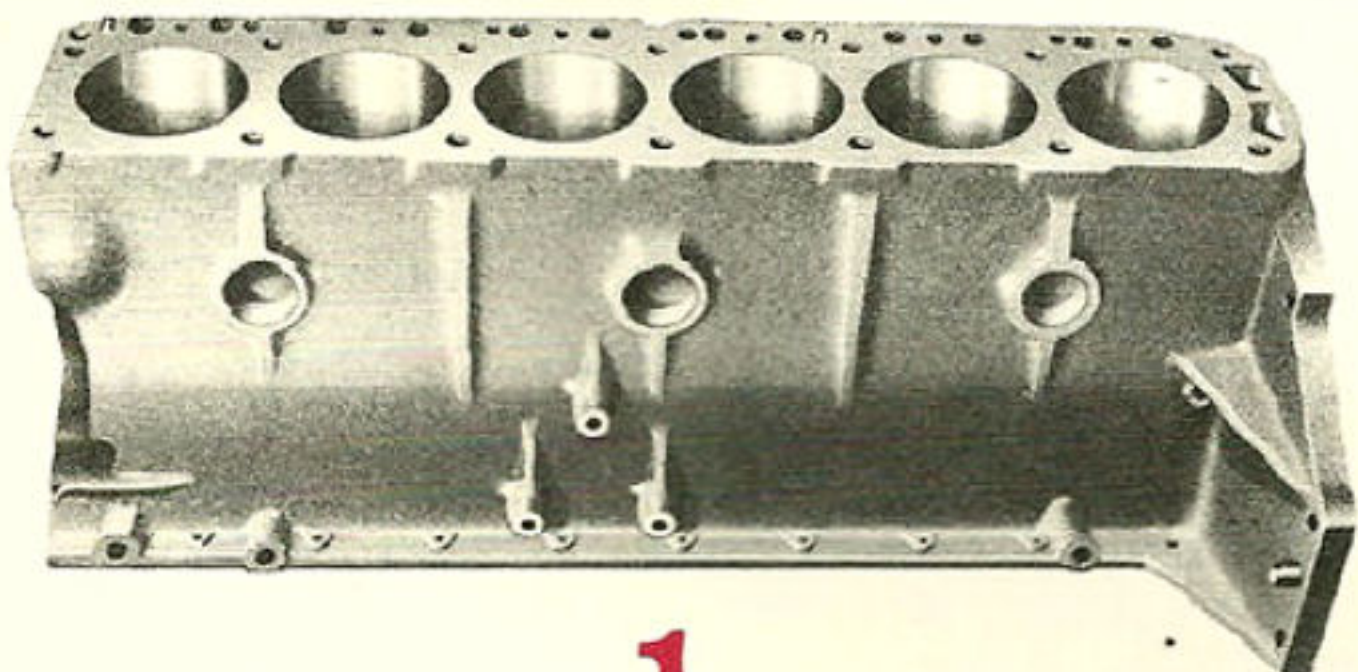

1

3

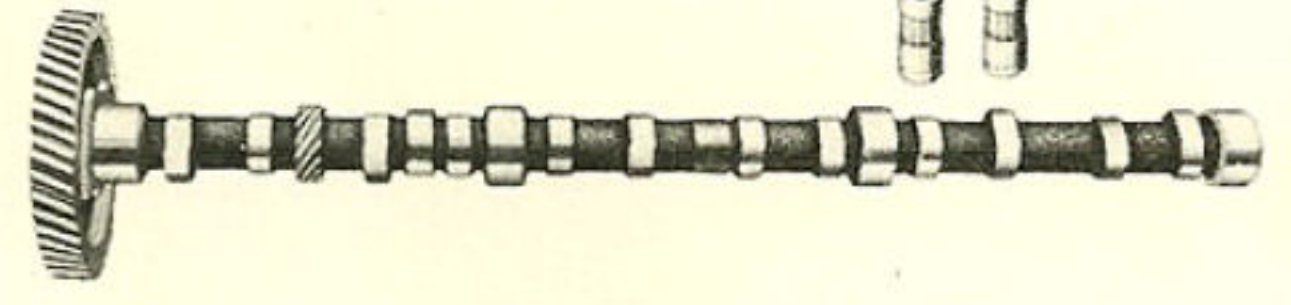

5

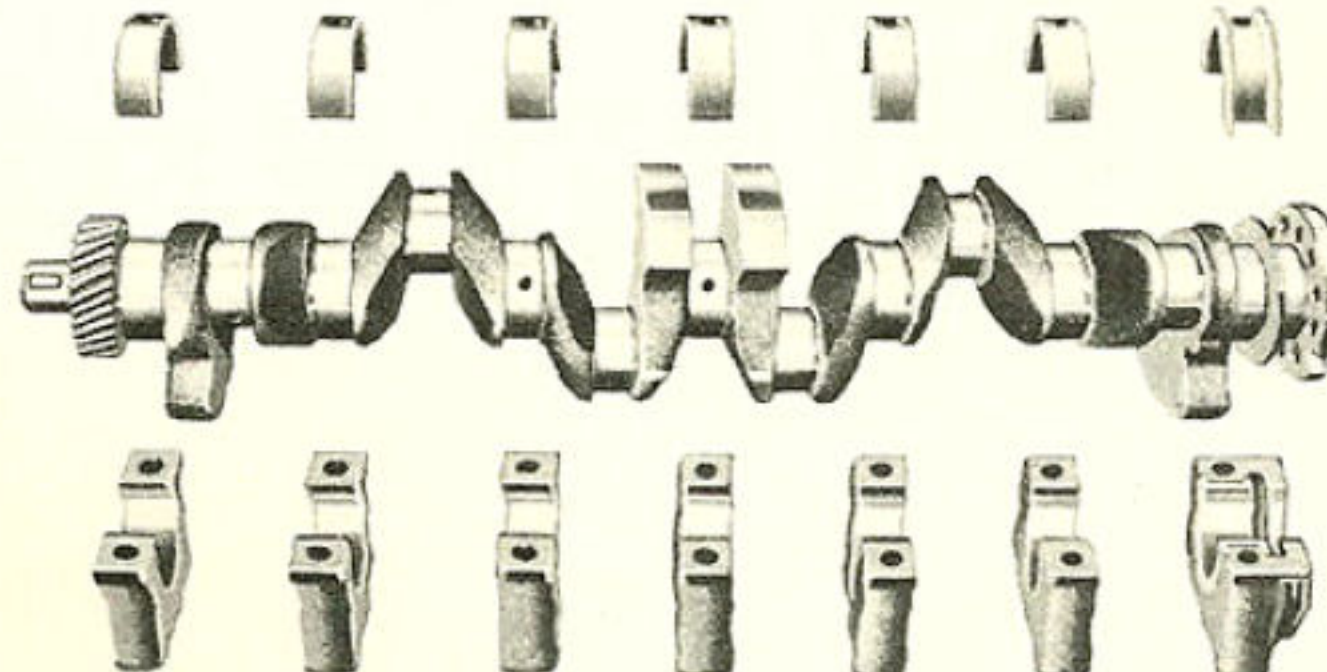

4

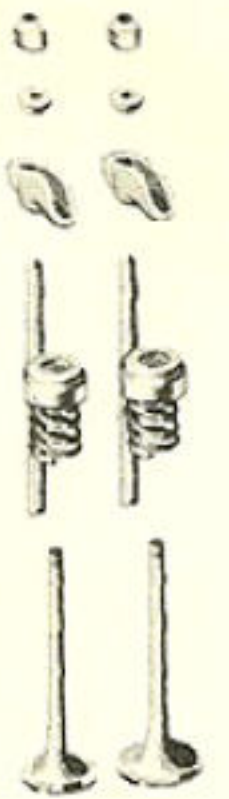

6

1 **PRECISION-CAST BLOCK AND CRANKCASE**—Stiff, cast-in reinforcements strategically located provide great durability. Full-length water jackets uniformly cool the cylinder walls to eliminate hot spots and prolong engine life.

2 **PRECISION-CAST CYLINDER HEAD**—A super-strong cylinder head provides excellent rigidity. Large, precision-cast intake and exhaust chambers, integral valve guides, and ample water passages add high operating efficiency. Combustion chambers are contoured to develop full power smoothly and quietly from regular grade gasoline.

3 **CAST ALUMINUM PISTONS**—Light weight, aluminum alloy pistons with cast-in steel struts (for controlled expansion) produce peak pulling power. A steel-belted top groove teams with a flash-chromed top ring to give long piston and cylinder wall life. Three rings (two compression and one oil-control) provide positive compression sealing and maximum oil economy.

DROP FORGED STEEL I-BEAM CONNECTING RODS—Through short, sturdy connecting rods piston power flows smoothly to the crankshaft. Shrunk fit, solid chromium steel piston pins absorb combustion forces easily for long trouble-free service.

4 **CAST CRANKSHAFT**—This nodular iron crankshaft is extra tough. Four integral counterweights minimize vibration. Seven Moraine alloy main bearings give solid support from end to end.

5 **CAST ALLOY IRON CAMSHAFT**—Cradled in four steel-backed babbitt bearings, this helical gear driven camshaft assures precise valve operation and top economy.

6 **PRECISION VALVE MECHANISM**—High alloy steel valves, hydraulic valve lifters, tubular push rods, and independent rocker mounts combine to provide a free-breathing, free-venting, highly efficient valve mechanism.

GMC's V-6 Engine - TODAY'S MODERN TRUCK POWER!

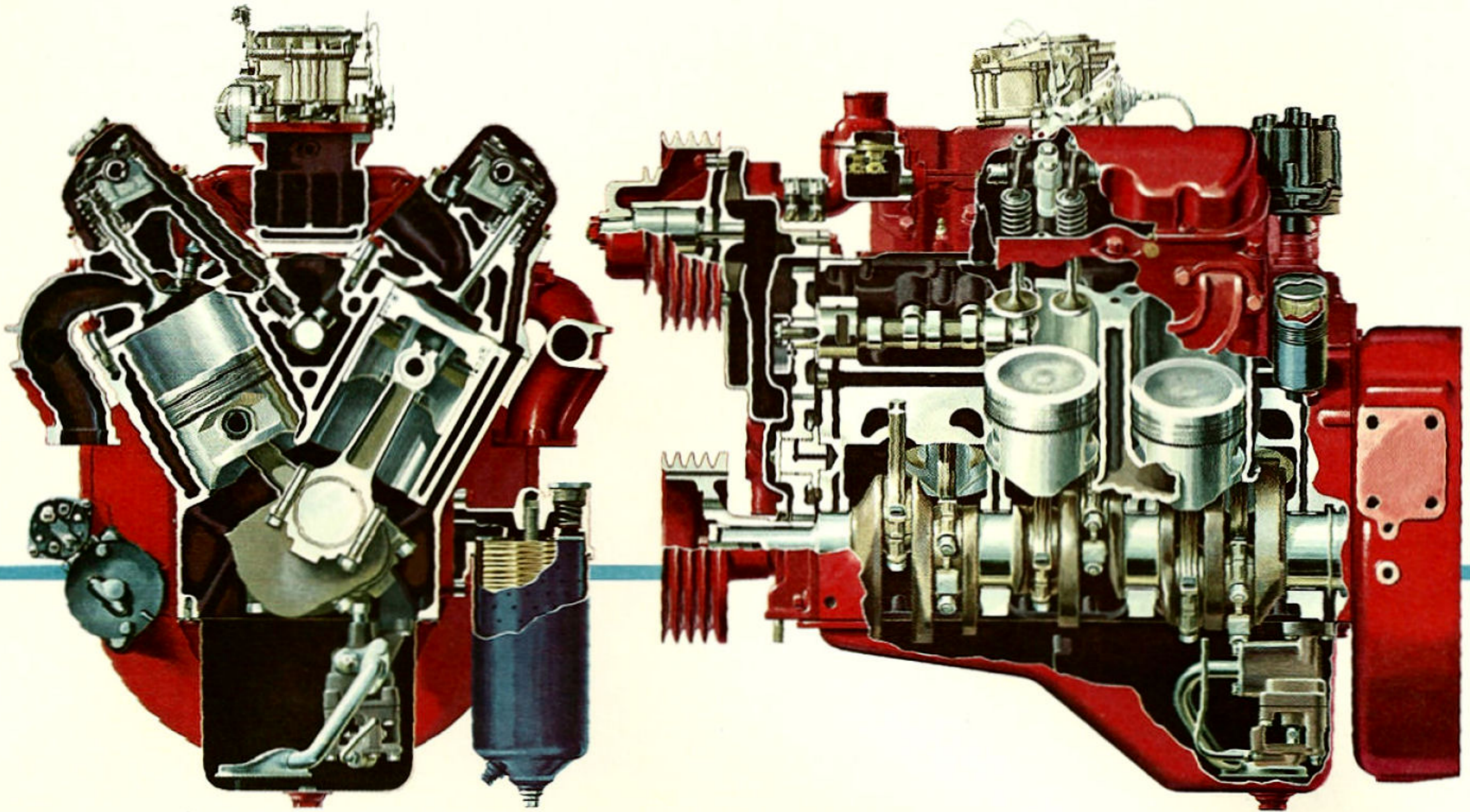

CROSS SECTIONS THROUGH A TYPICAL GMC V-6 ENGINE
(MODEL 401)

GMC's exclusive, time-proved 6-cylinder engine with modern 60°, "V" type design is the greatest advancement in truck-built gasoline engines in over a quarter century.

It's a product of GMC truck and Coach Division's 50 years of truck engine design experience combined with the vast resources of General Motors Research and Testing Laboratories. These new engines have surpassed all the most rigid specifications established for an engine that is to be used exclusively in trucks.

It does your job better and saves you money. Here are a few reasons why:

- Its short stroke reduces internal friction . . . gives full power with less piston travel. Result is less engine wear . . . longer engine life.
- Peak torque is reached at low r.p.m. and maintained over a wide range of engine speed for longer sustained power. The toughest jobs are handled in stride.
- Oil and fuel consumption is low . . . maintenance and service costs are low . . . save you money four ways.
- It has the highest cooling and lubricating ability of any comparable size engine. This means greater engine efficiency . . . longer trouble-free service.

- Many major parts are interchangeable within all GMC V-6 engines to provide greater parts availability and standardization.
- High mounted camshaft . . . short push rods . . . big, tough, long-lived valves combine to make an exceptionally rigid, durable valve train. Again . . . lower cost, longer life, more economy . . . for you!
- Strength where strength counts! Short, rigid crankshaft . . . massive connecting rods . . . big, rugged, heavy-duty pistons. Many thousands of miles of dependable service.

*and . . . It's compact!
Light in weight!
Easy to service!*

Most of the outstanding "big" engine features of the GMC 401 engine are also found in GMC's 305 E engine. This power-packed engine, with the time-proved dependability of six-cylinders, plus the advantages of V-type design, does your job better with less operating and maintenance expense.

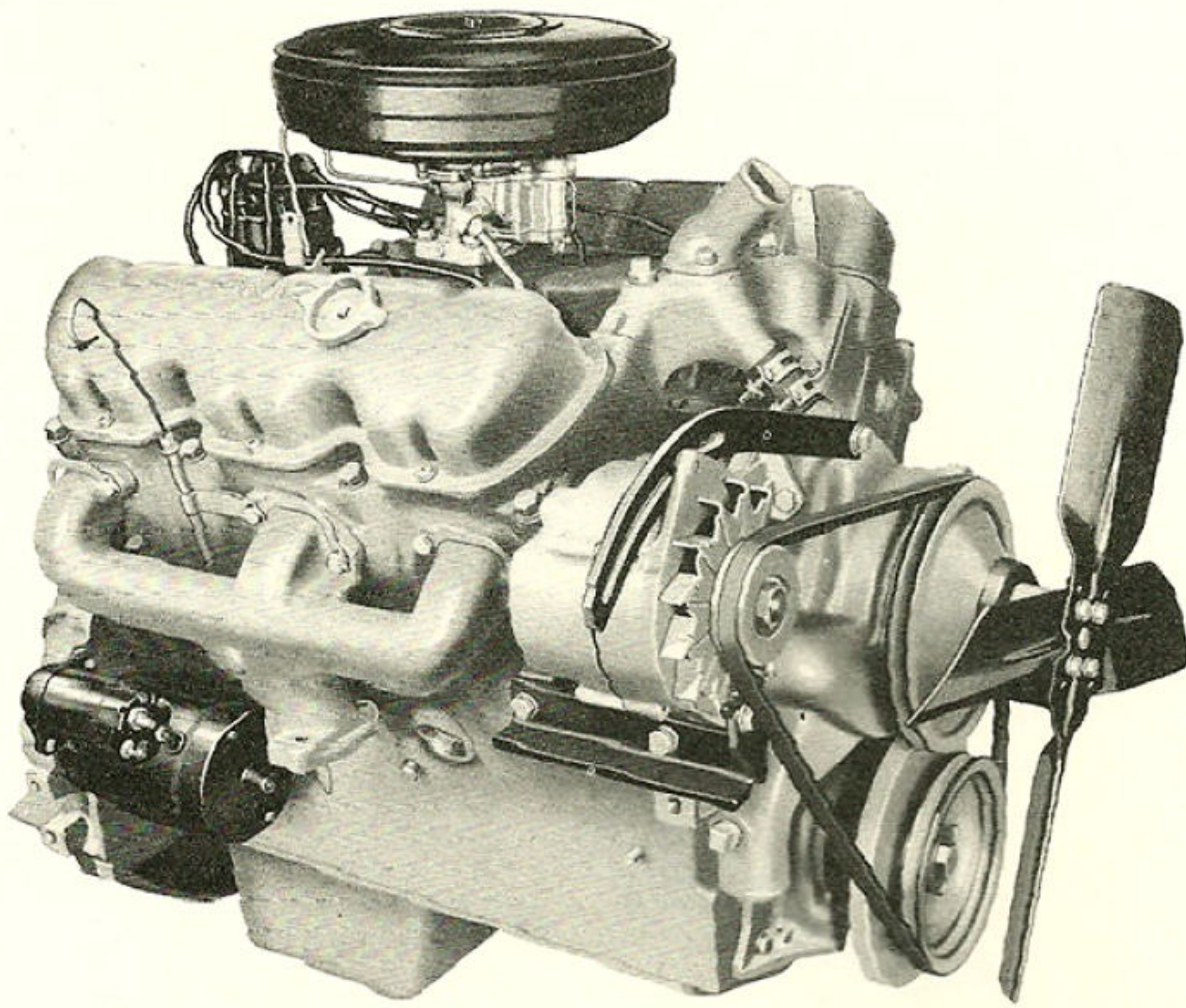

GMC 305E ENGINE

Max. gross B.H.P.....165 @ 3800 r.p.m.
 Max. net B.H.P.....142 @ 3800 r.p.m.
 Max. gross torque (lbs. ft.).....280 @ 1600 r.p.m.
 Max. net torque (lbs. ft.).....260 @ 1600 r.p.m.
 Bore, 4.25 in.....Stroke, 3.58 in.
 Displacement.....304.7 cu. in.
 Compression ratio.....7.75 to 1

THE HIGH OUTPUT OIL PUMP, capable of pumping 14 gallons of oil per minute, provides extra circulation at all engine speeds . . . extra protection and well oiled surfaces on all vital moving parts. Engine is lubricated as soon as it's started. Cam lobes dip into a built-in reservoir of oil as the camshaft rotates, preventing cam and valve lifter scuffing—a major reason why this engine gives long, dependable service.

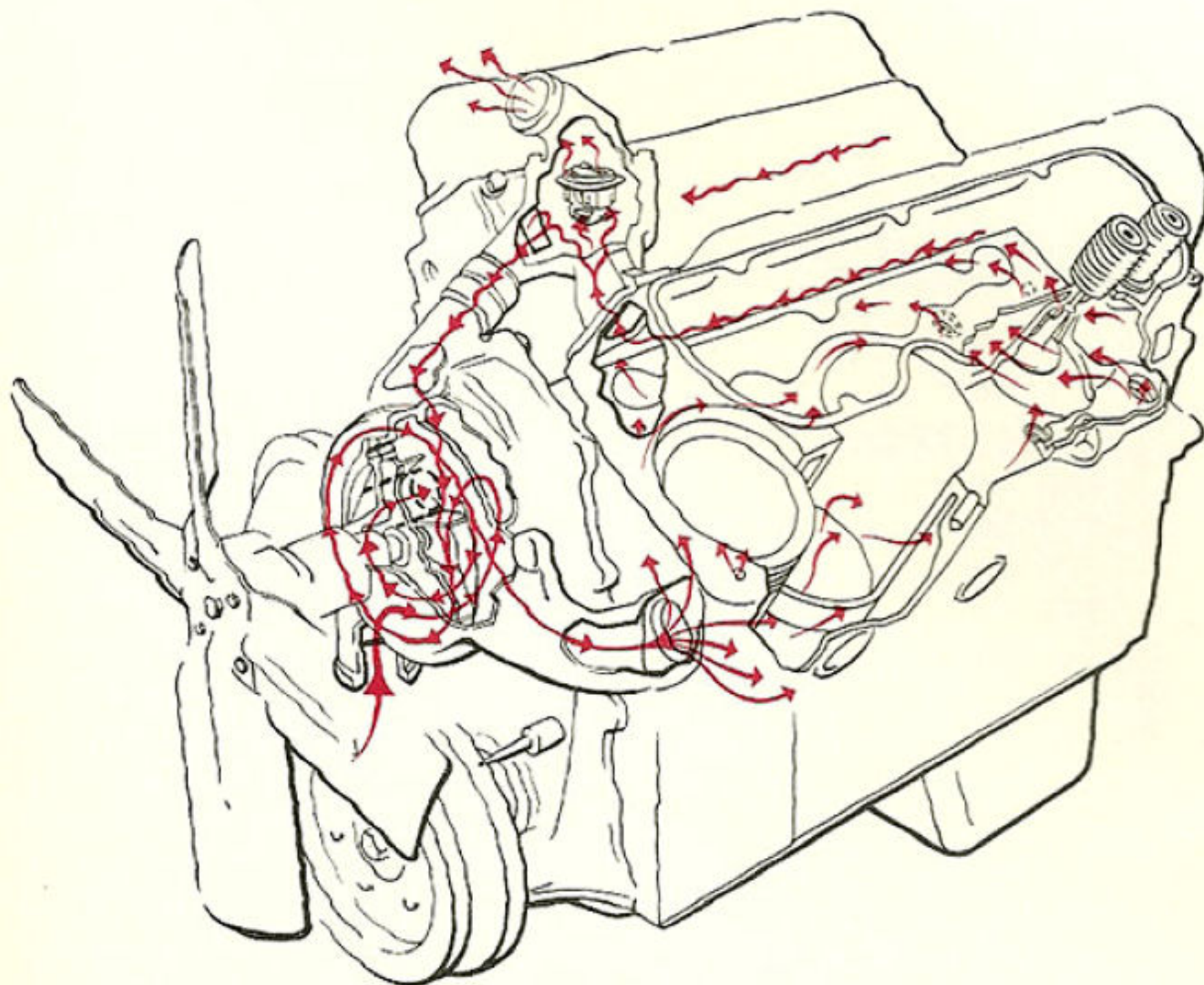
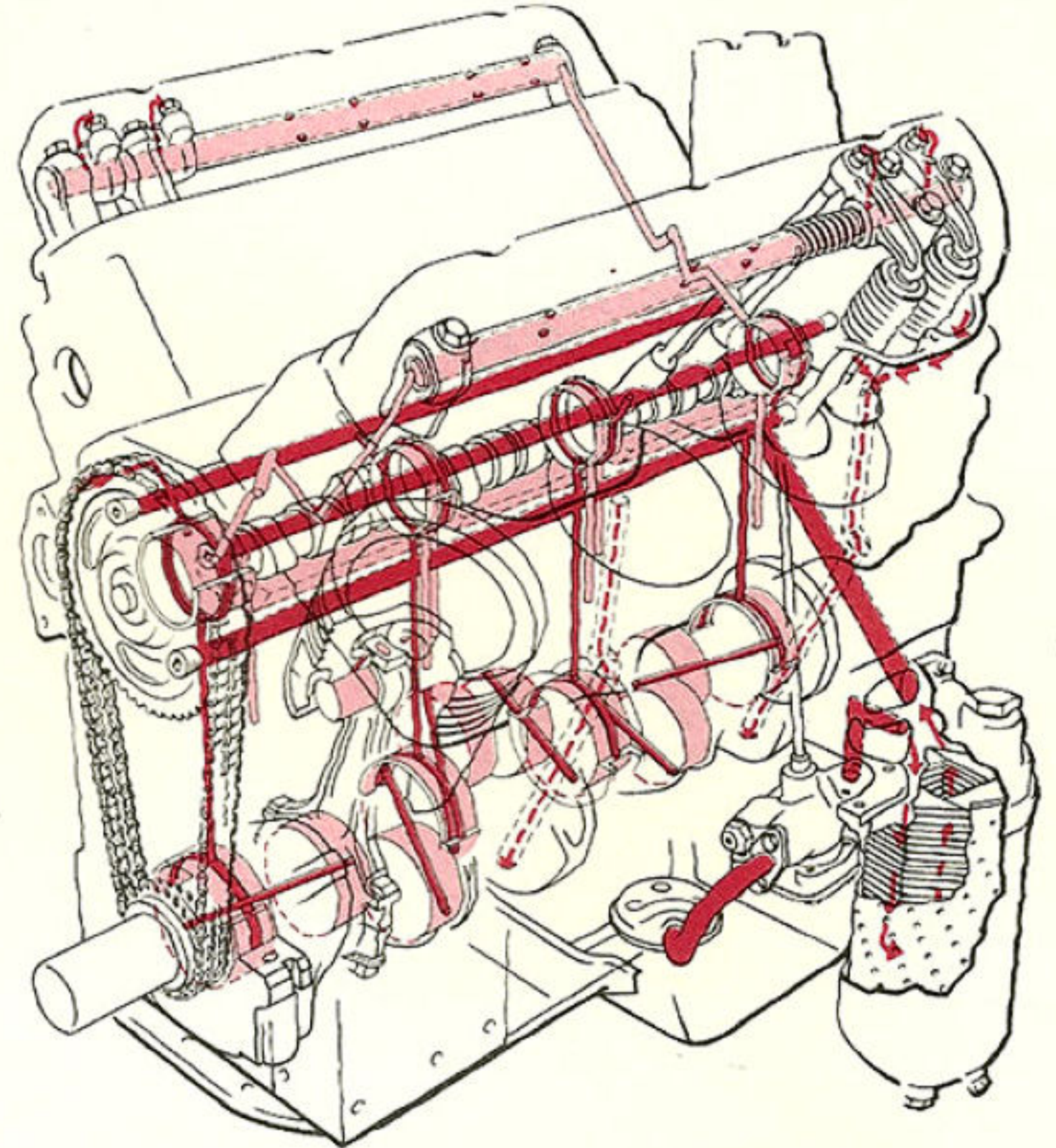

POSITIVE CRANKCASE VENTILATION is provided by using manifold vacuum to draw fresh air through the engine. Air enters through a replaceable paper-element breather, travels up through crankcase to cylinder head covers, then through air flow regulating valves directly into an intake port of each cylinder head, carrying with it, into the combustion chamber, harmful sludge-forming fumes and moisture laden air. Bearings and other precision parts last longer . . . maintenance is less . . . engine life is extended.

135 GALLONS OF WATER (at 3400 r.p.m.) are pumped through this engine every minute. With thermostat open, only half the water goes to the radiator; the other half returns to the pump through a by-pass. This results in excellent cooling ability. There is less than four degrees variation in water temperature throughout the engine. This checks the possibility of hot spots. Here's cooling efficiency that is not matched by any other comparable size engine. Life of pistons, valves, valve guides and spark plugs is much greater, and the possibility of head-cracking is held safely in check . . . further proof of the durability and long life that is built into this engine.

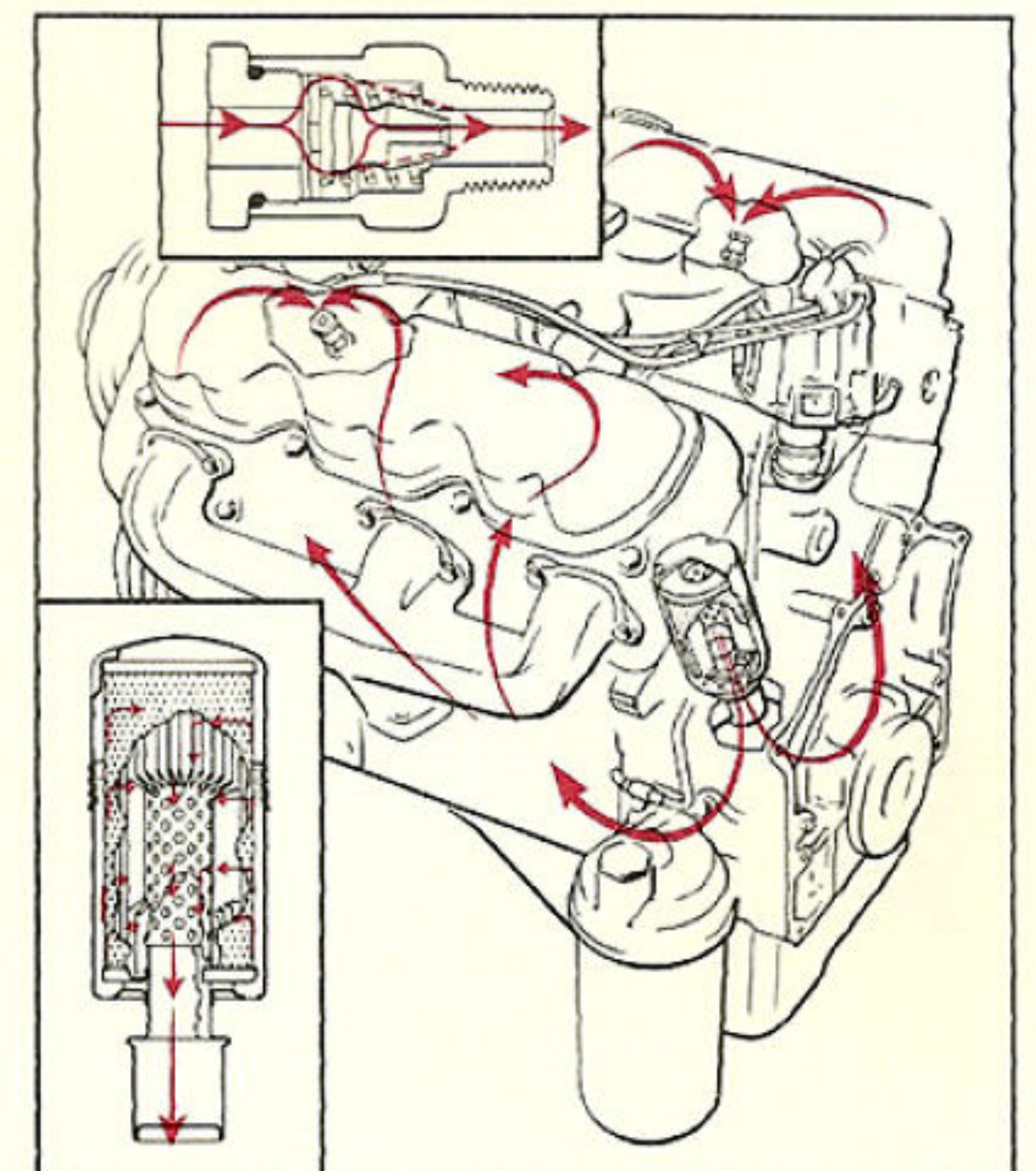

You get the best of all that's new with GMC's

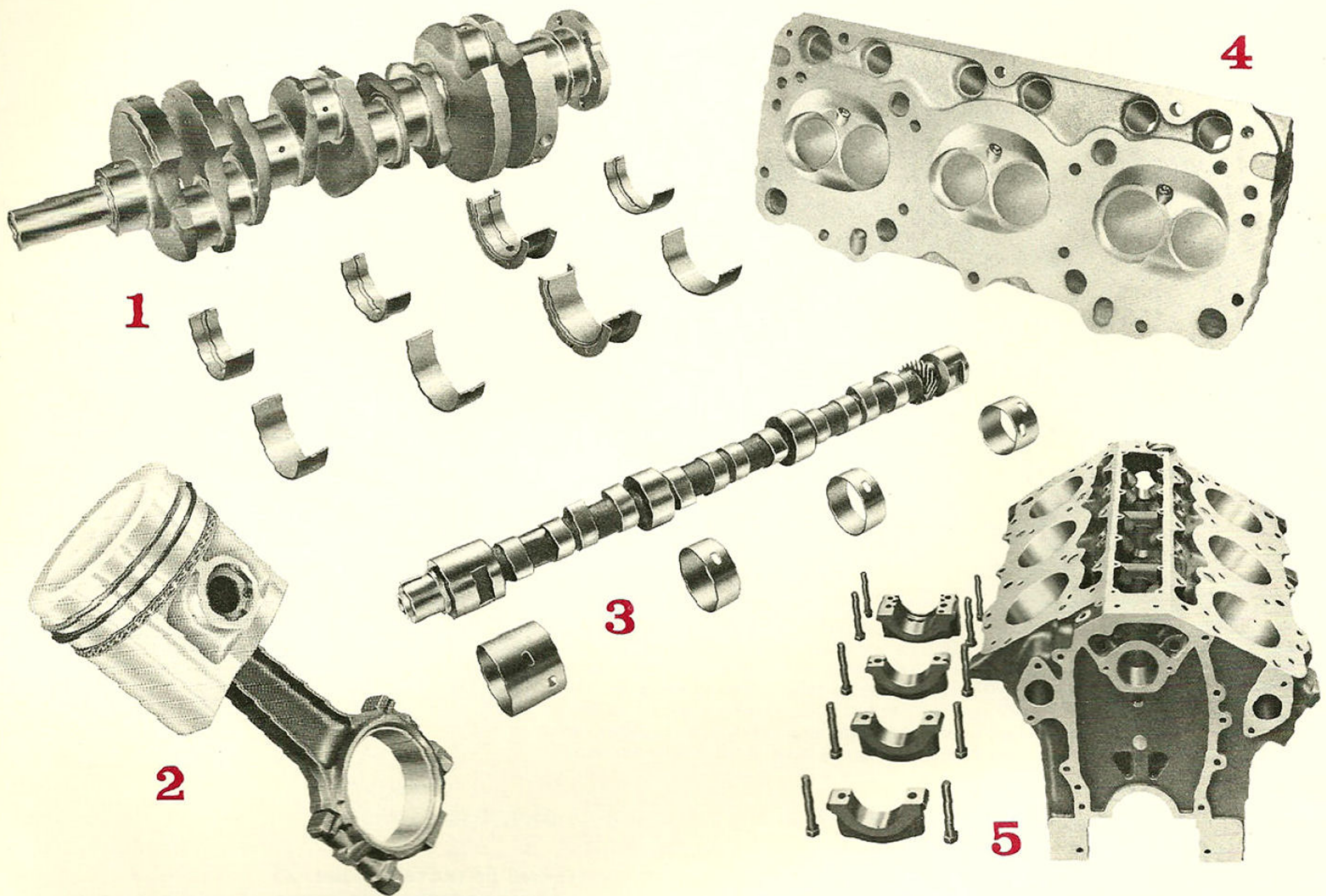

1 **SHORT, RIGID CRANKSHAFT** has 4 extra large main bearing journals . . . 6 extra large crankpins—one for each connecting rod. Its heavy weight and short length make it exceptionally rigid. Moraine, precision, replaceable main and connecting rod bearings provide excellent durability . . . unusual long life.

2 **CAST ALUMINUM PISTONS** cam ground; and with cast-in steel expansion control band, eliminate piston slap. Pistons are weighed and matched to exacting tolerances to ensure vibration-free performance. Long skirts are precision-ground and tin-plated to prevent scuffing during initial run-in. 3 rings—2 compression, one oil control—provide positive compression sealing . . . improved oil economy. Top compression ring and oil control ring have thick facing of chrome plating for longest wear.

FORGED CARBON STEEL, I-BEAM CONNECTING RODS are extra rigid. Piston pins are efficiently lubricated by large wells on top of rods. Piston pins and connecting rods are weighed and matched to exacting tolerances to give smoothest engine operation. Rods are interchangeable with those used in the largest GMC gasoline engine—proof of this engine's ruggedness.

3 **HIGH STRENGTH, ALLOY IRON CAMSHAFT.** Cam lobes and bearing journals are induction-hardened for great wear resistance. Short, stiff push rods provide rigid valve train and positive valve action. Valves last longer . . . fewer adjustments are needed . . . service expense is lower.

4 **FULLY-MACHINED COMBUSTION CHAMBERS.** Smooth, precision-machined combustion chambers—rarely found in this size engine—minimize carbon deposits, hot spots and pre-ignition. And—there is uniform combustion in all 6 cylinders for smoothest engine operation. 6 equally-spaced cylinder head bolts (not 4 as found in other engines) surround each cylinder to reduce bore distortion . . . guarantee gasket sealing for long engine service. Spark plugs, located inside the "V", away from hot exhaust manifolds, run cooler, have much shorter wires, and are easy to service.

5 **EXTRA HEAVY BLOCK AND CRANKCASE** is solidly cast of high strength, long-wearing iron alloy. A deep, 3-inch ribbed skirt below the centerline of the crankshaft provides rigid reinforcement to the crankcase. Cylinders are widely spaced and staggered, providing even greater block rigidity and much greater cooling area around cylinder walls for long engine life.

Truck-built Engine! HERE IS THE INSIDE STORY OF GMC's 305E ENGINE

Also available, at extra cost, are:

1. Two-piece exhaust valves
Positive valve rotators
2. Silchrome inlet valves
Hard-faced silchrome exhaust valves
Positive valve rotators

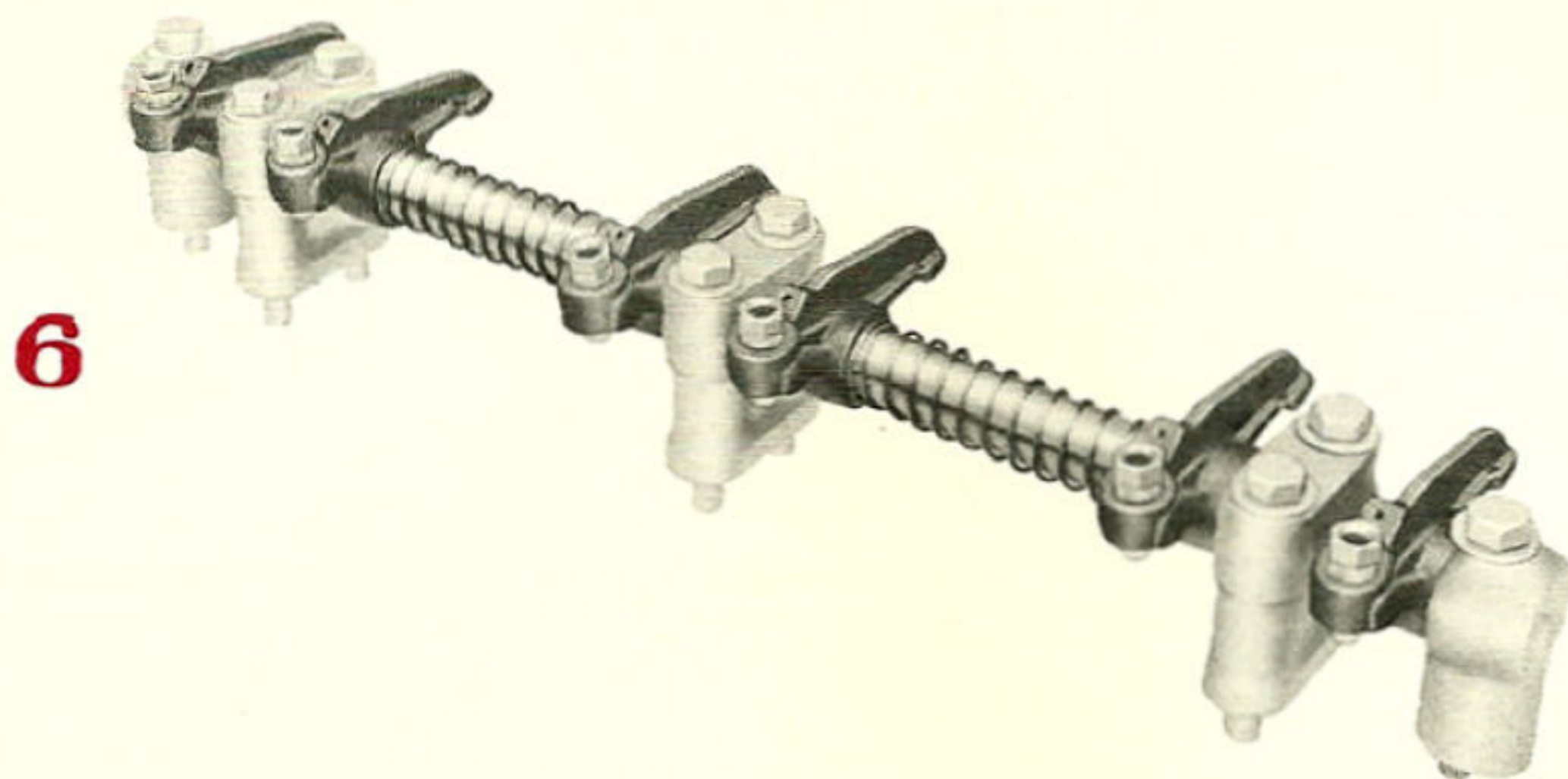

6

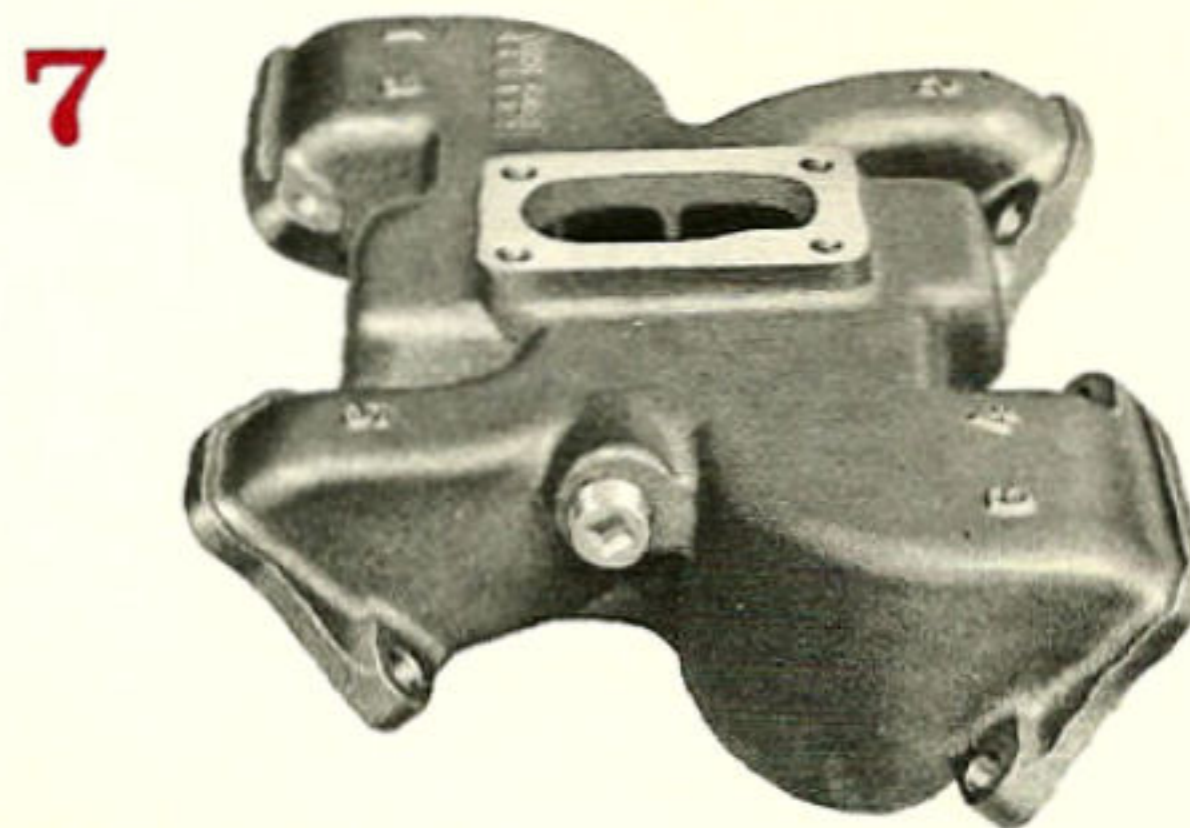

7

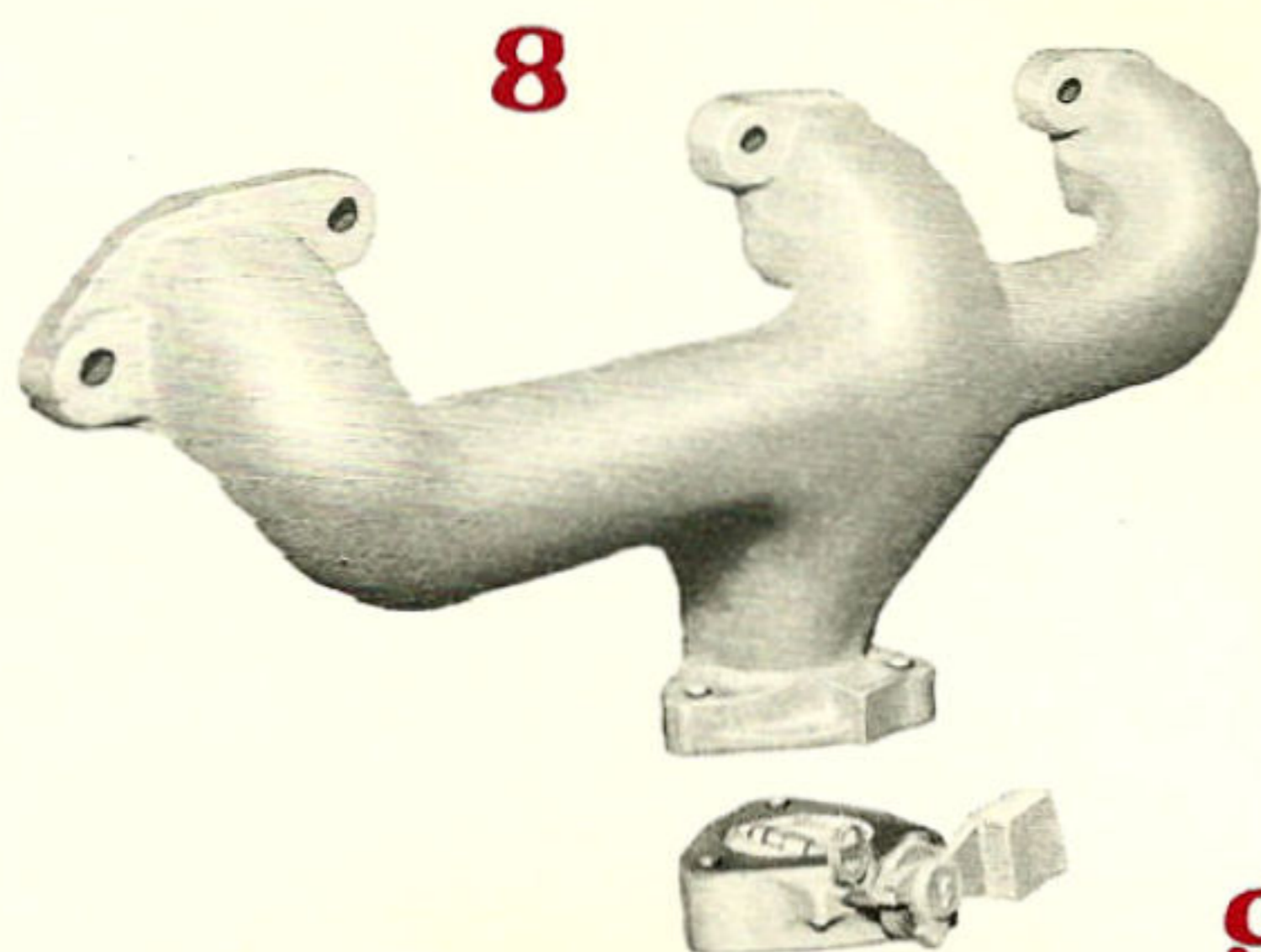

8

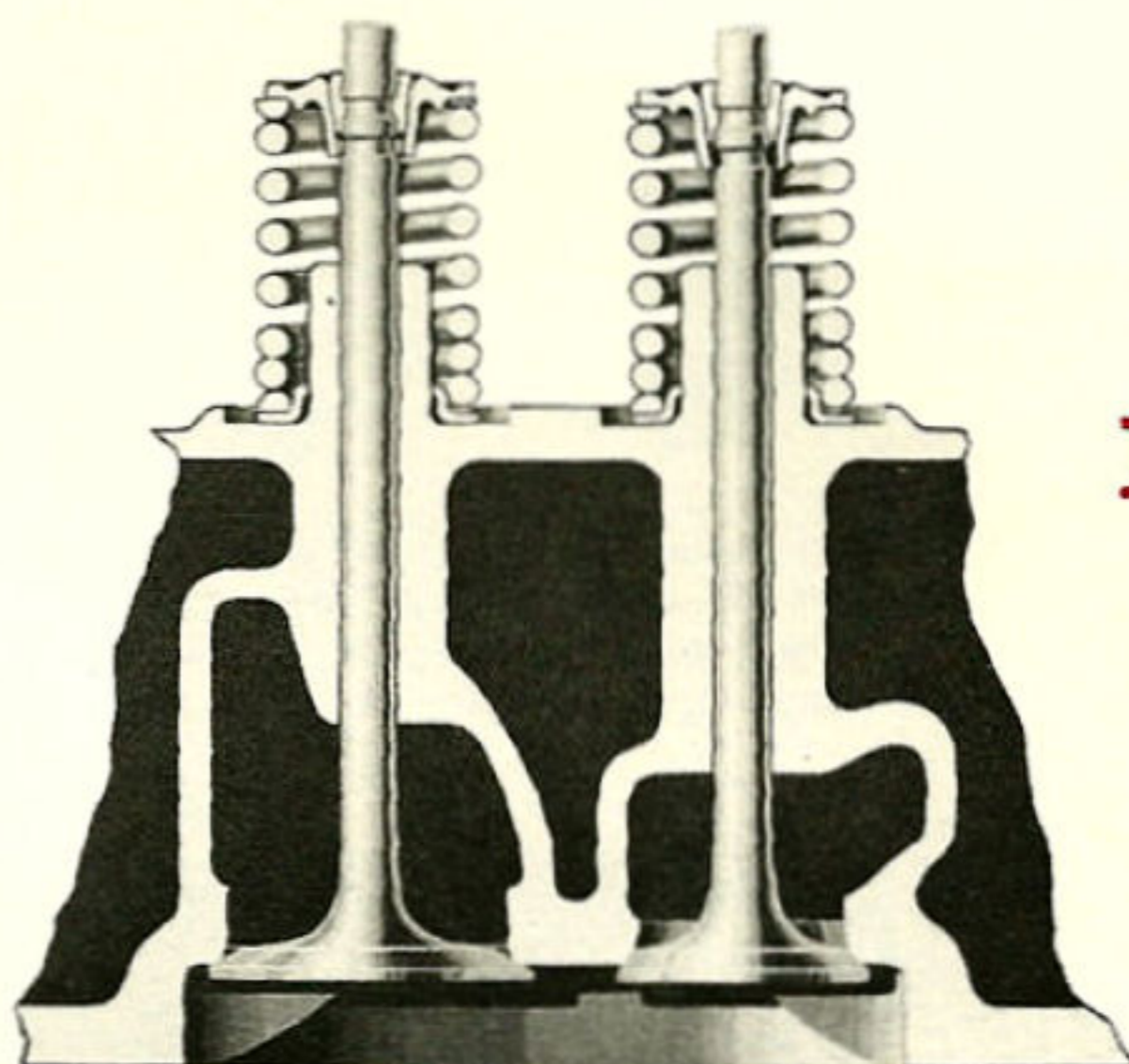

10

9

Heavy bearing caps and the use of 4 (not the usual 2) large cap screws on the rear main bearing assure perfect crankshaft alignment, minimize crankshaft deflection and assure maximum bearing life.

6 ALUMINUM ROCKER ARM BRACKETS. The hardened steel rocker arm shaft is held firmly in place by 5 aluminum brackets. As valves warm up and expand, brackets expand too, assuring proper valve clearance under all operating temperatures. The engine runs quieter . . . fewer valve adjustments are needed . . . valve life extended.

Brackets at both ends of the shaft, and one bracket between each set of rocker arms holds shaft deflection in check. This, plus the high-up camshaft mounting and use of short, stiff push rods provides an exceptionally rigid valve train. Just another way you save on maintenance and get longer engine life.

7 SHORT INTAKE MANIFOLDS with individual ports for each cylinder are a special feature of this engine. Individual ports permit faster intake and more uniform distribution of fuel-air mixture to each cylinder. Because manifolds are short and have a minimum of bends and curves, too rich or too lean fuel mixtures, usually found in longer in-line or V8 engines are completely eliminated. This results in much better fuel economy, cleaner, more complete combustion and greater engine efficiency.

8 TOP QUALITY EXHAUST MANIFOLDS. Identical left and right exhaust manifolds of special alloy iron are highly resistant to cracking and warping by extreme temperature changes. Large individual ports for each cylinder and short, large diameter passages permit more complete scavenging of exhaust gases. Result is better fuel economy . . . longer life . . . better performance.

9 ANOTHER EXTRA-VALUE FEATURE. A thermostatically controlled valve, at the outlet of the right hand exhaust manifold, automatically regulates the flow of exhaust gases to shorten the engine warm-up time and give you better fuel economy . . . better performance.

10 LARGEST VALVES. This engine has the largest diameter intake and exhaust valves of any comparable size engine. This means it is unsurpassed in volumetric, or breathing, efficiency. Combustion is more complete, scavenging of exhaust gases more thorough. The engine gets more work out of a gallon of gasoline . . . and stays cleaner longer, too. In addition, valves have short, large diameter stems to reduce possible distortion and dissipate heat quickly. Short, rigid push rods hold valve train deflection to a minimum and help keep engine in top running condition. Valve clearance is controlled by self-locking adjusting screws . . . tune-ups are easy . . . upkeep low.

**GMC's WIDE SELECTION OF CLUTCHES, TRANSMISSIONS, AND REAR AXLES,
LETS YOU TAILOR YOUR TRUCK TO YOUR PARTICULAR NEEDS.**

LOOK AT WHAT YOU GET:

Clutch

LONG-LIFE CLUTCHES

Big, single plate, spring cushioned, clutches used with the V-6 engine and In-line-6 engine are more than adequate to handle capacity loads under normal operating conditions. However, if you operate off-road, in hilly or mountainous areas, or stop and start much of the time, oversize clutches are available at slight extra cost to assure long life and trouble free service.

EASY-ACTION, SUSPENDED BRAKE AND CLUTCH PEDALS

Special care has been taken in locating the suspended brake and clutch pedals. They're easy to reach . . . easy to operate . . . leave lots of clear floor area for more comfortable driving. Drafty, dust-leaking floorboard holes are no longer there.

Transmissions

FAMOUS GMC 3-SPEED SYNCHROMESH TRANSMISSION



You shift quickly and safely with the popular GMC 3-speed synchromesh transmission. Constant mesh helical gears, synchronized in second and third speeds, eliminate gear clashing and assure quiet operation. Gear ratios provided with this transmission are more than adequate to move your biggest rated loads. Gear shift lever is mounted on the steering column for maximum convenience. (Standard on Series 1000.)

HEAVY-DUTY 3-SPEED SYNCHROMESH TRANSMISSION



Heavily-constructed throughout, and with constant mesh helical gears, synchronized in second and third speeds, this unit operates smoothly and quietly. It is ideal for unusually rugged work where steering column shifting is desired. (Optional at extra cost on Series 1000.)

4-SPEED SYNCHROMESH TRANSMISSION



This transmission is especially designed and engineered to do heavier jobs requiring greater gear reduction and greater strength. Constant mesh, helical gears, synchronized in second, third and fourth speeds, eliminate gear clashing and make shifting easier and less tiring. Power-take-off opening on the left side permits convenient operation of winches, post-hole diggers and other power equipment. (Standard in Series 2500. Optional, at extra cost, in Series 1000.)

SMOOTH, DEPENDABLE AUTOMATIC TRANSMISSION

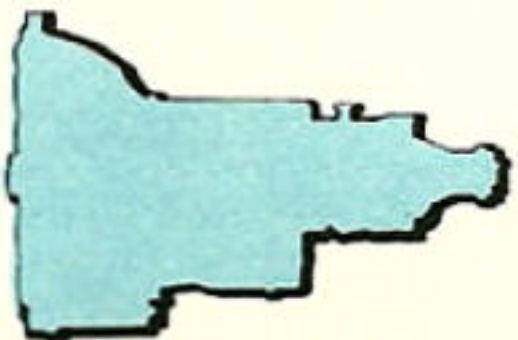

This fully automatic transmission does your shifting for you. Tiresome clutching is gone forever. Engine and drive-line are always protected against strain and shock from improper shifting . . . and all by means of a torque converter and the automatic gear selection of a 2-speed planetary gear set. Here's a transmission that is time-proved in millions of customer miles and one that will give you long trouble-free service. In the city . . . on the open highway, you'll enjoy driving more with GMC's dependable automatic transmission. (Optional, at extra cost, Series 1000.)

Axles

MAXIMUM POWER AND ECONOMY FROM HYPOID REAR AXLES



Extra-strong GMC hypoid rear axles feature greater tooth contact between ring gear and pinion for long axle life . . . much quieter operation. Series 1000 features a 3500 lbs. capacity, semi-floating rear axle with a heavy-duty axle available at extra cost. A 7200 lbs. capacity rear axle in Series 2500 easily moves the heavier loads expected with these units. It features extra-rugged, full-floating axle shafts for longer axle life. Axle ratios available are carefully engineered to provide the best over-all performance and economy. Fast-cruising ratios, standard with the V-6 engine, give overdrive economy without the extra cost of an overdrive transmission . . . your engine lasts longer because it runs at less r.p.m. even with the same size tires.

ALL-WEATHER MAXIMUM-TRACTION DIFFERENTIAL, optional at extra cost, automatically applies power to the wheel having the best traction. It keeps your job moving over all types of roads and terrain.

HUSKY DEEP-CHANNEL FRAMES

Rugged ladder-type frame with deep-channel drop-center side rails form the backbone of these GMC's. You get greater body life because twists and strains normally taken by the body are absorbed by the frame. In addition, driving stability is substantially increased by the frame's rigidity and low center of gravity. The result is a safe and comfortable ride.

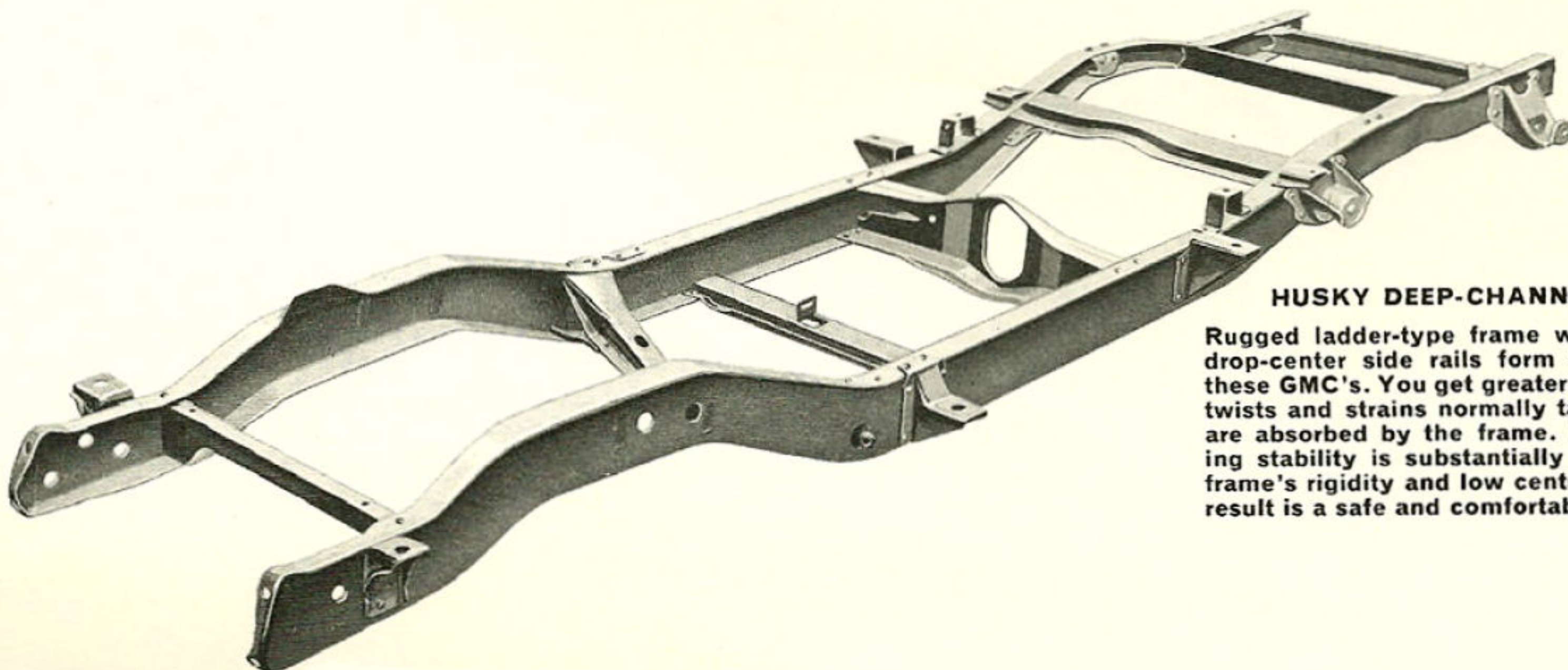

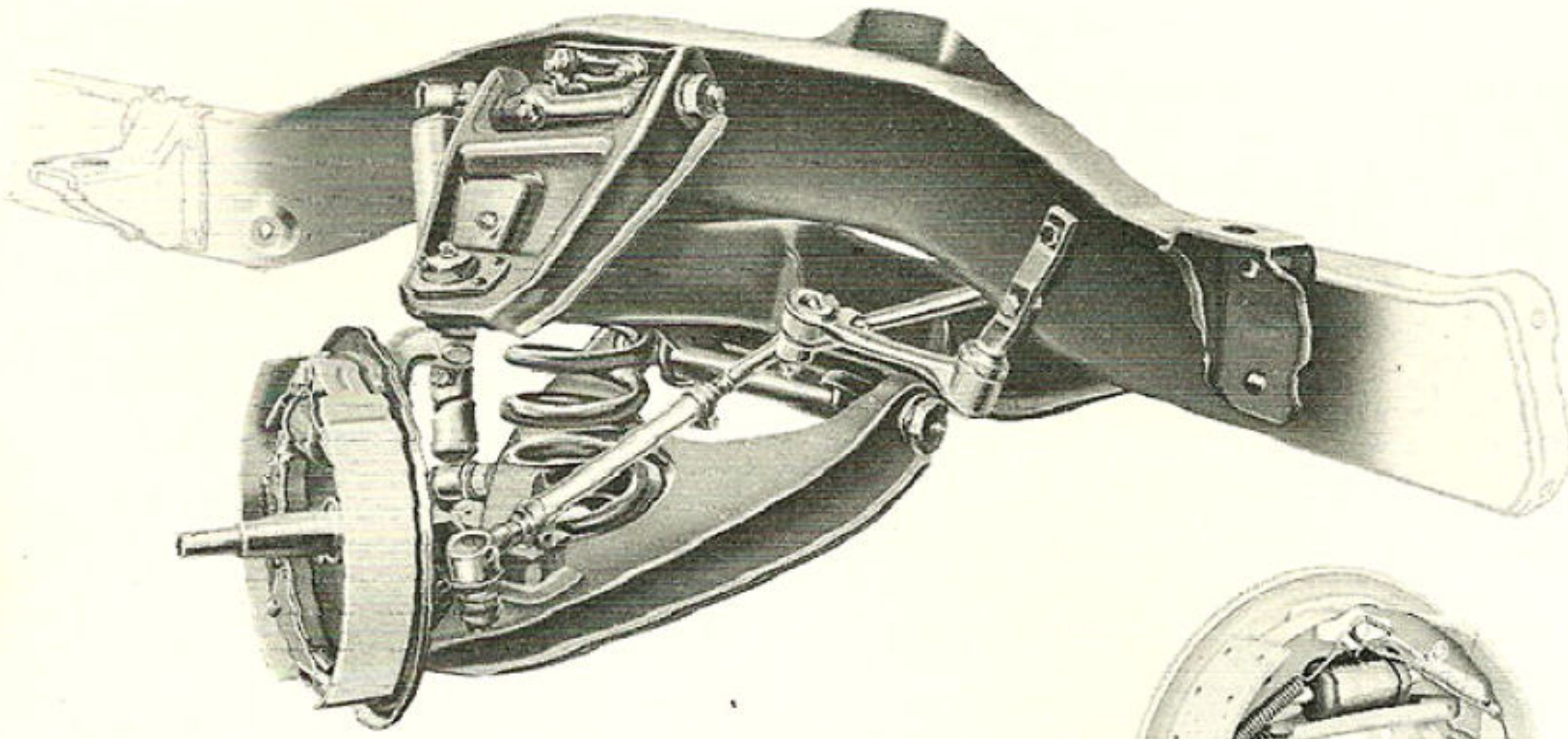

EASY-RIDE INDEPENDENT FRONT WHEEL SUSPENSION

Passenger car ride, greater steering ease and less maintenance are made possible with GMC's modern independent front suspension. Here's why:

- Front wheels operate independently of each other.
- There's no front axle to support . . . deep-coil, friction-free springs give a more comfortable ride. No routine maintenance is required.
- Direct, double-acting shock absorbers soak up road vibrations and add to the smoothness of the ride.
- Ball-joint steering reduces steering friction for effortless driving.
- Frame height and center of gravity are lower for greater road stability.

One demonstration ride will convince you this is the easiest driving, smoothest riding of all!

SELF-ADJUSTING BRAKES

Self-adjusting brakes, a feature on Series 1000, assure proper brake adjustment throughout the entire life of brake lining. You enjoy constant, safe, pedal response . . . no adjustments needed.

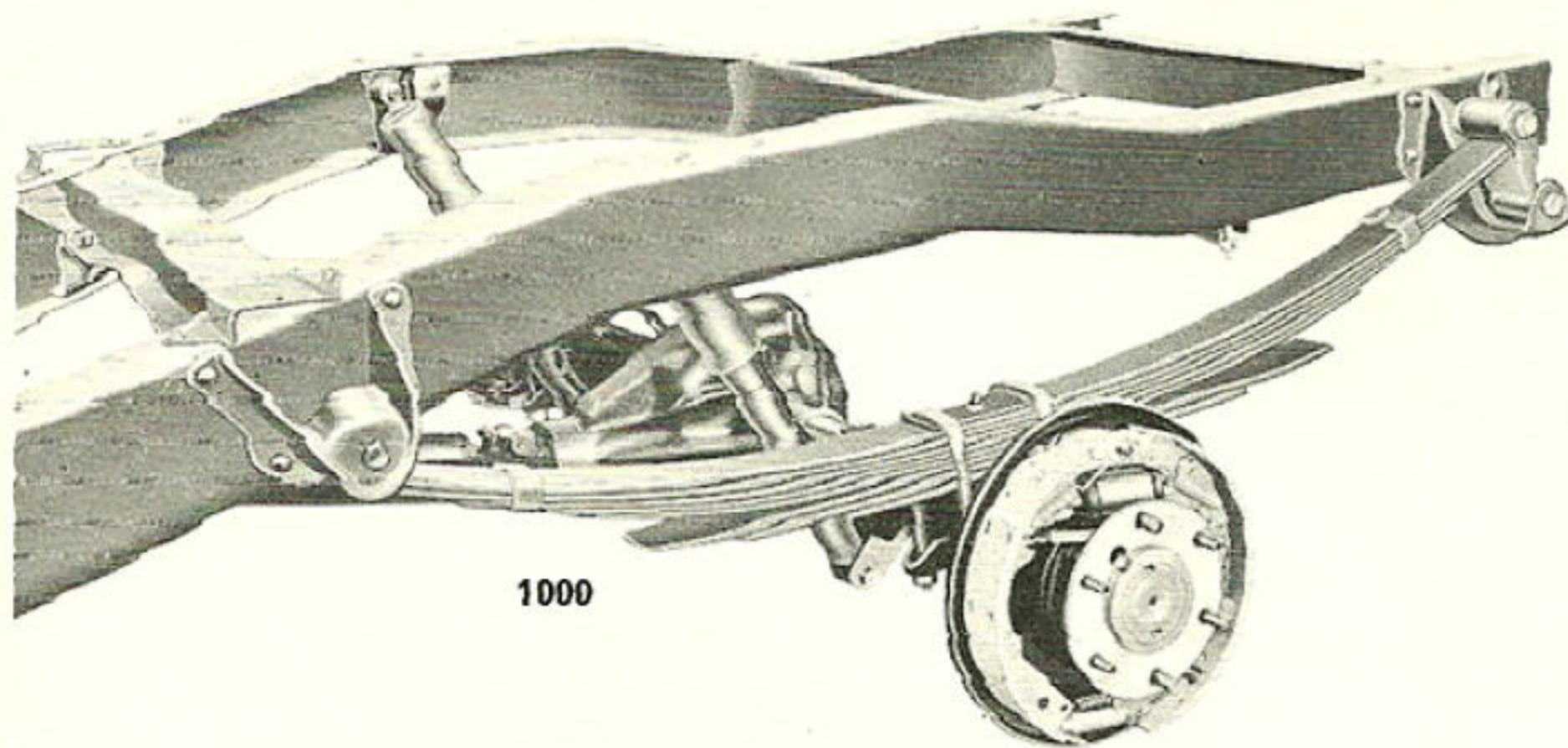
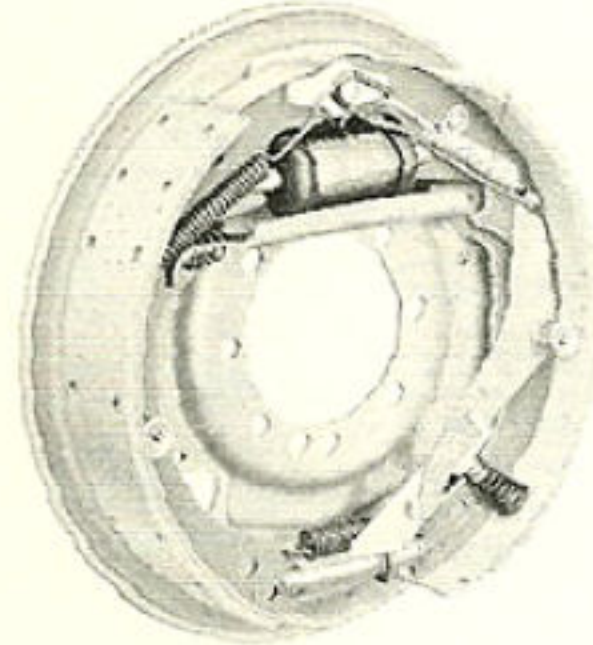

1000

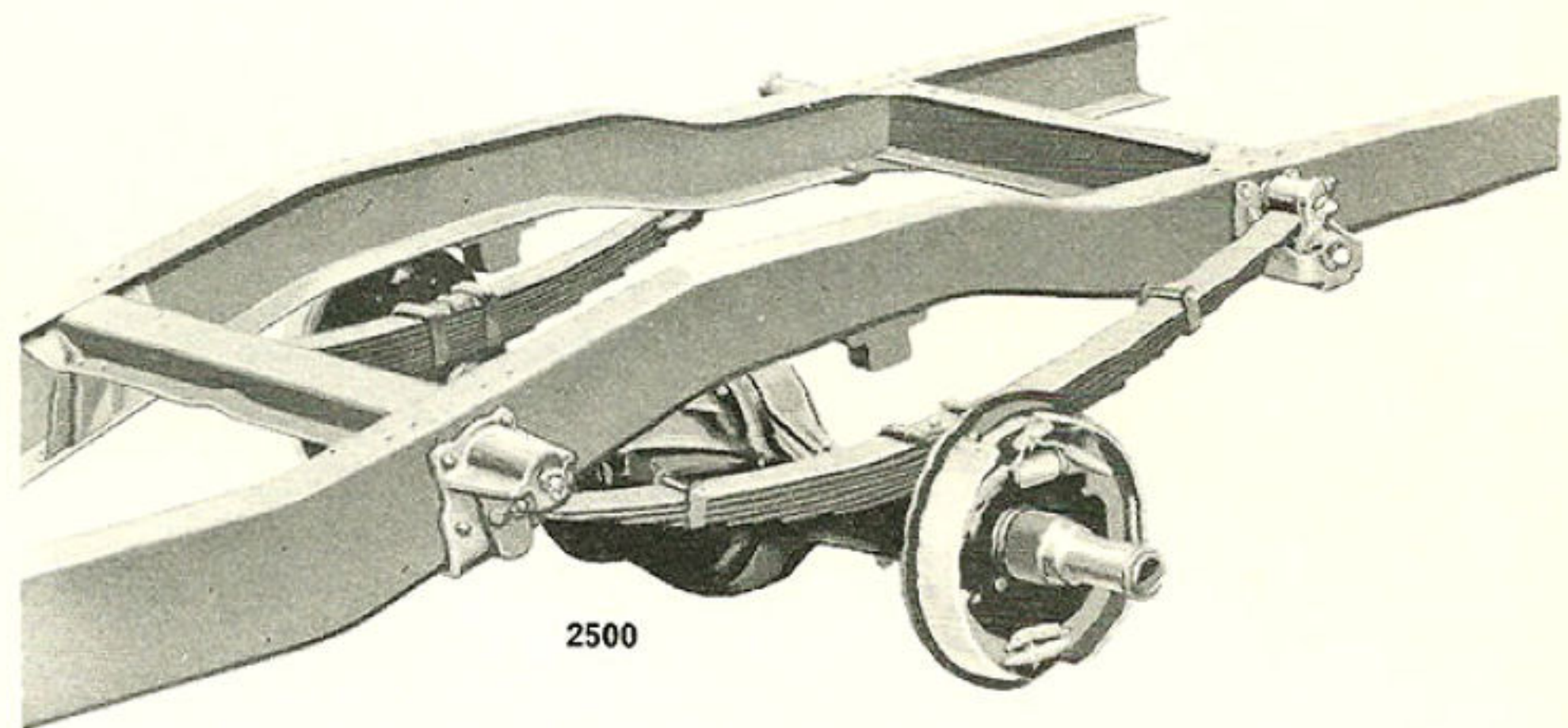

2500

LONG-LIFE, LONG-LEAF, REAR SPRING SUSPENSIONS

GMC Suburbans have long, durable leaf-type rear springs. They're designed to give greater load starting stability, handle payloads with ease and give an excellent ride too. Two-stage progressive type rear springs are standard on Series 1000, optional at extra cost on 2500. Empty or with light loads, just the soft upper

leaves of these springs are utilized . . . with capacity loads, the rugged lower leaves come into action to carry your loads safely and dependably. Double-acting rear shock absorbers (standard on Series 1000, optional at extra cost on 2500) smooth out the ride even more. These are examples of more value from GMC.

V-6 Engine . . . Four Driving Wheels . . .

FOR DRIVING ANYWHERE!

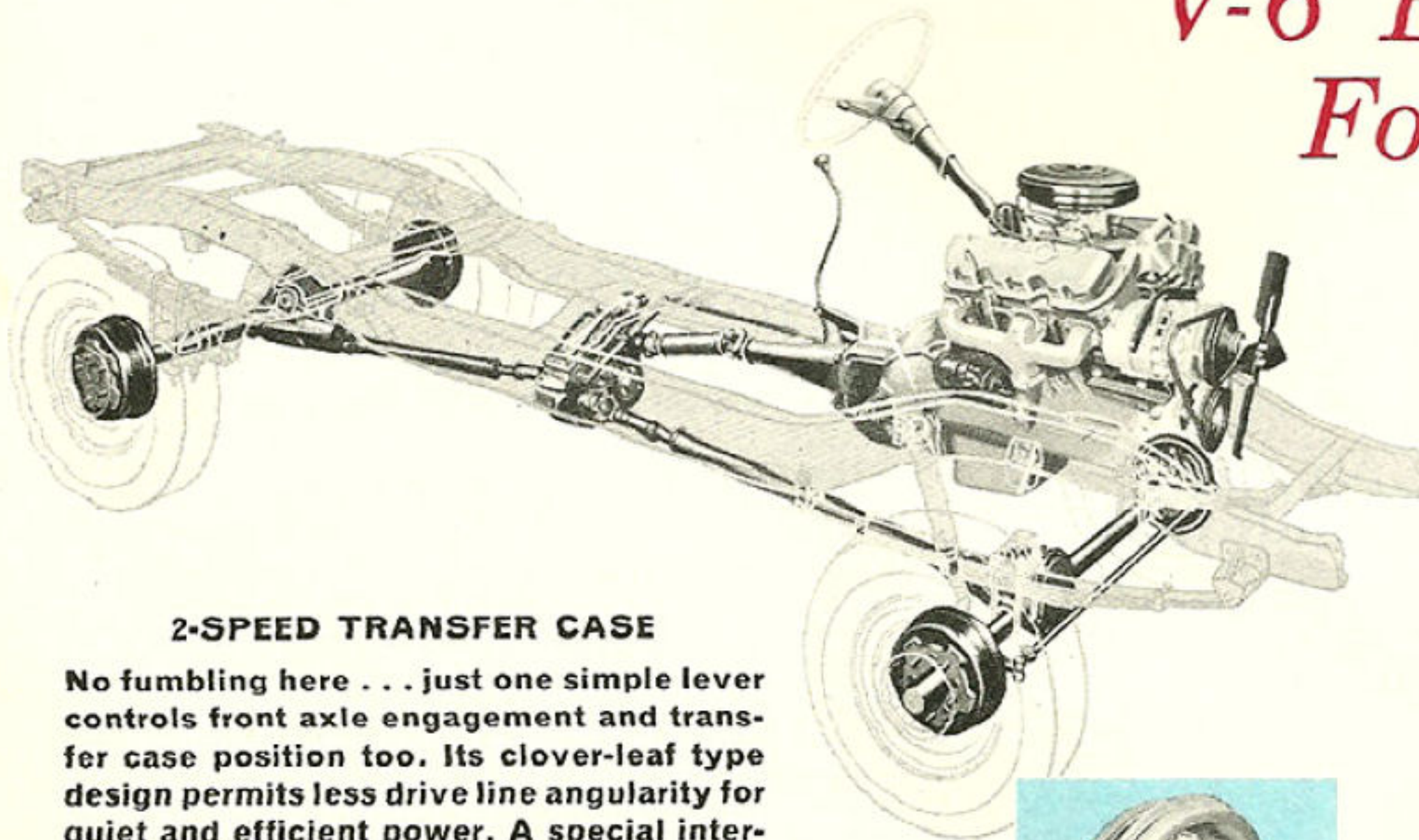

2-SPEED TRANSFER CASE

No fumbling here . . . just one simple lever controls front axle engagement and transfer case position too. Its clover-leaf type design permits less drive line angularity for quiet and efficient power. A special interlock prevents low gear operation of the transfer case without front wheel engagement. Full torque power-take-off is available with drive to the rear; also an indirect type with drive to the front for installation of all types of auxiliary equipment from winches to back-hoes.

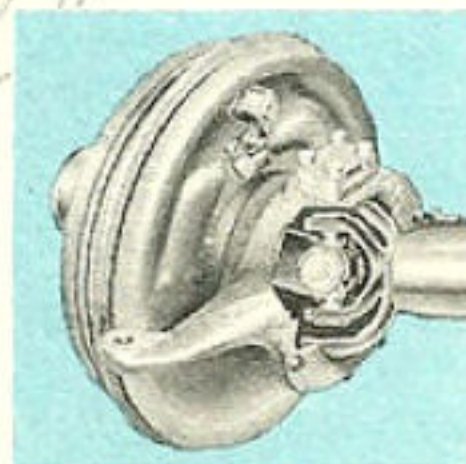

FRONT DRIVING AXLE

Full power at full turn . . . and any other angle too . . . that's what you get with this hypoid geared, universal-jointed front driving axle. It delivers firm, positive power in any position. Forward-mounted steering gear and linkage reduce steering effort and dampen road shock and vibration. Except for its steering features, this unit is a faithful mate to its famous rear driving axle.

S P E C I F I C A T I O N S

SERIES	1000	11000	2500	12500	K1000
RATED GVW LBS.	4600-5200*	4100-5000*	6700-8800*		4600-5600*
AIR CLEANER—Standard	Oil Bath, 1-pt.	Oil Wetted	Oil Bath, 1-pt.	Oil Wetted	Oil Bath, 1-pt.
Optional*	Oil Bath, 1-quart capacity				
AXLE, FRONT	Independent front wheel suspension				Hypoid, driving-steering
Type					
Rating (lbs.)	2500		3500		3300
Ratio	—				3.54 to 1
AXLE, REAR—Standard	Hypoid, semi-floating		Hypoid, full-floating		Hypoid, semi-floating
Type					
Rating (lbs.)	3500		7200		3500
Ratios	3.07 or 3.54# to 1	3.54 to 1	4.57 or 5.14 to 1	5.14 to 1	3.54 to 1
Optional*	H.D. Hypoid, semi-floating				—
Type					
Rating (lbs.)	3500				—
Ratio	3.54 to 1				—
Optional*	Maximum-traction differential				
BATTERY	12-volt, 53 ampere-hour capacity (70 ampere-hour optional*)				
BRAKES, SERVICE—Hydraulic	Size, Front (in.)		11 x 2		11 x 2
	Size, Rear (in.)		11 x 2		11 x 2
Vacuum Power	Optional*				
BRAKES, HAND	Mechanical—rear wheel		Drum and band		Mechanical—rear wheel
BODY	Deluxe Suburban* (Custom optional*)		—		Dlx. Suburban* (Cust. opt.)*
	7½ ft. Deluxe Panel (Custom optional*)		10½ ft. Deluxe Panel (Custom optional*)		—
CLUTCH, MECHANICAL	Dia. (in.)	10½ (11 opt.)*	10 (11 opt.)*	10½ (11 opt.)*	10 (11 opt.)*
COOLING SYSTEM	Rad. Core Type	Tube and serpentine fin			
	Frontal Area (sq. in.)	439	314	439	314
	Pressure Cap (lbs.)	13			
	Fan Blade, No.	4			
HEAVY-DUTY COOLING	Optional*				
CRANKCASE VENTILATION, POSITIVE TYPE	Standard				
DIRECTIONAL SIGNALS	Standard				
ENGINE	Model	305E V-6	230 In-line-6	305E V-6	230 In-line-6
		Specifications for 305E V-6		Specifications for 230 In-line-6	
	Max. Gross Brake H.P. @ r.p.m.	165 @ 3800		140 @ 4400	165 @ 3800
	Max. Net Brake H.P. @ r.p.m.	142 @ 3800		120 @ 3800	142 @ 3800
	Max. Gross Torque (lbs. ft.) @ r.p.m.	280 @ 1600		220 @ 1600	280 @ 1600
	Max. Net Torque (lbs. ft.) @ r.p.m.	260 @ 1600		205 @ 1600	260 @ 1600
	Bore and Stroke (in.)	4.25 x 3.58		3.875 x 3.25	
	Displacement (cu. in.)	304.7			
	Compression Ratio	7.75 to 1		8.5 to 1	
	2-piece Exhaust Valves and Rotators	Optional*	—	Optional*	—
	Heavy-duty Valves and Rotators	Optional*	—	Optional*	—
FRAME	Side Rail Section (in.)	6½ x 2½ x ½		8½ x 2½ x ¾	
FUEL TANK	Capacity (gals.)	20			
FUEL FILTER	Type	Sintered bronze replaceable element at carburetor			
GENERATOR	12-volt, 37 ampere capacity "Delcotron" a.c. generator (42, 55 or 62 ampere capacity optional*)				
GOVERNOR—Optional*	Velocity type				
HEATER AND DEFROSTER—Optional*	Air-flow or Heavy-duty Air-flow type				
OIL FILTER—Standard	—	1-qt., full-flow	—	1-qt., full-flow	—
Optional*	1-qt., full-flow	—	1-qt., full-flow	—	1-qt., full-flow
SEAT, TWO PASSENGER (Suburban body)	Optional*				
SEAT, PASSENGER (Panel body)	Optional*				
SHOCK ABSORBERS	Front	Standard		Standard (H.D. optional*)	
Direct Double Acting	Rear	Standard		Optional*	
				Standard (H.D. optional*)	
STEERING GEAR	Ratio	24 to 1			
Recirculating Ball Type	Wheel Dia. (in.)	17			
STEERING, Hydraulic Power	Optional*				
SPRINGS, FRONT	Type	Coil		Coil (Heavy-duty optional*)	
	Size (in.)	—			
	Rated at Ground (lbs.)	—			
SPRINGS, REAR—Standard	Type	Progressive type leaf		Leaf	
	Size (in.)	52 x 2¼, 8-leaf		52 x 2½, 8-leaf	
	Rated at Ground (lbs.)	1250		2400	
Optional*	Type	Leaf		Progressive type leaf	
	Size (in.)	52 x 2¼, 9-leaf		52 x 2½, 8-leaf	
	Rated at Ground (lbs.)	1750		3100§	
TIRES (Tubeless)	Standard	7.10-15, 4 p.r., SR†		8-17.5, 6 p.r., F., 8 p.r. SR	
Tube Type Tires Available	* Maximum	7-17.5, 6 p.r., SR†		8-19.5, 10 p.r., SR	
TRANSMISSION—Standard	3-speed synchromesh		4-speed synchromesh		3-speed synchromesh
Optional*	Heavy-duty 3-speed synchromesh		—		H.D. 3-speed synchromesh
Optional*	4-speed synchromesh		—		4-speed synchromesh
Optional*	POW-R-FLO (automatic)		—		—
TRANSFER CASE	—				2-speed
WHEELS	Stamped steel ventilated disc (spare wheel and carrier)				
WHEELBASES	(in.)	115		133	

*Refer to Load Capacity Chart in Owners and Drivers Manual for minimum equipment requirements and recommended minimum tire size.

†Optional gear ratio on standard rear axle available at extra cost. §1050 lbs. auxiliary rear springs available (at extra cost) with this spring.

*Lift and tailgate standard, panel rear doors available. 6-pass. seating standard, 8-pass. seating with sliding rear side windows optional at extra cost.

†Single rear tires . . . Spare tire standard . . . 6.70-15, 4 p.r., SR standard with 11001 Panel. *Optional at extra cost.

GMC Truck & Coach Division reserves the right to make changes at any time without notice in prices, colors, materials, equipment, specifications and models and also to discontinue models. Data shown above is basic information for the prospective buyer as effective at time of issuance of this pamphlet. Dealer will provide complete up-to-date information on options, specifications, etc., not shown here.

GMC TRUCK & COACH DIVISION, GENERAL MOTORS CORPORATION . . . PONTIAC, MICHIGAN

LITHO IN U.S.A.—ADV. 532—6-63—125M