

BMW 2006 3 Series
Coupe



The Ultimate
Driving Machine®

325Ci
330Ci



The performance leader
wears a bold face.



The 3 Series Coupe for 2006:
proving Paradise has two doors.



A thrilling land sport:
driving the 3 Series Coupe.





Behind the wheel,
ahead of the times.

Equipment | Interior – Standard



The close shift pattern of the **six-speed manual transmission**, standard in the 330Ci, delivers a precise, athletic feel for a more dynamic driving experience. (330Ci only) (5-speed manual available in the 325Ci)



A **three-spoke leather-wrapped multi-function sport steering wheel** lets you keep both hands on the wheel while adjusting audio settings, cruise control and the accessory phone.



BMW anti-theft AM/FM stereo/CD/MP3 audio system produces full, rich sound through 10 speakers. Includes Radio Data System (RDS), Auto-Store; pre-wired for a BMW six-disc CD player/changer¹ and compatible with auxiliary audio input adapter¹ for audio connection of portable music players, standard. (325Ci; Harman Kardon stereo system standard in 330Ci)

¹ Available as an accessory.



The **instrument panel** presents all important information at a glance through analog gauges and LCD readouts. When parking lights or headlights are on, the gauges are lit in an easy-to-read red.

Interior – Standard or No-cost | Equipment

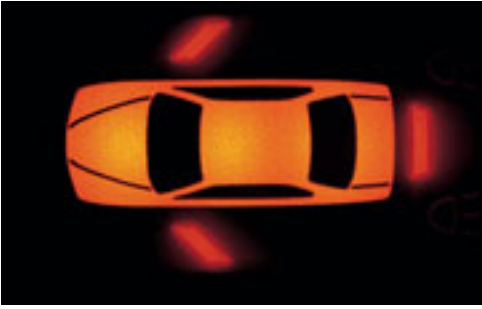

Check Control monitors important data, such as brake fluid and oil levels, whether lights are functioning properly, and all vehicle systems. Any problems are clearly indicated on the pictogram or beside it, in order of importance.



An **on-board computer** offers valuable travel information, with readouts on expected travel range on remaining fuel, average mpg and average speed. An external thermometer sounds a warning when the temperature falls below 38°F – indicating that the road may ice up.



1/3 and 2/3 split-fold rear seats allow you to load long objects in the trunk by folding down one or both rear seats, as needed.



Eight-way adjustable seats (including 2-way headrests) firmly support the driver and front passenger over long distances. Front seat bolsters help eliminate “submarining” during sudden stops. (325Ci; 330Ci has eight-way power seats)



Eight-way Power front seats include a **driver's seat and mirror memory system**, which lets up to three drivers set their preferred seat and exterior mirror positions. (Plus, the passenger's-side mirror tilts down when vehicle is shifted into reverse gear.) (330Ci; optional and included in 325Ci Premium Package.) Lumbar support [shown] is included in 330Ci and 325Ci Premium Package)



A **front center armrest** makes travel more comfortable. It also includes an integrated storage compartment, which can be accessed when the armrest is down.



Titanium-finish ringed gauges distinguish the interior of the 330Ci from the 325Ci, while adding a high-tech look. (330Ci only)



Myrtle Wood trim curves around doors, dashboard and center console, adding a luxurious touch to the interior.



Aluminum Brushed Columns interior trim is a handsome, no-cost option.

330Ci Performance Package

The 330Ci Performance Package is a product of BMW Individual – the division responsible for creating unique, limited-edition BMWs. It includes a more muscular engine that boasts 235 hp at 5900 rpm, and 222 lb-ft of torque at just 3500 rpm. To make the most of this extra power, the redline has been increased from 6500 to 6800 rpm. Additional, distinctive exterior and interior features further differentiate the Performance Package from all other 3 Series models.



Front air dam that is unique to the Performance Package displays a face that's all business.



Rear apron: The rear apron, with its integrated diffuser, upgrades the car's aerodynamics.



Thanks to modifications by driving enthusiast engineers at BMW, the **330Ci Performance Package** brings track-inspired excitement to your daily drive. The suspension is even lower, stiffer and firmer than in the standard 330Ci Coupe. For greater adhesion, wheel camber is set at -0.5° , which results in a larger tire contact patch when cornering quickly. The bold look of the 18" M Double Spoke (Styling 135M) alloy wheels and performance tires – 225/40 front, 255/35 rear – emphasize the feeling that these wheels can deliver higher cornering speeds with confidence.

330Ci Performance Package



M three-spoke leather-wrapped multi-function sport steering wheel has fingertip cruise, audio and accessory phone¹ controls.

¹If so equipped.



Sport seats: The sport seats provide optimum lateral support while the cloth/Alcantara upholstery adds a dynamic touch. Montana leather is also available for those who prefer the look and feel of all-leather upholstery.

















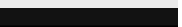















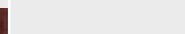

Aluminum Black Cube interior trim: The black aluminum cube interior trim makes for a more sporty, high-tech interior. Silver Cube interior trim is also available as a no-cost option.

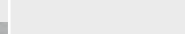
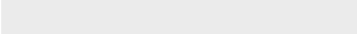

Clean lines, throaty sound. The exhaust has been specially tuned to emit a distinctly more assertive sound than the standard 330Ci Coupe. This lusty growl is conducted through two handsome matte stainless steel, 35mm exhaust tips, which are set into a sleek, new rear apron.

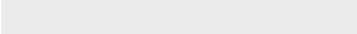
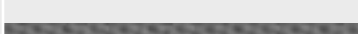
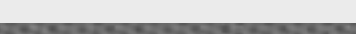
Combinations

Materials	Leatherette ¹		Montana Leather ²				Cloth/Alcantara ³
	Sand	Black	Sand	Natural Brown ⁴	Gray	Black	Anthracite Black
Interior/Upholstery Colors							
Exterior Colors							
300 Alpine White ⁵		●	●	●	●	●	●
438 Electric Red ^{5,7}		●	●	●	●	●	NA
405 Imola Red ⁶		NA	NA	●	●	●	●
668 Jet Black ⁵		●	●	●	●	●	●
354 Titanium Silver Metallic ⁸		●	●	●	●	●	●
A08 Silver Gray Metallic ⁸		●	●	●	●	●	●
A22 Sparkling Graphite Metallic ⁸		●	●	●	●	●	●
A18 Quartz Blue Metallic ^{7,8}		●	●	●	●	●	NA
A07 Mystic Blue Metallic ⁸		●	●	●	●	●	●
A35 Monaco Blue Metallic ⁸		●	●	●	●	●	●
A23 Sonora Metallic ^{7,8}		●	●	●	●	●	NA
A43 Deep Green Metallic ^{7,8}		●	●	●	●	●	NA
475 Black Sapphire Metallic ⁸		●	●	●	●	●	●
Interior Trims							
Myrtle Wood ⁹							
Aluminum Brushed Columns ¹⁰							
Exclusive 330Ci Performance Package Trims							
Black Cube ¹¹							
Silver Cube ¹²							

1 Leatherette upholstery: Standard in 325Ci and 330Ci. Not available with 330Ci Performance Package.

2 Montana Leather upholstery: Optional in 325Ci and 330Ci. Included in 330Ci Premium Package.

3 Cloth/Alcantara upholstery: Exclusive to and standard with 330Ci Performance Package.

4 Natural Brown Montana Leather upholstery: Includes Black Leather details.

5 Non-metallic exterior paint: Standard on 325Ci and 330Ci.

6 Imola Red Non-metallic exterior paint: Exclusive to 330Ci Performance Package.

7 Electric Red Non-metallic, Quartz Blue Metallic, Sonora Metallic and Deep Green Metallic exterior paint: Not available with 330Ci Performance Package.

8 Metallic exterior paint: Optional on 325Ci and 330Ci.

9 Myrtle Wood interior trim: Standard in 325Ci and 330Ci. Not available with 330Ci Performance Package.

10 Aluminum Brushed Columns interior trim: No-cost option. Not available with 330Ci Performance Package.

11 Black Cube interior trim: Exclusive to and standard with 330Ci Performance Package.

12 Silver Cube interior trim: Exclusive to and no-cost option with 330Ci Performance Package.

Here are your exterior and interior color choices. Review the color swatches to compare various combinations indicated in the chart. Since exterior paint samples and colors printed on paper can never perfectly match paint finishes and upholstery, we suggest you visit your local authorized BMW center to view the actual colors.

Standard Equipment | Optional Equipment

	325Ci	330Ci
Performance and efficiency		
2.5-liter dual overhead cam (DOHC), 24-valve inline 184-horsepower 6-cylinder engine	●	
3.0-liter dual overhead cam (DOHC), 24-valve inline 225-horsepower 6-cylinder engine		●
3.0-liter dual overhead cam (DOHC), 24-valve inline 235-horsepower 6-cylinder engine		■
Electronic throttle control	●	●
Double-VANOS "stepplessly" variable valve timing	●	●
Dual resonance intake system	●	●
5-speed manual transmission	●	
6-speed manual transmission		●
5-speed STEPTRONIC automatic transmission with Adaptive Transmission Control	○	○
Handling, ride and braking		
Dynamic Stability Control (DSC), with All Season Traction	●	●
Strut-type front suspension with forged-aluminum lower arms	●	●
Multi-link rear suspension with cast-aluminum upper transverse arms	●	●
Front and rear anti-roll (stabilizer) bars	●	●
Twin-tube gas-pressure shock absorbers	●	●
Engine-speed-sensitive, variable-assist power steering	●	●
4-wheel ventilated anti-lock disc brakes with Dynamic Brake Control	●	●
Sport suspension calibration	●	●/■ ¹
Exterior		
16x7.0 Five Spoke (Styling 169) alloy wheels, 205/55R-16 all-season tires	●	
17 x 8.0 Five Spoke (Styling 119) alloy wheels, 225/45R-17 performance tires ²	□	
17 x 7.0 Double Spoke (Styling 98) alloy wheels, 205/50R-17 all-season tires		●
17 x 7.0 Double Spoke (Styling 98) alloy wheels, 205/50R-17 run-flat all-season tires ³		○
M Double Spoke (Styling 68M) alloy wheels, 17 x 7.5 front, 17 x 8.5 rear; 225/45R-17 front, 245/40R-17 rear performance tires ²		□
Double Spoke Composite (Styling 71) alloy wheels, 18 x 8.0 front, 18 x 8.5 rear; 225/40R-18 front, 255/35R-18 rear performance tires ^{2,4,5}		○
M Double Spoke (Styling 135M) alloy wheels, 18x8.0 front, 18 x 8.5 rear; 225/40R-18 front, 255/35R-18 rear performance tires ^{2,6}		■
Flat Tire Warning Indicator	●	●
Chrome ⁷ and body-color detail trim	●	●
Xenon Adaptive Headlights with auto-leveling	○	○
Halogen free-form foglights	●	●
Retractable, high-intensity headlight washers	★	★
White turn-signal indicators	●	●
High-Gloss shadowline exterior trim		■
Matte stainless steel, 35mm dual exhaust pipes		■
Aerodynamic package		■
Heated dual-power mirrors and heated windshield washer jets	●	●
Metallic paint	○	○

- = Standard
- = Optional
- ◇ = Included in optional Premium Package
- = Included in optional Sport Package
- = Included in optional 330Ci Performance Package
- ★ = Included in optional Cold Weather Package

- 1 Sport suspension is tuned more aggressively on 330Ci with Performance Package.
- 2 Due to low-profile tires, please note: wheels, tires and suspension parts are more susceptible to road hazard and consequential damages. Performance tires not recommended for driving in snow and ice.
- 3 Not available with Sport or Performance Package. Space-saver spare tire and wheel replaces full-use spare and wheel for Styling 98 wheels with run-flat tires.
- 4 Sport Package required. Space-saver spare tire and wheel replaces full-use spare and wheel for Styling 71 wheels.
- 5 Not available with 330Ci Performance Package.
- 6 Space-saver spare tire and wheel replaces full-use spare and wheel for Styling 135M wheels with performance tires.

Optional Equipment | Standard Equipment

Interior seating	325Ci	330Ci
8-way adjustable front seats (includes 2-way headrests)	●	
8-way power front seats with 2-way manual headrests; 3-driver memory for exterior mirror and seat positions; automatic tilt-down of passenger's side-view mirror when vehicle is shifted into reverse gear	○/◇	●
12-way adjustable front sport seats (includes 2-way headrests and thigh support)	□	
8-way power front sport seats with 2-way manual headrests and thigh support; 3-driver memory for exterior mirror and seat positions; automatic tilt-down of passenger's side-view mirror when vehicle is shifted into reverse gear	○ ⁷ /◇ ⁷	□/■
4-way power lumbar support for front seats	◇	◇
Leatherette upholstery	●	●
Montana leather upholstery	○	○/◇
3-stage heated front seats	○/★	○/★
3-spoke leather-wrapped multi-function sport steering wheel with fingertip cruise, audio and accessory mobile phone ⁸ controls	●	●
M 3-spoke leather-wrapped multi-function sport steering wheel with fingertip cruise, audio and accessory mobile phone ⁸ controls		■
Front-seat center armrest with storage compartment	●	●
Front seatback storage nets	●	●
Split fold-down rear seats with center armrest	●	●
Ski bag	★	★
Comfort and convenience		
Vehicle & Key Memory	●	●
Remote entry, including 2-step unlocking and remote trunk release	●	●
Automatic climate control with micro-filter and air recirculation	●	●
2-way power glass moonroof with "one-touch" operation, sliding interior sunshade, and wind deflector	●	●
Tilt/telescopic steering wheel column	●	●
Park Distance Control (PDC), rear	○	○
Automatic-dimming inside rear-view mirror	◇	◇
Power front windows with "one-touch" up/down operation; power rear windows with "one-touch" open	●	●
Cruise control	●	●
Front/rear map-reading, footwell and visor-mirror lights	●	●
Locking glovebox with rechargeable take-out flashlight	●	●
Electric interior trunk release	●	●
Fully finished trunk with reversible mat and drop-down tool kit	●	●
Rain-sensing windshield wipers and Automatic headlight control	●	●
BMW Ambiance Lighting	●	●
Pre-wiring for mobile phone, alarm, garage-door opener, 6-disc CD changer and auxiliary audio input	●	●
Power rear-window sunshade	○	○

7 Sport Package required.
8 If so equipped.

All illustrations and specifications contained in this brochure are based on the latest product information available at the time of printing. BMW reserves the right to make changes at any time, without notice, in colors, materials, equipment, specifications and models. BMW may, subject to legal requirements, determine the Model Year designation of its vehicles. The Model Year designation on any particular model may be longer or shorter than 12 months. Some vehicles pictured may contain non-U.S. equipment. Some models may be shown with optional equipment. While BMW NA makes all reasonable efforts to provide accurate information in this brochure, there is no guarantee or warranty of accuracy. Furthermore, we do not assume any liability for the accuracy or completeness of information presented. This brochure shall not be used or relied upon as a substitute for information that is available from your BMW center. Further information can be obtained from your authorized BMW center or bmwusa.com.

Standard Equipment | Optional Equipment

	325Ci	330Ci
Audio system		
Anti-theft AM/FM stereo/CD/MP3 audio system with 10 speakers, Radio Data System (RDS), Auto-Store, and 3-channel FM diversity antenna system; pre-wired for 6-disc CD changer ⁹ and compatible with auxiliary audio input adaptor ⁹ for audio connection of portable music players	●	
Harman Kardon AM/FM stereo/CD/MP3 audio system with 12 upgraded speakers (including 2 subwoofers), upgraded amplification, and vehicle-speed-sensitive equalization; pre-wired for 6-disc CD changer ⁹ and compatible with auxiliary audio input adaptor ⁹ for audio connection of portable music players	○	●
iPod Seamless Integrated System ¹⁰	△	△
SIRIUS Satellite Radio	△	△
Instrumentation and controls		
Service Interval Indicator with miles-to-service readout	●	●
Check Control vehicle monitor system with pictogram display	●	●
4-function on-board computer	●	●
On-board navigation system with 16:9 screen and high-function on-board computer	○	○
Titanium-finish instrument rings		●
Tachometer with 300 rpm-higher redline and red needles		■
Short, sport gearshift lever		■
Safety and security		
Anti-lock braking system (ABS)	●	●
Adaptive Brake Lights	●	●
Head Protection System (HPS)	●	●
Driver's and passenger's front airbag supplemental restraint system (SRS) with "smart" dual-threshold, dual-stage deployment and sensor to help prevent unnecessary passenger's airbag deployment	●	●
Door-mounted side-impact airbags	●	●
Rear side-impact airbags	○	○
Interlocking door anchoring system to help protect against door intrusion in side impacts	●	●
Battery Safety Terminal	●	●
Central locking system with center console switch (leaves gas filler door unlocked), double-lock feature and 2-step unlocking	●	●
Coded Driveaway Protection	●	●
Height-adjustable front safety belts with automatic tensioners and force limiters	●	●
Automatic-locking retractors (ALR) on all passenger safety belts for installation of child restraint seat	●	●
LATCH attachments on child-restraint safety installation	●	●
Crash sensor that automatically turns on hazard lights and interior lights, and unlocks doors	●	●
Daytime running lights (via Vehicle Memory system – programmed at BMW center)	●	●
BMW Assist and Bluetooth [®] wireless communication for hands-free mobile phone ¹¹	○◇	○◇
BMW Maintenance Program		
BMW Full Maintenance ¹²	●	●
Premium Packages		
8-way power front seats with 2-way manual headrests; 3-driver memory for exterior mirror and seat positions; automatic tilt-down of passenger's side-view mirror when vehicle is shifted into reverse gear	◇	●
4-way power lumbar support for front seats	◇	◇
Montana leather upholstery		◇
Automatic-dimming inside rear-view mirror	◇	◇
BMW Assist and Bluetooth [®] wireless communication for hands-free mobile phone ¹¹	◇	◇

● = Standard

○ = Optional

◇ = Included in optional Premium Package

□ = Included in optional Sport Package

■ = Included in optional 330Ci Performance Package

★ = Included in optional Cold Weather Package

△ = BMW center-installed accessory

⁹ Available as an accessory.

¹⁰ For more information go to ipodyourbmw.com.

¹¹ If so equipped.

¹² Full Maintenance Program covers all factory-recommended maintenance, as determined by the Service Interval Indicator for 4 years or 50,000 miles, whichever comes first. Full Maintenance Program includes items that need replacement due to normal wear and tear, provided wear and tear exceeds BMW specifications. This includes items such as brake pads, brake rotors and wiper blades that are not covered by the original New Vehicle Limited Warranty. Any adjustments required due to normal operating conditions are also included. For exclusions and limitations, refer to the Service and Warranty Information booklet that came with your new BMW, or see your authorized BMW center for details.

Optional Equipment | Standard Equipment

	325Ci	330Ci
Sport Packages¹³		
17 x 8.0 Five Spoke (Styling 119) alloy wheels, 225/45R-17 performance tires ¹⁴	□	
12-way adjustable front sport seats (includes 2-way headrests and thigh support)	□	
8-way power front sport seats with 2-way manual headrests and thigh support; 3-driver memory for exterior mirror and seat positions; automatic tilt-down of passenger's side-view mirror when vehicle is shifted into reverse gear	○ ¹⁵ /◇ ¹⁵	□
M Double Spoke (Styling 68M) alloy wheels, 17 x 7.5 front, 17 x 8.5 rear; 225/45R-17 front, 245/40R-17 rear performance tires ¹⁴		□
Double Spoke Composite (Styling 71) alloy wheels, 18 x 8.0 front, 18 x 8.5 rear; 225/40R-18 front, 255/35R-18 rear performance tires ^{13, 14, 16}		○
Cold Weather Package		
3-stage heated front seats	★	★
Retractable, high-intensity headlight washers	★	★
Ski bag	★	★
Performance Package		
235-horsepower engine		■
More aggressively tuned sport suspension		■
8-way power front sport seats with 2-way manual headrests and thigh support; 3-driver memory for exterior mirror and seat positions; automatic tilt-down of passenger's side-view mirror when vehicle is shifted into reverse gear		■
Anthracite interior headliner		■
Alcantara/cloth upholstery		■
Aluminum "Black Cube" interior trim		■
Aluminum "Silver Cube" interior trim ¹⁷		○
M 3-spoke leather-wrapped multi-function sport steering wheel with fingertip cruise, audio and accessory mobile phone ¹⁸ controls		■
M Double Spoke (Styling 135M) alloy wheels, 18x8.0 front, 18 x 8.5 rear; 225/40R-18 front, 255/35R-18 rear performance tires ^{14, 19}		■
High-Gloss shadowline exterior trim		■
Matte stainless steel, 35mm dual exhaust pipes		■
Aerodynamic package		■
Tachometer with 300 rpm-higher redline and red needles		■
Short, sport gearshift lever		■
Accessories²⁰		
CD changer (6-disc)	△	△
Alarm system	△	△
BMW Universal Transceiver (integrated remote garage-door opener)	△	△
Floor mats	△	△
Auxiliary audio input adaptor	△	△
iPod Seamless Integrated System ¹⁰	△	△
SIRIUS Satellite Radio	△	△

13 Not available with 330Ci Performance Package.

14 Due to low-profile tires, please note: wheels, tires and suspension parts are more susceptible to road hazard and consequential damages. Performance tires not recommended for driving in snow and ice.

15 Sport Package required.

16 Sport Package required. Space-saver spare tire and wheel replaces full-use spare and wheel for Styling 71 wheels.

17 No-cost option with 330Ci Performance Package.

18 If so equipped.

19 Space-saver spare tire and wheel replaces full-use spare and wheel for Styling 135M wheels with performance tires.

20 For additional information, please visit your-authorized BMW center.

Technical | Data

Weight		325Ci	330Ci
Unladen	lbs	3197 (3285)	3285 (3362)
Weight distribution, front/rear			
Manual transmission	%	50.4/49.6	50.1/49.9
Automatic transmission	%	51.1/48.9	50.6/49.4
Engine			
Liter/type		2.5/inline 6	3.0/inline 6
Bore/stroke	inch	3.31/2.95	3.31/3.53
Nominal output/rpm	hp	184/6000	225/5900
Max torque/rpm	lb-ft	175/3500	214/3500
Compression ratio	:1	10.5	10.2
Fuel grade		Unleaded premium	Unleaded premium
Transmission			
Manual gear ratios			
I/II	:1	4.23/2.52	4.35/2.50
III/IV	:1	1.66/1.22	1.66/1.23
V/VI/R	:1	1.00/—/4.04	1.00/0.85/3.93
Final drive ratio	:1	3.15	2.93
Automatic gear ratios			
I/II	:1	3.45/2.21	3.45/2.21
III/IV	:1	1.59/1.00	1.59/1.00
V/R	:1	0.76/3.17	0.76/3.17
Final drive ratio	:1	3.46	3.38
Performance			
Drag coefficient	C _d	0.32	0.32
Top speed ¹	mph	128	128 [155]
Acceleration 0-60 mph ²	sec	7.1 (8.1)	6.4 (7.0) [5.9]

Figures in () apply to vehicles with automatic transmission.

- 1 Top speed limited electronically.
- 2 BMW AG test results. Actual acceleration results may vary, depending on specification of vehicle; road and environmental conditions: testing procedures and driving style. These results should be used for comparison only and verification should not be attempted on public roads. **BMW urges you to obey all posted speed laws and always wear safety belts.**
- 3 Due to low-profile tires, please note: wheels, tires and suspension parts are more susceptible to road hazard and consequential damages.

For up-to-date fuel consumption information on the 2006 3 Series Coupe, please log on to bmwusa.com

Technical | Data

Tires, wheels and brakes³

Tire dimensions	(standard)		205/55R-16 all-season	205/50R-17 all-season
Wheel dimensions	(standard)		16 x 7.0	17 x 7.0
Tire dimensions	(Sport Package)		225/45R-17 performance	225/45R-17 performance (front)
				245/40R-17 performance (rear)
Wheel dimensions	(Sport Package)		17 x 8.0	17 x 7.5 front/17 x 8.5 rear
Material			Cast alloy	Cast alloy
Brake dimensions	(diameter)			
	front – vented	inch	11.8	12.8
	rear – vented	inch	11.6	12.6

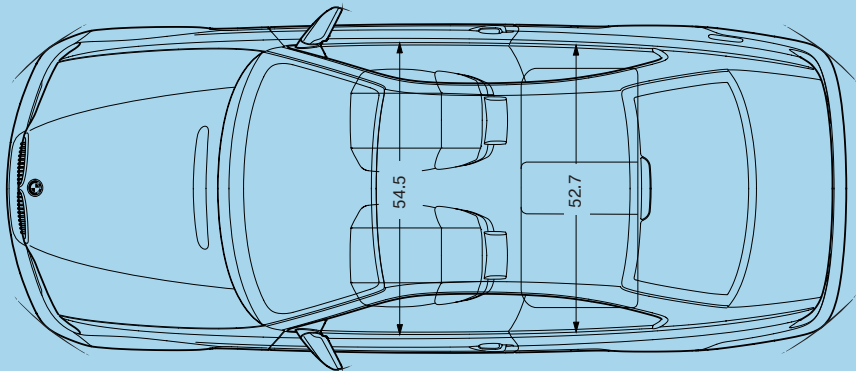
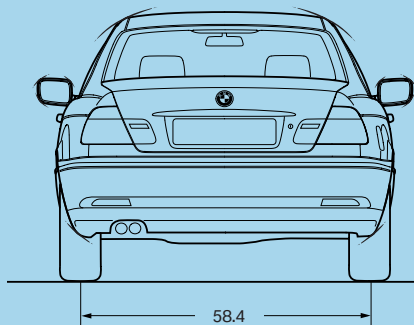
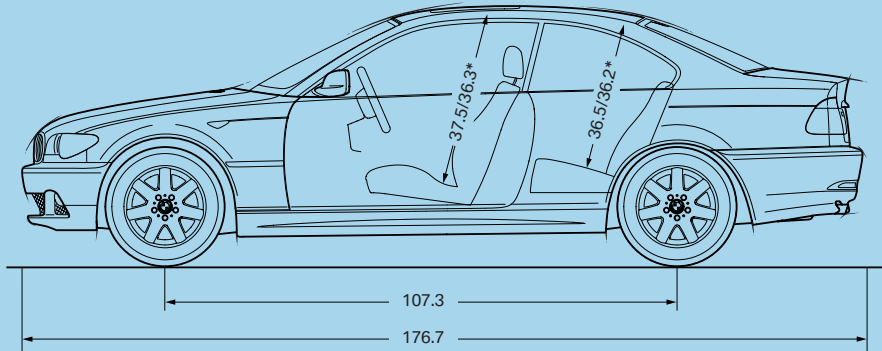
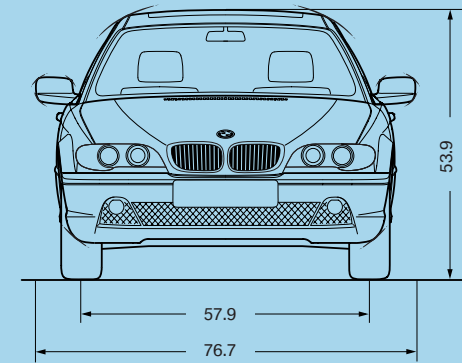

Illustrations above:

* = Dimension with optional moonroof.

All dimensions in inches.

All illustrations and specifications contained in this brochure are based on the latest product information available at the time of printing. BMW reserves the right to make changes at any time, without notice, in colors, materials, equipment, specifications and models. BMW may, subject to legal requirements, determine the Model Year designation of its vehicles. The Model Year designation on any particular model may be longer or shorter than 12 months. Some vehicles pictured may contain non-U.S. equipment. Some models may be shown with optional equipment. While BMW NA makes all reasonable efforts to provide accurate information in this brochure, there is no guarantee or warranty of accuracy. Furthermore, we do not assume any

liability for the accuracy or completeness of information presented. This brochure shall not be used or relied upon as a substitute for information that is available from your BMW center. Further information can be obtained from your authorized BMW center or bmwusa.com.

U.S. Importer: BMW of North America, LLC, Woodcliff Lake, NJ 07677. All illustrations and specifications contained in this brochure are based on the latest product information available at the time of printing. BMW reserves the right to make changes at any time, without notice, in colors, materials, equipment, specifications and models. BMW may, subject to legal requirements, determine the Model Year designation of its vehicles. The Model Year designation on any particular model may be longer or shorter than 12 months. Some vehicles pictured may contain non-U.S. equipment. Some models may be shown with optional equipment. Further information can be obtained from your authorized BMW center or bmwusa.com.

©2005 BMW AG, Munich/Germany. Not to be reproduced wholly or in part without written permission of BMW AG, Munich. The BMW name and logo are registered trademarks.

BMW recommends 