

C A D I L L A C



S T Y L E



1 | 9 | 9 | 1

- 2 • Performance
- 6 • Quality
- 8 • Advanced Anti-Lock Brakes
- 10 • Safety
- 14 • Cadillac Ownership Experience
- 16 • Allanté
- 24 • Fleetwood
- 34 • De Ville
- 42 • Eldorado
- 54 • Seville
- 62 • Brougham
- 70 • Limousines
- 72 • Sound Systems
- 74 • Standard and Available Features

THE ONLY WAY TO TRAVEL IS CADILLAC STYLE.™



Technology: First in the world to incorporate traction control as standard on a roadster, Cadillac incorporates proven innovations that enhance performance, comfort and safety.



Ownership: Backed by an outstanding portfolio of preferred ownership programs, a Cadillac is as comfortable to own as it is to drive.

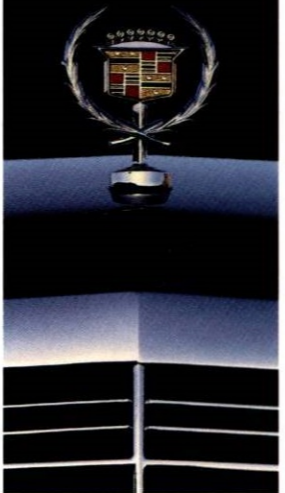

Luxury. Distinction. Sophistication. Performance. Safety. For 1991, each has been enhanced to provide even more substance behind Cadillac Style.



Performance: The world leader in V8 power, Cadillac has created a uniquely American balance of responsiveness and refinement.



PERFORMANCE

■ New for 1991, every Cadillac Fleetwood, De Ville, Eldorado and Seville incorporates an exclusive, electronically integrated powertrain system. It combines a powerful 4.9 liter V8 with an electronically controlled four-speed automatic transmission with Cadillac-exclusive viscous converter clutch for driving responsiveness, smoothness and efficiency.

1 New 4.9 liter V8 with sequential port fuel injection is rated at 200 hp and 275 lbs.-ft. of torque, highest of any front-drive automobile in the world. Standard on Fleetwood, De Ville, Eldorado and Seville.

2 Sophisticated injectors deliver fuel with precise, split-second accuracy for impressive power.

3 Sequential port fuel injection provides more precise fuel metering to each individual cylinder to maximize power, especially when changing driving speed.

4 Low swirl technology in the combustion chamber and large intake valves improve engine breathing, which maximizes the output of each power stroke.

5 Longer stroke increases displacement to 4.9 liters for added torque and horsepower. Higher torque at lower engine speed improves driving response when merging.

6 Electronically controlled four-speed automatic transmission and transverse V8 engine give more precise, responsive and efficient performance. EPA estimates: 26 mpg highway.

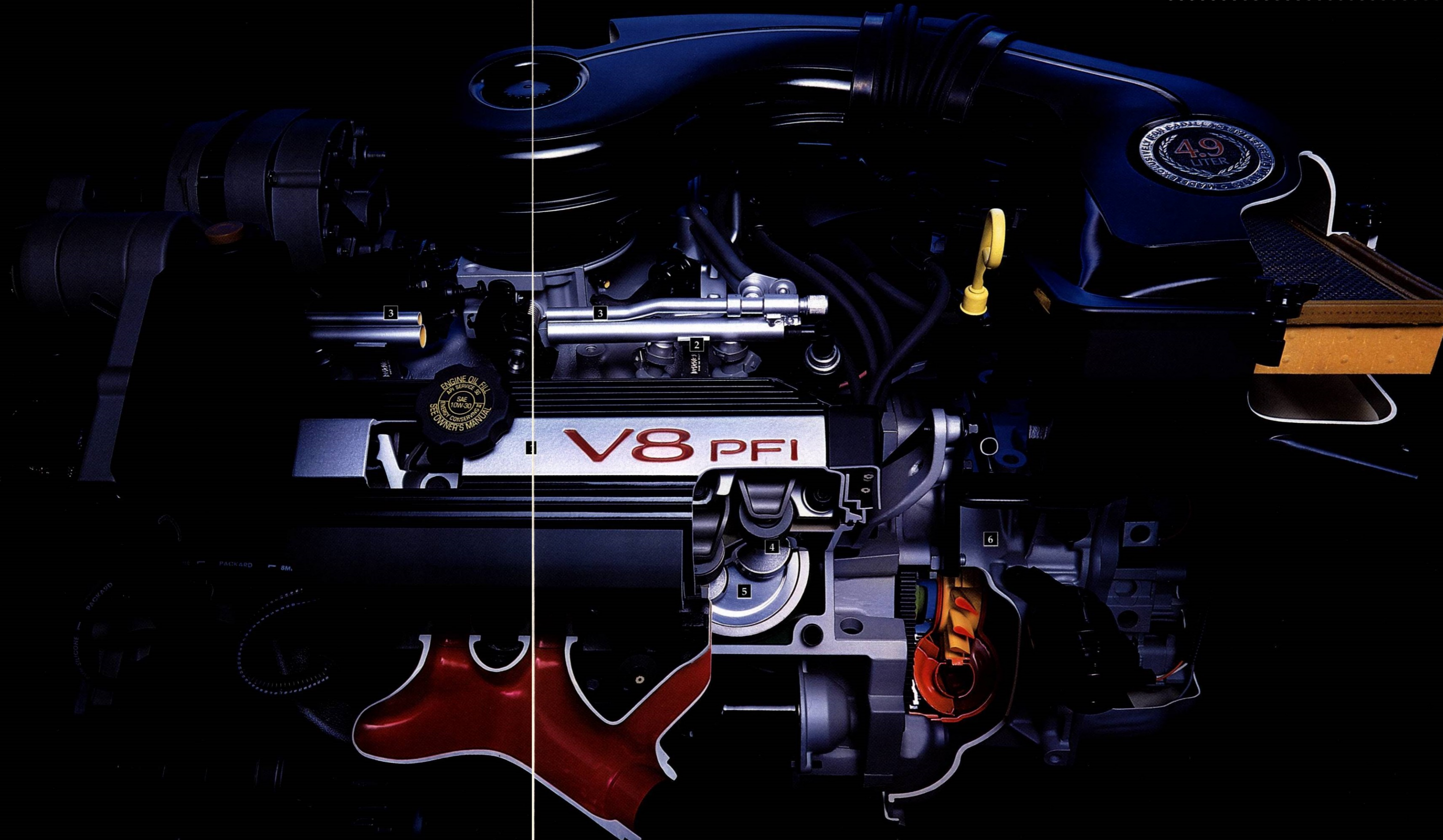

COMFORT MODE

NEW COMPUTER COMMAND RIDE



TOURING MODE

Announcing a new speed-sensing suspension called Computer Command Ride (CCR). It cushions city driving, yet affords impressive control and road feel on the highway. CCR also helps keep the car level when accelerating, braking and cornering. All automatically.

CCR is standard or available on front-drive Cadillacs. Speed Dependent Damping is standard on Allanté.

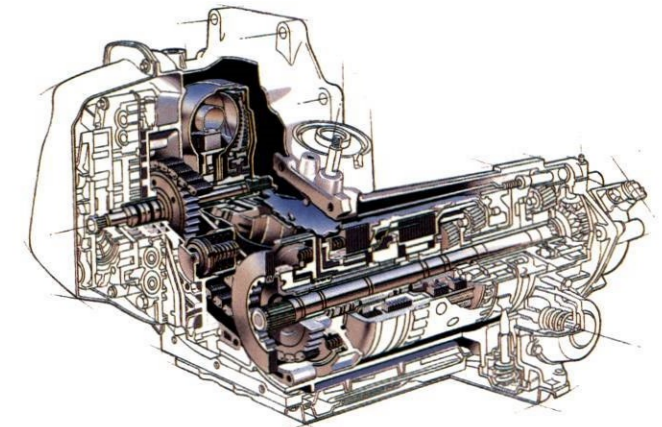

Allanté is the only front-wheel-drive automobile sold in the U.S. to employ Traction Control as standard equipment. See page 21 for details.

Cadillac adds new electronic controls to the four-speed automatic transmission to deliver precise, barely detectable shifts, and smooth operation at highway speeds. Cadillac's exclusive viscous converter clutch provides excellent fuel economy while maintaining driveline smoothness.

Because the entire powertrain is controlled by one computer, it can work in harmony with the cruise control by minimizing shift busyness between third and fourth gears on long mountain upgrades.

Refer to individual car line sections for feature availability.

**Putting quality on the road,
Cadillac Style.**

Everywhere you look in a Cadillac, you see the reflection of your own high standards. Quality in Cadillacs is verified by round-the-clock durability testing, independent research analyses and the unsurpassed achievement of 42 consecutive years of luxury leadership.

It is a confident quality backed by a 4-year/50,000-mile Gold Key Bumper to Bumper warranty that covers every part, no deductible.*



From sunbaked 120°F desert runs to windchilled -35°F winter odysseys, the V8 engines exclusively in Cadillacs have been tested in some of the toughest "real-world" conditions.

*Covers every component (except tires, which are covered by their manufacturer, adjustments, normal maintenance items and battery, which is covered by its own 4-year/50,000-mile prorated warranty).

Refer to individual car line sections for feature availability.

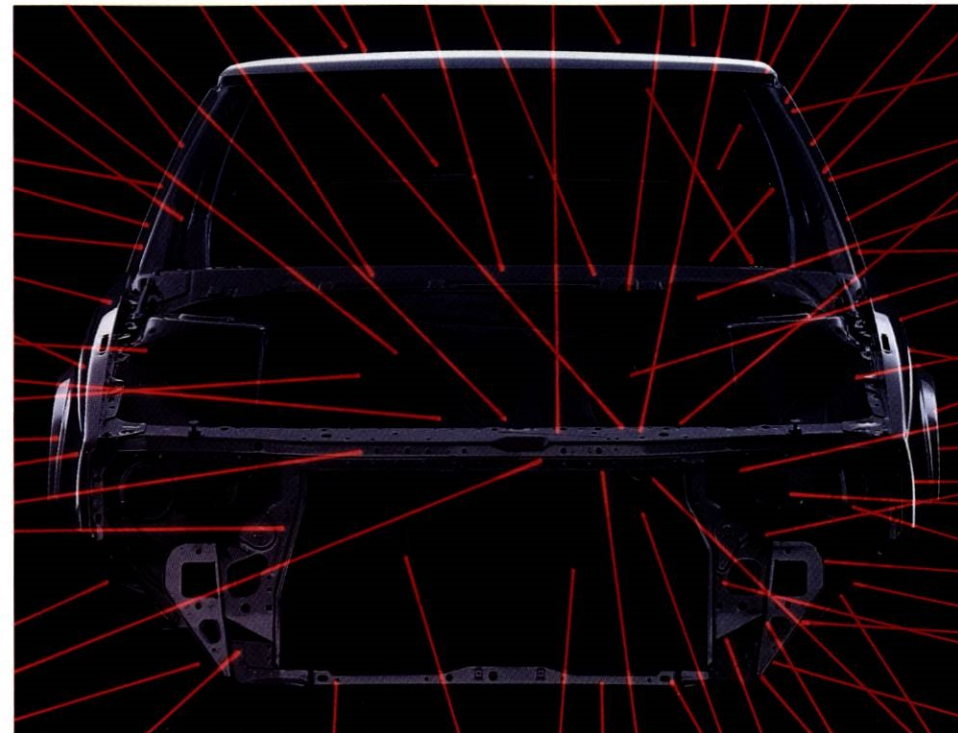

Perceptron® laser beams probe into each Cadillac at more than 600 points, verifying that fits between panels meet strict objectives.

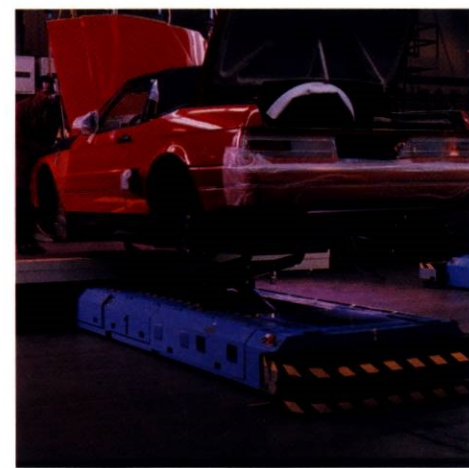

Automatic Guided Vehicles (AGVs) move Allanté bodies from station to station along an electronic pathway. Skilled assemblers can raise or lower each AGV to an optimum work height for the assembly operation at hand.

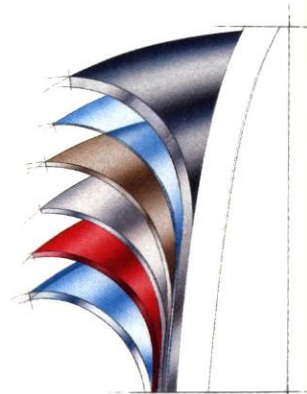

Six coats of protectants, sealers, primers and paint cover the two-sided galvanized steel body panels used for front-drive Cadillacs. (Seven coats on Allanté.) The zinc coating actually eliminates surface rust on the outside due to scratches, dings and chips. Cadillac's corrosion coverage lasts for 6 years/100,000 miles.

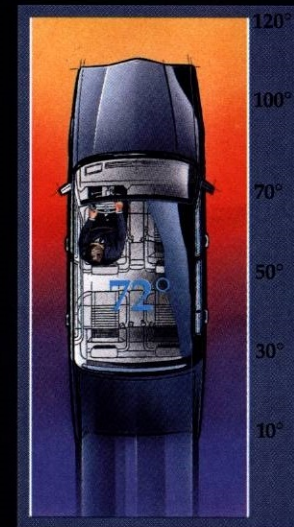

A sensor measures the intensity and angle of sunlight and signals the body computer module to adjust the electronic climate control accordingly. Bringing further distinction to a system already renowned for its superior reliability.



New EZ-KOOL™ solar control glass keeps the interior cooler, enhances air-conditioning performance and lengthens cloth, leather and interior trim life.



**Orthopedically
designed.**

The innovative quality of the Fleetwood Sixty Special's 22-way seating is so unique that it is patented.

Bio-engineered with a leading research university, the split-frame seat design adjusts to accommodate your individual physique.

The result: a new standard in occupant back comfort.

An up-and-down adjustment moves front seat cushions independently from the seatbacks for maximum comfort and lower back support.

Heated front seatbacks and cushions offer extra cold-weather comfort.

Memory driver seat "remembers" two seating positions and includes an "exit" feature.

**A total commitment to V8 power
and anti-lock braking.**

Cadillac offers you the largest commitment to anti-lock braking of any automotive nameplate in the world. In fact, every 1991 Cadillac assures you the sophisticated control of anti-lock brakes standard.

In addition, Cadillac is the only American nameplate to complement the advantages of anti-lock braking with the inherent benefits of a powerful V8 standard on every automobile we sell.

Cadillac's exclusive commitment to V8 power has created the most powerful front-wheel-drive luxury cars in the world. They afford you levels of power and refinement that let you pass on two-lane roads and merge onto the highway with confidence.

Accident Avoidance Features

*Audible brake lining wear indicators,
disc brakes*

Backup lamps

*Brake system with dual master
cylinder and warning light*

Center high-mounted stop lamp

Four-way hazard warning flashers

Another
Cadillac
exclusive:
All V8.
All ABS.



An investment designed with your security in mind.

Every Cadillac affords you some of the most advanced automotive security systems in the world.

Foremost of these features is PASS Key,[®] a sophisticated automotive theft-deterrent system. Standard on all front-drive Cadillacs, PASS Key[®] employs a resistance-coded pellet discreetly placed in your ignition key. If a key that doesn't bear an identical pellet is turned in the ignition, or if ignition wiring is disturbed, the system will detect the situation. The fuel system and starter are temporarily shut down by the PASS Key[®] system to help protect your Cadillac from theft.

PASS Key[®] may also qualify you for comprehensive insurance discounts.

Occupant Protection Features

Automatic safety belt system for driver and right front passenger (Brougham) OR Supplemental Inflatable Restraint, driver only, with manual lap/shoulder safety belts for the driver and right front passenger (Allanté, Fleetwood, De Ville, Eldorado and Seville) both including visual and audible warning system.

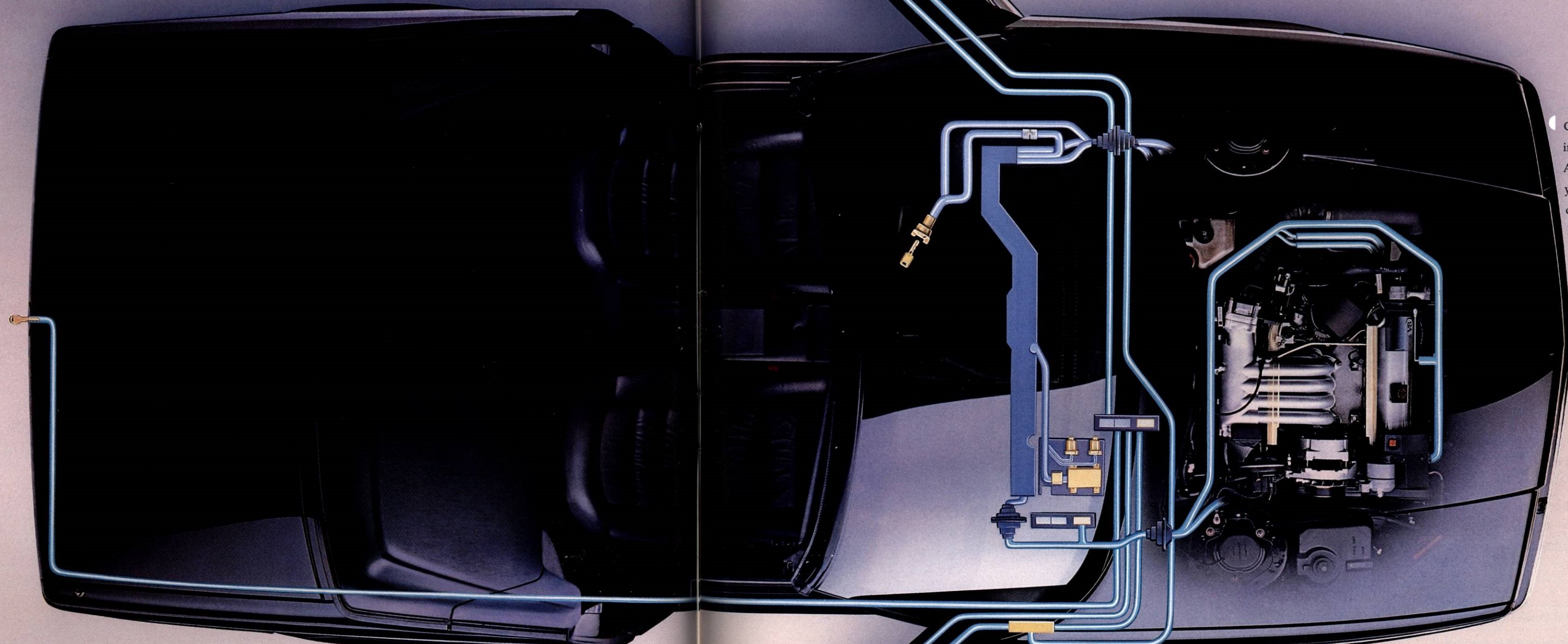

Central door unlocking on the Cadillac Allanté (left) enables you to unlock both doors by turning the key twice in any lock, even the luggage compartment lock.

New child security rear door locks and window controls plus lap/shoulder safety belts for all front and rear window seat passengers help protect your family.



Touch the outside button of either front door and the illuminated entry system automatically lights the interior of your Cadillac for added security.

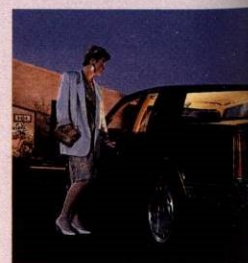

A remote keyless entry system locks and unlocks doors and unlocks deck lid from a 15-foot radius. The system also activates interior lights and the theft-deterrent system.

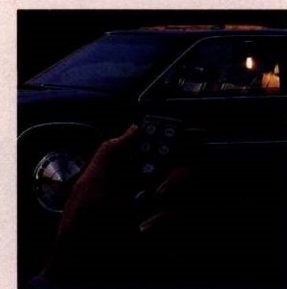

Twilight sentinel turns your lights on and off automatically as needed. And as you leave your Cadillac, it safely lights your way for a preset period of time. Refer to individual car line sections for feature availability.

**Building a safer automobile,
Cadillac Style.**

At Cadillac, we believe it's our duty to help protect the people who drive and ride in our cars. As a result, we conduct extensive testing and offer features which meet or exceed governmental regulations.

Every Cadillac benefits from knowledge learned at General Motors' automotive safety research center, the world's largest. There, Cadillacs undergo impact tests so exhaustive, they exceed governmental mandates. Brakes, steering and other systems are subjected to rigid trials.

The results: every Cadillac is equipped with some of the most sophisticated safety technology on the road today.

Occupant Protection Features

Manual lap safety belts, center front/rear seat positions, where applicable

Manual lap/shoulder safety belts, outboard rear seat positions

Tempered safety glass, side windows; also rear windows

Accident Avoidance Features

Illuminated windshield wiper and washer controls (if on IP)

Low-glare finish on inside windshield moldings, wiper arms and blades, metallic steering wheel surfaces

Windshield defroster, washer and multi-speed wipers

⌋ A driver-side Supplemental Inflatable Restraint system (air bag) is standard on every front-drive Cadillac. Supplementing your lap/shoulder safety belt, it inflates in 1/20 of a second, then quickly deflates.

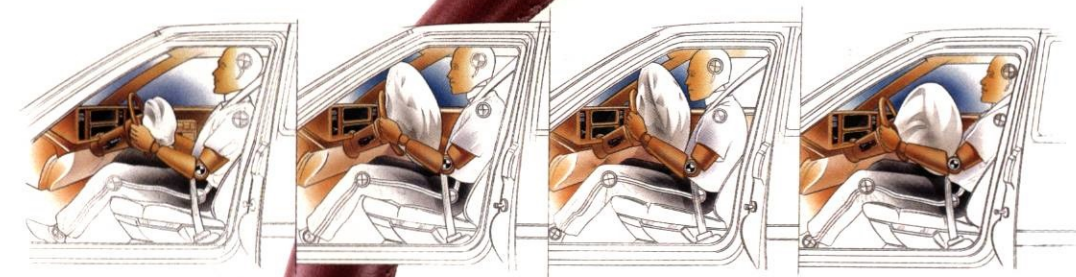

⌋ At Cadillac, we don't just surround your family with luxury. We surround them with safety.

⌋ A new windshield washer system on many 1991 Cadillacs directs washer fluid over a wider area for improved visibility. Refer to individual car line sections for feature availability.

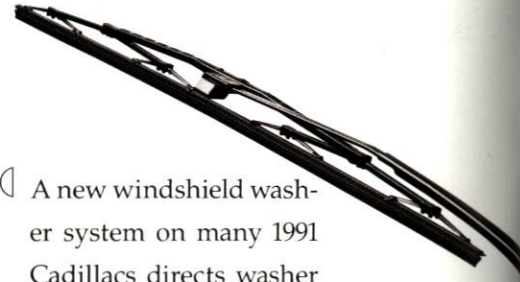

Cadillac proves a beautiful automobile can also be a safer automobile.

Cadillacs are renowned for their style and comfort.

But we believe that the ulti-

mate luxury in an automobile isn't a luxury at all; it's safety.

That's why every one of our Cadillacs is designed with a

rugged safety cage, made up of strong steel sections along the roof (except convertibles), door pillars and rocker panels.

Air bag. A driver-side Supplemental Inflatable Restraint system (air bag) is standard on all front-drive Cadillacs.

Safety glass. Cadillac was the first automaker to introduce standard safety glass.

Halogen headlamps. Exceed federal safety standards.

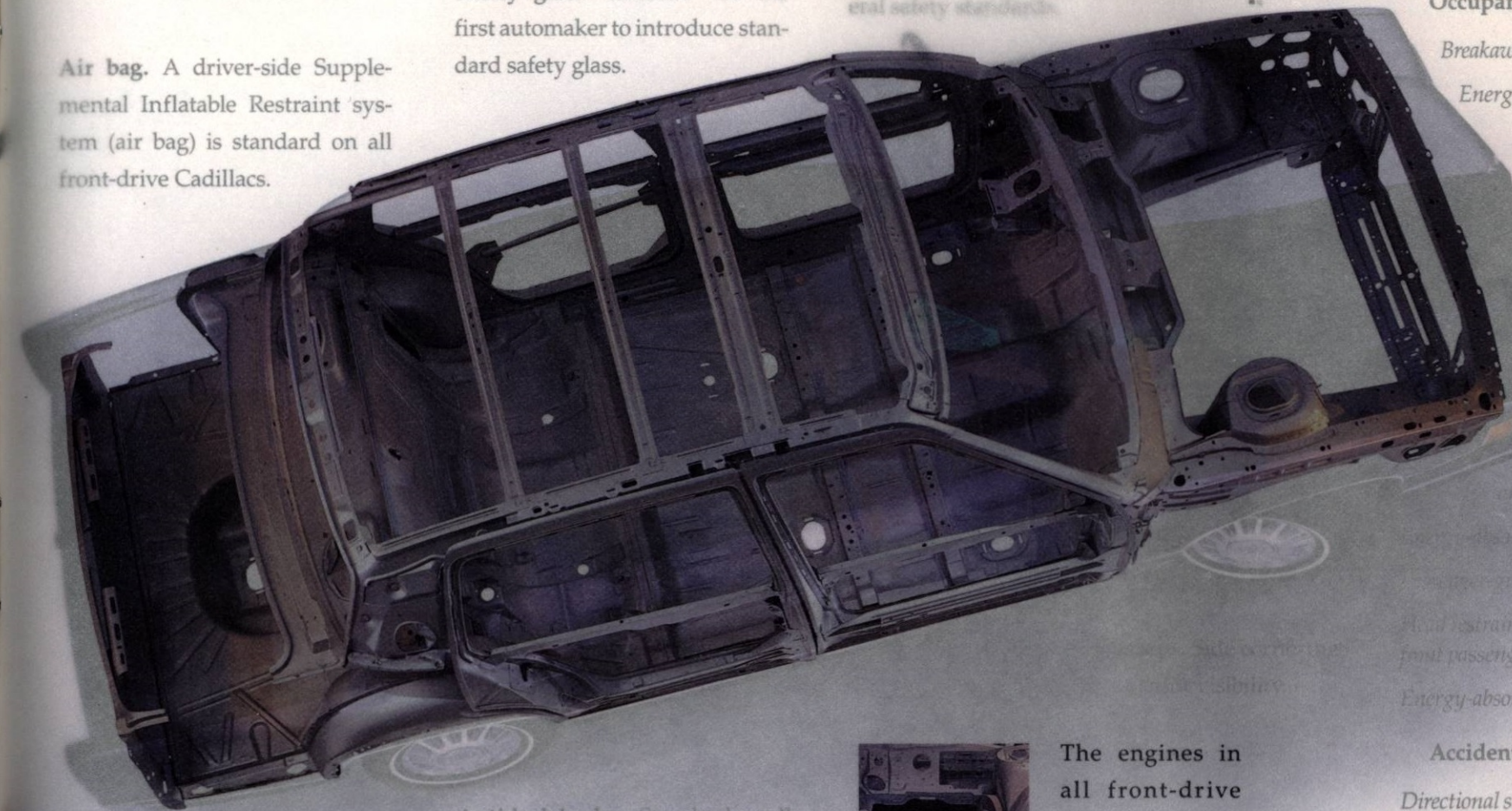

Anti-lock brakes. Standard on all Cadillacs.

Automatic door locks. When the transmission is shifted out of park, all doors are automatically locked.



Fuel tanks on all Cadillacs are designed and tested to be protected in collisions.

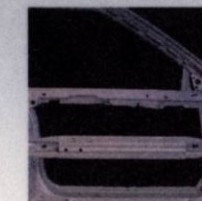

Side guard door beams help reduce intrusion in the event of a side impact.

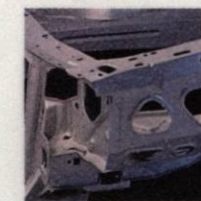

Energy-absorbing "crush zones" in the front and rear help absorb energy in the event of a collision.



All front-drive Cadillacs feature body-frame integral construction. All sections of the car are securely welded.

Occupant Protection Features

- Breakaway inside rearview mirror*
- Energy-absorbing steering column*
- Inertia-locking, folding front seatbacks, two-door models*
- Interlocking door latches*
- Pressure lock radiator cap*
- Dual sun visors*
- Safety armrests*
- Side-guard door beam*
- Security door lock and door retention components*
- Energy-absorbing seatback tops, front and rear*
- Energy-absorbing inside door lock handles*
- Head restraints, driver and right front passenger (adjustable)*
- Energy-absorbing instrument panel*

Accident Avoidance Features

- Directional signal control with lane-change feature*
- Dual-action hood latch*
- Illuminated heater and defroster controls*
- Inside rearview mirror*
- Outside left and right rearview mirrors*
- Parking lamps that illuminate with headlamps*
- Pressure-relief fuel cap (pressure-relief fuel system on Allanté)*
- Safety road wheel rims*
- Side marker lamps and reflectors*
- Starter safety switch*
- Tires with built-in tread wear indicators*

Cadillac proves a beautiful automobile can also be a safer automobile. Cadillacs are renowned for their style and comfort. But we believe that the style

isn't a luxury at all; it's safety. That's why every one of our Cadillacs is designed with a

mate luxury in an automobile. That's why every one of our Cadillacs is designed with a

A new windshield washer system on many 1991 Cadillacs directs washer fluid over a wider area for improved visibility.

At Cadillac, we don't just surround your family with luxury. We surround them with safety.

Air bag. A driver-side Supplemental Inflatable Restraint system (air bag) is standard on all front-drive Cadillacs.

Safety glass. Cadillac was the first automaker to introduce standard safety glass.

Halogen headlamps. Exceed federal safety standards.

Occupant Protection Features

- Breakaway inside rearview mirror
- Energy-absorbing steering column
- Inertia-locking, folding front seatbacks, two-door models
- Interlocking door latches
- Pressure lock radiator cap
- Dual sun visors
- Safety armrests
- Side-guard door beam
- Security door lock and door retention components

- Energy-absorbing seatback tops, front
- Passenger-guard inside door lock handles
- Head restraints, driver and right front passenger (adjustable)
- Energy-absorbing instrument panel

Accident Avoidance Features

- Directional signal control with lane-change feature
- Dual-action hood latch
- Illuminated heater and defroster controls
- Inside rearview mirror
- Outside left and right rearview mirrors
- Parking lamps that illuminate with headlamps
- Pressure-relief fuel cap (pressure-relief fuel system on Allanté)
- Safety road wheel rims
- Side marker lamps and reflectors
- Starter safety switch
- Tires with built-in tread wear indicators

Anti-lock brakes. Standard on all Cadillacs.

Automatic door locks. When the transmission is shifted out of park, all doors are automatically locked.

Cornering lamps. Side cornering lamps for superior visibility.

Building a safer automobile. Cadillac Style.

At Cadillac, we believe it's our duty to help protect the people who drive and ride on our cars. As a result, we conduct extensive testing and offer features which meet or exceed governmental regulations.

Every Cadillac begins from knowledge learned at General Motors' automotive safety research center, the world's largest. There, Cadillacs undergo impact tests so exhaustive, they exceed governmental mandates. Brakes, steering and other systems are subjected to rigid trials.

The results: every Cadillac is equipped with some of the most sophisticated safety technology on the road today.

Occupant Protection Features

Manual lap safety belts, center front/rear seat positions, where applicable

Manual lap/shoulder safety belts, outboard rear seat positions

Tempered safety glass, side windows; also rear windows

Accident Avoidance Features

Illuminated windshield wiper and washer controls (if on IP)

Low-glare finish on inside windshield moldings, wiper arms and blades, metallic steering wheel surfaces

Windshield defroster, washer and multi-speed wipers

The engines in all front-drive Cadillacs are designed to rotate downward in a frontal collision.

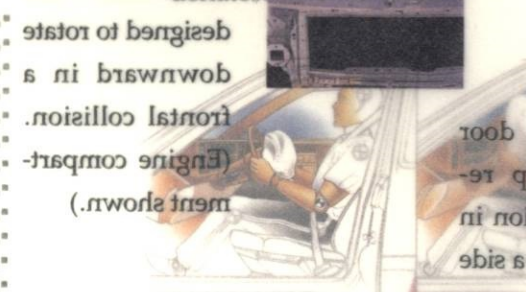

All front-drive Cadillacs feature body-frame integral construction. All sections of the car are securely welded.



Fuel tanks on all Cadillacs are designed and tested to be protected in collisions.



Side guard door beams help reduce intrusion in the event of a side impact.

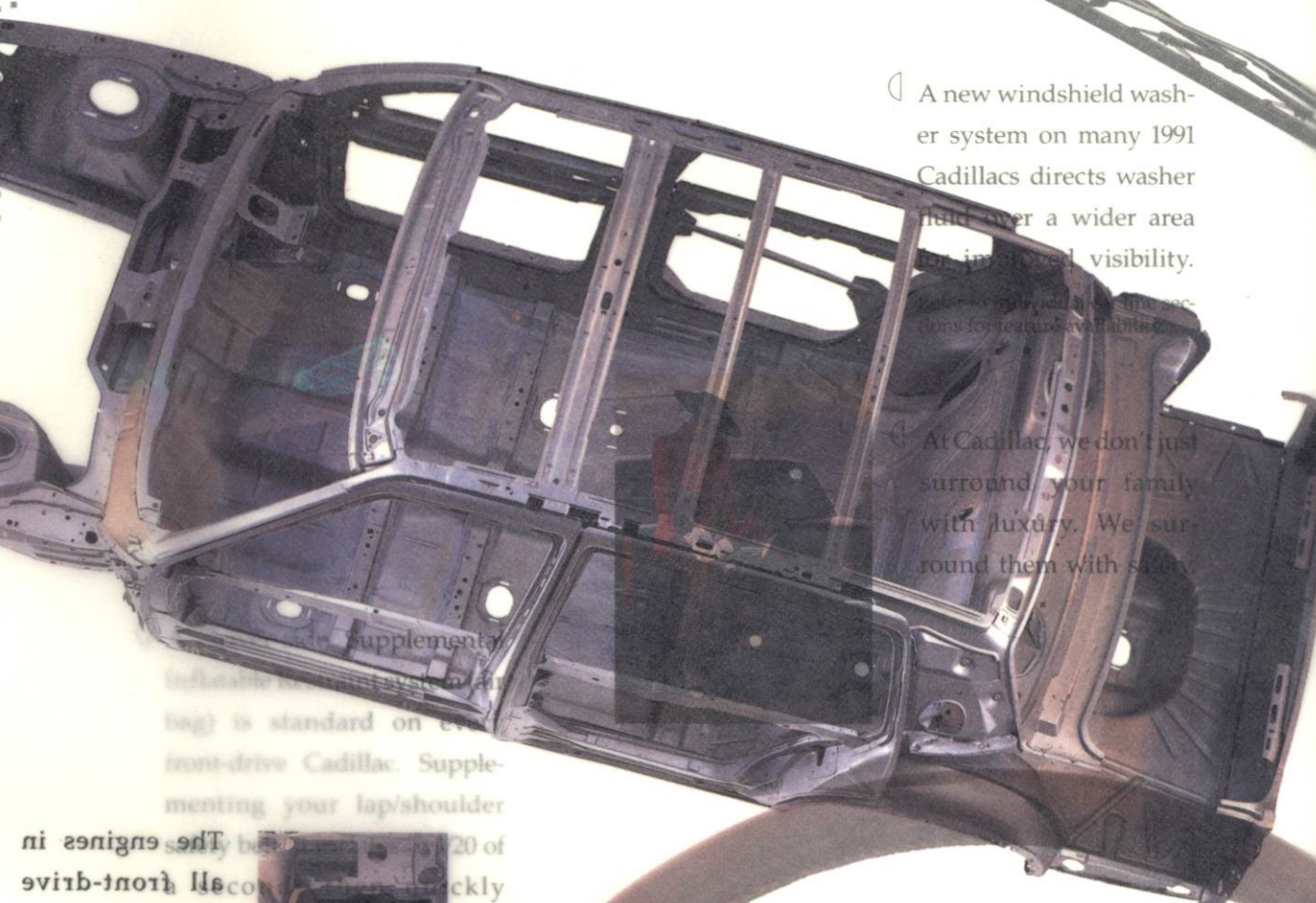

**No-deductible,
bumper-to-bumper warranties.**

The substance of Cadillac Style includes warranty protection among the finest of any luxury car—foreign or domestic.

Cadillac's Gold Key Bumper to Bumper warranty covers every component of every Cadillac—no exceptions, no deductibles—for 4 years/50,000 miles.* The Allanté Assurance Plan extends powertrain and major assembly component protection to 7 years/100,000 miles.**

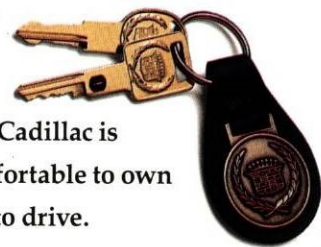

**Why a Cadillac is
as comfortable to own
as it is to drive.**

An outstanding portfolio of services is another reason why Cadillac owners are the most loyal of all luxury car owners.†

As a Cadillac owner, you have the support of over 1,600 leading luxury Cadillac dealers nationwide. As part of Cadillac's Gold Key delivery system, your sales representative will make sure the fuel tank is filled and introduce you to key dealership personnel.

*Covers every component (except tires, which are covered by their manufacturer, adjustments, normal maintenance items and battery, which is covered by its own 4-year/50,000-mile prorated warranty).

**Unique Allanté Assurance Plan. See your dealer for terms of this limited warranty.

†According to an R. L. Polk & Co. study of initial retail purchasers of leading 1989 luxury cars.

**Cadillac Roadside Service®
follows you wherever you go.**

Cadillac Roadside Service® has more participating dealers offering on-the-spot service than any other luxury car program. As a Cadillac owner, you are automatically covered—whatever year or model you drive.

Call toll-free **1-800-882-1112** to talk with factory-trained service advisors 24 hours a day, 365 days a year. They will help remedy your situation right over the phone.

If necessary, a highly trained service technician will be dispatched in a special vehicle that carries genuine GM parts to provide on-the-spot service when you need it the most—nights, weekends and holidays.

We listen 24 hours a day.

Cadillac's Consumer Relations Center is a 24-hour owner hotline to get you in contact with a Cadillac specialist.

Call **1-800-458-8006** with any inquiries or concerns. Allanté owners may call **1-800-ALLANTÉ.**

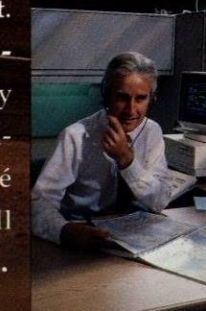

A | L | L | A | N | T | É

1 | 9 | 9 | 1

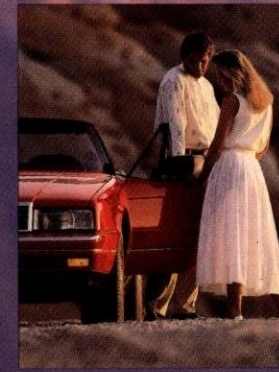

Allanté, the ultra-luxury roadster with coachwork designed and handcrafted in Italy by Pininfarina. Allanté combines a high-output V8, European road manners, advanced technology and renowned Cadillac comfort to afford you the finest in open-air motoring.



Allanté® shown in Red. Allanté interior with Charcoal leather seating areas shown on the following pages.



Allanté's soft top affords you the inherent advantages of a heated glass rear window.



Controls for Recaro® seats include 10-way power adjustment and two-position driver-side memory.



Allanté's new, 200-watt Delco/Bose 200 Series sound system is custom-equalized to complement Allanté's interior surfaces and dimensions.





The first roadster in the world with Traction Control standard. Allanté combines the advantages of standard Traction Control, anti-lock braking and variable assist steering. Allanté also balances inspired performance with Cadillac refinement by virtue of its responsive 200-horsepower, tuned V8. High performance four-speed automatic transmission with overdrive. And an enhanced Speed Dependent Damping suspension and Cadillac-exclusive Goodyear Eagle 16" V-rated tires.

New platinum-tipped spark plugs are so durable, their recommended replacement interval is an impressive 100,000 miles.

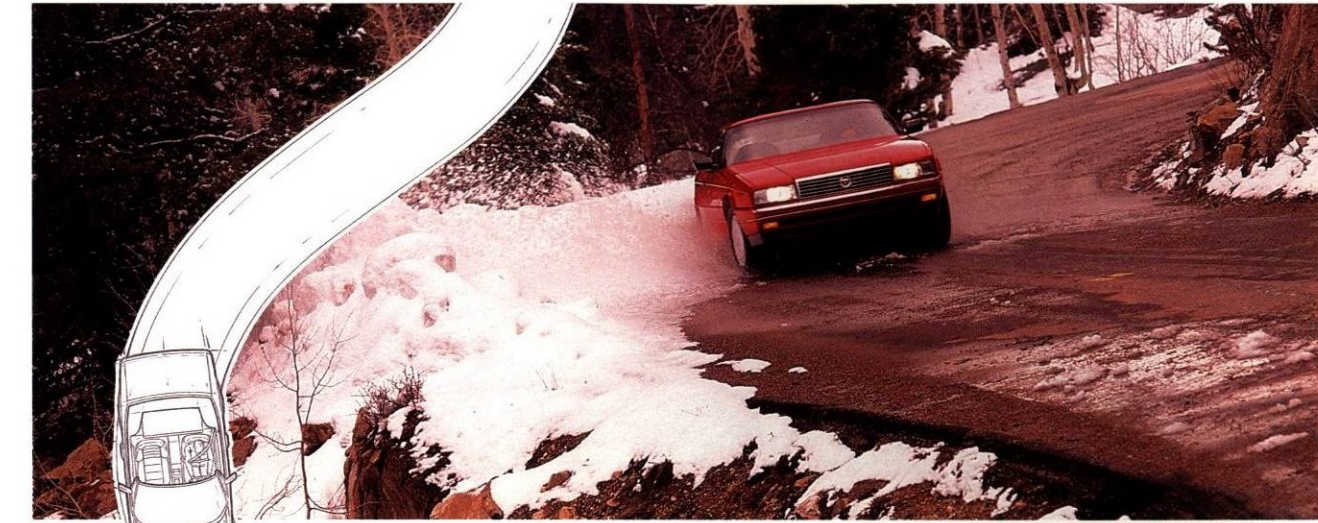

Wheel slip detected.

Anti-lock brakes pulsed.

Engine output reduced.

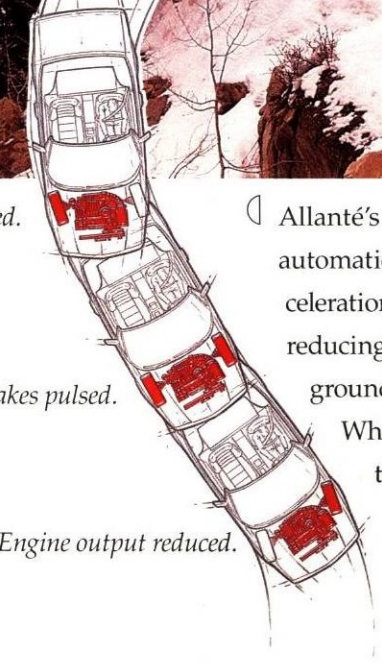

Allanté's standard Traction Control system automatically detects wheel slip during acceleration, pulsing the anti-lock brakes and reducing engine output until wheel and ground speed are nearly matched. Wheel slip is minimized for greater control on virtually any road surface.



Allanté was the first car in the world equipped with the reassuring control of Bosch III anti-lock brakes.

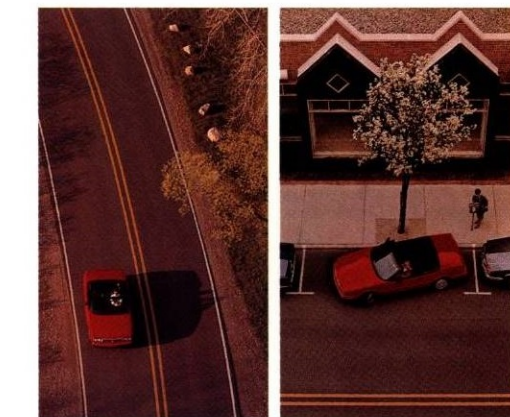

A washer helps keep Allanté's integral headlamp/foglamp clean for maximum visibility.



Allanté's advanced driving systems react to changing vehicle speeds. The Speed Dependent Damping system automatically adjusts the strut damping of the fully independent suspension. The result: isolation from bumps in city driving and increased control for highway travel. Speed-sensing variable assist steering provides parking ease, as well as highway stability.

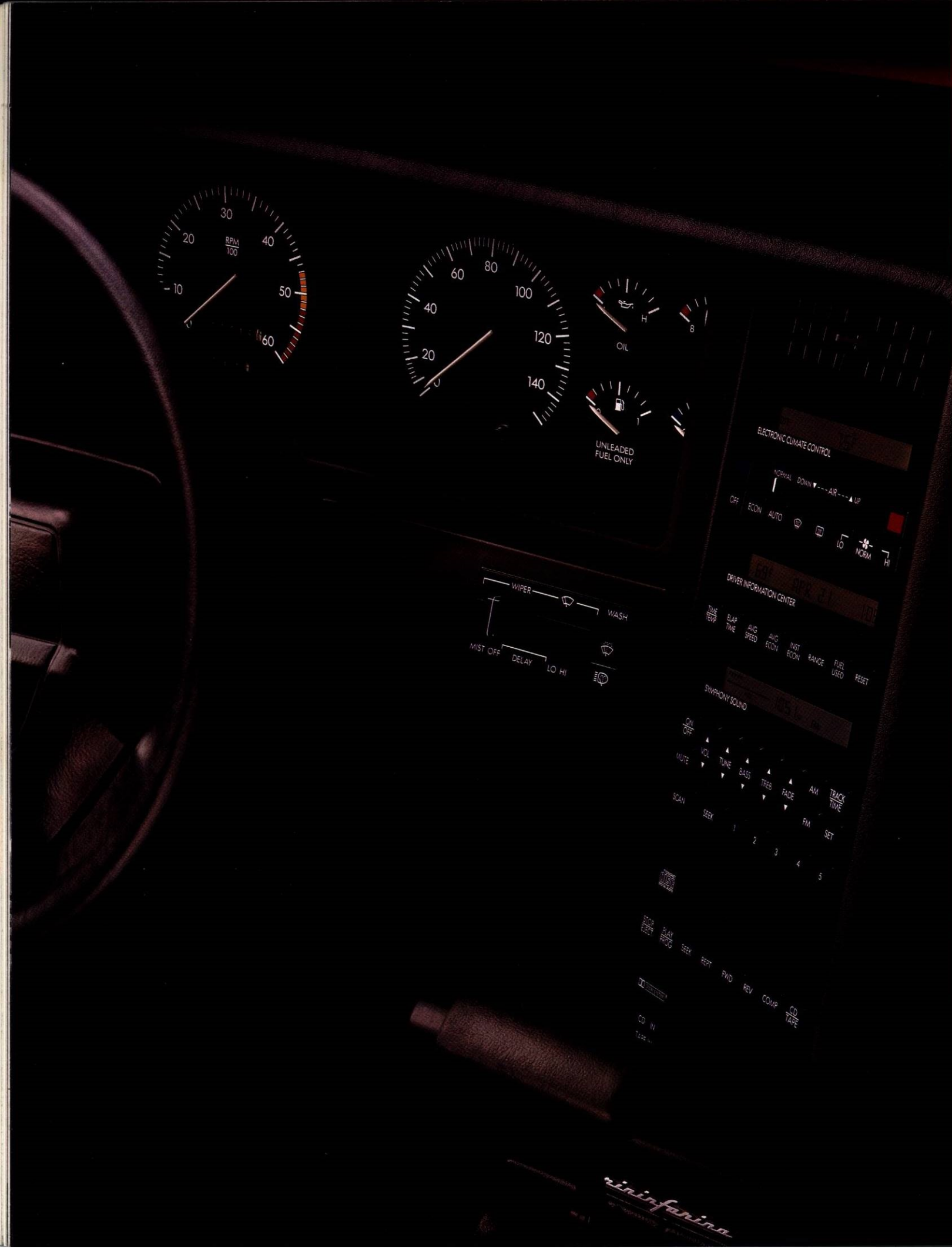

**Comfort and convenience
previously unheard-of
in a roadster.**

Allanté affords you unequalled comfort and convenience through whisper-quiet aerodynamics. Ten-way, power-adjusting Recaro® seats with supple, hand-matched Italian leather seating areas. One of the world's finest electronic climate control systems. Plus power headlamp washers. Express-down windows. Central door unlocking. And a PASS Key® theft-deterrent system.

⌋ Analog instrumentation allows you to monitor driving systems at a glance.



⌋ With the most luggage space of any roadster sold in America, Allanté's pass-through compartment design accommodates skis, golf clubs and more.

⌋ Computer-based lamp control, a worldwide exclusive, senses when a front lamp burns out, notifies the driver, and automatically illuminates a lamp nearby.



⌋ With the touch of a button, Allanté's new power-latching roof design automatically reattaches the soft top.



⌋ Allanté's digital instrument panel (shown above) and analog instrument panel (shown facing page) both include a driver's side Supplemental Inflatable Restraint system (air bag) concealed in the steering wheel hub.

SPECIFICATIONS

Two Models:

- Hardtop/Convertible with hard and soft top, your choice of digital or analog instrument panel.
- Convertible with soft top, analog instrument panel or available digital instrument panel.
- 4.5 liter tuned V8.
- Traction Control.
- Unique four-speed automatic transmission with overdrive.
- BOSCH III anti-lock brake system (ABS).
- Fully independent four-wheel suspension with enhanced Speed Dependent Damping.
- Power rack and pinion variable assist steering.
- Exclusive P225/55VR16 Goodyear Eagle V-rated tires on 16" x 7" forged aluminum alloy wheels.
- 99.4" wheelbase, 178.7" length.
- 16.3 cu.-ft. luggage space with pass-through.

F | L | E | E | T | W | O | O | D

1 | 9 | 9 | 1



With its new styling enhancements, a new, more powerful V8 engine, new standard Computer Command Ride and standard anti-lock brakes, the 1991 Fleetwood is eminently qualified to carry the title of America's most distinctive full-size luxury car.



Fleetwood® Sedan shown in Sable Black. Fleetwood Sixty Special interior with Dark Blue leather seating areas shown on the following pages.

FLEETWOOD
SIXTY SPECIAL



The interior displays the hand-fitted craftsmanship of supple leather seating areas, complete with elegant French seamwork.

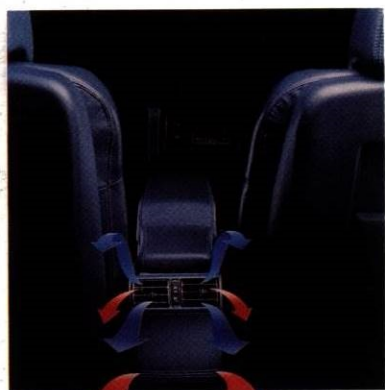

New rear-seat climate control vent features multi-directional and air volume controls.



The orthopedically designed 22-way seats create a new standard in occupant back comfort.

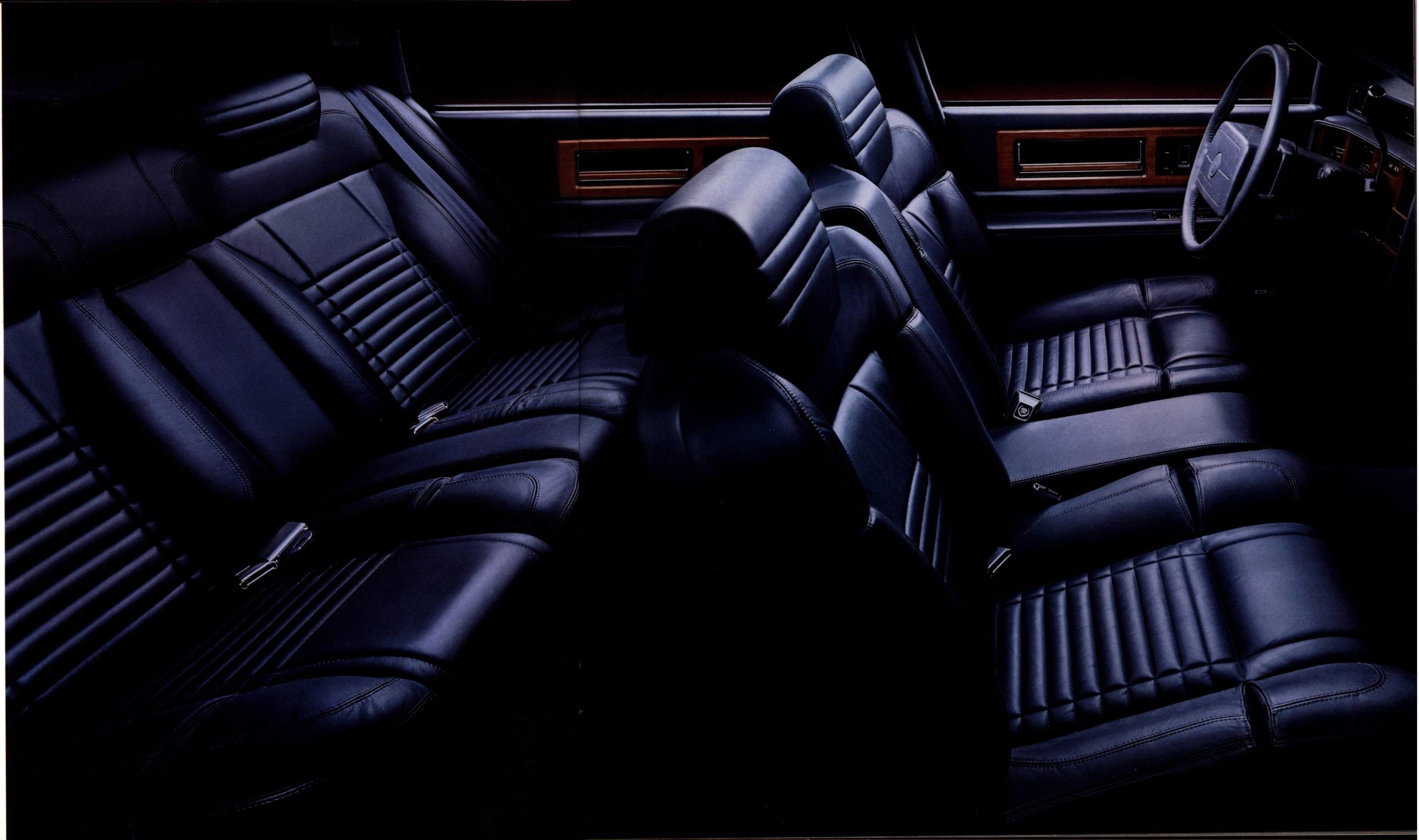

F | L | E | E | T | W | O | O | D | C | O | U | P | E

1 | 9 | 9 | 1

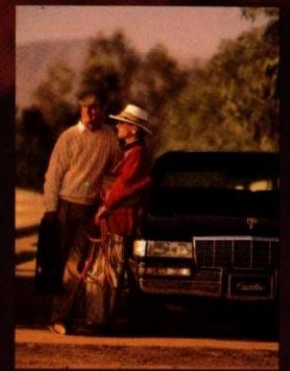

Only Cadillac offers you a full-size, six-passenger luxury coupe. The 1991 Fleetwood Coupe. With a new, more powerful V8 engine. New standard Computer Command Ride. A wide range of comfort and convenience features. And distinctive, two-door styling that is unmistakably Cadillac.

Fleetwood® Coupe shown in Royal Maroon. Fleetwood interior with available Slate Gray leather seating areas shown on the following pages.



Fleetwood's new standard cloth seating shown in Dark Blue.

A new sun sensor monitors the intensity and angle of infrared light waves entering the passenger compartment. Interior climate control flow is adjusted accordingly.

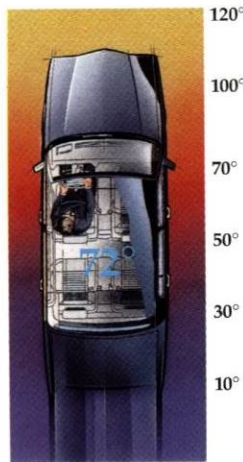

The standard Electrochromic inside rearview mirror automatically darkens to reduce glare.



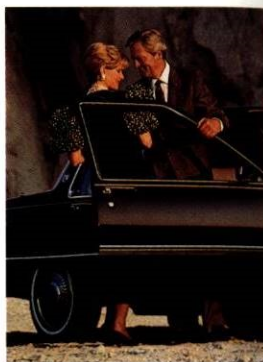
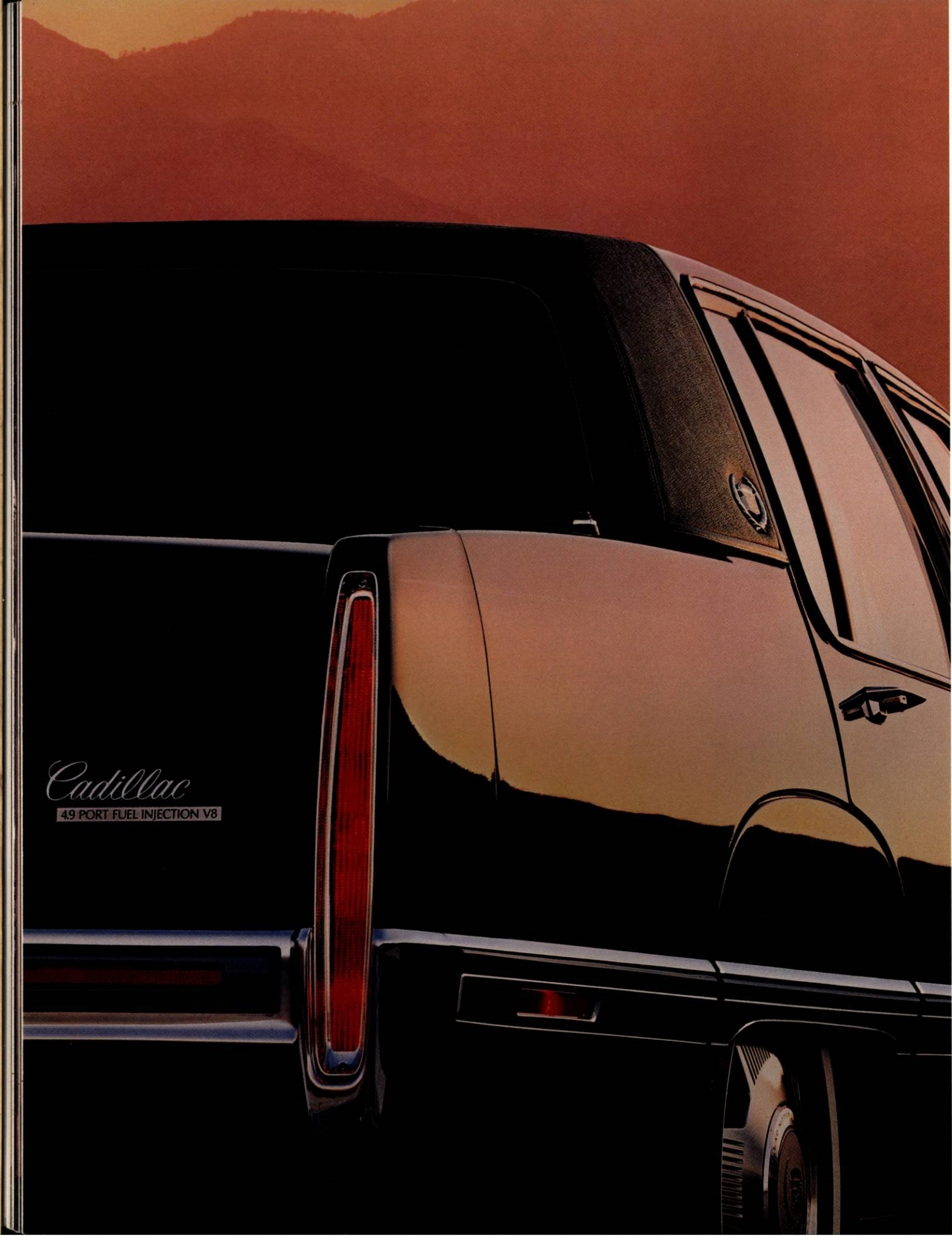

Cadillac Fleetwood.

As distinctive as the individuals who drive it.

Fleetwood's high standards provide unparalleled comfort and distinction. New grille and molding treatments. Rear-wheel fender skirts. New aluminum alloy wheels. A six-speaker sound system featuring five-band graphic equalizer and cassette player. And a driver's-side Supplemental Inflatable Restraint system (air bag).



Polished American walnut frames the sophisticated, yet uncluttered, electronic instrument panel.

Comfort Mode Touring Mode

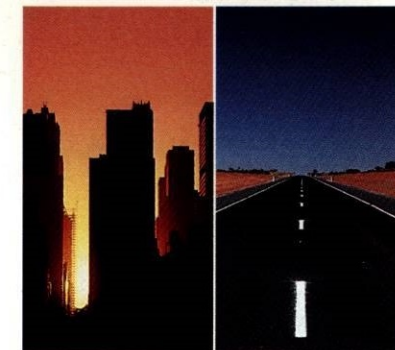

The standard Computer Command Ride system enhances ride comfort and control by automatically adjusting the suspension's firmness as vehicle speed changes.



Fleetwood's standard Teves anti-lock brake system helps you to maintain control when braking on slippery surfaces.

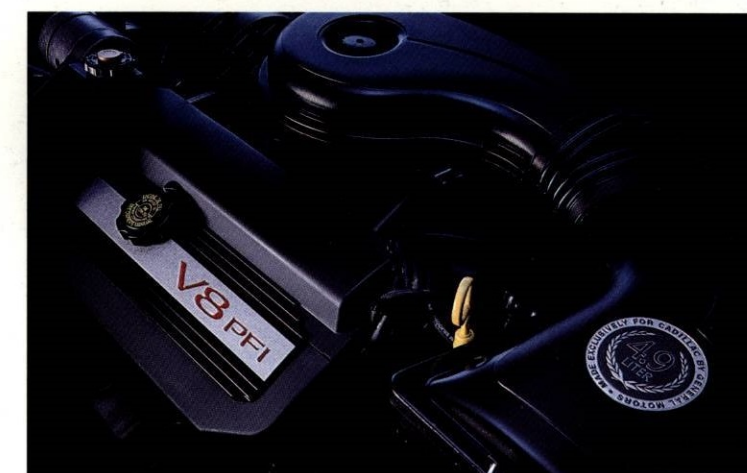

Every 1991 Fleetwood incorporates a new 4.9 liter V8 with sequential port fuel injection rated at 200 hp and 275 lbs.-ft. of torque, highest of any front-drive automobile in the world.

An available remote keyless entry system locks and unlocks doors and unlocks the deck lid from a 15-foot radius. The system also activates interior lights and the theft-deterrent system.



D | E | V | I | L | L | E

1 | 9 | 9 | 1



In 1991, De Ville offers a balance of power and luxury in which neither is compromised. Combining a new, more powerful V8, distinctive new styling refinements, and the largest interior of any front-drive automobile in the world.



Sedan de Ville® shown in Black Sapphire. Sedan de Ville interior with available Dark Blue leather seating areas shown on the following pages.



Soft new seat cloth creates an added touch of comfort and elegance.



De Ville's fuel data center calculates your average mileage and estimated driving range.



Newly standard heated outside rearview mirrors with power adjustment offer maximum visibility in freezing weather.



C | O | U | P | E | D | E | V | I | L | L | E

1 | 9 | 9 | 1



For 1991, the distinctive Coupe de Ville combines new two-door styling, standard anti-lock brakes, a more powerful, Cadillac-exclusive V8, and full-size, six-passenger comfort.

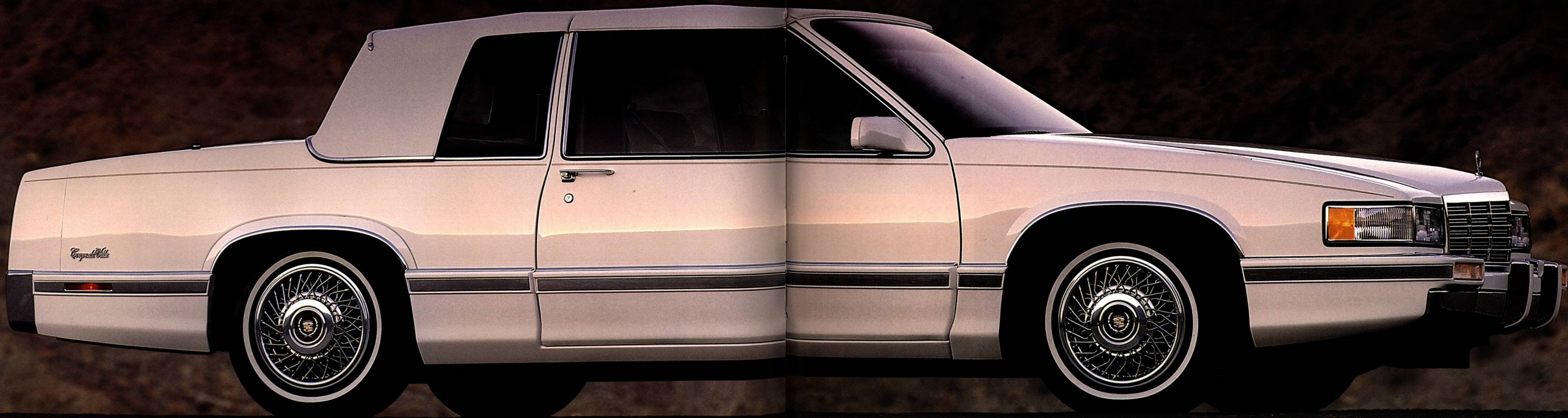

Coupe de Ville® shown in Cotillion White with available full cabriolet roof.



Refining America's most successful luxury automobile. Behind the new styling of the 1991 De Ville is the new substance of a more powerful, 200 horsepower V8. The superior control of anti-lock brakes. Automatic door locks with central door unlocking. New child security windows and rear door lockouts. New rear-seat heating/air conditioning. And new design cast aluminum alloy wheels. All standard.

The distinctive new grille, headlamps and sculptured hood reflect the increased power that lies beneath.



De Ville's uncluttered, ergonomically designed instrument panel makes all controls easy to locate and reach.



New EZ-KOOL™ glass shields you from 57% of the sun's rays to keep you cooler, reduce glare and prolong interior beauty.

A newly standard anti-lock braking system modulates brakes to provide improved control on virtually any road surface.



Over 18 cubic feet of trunk space gives you abundant luggage room.



A new, more powerful, 4.9 liter V8 with sequential port fuel injection delivers that added response to help you merge and pass with ease.



E | L | D | O | R | A | D | O

1 | 9 | 9 | 1



In 1991, Eldorado strengthens its position as America's definitive personal luxury coupe with expressive styling and sophisticated technology. A new, more powerful V8 engine. Newly standard anti-lock brakes. And new Computer Command Ride, standard.



Eldorado® shown in Carmine Red. Eldorado interior with available Garnet leather seating areas shown on the following pages.

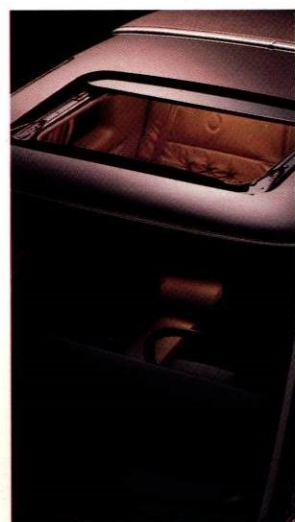

⌋ An available power Astrorooftop features a retractable/tiltable glass panel, adjustable sunshade and air deflector.



⌋ Touch the power button momentarily and the express-down window lowers itself completely.

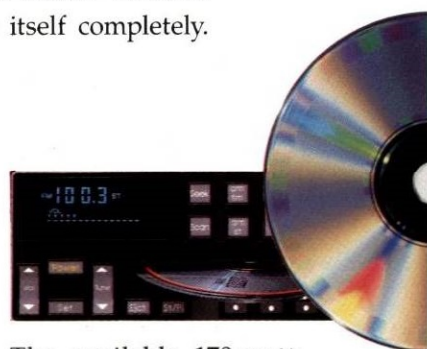

⌋ The available 170-watt Delco/Bose Gold Series sound system, featuring cassette or compact disc capabilities, provides custom-equalized sound.



E | L | D | O | R | A | D | O T | O | U | R | I | N | G

C | O | U | P | E

1 | 9 | 9 | 1



From its technological advancements to the distinctive styling and luxury that surround them, the Eldorado Touring Coupe delivers grand touring, Cadillac Style. With sophisticated performance. And interior appointments designed to indulge the driving enthusiast.



Eldorado® Touring Coupe shown in Sable Black. Eldorado Touring Coupe interior with standard Beechwood leather shown on the following pages.

ELDORADO
TOURING COUPE



Genuine Birdseye maple frames the console and instrument panel.

Ultra-soft leather is hand-fitted to the seats. Front-seat side bolsters provide added support.



The 10-way power-adjusting seats include lumbar and recliner controls.



E | L | D | O | R | A | D | O B | I | A | R | R | I | T | Z 1 | 9 | 9 | 1

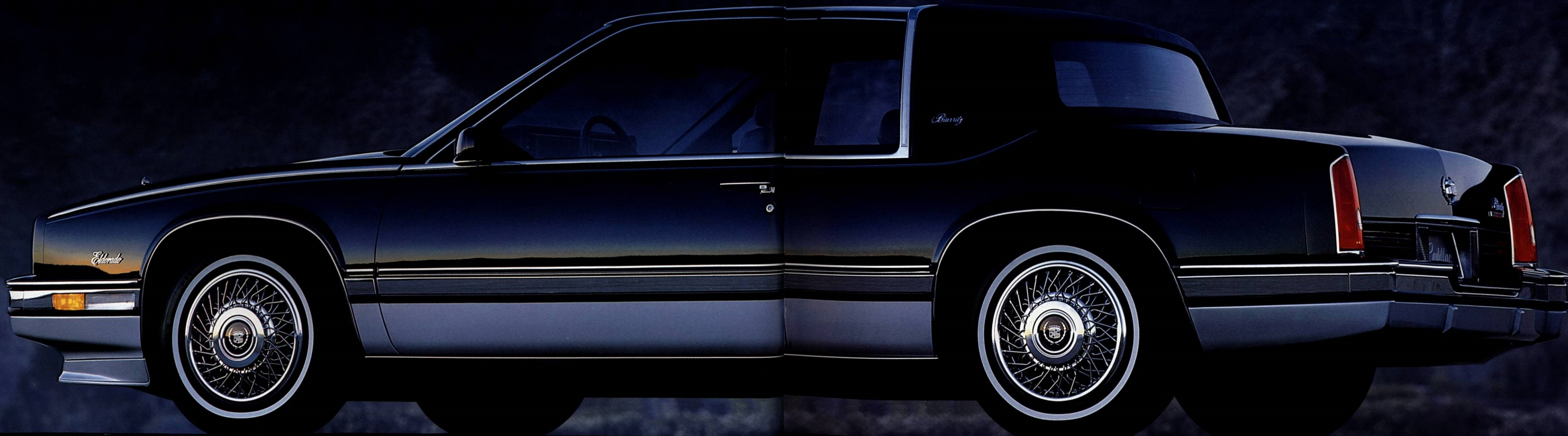

The Eldorado Biarritz. A most elegant way to display your penchant for uniqueness. With a cabriolet roof, genuine Birdseye maple interior trim, and plush 10-way power adjusting seats.



The exclusive Eldorado® Biarritz™ interior with standard leather seating areas shown in Dark Blue.

Eldorado Biarritz shown in Black Sapphire.

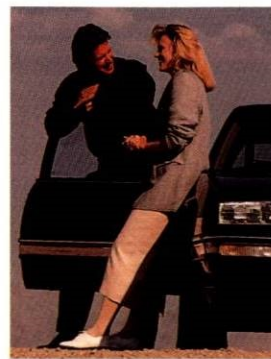
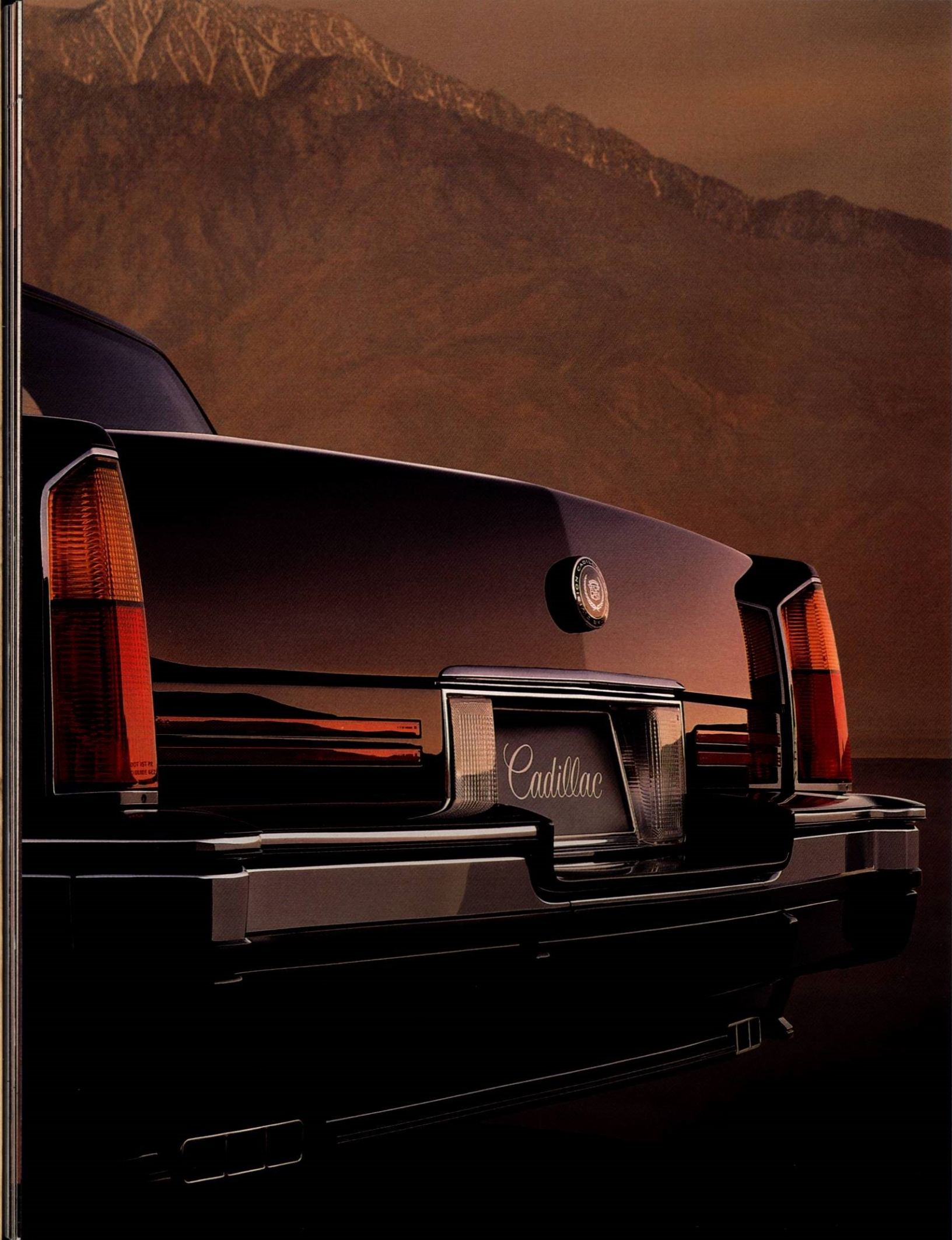

Cadillac Eldorado. America's premier luxury coupe.

Crisp styling and luxurious appointments make Eldorado the embodiment of what a driver's coupe should be. With the inspired performance of a taut suspension. The inherent security of an illuminated entry system. A standard driver-side Supplemental Inflatable Restraint system (air bag) and lap/shoulder safety belts. And electronic climate control for calibrated comfort.

⌋ Dual-outlet exhausts and international-style tail lamps are just two examples of Eldorado Touring Coupe's unique brand of distinction.



⌋ Birdseye maple wood highlights the digital instrument panel. This premium handfinished wood is standard on Biarritz and Touring Coupe and available on Eldorado.

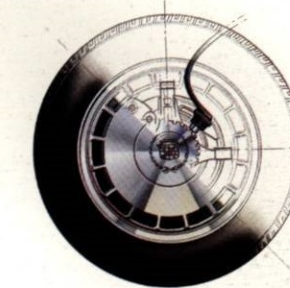

⌋ Eldorado's standard Bosch II anti-lock brake system helps you to maintain steering control when braking on virtually any road surface.

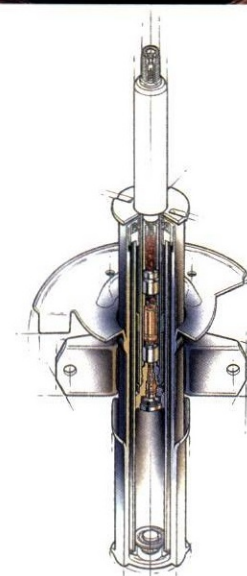

⌋ Eldorado's sophisticated new Computer Command Ride system automatically adapts suspension modes to vehicle speed in 15/100 of a second for precise response.



⌋ Sequential port fuel injection meters fuel precisely to each cylinder of the new 4.9 liter V8. Fast response time maximizes increased power.

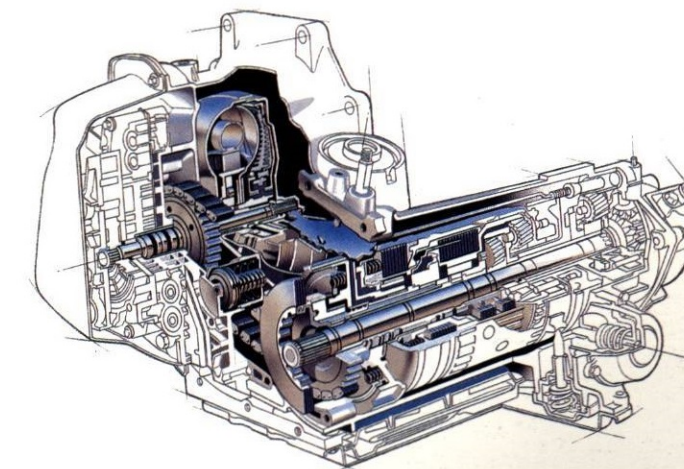

⌋ A new electronic transmission with a Cadillac-exclusive viscous converter clutch provides precise shifting for consistently smoother feel.

S | E | V | I | L | L | E | S | T | S

1 | 9 | 9 | 1



The 1991 Seville STS enhances its renown as America's international touring sedan with a new, higher-output V8. Standard anti-lock braking. New five-passenger seating. A sophisticated speed-sensing suspension. Combined with a luxurious, hand-crafted interior.



Seville® STS shown in Carmine Red. Seville STS interior with standard Beechwood leather shown on the following pages.



The elegance of inlaid elm burl even frames the controls of the 10-way power front bucket seats.



New, leather-wrapped, rear-seat headrests are designed and crafted for comfort and safety.



Seville's sophisticated driver information center keeps you updated on vital automotive systems.



S | E | V | I | L | L | E

1 | 9 | 9 | 1

In 1991, Seville's comfort and convenience are complemented by a new, even more powerful 4.9 liter V8. Standard anti-lock brakes. A suspension that adjusts to the way you drive. And virtually every conceivable power assist standard.



Seville® interior with available Dark Auburn leather seating areas.

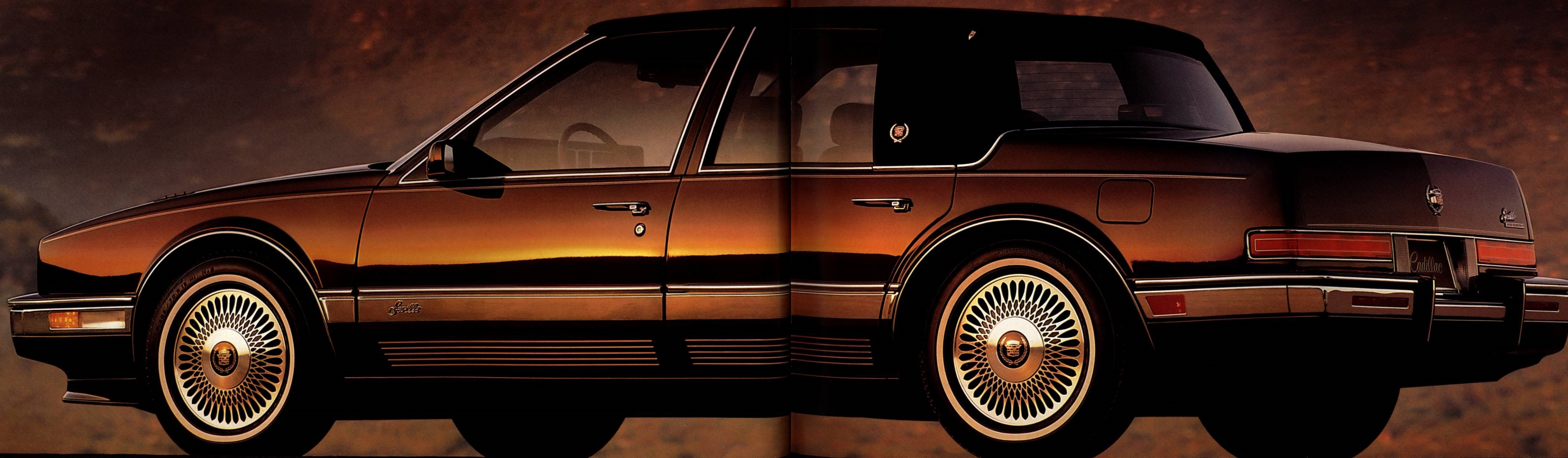

Seville shown in Dark Auburn with available Phaeton roof.

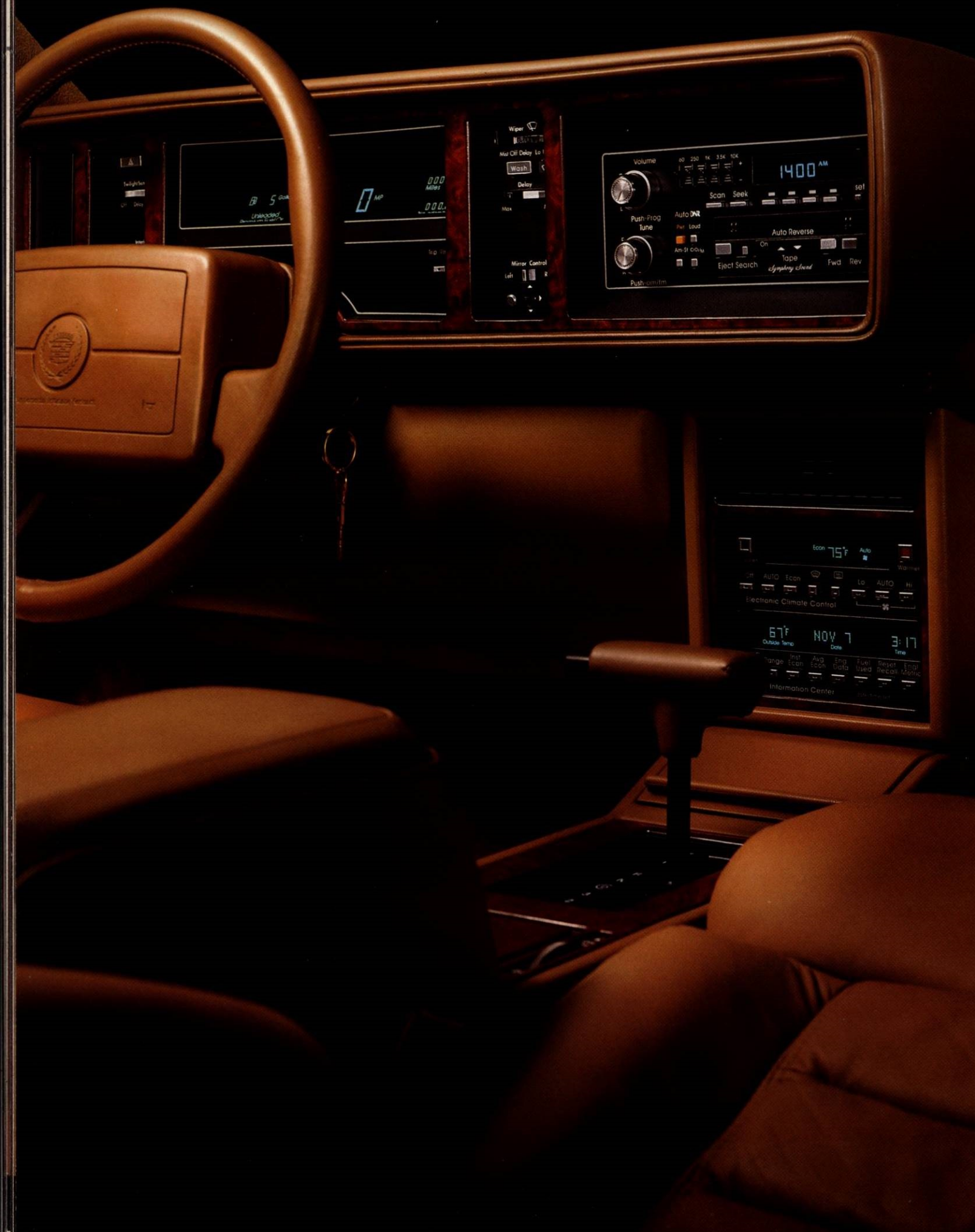

Seville 1991

The substance behind the style. The new contoured seating of the Seville STS interior is covered with over 95 square feet of hand-fitted, ultra-soft leather. The taut touring suspension delivers spirited handling without unwanted harshness. Automatic door locks and keyless entry are also standard.

Seville's impressive amenities include 10-way power adjusting front seats, fitted with elegant French seams. Driver information center. And a driver's-side Supplemental Inflatable Restraint system (air bag).

The Seville STS features rich inlaid elm burl wood, hand-finished at Behr in West Germany.



New Computer Command Ride cushions city driving, yet affords you superb road feel and control on the highway by automatically adjusting the suspension as you change speeds.

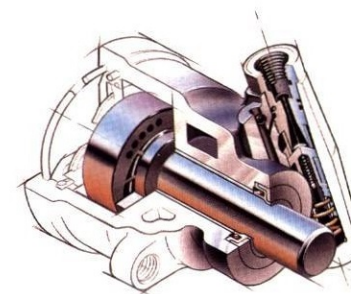

Refinements to the power-steering pump contribute to quiet, precise steering.

Standard anti-lock braking gives you improved control during severe braking on dry pavement or when braking on wet or slippery surfaces.

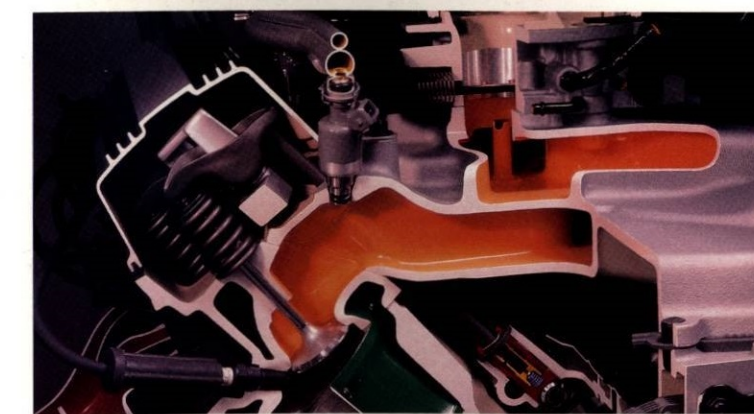

Sequential port fuel injection meters fuel precisely to each cylinder of the new 4.9 liter V8. Fast response time maximizes increased power.

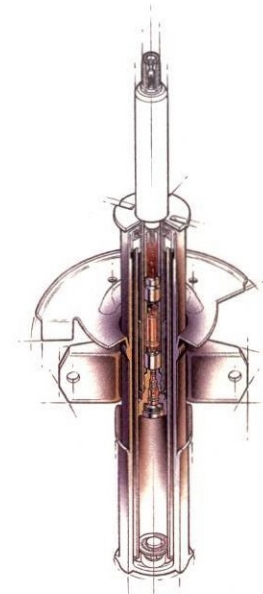

Computer Command Ride automatically shifts the damper between "comfort," "normal," and "touring" modes in 15/100 of a second as you stop, start, corner or accelerate.

B | R | O | U | G | H | A | M D ' E | L | E | G | A | N | C | E

1 | 9 | 9 | 1

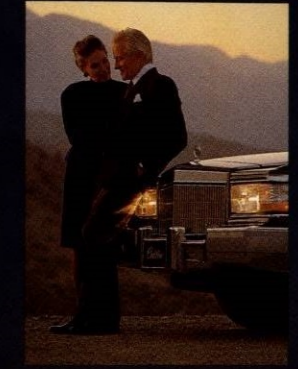

Peace of mind comes standard on America's longest regular-production automobile. Provided by a new, more powerful V8 engine. Standard anti-lock brakes. Full-size, six-passenger comfort. And the timeless elegance of a true automotive classic.



Brougham™ d'Elegance® shown in Black Sapphire. Brougham d'Elegance interior with available Dark Blue leather seating areas shown on the following pages.



Brougham's seats are designed for ease of entry and exit.



Adjustable rear-seat reading lamps provide added convenience.

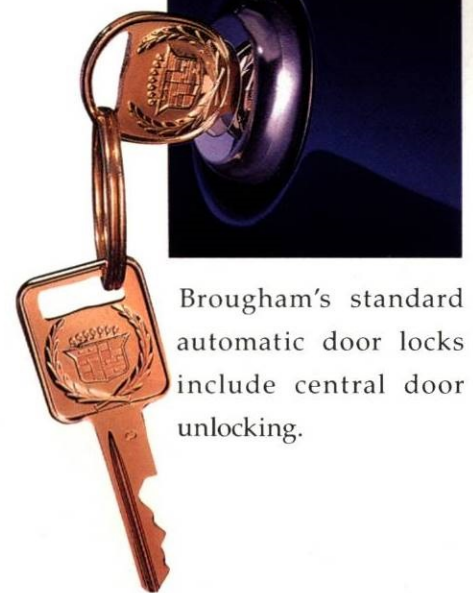
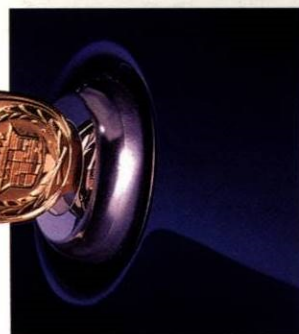

Brougham's standard automatic door locks include central door unlocking.



B | R | O | U | G | H | A | M

1 | 9 | 9 | 1



• The 1991 Brougham. Featuring the uncompromising luxury and elegance of full-size, six-passenger comfort. The style and elegance of a classic design. And the inherent luxury of a true automotive legend.

Brougham™ shown in Sable Black.



Cadillac Brougham.
An American classic.

Brougham once again displays a perfect blend of comfort and convenience. With six-way, power-adjusting front seats. A leather-wrapped steering wheel rim with tilt and telescoping functions. The smooth ride of an improved suspension, and operational ease of new electronic variable assist steering. An AM stereo*/FM stereo radio with cassette player. And perhaps the most comforting feature of all: Cadillac's impressive ownership services program.

*See page 72

Composite headlamps and styling refinements enhance Brougham's classic design.



Brougham's easy-to-read digital instrument panel puts controls and convenience features within comfortable reach.

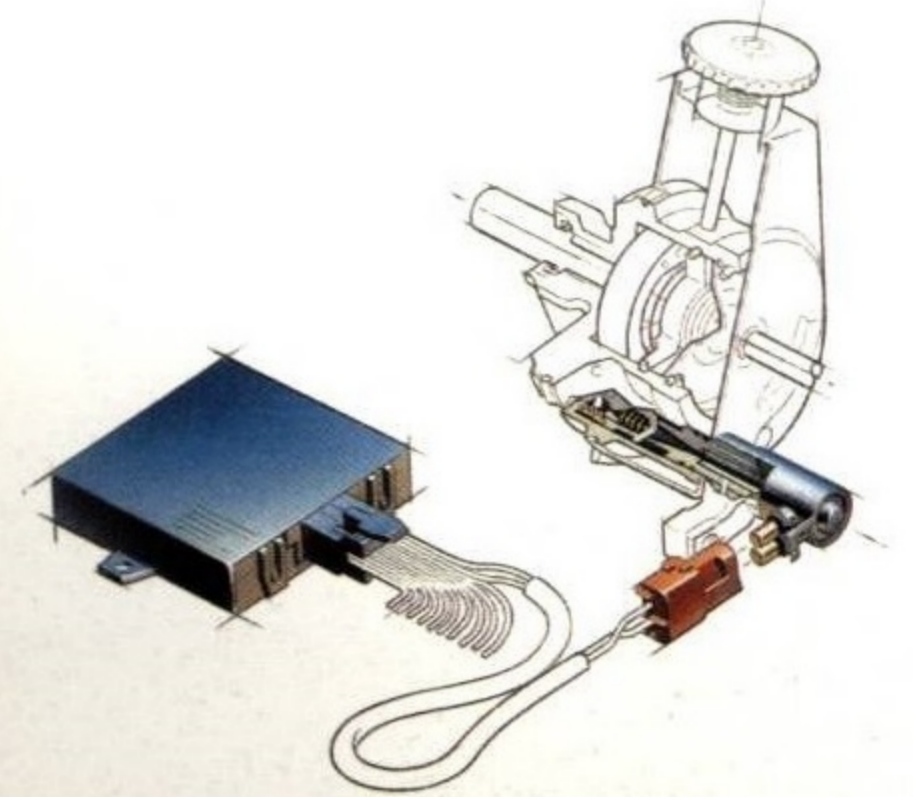

New standard electronic variable assist steering controller monitors vehicle speed to automatically adjust steering for added stability at higher speeds and reduced effort when parking.

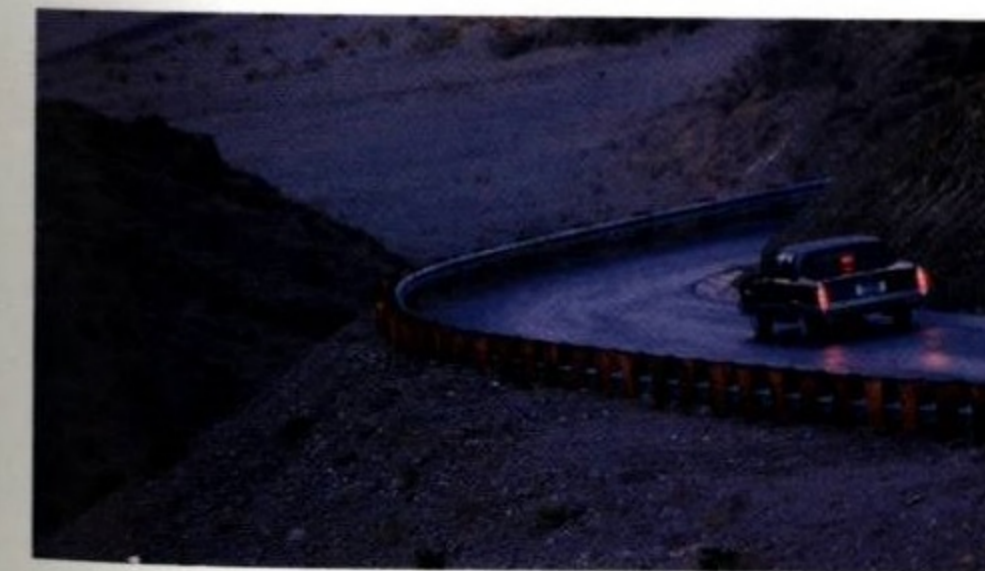

Standard Bosch II anti-lock brakes help you maintain steering control when braking on virtually any road surface.



A mere touch of the power trunk lid release displays 19.6 cubic feet of luggage space.



A standard 5.0 liter fuel-injected V8 engine, new for 1991, generates 170 horsepower and 255 lbs-ft. of torque for impressive response.



An available 5.7 liter V8 engine provides 185 horsepower and 300 lbs-ft. of torque. It is included in the available trailer towing package.

L | I | M | O | U | S | I | N | E | S

1 | 9 | 9 | 1

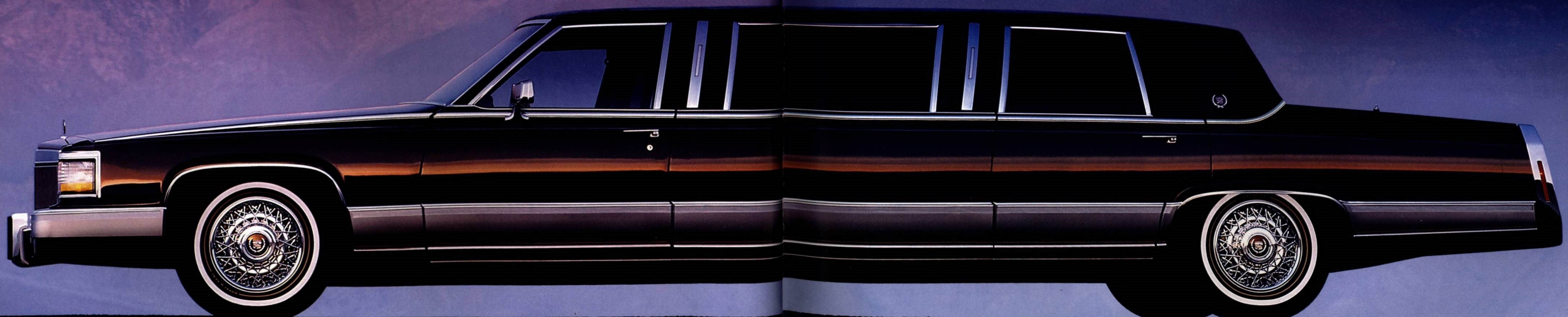

When the premium coachbuilders set out to build custom limousines of unparalleled distinction, they look to Cadillac. With the timeless elegance of an American classic. And a level of comfort and convenience that has become legendary.

All limousines are available through manufacturers, retailers and establishments that are not part of the Cadillac Motor Car Division.

Availability, price and quality of these items rest solely with the respective manufacturers and their sales organizations.

Every 1991 Cadillac offers premium sound, standard.

Radios in front-drive Cadillacs offer seven station presets per band with only four pushbuttons. Allanté offers nine presets per band using five pushbuttons. In Fleetwood, De Ville, Eldorado and Seville, a five-band graphic equalizer lets you tailor the sound to your preference. Brougham offers the sophisticated convenience of five automatic tone control presets for effortless listening.

You can select compact disc playback for even greater sonic realism, standard in Allanté and available in every Cadillac.

Delco/Bose Gold Series sound systems, standard in Allanté (called 200 Series) and available in every front-drive Cadillac, offer you up to 200 watts total power and custom equalization matched precisely to your Cadillac's interior.

No matter which sound system you select, you get extraordinary technology that makes operation simple.

*Receives C-Quam® stereo broadcasts. Most AM stereo stations across the country broadcast in C-Quam® but some do not. Check with your local stations for compatibility in your area.



Delco/Bose Gold Series sound system offers compact disc realism, seek/scan AM stereo*/FM stereo radio, and is custom-equalized for each interior. Available for all front-drive Cadillacs except Allanté.



Delco/Bose Gold Series sound system offers seek/scan AM/FM stereo radio, full-featured auto-reverse cassette tape, and is custom-equalized for each interior. Available for all front-drive Cadillacs except Allanté.



Fleetwood, De Ville, Eldorado and Seville standard premium sound system. Seek/scan AM stereo*/FM stereo radio and full-featured auto-reverse cassette tape for three kinds of stereo. Seven-station pushbutton tuning on each radio band. Five-band graphic equalizer.



New Brougham available Delco premium sound system now includes both compact disc realism and full-featured auto-reverse cassette tape along with seek up-down/scan up-down AM stereo*/FM stereo radio and five automatic tone control presets. Powerful amplifiers, door-mounted front speakers and large rear speakers enhance sound.



Brougham's standard Delco seek up-down/scan up-down AM stereo*/FM stereo radio, full-featured auto-reverse cassette tape, and five automatic tone control presets. Advanced technology makes it easy to operate.

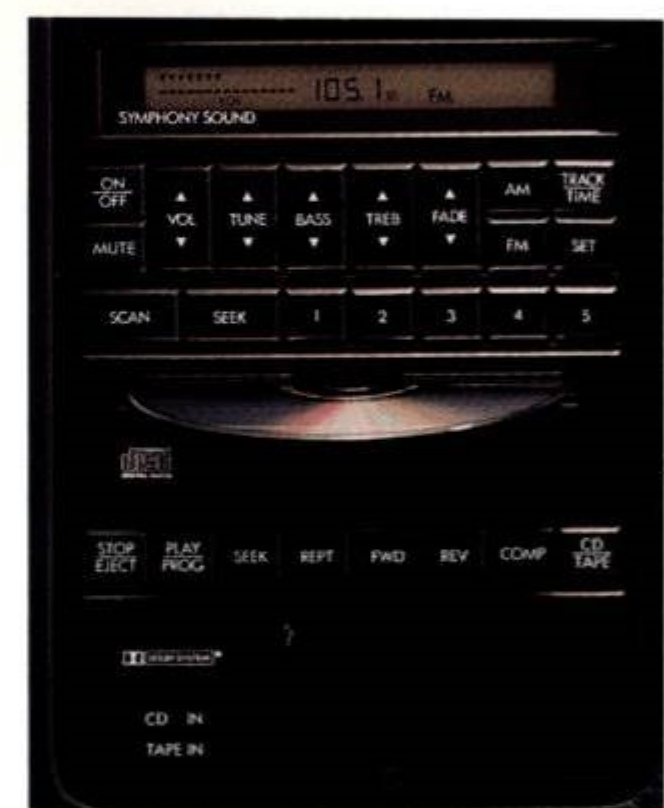

Allanté's standard Delco/Bose 200 Series sound system. Now twice the power (200 watts total) for greater clarity at higher listening levels. Features both compact disc realism and full-featured auto-reverse cassette tape along with AM stereo*/FM stereo radio, and is custom-equalized for the interior.

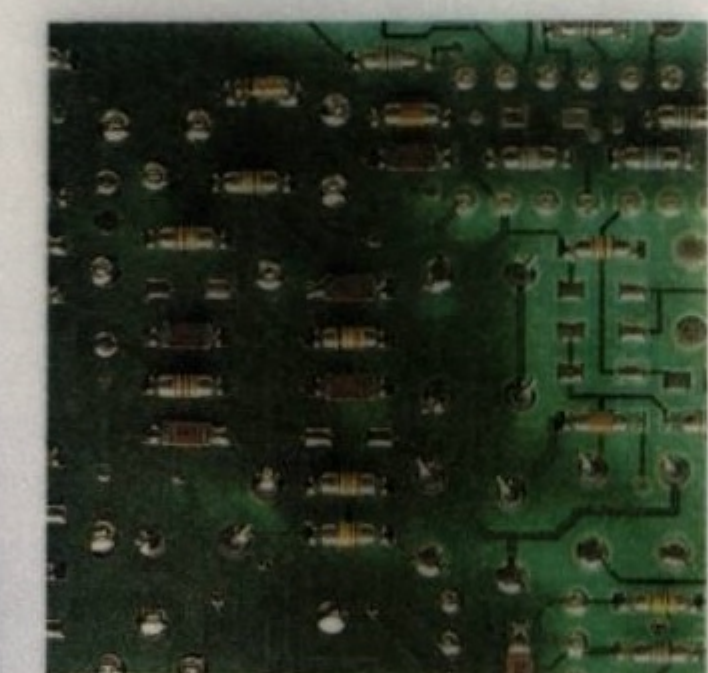
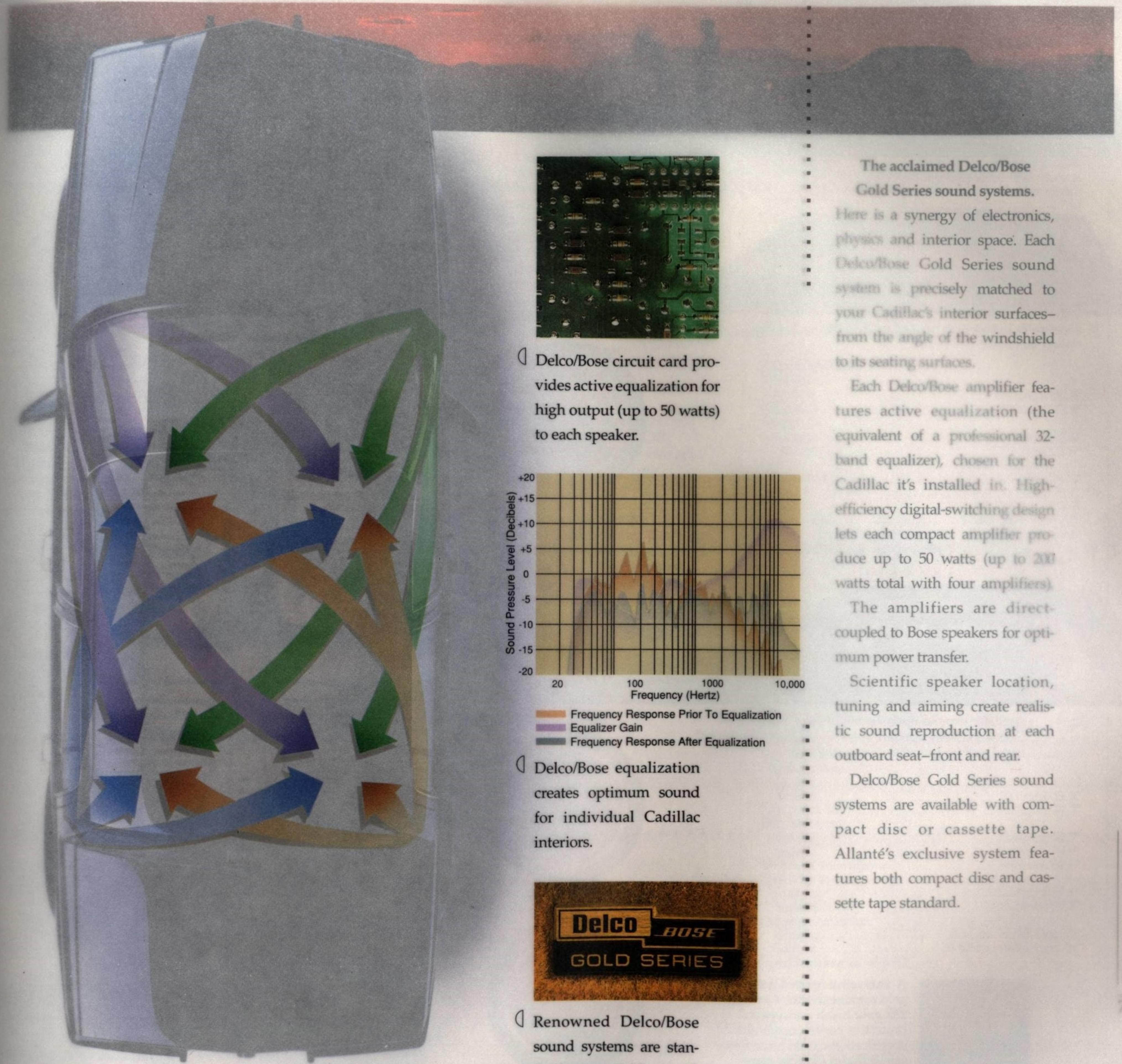

Delco/Bose circuit card provides active equalization for high output (up to 50 watts) to each speaker.

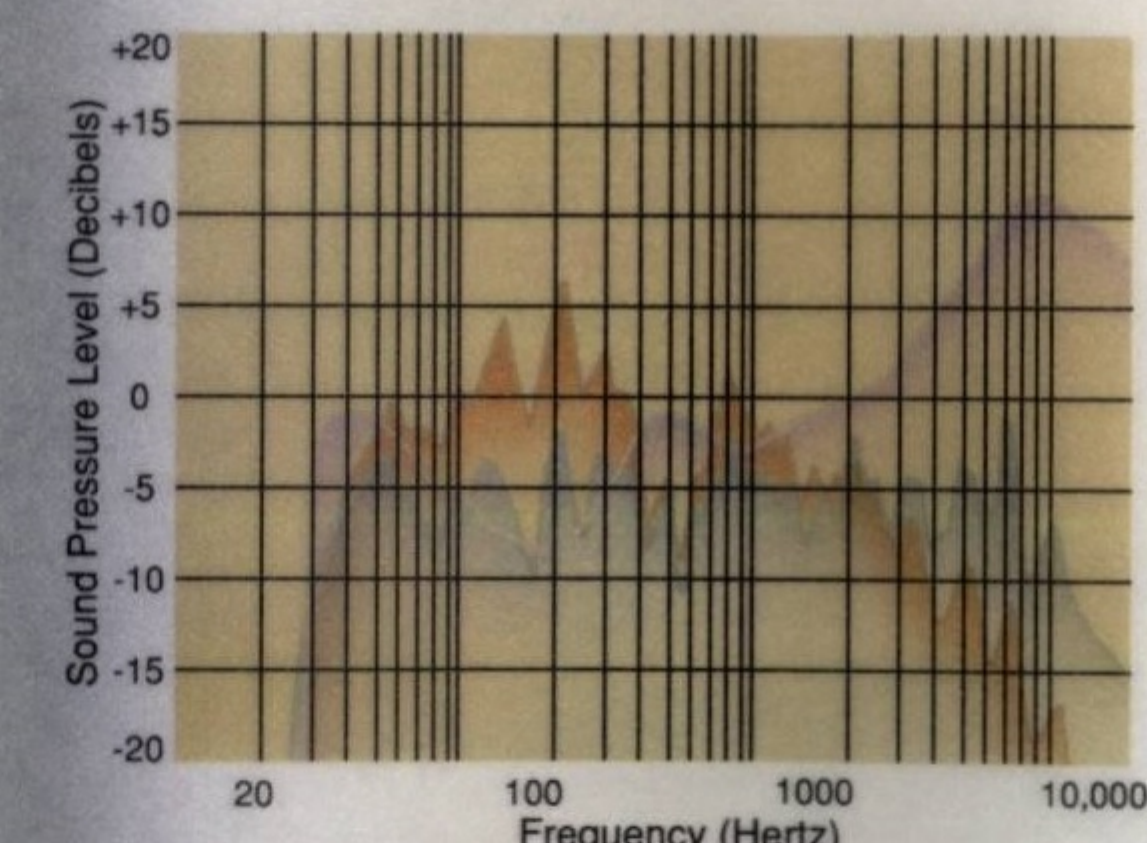

Frequency Response Prior To Equalization
Equalizer Gain
Frequency Response After Equalization

Delco/Bose equalization creates optimum sound for individual Cadillac interiors.



Renowned Delco/Bose sound systems are standard or available on all front-drive Cadillacs.

The acclaimed Delco/Bose Gold Series sound systems.

Here is a synergy of electronics, physics and interior space. Each Delco/Bose Gold Series sound system is precisely matched to your Cadillac's interior surfaces—from the angle of the windshield to its seating surfaces.

Each Delco/Bose amplifier features active equalization (the equivalent of a professional 32-band equalizer), chosen for the Cadillac it's installed in. High-efficiency digital-switching design lets each compact amplifier produce up to 50 watts (up to 200 watts total with four amplifiers).

The amplifiers are direct-coupled to Bose speakers for optimum power transfer.

Scientific speaker location, tuning and aiming create realistic sound reproduction at each outboard seat—front and rear.

Delco/Bose Gold Series sound systems are available with compact disc or cassette tape. Allanté's exclusive system features both compact disc and cassette tape standard.

Every 1991 Cadillac offers premium sound, standard.

Radios in front-drive Cadillacs offer seven station presets per band with only four pushbuttons. Allanté offers nine presets per band using five pushbuttons. In Fleetwood, De Ville, Eldorado and Seville, a five-band graphic equalizer lets you tailor the sound to your preference. Brougham offers the sophisticated convenience of five automatic tone control presets for effortless listening.

You can select compact disc playback for even greater sonic realism, standard in Allanté and available in every Cadillac.

Delco/Bose Gold Series sound systems, standard in Allanté (called 200 Series) and available in every front-drive Cadillac, offer you up to 200 watts total power and custom equalization matched precisely to your Cadillac's interior.

No matter which sound system you select, you get extraordinary technology that makes operation simple.

*Receives C-Quam® stereo broadcasts. Most AM stereo stations across the country broadcast in C-Quam® but some do not. Check with your local stations for compatibility in your area.



Delco/Bose Gold Series compact disc stereo offers compact disc realism and AM stereo*/FM stereo for each interior. Available on all front-drive Cadillacs except Allanté.

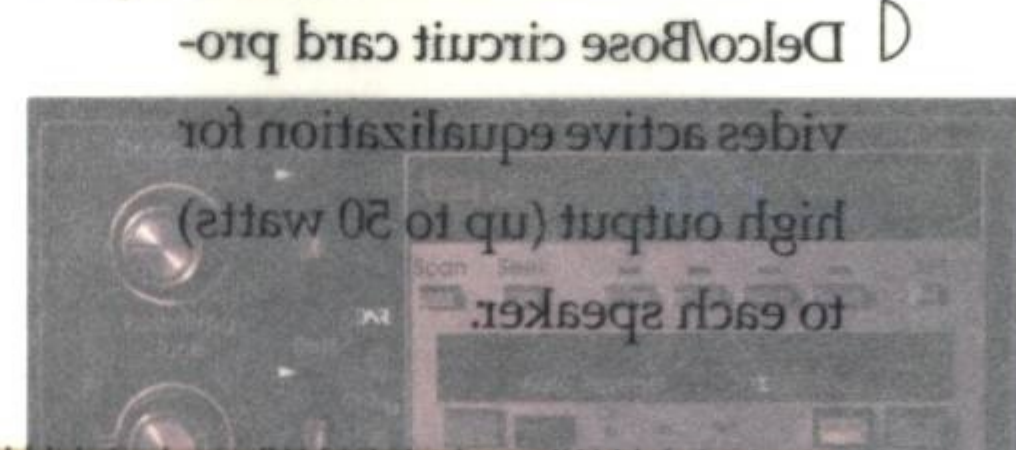

Delco/Bose Gold Series auto-reverse cassette stereo offers compact disc realism and AM stereo*/FM stereo for each interior. Available on all front-drive Cadillacs except Allanté.



Delco/Bose Gold Series five-band graphic equalizer offers custom equalization for each interior. Available on all front-drive Cadillacs except Allanté.

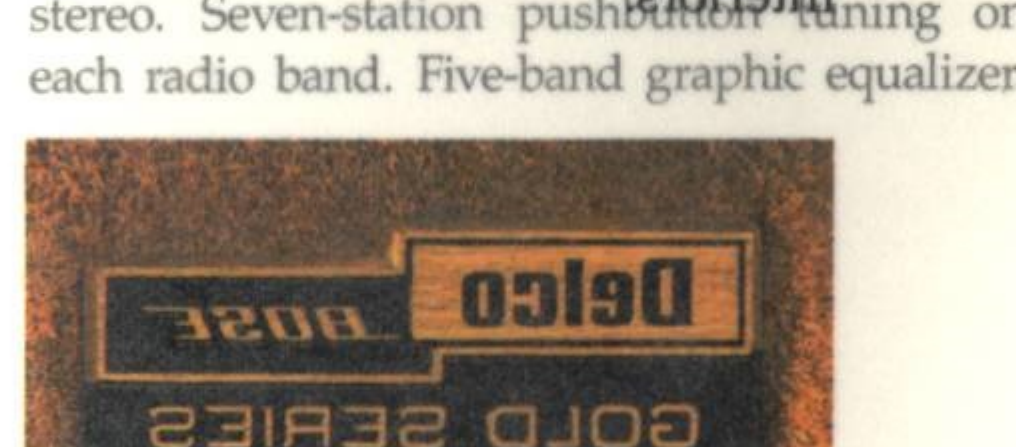

Delco/Bose 200 Series stereo offers compact disc realism and AM stereo*/FM stereo for each interior. Available on all front-drive Cadillacs.



New Brougham available Delco premium sound system now includes both compact disc realism and full-featured auto-reverse cassette tape along with seek up-down/scan up-down AM stereo*/FM stereo radio and five automatic tone control presets. Powerful amplifiers, door-mounted front speakers and large rear speakers enhance sound.

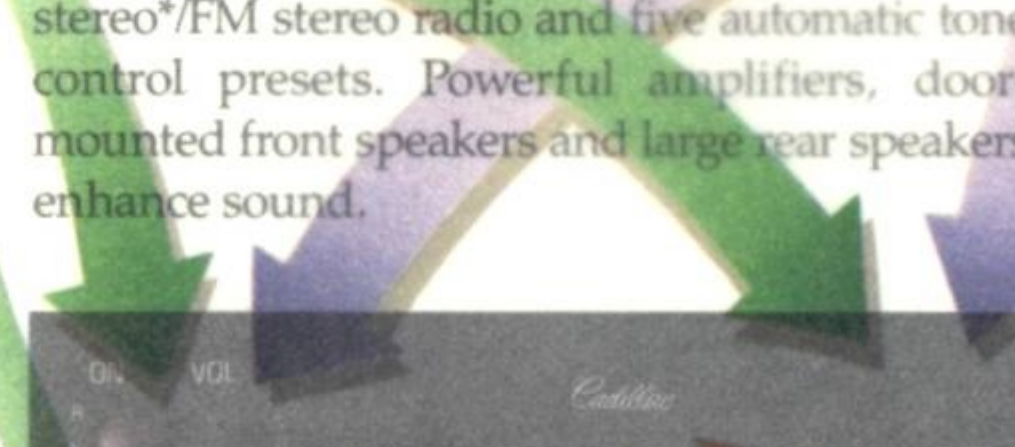

Brougham's standard Delco seek up-down/scan up-down AM stereo*/FM stereo radio, full-featured auto-reverse cassette tape, and five automatic tone control presets. Advanced technology makes it easy to operate.

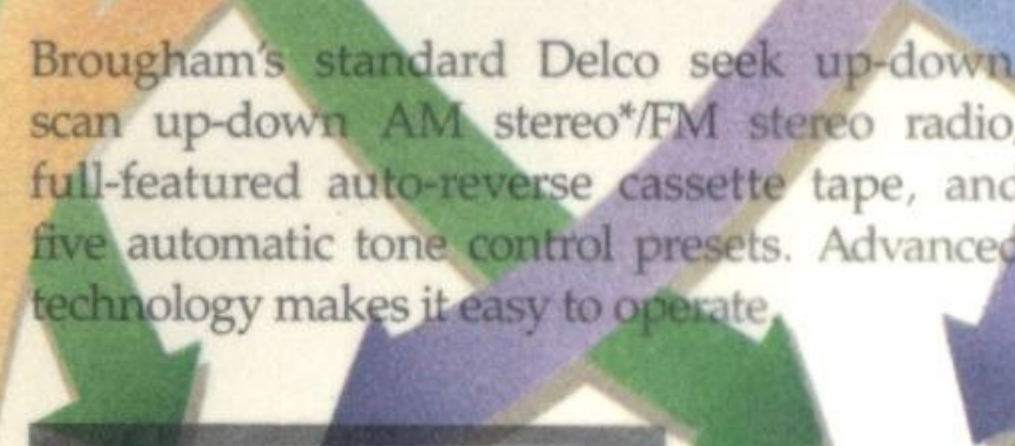

Allanté's standard Delco/Bose 200 Series sound system. Now twice the power (200 watts total) for greater clarity at higher listening levels. Features both compact disc realism and full-featured auto-reverse cassette tape along with AM stereo*/FM stereo radio, and is customized for the interior.



Allanté's standard Delco/Bose 200 Series sound system. Now twice the power (200 watts total) for greater clarity at higher listening levels. Features both compact disc realism and full-featured auto-reverse cassette tape along with AM stereo*/FM stereo radio, and is customized for the interior.



The acclaimed Delco/Bose Gold Series sound systems.

Here is a synergy of electronics, physics and interior space. Each Delco/Bose Gold Series sound system is precisely matched to your Cadillac's interior surfaces—from the angle of the windshield to its seating surfaces.

Each Delco/Bose amplifier features active equalization (the equivalent of a professional 32-band equalizer), chosen for the Cadillac it's installed in. High-efficiency digital-switching design lets each compact amplifier produce up to 50 watts (up to 200 watts total with four amplifiers).

The amplifiers are direct-coupled to Bose speakers for optimum power transfer.

Scientific speaker location, tuning and aiming create realistic sound reproduction at each outboard seat—front and rear.

Delco/Bose Gold Series sound systems are available with compact disc or cassette tape. Allanté's exclusive system features both compact disc and cassette tape standard.

1991 FLEETWOOD® STANDARD FEATURES



Standard sedan full padded roof with electroluminescent wreath and crest (may be deleted from Fleetwood Sedan and Fleetwood Sixty Special)



Standard formal cabriolet roof—Fleetwood Coupe only



• Standard 15"x6" aluminum alloy wheel

FLEETWOOD® AVAILABLE FEATURES



• Available express-open Astrorof (now available on Fleetwood Sixty Special); shown with available painted metal roof (reduces headroom slightly)



• Available lace-look 15"x6" aluminum alloy wheel



Available 15" wire wheel disc



A distinctive touch: Cadillac gold ornamentation. Genuine 23K gold finish with special protective coating meets all GM specifications. Gold ornamentation includes Cadillac name, symbols and Fleetwood identification.

CADILLACS OFFERED IN THIS SERIES

MODEL	COUPE	SEDAN
Fleetwood	●	●
Fleetwood Sixty Special		●

STANDARD FEATURES

• INDICATES NEW STANDARD AND AVAILABLE FEATURES

CADILLAC-EXCLUSIVE TOTAL OWNERSHIP PRIORITY SERVICES†:

- Cadillac Consumer Relations Center—24-hour toll-free assistance, 365 days a year
- Gold Key delivery system
- Cadillac Roadside Service®—professional help is a toll-free call away (1-800-882-1112), 24 hours a day, 365 days a year. You get on-the-spot assistance nights, weekends and holidays

Cadillac's 4-year/50,000-mile Gold Key Bumper to Bumper warranty* and 6-year/100,000-mile rust-through protection. There is no deductible

*See your dealer for terms and conditions of this limited warranty.

†For additional information, please see pp 14-15.

COMFORT AND CONVENIENCE

- Air distribution duct, rear seat—with direction and shut-off control
- Door locks, automatic—with central door unlocking from driver door and luggage compartment

AVAILABLE FEATURES

Available option packages that you may order:

- Custom seating package (standard on Fleetwood Sixty Special):
Recliner, power—driver seat
Recliner, power—front passenger seat
Seat, memory—driver
- Fleetwood security package:
Remote keyless entry system
Theft-deterrent system

- EZ-KOOL™ solar control glass
- Mirror, inside rearview, automatic dimming—Electrochromic
- Mirrors, illuminated—driver and passenger visors, with variable intensity lighting
- Solar sensor—two-way electronic
- Visors, padded dual sun—with extensions
- Body computer module
- Climate control, electronic
- Garage door opener transmitter retainer
- Lamp monitors—front and rear
- Mirrors, rear vanity—illuminated (sedans)
- Retained accessory power

SEATING/INTERIOR

- Armrest, front-seat storage
- Seats, Esteem knit cloth
- Armrest, rear-seat—center
- Floor carpet
- Floor mats, front and rear, carpeted
- Seats: six-passenger, dual-comfort 45/55 split front (three-passenger); six-way power seat adjuster (driver & passenger); manual seatback recliners; rear-seat integral headrests (sedans); front seatback pockets
- Storage—rear package shelf (sedans)

MUSIC SYSTEM

- Delco sound system: AM stereo** (with expanded tuning)/FM stereo radio with auto-reverse cassette tape player, five-band graphic equalizer and six speakers
- Antenna, power

**Please see page 72.

Available features that you may order individually:

SEATING/INTERIOR

Seating areas, leather

MUSIC SYSTEMS

- Delco/Bose Gold Series sound system: AM stereo** (with expanded tuning)/FM stereo radio with compact disc player; custom-equalized for Fleetwood interior

CONTROLS AND INSTRUMENTATION

- Defogger, electric rear window
- Windshield wiper, controlled-cycle
- Clock, digital (in radio)
- Computer diagnostics
- Cruise control
- Defogger, front side windows
- Door locks—power
- Fuel data center
- Fuel filler door release—power
- Fuel gauge—digital
- Illuminated entry system
- Indicators, low brake fluid, low fuel, low windshield washer fluid level
- Instrument cluster, digital
- Lock-only switches, rear door (sedans)—power
- Luggage compartment lid release and pull-down—power
- Mirrors, heated outside rearview—power
- Reading lamps, rear-seat
- Steering wheel, tilt—leather-trimmed rim
- Trip odometer—push-to-reset
- Turn signal lever, multifunction—with wipe-wash, high-low beam and cruise controls
- Twilight sentinel
- Window, express-down, driver—power
- Windows—power

APPEARANCE AND PROTECTION

- Brake/transmission shift interlock (apply brake pedal to shift from park)
- Child safety lockout, front/rear window, driver-controlled—power

Delco/Bose Gold Series sound system: AM/FM stereo radio with auto-reverse cassette tape player; custom-equalized for Fleetwood interior

**Please see page 72.

APPEARANCE AND PROTECTION

Gold ornamentation
Paint, Firemist

- Child safety belt restraint—front and rear passenger seats
- Child safety lockout, rear door (sedans)—manual
- Interior trim, darker high-gloss American walnut wood
- Structural enhancements for improved crashworthiness
- Styling enhancements
Cornering lamps, front
- Door edge guards
- Fender skirts, rear wheel
- Galvanized steel, two-sided, and polymer composites in body and underbody panels
- Headlamps, composite tungsten-halogen
- Keys, body and ignition, 23K gold-finish
- Luggage compartment, carpeted
- Mat, luggage compartment
- Paint finish—clearcoat
- Safety belts, lap/shoulder: driver, front-passenger and outboard rear-seat positions
- Safety glass: laminated windshield, tempered side and rear glass
- Sill treatment, luggage compartment
- Spare tire cover
- Stop lamp, center high-mounted
- Supplemental Inflatable Restraint (air bag) in steering wheel hub
- Theft-deterrent system, PASS Key®
- Wreath and crest, electroluminescent—on sail panel (sedans)

ENGINE/CHASSIS

- 4.9 liter V8 with sequential port fuel injection

- Alternator, 140-ampere
- Computer Command Ride
- Oil life indicator
- Transmission, automatic four-speed with electronic shift control, overdrive and Cadillac-exclusive viscous converter clutch
- Wheels, 15"x6" aluminum alloy
Anti-lock brake system
Battery, heavy-duty—Delco Freedom® III
Exhaust system, stainless steel—from manifold back
Front-wheel drive
Integral body-frame
Parking brake release, automatic
Spare tire—compact

FLEETWOOD SIXTY SPECIAL

Additional standard features: SEATING/INTERIOR

- Driver seat, memory—two settings plus exit setting
- Seats: exclusive 22-way split-frame 45/55 dual front power seats and headrests; heated front seatbacks and cushions; ultra-soft leather seating areas (including headrests and center armrest). Exclusive Ital/Giugiaro design

APPEARANCE AND PROTECTION

- Deck lid plaque
- Plaque, glove box
- Roof—full padded or painted

SPECIFICATIONS

1991 FLEETWOOD

Engine	4.9 liter V8 with sequential port fuel injection
Power	200 bhp @ 4100 rpm
Torque	275 lbs.-ft. @ 3000 rpm
Recommended fuel/tank capacity	Unleaded premium/18.0 gallons usable
Transmission	Four-speed automatic with electronic shift control, overdrive and viscous converter clutch
Final drive ratio (effective)	2.73:1
Suspension	Computer Command Ride; fully independent with Superlift rear electronic level control
Steering	Power-assisted rack and pinion; 18.6:1 ratio
Brakes	Teves Mk IV-3 anti-lock; power front disc/rear drum
Wheels	15"x6" aluminum alloy
Tires	P205/70R15 Michelin steel-belted all-seasons whitewall radials

DIMENSIONS

Wheelbase	2815mm/110.8"
Coupe	2890mm/113.8"
Sedans	2890mm/113.8"
Length	5148mm/202.6"
Coupe	5223mm/205.6"
Sedans	5223mm/205.6"
Height	1394mm/54.9"
Coupe	1401mm/55.2"
Sedans	1401mm/55.2"
Width	1863mm/73.3"
Tread width	Front 1532mm/60.3"
	Rear 1518mm/59.8"
Turning diameter (curb-to-curb)	12.4m/40.7'
Coupe	12.5m/41.0'
Sedans	12.5m/41.0'
Turning diameter (wall-to-wall)	13.1m/42.9'
Coupe	13.4m/44.0'
Sedans	13.4m/44.0'
Curb weight	1631kg/3545.7 lbs.
Fleetwood Coupe	1678kg/3699.4 lbs.
Fleetwood Sedan	1697kg/3741.2 lbs.
Fleetwood Sixty Special	1697kg/3741.2 lbs.
Seating capacities (front and rear)	3/3
Headroom front	997mm/39.3"
Headroom rear	964mm/37.9"
Coupe	970mm/38.2"
Sedans	970mm/38.2"
Legroom front	1067mm/42.0"
Legroom rear	1023mm/40.3"
Coupe	1101mm/43.3"
Sedans	1101mm/43.3"
Hip room front	1376mm/54.2"
Hip room rear	1338mm/52.7"
Coupe	1369mm/53.9"
Sedans	1369mm/53.9"
Shoulder room front	1499mm/59.0"
Shoulder room rear	1464mm/57.6"
Coupe	1506mm/59.3"
Sedans	1506mm/59.3"
Luggage capacity	0.51 cu. m/18.1 cu. ft.
Coupe	0.52 cu. m/18.4 cu. ft.
Sedans	0.52 cu. m/18.4 cu. ft.

Specifications as of 8-90

1991 DE VILLE SELECTED STANDARD FEATURES



Standard painted metal roof shown with available express-open Astrorooft (reduces headroom slightly)



Standard 15"x6" fine-look aluminum alloy wheel

1991 DE VILLE SELECTED AVAILABLE FEATURES



Available full padded roof—Sedan de Ville—with electro-luminescent wreath and crest ornaments on sail panel



Available formal cabriolet roof—Coupe de Ville only



Available full cabriolet roof—Sedan and Coupe



A distinctive touch: Cadillac gold ornamentation. Genuine 23K gold finish with special protective coating meets all GM specifications. Gold ornamentation includes Cadillac name, symbols and De Ville identification.



Available 15"x6" lace-look aluminum alloy wheel



Available 15" wire wheel disc

CADILLACS OFFERED IN THIS SERIES

MODEL	COUPE	SEDAN
Coupe de Ville®	☐	☐
Sedan de Ville®	☐	☐

STANDARD FEATURES

• INDICATES NEW STANDARD AND AVAILABLE FEATURES

CADILLAC-EXCLUSIVE TOTAL OWNERSHIP PRIORITY SERVICES :

- Cadillac Consumer Relations Center—24-hour toll-free assistance, 365 days a year
- Gold Key delivery system
- Cadillac Roadside Service®—professional help is a toll-free call away (1-800-882-1112), 24 hours a day, 365 days a year. You get on-the-spot assistance nights, weekends and holidays

Cadillac's 4-year/50,000-mile Gold Key Bumper to Bumper warranty* and 6-year/100,000-mile rust-through protection. There is no deductible

*See your dealer for terms and conditions of this limited warranty.

COMFORT AND CONVENIENCE

- Air distribution duct, rear seat—with direction and shut-off control
- Door locks, automatic—with central door unlocking from driver door and luggage compartment
- EZ-KOOL™ solar control glass
- Solar sensor—two-way, electronic
- Visors, padded dual sun—with extensions

AVAILABLE FEATURES

Available option packages that you may order:

De Ville option package 1SB
Floor mats, front—carpeted
Floor mats, rear—carpeted
Seat adjuster, six-way power—passenger

De Ville option package 1SC
(includes package 1SB plus:)
• Mirrors, illuminated—driver and passenger visors, with variable intensity lighting
Luggage compartment lid, power pull-down

Body computer module
Climate control, electronic
Garage door opener transmitter retainer
Lamp monitors—front and rear
Mirrors, driver and passenger visors
Retained accessory power

SEATING/INTERIOR

- Armrest, front-seat storage
- Seats, Esteem knit cloth
- Armrest, rear-seat—center
- Floor carpet
- Seats: six-passenger, dual-comfort 45/55 split front (three-passenger); six-way power seat adjuster (driver); front seatback pockets; driver and passenger seatback recliners (manual); rear-seat integral headrests (sedan)
- Stowage—rear package shelf (sedan)

MUSIC SYSTEM

- Delco sound system: AM stereo** (with expanded tuning)/FM stereo radio with auto-reverse cassette tape player, five-band graphic equalizer and six speakers
- Antenna, power

**Please see page 72.

CONTROLS AND INSTRUMENTATION

- Defogger, electric rear window—with heated outside mirrors
- Twilight sentinel
- Windshield wiper, controlled-cycle
- Clock, digital (in radio)
- Computer diagnostics
- Cruise control
- Defogger, front side windows

Mat, luggage compartment
De Ville option package 1SD
(includes package 1SC plus:)
Fuel filler door release—power
Instrument cluster, digital
Mirror, inside rearview automatic dimming—
Electrochromic
Trumpet horn

Available features that you may order individually:

SEATING/INTERIOR

- Seating areas, white leather
- Seating areas, leather

Door locks—power
Fuel data center
Fuel gauge—digital
Indicators, low brake fluid, low fuel, low windshield washer fluid level
Instrument cluster, analog
Lock-only switches, rear door—power (sedan)
Luggage compartment lid release—power
Mirrors, heated outside rearview—power
Steering wheel, tilt—leather-trimmed rim
Trip odometer—push-to-reset
Turn signal lever, multifunction—with wipe-wash, high-low beam and cruise controls
Window, express-down, driver—power
Windows—power

APPEARANCE AND PROTECTION

- Accent striping—side and deck lid
- Brake/transmission shift interlock (apply brake pedal to shift from park)
- Child safety belt restraint—front and rear passenger seats
- Child safety lockout, front/rear window, driver-controlled—power
- Child safety lockout, rear door (sedans) manual
- Structural enhancements for improved crashworthiness
- Styling enhancements
Cornering lamps, front
Door-edge guards
Galvanized steel, two-sided, and polymer composites in body and underbody panels

MUSIC SYSTEMS

- Delco/Bose Gold Series sound system: AM stereo** (with expanded tuning)/FM stereo radio with compact disc player; custom-equalized for De Ville interior
- Delco/Bose Gold Series sound system: AM/FM stereo radio with auto-reverse cassette tape player; custom-equalized for De Ville interior

**Please see page 72.

Headlamps, composite tungsten-halogen
Keys, body and ignition, 23K gold-finish
Luggage compartment, carpeted
Paint finish—clearcoat
Safety belts, lap/shoulder: driver, front-passenger and outboard rear-seat positions
Safety glass: laminated windshield, tempered side and rear glass
Spare tire cover
Stop lamp, center high-mounted
Supplemental Inflatable Restraint (air bag) in steering wheel hub
Theft-deterrent system, PASS Key®

ENGINE/CHASSIS

- 4.9 liter V8 with sequential port fuel injection
- Alternator, 140-ampere
- Anti-lock brake system
- Oil life indicator
- Transmission, automatic four-speed with electronic shift control, overdrive and Cadillac-exclusive viscous converter clutch
- Wheels, 15"x6" cast aluminum alloy
- Battery—Delco Freedom® II
- Exhaust system, stainless steel—from manifold back
- Front-wheel drive
- Integral body-frame
- Parking brake release, automatic
- Spare tire—compact

APPEARANCE AND PROTECTION

- Security package includes remote keyless entry, illuminated entry, and theft-deterrent system
- Gold ornamentation
- Paint, Firemist

ENGINE/CHASSIS

- Computer Command Ride Coachbuilder limousine conversion package
- Livery package, heavy-duty (sedan)

SPECIFICATIONS

1991 DE VILLE

Engine.....4.9 liter V8 with sequential port fuel injection
Power.....200 bhp @ 4100 rpm
Torque.....275 lbs.-ft. @ 3000 rpm
Recommended fuel/tank capacity.....Unleaded premium/18.0 gallons usable
Transmission.....Four-speed automatic with electronic shift control, overdrive and viscous converter clutch
Final drive ratio (effective).....2.73:1
Suspension.....Fully independent with Superlift rear electronic level control
Steering.....Power-assisted rack and pinion; 18.6:1 ratio
Brakes.....Teves Mk IV-3 anti-lock; power front disc/rear drum
Wheels.....15"x6" aluminum alloy
Tires.....P205/70R15 Michelin steel-belted all-seasons whitewall radials

DIMENSIONS

Wheelbase
Coupe de Ville.....2815mm/110.8"
Sedan de Ville.....2890mm/113.8"
Length
Coupe de Ville.....5148mm/202.6"
Sedan de Ville.....5223mm/205.6"
Height
Coupe de Ville.....1394mm/54.9"
Sedan de Ville.....1401mm/55.2"
Width.....1842mm/72.5"
Tread width.....Front 1532mm/60.3"
Rear 1518mm/59.8"
Turning diameter (curb-to-curb)
Coupe de Ville.....12.4m/40.7'
Sedan de Ville.....12.5m/41.0'
Turning diameter (wall-to-wall)
Coupe de Ville.....13.1m/42.9'
Sedan de Ville.....13.4m/44.0'
Curb weight
Coupe de Ville.....1608kg/3545.0 lbs.
Sedan de Ville.....1643kg/3622.2 lbs.
Seating capacities (front and rear).....3/3
Headroom front.....997mm/39.3"
Headroom rear
Coupe de Ville.....964mm/37.9"
Sedan de Ville.....970mm/38.2"
Legroom front.....1067mm/42.0"
Legroom rear
Coupe de Ville.....1023mm/40.3"
Sedan de Ville.....1101mm/43.3"
Hip room front.....1376mm/54.2"
Hip room rear
Coupe de Ville.....1338mm/52.7"
Sedan de Ville.....1369mm/53.9"
Shoulder room front.....1499mm/59.0"
Shoulder room rear
Coupe de Ville.....1464mm/57.6"
Sedan de Ville.....1506mm/59.3"
Luggage capacity
Coupe de Ville.....0.51 cu. m/18.1 cu. ft.
Sedan de Ville.....0.52 cu. m/18.4 cu. ft.
Specifications as of 8-90

1991 ELDORADO® SELECTED STANDARD FEATURES



Standard painted metal roof (not available on Eldorado Biarritz)



Standard formal cabriolet padded roof with opera lamps for Eldorado Biarritz. Shown with available Astrorooft¹ (reduces headroom slightly)



Standard interior with Mayfair cloth-and-leather seating areas.



Standard 15"x6" aluminum alloy "snowflake" wheel



Standard 16"x7" exclusive diamond-finish alloy wheels—Eldorado Touring Coupe

1991 ELDORADO® SELECTED AVAILABLE FEATURES



Available full cabriolet roof for Eldorado (not available on Eldorado Biarritz or Eldorado Touring Coupe)



Available full-padded roof for Eldorado (not available on Biarritz or Eldorado Touring Coupe)

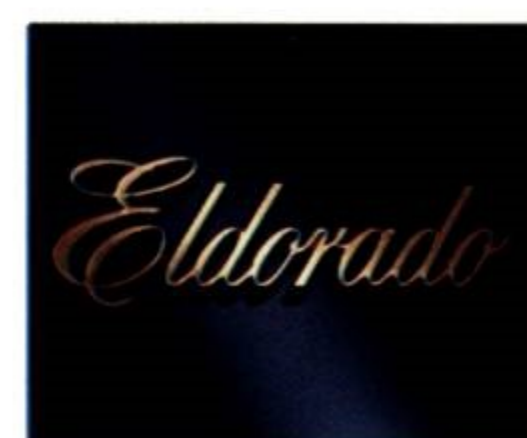

A distinctive touch: Cadillac gold ornamentation. Genuine 23K gold finish with special protective coating meets all GM specifications. Gold ornamentation includes Cadillac name, symbols and Eldorado identification. (Not available on Eldorado Touring Coupe.)



Available 15"x6" aluminum alloy wheel (not available with touring suspension or Eldorado Touring Coupe)



Available 15" wire wheel disc (standard on Biarritz, not available with touring suspension or Eldorado Touring Coupe)

CADILLACS OFFERED IN THIS SERIES

MODEL	COUPE
Eldorado	☐
Eldorado Biarritz	☐
Eldorado Touring Coupe	☐

STANDARD FEATURES

• INDICATES NEW STANDARD AND AVAILABLE FEATURES

CADILLAC-EXCLUSIVE TOTAL OWNERSHIP PRIORITY SERVICES:

- Cadillac Consumer Relations Center—24-hour toll-free assistance, 365 days a year
- Gold Key delivery system
- Cadillac Roadside Service®—professional help is a toll-free call away (1-800-882-1112), 24 hours a day, 365 days a year. You get on-the-spot assistance nights, weekends and holidays

Cadillac's 4-year/50,000-mile Gold Key Bumper to Bumper warranty* and 6-year/100,000-mile rust-through protection. There is no deductible

*See your dealer for terms and conditions of this limited warranty.

COMFORT AND CONVENIENCE

- Acoustic treatment enhances interior quietness
- Body computer module
- Climate control, electronic
- Lamp monitors—front and rear
- Mirrors, illuminated—driver and passenger visors
- Retained accessory power
- Visors, padded dual sun—with adjustable sunshades
- Windows—Soft Ray tinted glass

SEATING/INTERIOR

- Armrests—front- and rear-seat, center
- Assist handles
- Console, front floor—stowage
- Console, overhead—with reading lamps
- Floor carpet—Tiffany
- Floor mats, front and rear—carpeted
- Seats: five-passenger; front bucket with lateral and lumbar support (driver and passenger); six-way power seat adjuster; manual front seat recliners; Mayfair cloth and leather combination seating areas; front-seat adjustable headrests

- Seats: five-passenger; front bucket with lateral and lumbar support (driver and passenger); six-way power seat adjuster; manual front seat recliners; Mayfair cloth and leather combination seating areas; front-seat adjustable headrests

MUSIC SYSTEM

- Antenna, power
- Delco sound system: AM stereo**/FM stereo radio with auto-reverse cassette tape player and five-band graphic equalizer

**Please see page 72.

CONTROLS AND INSTRUMENTATION

- Windshield wiper, controlled-cycle—with fluidic washer

AVAILABLE FEATURES

Available features that you may order individually:

COMFORT AND CONVENIENCE

- Mirror, inside rearview, automatic dimming—Electrochromic (standard on Touring Coupe)

MUSIC SYSTEMS

- Delco/Bose Gold Series sound system:¹ AM/FM stereo radio

- Clock, digital display
- Computer diagnostics
- Cruise control
- Defogger, electric rear window
- Defogger, front side windows
- Door locks—power
- Driver information center
- Fuel filler door release—power
- Illuminated entry system
- Indicators, low brake fluid, low windshield washer fluid level
- Instrument cluster, digital
- Luggage compartment lid release and pull-down—power
- Mirrors, heated outside rearview—power
- Steering wheel, tilt—leather-trimmed rim
- Trip odometer—push-to-reset
- Twilight sentinel
- Window, express-down, driver—power
- Windows—power

APPEARANCE AND PROTECTION

- Composite tungsten-halogen headlamps
- Cornering lamps, front
- Galvanized steel, two-sided, in all body and underbody panels (except roof)
- Luggage compartment, carpeted
- Mat, luggage compartment
- Paint finish—clearcoat
- Safety belts, lap/shoulder: driver, front-passenger and outboard rear-seat positions
- Safety glass: laminated windshield, tempered side and rear glass
- Spare tire cover
- Stop lamp, center high-mounted
- Supplemental Inflatable Restraint (air bag) in steering wheel hub

- with auto-reverse cassette tape player; custom-equalized for Eldorado interior

- Delco/Bose Gold Series sound system:¹ AM stereo**/FM stereo radio with compact disc player; custom-equalized for Eldorado interior

SEATING/INTERIOR

- Interior trim, high-gloss Birdseye maple wood (standard on Eldorado Biarritz and Eldorado Touring Coupe)

- Theft-deterrent system, PASS Key®

ENGINE/CHASSIS

- 4.9 liter V8 with sequential port fuel injection
- Alternator, 140-ampere
- Anti-lock brake system
- Computer Command Ride
- Transmission, automatic four-speed with electronic shift control, overdrive and Cadillac-exclusive viscous converter clutch
- Battery—Delco Freedom® II
- Exhaust system, stainless steel—from manifold back
- Front-wheel drive
- Integral body-frame
- Oil-life indicator
- Parking brake release, automatic
- Spare tire—compact

ELDORADO BIARRITZ

Additional standard features:

SEATING/INTERIOR

- Floor carpet—Tampico
- Floor mats, front and rear, carpeted—Tampico
- Interior trim, instrument panel and console, high-gloss Birdseye maple wood
- Seats: five-passenger; 10-way power front bucket; with power recliner and lumbar adjusters; manual adjustable headrests (driver and passenger); leather seating areas

APPEARANCE AND PROTECTION

- Biarritz identification
- Paint treatment—two-tone
- Roof, padded cabriolet with opera lamps
- Wire wheel discs

- Seating areas, leather (includes power passenger seat recliner)

**Please see page 72.

APPEARANCE AND PROTECTION

- Security package includes remote keyless entry, automatic door locks with central door unlocking and theft-deterrent systems¹
- Gold ornamentation
- Paint, Firemist

ELDORADO TOURING COUPE

Additional standard features:

SEATING/INTERIOR

- Assist handles
- Floor carpet—Thaxton
- Floor mats, front and rear carpeted—Thaxton
- Headrests, rear seat
- Interior trim, instrument panel and console—high-gloss Birdseye maple wood
- Mirror, inside rearview, automatic dimming—Electrochromic
- Seats: five-passenger; 10-way power front bucket with power recliners and lumbar adjusters; manual articulating headrests; Beechwood ultra-soft leather seats

CONTROLS AND INSTRUMENTATION

- Mirrors, heated outside rearview—power, with blue-tinted glare-resistant glass

APPEARANCE AND PROTECTION

- Deck lid emblem, cloisonné
- Styling enhancements
- Wreath and crest flush-mounted on grille

ENGINE/CHASSIS

- Exhaust outlets, dual—with bright tailpipes
- Tires, Goodyear Eagle P215/60R16 GT + 4 steel-belted radials
- Touring suspension with 3.33:1 effective final drive ratio
- Wheels, Cadillac-exclusive—16"x7" diamond-finish forged aluminum alloy

ENGINE/CHASSIS

- Tires—P215/65R15 whitewall steel-belted radial
- Touring suspension (standard on Eldorado Touring Coupe)

¹One of only four features available for Eldorado Touring Coupe

SPECIFICATIONS

1991 ELDORADO

Engine	4.9 liter V8 with sequential port fuel injection
Power	200 bhp @ 4100 rpm
Torque	275 lbs.-ft. @ 3000 rpm
Recommended fuel/tank capacity	Unleaded premium/18.8 gallons usable
Transmission	Four-speed automatic with electronic shift control, overdrive and viscous converter clutch
Final drive ratio (effective)	
Eldorado, Eldorado Biarritz	2.93:1
Eldorado Touring Coupe	3.33:1
Suspension	
Eldorado, Eldorado Biarritz	Computer Command Ride; fully independent with front stabilizer bar and Superlift rear electronic level control
Eldorado Touring Coupe (and Eldorado with available touring suspension)	Same as above, plus touring version components: larger front plus rear stabilizer bars; firmer front/rear strut valving; higher rate front/rear springs; and suspension bushings
Steering	
Eldorado, Eldorado Biarritz	Power-assisted rack and pinion; 16.5:1 ratio
Eldorado Touring Coupe (and Eldorado with available touring suspension)	Power-assisted rack and pinion; 15.6:1 ratio
Brakes	Bosch IIU® anti-lock; power four-wheel disc
Wheels	
Eldorado	15"x6" snowflake-look aluminum alloy
Eldorado Biarritz	15"x6" steel
Eldorado Touring Coupe	Cadillac-exclusive 16"x7" diamond-finish forged aluminum alloy
Tires	
Eldorado and Eldorado Biarritz	P205/70R15 Michelin steel-belted all-seasons whitewall radials
Eldorado with touring suspension	P215/65R15 Goodyear Eagle GT + 4 steel-belted radials
Eldorado Touring Coupe	P215/60R16 Goodyear Eagle GT + 4 steel-belted radials

DIMENSIONS

Wheelbase	2743mm/108.0"
Length	4862mm/191.4"
Height	1352mm/53.2"
Width	1838mm/72.4"
Tread width	Front 1522mm/59.9" Rear 1522mm/59.9"
Turning diameter (curb-to-curb)	12.0m/39.4'
(wall-to-wall)	12.8m/42.0'
Curb weight	
Eldorado	1570.9kg/3463.2 lbs.
Eldorado Biarritz	1631.3kg/3597.7 lbs.
Eldorado Touring Coupe	1598.1kg/3523.2 lbs.
Seating capacities (front and rear)	2/3
Headroom front	959mm/37.8"
Headroom rear	961mm/37.8"
Legroom front	1076mm/42.4"
Legroom rear	915mm/36.0"
Hip room front	1409mm/55.5"
Hip room rear	1408mm/55.4"
Shoulder room front	1463mm/57.6"
Shoulder room rear	1460mm/57.5"
Luggage capacity	0.40 cu. m/14.1 cu. ft.
Specifications as of 8-90	

1991 SEVILLE® SELECTED STANDARD FEATURES



Standard painted metal roof shown with available Astrorooft (reduces headroom slightly)



Standard 15"x6" lace-look aluminum alloy wheel



Standard 16"x7" exclusive diamond-finish alloy wheels—STS



Standard interior with Mayfair cloth-and-leather seating areas.

1991 SEVILLE® SELECTED AVAILABLE FEATURES



Available Phaeton roof



Available 15"x6" "snowflake" aluminum alloy wheels—Seville (standard with touring suspension)



Available 15" wire wheel disc—Seville (not available with touring suspension or STS)



A distinctive touch: Cadillac gold ornamentation. Genuine 23K gold finish with special protective coating meets all GM specifications. Gold ornamentation includes Cadillac name, symbols and Seville identification. (Not available on STS.)

CADILLACS OFFERED IN THIS SERIES

MODEL	SEDAN
Seville	●
Seville STS	●

STANDARD FEATURES

• INDICATES NEW STANDARD AND AVAILABLE FEATURES

CADILLAC-EXCLUSIVE TOTAL OWNERSHIP PRIORITY SERVICES:

- Cadillac Consumer Relations Center—24-hour toll-free assistance, 365 days a year
- Gold Key delivery system
- Cadillac Roadside Service®—professional help is a toll-free call away (1-800-882-1112), 24 hours a day, 365 days a year. You get on-the-spot assistance nights, weekends and holidays

Cadillac's 4-year/50,000-mile Gold Key Bumper to Bumper warranty* and 6-year/100,000-mile rust-through protection. There is no deductible

*See your dealer for terms and conditions of this limited warranty.

COMFORT AND CONVENIENCE

- Acoustic treatment enhances interior quietness
- Body computer module
- Climate control, electronic
- Lamp monitors—front and rear
- Mirrors, illuminated—driver and passenger visors
- Retained accessory power
- Visors, padded dual sun—with adjustable sunshades
- Windows, Soft Ray tinted glass

SEATING/INTERIOR

Armrests, front and rear seat, center

AVAILABLE FEATURES

Available features that you may order individually:

COMFORT AND CONVENIENCE

Mirror, inside rearview automatic dimming—Electrochromic

SEATING/INTERIOR

Seating areas, leather

Assist handles
Console, front floor—stowage
Console—overhead with reading lamps

Floor carpet, Tampico
Floor mats, front and rear—carpeted

Seats: five-passenger, 10-way front bucket, power (driver and passenger) with recliner and lumbar; manual adjustable headrests; Mayfair cloth and leather combination seating areas

Trim—interior high-gloss
Birdseye maple wood

MUSIC SYSTEM

Antenna, power
Delco sound system: AM stereo**/FM stereo radio with auto-reverse cassette tape player and five-band graphic equalizer

**Please see page 72.

CONTROLS AND INSTRUMENTATION

- Windshield wiper, controlled-cycle—with fluidic washer
- Clock, digital display
- Computer diagnostics
- Cruise control
- Defogger, electric rear window
- Defogger, front side windows
- Door locks—power
- Driver information center
- Fuel filler door release—power
- Illuminated entry system
- Indicators—low brake fluid, low windshield washer fluid level
- Instrument cluster, digital
- Lock-only switches, rear door—power
- Luggage compartment lid release and pull-down—power
- Mirrors, heated, outside rearview—power
- Steering wheel, tilt—leather-trimmed rim

MUSIC SYSTEMS

Delco/Bose Gold Series sound system: AM/FM stereo radio with auto-reverse cassette tape player; custom-equalized for Seville interior
Delco/Bose Gold Series sound system: AM stereo**/FM stereo radio with compact disc player; custom-equalized for Seville interior

**Please see page 72.

Twilight sentinel
Window, express-down, driver—power
Windows—power

APPEARANCE AND PROTECTION

- Cornering lamps, front
- Door-edge guards
- Galvanized steel, two-sided, in all body and underbody panels (except roof)
- Headlamps, composite tungsten-halogen
- Luggage compartment, carpeted
- Mat, luggage compartment
- Paint finish—clearcoat
- Safety belts, lap/shoulder: driver, front-passenger and outboard rear-seat positions
- Safety glass: laminated windshield, tempered side and rear glass
- Spare tire cover
- Stop lamp, center high-mounted
- Supplemental Inflatable Restraint (air bag) in steering wheel hub
- Theft-deterrent system, PASS Key®

ENGINE/CHASSIS

- 4.9 liter V8 with sequential port fuel injection
- Alternator, 140-ampere
- Anti-lock brake system
- Computer Command Ride
- Transmission, automatic four-speed with electronic shift control, overdrive and Cadillac-exclusive viscous converter clutch
- Battery—Delco Freedom® II
- Exhaust system, stainless steel—from manifold back
- Front-wheel drive
- Integral body-frame
- Oil-life indicator
- Parking brake release, automatic
- Spare tire—compact

CONTROLS AND INSTRUMENTATION

- Security package includes remote keyless entry with illuminated entry, automatic door locks with central door unlocking, and theft-deterrent system (standard on STS)

SEVILLE STS

Additional standard features: SEATING/INTERIOR

- Rear-seat, full-width—with headrests, center armrest
- Seats: five-passenger, 10-way power front bucket; Beechwood ultra-soft leather-covered seats and trim
- Floor carpet, Thaxton
- Floor mats, front and rear carpeted—Thaxton with STS logo
- Interior trim, instrument panel—high-gloss elm burl wood
- Pockets, front seatback

CONTROLS AND INSTRUMENTATION

- Mirrors, heated outside rearview—power, with blue-tinted glare-resistant glass
- Security package includes remote keyless entry with illuminated entry, theft-deterrent system and automatic door locks with central door unlocking

APPEARANCE AND PROTECTION

STS identification
STS logo on wheel center cap
Styling enhancements
Wreath and crest flush-mounted on grille

ENGINE/CHASSIS

Exhaust outlets, dual
Tires, Goodyear Eagle P215/60R16 GT + 4 steel-belted radials
Touring suspension with 3.33:1 effective final drive ratio
Wheels, Cadillac-exclusive—16" x 7" diamond-finish forged aluminum alloy

APPEARANCE AND PROTECTION

Gold ornamentation
Paint, Firemist
Paint treatment, two-tone

ENGINE/CHASSIS

Tires—P215/65R15 whitewall steel-belted radial
Touring suspension (standard on STS)

SPECIFICATIONS

1991 SEVILLE

Engine	4.9 liter V8 with sequential port fuel injection
Power	200 bhp @ 4100 rpm
Torque	275 lbs.-ft. @ 3000 rpm
Recommended fuel/tank capacity	Unleaded premium/18.8 gallons usable
Transmission	Four-speed automatic with electronic shift control, overdrive and viscous converter clutch
Final drive ratio (effective)	
Seville	2.93:1
Seville STS	3.33:1
Suspension	
Seville	Computer Command Ride; fully independent with front stabilizer bar and Superlift rear electronic level control
STS (and Seville with available touring suspension)	Same as above, plus larger front plus rear stabilizer bars; firmer front/rear strut valving; higher rate front/rear springs; and suspension bushings
Steering	
Seville	Power-assisted rack and pinion; 16.5:1 ratio
STS (and Seville with available touring suspension)	Power-assisted rack and pinion; 15.6:1 ratio
Brakes	Bosch IIU® anti-lock; power four-wheel disc
Wheels	
Seville	15"x6" lace-look aluminum alloy
STS	16"x7" diamond-finish forged aluminum alloy
Tires	
Seville	P205/70R15 Michelin steel-belted all-seasons whitewall radials
Seville with touring suspension	P215/65R15 Goodyear Eagle GT + 4 steel-belted radials
STS	P215/60R16 Goodyear Eagle GT + 4 steel-belted radials

DIMENSIONS

Wheelbase	2743mm/108.0"
Length	4846mm/190.8"
Height	1352mm/53.2"
Width	1828mm/72.0"
Tread width	Front 1522mm/59.9" Rear 1522mm/59.9"
Turning diameter (curb-to-curb)	12.0m/39.4'
(wall-to-wall)	12.8m/42.0'
Curb weight	
Seville	1592.5kg/3510.9 lbs.
STS	1616.0kg/3562.8 lbs.
Seating capacities (front and rear)	2/3
Headroom front	959mm/37.8"
Headroom rear	962mm/37.9"
Legroom front	1079mm/42.5"
Legroom rear	915mm/36.0"
Hip room front	1410mm/55.5"
Hip room rear	1420mm/55.9"
Shoulder room front	1454mm/57.2"
Shoulder room rear	1454mm/57.2"
Luggage capacity	0.40 cu. m/14.1 cu. ft.
Specifications as of 8-90	

1991 BROUGHAM SELECTED STANDARD FEATURES



- Standard full padded roof with closed-in padded rear vent window Available Astrorooft (reduces headroom slightly)



Standard Brougham Prima Vera cloth interior.



Standard Brougham d'Elegance Prima Vera cloth interior.



Standard 15" wheel disc

BROUGHAM SELECTED AVAILABLE FEATURES



- Trailer towing package—requires 5.7 liter V8 and includes 124-ampere alternator and trailer towing wiring harness—up to 5,000 lbs. towing capacity



Cadillac 23K gold ornamentation. Includes: Cadillac name, symbols and Brougham identification.



Available 15" genuine wire wheel



Available 15" wire wheel disc

CADILLACS OFFERED IN THIS SERIES

MODEL	SEDAN
Brougham	●
Brougham d'Elegance	●

STANDARD FEATURES

INDICATES NEW STANDARD AND AVAILABLE FEATURES

CADILLAC-EXCLUSIVE TOTAL OWNERSHIP PRIORITY SERVICES:

- Cadillac Consumer Relations Center
- Cadillac Roadside Service®
- Cadillac's warranties* Please see pages 14-15.
- Gold Key delivery system

COMFORT AND CONVENIENCE

- Door locks, automatic—with central door unlocking
- Climate control, electronic
- Garage door opener transmitter retainer
- Lamp monitors—front and rear
- Mirror, passenger visor
- Visors, padded dual sun
- Windows, Soft Ray tinted glass

SEATING/INTERIOR

- Reading lamps, rear-seat (adjustable)
- Seats: six-passenger, six-way power seat adjuster (driver & passenger), power seat recliners, dual-comfort 55/45 front seats (three-passenger), adjustable front headrests, front seatback pockets
- Armrest, front, with storage
- Floor mats, front and rear

AVAILABLE FEATURES

Brougham option package 1SB (standard on Brougham d'Elegance)
Luggage compartment lid power pull-down
Mirrors, illuminated, driver and passenger visors
Twilight sentinel

- Brougham option package 1SC** (includes package 1SB plus):
Fuel filler door, remote release
Theft-deterrent system

MUSIC SYSTEM

Antenna, power
Delco sound system: AM stereo**/FM stereo radio with auto-reverse cassette tape player, and five pre-set graphic equalization choices

**Please see page 72.

CONTROLS AND INSTRUMENTATION

- Steering wheel, leather trimmed, tilt-and-telescope
- Clock, digital display
- Cruise control
- Defogger, electric, rear window
- Door locks, power
- Headlight, high-low beam switch
- Illuminated entry system
- Indicators, low fuel, low windshield washer fluid level
- Instrument cluster, digital
- Luggage lid, power release
- Mirrors, power outside rear-view, heated
- Trip odometer—push-to-reset
- Windows, power
- Windshield wipers, controlled cycle

APPEARANCE AND PROTECTION

Door edge guards
Headlamps, composite tungsten-halogen
Keys, 23K gold-finish
Lamps, cornering and opera
Luggage compartment, carpeted
Mat, luggage compartment
Paint finish, clearcoat
Safety glass: laminated windshield, tempered side and rear glass

Available features that you may order individually:

COMFORT AND CONVENIENCE

Mirror, inside rearview, automatic dimming—
Electrochromic

SEATING AND INTERIOR

Seating areas, leather

IMPORTANT WORDS ABOUT...

THIS CATALOG

We have tried to make this catalog as comprehensive and factual as possible. We reserve the right, however, to make changes at any time, without notice, in prices, colors, materials, equipment specifications, models and availability. Since some information may have been updated since the time of printing, please check with your Cadillac dealer for complete details.

ENGINES

Cadillacs are equipped with engines produced by different operating units of GM, its subsidiaries or suppliers to GM worldwide.

ASSEMBLY

Cadillacs are assembled by different operating units of General Motors, its subsidiaries or suppliers to GM worldwide. We sometimes find it necessary to produce Cadillacs with different or differently sourced components than originally scheduled. All such components have been approved for use in Cadillacs and will provide the quality performance associated with the Cadillac name. Since some options may be unavailable when your vehicle is assembled, we suggest that you verify that your vehicle includes the equipment you ordered, or if there are changes, that they are acceptable to you.

MUSIC SYSTEM

- Premium music system: stereo radio with cassette tape and compact disc players; door-mounted speakers

APPEARANCE AND PROTECTION

Gold ornamentation
Paint, Firemist

ENGINE/CHASSIS

- 5.7 liter V8 with throttle-body fuel injection

Stop lamp, center high-mounted
Safety belts, passive door-mounted front lap/shoulder
Safety belts, rear outboard lap/shoulder
Spare tire cover

ENGINE/CHASSIS

- 5.0 liter V8 with throttle-body fuel injection
- Steering, electronic variable assist
- Suspension, single level
- Alternator, 100-ampere
- Anti-lock brake system, Bosch II
- Battery, Delco Freedom® II
- Body-on-frame construction
- Parking brake release, automatic
- Rear-wheel drive
- Spare tire, compact

BROUGHAM D'ELEGANCE

Added standard features:

COMFORT AND CONVENIENCE

Mirrors, illuminated driver and passenger visors

SEATING/INTERIOR

Assist handles, overhead
Seat button trim

CONTROLS AND INSTRUMENTATION

Luggage lid, power pull-down
Twilight sentinel

Let's Get It Together... Buckle Up. 

about Cadillac products.

Cadillac monitors product performance in the field. We then prepare bulletins for servicing our products better. Now you can get these bulletins, too. Ask your dealer. To get ordering information, call toll-free 1-800-551-4123.

FINANCING OR LEASING, IT'S AS EASY AS GMAC®

Financing is done right in the showroom. Terms are tailored to suit your personal needs. You can choose your monthly payment date.

CORROSION PROTECTION

Cadillacs are designed and built to resist corrosion. All body sheet-metal components are warranted against rust-through corrosion for 6 years/100,000 miles. Allanté is covered for 7 years/100,000 miles. There is no deductible for rust-through repairs. Application of additional rust-inhibiting materials is not required *under the corrosion coverage* and none is recommended.

WARRANTY

The GM 4-year/50,000-mile Gold Key Bumper to Bumper limited warranty covers repairs for any new Cadillac, including labor and parts, to correct any defects in material or workmanship occurring during the warranty period. The complete vehicle will be covered for 4 years or 50,000 miles, whichever comes first (except tires, which are covered by their manufacturer, adjustments, normal maintenance items and battery, which is covered by its own 4-year/50,000-mile prorated warranty). The Cadillac Allanté is backed for 7 years/100,000 miles. There is no deductible on any Cadillac warranty. See your Cadillac dealer for terms of these limited warranties.

SPECIFICATIONS

1991 BROUGHAM

ENGINES	
Standard	5.0 liter V8 with throttle-body fuel injection
Power	170 bhp @ 4400 rpm
Torque	255 lbs.-ft. @ 2400 rpm
Available	5.7 liter V8 with throttle-body fuel injection
Power	185 bhp @ 3800 rpm
Torque	300 lbs.-ft. @ 2400 rpm
Fuel tank capacity	25.0 gallons
Transmission	Four-speed automatic with overdrive and torque converter clutch
Rear axle ratio (either engine)	3.08:1
Suspension	Independent front, four-link rear; uprated springs and stabilizer bar; deflected-disc shock absorbers; Superlift rear electronic level control (please check with dealer for availability on cars without trailer towing package ¹)
Steering	Electronic Variable Orifice (EVO) power-assisted recirculating ball; variable 15-13:1 ratio
Brakes	Bosch II anti-lock; power front disc/rear drum
Wheels	15"x7"
Tires	P225/75R15 GM specification puncture-sealing steel-belted all-season whitewall radials

DIMENSIONS

Wheelbase	3085mm/121.5"
Length	5614mm/221.0"
Height	1457mm/57.4"
Width	1942mm/76.5"
Tread width	Front 1568mm/61.7" Rear 1542mm/60.7"

Turning diameter (curb-to-curb)	12.4m/40.5'
(wall-to-wall)	13.4m/44.0'
Curb weight	1942.1kg/4281.6 lbs.
Seating capacities (front and rear)	3/3
Headroom front	991mm/39.0"
Headroom rear	967mm/38.1"
Legroom front	1067mm/42.0"
Legroom rear	1047mm/41.2"
Hip room front	1391mm/54.8"
Hip room rear	1408mm/55.4"
Shoulder room front	1508mm/59.4"
Shoulder room rear	1508mm/59.4"
Luggage capacity	0.55 cu. m/19.6 cu. ft.
Specifications as of 8-90	

¹Standard on Brougham equipped with available trailer towing package

CADILLAC, the CADILLAC emblem, ALLANTÉ, FLEETWOOD, SEVILLE, SEDAN DE VILLE, COUPE DE VILLE, d'ELEGANCE, ELDORADO, CADILLAC ROADSIDE SERVICE, and the GM emblem are registered trademarks of the General Motors Corporation. BIARRITZ, BROUGHAM and THE ONLY WAY TO TRAVEL IS CADILLAC STYLE are trademarks of General Motors Corporation. GMAC is a registered trademark of the General Motors Acceptance Corporation. Litho in U.S.A. 8/90 ©1990 GM CORP. All Rights Reserved.

CADILLAC MOTOR CAR DIVISION