

The 2013 R-Class



Mercedes-Benz
The best or nothing.

The R-Class is the perfect blend of convenience and luxury that is nothing less than artful. Even at first glance, it's clear that this is more than just a roomy Mercedes-Benz. Luxurious interior accommodations, a stylish and sporty exterior, state-of-the-art entertainment and communication capabilities as well as innovative engineering blend together to create a driving experience with unmatched character and sophistication.

The R-Class

DESIGN	2
ENTERTAINMENT & COMMUNICATION	12
AGILITY	14
BlueEFFICIENCY & 4MATIC™	18
SAFETY	20
COLOURS & MATERIALS	22
ACCESSORIES & OWNERSHIP	26
WEBSITE, TEST DRIVE, EQUIPMENT LISTING & TECHNICAL SPECIFICATIONS	28



R 350 BlueTEC 4MATIC™.

Even its looks are enormously impressive.

The bold lines of the exterior create an aggressive and sporty impression. An impression validated by the R-Class' car-like performance. Every detail, from the shape of the door handles to the radiator grille in chrome-accented black is an expression of a subtle, yet sleek design sensibility. And, as with every Mercedes-Benz, where there's form there's function.





R 350 BlueTEC 4MATIC™.



R 350 BlueTEC 4MATIC™.



Handsomely equipped.

The 2013 R-Class is as viscerally pleasing as any Mercedes-Benz should be. Design features include:

- 19" 5-spoke alloy wheels.
- Available AMG 20" 5-spoke alloy wheels.¹
- Dynamic hood, fenders, mirrors and rear bumper.
- Front bumper design with simulated underguard.
- Bi-Xenon headlamps with washers and cornering lights.
- LED daytime running lights.
- LED taillights.
- Panoramic sunroof¹ opens with one touch of the overhead switch.
- Integrated exhaust tips.

¹Available on the R 350 4MATIC™ and R 350 BlueTEC 4MATIC™ as part of an option package.

Never get lost in these eyes.

The aggressive front bumper design with its simulated underguard gives the R-Class its signature sporty look. Situated just above it are the beautiful Bi-Xenon headlamps that seem to stare right back. But they'll do more than that – cornering lights follow your every turn for added safety and visibility, and high-pressure headlamp washers keep your lights clean and clear during inclement weather and dusty road conditions. And LED daytime running lights increase your visibility to other vehicles in an attractive and efficient way.





R 350 BlueTEC 4MATIC™.



R 350 BlueTEC 4MATIC™ interior.

We luxuriously welcome you aboard.

Can smart functionality and sophisticated good looks truly coexist? Inside the R-Class, the answer is a resounding 'yes'. Even your passengers get treated to luxuries you'll only find in a Mercedes-Benz. Features include:

- Available Leather Package featuring luxurious Leather upholstery on seats and front and rear headrests, and Interior Lighting Package.
- Standard 8-way power adjustable heated front seats with 4-way power lumbar support and 3-position memory.
- THERMOTRONIC 3-zone automatic climate control system.¹
- EASY-PACK power tailgate which opens and closes at the push of a button.¹



Adjustable rear seats offering quick and easy access for 3rd row seating.

¹Available on the R 350 4MATIC™ and R 350 BlueTEC 4MATIC™ as part of an option package.

Welcome to your very own family luxury liner.

The R-Class accommodates up to seven passengers - and does so with exceeding luxury, safety, comfort and space. Shedding the rigid and traditional definition of its category, the spacious R-Class is inspired by your needs, as well as your desires. It's the perfect blend of convenience and luxury that is nothing less than artful - nothing less than a Mercedes-Benz.





R 350 BlueTEC 4MATIC™ interior.

Acts like a sixth sense, works like second nature.

Leading-edge features that follow your intuition. The R-Class makes it easy to enjoy the benefits of its advanced technology and entertainment systems. Its controls are designed to operate with a simple, natural logic. The concert-hall experience of the sound system, the preeminence of the communication features, and the available Rear Seat Entertainment System² complement your driving experience. Features include:

- Standard COMAND APS system equipped with HDD navigation, LINGUATRONIC voice control system, and 6-disc DVD changer, that combines navigation, audio and telephone into one intuitive design.
- Media Interface¹ with 3 different connection cables: one for your iPod®, another with a USB input for your memory stick, and an auxiliary audio input.
- harman/kardon® LOGIC7® surround sound system¹ with 610 watts and 12 speakers.
- Available Rear Seat Entertainment System² includes two 8" LCD screens in the back of the front seats, a DVD changer and two wireless headphones.
- SiriusXM is standard and includes a 6 month complimentary subscription³ featuring over 120 channels of the best in audio entertainment. Get 100% commercial-free music from every genre, plus sports, news, talk and comedy – all with crystal-clear, coast-to-coast coverage.



Entertainment controls are easily accessed by either the head unit or controls on the steering wheel.



¹Available on the R 350 4MATIC™ and R 350 BlueTEC 4MATIC™ as part of an option package. ²Available on the R 350 4MATIC™ and R 350 BlueTEC 4MATIC™ as a standalone option. ³Complimentary service is comprised of a SIRIUS package. Monthly subscription required for service thereafter. © 2012 Sirius XM Canada Inc. "SiriusXM", the SiriusXM logo, channel names and logos are trademarks of Sirius XM Radio Inc. and are used under licence.



Convenient and discreet, playback and iPod® functionality is hosted by the optional Media Interface.



R 350 4MATIC™.



Power or comfort? For life's journeys, have both.

When it comes to power, the R 350 4MATIC™ has plenty to offer. Driven by the 3.5 L direct injection V6, the R 350 4MATIC™ offers 302 horsepower (6,500 rpm), 273 lb-ft of torque (3,500-5,250 rpm), with an estimated 10% increase in fuel economy versus the outgoing V6 and reduced CO₂ emissions.



3.5 L direct injection V6.

Optimum power and performance.

The revised programming of the R-Class' 7G-TRONIC automatic transmission provides the optimum engine speed for all shifts. Working in tandem with the engine, the 7G-TRONIC delivers exceptional ride comfort due to its seven forward gears – and with DIRECT SELECT, gear selection is easy using the steering column selector lever. Additionally, the transmission can skip several gears for responsive stopping power or when downshifting.

What comes between you and the road.

The R-Class wheel options are designed with the same philosophy as the rest of this inspired vehicle. Style, substance and safety are the cornerstones of Mercedes-Benz, and none of them were spared while developing these impressive wheels.

¹Standard on the R 350 4MATIC™ and R 350 BlueTEC 4MATIC™. ²Available on the R 350 4MATIC™ and R 350 BlueTEC 4MATIC™ as part of an option package.



19" 5-spoke wheels.¹



AMG 20" 5-spoke wheels.²

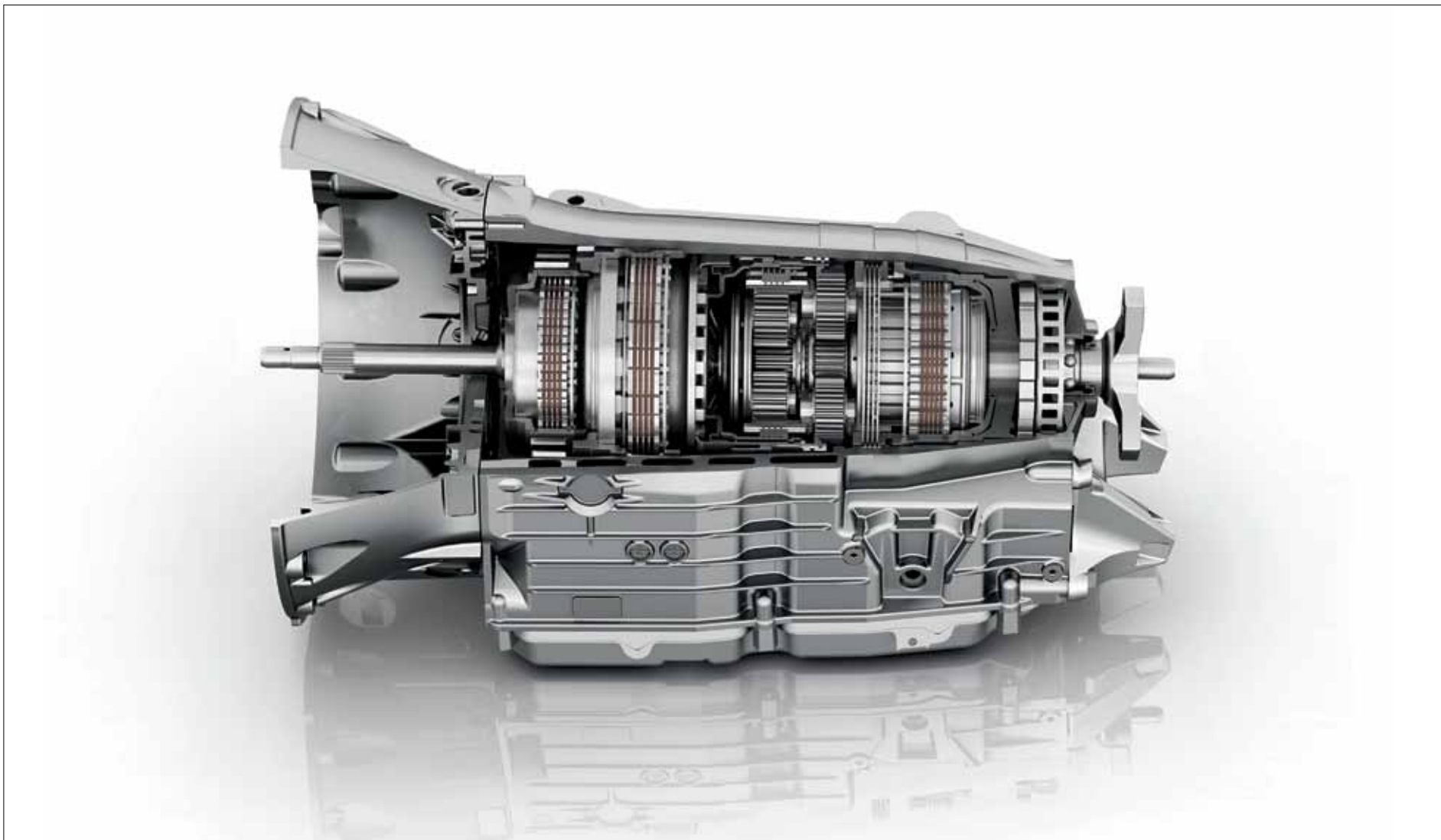

The 7G-TRONIC automatic transmission; one of over 18 million automatic transmissions produced in a period spanning more than 50 years.



Increased adrenaline. Reduced emissions.

At Mercedes-Benz, we don't believe in compromise. Our BlueEFFICIENCY philosophy ensures that environmental responsibility plays a major role in all we do. This all-round approach includes aspects such as total emissions, choice of materials, development, production, use and servicing, right up to eventual vehicle recycling and disposal. The world's awareness is increasing as emissions, fuel consumption and fuel prices become topics that affect us all. For Mercedes-Benz it is both a corporate goal and an obligation to shape the future of mobility in a responsible and sustainable manner.

The standout BlueTEC diesel engine generates a remarkable 210 hp and attains a massive 400 lb-ft of torque at an incredibly low rpm range, between 1,600 and 2,400.



Owens the road as easily as it does attention.

With our award-winning 4MATIC™ permanent all-wheel drive system delivering optimal traction regardless of road conditions, the R-Class knows no boundaries. 4MATIC™ incorporates the 4-wheel Electronic Traction System (4ETS), monitoring each wheel for slippage and individually braking wheels to maintain the balance of power. By continuously ensuring that power is transferred to the wheels with grip, 4MATIC™ will provide control and a balanced feel making the R-Class a joy to drive in any season.



The award winning 4MATIC™ permanent all-wheel drive system provides exceptional traction capability in all weather conditions.

Priority one.

A cornerstone of Mercedes-Benz engineering and design is to ensure your driving experience is as safe as possible. Should the unthinkable occur, a series of functions designed to provide passengers with the best possible protection engages automatically providing support throughout the duration of danger.¹ The R-Class works with your safety in mind by preventing a post-accident situation from deteriorating. Safety features include:

- Sensor-controlled NECK-PRO front headrests, moving almost instantaneously into position to reduce the risk of whiplash.
- PRE-SAFE[®] predictive occupant-protection system.
- The Electronic Stability Program (ESP[®]) providing automatic traction control in suspect road or adverse weather conditions.
- Brake Assist System (BAS) which automatically applies full brake pressure should you be incapable of doing so.
- Front, rear and side airbags support all occupants in the event of vehicle impact.²

Additionally, anytime an airbag or Emergency Tensioning Device is activated, the vehicle engages the TeleAid System³, putting your vehicle in touch with the TeleAid Emergency Response Center, where trained specialists can assess the situation and alert emergency services.

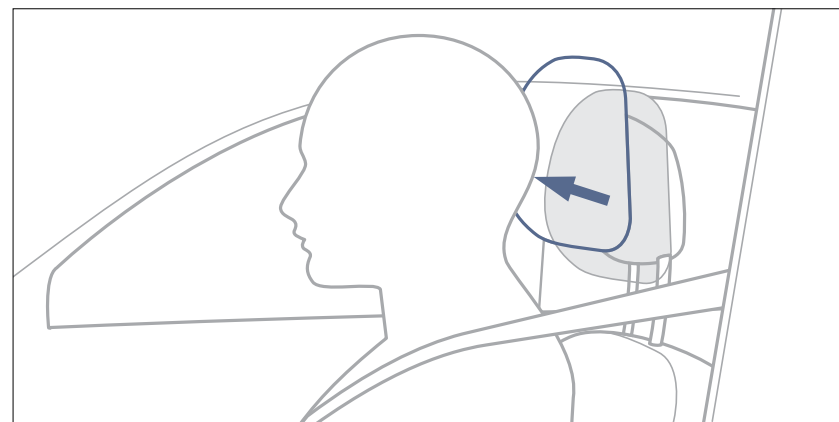

NECK-PRO head restraints automatically engage should an accident occur.

¹No system, regardless of how advanced, can overcome the laws of physics or correct careless driving. Please always wear your seat belt. Best performance in snow is obtained with winter tires. ²WARNING: The forces of a deploying airbag can cause serious or fatal injuries to a child under age 13. Children under 13 should be seated in the back seat if possible. See Operator's Manual for additional warnings and information on airbags, seat belts and child seats. ³First year's monitoring provided at no cost. Subscription is required for service to be active thereafter. TeleAid operates only where cellular and Global Positioning System coverage is available.

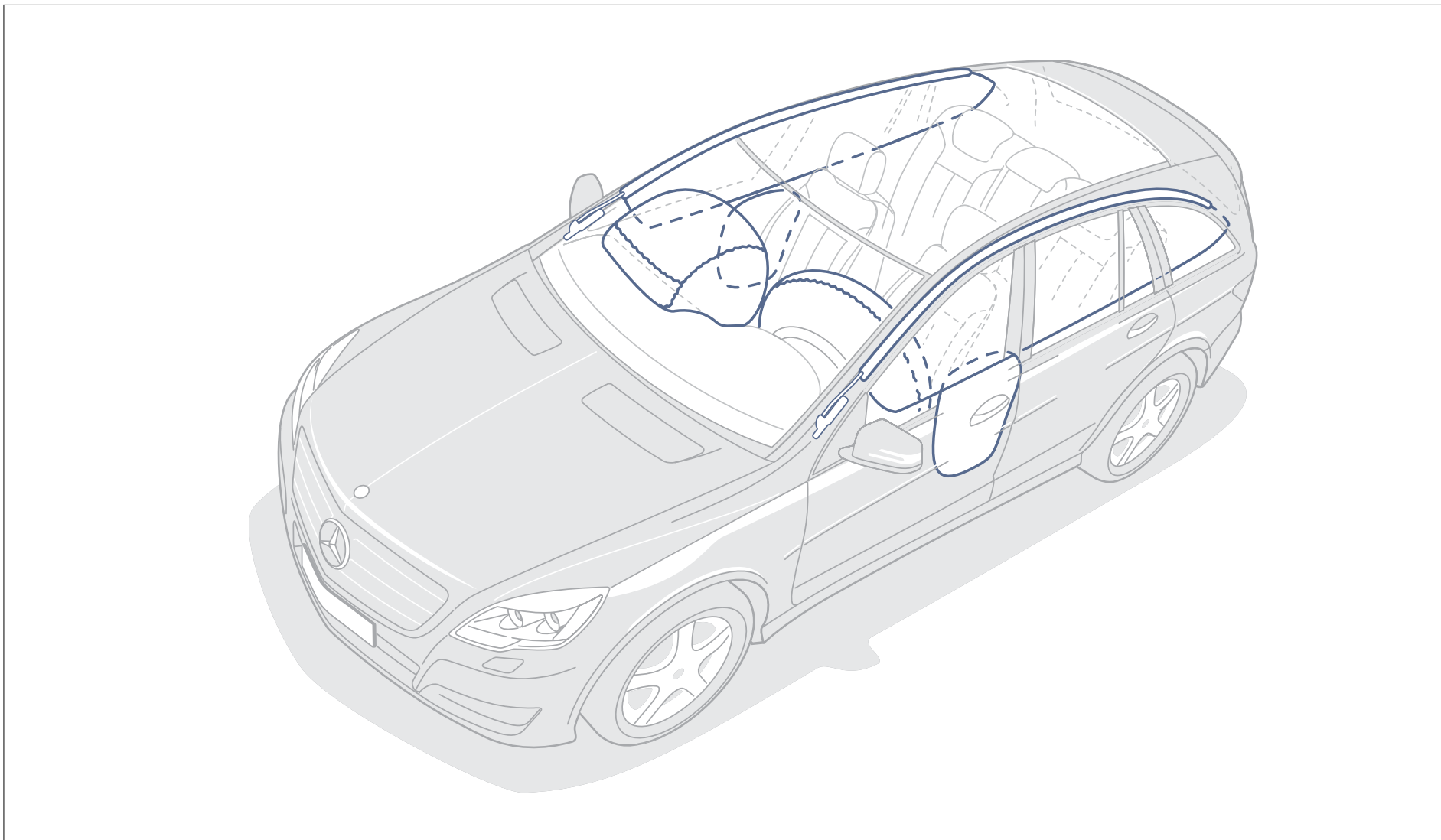

Eight-standard airbags including side curtain airbags in all three rows will support all occupants in the event of a vehicle impact.

Dressed for the occasion.

The finishing touches can mean the difference between a work of art and a true masterpiece. Whichever colour you opt for, you've made the right choice. Because with a selection of paint finishes benefitting from an extra scratch-resistant clear coat, your R-Class is less susceptible not only to scratches, but also to sunlight, temperature variations, dust and soot.



	ARITCO LEATHER Black/Black	Almond Beige/Black	Alpaca Grey/Black	LEATHER ¹ Black/Black	Almond Beige/Black	Alpaca Grey/Black
SOLID PAINT						
Black	●	●	●	●	●	●
Calcite White	●	○	-	●	○	-
METALLIC PAINT						
Obsidian Black	●	●	●	●	●	●
Tenorite Grey	●	○	●	●	○	●
Iridium Silver	●	-	●	●	-	●
Palladium Silver	●	○	●	●	○	●
Pearl Beige	●	●	-	●	●	-
Citrine Brown	●	●	-	●	●	-
Diamond White	●	○	-	●	○	-
Cavansite Blue	●	○	●	●	○	●

● Recommended combination ○ Possible Combination - Not Available

¹Available as part of an option package on the R 350 BlueTEC 4MATIC™ and the R 350 4MATIC™.

SOLID PAINT



040 Black

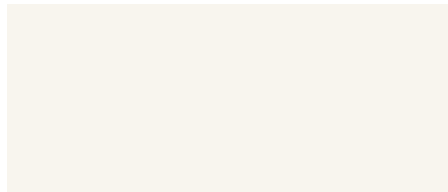

650 Calcite White

METALLIC PAINT (OPTIONAL)



197 Obsidian Black



755 Tenorite Grey



775 Iridium Silver



792 Palladium Silver



794 Pearl Beige

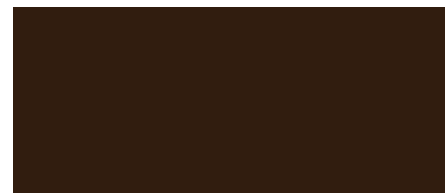

796 Citrine Brown

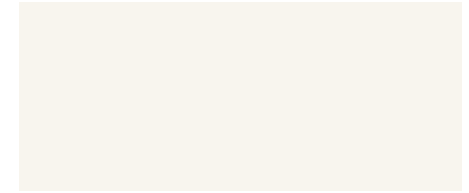

799 Diamond White



890 Cavansite Blue

ARTICO LEATHER



151 Black/Black



165 Almond Beige/Black



168 Alpaca Grey/Black

LEATHER¹



221 Black/Black



265 Almond Beige/Black



268 Alpaca Grey/Black

TRIM



729 Anthracite Poplar Wood²



731 Burl Walnut Wood³

¹Available as part of an option package on the R 350 BlueTEC 4MATIC™ and the R 350 4MATIC™. ²Standard on the R 350 BlueTEC 4MATIC™ and the R 350 4MATIC™. ³Available as a standalone option on the R 350 BlueTEC 4MATIC™ and the R 350 4MATIC™.



The final touches.

Added nuances and unique refinements are just the things to make your R-Class a distinctively richer driving experience. Mercedes-Benz accessories are a cut above, having been designed and built to the highest standards for concept, engineering, quality, form and function.



Rear Roof Spoiler

Emphasize the sporty, yet elegant appearance of the R-Class while maintaining its strong character. Exclusively designed for a perfect fit.



Chrome Door Handle Cups

Rounds out the chrome finish of the R-Class while protecting your paint from scratches.



Roof Rack and Box

Need even more cargo carrying capacity? The R-Class roof rack and box is an ideal solution. We have something to fit all of your needs with multiple sizes available.

A passion for things done right.

A passion for craftsmanship and attention to detail – it's what you'd expect from Mercedes-Benz, setting us apart from all other manufacturers. It drives us to set new standards in design, performance, comfort and safety. To continually build on the legendary traditions of Mercedes-Benz, and to provide you with an ownership experience that includes the valuable benefits described below.

24-hour Roadside Assistance

During the basic warranty coverage of 48 months and the time duration of the optional Extended Limited Warranty, Mercedes-Benz Roadside Assistance will be at your service. We'll bring you some gas, replace a flat tire with your spare, or jumpstart your car. In the event of a mechanical breakdown, if attempts by our Roadside Assistance technician have not made your vehicle safely operable, towing service will be provided to the nearest Mercedes-Benz dealership. Assistance is available 24 hours a day, every day, to anyone driving a Mercedes-Benz anywhere in Canada or the continental U.S.¹

Wear and tear period

The following parts listed are covered for wear and tear during the first 24 months or 40,000 km, whichever comes first. Brake pads, brake discs, brake pad wear sensors and light bulbs.

Mercedes-Benz warranties

The Mercedes-Benz New Vehicle Limited Warranty covers defects in materials or workmanship for 48 months or 80,000 km, whichever comes first. To widen your window of confidence, you can opt for a Mercedes-Benz Extended Limited Warranty as well.²

Customer service

Owning a Mercedes-Benz means that when you have a question, we're here to help. Customer Service is open from 9 a.m. to 5 p.m. EST, Monday through Friday, and is staffed with knowledgeable Mercedes-Benz experts who can talk you through the finer points of working your car's audio system – or even assist you in locating the nearest Mercedes-Benz dealership. Just call 1-800-387-0100. It's that simple.

Trip interruption reimbursement

If a breakdown covered by your New Vehicle Limited Warranty or optional

Extended Limited Warranty occurs more than 80 km from your home, leaves your Mercedes-Benz vehicle inoperable or unsafe to drive, and requires overnight repairs, we've got you covered. You will be reimbursed up to \$500 for hotel accommodations and up to \$600 for alternative travel expenses per incident while your car is being repaired at an authorized Mercedes-Benz dealership.

¹Vehicle must be accessible from main roads. Roadside Assistance may involve charges for parts, service and towing. Depending on the circumstances, these services may be provided by an outside service provider, courtesy of Mercedes-Benz Roadside Assistance. For full details of the Roadside Assistance Program, please see your dealer. ²Please see your dealer for warranty details as well as for terms, conditions and pricing for extended warranty options.



To be continued. With a test drive.

Nowhere is your R-Class so convincing as on the road. It's only there that you can fully experience the superior handling and power that makes this car so special. Feel the engine move you forward, and watch your heart rate rise with the speedometer. That unique feeling in your stomach cannot be put down on paper. That's why we would like to invite you in for a test drive at your local Mercedes-Benz dealer. Reserve your appointment today, or visit mercedes-benz.ca. We look forward to seeing you.

Mercedes-Benz is virtually yours.

Visit mercedes-benz.ca and open an online window to Mercedes-Benz Canada. Revel in the incredible photography of our vehicles and get a visceral impression of what it would be like to see yourself behind the wheel. Access information about any of our vehicles, including financing and leasing options, upcoming models, and configure your dream Mercedes online. Our website also offers details about the Mercedes-Benz Extended Limited Warranty, vehicle ownership, and much more on the fascinating story behind one of the world's most recognizable brands.

The 2013 R-Class

EQUIPMENT LISTING AND TECHNICAL SPECIFICATIONS

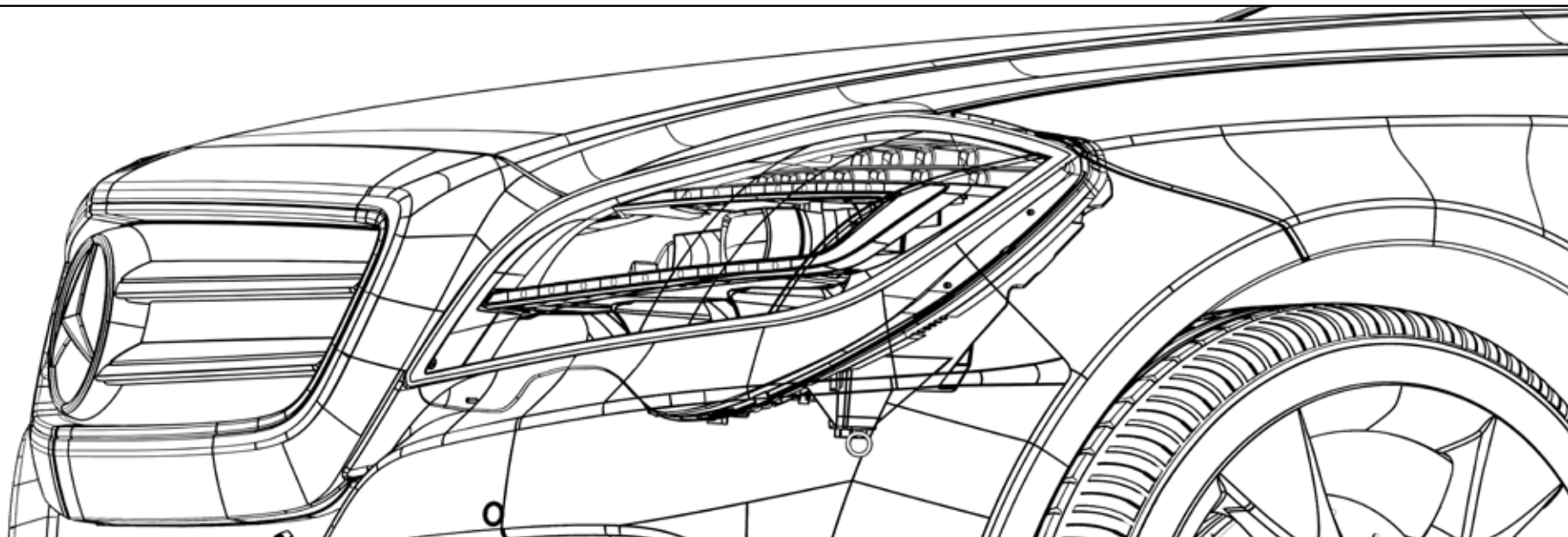

Mercedes-Benz

The best or nothing.

INDIVIDUAL EQUIPMENT

TRANSMISSION

7G-TRONIC automatic transmission

TRACTION/STABILITY

4MATIC™ permanent all-wheel drive with 4ETS

Electronic Stability Program (ESP®) including ABS and traction control (ASR)

Brake Assist (BAS)

Rear air suspension

AIRMATIC air suspension

Adaptive Damping System (ADS)

AUDIO/VISUAL/COMMUNICATION

COMAND APS with HDD navigation and DVD changer

Media Interface

SIRIUS Satellite Radio¹

Rear Seat Entertainment System

harman/kardon® LOGIC7® surround sound system

EXTERIOR

19" 5-spoke alloy wheels

AMG 20" 5-spoke alloy wheels

Bi-Xenon headlamps with washers and cornering lights

LED daytime running lights and taillights

Exterior power folding mirrors

Heated windshield washer system

Front blue tinted glass (driver and passenger)

R 350 4MATIC™

R 350 BlueTEC 4MATIC™

▲ ▲

▲ ▲

▲ ▲

▲ ▲

▲ ▲

○ ○

○ ○

▲ ▲

○ ○

▲ ▲

△ △

○ ○

▲ ▲

○ ○

▲ ▲

▲ ▲

▲ ▲

▲ ▲

○ ○

INDIVIDUAL EQUIPMENT

INTERIOR

Power adjustable heated front seats

Climate comfort front seats

Multicontour front seats

Front luxury headrests

Heated rear seats

ARTICO Leather upholstery

Leather upholstery

Leather covered steering wheel and shift knob

Heated steering wheel

Wood/leather steering wheel

2nd row executive chairs with centre console

Power pop-out 3rd row windows

Sliding glass sunroof with pop-up

Panoramic sunroof

Roller blinds for rear side windows

Power-tilt/telescoping steering column

THERMATIC automatic climate control

THERMOTRONIC automatic climate control with rear controls

3-position memory for front seats, steering wheel and exterior mirrors

Auto dimming mirrors (rearview and driver's side)

CONVENIENCE

Integrated garage door opener

SmartKey remote with panic button

R 350 4MATIC™

R 350 BlueTEC 4MATIC™

▲ ▲

○ ○

○ ○

○ ○

○ ○

▲ ▲

○ ○

▲ ▲

▲ ▲

△ △

△ △

▲ ▲

▲ ▲

○ ○

○ ○

▲ ▲

▲ ▲

○ ○

▲ ▲

▲ ▲

▲ ▲

▲ ▲

INDIVIDUAL EQUIPMENT

CONVENIENCE

KEYLESS-GO

PARKTRONIC

EASY-PACK power tailgate

115 V power outlet

Trailer hitch

SAFETY

DISTRONIC

PRE-SAFE®

Crash-responsive NECK-PRO front head restraints

Dual-stage front airbags, front side airbags, rear side airbags and full-length window curtain airbags

ISOFIX child seat mounts

TeleAid Emergency Calling System²

Anti-theft alarm system

Tire Pressure Loss Warning System

Rear view camera

Passive blind spot assist

R 350 4MATIC™

R 350 BlueTEC 4MATIC™

○ ○

▲ ▲

○ ○

○ ○

△ △

△ △

▲ ▲

▲ ▲

▲ ▲

▲ ▲

△ △

▲ ▲

▲ ▲

○ ○

○ ○

EQUIPMENT PACKAGES

PREMIUM PACKAGE: Rear view camera, Passive Blind Spot Assist, Panoramic sunroof, Media interface, harman/kardon® LOGIC7® surround sound system, Heated rear seats, KEYLESS-GO, EASY-PACK power tailgate, 115V Power socket.

PREMIUM FRONT SEATING PACKAGE: Climate comfort front seats, Multicontour driver's seat, Multicontour passenger seat.

LEATHER PACKAGE: Leather upholstery, Luxury front headrests, Interior lighting package.

PREMIUM REAR SEATING PACKAGE: Roller blinds for rear side windows, THERMOTRONIC automatic climate control.

SPORT PACKAGE: Adaptive damping system (ADS), AIRMATIC air suspension, Blue tinted glass, AMG 20" 5-spoke wheels.

R 350 4MATIC™

R 350 BlueTEC 4MATIC™

△

△

△

△

△

△

△

△

△

△

▲ Standard equipment △ Optional Equipment ○ Optional as part of a Package — Not available

¹Complimentary service is comprised of a SIRIUS package for a duration of 6 months. Monthly subscription required for service thereafter. © 2012 Sirius XM Canada Inc. "SiriusXM", the SiriusXM logo, channel names and logos are trademarks of Sirius XM Radio Inc. and are used under licence. ²First year's monitoring provided at no cost. Subscription is required for service to be active thereafter. TeleAid operates only where cellular and Global Positioning System coverage is available.

Technical data:

	R 350 BlueTEC 4MATIC™	R 350 4MATIC™
Engine type	24V DOHC V6 Turbo	24V DOHC V6
Total displacement	2,987 cm ³	3,498 cm ³
Net power	210 hp @ 3,400 rpm	302 hp @ 6,500 rpm
Net torque	400 lb-ft @ 1,600-2,400 rpm	273 lb-ft @ 3,500-5,250 rpm
Acceleration ¹ , 0–100 km/h	8.9 seconds	8.4 seconds
Approximate top speed ²	210 km/h	210 km/h
Tires, front rear	255/50 R 19 255/50 R 19	255/50 R 19 255/50 R 19
Fuel economy ³ , city/highway estimate	11.7 - 8.2 L/100 km	13.1-9.4 L/100 km
Fuel tank capacity	80 litres (13 L reserve)	80 litres (13 L reserve)
Fuel requirement	Diesel	Premium unleaded
Dimensions ⁴ Wheelbase Overall length Overall height Overall width – Mirrors Extended	3,215 mm 5,157 mm 1,663 mm 2,183 mm	3,215 mm 5,157 mm 1,663 mm 2,183 mm
Curb weight	2,380 kg	2,270 kg
Cargo capacity	2,385 litres	2,385 litres

¹Stated rates of acceleration are based upon the manufacturer's track results and may vary depending upon model, environmental and road surface conditions, driving style, elevation and vehicle load. ²Electronically limited.

³These estimates are based on Government of Canada testing methods. The actual fuel consumption of these vehicles may vary. Refer to the Government of Canada Fuel Consumption Guide. ⁴With standard equipment.

© 2012 Mercedes-Benz Canada Inc.

All illustrations and specifications contained in this brochure are based on the latest product information available at the time of publication. Mercedes-Benz Canada reserves the right to make changes at any time, without notice, in colours, materials, equipment, specifications and models. Any inaccuracies in colours shown are due to reproduction variations of the printing process. Some vehicles may be shown with non-Canadian equipment. Some vehicles may be shown without side marker lights. Some vehicles are shown with optional equipment available at extra cost. Some optional equipment may not be available on all models. For current information regarding the range of models, standard features, optional equipment and/or colours available in Canada and their pricing, contact your nearest authorized Mercedes-Benz dealer or visit mercedes-benz.ca. harman/kardon® and LOGIC7® are registered trademarks of Harman International Industries Inc. iPod® is a registered trademark of Apple Computer, Inc.

Printed in Canada
MBC-12-R13-4050E

Mercedes-Benz Canada Inc. 98 Vanderhoof Avenue, Toronto, Ontario M4G 4C9
1-800-387-0100
mercedes-benz.ca

