

2017 MAZDA MX-5 AND THE ALL-NEW 2017 MX-5 RF



DOES DRIVING MATTER?

Does a long, winding road or an empty highway on Sunday morning matter if the car you're driving doesn't take advantage of the moment?

Does safety, technology, efficiency or even beauty matter, if a car doesn't feel right in your hands?

If you build Mazdas, driving is what matters most.

That's why everything we do has one purpose... to make driving better.

Like creating safety technology that inspires confidence.

Engine technology that makes our cars and SUVs more fuel efficient, responsive. And sticky in the turns.

With designs that capture motion, even when the car isn't moving.

What's better than a great driving car?

A car company that won't build anything less.

MAZDA
DRIVING MATTERS

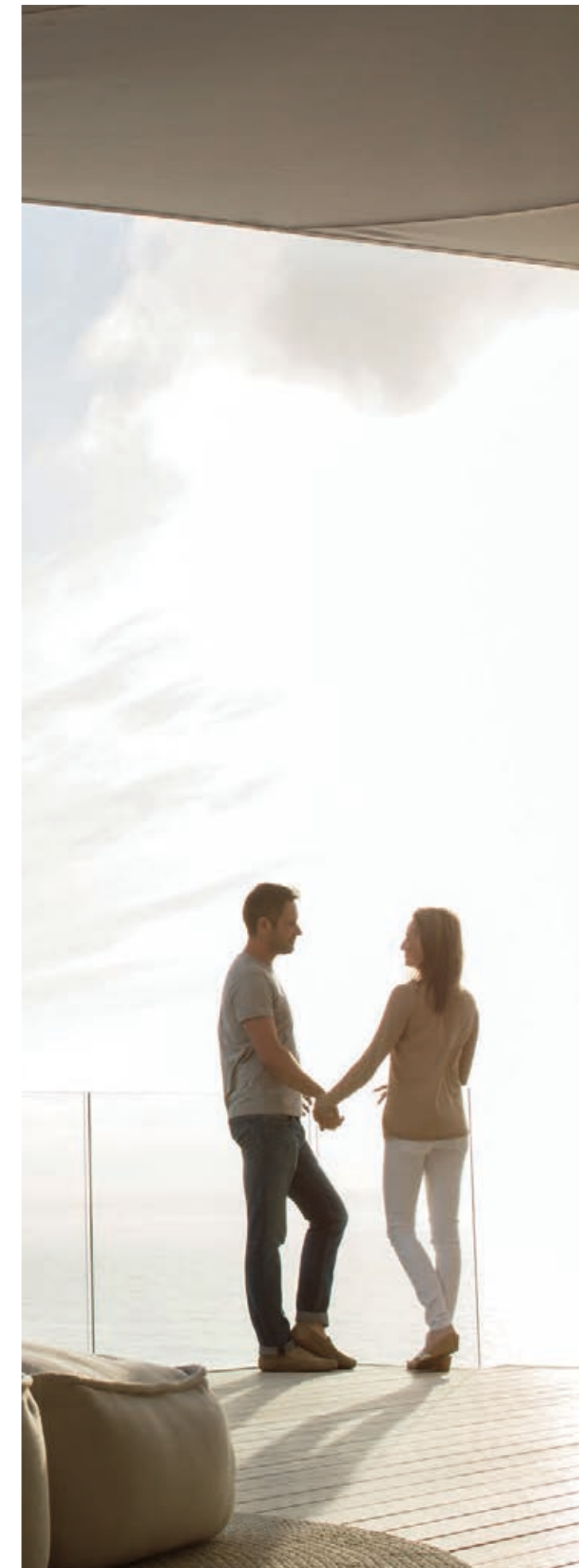

WAS FOCUSING ON EVERY BOLT, EVERY WIRE AND EVERY STITCH OVERKILL? WE THINK NOT.

We built the 2017 MX-5 and the all-new 2017 MX-5 RF like we built the very first one, preserving its roots, but evolving the technology. For the last 27 years, it has embodied a pure love of driving - a roadster with beautiful proportions, heart-pounding excitement, a rocking power-to-weight ratio and a connection to the road unlike any other.

The fourth-generation MX-5 with SKYACTIV TECHNOLOGY is no different. It commits to the asphalt with smooth and quick agility, without hesitation. At a lean 1,058 kg for the soft top MX-5 (1,114 kg

for the RF hardtop), it's athletic, light and lively. And loaded with as much thrill as you want to give it. It's built to behave precisely how you want it to. Intuitive. Responsive. Making you grin from ear to ear.

What's vital is how it makes you feel when you grip the steering wheel and take a curvy off-ramp after a long day. Whether it's s-curves, corners or cliff-side highway corkscrews, in the MX-5, you can take them confidently and never hold back. We built the 2017 MX-5 and MX-5 RF for drivers like you. Because driving matters.



EXHILARATING. WITHOUT MOVING AN INCH.

KODO "Soul of Motion" design language is not just a curve in the side panels or the shape of a headlight. You'll find its essence in every element of the MX-5 and MX-5 RF. Whether the top is up or folded neatly away, the new muscular stance conveys the feeling of spontaneous power and a fluid symmetry. Even at a standstill, the MX-5's design evokes the feeling of motion and the desire to get in and drive.

IS THE SHORTEST DISTANCE BETWEEN TWO POINTS REALLY THE BEST ROUTE?

What is it about the MX-5 that makes you want to drive just a little bit longer? With such a long and storied evolution, you learn a few things about what matters. Take it from longtime MX-5 Chief Program Manager, *Nobuhiro Yamamoto*. Not only was he on the high-profile Mazda R&D team for the 1991 Le Mans win, but he also leads the team today in its obsessive need to achieve absolute performance and sheer driving excitement. Of his winning strategy, Yamamoto explains, "That means a light, compact body, front mid-ship engine and rear-wheel drive, 50:50 weight distribution, low yaw moment of inertia and low centre of gravity."

Since we race everything we build, you can be assured the MX-5 has a track-tuned suspension that delivers superb handling and directional stability by combining a sophisticated double-wishbone layout up front with an advanced multi-link setup in the rear. Lowering the engine for a lower centre of gravity and pushing the engine back are all nuances that enhance balance and directional control, so that the MX-5 stays firmly anchored to the pavement.

The Dynamic Stability Control* with an integrated Traction Control System optimizes both traction and handling in less-than-ideal road conditions without interfering with your oneness with the road. For all those twists and turns the road has in store, each and every MX-5 is precisely engineered to create balance.



MX-5 GS SPORT PACKAGE

The MX-5 GS and MX-5 RF GS with manual transmission offer an available Sport Package that has everything you need to give your MX-5 a sports car edge. From BBS® wheels and Brembo® front brakes to Recaro® sport seats with Nappa leather and luxurious Alcantara®-trimmed upholstery, it's fully tuned for sports car driving. (GS and RF GS with manual transmission.)



SPORT PACKAGE INCLUDES:

Brembo® front brakes (opposed piston design with unique rotor), red painted front and rear calipers, 17" BBS® forged alloy wheels with dark finish, Recaro® sport seats with Nappa leather - and Alcantara®-trimmed upholstery, and adjustable heated seats. (GS and RF GS with manual transmission.)

GRAND SPORT PACKAGE INCLUDES:

Contrasting top in piano black, Brembo® front brakes (opposed piston design with unique rotor), red painted front and rear calipers, 17" BBS® forged alloy wheels with dark finish, and Nappa leather-trimmed seats. (RF GT with manual transmission.)

EXCLUSIVE PACKAGE INCLUDES:

Contrasting top in piano black and Nappa leather-trimmed seats. (RF GT.)

*Dynamic Stability Control is not a substitute for safe driving practices.

IS IT POSSIBLE TO IMPROVE THE BEST-SELLING ROADSTER OF ALL TIME?

The respected and fundamental driving dynamics of the MX-5 and MX-5 RF are fuelled by the need to build a sports car that is lightweight, strong and a total blast to drive. It's in our DNA to build cars that are responsive and faithful. It's why the MX-5 inspired the holistic approach to building our vehicles, called SKYACTIV TECHNOLOGY.

SKYACTIV TECHNOLOGY makes for a lighter, stiffer and safer vehicle. It is at the heart of the MX-5. Or is it the other way around? It's the foundation for a strong, lightweight platform with a powerful-yet-efficient drivetrain that maximizes driving enjoyment with every drop of fuel. While you may not think about these things when you're tearing it up on an s-curve, it matters to us that you get the most out of your sports car.

UP TO AN ESTIMATED
6.7 L/100 KM HWY*



SKYACTIV-G ENGINE

To maintain performance in the fourth-generation MX-5, exhaustive efforts were made to reduce weight, yet preserve the responsive feel found in the very first MX-5. We started with a 22% drop in weight from the previous generation, including what could be the world's thinnest (1.7 mm) cylinder head cover. The new MX-5 and MX-5 RF get the most out of their new dedicated engine with a 13.0:1 compression ratio and 4-2-1 race-inspired headers. This energizing 2.0 L, 16-valve, DOHC engine delivers an assertive 155 hp and 6,000 rpm redline without sacrificing fuel efficiency, offering up to an estimated 6.7 L/100 km highway. While the numbers may change, the original experience remains.



SKYACTIV-MT

The distinctive *Jinba Ittai* experience is fully realized behind the wheel due to the MX-5's precise and ultra-responsive short-throw, close-ratio 6-speed manual gearbox. With a mere flick of your wrist, shifting from gear to gear is not only rapid and precise, but a total blast. Smaller, lighter and smoother than any we've ever built before, the shifter, accelerator and clutch work harmoniously to orchestrate a tempo with the driver that is unparalleled.

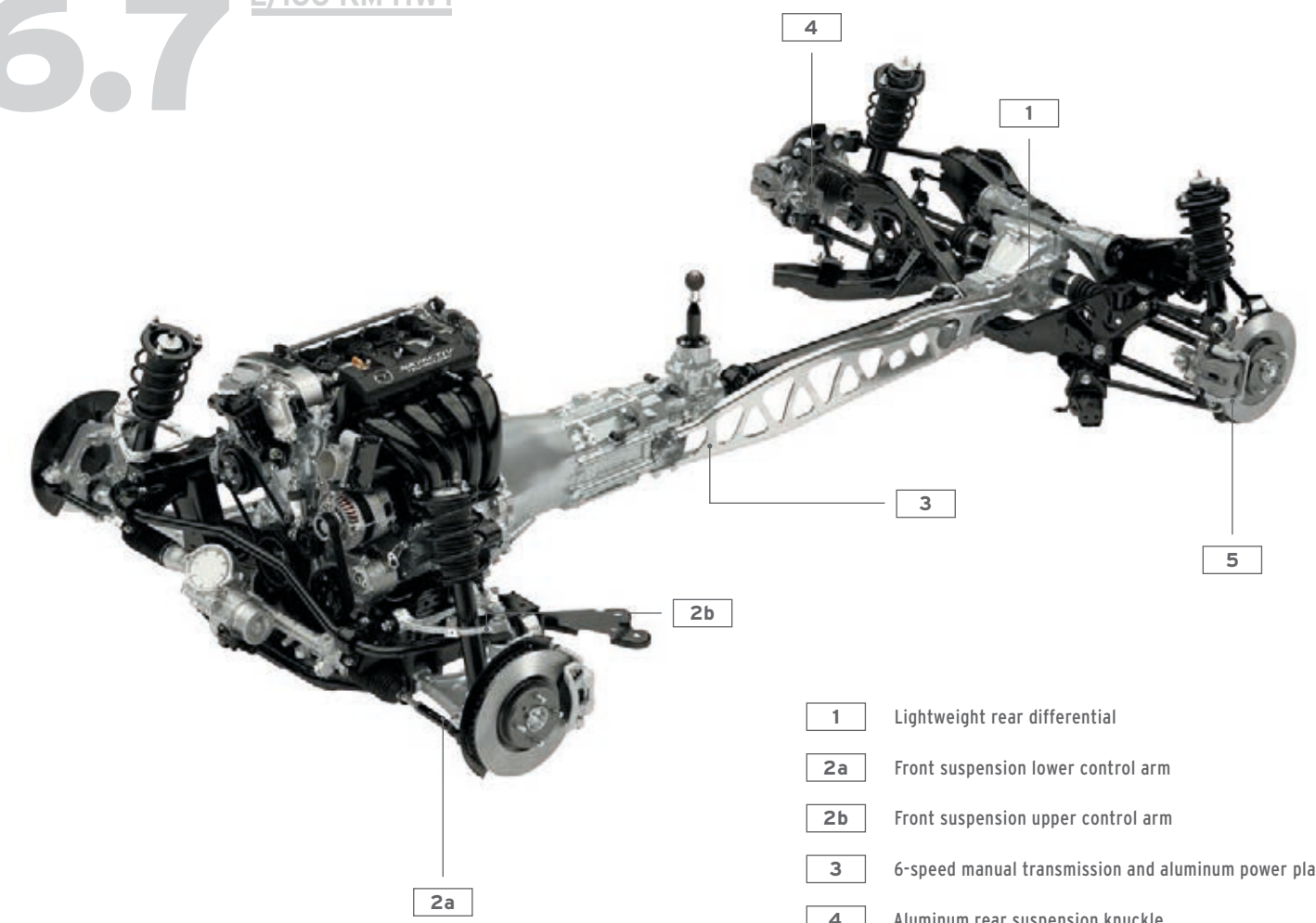

- 1** Lightweight rear differential
- 2a** Front suspension lower control arm
- 2b** Front suspension upper control arm
- 3** 6-speed manual transmission and aluminum power plant frame
- 4** Aluminum rear suspension knuckle
- 5** Rear multi-link suspension



A COMPLETE BODY OF WORK

How can moving the A-pillars 57 mm closer to the seats, and expanding the spread angle 2.7° on the driver's side and 2.0° on the passenger's side, help you corner better? This purposeful body design isn't strictly for aesthetics. It's the minutiae that MX-5 engineers get obsessive about because it matters in g-forces. And when entering turns, having a precise grasp of your exact position should never be guesswork. So we expanded the field of vision to 5.3° and gave the front fenders high-rising edges and a lower hood to allow for accurate tire placement. You aim the MX-5 and it responds in accord.



SKYACTIV-BODY

For the MX-5, the challenge was to deliver a lightweight, open-top sports car that felt responsive at every turn, yet minimized vibration. We crafted a sturdier structural design that used ultra-high-tensile and high-tensile steel in critical areas, while high-strength 7000-series aluminum materials replaced heavier steel at the front and rear bumper support, front fenders, brace bar, bulkhead and diagonal braces. The aluminum roof materials even help lower the centre of gravity. The new MX-5's body is 15% lighter than that of the previous model, yet stiffer, stronger and safer.

SKYACTIV-CHASSIS

Can changing the front caster angle by 1° make any difference? It does, so we did it. Getting the details just right is a Mazda engineer's sole purpose. And for the MX-5, that includes the details in the design marvel that is the highly rigid and lightweight double-wishbone front suspension and multi-link rear suspension. Adopting aluminum for the upper arms, lower arms and knuckles, and 780 MPa-grade high-tensile steel for the cross member, also contributed to the overall weight reduction.

Engineered to work in perfect harmony, the steering and suspension systems achieve two seemingly contradictory goals at once: to be nimble at low speeds, yet stable at high speeds, optimizing performance in those corners. And we kept refining, millimetre-by-millimetre and gram-by-gram, until optimum vehicle posture and vibration-dampening performance were achieved.

POWER PLANT FRAME

This structural "backbone" helps eliminate drivetrain twist, which wastes power and produces acceleration lag. The MX-5's ingenious aluminum Power Plant Frame that unites its engine, transmission and rear differential has also undergone a weight loss of nearly 20% from its predecessor. But just eliminating the weight wasn't the only solution to increasing the rigidity and stability. Re-shaping the cross-section of the frame had to be done to achieve this unparalleled driving experience. You'll feel the responsiveness and feedback - from your right foot to your fingers wrapped around the steering wheel, up to the hairs on the back of your neck.

*Estimated fuel economy on the 2017 MX-5 AT. Estimated fuel economy based on Government of Canada's approved, revised 5-cycle testing method. Your actual fuel consumption may vary depending on how, where and when you drive. For comparison purposes only. For more information on revised 5-cycle testing, visit mazda.ca/5cycle.



SEATS

Heated, leather-trimmed bucket seats with three comfort settings in GT models are meticulously designed to conform to your every curve and adjust to your specific driving position. To reduce vibration and improve holding capabilities of the driver, even in corners, the MX-5 seatbacks and cushions have been structurally reimagined with lighter netting materials. The best seat in the house just got more comfortable.



A CAR SHOULD BE AN EXTENSION OF YOUR BODY. DRIVING SHOULD BE AN EXTENSION OF YOUR SOUL.

The concept of *Jinba Ittai*, or "horse and rider as one," is the inspiration for the MX-5 and MX-5 RF - that a horse and its rider communicate by being instinctively in tune with each other, achieving effortless communication. The MX-5 is a car so precisely tuned, it isn't complete until one variable enters - you, the driver.

To complete that same communication behind the wheel of an MX-5, Mazda engineers used multiple electromyograms and G sensors to analyze a driver's complete interaction with the vehicle. From determining the exact location of the shift lever, to which muscles and precisely how much effort would be needed to shift, every aspect of the drive is engineered to not just connect you with your MX-5, but make you one with it.



Is it possible to increase the cabin room without expanding the dimensions outside? Mazda engineers achieved this marvel by tilting the steering wheel 10 mm, increasing the head clearance by 11 mm and allowing for the seats to recline by an additional 2°. The MX-5's interior environment is designed to the utmost of form and function, because it's this attention to detail that matters when someone six feet tall takes a seat behind the wheel.

WHO SAYS A TWO-SEATER SPORTS CAR CAN'T FIT EVERYTHING?

The MX-5 and MX-5 RF come fully equipped with a wide array of amenities you wouldn't expect to find in a track-proven sports car. We've introduced our most advanced infotainment technology, MAZDA CONNECT, into the GS and GT models. All easily accessible from the multi-function HMI Commander switch*, located within minimal distance to keep you focused on driving.

The 7-inch, full-colour touchscreen display on the GS and GT models is your window to the world and helps avoid distractions from the road.

Pairing your mobile device via standard Bluetooth® technology connects your MX-5 to streaming media, music and social content from Facebook and Twitter feeds. On the GS and GT models the navigation system keeps you on course with voice-guided commands and advanced lane guidance. Even beyond just making and receiving hands-free calls from steering-wheel-mounted controls, the SMS* text message audio delivery and reply lets you stay both connected and focused on the road.

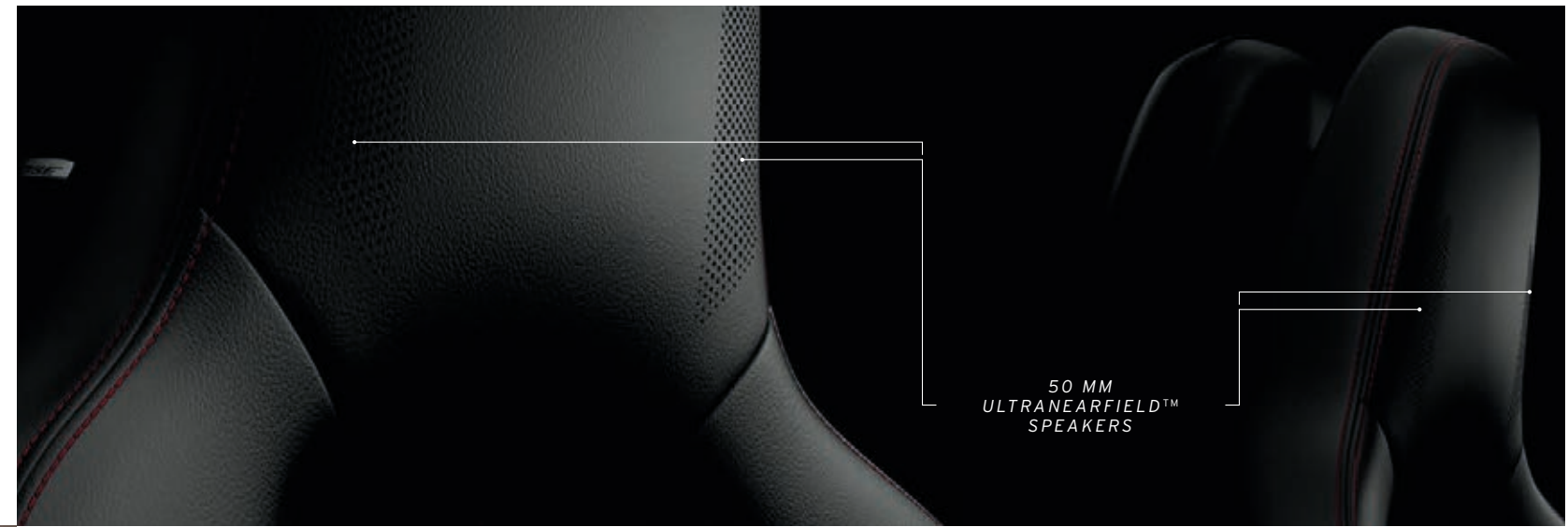

AVAILABLE AMENITIES

Navigation system with 3D interactive map*/Keyless Entry System/ Automatic climate control†

YOUR OWN PRIVATE AMPHITHEATRE.

The top is dropped. The sun is glistening. Your cares may be going out the top, but your tunes shouldn't go along with them. In GT models, the Bose® sound system keeps the sound within the cabin - in fact, within inches of your ears. With 9 speakers, including two 50 mm UltraNearfield™ speakers positioned in each of the MX-5's headrests‡,

sound is as clear as day. From bass to treble, audiophiles can enjoy pure sound quality from their MP3s through dual USB ports**. Only the roar of the MX-5's engine will penetrate the cabin thanks to the Bose® AudioPilot® 2 noise compensation technology. Now road noise is left where it belongs - outside.



*Standard on GS and GT models.
 †Standard on GT models.
 ‡Speakers in the driver's side headrest are standard on all models. Speakers in the passenger's side headrest are standard on GT models.
 **One USB port is standard on the GX model and two USB ports are standard on the GS and GT models.



RETRACTABLE ROOF

In a matter of seconds, the MX-5's iconic soft top can be unlocked and dropped for pure driving enjoyment in one simple, intuitive and ergonomic step. Even positioned from the driver's seat, the release is quick, smooth and effortless - all with one hand. Should the sky suddenly decide to change, and the top require closure, we've reduced the top's weight and incorporated an "assist spring" mechanism to aid in raising the roof back into position while remaining seated. Because being comfortable in all weather matters.

CAN A FEW BLINKING LIGHTS GIVE YOU PEACE OF MIND?

Because feeling safe and having confidence behind the wheel of a convertible sports car matters, our i-ACTIVSENSE suite of safety technologies provides the ultimate sense of security and comes standard on GT models. Knowing that there are advanced safety features active while you're enjoying the drive means less distraction. Being alerted to a hazard before it becomes an issue helps avoid collisions in the first place, or even lessen their impact. i-ACTIVSENSE is there when you need it, without encumbering your driving experience.

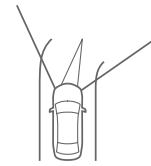
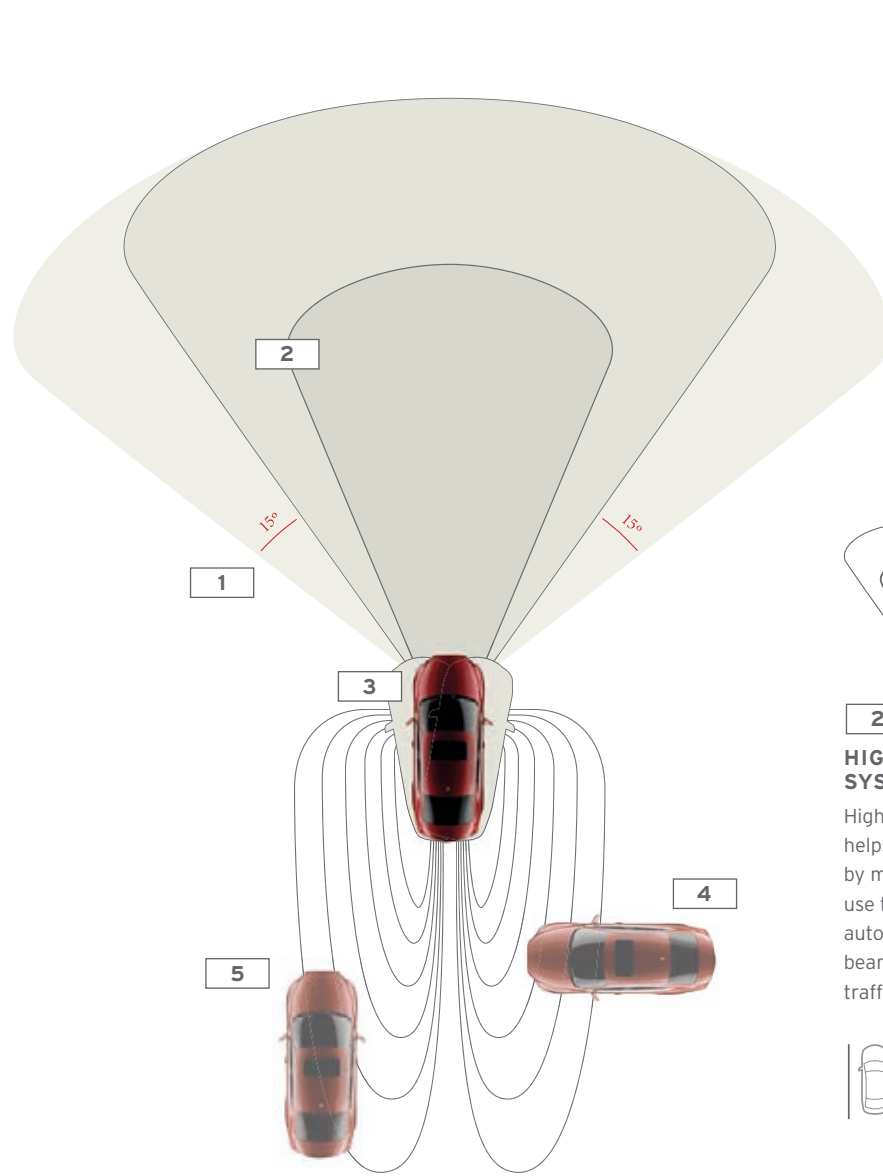

1 LED HEADLIGHTS WITH ADAPTIVE FRONT LIGHTING SYSTEM (AFS)

The MX-5 and MX-5 RF offer standard LED headlights and GT models also feature Mazda's Adaptive Front Lighting System (AFS), which is designed to help you see around corners at night - literally. As you turn into a corner, the headlights pivot up to 15° in the direction of your turn, improving visibility and allowing you to spot potential hazards and dangers ahead.

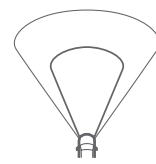

2 HIGH BEAM CONTROL SYSTEM (HBC)

High Beam Control system (HBC) helps the driver see better at night by maximizing opportunities to use the high beams. The system automatically switches to the low beams when it detects oncoming traffic and/or a vehicle ahead.*

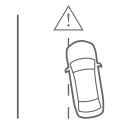

3 LANE DEPARTURE WARNING SYSTEM (LDWS)

This system gives audible and visual warnings when the vehicle is about to unintentionally depart from its lane at a speed of 65 km/hour or higher.*

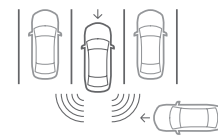

4 REAR CROSS TRAFFIC ALERT (RCTA)

When backing up, this system detects a vehicle approaching from the side and promptly alerts the driver with an audible warning, as well as a visual warning in both side mirrors.†



5 ADVANCED BLIND SPOT MONITORING (ABSM)

Radar sensors detect objects in your left or right blind spots and then alert you with a warning light that appears in the corresponding side mirror. If you signal a lane change while an object is there, the light blinks and a cabin warning chime sounds.††

i-ACTIVSENSE

*Standard on GT models.
†Always check your mirrors. Be aware of the traffic around you.
‡Standard on GS and GT models.

"FOR PURE DRIVING BLISS, LOOK NO FURTHER THAN THE [MX-5] - AND YOU'LL NEED ONLY ONE TURN BEHIND THE WHEEL TO SEE WHY."

- caranddriver.com

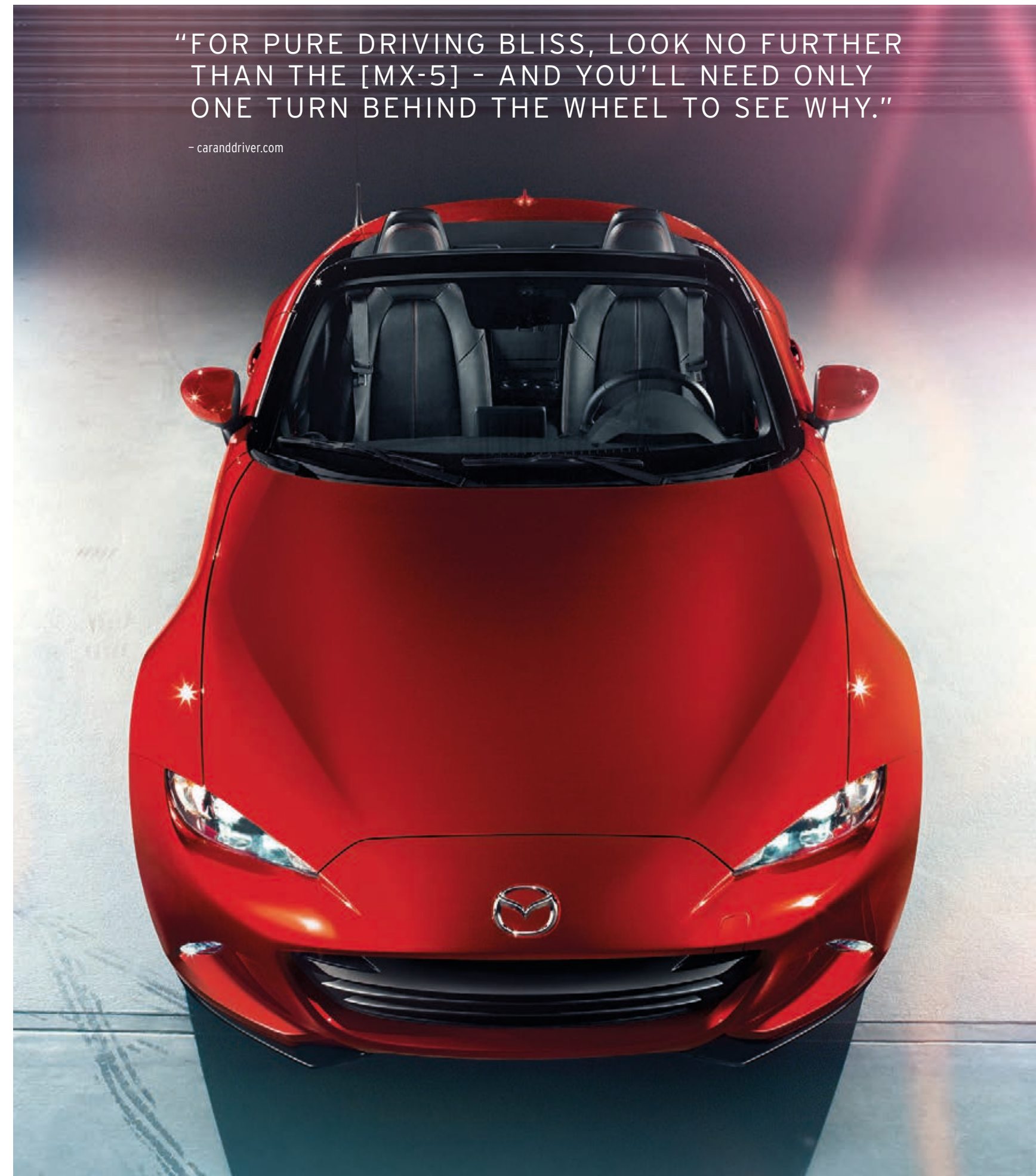

THE ALL-NEW 2017 MAZDA MX-5 RF

EXHILARATION AND PERFORMANCE UNDER ONE HARDTOP RETRACTABLE ROOF.

How does one improve upon the world's best-selling roadster? For Mazda engineers, the MX-5 RF was an exercise in retaining the iconic look and feel of its predecessor while integrating profoundly innovative technology to create a one-of-a-kind driving experience. By pioneering a retractable hardtop that flawlessly embraces its fastback design, the MX-5 RF achieves an indescribable open-air feel that's stunning to look at and even more exciting to drive.



MUSCULAR EXTERIOR. REFINED INTERIOR.

While strikingly athletic on the outside, the MX-5 RF is remarkably refined on the inside. Supple Nappa leather* cut exclusively for the RF bounds the spacious seating that accommodates and comforts drivers of any physique. The progress of the automated hardtop is indicated by a 4.6" multi-information colour display. Plus, an insulated hardtop and rear-wheel housing significantly reduce road and wind noise to provide an incredibly quiet drive.

*Available on the RF GT models with Exclusive Package and Grand Sport Package. Special order only.



ENGINEERED TO STIR YOUR SOUL.

The MX-5 RF simultaneously captivates the driver and dominates the road. Its electric power steering and suspension are specially tuned to the RF to deliver a smooth yet intensely gripping drive. With the renowned traction and stability of the MX-5 soft top, the MX-5 RF firmly hugs the pavement while retaining a sensationally lightweight, nimble feel that makes driving anything but a point A to point B exercise.





TRUE DESIGN IS MEASURED BY HOW MUCH IT MOVES YOU.

Painstaking attention to detail yielded the powerful and seductive presence of the MX-5 RF, a triumph of KODO design and a celebration of passionate driving. With its teardrop-shaped cabin, neighbored by beautiful fastback lines and an aerodynamic hood, the RF attacks the road with a rigid posture and an undeniable style. Its compact body and retractable hardtop include impressive interior and cargo space for a drive that offers both amenity and adventure.



BE ONE WITH THE ROAD AND SKY

The MX-5 RF has set the new standard in automotive engineering with its brilliantly groundbreaking retractable hardtop technology. Three sections of the electric roof overlap in motion to achieve the world's fastest retractable hardtop operation, opening and closing in only 13 seconds. With new controls allowing for operation while travelling 10 km/h or less, and the rear glass window retracting congruently with the hardtop, the MX-5 RF combines the freedom of the outdoors with the thrill of the open road.

MX-5 COLOUR COMBINATIONS

PAINT COLOURS	GX		GS		GT	
	Black Cloth with Black Stitching	Black Cloth with Red Stitching	Recaro® Seats with Black Nappa Leather and Alcantara® Trim with Red Piping	Black Leather with Red KODO Stitching	Sport Tan Leather with Tan KODO Stitching	
Crystal White Pearl	●	●	●	●	○	
Soul Red Metallic	●	●	●	●	○	
Jet Black Mica	●	●	●	●	○	
Meteor Grey Mica	●	●	●	●	○	
Blue Reflex Mica	●	●	●	●	○	
Ceramic Metallic	●	●	●	●	○	

MX-5 RF COLOUR COMBINATIONS

PAINT COLOURS	GS		GT		Chroma Brown Nappa Leather*
	Black Cloth with Red Stitching	Recaro® Seats with Black Nappa Leather and Alcantara® Trim with Red Piping	Black Leather with Red KODO Stitching	Sport Tan Leather with Tan KODO Stitching	
Crystal White Pearl	●	○	●	○	○
Soul Red Metallic	●	○	●	○	○
Jet Black Mica	●	○	●	○	○
Blue Reflex Mica	●	○	●	○	○
Ceramic Metallic	●	○	●	○	○
Machine Grey Metallic	●	○	●	○	○

● = Available ○ = Special order only *Contrasting top in piano black

WHEEL OPTIONS

16" silver finish alloy wheels (GX)



17" gunmetal finish alloy wheels (GS, RF GS)



17" BBS® forged dark finish alloy wheels (GS with Sport Package, RF GS with Sport Package, and RF GT with Grand Sport Package)



17" high-lustre gunmetal finish alloy wheels (GT, RF GT)



UPHOLSTERY

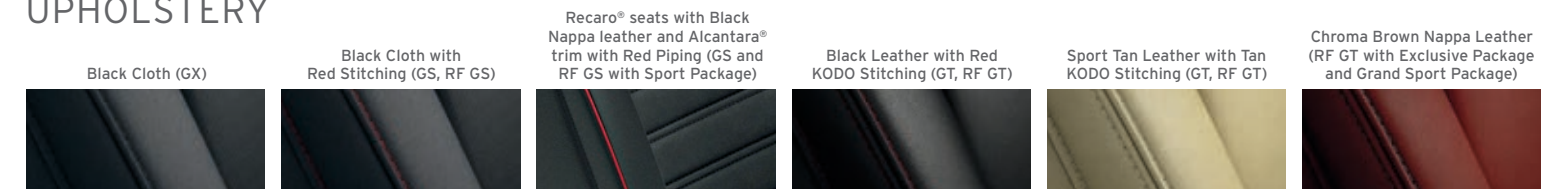

MX-5 SPECIFICATIONS AND CAPACITIES

SPECIFICATIONS	GX/GS/GT	RF GS/RF GT
Engine type	SKYACTIV-G 2.0 L DOHC 16-valve 4-cylinder	SKYACTIV-G 2.0 L DOHC 16-valve 4-cylinder
Displacement	1,998 cc	1,998 cc
Compression ratio	13.0:1	13.0:1
Horsepower SAE net	155 @ 6,000 rpm	155 @ 6,000 rpm
Torque SAE net lb. ft.	148 @ 4,600 rpm	148 @ 4,600 rpm
Fuel system	Direct Injection	Direct Injection
Recommended fuel	Premium unleaded	Premium unleaded
Fuel economy city/highway (L/100 km)*		
6MT	8.9/7.1	8.9/7.1
6AT	9.0/6.7	9.0/6.7
Curb weight (kg)		
6MT	1,058	1,114
6AT	1,078	1,131

*Estimated fuel economy based on Government of Canada's approved, revised 5-cycle testing method. Your actual fuel consumption may vary depending on how, where and when you drive. For comparison purposes only. For more information on revised 5-cycle testing, visit mazda.ca/5cycle.

EXTERIOR DIMENSIONS	MX-5	MX-5 RF
Wheelbase/overall length (mm)	2,309/3,914	2,309/3,914
Overall width mirror to mirror (mm)	1,918	1,918
Overall height (mm)		
16" wheels	1,234	-
17" wheels	1,240	1,245
Track (fr/r) (mm)	1,495/1,505	1,495/1,505
Turning circle, curb-to-curb (m)	9.4	9.4
INTERIOR DIMENSIONS		
Headroom (mm)	950	935
Legroom (mm)	1,095	1,095
Shoulder room (mm)	1,326	1,326
CAPACITIES		
Seating	2	2
Fuel tank (L)	45	45
Cargo volume (L)	130	127

CRYSTAL WHITE PEARL

SOUL RED METALLIC

JET BLACK MICA

METEOR GREY MICA

BLUE REFLEX MICA

CERAMIC METALLIC

MACHINE GREY METALLIC

MX-5 FEATURES

ENGINE & TRANSMISSION	GX	GS	GT	RF GS	RF GT
SKYACTIV-G 2.0 L DOHC 16-valve 4-cylinder engine	S	S	S	S	S
SKYACTIV-MT 6-speed manual transmission	S	S	S	S	S
6-speed automatic transmission with manual-shift mode and Drive Selection switch	0	-	-	-	-
6-speed automatic transmission with manual-shift mode, paddle shifters and Drive Selection switch	-	0	0	0	0
Front mid-engine/rear-wheel drive	S	S	S	S	S
SUSPENSION & BRAKES					
Power-assisted 4-wheel disc brakes	S	S	S	S	S
Brembo® front brakes (opposed piston design with unique rotor), red painted front and rear calipers (manual transmission only)	-	SP	-	SP	GSP
Anti-lock Brake System (ABS) with Electronic Brake Force Distribution (EBFD)	S	S	S	S	S
Front independent double-wishbone suspension with coil springs and stabilizer bar	S	S	S	S	S
Rear independent multi-link suspension with coil springs and stabilizer bar	S	S	S	S	S
Rack-and-pinion steering with rpm-sensing variable power assist	S	S	S	S	S
Front strut tower bar ¹	-	S	S	S	S
Limited-Slip Differential (LSD) ²	-	S	S	S	S
Sport suspension with Bilstein® shocks ³	-	S	S	S	S
Induction Sound Enhancer (ISE) ⁴	-	S	S	S	S
WHEELS & TIRES					
16" silver finish alloy wheels with 195/50R16 tires	S	-	-	-	-
17" gunmetal finish alloy wheels with 205/45R17 tires	-	S	-	S	-
17" BBS® forged dark finish alloy wheels	-	SP	-	SP	GSP
17" high-lustre gunmetal finish alloy wheels with 205/45R17 tires	-	-	S	-	S
Tire Pressure Monitoring System (TPMS)	S	S	S	S	S
Tire repair kit	S	S	S	S	S
SAFETY & SECURITY					
Dynamic Stability Control (DSC)	S	S	S	S	S
Traction Control System (TCS)	S	S	S	S	S
Hill Launch Assist (HLA)	S	S	S	S	S
Advanced Blind Spot Monitoring System (ABSM)	-	S	S	S	S
Rear Cross Traffic Alert (RCTA)	-	S	S	S	S
Lane Departure Warning System (LDWS)	-	-	S	-	S
Dual front and side air bags	S	S	S	S	S
Side-impact door beams	S	S	S	S	S
Engine immobilizer theft-deterrent system	S	S	S	S	S
Anti-theft alarm system	-	S	S	S	S
Driver's and passenger's seat-belt pretensioners with force limiters	S	S	S	S	S

EXTERIOR	GX	GS	GT	RF GS	RF GT
Power retractable hardtop	-	-	-	S	S
Power retractable hardtop with contrasting top in piano black	-	-	-	-	EP/GSP
Black cloth soft-folding convertible top with glass rear window	S	S	S	-	-
Convertible top cloth liner	-	-	S	-	-
Noise absorption headliner	-	-	-	S	S
Body-coloured power-operated door mirrors	S	-	S	-	S
Piano black power-operated door mirrors	-	S	-	S	GSP
Auto-dimming driver's side door mirror	-	-	S	-	S
Heated door mirrors	-	-	S	-	S
Manual foldable door mirrors	S	S	S	S	S
LED rear combination lights	S	S	S	S	S
LED headlights with signature lighting	S	S	S	S	S
LED Daytime Running Lights (DRL)	-	S	S	S	S
Automatic shut-off headlights	S	-	-	-	-
Automatic on/off headlights	-	S	S	S	S
Adaptive Front Lighting System (AFS)	-	-	S	-	S
Automatic headlight levelling	S	S	S	S	S
High Beam Control system (HBC)	-	-	S	-	S
Side turn indicator light on front fenders	S	S	S	S	S
Intermittent windshield wipers	S	-	-	-	-
Rain-sensing intermittent windshield wipers	-	S	S	S	S
Rear window defroster	S	S	S	S	S
Green tint windshield UV shield	S	S	S	S	S
Noise-isolating windshield	-	S	S	S	S
INTERIOR: AUDIO & CONNECTIVITY					
7" colour touchscreen display with MAZDA CONNECT	-	S	S	S	S
Audio display screen	S	-	-	-	-
AM/FM radio CD player with 6 speakers (including driver's headrest)	S	S	-	S	-
9-speaker premium Bose® audio system with AudioPilot® 2 noise compensation technology, AM/FM radio and CD player (with speakers in driver's and passenger's headrests)	-	-	S	-	S
MP3 functionality on CD player	S	S	S	S	S
HD Radio	-	S	S	S	S
Automatic volume control	S	S	-	S	-
USB port and auxiliary audio input jack	S	-	-	-	-
2 USB ports and auxiliary audio input jack	-	S	S	S	S

MX-5 FEATURES (CONT'D)

INTERIOR: AUDIO & CONNECTIVITY (cont'd)	GX	GS	GT	RF GS	RF GT
Voice-activated navigation system	-	S	S	S	S
HMI Commander switch	-	S	S	S	S
Steering-wheel-mounted audio and Bluetooth® controls with Audio Profile	S	S	S	S	S
Integrated Aha™ Internet Radio functionality ⁵	-	S	S	S	S
Integrated Stitcher™ Internet Radio functionality ⁶	-	S	S	S	S
SMS text message audio delivery and reply ⁷	-	S	S	S	S
SiriusXM™ Satellite Radio with fin antenna	-	-	S	-	S
INTERIOR: COMFORT & CONVENIENCE					
Air conditioning with manual climate controls	S	S	-	S	-
Air conditioning with automatic climate controls	-	-	S	-	S
Open/close button for power retractable hardtop	-	-	-	S	S
Heater/defroster with multiple-speed fan	S	S	S	S	S
Steering-wheel-mounted cruise controls	S	S	S	S	S
Tilt steering wheel	S	S	S	S	S
Speed-sensing power door locks	S	S	S	S	S
Power windows with driver's and passenger's one-touch down feature	S	S	S	S	S
Push Button Start	S	S	S	S	S
Remote keyless entry with panic mode	S	S	S	S	S
Day/night rearview mirror	S	S	-	S	-
Auto-dimming rearview mirror with HomeLink® wireless control system	-	-	S	-	S
Courtesy light on windshield header	S	S	S	S	S
Driver's and passenger's sunvisors with vanity mirrors	S	S	S	S	S
Transparent polycarbonate windblocker	-	-	-	S	S
Mesh aero board windblocker	S	S	S	-	-
Internal trunk and hood releases	S	S	S	S	S
Cargo area light	S	S	S	S	S
Dual cup holders (removable)	S	S	S	S	S
12-volt power outlet	S	S	S	S	S
INTERIOR: SEAT & TRIM					
Black cloth upholstery with black stitching	S	-	-	-	-
Black cloth upholstery with red stitching	-	S	-	S	-
Recaro® sport seats with Nappa leather- and Alcantara®-trimmed upholstery	-	SP	-	SP	-
Leather-trimmed upholstery with KODO stitching	-	-	S	-	S
Nappa leather-trimmed seats with KODO stitching	-	-	-	-	EP/GSP
Adjustable heated seats	-	SP	S	SP	S

INTERIOR: SEAT & TRIM (cont'd)	GX	GS	GT	RF GS	RF GT
6-way manually adjustable driver's seat	S	S	S	S	S
4-way manually adjustable passenger's seat	S	S	S	S	S
Integrated headrests	S	S	S	S	S
Leather-wrapped steering wheel and shift knob	-	S	S	S	S
Leather-wrapped parking brake handle	-	S	S	S	S
Body-coloured interior door trim	-	S	S	S	S
Custom-fitted floor mats	S	S	S	S	S
INSTRUMENTATION					
Trip computer	S	S	S	S	S
4.6" multi-information colour display in gauge cluster	-	-	-	S	S
Gauge illumination control	S	S	S	S	S
Exterior temperature gauge	S	S	S	S	S
Warning lights for low windshield washer fluid level, low fuel level, door ajar, check engine, oil pressure, parking brake, high beam and safety belts	S	S	S	S	S
STORAGE					
Centre console with armrest and storage	S	S	S	S	S
Lockable rear centre storage compartment	S	S	S	S	S
Driver's and passenger's back panel covered storage	S	S	S	S	S
Coin holder	S	S	S	S	S

S = Standard O = Optional SP = Sport Package EP = Exclusive Package
GSP = Grand Sport Package - = Not available

MX-5 PACKAGES

Sport Package (GS and RF GS with manual transmission): 17" BBS® forged dark finish alloy wheels, Brembo® front brakes (opposed piston design with unique rotor), red painted front and rear calipers, Recaro® sport seats with Nappa leather- and Alcantara®-trimmed upholstery, and adjustable heated seats.

Exclusive Package (RF GT): Contrasting top in piano black and Nappa leather seats.

Grand Sport Package (RF GT with manual transmission): Contrasting top in piano black, Nappa leather seats, 17" BBS® forged dark finish alloy wheels, Brembo® front brakes (opposed piston design with unique rotor), red painted front and rear calipers, power exterior mirror in piano black.

¹Available with 6-speed manual transmission only.
²Aha, Stitcher and SMS text functionality are a part of MAZDA CONNECT and are only compatible with certain devices.
© BBS is a registered trademark of BBS GmbH.
© Brembo is a registered trademark of Brembo S.p.A.
© RECARO is a registered trademark of RECARO Holding GmbH.
© Alcantara is a registered trademark of Alcantara S.p.A.
© Bluetooth is a registered trademark of Bluetooth SIG, Inc.
© Bilstein is a registered trademark of ThyssenKrupp Bilstein GmbH.
© Bose and © AudioPilot are registered trademarks of Bose Corporation.
© HomeLink and the HomeLink house are registered trademarks of Johnson Controls, Inc.
™ "SiriusXM," the SiriusXM logo, channel names and logos are trademarks of SiriusXM Radio Inc. and are used under license.

MAZDA MX-5 ACCESSORIES. IT'S YOUR MAZDA - MAKE IT YOUR OWN.

Customize your new MX-5 with Genuine Mazda Accessories. When installed by your Mazda Dealer prior to or at initial vehicle retail delivery, Genuine Mazda Accessories carry the same new-vehicle limited warranty as your new Mazda. Ask your dealer for details.



16" M009 WHEEL WITH SATIN BLACK FINISH

These satin black rims add style to match your MX-5's sleek exterior design.



ROADSIDE ASSISTANCE KIT

Be prepared to handle most travel emergencies while on the road with our Roadside Assistance Kit. Includes a folding reflective triangle, flashlight with batteries, dial tire pressure gauge, emergency blanket, rain poncho, and more!



SOFT CARGO TOTE BAG

You've got a lot more to do than shop for groceries. This roomy carrier helps you pack in plenty of supplies, then lifts out and folds away flat to free up cargo space for your next errand.*



ALLOY PEDAL SET

Add a powerful look and help improve pedal grip in your MX-5 with these high-quality aluminum Alloy Pedals and Footrest.



AERO KIT

Give your MX-5 a bold, aerodynamic stance. Accessorize your ride with our Brilliant Black Aero Kit that includes Front Air Dam Skirt, Side Sill Extensions, Rear Underskirt and Rear Trunk Spoiler. Pick and choose only the accessories you like or go all out and customize your MX-5 with all four.



VISIT MAZDA.CA FOR ACCESSORY OPTIONS.

*Please remember to properly secure all cargo.

Mazda

UNLIMITED

**CANADA'S ONLY UNLIMITED
MILEAGE WARRANTY**

STANDARD ON ALL NEW MODELS

**3-YEAR
NEW VEHICLE
UNLIMITED MILEAGE WARRANTY**

**3-YEAR
ROADSIDE ASSISTANCE
UNLIMITED MILEAGE**

**5-YEAR
POWERTRAIN
UNLIMITED MILEAGE WARRANTY**

**7-YEAR
ANTI-PERFORATION
UNLIMITED MILEAGE WARRANTY**

MAZDA VEHICLES ARE DESIGNED TO BE DRIVEN, AND TO PROVE IT, WE'VE INTRODUCED MAZDA UNLIMITED - THE ONLY WARRANTY PROGRAM OF ITS KIND IN CANADA.

Mazda Unlimited features unlimited mileage for our 3-year New Vehicle, 3-year Roadside Assistance, 5-year Powertrain and 7-year Anti-Perforation warranties, so you can focus on every thrilling moment spent behind the wheel instead of the odometer.

Standard on all new models.

What does Mazda Unlimited mean for you?

- Added confidence in the quality of the product you are driving
- Added protection, knowing Mazda will be there, kilometre after kilometre
- Added value, knowing that if you ever sell, trade or upgrade to a new vehicle during the warranty period, **Mazda Unlimited** will be transferable to the new owner
- Added peace of mind, knowing that there are no limits to how far you can go

To learn more about the Mazda Unlimited Warranty, visit mazdaunlimited.ca.



WE BUILT THE CAR. FANS BUILT THE CULTURE. THE MX-5 COMMUNITY.

With 17 Mazda MX-5 clubs across Canada, day trips, rallies, road runs, overnight excursions, track days, tech sessions, car talks and motorsports events fill our calendars. In fact, on September 5-7, 2014, more than 1,900 fans attended the 25th anniversary celebration at Mazda Raceway Laguna Seca. We are the Mazda devotees who have an unrelenting passion for driving the world's best-selling roadster. Because having bugs in the grille and our tops down on 0° mornings is how we measure a great day. Loyal fans, enthusiasts and collectors know it's a special community to belong to because like us, driving matters. Join the club.



WE KNOW YOUR FIRST IMPRESSION OF MAZDA STARTS WITH US, YOUR MAZDA DEALER.



It's a responsibility we don't take lightly. It's why we work hard every day to make sure your customer service experience exceeds your expectations, in every way.

From the factory to your first test drive, and to every drive you'll ever make in a Mazda, we're here to make driving better.

BECAUSE DRIVING MATTERS.

FINANCING WITHOUT THE FUSS Whether you're buying or leasing a new Mazda, or a used vehicle, Mazda Financial Services can help make the financing process more convenient and satisfying. Mazda Financial Services is known for first-class customer service, a wide range of financing options and highly competitive rates. To find out which purchase or lease plan is right for you, talk with your Mazda Dealer or visit mazda.ca.

MAZDA ROADSIDE ASSISTANCE PROGRAM As part of our commitment to your total satisfaction, 2017 MX-5 owners are automatically enrolled in our Roadside Assistance Program. Roadside Assistance protects your MX-5 for the duration of the 3-year basic limited warranty. Should you require assistance during this period, our service will help to get your vehicle back on the road and minimize any inconvenience. For complete details on this program, see your Mazda Dealer or visit mazda.ca.

MAZDA MOBILITY ASSISTANCE PROGRAM Mazda Canada believes that vehicle access is vital for everyone. Under this program, physically challenged customers who purchase or lease a new, unused Mazda vehicle may be eligible to receive assistance from Mazda Canada Inc. to aid with the cost of acquiring and installing adaptive driving aids on their vehicle. For complete details on this program, see your Mazda Dealer.

MAZDA TEST-DRIVE EXPERIENCE Exhilaration begins with the Mazda Test-Drive Experience - a uniquely designed road trip engineered to take you miles beyond the ordinary test-drive. Down local streets, on-ramps, highways and off-ramps. Through straightaways, S-curves and corners. It's all about putting a Mazda to the test under real-world conditions. It's about discovering the superb acceleration, braking, steering, handling and ride quality that every Mazda offers. And rediscovering that fun, connected-to-the-road feeling we call Zoom-Zoom.

READY TO ROLL Our pre-delivery commitment means every new Mazda is inspected, gassed up and fitted with floor mats.



ADDED PROTECTION

For peace-of-mind motoring, we've created Mazda Added Protection Plan (M.A.P.) extended warranty plans. M.A.P. plans complement your Mazda Limited Warranty and protect you from unexpected repair expenses and the rising cost of repairs. All M.A.P. plans include Personal Budget and Repair Inflation Protection. In addition, all M.A.P. plans include Premium Roadside Assistance, Tire Road Hazard coverage and OEM Collision Part Coverage. Premium Roadside Assistance extends the roadside assistance coverage offered during the new-vehicle limited-warranty period throughout the M.A.P. term. The Premium Roadside Assistance offers Towing, Winching, Battery Boost, Out-of-Fuel Coverage, Tire Service, Lockout Service, Emergency Travel Expense Reimbursement and Travel Planning and Dealer Locator. Should you ever decide to sell your Mazda vehicle, M.A.P. is transferable to future owners and will enhance the resale value of your vehicle. The Mazda Added Protection Plan is fully backed and administered by Mazda Canada Inc. For more information, please contact your Mazda Dealer.



GRADUATE PROGRAM

Ask your dealer about Mazda's competitive program for recent university and college graduates.

Product changes and options availability: Following publication of this brochure, certain changes in standard equipment, options, prices and the like, or product delays may have occurred which would not be included in these pages. Your Mazda Dealer is your best source for up-to-date information. Mazda reserves the right to change product specifications at any time without incurring obligations. Options and accessories shown or described in this brochure are available at extra cost and may be offered only in combination with other options or subject to additional ordering requirements or limitations. E. & O. E.

ZOOM-ZOOM



Find out more on:



Get more detailed information on your MX-5 and MX-5 RF. Check out our website at mazda.ca for specifications and features, option packages, pricing, financing, to get a quote and find a dealer near you.

© 2016 Mazda Canada Inc., 55 Vogell Road, Richmond Hill, Ontario L4B 3K5 Printed in Canada Part No. 9999-92-X517-EN



DRIVING MATTERS

