



CITROËN

C8



C8
INFINITELY
LUXURIOUS

INNOVATIVE AND STYLISH. TAKE YOUR FIRST LONG LOOK AT THE CITROËN C8 AND THE UNIQUE BLEND OF PERSONALITY AND DISTINCTIVE DESIGN IS EVIDENT.

A VAST TWO SQUARE METRE PANORAMIC WINDSCREEN OFFERS UNRIVALLED VISIBILITY. IT COMBINES WITH THE PLUNGING BONNET TO CONVEY A STYLISH FLUIDITY OF LINE AND FORM THAT YOU JUST WON'T FIND AMONGST THE REST. TAKE A CAREFUL LOOK AT THE GENEROUS TEARDROP HEADLAMPS, THE 'FLAG-TYPE' DOOR MIRRORS, THE CHROME EFFECT ELONGATED DOOR HANDLES, AND THE SLIMLINE VERTICAL REAR LIGHT CLUSTER. THIS SENSE OF DISTINCTIVE STYLING IS CONVEYED THROUGHOUT THE CABIN TOO.



DIESEL ENGINE AVAILABILITY

	LX	SX	EXCLUSIVE
2.0HDi 16V 120hp	•	•	
2.0HDi 16V 136hp DPFS†		•	•
2.2HDi 16V 173hp Auto		•	•

† Diesel Particulate Filter System

CITROËN C8 - LX FEATURES:

- ABS with Electronic Brakeforce Distribution (EBD) and Emergency Braking Assistance (EBA)
- Electronic Stability Programme (ESP) with traction control
- Driver's, passenger's, front lateral and side window airbags
- Body colour painted bumper skirts and door mirrors
- High-frequency remote control central locking with deadlocks and dashboard mounted control
- Rear twin sliding side doors
- Automatic digital air conditioning with dual-zone temperature setting
- Front fog lights
- Front electric windows with 'one-touch' operation and anti-pinch
- Blackout tailgate window
- Five full size individual, sliding, foldable and removable rear seats
- Quickfix® instant anchorage system
- 16" steel wheels with 'Narcisse' wheel covers (set of four)
- RDS stereo radio/MP3 compatible CD player with steering mounted controls

CITROËN C8 - SX FEATURES: (ADDITIONAL TO LX)

- Body colour painted bumpers and side rubbing strips with chrome inserts
- Twin electric rear sliding side doors with anti-pinch function
- Automatic digital air conditioning with tri-zone temperature setting
- Anti-theft alarm
- Heat-reflecting windscreen
- Middle electric windows with 'one-touch' operation and anti-pinch
- 'Guide-me-home' headlamp function
- Child surveillance mirror
- Adjustable and foldable front seat armrests
- Electrically foldable door mirrors
- Aircraft style tables on back of front seats
- Electrochrome rear view mirror
- Cruise control with speed limiter
- Leather steering wheel and gear knob
- 16" 'Ispahan' alloy wheels - set of four (2.2HDi Auto only)
- Boot net

CITROËN C8 - EXCLUSIVE FEATURES: (ADDITIONAL TO SX)

- Chrome effect rear spoiler with integrated roof bars
- 16" 'Ispahan' alloy wheels (set of four)
- Blackout side windows
- Mistral 'Claudia' leather
- Front electric seats with memory function for driver's seat
- Front heated seats
- Front and rear parking sensors
- Bi-Xenon headlamps with washer jets
- Tyre pressure monitor



C8

ERGONOMIC
TECHNOLOGY



COMFORT AND FLEXIBILITY. THE CITROËN C8 CAN ADAPT WITH EASE TO CATER FOR THE CHANGING DEMANDS OF YOUR LIFESTYLE.

THE THREE ROWS OF SEATING CAN ACCOMMODATE UP TO EIGHT PEOPLE. ALL MODELS FEATURE SEVEN INDIVIDUAL FULL-SIZE SEATS. A THIRD-ROW THREE-SEAT PASSENGER BENCH CAN ALSO BE SPECIFIED AT NO EXTRA COST ON LX AND SX MODELS. ALL INDIVIDUAL REAR SEATS ARE RAKE AND REACH ADJUSTABLE AND, THANKS TO A BROAD HIGH BACKREST THAT IS SLIGHTLY CURVED AT THE BASE, THEY ALSO PROVIDE EXCELLENT LUMBAR SUPPORT.



Flexibility is further assured with the use of the patented Quickfix® instant anchoring system. All the rear seats can slide a distance of 15cm by means of rails and be easily folded, installed or removed completely in a matter of seconds. Invaluable when you need that extra storage space for a bulky item or perhaps to provide easier access to the third row of seats.



OPTIONS YOU WON'T WANT TO BE WITHOUT

Whether you wish to enhance the vehicle's appearance, add to its convenience, storage or safety features, or enjoy its high-quality in-car entertainment including the 6-CD autochanger and satellite navigation systems, we have the solution for you.

1. NaviDrive Pack (option)

The advanced NaviDrive technology incorporates a navigation system with European mapping and live traffic information, Bluetooth® system, address book, an RDS stereo radio/MP3 compatible CD player and a 30GB hard drive with the ability to upload 650 hours of your favourite music.

2. Parcel shelf (accessory)

The generous boot features a parcel shelf that also acts to shield your luggage from view.

For information on the full range of accessories available, contact your local Citroën Dealer or visit www.accessories.citroen.co.uk

COMFORT IN ALL ITS FORMS

The trouble is, some may want to heat it up and others to cool it down. Either way, the C8 has it covered. As you would expect, all models feature automatic digital air conditioning. But our advanced system has been designed to give each occupant control over their own zone's climate. Seven front air vents facilitate independent temperature control for the driver and front passenger.

The second and third rows of seats (from SX models) are each serviced by four air vents, to ensure air-flow throughout the rest of the cabin. Also included as part of the air conditioning system is a clever sensor that automatically adjusts the air temperature according to the intensity of direct sunlight.



Check it out. The C8 provides a host of storage compartments. Your only problem may be remembering where you put what!



C8

COLOURS,
TRIMS, WHEELS
& OPTIONS

DISTINCTIVE DESIGN. THE C8'S EXTERNAL GOOD LOOKS ARE WELL-MATCHED BY THE INTERIOR STYLE AND THE CAREFULLY CHOSEN COLOURS, TRIMS, WHEELS AND OPTIONS.

16" 'NARCISSE' WHEEL COVERS

Set of four
Tyres: 215/60 R16

LX

SX

EXCLUSIVE



16" 'ISPAHAN' ALLOY WHEELS

Set of four
Tyres: 215/60 R16

LX

SX

EXCLUSIVE

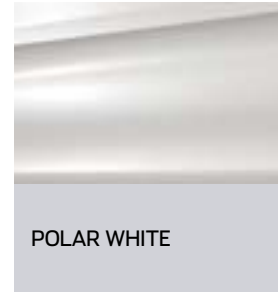

POLAR WHITE

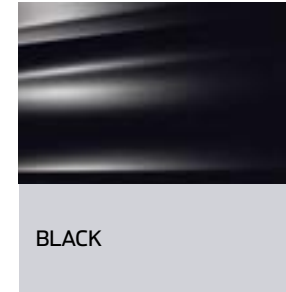

BLACK



ARCTIC STEEL
(METALLIC)

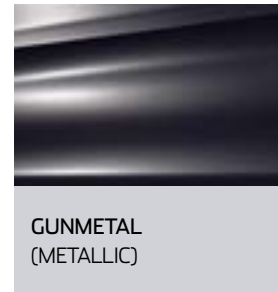

GUNMETAL
(METALLIC)

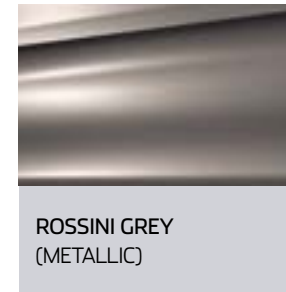

ROSSINI GREY
(METALLIC)



KYANOS BLUE
(METALLIC)



MANITOBA GREY
(METALLIC)

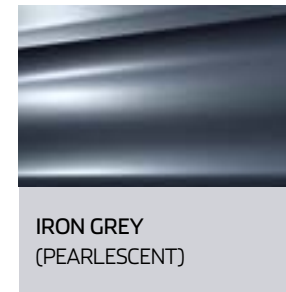

IRON GREY
(PEARLESCENT)

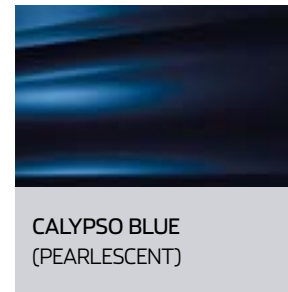

CALYPSO BLUE
(PEARLESCENT)

• Standard equipment

1 Excludes 2.2HDi Auto models

2 2.2HDi Auto models only

Please note: Colours and pictures shown are for illustration purposes only. Please consult your Dealer for definitive colour and trim/upholstery details.



OPTION SUMMARY

	LX	SX	EXCLUSIVE
Third row bench seat for three passengers	o ³	o ³	
VIP Pack - blackout side windows, aluminium effect rear spoiler with integrated roof bars and rear parking sensors		o	
Three electric slide/tilt sunroofs with sunblinds		o	o
NaviDrive Pack - RDS stereo radio/MP3 compatible CD player, colour satellite navigation, live traffic information, European mapping, Bluetooth® system and 30GB hard drive		o ⁴	o ⁴
Black paint	o	o	o
Metallic/Pearlescent paint	o	o	o

'YMER' CLOTH

STANDARD ON LX

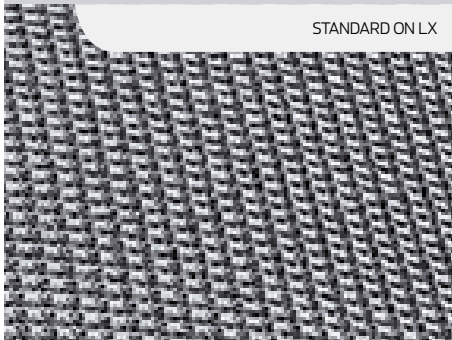

MISTRAL 'REPS' WOVEN CLOTH

STANDARD ON SX

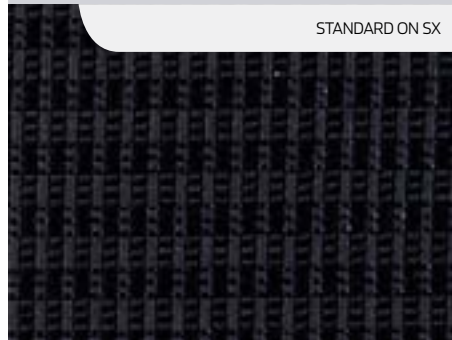

MISTRAL 'CLAUDIA' LEATHER

STANDARD ON EXCLUSIVE



o Optional factory fitted equipment

³ No cost option

⁴ Mobile phone compatibility can vary by phone manufacturer. Please consult your Dealer for further compatibility information.

C8

EQUIPMENT SPECIFICATION



	LX	SX	EXCLUSIVE
SAFETY & SECURITY			
ABS with Electronic Brakeforce Distribution (EBD)	•	•	•
Emergency Braking Assistance (EBA)	•	•	•
Electronic Stability Programme (ESP) with traction control	•	•	•
Driver's airbag	•	•	•
Front passenger's airbag with cut-off device	•	•	•
Front lateral airbags	•	•	•
Front, middle and rear passengers' side window airbags	•	•	•
Energy absorbing side impact protection	•	•	•
Front and two outer middle seats height-adjustable seat belts	•	•	•
Front and two outer middle seats seat belt pre-tensioners with force-limiters	•	•	•
3-point inertia reel seat belt on central seat in row 2	•	•	•
Fuel cut-off device	•	•	•
Automatic activation of hazard warning lights (in case of rapid deceleration or impact)	•	•	•
High-frequency multi-function remote control central locking with deadlocks and dashboard mounted control	•	•	•
High-frequency multi-function plip remote control central locking with folding ignition key (locking, unlocking and remote window closing)	•		
High-frequency multi-function plip (x 2) remote control central locking with folding ignition key (locking, unlocking, remote window closing and separate opening and closing of electric twin sliding side doors)		•	•
Transponder immobiliser	•	•	•
Anti-theft alarm (perimetric and volumetric)		•	•
Automatic re-locking after 30 seconds (when using plip - if the doors and boot remain unopened)	•	•	•
Automatic door and boot locking (when car in motion)	•	•	•
High level third brake light	•	•	•
Two outer rear seats Isofix child seat anchorage points in row 2	•	•	•
Child surveillance mirror		•	•
Electric child locks for rear sliding side doors and windows in row 2 with dashboard mounted control	• ¹	• ¹	• ¹
Tyre pressure monitor			•
DRIVER INFORMATION			
Self-programmable audible over-speed warning	•	•	•
3-in-1 glass sphere centre instruments (speedometer, rev counter, fuel level and coolant temperature)	•	•	•
Multi-function on-board trip computer (radio, time, external temperature, date, current fuel consumption, average fuel consumption, distance covered, average speed, range on remaining fuel and warning messages)	•	•	•
Steering wheel mounted multi-function display (maintenance, oil level and warning indicators plus odometer. Includes selected gear display on automatic models)	•	•	•
Door-ajar warning (driver's and passenger's doors, tailgate and bonnet)	•	•	•

	LX	SX	EXCLUSIVE
STYLE			
EXTERIOR			
Body colour painted bumper skirts	•	•	•
Body colour painted bumpers and side rubbing strips with chrome inserts	•	•	•
Body colour painted door mirrors	•	•	•
16" steel wheels with 'Narcisse' wheel covers (set of four)	•	• ²	
16" 'Ispahan' alloy wheels (set of four)		• ³	•
Vertical slimline rear light cluster shape	•	•	•
'Flag' type door mirrors with integrated side repeaters	•	•	•
Chrome effect tailgate handle and 2-in-1 door handles	•	•	•
Chrome effect bar on front grille	•	•	•
Chrome effect rear spoiler with intergrated roof bars			•
Blackout tailgate window	•	•	•
Blackout side windows on row 2 and 3			•
INTERIOR			
Aluminium effect inserts on dashboard, dial surrounds and air conditioning surround	•	•	•
Aluminium effect door handles	•	•	•
Aluminium effect head restraint bars			•
Aluminium front door sills			•
Chrome effect gear knob insert	•	•	•
Leather steering wheel		•	•
Leather gear knob		•	•
LIGHTING & VISIBILITY			
Automatic illumination of interior lights when vehicle is unlocked or doors opened	•	•	•
Front fog lights	•	•	•
Twin rear fog and reversing lights	•	•	•
Courtesy light in rows 2 and 3	•	•	•
Front reading lights	•	•	•
Reading lights in row 2	•	•	•
Reading lights in row 3		•	•
Electrochrome rear view mirror		•	•
Automatic rain-sensitive windscreen wipers and automatic illumination of headlamps		•	•
'Butterfly' style windscreen wipers with integrated washer jets	•	•	•
Speed sensitive windscreen wipers	•		
Automatic rear wiper (when reverse gear is engaged and front wipers on)	•	•	•
'Guide-me-home' headlamp function		•	•
Bi-Xenon headlamps for main and dipped beam			•
Headlamp washer jets			•
Footwell lighting		•	•

• Standard equipment

○ Optional factory fitted equipment

¹ Includes electric child lock for sunroofs when optional sunroofs are ordered

² Excludes 2.2HDI models

³ 2.2HDI Auto models only

⁴ Part of optional VIP Pack

⁵ Not supplied when optional NaviDrive Pack is ordered

	LX	SX	EXCLUSIVE
COMFORT & CONVENIENCE			
Rear twin sliding side doors	•		
Rear twin electric sliding side doors with anti-pinch function		•	•
Variable power assisted steering	•	•	•
Height and reach adjustable steering wheel	•	•	•
Dashboard mounted gear lever	•	•	•
Cruise control with speed limiter		•	•
Electrically adjustable and heated door mirrors	•	•	•
Electrically foldable door mirrors		•	•
Aircraft style tables on rear of front seats		•	•
Fold down table with integrated cup holders on back of row 2 and 3 seats	•	•	•
Front parking sensors			•
Rear parking sensors		○ ⁴	•
12 volt socket on base of driver's seat			● ⁵
12 volt socket in rear		•	•
Driver's and front passenger's sunvisor with covered courtesy mirror	•		
Driver's and front passenger's sunvisor with covered illuminated courtesy mirror		•	•
Automatic digital air conditioning with dual-zone temperature setting (separate temperature controls for driver and front passenger, side and floor air vents in row 2 and sunlight sensor)	•		
Automatic digital air conditioning with tri-zone temperature setting (separate temperature controls for driver and front passenger, side air vents for row 2 passengers with separate air flow control, floor air vents for row 2 passengers, side air vents for row 3 passengers and sunlight sensor)		•	•
Heat-reflecting windscreen		•	•
Pollen filter	•	•	•
Front electric windows with 'one-touch' operation and anti-pinch	•	•	•
Front electric windows with 60 second operating period after the ignition is switched off	•	•	•
Middle electric windows with 'one-touch' operation and anti-pinch		•	•
Middle electric windows with 60 second operating period after the ignition is switched off and if rear sliding side doors remain unopened		•	•
Rear opening quarter lights	•	•	•
Middle window retractable sunblinds		•	•
Retractable quarter light sunblinds		•	•
IN-CAR ENTERTAINMENT			
RD4 stereo radio/MP3 compatible CD player with eight speakers and steering mounted controls	•	•	•
Speed sensitive stereo volume	•	•	•

	LX	SX	EXCLUSIVE
SEATING			
Five individual sliding, foldable and removable rear seats	•	•	•
Quickfix® anchorage system	•	•	•
Height-adjustable driver's seat	•	•	•
Lumbar adjustment on driver's seat		•	•
Swivelling front seats		•	•
Adjustable and foldable front seat armrests		•	•
Height and tilt adjustable front head restraints	•	•	•
Front electric seats with memory function for driver's seat			•
Front heated seats			•
Interchangeable outer rear seats on row 2 and 3	•	•	•
Reclining backrests on all rear seats	•	•	•
Retractable head restraints on all rear seats	•	•	•
STORAGE			
Front seat back pockets	•	•	•
Rear door storage compartments with bottle, can holders and A4 size document holder	•	•	•
Twin dashboard mounted lidded storage compartments for driver and front passenger, with integrated multiple CD holder on front passenger's side	•	•	•
Illuminated and lockable front passenger glovebox	•	•	•
Multi-function drawer at the base of the centre console, with 12 volt socket, can holder and ashtray	•	•	•
Air conditioned storage compartment at the base of the centre console including three can holders	•	•	•
Storage compartment under steering column	•	•	•
Storage bins under front passenger's seat		•	•
Storage bins under driver's seat			•
Front door storage compartments with bottle and can holders	•	•	•
Rear parcel shelf	•	•	•
Six lashing eyes in the boot	•	•	•
Storage compartments in the boot	•		
Boot net		•	•

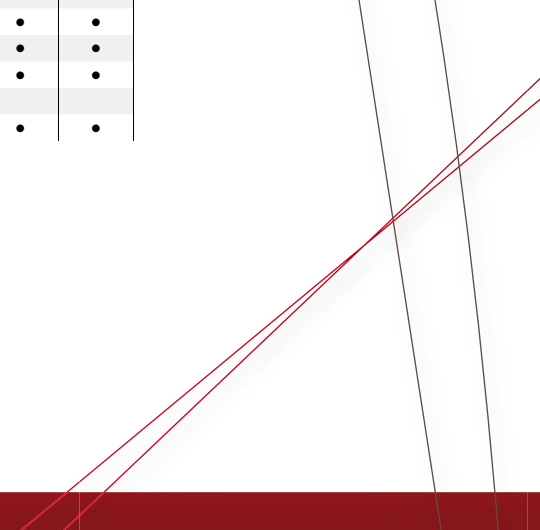

C8

TECHNICAL SPECIFICATION



2948 dm³
2948 dm³ of loadspace
on all models



6-speed
6-speed manual and auto
transmissions available
on all models

† Diesel Particulate Filter System

ENGINE	
Capacity (cc)	1997
Cylinders	4 in line
Bore and stroke (mm)	85.0 x 88.0
Max power DIN (hp/rpm)	120/4000
Max torque DIN (lb.ft/rpm)	221/2000
Fuel system	High pressure direct diesel injection
TRANSMISSION	
Six speed manual	•
Six speed automatic	•
Clutch type	Dry single plate
(All figures driver alone) PERFORMANCE	
Max speed (mph)	112
0-62mph (secs)	12.9
Standing 1000m (secs)	34.3
(Official Government test fuel consumption figures) ECONOMY Litres/100km (mpg)	
Urban cycle	8.8 (32.1)
Extra urban	5.8 (48.7)
Combined	6.9 (40.9)
CO₂ EMISSIONS (g/km)	
	182
Please note: the maximum plated weights must not be exceeded WEIGHTS (kg)	
Kerb weight	1736
Max laden weight	2530
Max towing weight braked	1800
Max tow hitch download	72
Max roof rack load	100
BRAKES	
	Servo assisted hydraulic dual circuit brakes. Front and rear discs. ABS with EBD and Emergency Braking Assistance (EBA)
STEERING	
Number of turns lock to lock	3.25
Turning circle between kerbs (m)	11.62
SUSPENSION	
	Front and rear hydraulic dampers with anti-roll bars. Front pseudo MacPherson strut/coil springs. Rear independent trailing arms/coiled springs.
FUEL TANK CAPACITY Litres (gallons)	
	80 (17.6)
EXTERIOR DIMENSIONS (mm)	
Length	4727
Width	1854
Height	1856
Wheelbase	2823
BOOT VOLUME & DIMENSIONS (dm³)	
3 rows of seats in place – at top of back of seat level – min / max	225 / 480
2 rows of seats in place – at top of back of seat level – max	1160
1 row of seats in place – at top of back of seat level – max	2264
1 row of seats in place – up to roof level – max	2948

DIESEL MODELS

	2.0HDi 16V (120hp)	2.0HDi 16V (136hp) DPFS†	2.2HDi 16V (173hp) Auto
Capacity (cc)	1997		2179
Cylinders	4 in line		
Bore and stroke (mm)	85.0 x 88.0	85.0 x 88.0	85.0 x 96.0
Max power DIN (hp/rpm)	120/4000	136/4000	173/4000
Max torque DIN (lb.ft/rpm)	221/2000	236/2000	295/1750
Fuel system	High pressure direct diesel injection		
TRANSMISSION			
Six speed manual	•	•	•
Six speed automatic			
Clutch type	Dry single plate	Dry single plate	N/A
(All figures driver alone) PERFORMANCE			
Max speed (mph)	112	118	122
0-62mph (secs)	12.9	11.4	10.8
Standing 1000m (secs)	34.3	33.4	32.1
(Official Government test fuel consumption figures) ECONOMY Litres/100km (mpg)			
Urban cycle	8.8 (32.1)	9.0 (31.4)	11.0 (25.7)
Extra urban	5.8 (48.7)	6.0 (47.1)	6.6 (42.8)
Combined	6.9 (40.9)	7.1 (39.8)	8.2 (34.4)
CO₂ EMISSIONS (g/km)			
	182	188	218
Please note: the maximum plated weights must not be exceeded WEIGHTS (kg)			
Kerb weight	1736	1743	1818
Max laden weight	2530	2530	2610
Max towing weight braked	1800	1850	1870
Max tow hitch download	72	72	75
Max roof rack load	100	100	100
BRAKES			
	Servo assisted hydraulic dual circuit brakes. Front and rear discs. ABS with EBD and Emergency Braking Assistance (EBA)		
STEERING			
Number of turns lock to lock	3.25		
Turning circle between kerbs (m)	11.62		
SUSPENSION			
	Front and rear hydraulic dampers with anti-roll bars. Front pseudo MacPherson strut/coil springs. Rear independent trailing arms/coiled springs.		
FUEL TANK CAPACITY Litres (gallons)			
	80 (17.6)		
EXTERIOR DIMENSIONS (mm)			
Length	4727		
Width	1854		
Height	1856		
Wheelbase	2823		
BOOT VOLUME & DIMENSIONS (dm³)			
3 rows of seats in place – at top of back of seat level – min / max	225 / 480		
2 rows of seats in place – at top of back of seat level – max	1160		
1 row of seats in place – at top of back of seat level – max	2264		
1 row of seats in place – up to roof level – max	2948		

ESSENTIAL CARE.

CITROËNS ARE RENOWNED FOR THEIR RELIABILITY – AND THE CITROËN C8 IS NO EXCEPTION. WITH THE ADDED REASSURANCE OF A WARRANTY, ROUTINE SERVICING AND MAINTENANCE, AS WELL AS 24-HOUR ROADSIDE ASSISTANCE, YOU ARE PROTECTED AT EVERY TURN.

CITROËN ADVANTAGE

Enjoy your Citroën for years to come with Citroën Advantage. This extended warranty gives you long-term cover if you're planning to keep your new Citroën for more than three years, or anticipate your mileage to be more than 60,000 miles over this time.

To find out more, contact your Citroën Dealer or call the Customer Contact Centre on 0844 463 3500.

CITROËN MAINTENANCE

From roadside assistance to replacing wear and tear parts or regular servicing, with Citroën Maintenance you have total peace of mind. For a one-off fee or low monthly payment, our experienced engineers will take care of your Citroën, whatever happens.

To find out more, contact your Citroën Dealer or Citroën authorised repairer.

CITROËN ASSISTANCE

For all models except C6: In response to a free telephone call, Citroën Assistance brings rapid expert roadside assistance to you in an emergency. It comes free of charge for a full year and operates 24 hours a day in all parts of the UK and Europe. Services include nationwide recovery for both car and passengers, a home call service, replacement vehicle, hotel accommodation and vehicle storage if required. Please note, Citroën Assistance only applies to incidents covered by the new vehicle warranty, and excludes non-vehicle faults, such as running out of fuel, mis-fuelling, loss of keys, lock-ins, road traffic accidents and punctures/wheel changes. C6: Citroën Assistance covers all incidents and for a period of 3 years. Full details are available on request from Citroën UK via cuk_contactcentre@citroen.com

CITROËN WARRANTY

Every new Citroën car has the benefit of a 3 year* warranty package, plus a 12 year anti-perforation** warranty and a 3 year paint warranty.



C8
CARE, FINANCE
& INSURANCE

DRIVE YOUR WAY.

GET BEHIND THE WHEEL OF YOUR NEW C8, WITH CITROËN'S DRIVENOW RANGE OF FINANCE AND CAR INSURANCE PRODUCTS. HERE YOU CAN FIND EVERYTHING YOU NEED FOR AN ENJOYABLE MOTORING EXPERIENCE. LET YOUR JOURNEY BEGIN...



Own your vehicle with this flexible package designed to fit your budget.



A new Citroën car every two or three years with monthly payments structured to suit your budget.



Enjoy the convenience of a new car without the stress and hassle of ownership.

TO FIND OUT MORE ABOUT CITROËN PRODUCTS AND SERVICES, GO TO WWW.CITROEN.CO.UK OR CONTACT YOUR CITROËN DEALER.



A tried and tested finance package that allows you to own your vehicle.



An alternative to vehicle ownership that allows you to control your business cash flow and gain tax efficiencies.



Own a vehicle with a finance solution that offers ultimate flexibility to complement your business cash flow.



A non ownership finance solution that keeps costs fixed and risks low.

FOR MORE INFORMATION ON CITROËN FLEET AND BUSINESS SALES, PLEASE CALL CITROËN FLEET CONNECT ON **08457 940 940** OR LOOK US UP AT WWW.CITROEN.CO.UK/FLEET

*** Citroën Insurance is arranged by Banque PSA Finance and underwritten by UK Insurance Limited. Conditions apply. Full details available on request. Credit subject to status and to over 18s only. A guarantee may be required. Written quotations available on request from Citroën Financial Services, Quadrant House, Princess Way, Redhill, Surrey RH1 1QA. Citroën Financial Services is a trading name of Banque PSA Finance. Telephone calls may be recorded or monitored for training or quality purposes.

* 2 years' manufacturer's warranty. No-fee customer option of 1 year's Dealer provided extended warranty, only on cars sourced from Citroën UK Limited. Note: dealer provided warranty is limited to 60,000 miles for cars and 100,000 miles for light commercial vehicles.

** Against all internal to external perforation to bodywork or underbody on condition the car undergoes an inspection by a Citroën franchised Dealer every two years from its fourth anniversary.

+ Lines open 8am - 8pm weekdays, 9am - 5pm Saturdays. Max call charge from a BT landline is 8p per minute. Calls from other networks may vary.

CITROËN INSURANCE*** IS THE ONLY MOTOR INSURANCE DESIGNED SPECIFICALLY FOR CITROËN DRIVERS, WITH COVER DESIGNED AROUND YOUR NEEDS.



To help you drive away your new car without delay, we offer DRIVENOW Instant Cover insurance, providing you with 7 days comprehensive car insurance, for free!



Simply put, Citroën Insurance offers real benefits, quality support and the usual high standards you can expect from a big name brand.

CALL US TODAY ON **0870 024 2725** AND DISCOVER MOTOR INSURANCE DESIGNED EXCLUSIVELY FOR CITROËN DRIVERS.†

...AND EVEN MORE!

Whether you want protection against unforeseen circumstances that may affect your ability to make your monthly payment, or financial protection against a 'total loss' insurance claim, we will have a DRIVENOW product to suit your needs. And you have the confidence of knowing it's all backed up by the brand you know and love, Citroën!

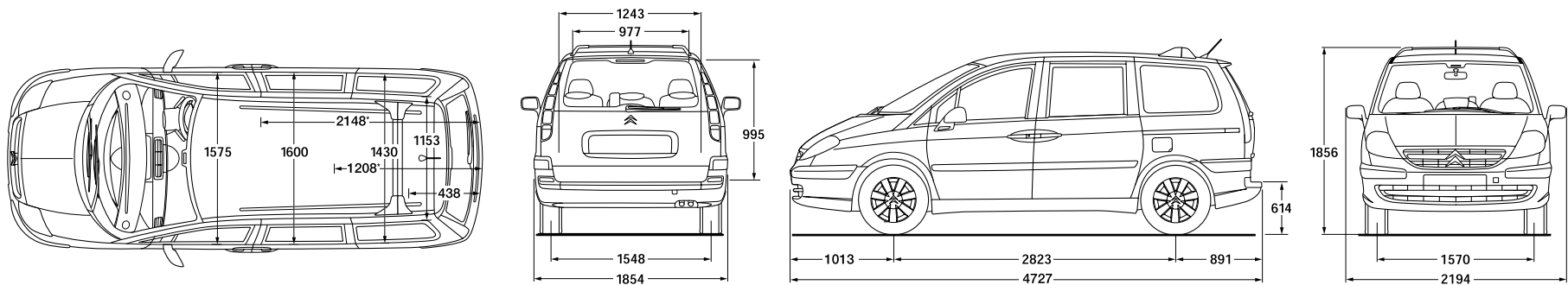

All measurements are in millimetres.

*Measurement when rows of seats positioned in middle of rails



Citroën UK Ltd. 221 Bath Road, Slough SL1 4BA.
www.citroen.co.uk



This brochure is made from paper from a sustainable and well-managed forest. Citroën support responsible use of forest resources.

Please don't throw me away, give me to a friend or recycle me.

NOTE: Every endeavour has been made to ensure that the information contained in this leaflet was accurate at the date of going to press January 2009. The Company however, reserves the right, whilst preserving the essential characteristics of the models described, to introduce at any time modifications, changes of details, equipment or accessories as may be considered necessary to improve the models described or for any other reason of a constructional or operational nature.

CITROËN prefers TOTAL

K11197 DESIGNED AND PRODUCED BY PEXTON SEARLE 01923 244241