



NEW CITROËN C4 PICASSO























# A NEW FORM OF FEEL GOOD. THE NEW CITROËN C4 PICASSO MAKES EACH DAY EASIER AND MORE ENJOYABLE THROUGH PURE INNOVATION. YOU'LL FEEL GOOD FROM THE VERY FIRST MOMENT.

STYLISH AND SPACIOUS, IT HAS BAGS OF STUNNING DETAILS AND THE LATEST FEATURES: THIS IS AN INSPIRING, HIGHLY EQUIPPED PLACE TO TRAVEL. TECHNICALLY ADVANCED BUT BEAUTIFULLY SIMPLE, NEW CITROËN C4 PICASSO TAKES FEEL GOOD FURTHER.

> CONTENTS: **8** INTRODUCTION **10** COMPACT ELEGANCE **12** INSIDE **14** SPACE & FLEXIBILITY **16** INNOVATIVE TECHNOLOGY  
**18** SAFETY **20** ENVIRONMENTAL **22** RANGE OVERVIEW **26** OPTIONS **27** COLOUR, TRIM & WHEEL OPTIONS  
**28** EQUIPMENT SPECIFICATION **30** TECHNICAL SPECIFICATION **32** ACCESSORIES **33** ENVIRONMENTAL COMMITMENT  
**34** FINANCE, CARE & INSURANCE **35** GLOSSARY & DIMENSIONS

Images and specification descriptions are dependent on trim level and options specified.

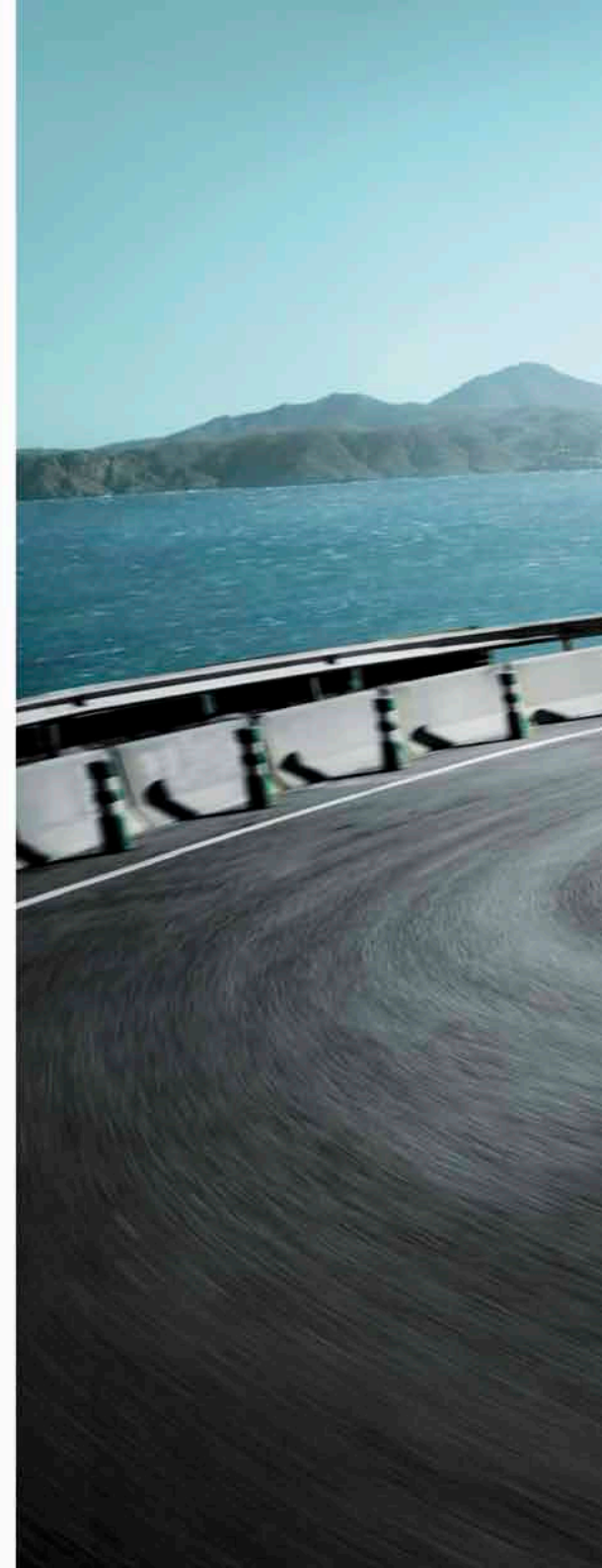





# COMPACT ELEGANCE. TAKE A LOOK AROUND THE OUTSIDE AND YOU'LL SENSE IT INSTANTLY: THE NEW CITROËN C4 PICASSO HAS PRESENCE AND PERSONALITY.

ALTHOUGH IT'S USEFULLY COMPACT FOR BUSY STREETS AND TRICKY MANOEUVRES, THE SWEEPING CURVES OF THE GLASS SURFACES, LOWERED ROOFLINE AND BOLD SCALLOPED FORMS OF THE BODYWORK GIVE THE NEW CITROËN C4 PICASSO A CHARISMATIC PROFILE.



## › EXCEPTIONAL DETAILS

Powerful, bright and beautifully designed halogen twin-optic headlights and daytime-running LEDs, make the face of the New Citroën C4 Picasso unmistakable. So does the proud sweep of the double chevron grille. At the rear you'll find a clamshell tailgate that houses the light clusters and an integrated spoiler – it's uncluttered, confident and seriously practical too. 3D effect LED lights can be chosen to add a really prestigious flourish. Door handles are solidly sculpted and a pleasure to use.













# SPACE AND LUXURY IN HIGH DEFINITION. SETTLE INTO THE ROOMY PREMIUM QUALITY INTERIOR AND YOU'LL FIND THAT THE ELEGANTLY SIMPLE DASHBOARD IS BASED AROUND TWO CRYSTAL CLEAR SCREENS.

THE LOWER 7" SCREEN PUTS ALL ESSENTIAL FUNCTIONS AT YOUR FINGERTIPS, SUCH AS DUAL ZONE AIR CONDITIONING, MEDIA AND SATELLITE NAVIGATION. THE UPPER 12" SCREEN BRINGS YOU A HIGH DEFINITION VIEW OF VITAL DRIVING INFORMATION SUCH AS SPEED, RPM AND FUEL. THIS IS INTERACTION IN HD.

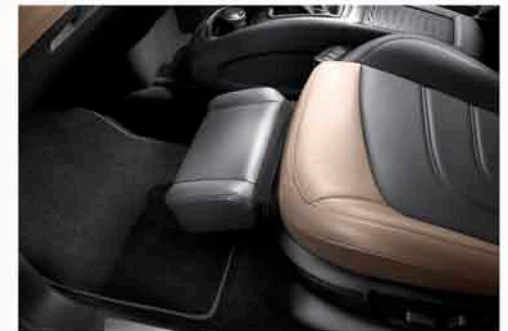

## > A SENSUAL JOURNEY

The sense of bright, spacious tactility is all encompassing inside the New Citroën C4 Picasso. The huge panoramic windscreen lets light flood in over an elegant two-tone dashboard: every control and detail is finely honed and trimmed. Now with even greater legroom, this is the perfect place to settle into the Relax Pack's exclusive massaging seats. This is a vehicle that believes versatile and luxurious belong together.



# MORE AND LESS. MORE COMPACT THAN BEFORE, THE NEW CITROËN C4 PICASSO PROVIDES EXTRA SPACE AND FLEXIBILITY EVERYWHERE. THERE ARE SO MANY PRACTICAL INNOVATIONS TO MAKE THE BUSIEST LIVES SEAMLESSLY RELAXED.

THE FIGURES SPEAK VOLUMES. BOOTSPACE HAS GONE UP 37 LITRES, EXPANDABLE FROM 537 TO 630 LITRES, THANKS TO AN INCREASE OF 6CM IN THE WHEELBASE. THE BOOTLID OPENS AND CLOSSES AUTOMATICALLY AND THE HEIGHT IS PROGRAMMABLE FOR CONFINED AREAS.



## › SMART SPACES

The centre console on 6-speed manual versions provides a large storage area with a roller blind: there's also twin cup holders and a mobile ashtray. On ETG6 versions, the whole console can also be removed completely to create easy access between the two front seats when needed.

As ever, back seat passengers are just as well looked after. There are generous pockets in the front seat backs, plus there's secure storage in the rear foot wells if you need to stow valuables discreetly.



## › NO-COMPROMISE ACCOMMODATION

The beautifully trimmed and sculpted back seats are designed to welcome three in proper comfort. Each seat slides backwards and forwards, and reclines independently as well as folding totally flat with one pull on the easily accessed release tab. A neat foldaway table is integrated into each of the front seats with a reading spot light, there's no second class when you travel in the New Citroën C4 Picasso.





› COMPLETE CONNECTIVITY

Citroën Multicity Connect brings you the effortless convenience of a 3G connected multimedia tablet and GPS system all in one. Seamlessly integrating the latest technologies, the system allows you to enjoy the benefits of your favourite apps whilst planning the best journeys – wherever you're heading. Specially developed by Citroën, it turns the 7" Touch Drive into a comprehensive media and control centre, with fingertip access to numerous services and features such as TripAdvisor, Wikipedia, traffic and weather news, your social media and email. It's a model of simplicity too: just plug in the USB Key and you're off. Intuitive, safe, smart and reliable, Citroën Multicity Connect makes the most of life on the move.



# MAKING THE SOPHISTICATED SIMPLE. THE NEW CITROËN C4 PICASSO USES INNOVATIVE TECHNOLOGY TO MAKE EVERY JOURNEY REFRESHINGLY SIMPLE, ENJOYABLE AND SAFE.

FROM STARTING UP TO AIR CONDITIONING, MUSIC TO COMMUNICATION AND PINPOINT NAVIGATION, EVERYTHING IS SMOOTHLY INTUITIVE, INTEGRATED AND CUTTING EDGE. YOU DON'T HAVE TO THINK ABOUT IT, JUST ENJOY THE PURE SIMPLICITY.

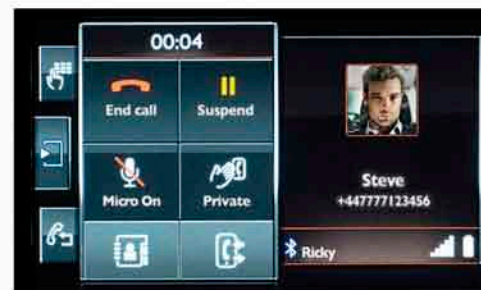



### > JUST JUMP IN

It starts the moment you walk towards the vehicle. There's no need to get your keys out, because the New Citroën C4 Picasso detects the electronic key fob as you approach. Simply touch the door handle to get in and touch the Start/Stop button to get going.

### > THE ART OF PARKING

The New Citroën C4 Picasso turns parking into an innovative art form. Park Assist is an active parking aid that first detects a suitable space then guides the vehicle in. All you need to do is select reverse, accelerate and brake. The whole manoeuvre is accompanied by a audible warning signal and pin sharp images sent from a reversing camera to the 12" panoramic screen.









# SAFETY: THE NEXT CHAPTER.

## THE NEW CITROËN C4 PICASSO TAKES SAFETY TECHNOLOGY TO THE NEXT LEVEL. IT REALLY KNOWS HOW TO LOOK AFTER YOU.

EVERY PIONEERING DEVELOPMENT IS DESIGNED TO GIVE YOU ALL THE CONTROL, PROTECTION AND INFORMATION YOU NEED TO STAY SAFER THAN EVER.

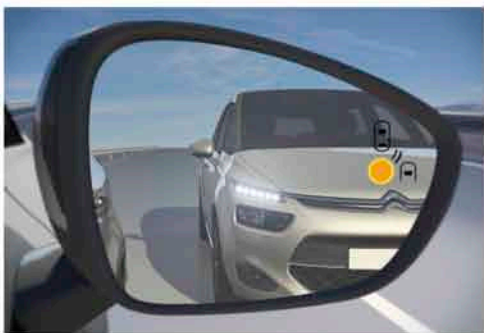

### > ALL SEEING

The New Citroën C4 Picasso has a blind spot monitor that detects vehicles up to three metres away. If someone has moved into that critical area where it's hard for you to see just using mirrors, a bright orange light illuminates in the wing mirror on the relevant side. Now you've got an extra pair of eyes looking out for you.



### > KEEP YOUR DISTANCE

Sophisticated active cruise control senses when the car in front slows down and automatically adjusts road speed accordingly. Now you can keep a safe constant distance in moving traffic without continually making changes. The system regulates acceleration and deceleration within a 15mph (20km/h) speed band.

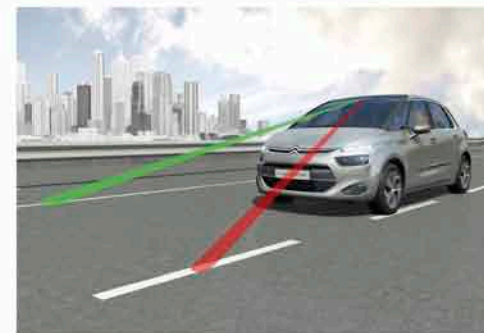

### > YOUR SAFETY CAMERA

A miniature camera mounted in the base of the rear view mirror automatically dips your headlights when it sees an oncoming vehicle, before reverting back to main beam. The camera system also senses when white lines are crossed accidentally and warns the driver with vibrations through the seat belt.

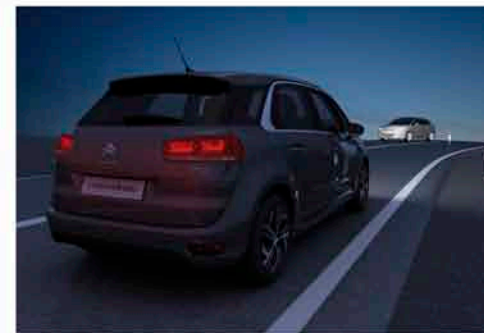



# ENVIRONMENTAL ENGINEERING.

WHEN CREATING THE NEW CITROËN C4 PICASSO, WE CONSIDERED EFFICIENCY AND ENVIRONMENTAL IMPACT AT EVERY STAGE AND IN EACH DETAIL.

IT STARTS AT THE VERY HEART OF THE MACHINE, WHERE YOU'LL FIND ENGINES WITH CLASS LEADING CO<sub>2</sub> EMISSIONS: THE e-HDi 90 AIRDREAM ETG6 PRODUCES JUST 98G/KM CO<sub>2</sub>.

## › TREAD SOFTLY, GO SMOOTHLY

The entire e-HDi engine range uses micro-hybrid technology to achieve amazing efficiency and economy. The latest seamlessly smooth Stop & Start system automatically shuts down when you stop and restarts as you release the brake pedal. Ideal for city driving, it helps to cut CO<sub>2</sub> and fuel consumption. All diesel models benefit from particulate filters that remove harmful particulate pollution from exhaust gases. Thanks to its brand new platform, the New Citroën C4 Picasso is 140kg lighter than before, boosting efficiency further!









**DIVERSITY IN DEPTH.** BY DEFINITION, THE NEW CITROËN C4 PICASSO IS WHATEVER YOU WANT IT TO BE. ULTRA-VERSATILE, STYLISH, DYNAMIC AND ADVANCED, IT ENCOMPASSES THE ESSENTIAL AND THE DESIRABLE IN ONE GREAT NEW SHAPE.

IT ALSO BRINGS YOU THE CHOICE OF FOUR EXCITING MODELS THAT EACH OFFER A UNIQUE BALANCE OF FEATURES, AESTHETICS AND FINE DETAIL. EVERY NEW CITROËN C4 PICASSO IS GENEROUSLY SPECIFIED. ONE WILL FIT YOUR LIFE BEAUTIFULLY.





# VTR

## NEW BENCHMARK

YOU ONLY HAVE TO GLANCE AT THE HUGE SPECIFICATION BELOW TO UNDERSTAND THE NATURE OF THIS RANGE. HERE'S A NEW STANDARD: THE NEW CITROËN C4 PICASSO VTR.

### > CITROËN C4 PICASSO VTR SPECIFICATION INCLUDES:

- ABS with Electronic Brakeforce Distribution (EBD) and Emergency Braking Assistance (EBA)
- Electronic Stability Control (ESC) with traction control
- Automatic electronic parking brake
- Driver's and front passenger's airbags with cut-off device
- Front lateral and curtain airbags (including row 2)
- Compressor with puncture repair kit
- High-frequency plip remote control central locking with deadlocks
- Automatic door and boot locking (when vehicle in motion and in case of accidental unlocking)
- Electronic child lock control and indicator
- Panoramic windscreen (with sliding interior sun blinds)
- Daytime-running LEDs
- Twin optic headlamps
- 16" 'Viper' alloy wheels (set of four)
- Two-tone soft touch upper dashboard and white back-lit dashboard illumination
- Front and rear electric windows with anti-pinch and one-touch operation
- Height and tilt-adjustable driver's seat
- 3 separate full size rear seats with adjustable recline angle
- Individual fold flat rear seats with retractable head restraints
- Illuminated glovebox and central storage compartment
- Cruise control with speed limiter
- Engine start button
- Gear Efficiency Indicator (GEI)
- 7" Touch Drive interface (used to control all vehicle functions)
  - 7" full colour touch screen
  - 6 speakers
  - FM radio
  - Aux-in jack, USB (in central storage cubby) and Bluetooth® with media streaming
  - Steering wheel controls
- Anti-theft immobiliser
- Variable assistance electric power steering
- Electronic fuel filler flap release
- 12 volt accessory power socket in central storage cubby and additional 12 volt sockets in row 2 and boot

# VTR+

## EVERYTHING PLUS

YOU CAN'T HAVE TOO MUCH INNOVATION. OR REFINEMENT. OR PRACTICALITY. VTR+ ADDS MORE ADVANCED TECHNOLOGY, MORE THOUGHTFUL TOUCHES AND MORE CLASSIC CITROËN INNOVATION.

### > CITROËN C4 PICASSO VTR+ SPECIFICATION IN ADDITION TO VTR INCLUDES:

- Automatic activation of lights and windscreen wipers
- Front fog lights
- Electrically heated and folding body colour door mirrors with LED indicators
- Automatic digital air conditioning with dual zone temperature setting
- Height and tilt adjustable, flat folding front passenger's seat
- Adjustable armrests for driver's and front passenger's seats
- Drawer under driver's and front passenger's seats
- Fold-down aircraft style tray tables (integrated in to back of front seats)
- Rear underfloor storage (row 2)
- Air vents for rear seat passengers
- DAB digital radio
- Rear parking sensors

	CO <sub>2</sub> EMISSIONS (G/KM)	
	VTR	VTR+
<b>PETROL ENGINE AVAILABILITY</b>		
VTi 120 manual	145	145
<b>DIESEL ENGINE AVAILABILITY</b>		
HDi 90 manual	109	109
e-HDi 90 Airdream ETG6		98
e-HDi 115 Airdream 6-speed manual		105
e-HDi 115 Airdream ETG6		104

**ABOVE AND BEYOND.** THE NEW CITROËN C4 PICASSO RANGE STARTS ON A HIGH AND RISES FROM THAT POINT. THE EXCLUSIVE MODELS INCLUDE EVERYTHING YOU COULD WISH FOR, FROM ENTERTAINMENT AND COMFORT, TO COMMUNICATION AND SAFETY.

IF YOU'D LIKE A VIVID DEMONSTRATION OF WHAT CITROËN MEANS BY CRÉATIVE TECHNOLOGIE, TAKE TIME TO EXPLORE...





# EXCLUSIVE

## AN EXPRESSION OF CLASS

FROM SATELLITE NAVIGATION AND REVERSING CAMERA ON THE HIGH DEFINITION PANORAMIC SCREEN, TO FOG LIGHTS THAT LOOK AROUND CORNERS AND KEYLESS ENTRY AND START, EXCLUSIVE MODELS PAMPER, PROTECT AND INSPIRE YOU.

› CITROËN C4 PICASSO **EXCLUSIVE** SPECIFICATION IN ADDITION TO VTR+ INCLUDES:

- LED front indicators
- Fog lights with cornering function
- Kerb lighting (puddle lights in door mirrors)
- Chrome side signature
- 'Exclusive' external badging
- 17" 'Anaconda' alloy wheels (set of four)
- Aluminium dashboard trim and air vent surrounds
- Stitched high-quality leather steering wheel with satin chrome inserts and 4 control zones
- **Kids Pack** – Integrated retractable rear side window sun blinds and rear seat conversation mirror
- Keyless entry and start
- 12" panoramic HD display
- Reversing camera (displayed on upper 12" HD screen)
- Satellite navigation with additional USB socket
- Perimetric and volumetric anti-theft alarm
- Removable and rechargeable boot light/torch

# EXCLUSIVE+

## THE ULTIMATE EXPRESSION

CAST YOUR EYES OVER THE FULL SPECIFICATION BELOW AND IMAGINE YOUR JOURNEYS WITH THESE ELEMENTS AT YOUR FINGERTIPS. WE'RE PROUD OF THE NEW CITROËN C4 PICASSO EXCLUSIVE+, THE ULTIMATE EXPRESSION OF CLASS.

› CITROËN C4 PICASSO **EXCLUSIVE+** SPECIFICATION IN ADDITION TO EXCLUSIVE INCLUDES:

- Active radar guided cruise control with collision alert
- Active seatbelt safety system
- Blind spot monitoring system
- Panoramic sunroof (with dark tinted glass and electric sliding blind)
- LED 3D effect rear lights
- Body colour, electrically heated, folding reverse-dipped door mirrors with LED indicators
- Aluminium front and rear sill scuff protectors
- 18" 'Python' alloy wheels (set of four) (Excludes e-HDi 115 versions)
- Dark tinted windows
- Automatic dimming electrochrome interior rear view mirror
- Fan speed adjustment for rear seat passenger air vents
- Integrated dashboard scented air freshener
- Reading spot light for rear aircraft style tray tables
- Driver's seat: electric massage function with adjustable lumbar support
- Front passenger's seat with massage function and electric footrest
- Extra support head rests
- Luxury velour carpet mats
- Slate grey half leather with black 'Ondulice' cloth interior trim
- Front parking sensors
- Park Assist
- Motorised rear tailgate (with programmable opening height memory)
- Fold out flat load cover panel

	CO <sub>2</sub> EMISSIONS (G/KM)	
	EXCLUSIVE	EXCLUSIVE+
<b>PETROL ENGINE AVAILABILITY</b>		
THP 155 manual 6-speed	139	142
<b>DIESEL ENGINE AVAILABILITY</b>		
e-HDi 115 Airdream 6-speed manual	105	105
e-HDi 115 Airdream ETG6	105	105
BlueHDi 150 6-speed manual	110	113

# FINE-TUNED FREEDOM. OPTIONS ON THE NEW CITROËN C4 PICASSO TAKE YOU FURTHER BY PROVIDING SOMETHING PRECIOUS: FREEDOM OF CHOICE. WE'VE CREATED A SERIES OF OPTION PACKS TO MAKE CHOOSING EASIER.

## > VTR+ STYLE PACK

The unique design flourishes start at street level with 17" 'Anaconda' alloy wheels when you select the VTR+ Style Pack. There is also a brilliant panoramic sunroof with dark tinted glass and electric sliding blind.

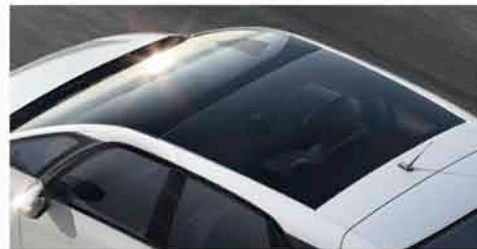

## > VTR+ CONVENIENCE PACK

Advanced technology and intelligent functions make up the Convenience Pack. There's satellite navigation displayed on the 7" Touch Drive with additional USB socket, keyless entry and start, a rear seat conversation mirror and retractable rear side window sun blinds.



## > EXCLUSIVE STYLE PACK

Step up to the Exclusive Style Pack to enjoy the stunning LED 3D effect rear lights, dark tinted windows and that beautifully designed panoramic sunroof with dark tinted glass and electric sliding blind.



## > EXCLUSIVE CONVENIENCE PACK

Here is a pack that's bursting with innovations and features to make your journeys easy and safe. There's a motorised rear tailgate, front parking sensors, Park Assist and the blind spot monitoring system with LED indicators in each door mirror. You also benefit from radar-guided cruise control, a Lane Departure Warning System, auto-dimming electrochromic rear view mirror, auto-dipping headlights and an active seatbelt safety system.

OPTION SUMMARY	VTR	VTR+	EXCLUSIVE	EXCLUSIVE+
Space saver steel spare wheel (with jack and toolkit)	○	○	○	○
Slate Grey half leather with black 'Ondulice' cloth			○ <sup>1</sup>	●
Champagne half leather with black 'Ondulice' cloth				○ <sup>2</sup>
Champagne/black full 'Nappa' leather				○
<b>Citroën Multicity Connect</b> – 3G and GPS enabled App hub	○	○	○	○
Satellite navigation and additional USB socket		○	●	●
Xenon headlights			○	○
Motorised rear tailgate			○	●
Panoramic roof with dark tinted glass and electric sliding blind		○	○	●
3D effect rear lights			○ <sup>3</sup>	● <sup>3</sup>
Keyless entry and start		○	●	●
Park Assist and Blind Spot Monitoring system			○	●
Park Assist Pack 360°				○
<b>Kids Pack</b> – Rear seat conversation mirror, integrated rear side window sun blinds		○	●	●
<b>Drive Assist Pack</b> – Active cruise control, active seatbelt safety system, electrochromic auto-dimming rear view mirror, Lane Departure Warning System, intelligent headlights			○	
<b>Serenity Pack</b> – Lane Departure Warning System, intelligent headlights				○
<b>VTR+ Style Pack</b> – 17" 'Anaconda' alloy wheels (set of four), panoramic sunroof with dark tinted glass and electric sliding blind		○		● <sup>4</sup>
<b>VTR+ Convenience Pack</b> – Satellite navigation, keyless entry and start, rear seat conversation mirror, integrated retractable rear side window sun blinds		○	●	●
<b>Exclusive Style Pack</b> – Panoramic sunroof with dark tinted glass and electric sliding blind, LED 3D effect rear lights, dark tinted rear windows			○	●
<b>Exclusive Style Pack Plus</b> – 18" 'Python' alloy wheels, panoramic sunroof with dark tinted glass and electric sliding blind, LED 3D effect rear lights, dark tinted windows			○ <sup>5</sup>	● <sup>5</sup>
<b>Exclusive Convenience Pack</b> – Motorised rear tailgate, front parking sensors, Park Assist, blind spot monitoring system, active radar-guided cruise control, Lane Departure Warning System, auto-dimming electrochromic rear view mirror, intelligent beam headlights, active seatbelt safety system			○	

- Standard equipment
- Optional factory fitted equipment

- 1 Includes RELAX function seats.
- 2 Includes electric adjustment function, front heated seats and velour carpet mats.

- 3 Includes dark tinted rear windows.
- 4 Available on e-HDi 115 versions only.
- 5 Applies to THP 155 version only.



# CLEAR YOUR MIND. IT'S TIME TO CHOOSE A BODY COLOUR TO COMPLEMENT THE UPHOLSTERY AND ALLOYS TO BRING YOUR NEW CITROËN C4 PICASSO TO LIFE. IT'S AN ENJOYABLE DILEMMA...

## BODY COLOURS



Polar White



Onyx Black



Aluminium (M)

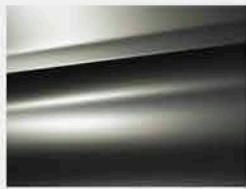

Shark Grey (M)



Teles Blue (M)



Kyanos Blue (M)



Ruby Red (M)

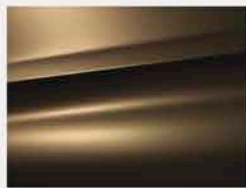

Hickory Brown (M)

## TRIMS



Standard on VTR



Standard on VTR+



Standard on Exclusive



Slate Grey/black  
'Milazzo' cloth



Slate Grey/black  
'Ondulice' cloth



Slate Grey gloss/black  
'Ondulice' cloth

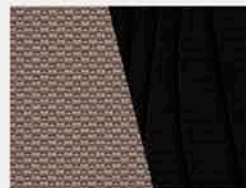

Standard on Exclusive



Standard on Exclusive+

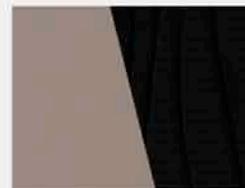

Optional on Exclusive+



Champagne gloss/black  
'Ondulice' cloth

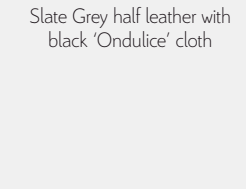

Slate Grey half leather with  
black 'Ondulice' cloth

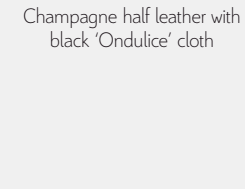

Champagne half leather with  
black 'Ondulice' cloth

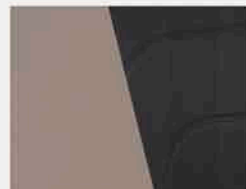

Optional on Exclusive+

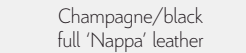

Champagne/black  
full 'Nappa' leather

(M) Metallic

- Standard equipment
- Optional factory fitted equipment

- 1 Standard on e-HDi 115 versions only.
- 2 Applies to THP 155 versions only.

16" 'VIPER' ALLOY WHEELS Set of four Tyres: 205/60 R16			
VTR	VTR+	EXCLUSIVE	EXCLUSIVE+
●	●		

17" 'ANACONDA' ALLOY WHEELS Set of four Tyres: 205/55 R17			
VTR	VTR+	EXCLUSIVE	EXCLUSIVE+
	○	●	●



18" 'PYTHON' ALLOY WHEELS Set of four Tyres: 225/45 R18			
VTR	VTR+	EXCLUSIVE	EXCLUSIVE+
		○	●



# EQUIPMENT SPECIFICATION

	VTR	VTR+	EXCLUSIVE	EXCLUSIVE+
<b>SAFETY &amp; SECURITY</b>				
ABS with Electronic Brakeforce Distribution (EBD) and Emergency Braking Assistance (EBA)	●	●	●	●
Electronic Stability Control (ESC) with traction control	●	●	●	●
Automatic electronic parking brake and Hill Start Assist function	●	●	●	●
Automatic activation of hazard warning lights (in case of rapid deceleration or impact)	●	●	●	●
Driver's and front passenger's airbags with cut-off device	●	●	●	●
Front lateral and curtain airbags (including row 2)	●	●	●	●
Front inertia reel seat belts with pre-tensioners and force-limiters	●	●	●	●
Outer rear seats with inertia reel seat belts with force-limiters	●	●	●	●
Centre rear seat with inertia reel seat belt housed in roof lining	●	●	●	●
Warning system for all 'unfastened' seat belts	●	●	●	●
Rear seat ISOFIX child seat anchorage points with top tether on all 3 rear seats	●	●	●	●
Programmable cruise control with speed limiter	●	●	●	●
Cruise control with active radar guided cruise control and collision alert			○	●
Active seatbelt safety system			○	●
Blind spot monitoring system with LED indicator in door mirrors			○	●
High frequency multi-function plip remote control central locking with deadlocks	●	●	●	●
Selective unlocking (driver's door only on first press of plip)	●	●	●	●
Automatic door and boot locking (when vehicle in motion and unlocking in case of impact)	●	●	●	●
Anti-theft immobiliser	●	●	●	●
Perimetric and volumetric anti-theft alarm			●	●
Electronic child lock control and indicator	●	●	●	●
Mono-tone horn	●	●		
Two-tone horn			●	●
<b>COMFORT &amp; CONVENIENCE</b>				
Variable assistance electric power steering	●	●	●	●
Stitched leather height and reach adjustable steering wheel with satin chrome inserts and 2 control zones	●	●		
Stitched high-quality leather steering wheel with satin chrome inserts and 4 control zones			●	●
Sliding driver's and passenger's sun blinds with sunvisors and courtesy mirrors	●	●	●	●
Front and rear electric windows with anti-pinch and one-touch operation	●	●	●	●
Air conditioning with dual zone temperature setting	●			
Automatic air conditioning with dual zone temperature setting		●	●	●
Air vents for rear seat passengers		●	●	●
Fan speed adjustment for rear seat passenger air vents			●	●
Integrated dashboard scented air freshener			●	●
Rear parking sensors		●	●	●
Front parking sensors and Park Assist			○	●
Reversing camera (displayed on upper 12" HD screen)			●	●
Electronic fuel filler flap release	●	●	●	●
Motorised rear tailgate (with programmable opening height memory)			○	●
Engine start button	●	●	●	●
Keyless entry and start		○	●	●
Total closure mode (closes all windows when 'lock' button is held down)	●	●	●	●
'Find my car' feature (illumination of interior lights and flashing of hazard warning lights)	●	●	●	●
Integrated fold-down aircraft style tray tables in back of front seats		●	●	●
Reading spot light for rear aircraft style tray tables			●	●
Integrated retractable rear side window sun blinds		○	●	●
12 volt accessory power socket in central storage cubby with additional 12 volt sockets in row 2 and boot	●	●	●	●
Front and rear luxury velour carpet mats			●	●

● Standard equipment

○ Optional factory fitted equipment

<sup>1</sup> Standard on e-HDi 115 Airdream versions only.

<sup>2</sup> Applies to THP 155 versions only.

<sup>3</sup> Standard on VTi 120 manual, HDi 90 manual and e-HDi 115 manual 6-speed versions.

<sup>4</sup> Standard on THP 155 and e-HDi 115 manual 6-speed versions.

<sup>5</sup> Standard on e-HDi 90 and e-HDi 115 versions.

<sup>6</sup> Standard on e-HDi 115 ETG6 version only.

<sup>7</sup> Available as part of the Kids Pack option.

<sup>8</sup> Available as part of Satellite Navigation option.

	VTR	VTR+	EXCLUSIVE	EXCLUSIVE+
<b>STYLING</b>				
<b>EXTERIOR</b>				
Body colour painted bumpers	●	●	●	●
Black door handles	●			
Body colour painted door handles		●	●	
Black door handles with chrome trim				●
Standard tinted rear window	●	●	●	
Dark tinted rear window and glass side windows			○	●
Light smoked glass side windows	●			
Light smoked acoustic glass side windows		●		
Chrome side signature			●	●
Body colour door mirrors with LED indicators	●			
Body colour electrically heated and folding door mirrors with LED indicators		●	●	
Body colour electrically heated and folding reverse-dipping door mirrors with LED indicators				●
'Exclusive' external badging			●	●
16" 'Viper' alloy wheels (set of four)	●	●		
17" 'Anaconda' alloy wheels (set of four)			●	● <sup>1</sup>
18" 'Python' alloy wheels (set of four)			○ <sup>2</sup>	● <sup>2</sup>
<b>INTERIOR</b>				
Two-tone soft touch upper dashboard	●	●	●	●
Black dashboard trim and air vent surrounds	●	●		
Aluminium dashboard trim and air vent surrounds			●	●
White back-lit dashboard illumination	●	●	●	●
Aluminium gear surround	●	● <sup>3</sup>	● <sup>4</sup>	●
Gear selector stalk mounted on steering column and black gear selector paddles		● <sup>5</sup>	● <sup>6</sup>	
Aluminium front and rear sill scuff protectors				●
Boot sill scuff protector	●	●	●	●
<b>LIGHTING &amp; VISIBILITY</b>				
Panoramic windscreen with sliding interior sun blinds	●	●	●	●
Panoramic sunroof with dark tinted glass and electric sliding blind		○	○	●
Halogen headlamps	●	●	●	●
Automatic activation of lights and windscreen wipers		●	●	●
Daytime-running LEDs	●	●	●	●
LED front indicators			●	●
Front fog lights		●	●	●
Front fog lights with cornering function			●	●
LED 3D effect rear lights			○	●
'Guide-me-home' headlamp function	●	●	●	●
Kerb lighting (puddle lights in door mirrors)			●	●
Blown bulb detection			●	●
Flat tyre indicator	●	●	●	●
Auto dimming electrochromic interior rear view mirror			○	●
Front concealed courtesy mirrors	●	●	●	●
Rear seat conversation mirror		○	●	●
Front and rear courtesy reading lights	●	●	●	●
Boot light	●	●		
Removable and rechargeable boot light/torch			●	●
Interior mood lighting			●	●



	VTR	VTR+	EXCLUSIVE	EXCLUSIVE+
<b>DRIVER INFORMATION</b>				
7" Touch Drive interface (used to control all vehicle functions)	•	•	•	•
LCD central display	•	•	•	•
12" Panoramic HD, full colour central display with 3 selectable themes	•	•	•	•
'Black Panel' night-time mode	•	•	•	•
Gear Efficiency Indicator (GEI)	•	•	•	•
Service, digital oil level and pressure status indicators	•	•	•	•
Audible warnings	•	•	•	•
Compressor with puncture repair kit	•	•	•	•
<b>SEATING</b>				
Height and tilt-adjustable driver's seat	•	•	•	•
Driver's seat with electric massage function, adjustable lumbar support with extra support head rest				•
Flat folding, height and tilt adjustable front passenger's seat (enables loading up to 2.5m)		•	•	•
Front passenger's seat with RELAX function (electric footrest, massage plus extra-support head rest)				•
Adjustable armrests for driver's and front passenger's seats		•	•	•
3 separate full size rear seats with adjustable recline angle	•	•	•	•
Rear seats with individual sliding fore/aft adjustment		o <sup>7</sup>	•	•
Individual fold flat rear seats with retractable rear head restraints	•	•	•	•
Fold out flat load cover panel (bridges gap between folded seat and boot floor)				•
Rear seats with extra support head rests				•
<b>STORAGE</b>				
Illuminated switchable central storage cubby (housing aux-in, USB and 12 volt connections)	•	•	•	•
Ventilated and illuminated glovebox	•	•	•	•
Cup holders	•	•	•	•
Fixed centre storage box with sliding lid (between front seats)	•	o <sup>3</sup>	• <sup>4</sup>	•
Removable centre storage box with sliding lid (between front seats)		• <sup>5</sup>	• <sup>6</sup>	•
Front door pockets and front seat back pockets	•	•	•	•
Drawer under driver's seat		•	•	•
Drawer under front passenger's seat		•	•	•
Rear underfloor storage (row 2)		•	•	•
Hanging hooks in rear (on B pillar)	•	•	•	•
Rigid load cover (parcel shelf) and 4 lashing eyes in boot floor	•	•	•	•
<b>IN-CAR ENTERTAINMENT</b>				
7" Touch Drive interface – 7" full colour touch screen, 6 speakers, FM radio, 12 volt socket, aux-in jack, USB, Bluetooth® with media streaming and 2 or 4 zone steering wheel controls	•	•	•	•
Additional USB socket		o <sup>8</sup>	•	•
DAB digital radio		•	•	•
Jukebox (built-in 8GB hard drive for storing music)				•
Satellite navigation (displayed on 7" Touch Drive and also 12" HD display where present)		o	•	•



# TECHNICAL SPECIFICATION



74.3mpg  
on e-HDi 90 Airdream  
ETG6 version



98g/km CO<sub>2</sub>  
on e-HDi 90 Airdream  
ETG6 version

	PETROL MODELS			DIESEL MODELS		
	VTi 120 manual	THP 155 6-speed manual	HDi 90 manual	e-HDi 90 Airdream ETG6	e-HDi 115 Airdream 6-speed manual	
<b>ENGINE</b>						
Capacity (cc)	1598	1598	1560	1560	1560	
Cylinders	4	4	4	4	4	
Max power CEE kW/rpm (PS)	88/6000 (120)	115/6000 (156)	68/4000 (92)	68/4000 (92)	84/3600 (114)	
Max torque CEE (Nm/rpm)	160/4250	240/1400	230/1750	230/1750	270/1750	
Fuel system	Multi-point electronic fuel injection	Turbo charged, multi-point electronic fuel injection	Turbo charged, multi-point electronic fuel injection	Turbo charged, multi-point electronic fuel injection	Turbo charged, multi-point electronic fuel injection	
Euro status	Euro 5	Euro 5	Euro 5	Euro 5	Euro 5	
<b>TRANSMISSION</b>						
Transmission type	Five speed manual	Six speed manual	Five speed manual	Six speed ETG6	Six speed manual	
Clutch type	Dry single plate	Dry single plate	Dry single plate	Dry single plate	Dry single plate	
<b>PERFORMANCE</b> <small>(All figures driver alone)</small>						
Max speed (mph)	116	130	108	109	117	
0-62mph (secs)	12.3	9.0	12.9	13.7	11.8	
Standing 1000m (secs)	33.4	29.9	34.5	34.9	33.4	
<b>ECONOMY Litres/100km (mpg)</b> <small>(Official Government test fuel consumption figures)</small>						
		Exclusive	Exclusive+			
Urban cycle	8.5 (33.2)	8.2 (34.4)	8.3 (34.0)	4.8 (58.9)	4.5 (62.8)	
Extra urban	4.9 (57.6)	4.8 (58.9)	4.9 (57.6)	3.8 (74.3)	3.8 (74.3)	
Combined	6.3 (44.8)	6.0 (47.1)	6.1 (46.3)	4.2 (67.3)	4.0 (70.6)	
<b>CO<sub>2</sub> EMISSIONS (g/km)</b>						
	145	139	142	109	105	
<b>WEIGHTS (kg)</b> <small>Please note: the maximum plated weights must not be exceeded</small>						
Kerb Weight	1252	1296		1279	1298	
Mass in service	1327	1371		1354	1373	
Max laden weight	1900	1940		1920	1940	
Max towing weight braked/unbraked	1200/660	1620/685		1450/675	1600/685	
Max roof rack load				80		
<b>BRAKES</b>						
	Front and rear discs					
<b>STEERING</b>						
Turning circle between kerbs (m)	10.8					
<b>FUEL TANK CAPACITY Litres (gallons)</b>						
	57	57	55	55	55	
<b>EXTERIOR DIMENSIONS (mm)</b>						
Length/width (including mirrors)/height/wheelbase	4428 / 1826 (1971/2117) / 1610 / 2785					
<b>BOOT VOLUMES &amp; DIMENSIONS</b>						
Seats up – below parcel shelf min/max (litres)	537					
Rear seats down – up to roof min/max (litres)	1851					

All diesel engines are fitted with Diesel Particulate Filter System.

MPG figures are achieved under official EU test conditions, intended as a guide for comparative purposes only, and may not reflect actual on-the-road driving conditions.



### DIESEL MODELS

e-HDi 115 Airdream ETG6		BlueHDi 150 6-speed manual	
1560		1997	
4		4	
84/3600 (114) 270/1750		110/4000 (150) 370/2000	
Turbo charged, multi-point electronic fuel injection		Turbo charged, multi-point electronic fuel injection	
Euro 5		Euro 6	
Six speed ETG6 Dry single plate		Six speed manual Dry single plate	
117		130	
12.3		9.7	
34.0		30.9	
VTR+	Exclusive & Exclusive+	Exclusive	Exclusive+
4.4 (64.2)	4.5 (62.8)	4.9 (57.6)	5.2 (54.3)
3.7 (76.3)	3.8 (74.3)	3.8 (74.3)	3.8 (74.3)
4.0 (70.6)	4.0 (70.6)	4.2 (67.3)	4.3 (65.7)
104	105	110	113
1295		1415	
1370		1490	
1940		2030	
1600/685		1600/745	
80			
Front and rear discs			
10.8			
55		55	
4428 / 1826 (2117) / 1611 / 2785			
537			
1851			



**FEEL GOOD. FEEL UNIQUE.** ACCESSORIES NEED TO INTEGRATE PERFECTLY WITH THE QUALITY AND STYLE OF YOUR CITROËN. THEY NEED TO BOOST COMMUNICATIONS, INCREASE PRACTICALITY OR SIMPLY LOOK BRILLIANT. WE MAKE CERTAIN THAT THEY DO.

FIND YOUR ULTIMATE ACCESSORIES AT [WWW.ACCESSORIES.CITROEN.CO.UK](http://WWW.ACCESSORIES.CITROEN.CO.UK) - HERE IS EVERYTHING YOU NEED, MADE WITH THE SAME CREATIVITY AND CARE AS YOUR VEHICLE.



> **TOMTOM CHOICE**

Choose from two TomTom Start 20 models. Both Start 20 UK & ROI and Start 20 Europe include plenty of great features such as 4.3" high quality touch screen, IQ routes and advanced lane guidance.



> **DIGITAL RADIO**

The New Citroën Ezi-DAB has been designed to upgrade your existing car stereo to receive outstanding digital reception. Enjoy many extra digital radio channels and be ready for the digital switch over.



> **1 ROOF BARS**

Citroën traversing roofbars are designed to match the contours of your New Citroën C4 Picasso and can be used with Citroën bicycle carriers, ski/snowboard carriers and roof boxes for quick and easy transport and storage solutions.

> **2 ROOF BOXES**

Citroën roof boxes are available in 280, 340, 370 or 430 litre capacities and enable you and your family to have a more relaxing journey with increased comfort on day trips and holidays with all your clutter hidden away on the roof.

> **3 ISOTHERM MODULE**

Keep your food and drink either warm or cold on the move in your New C4 Picasso.

> **4 CARPET MAT SET**

With a made-to-measure design that makes them easy to fit and maintain, Citroën mats work in harmony with the interior lines of your New C4 Picasso.

> **5 TOWBARS**

Citroën towbars have been developed to ensure the highest standards of safety and strength. Fixed swan neck towbars are available along with demountable towballs.

> **6 BOOT MATS**

Designed for ease of use and to perfectly fit your New Citroën C4 Picasso, Citroën boot mats will provide you with protection against dirt and stains.



# EFFICIENCY MINUS COMPROMISE. CITROËN HAS CREATED FUELEFFICIENT VEHICLES WITHOUT SACRIFICING DRIVER ENJOYMENT FOR SOME TIME. THE LATEST ADVANCES TAKE THIS FINE BALANCE FURTHER STILL...

WITH THE PROVEN CREDENTIALS AND ENVIRONMENTAL PERFORMANCE OF CITROËN HDi DIRECT INJECTION ENGINES AS INSPIRATION, e-HDi ADDS NEW TECHNOLOGY, SUCH AS A SMOOTH, SIMPLE STOP & START SYSTEM AND ETG6 GEARBOX. STOP & START PUTS THE ENGINE INTO IDLE MODE AS YOU DECELERATE AND STOPS ALTOGETHER AS YOU COME TO A HALT. THE MOMENT YOU TAKE YOUR FOOT OFF THE BRAKE, IT RESTARTS SILENTLY AND WITHOUT VIBRATION. THE RESULTS ARE A DRAMATIC REDUCTION IN BOTH FUEL CONSUMPTION AND CO<sub>2</sub> EMISSIONS, COMBINED WITH RESPONSIVE PERFORMANCE WHEREVER YOU GO.

We've also been equipping more of our vehicles with more environmentally friendly breakthroughs, such as our Efficient Tronic Gearbox (ETG6), which boasts impressively greener credentials, with less pollution and up to 5% more economy than a conventional manual gearbox system. In addition, Citroën has expanded the use of the exceptionally efficient, self-regenerating Diesel Particulate Filter System in our models. Cleaner, greener driving without taking away from the drive – that's what you can continue to expect from Citroën.



## › PURE TECHNOLOGY

Demonstrating Citroën's commitment to Créative Technologie, PureTech engines provide increased power with lower fuel consumption and emissions by adopting a smaller and lighter three cylinder configuration constructed of pressure-cast aluminium. In conjunction with low friction component coatings, improved air and fuel flow and optimised combustion, this allows engines to offer more power, better fuel economy and significantly lower CO<sub>2</sub> emissions.

## › AIRDREAM – A BENCHMARK

Citroën's environmental commitment and advanced efficiency are perfectly illustrated by Airdream. It's a benchmarking scheme that has three demanding criteria which a vehicle must achieve before it can wear the name. Firstly it must emit no more than 140g/km CO<sub>2</sub>. Secondly it must be produced at a plant that meets the rigorous ISO 14001 certification and also it must be 95% recoverable. Only e-HDi, electric or Hybrid4 engined Citroëns currently qualify. It's no surprise that Citroën is one of the leaders in Europe for low CO<sub>2</sub> emissions.

## › ELECTRIFYING. HOWEVER YOU LOOK AT IT

Forget what you know about electric cars. Citroën Survolt concept combines undiluted glamour with advanced sporting dynamics, then adds a 100% electric drivetrain. Outside, LED lights, voluptuous curves, two-tone charcoal and fuchsia paintwork, and a race-inspired rear spoiler meet your gaze. Inside, a stunning blend of curved chrome, swooping glass, high technology and organic forms welcomes you to an entirely new place. But this is no simple styling exercise. At heart, Survolt is even more radical, because although it is designed to thrill, it is powered purely by silent, efficient, clean electricity.



# DRIVE YOUR WAY. GET BEHIND THE WHEEL OF YOUR NEW CITROËN C4 PICASSO, WITH CITROËN'S RANGE OF FINANCE AND INSURANCE PRODUCTS.

## CITROËN FINANCIAL SERVICES

**PURCHASE PLAN**  
Own your vehicle with this flexible package designed to fit your budget.

**ELECT 3**  
A new Citroën car every two or three years with monthly payments structured to suit your budget.

**ELECT 4**  
Enjoy the convenience of a new car without the stress and hassle of ownership.

TO FIND OUT MORE ABOUT CITROËN PRODUCTS AND SERVICES, GO TO [WWW.CITROEN.CO.UK](http://WWW.CITROEN.CO.UK) OR CONTACT YOUR CITROËN DEALER.

FOR BUSINESS USERS

## CITROËN CONTRACT MOTORING

**HIRE PURCHASE**  
A tried and tested finance package that allows you to own your vehicle.

**BUSINESS LEASE**  
An alternative to vehicle ownership that allows you to control your business cash flow and gain tax efficiencies.

**LEASE PURCHASE**  
Own a vehicle with a finance solution that offers ultimate flexibility to complement your business cash flow.

**CONTRACT HIRE**  
A non-ownership finance solution that keeps costs fixed and risks low.

FOR MORE INFORMATION ON CITROËN FLEET AND BUSINESS SALES, PLEASE CALL CITROËN FLEET CONNECT ON 08457 940 940 OR LOOK US UP AT [WWW.CITROEN.CO.UK/FLEET](http://WWW.CITROEN.CO.UK/FLEET)

## CITROËN INSURANCE

**INSTANT COVER**  
To help you drive away your new car without delay, we offer Instant Cover insurance, providing you with 7 days comprehensive car insurance, for free!

**MOTOR INSURANCE**  
Citroën Insurance has been designed specifically for our vehicles. You don't just get repairs you get Citroën expertise, service, quality and parts. So, when the time comes to renew your insurance cover, call Citroën Insurance on 0870 024 2725.

Lines open 8am - 8pm weekdays, 9am - 5pm Saturdays. Max call charge from a BT landline is 8p per minute. Calls from other networks may vary. Alternatively, visit [www.citroen.co.uk](http://www.citroen.co.uk) for more information or to apply online.

Citroën Insurance is underwritten by UK Insurance Ltd which is authorised and regulated by the Financial Conduct Authority. Citroën Insurance is a trading style of Banque PSA Finance UK of Quadrant House, Princess Way, Redhill, Surrey, RH1 1QA.

# ESSENTIAL CARE. CITROËNS ARE RENOWNED FOR THEIR RELIABILITY – AND THE NEW CITROËN C4 PICASSO IS NO EXCEPTION.

WITH THE ADDED REASSURANCE OF A WARRANTY, ROUTINE SERVICING AND MAINTENANCE, AS WELL AS 24-HOUR ROADSIDE ASSISTANCE, YOU ARE PROTECTED.

## CITROËN WARRANTY

Every new Citroën car has the benefit of a 3 year\* warranty package, plus a 12 year anti-perforation\*\* warranty and a 3 year paint warranty.

\* 2 years' unlimited warranty. No-fee customer option of 1 year's Dealer provided warranty, only on cars sourced from Citroën UK Limited. Note: Dealer provided warranty is limited to 60,000 miles for cars.

\*\* Against all internal to external perforation to bodywork or underbody.

## CITROËN ASSISTANCE

In response to a free telephone call in the UK, Citroën Assistance brings rapid expert roadside assistance to you in an emergency. It comes free of charge for a full year and operates 24 hours a day in all parts of the UK and Europe. Services include nationwide recovery for both car and passengers, a home call service, replacement vehicle, hotel accommodation and vehicle storage if required. Please note, Citroën Assistance only applies to incidents covered by the new vehicle warranty, and excludes non-vehicle faults, such as running out of fuel, mis-fuelling, loss of keys, lock-ins, road traffic accidents and punctures/wheel changes.

Full details are available on request from Citroën UK via [cuk\\_contactcentre@citroen.com](mailto:cuk_contactcentre@citroen.com)

## CITROËN MAINTENANCE

From roadside assistance to replacing wear and tear parts or regular servicing, with Citroën Maintenance you have total peace of mind. For a one-off fee or low monthly payment, our experienced engineers will take care of your Citroën, whatever happens. To find out more, contact your Citroën Dealer or Citroën Authorised Repairer.

## CITROËN SERVICING

Available up to 1 year from your vehicle's registration date, but before its first chargeable service, a Citroën Servicing Package enables you to pay in advance for your vehicle's servicing needs for 3 years/35,000 miles.

For further information, please contact your Citroën Dealer.



# GLOSSARY

## › e-HDi ENGINES

The e-HDi 90 Airdream ETG6 engine is capable of 74.3mpg and CO<sub>2</sub> emissions of just 98g/km combined with the ETG6 gearbox. It has a reversible starter-alternator that works in tandem with an e-booster to provide a seamless Stop & Start function. Going further than other similar systems, the e-HDi's Stop & Start puts the engine into idle mode while decelerating before coming to a complete standstill. This reduces consumption by 15% in urban driving.

## › PETROL ENGINES

Part of Citroën's range of state-of-the-art engines, THP petrol powertrains are friction optimised and benefit from an inlet camshaft variable valve timing system that constantly measures the pressure on the accelerator and precisely regulates the quantity of air entering the cylinders. VTi engines boast advanced variable inlet valve lift and exhaust camshaft variable valve timing systems whilst THP engines are turbocharged. This guarantees outstanding efficiency and allows for immediate response with plenty of low range torque available.

## › PARK ASSIST

An advanced active parking aid, Park Assist finds a suitable space then smoothly guides Citroën C4 Picasso into it. All you have to do is engage reverse, accelerate and brake. Audible signals and a clear picture on the 12" panoramic screen let you know what's happening every inch of the way.

## › LANE DEPARTURE WARNING SYSTEM (LDWS)

The Lane Departure Warning System keeps you on course. It uses a miniature camera integrated into the base of the rear view mirror to monitor when white lines on the road have been crossed and sends vibrations through the driver's seatbelt. It's like an extra pair of eyes, looking out for you on every journey.

## › PARK ASSIST 360

Park Assist 360 provides all-round vision from four cameras. It's perfect for hassle-free parking manoeuvres in the tightest spots and further enhances the automated Park Assist system.

## › ELECTRONIC STABILITY CONTROL (ESC)

This is computer-controlled traction assistance and is provided primarily through the braking systems. The ESC's control unit constantly compares where the driver intends going (through the position of the steering wheel) with where the vehicle is actually going and, if necessary, makes speed corrections to each wheel individually through braking or engine torque to keep the vehicle 'in line'.

## › BLIND SPOT MONITORING SYSTEM

This sophisticated safety system detects vehicles approaching from behind up to three metres away. When they are in a place where you cannot easily see, Blind Spot Monitor triggers an orange light that illuminates in the wing mirror on the relevant side.

## › INTELLIGENT BEAM HEADLIGHTS

A miniature camera mounted in the base of the rear view mirror dips your headlights when it senses an oncoming vehicle. As soon as the vehicle has safely passed, it switches straight back to main beam.

## › ACTIVE SEATBELTS

Active seatbelts vibrate when the vehicle senses that you've accidentally crossed the white lines and for ESC and cruise control alerts. They also pre-tension if a collision is anticipated.

# DIMENSIONS

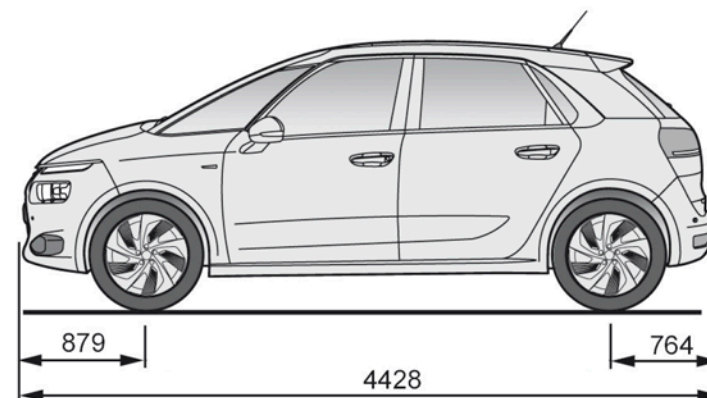
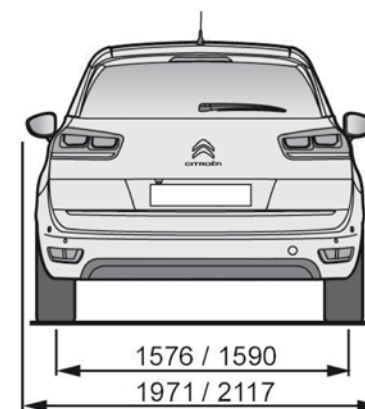
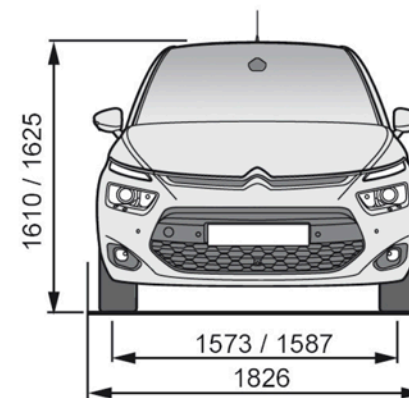

All measurements are in millimetres.



This brochure is made from paper from a well-managed forest. Citroën support responsible use of forest resources.

Please don't throw me away, give me to a friend or recycle me.

NOTE: Every endeavour has been made to ensure that the information and details contained in this brochure were accurate at the time of going to press July 2013. However the company reserves the right, whilst preserving the essential characteristics of the models described, to introduce at any time modifications, changes of details, equipment or accessories. Every effort will be made to bring this brochure up to date, but in order to avoid any misunderstandings please consult your Dealer. For full details of Citroën Care for Car and Driver, please see the full manufacturer's price list. The Citroën Website contains full information on all Citroën products and offers available in the UK, together with details of our environmental and recycling policies. The site address is: [www.citroen.co.uk](http://www.citroen.co.uk) or you can contact Citroën directly via [cuk\\_contactcentre@citroen.com](mailto:cuk_contactcentre@citroen.com)

CITROËN prefers TOTAL

CITROËN UK Ltd. 221 Bath Road, Slough SL1 4BA.  
[www.citroen.co.uk](http://www.citroen.co.uk)

CRÉATIVE TECHNOLOGIE

