



The new A3 and S3 range
Pricing and Specification Guide
Valid from April 2009



A User's Guide

This guide has been designed to help you tailor and price your new Audi A3 quickly and logically. At the back of this guide you will find information on CO2 emissions-based vehicle excise duty and the other services offered by Audi, including Finance and Insurance. Just visit audi.co.uk to configure your new Audi A3 online.

From the website, you can also access the Audi Channel player and see your potential new car in action on the following programmes:

Drivetime

www.audi.co.uk/A3drivetime

www.audi.co.uk/A3Sportbackdrivetime

www.audi.co.uk/S3drivetime

Your Audi

www.audi.co.uk/A3youraudi

www.audi.co.uk/A3Sportbackyouraudi

www.audi.co.uk/S3youraudi

Alternatively, you can tune into the Audi Channel at any time on Sky Guide No. 884 to see a whole range of programmes about the Audi range and our motorsport achievements.



Table of content

	Page Number
Introduction	
The new Audi A3	
Engines	6
Model details and prices	
Standard models	8
SE models	10
Sport models	12
S line models	14
Black Edition models	16
S3	18
Transmission	22
Colour and upholstery	
Paint finishes	24
Upholstery options	26
Colour and trim guide	30
Inlays	32
Options	
Wheels, tyres and suspension	34
Packages	36
Audio and communication	36
Seats	38
Steering wheels	39
Safety and security	40
Interior equipment	42
Exterior equipment	43
Audi centre-fitted accessories	44
Audi exclusive	
Audi exclusive options	46
Technical details	
Technical data	54
Dimensions	62
Additional information	66

The new Audi A3

Combining innovative concepts with modern design, the new Audi A3 is designed to be both versatile and sophisticated. Impressive from every angle, the new A3 boasts a stylish exterior with new headlight and taillight designs. And the chrome-trimmed grille's bold lines emphasise features that are unmistakably Audi. From the standard servotronic steering, distributing power evenly and precisely, to the athletic suspension of the quattro® all-wheel-drive system, each element of the A3 is designed for ultimate driving pleasure.

The comfortable interior has also undergone a few changes. Combining a new instrument cluster design with chrome trim, the A3 is noted for its modern styling. So as well as looking the part, the responsive drive and efficient range of engines ensure that the drive delivers too. Not only does the extensive range now offer more efficient petrol TFSI engines and new common-rail 2.0 TDI diesel engines, there's also the option to add dual-clutch S tronic transmission for even greater performance. And that's not all – the range is now more economical than ever with fuel consumption lowered by up to 15% and reduced CO₂ emissions.

Expressing yourself through the A3 is easy with a choice of new options. The Parallel Park Assist, a new introduction to the innovative Audi range, not only detects a good parking space but even steers the car into position. And for even better chassis control and handling, Audi Magnetic Ride is now available.

It's these new additions together with a wide range of multimedia, styling and practical options that ensure the new A3 is specifically tailored to suit your needs. So however you choose to customise your car, you can be confident that you've made it your own.





Engines

Petrol

The new Audi A3 model range includes an impressive turbocharged direct-injection TFSI® engine which is now even more efficient. TFSI® is a unique Audi innovation, combining turbo-charging with the FSI® technology originally developed for the Le Mans 24-hour endurance race to deliver increased power and torque, as well as enhanced fuel efficiency. Precisely the right amount of fuel and air are injected directly into the combustion chambers, 'unthrottling' the engine and enabling it to 'breathe' more easily. At the same time, electronics monitor the engine load and adjust the injection process. The result – reduced heat-loss and increased output, with around a 15% reduction in fuel consumption and significantly lower exhaust emissions. Ideal for someone who's looking for an uncompromising, exhilarating drive.



Diesel

We introduced TDI to the roads in 1989, marking a departure from the noisy, fuel-thirsty diesel engines of the past. And since then, we've continuously refined it, recently developing common-rail technology for even more efficiency and power. Under this system, a series of piezo injectors use electrical charge to precisely control the amount of fuel injected into the engine. As well as reducing noise, this allows combustion to happen at a lower temperature, with less oxygen, which cuts down emissions. In fact, it means that the new 2.0 TDI engine already complies with the proposed EU IV emission limits planned for 2010. So not only does common-rail technology help to protect the environment, it also enables us to future-proof our cars.





Standard model equipment

All new A3 models have the following items of standard equipment:

Engine

Automatic start/stop function for greater fuel and CO₂ efficiency. Comprising;

- Recuperation for optimal energy utilisation
- Energy saving tips feature in Driver's Information System; including gearshift indicator (if fitted)

(Only available on the 1.4 TFSI manual)

Wheels, tyres and suspension

16 x 6.5J '7-arm' design alloy wheels with 205/55 R16 tyres and locking wheel bolts
Space saving spare wheel

Audio and communication

Audi Chorus radio/single CD player with front speakers

Seats

Driver and front passenger seat manually adjustable
Easy Entry front seats (3-door only)
'Frequency' fabric upholstery

Seat belts – 3-point on all seats
Split-folding rear seats (1/3; 2/3 or all)

Safety and security

Audi backguard head restraints for front seats (adjustable)
Driver, front passenger and front side airbag system
Electronic Stability Programme (ESP), including ABS, EBD, ASR and EDL
Halogen headlights
ISOFIX child seat preparation for front passenger seat (with airbag disabling feature) and rear seats
Rear fog light
Rear head restraints (adjustable)
Remote central locking
Servotronic (speed dependent) power steering
Thatcham Category 1 Alarm and Immobiliser
Tool kit and car jack
Warning triangle

Exterior equipment

Body-coloured door mirrors with integrated indicators
Electrically operated and heated door mirrors

Interior equipment

3-spoke leather steering wheel with gear-change paddles (1.8 TFSI and 2.0 TDI S tronic models only)
4-spoke leather steering wheel
Dampened grab handles
Electric front and rear windows (Sportback only)
Electric front windows (3-door only)
Front and rear floor mats
Granite, Umbra or Opal inlays and door trim (depending on upholstery colour – see page 32)
Heat-insulating glass
Heated rear windscreen
Manual air conditioning
Manual headlight adjustment
Steering wheel adjustable for height and reach
Washer fluid level indicator



16 x 6.5J '7-arm' design alloy wheels



Body-coloured door mirrors with integrated indicators



Driver, passenger and side airbag system (rear side airbags optional)

Standard model prices

A3 – Petrol

Engines	Power	Transmission	Basic RRP	Total RRP ^{inc. VAT}	Recommended OTR
1.6	102PS	5-speed manual	£12,604.35	£14,495.00	£15,260.00
1.6 Technik	102PS	5-speed manual	£12,943.48	£14,885.00	£15,650.00
1.4 TFSI	125PS	6-speed manual	£14,034.78	£16,140.00	£16,880.00
1.8 TFSI	160PS	6-speed manual	£15,478.26	£17,800.00	£18,565.00
2.0 TFSI	200PS	6-speed manual	£16,586.96	£19,075.00	£19,840.00

A3 – Diesel

Engines	Power	Transmission	Basic RRP	Total RRP ^{inc. VAT}	Recommended OTR
1.9 TDle	105PS	5-speed manual	£14,273.91	£16,415.00	£17,070.00
2.0 TDI	140PS	6-speed manual	£15,756.52	£18,120.00	£18,860.00
2.0 TDI	170PS	6-speed manual	£16,547.83	£19,030.00	£19,770.00
2.0 TDI quattro*	170PS	6-speed manual	£17,739.13	£20,400.00	£21,140.00

A3 Sportback – Petrol

Engines	Power	Transmission	Basic RRP	Total RRP ^{inc. VAT}	Recommended OTR
1.6	102PS	5-speed manual	£13,073.91	£15,035.00	£15,800.00
1.6 Technik	102PS	5-speed manual	£13,413.04	£15,425.00	£16,190.00
1.4 TFSI	125PS	6-speed manual	£14,504.35	£16,680.00	£17,420.00
1.8 TFSI	160PS	6-speed manual	£15,947.83	£18,340.00	£19,105.00
2.0 TFSI	200PS	6-speed manual	£17,056.52	£19,615.00	£20,405.00

A3 Sportback – Diesel

Engines	Power	Transmission	Basic RRP	Total RRP ^{inc. VAT}	Recommended OTR
1.9 TDle	105PS	5-speed manual	£14,743.48	£16,955.00	£17,610.00
2.0 TDI	140PS	6-speed manual	£16,226.09	£18,660.00	£19,400.00
2.0 TDI	170PS	6-speed manual	£17,017.39	£19,570.00	£20,310.00
2.0 TDI quattro*	170PS	6-speed manual	£18,208.70	£20,940.00	£21,680.00

SE model equipment

In addition to Standard model equipment:

Basic RRP	Total RRP ^{inc.} _{VAT}
£552.17	£635.00

Wheels, tyres and suspension

16 x 6.5J '6-spoke design' alloy wheels with 205/55 R16 tyres
(Standard model wheels on 1.9 TDIe)

Exterior equipment

Front fog lights

Interior equipment

4-spoke leather multi-function steering wheel (with gear-change paddles on S tronic models)

Front centre armrest

Driver's Information System



Driver's Information System



16 x 6.5J '6-spoke design' alloy wheels



Front centre armrest

SE model prices

A3 – Petrol

Engines	Power	Transmission	Basic RRP	Total RRP ^{inc. VAT}	Recommended OTR
1.6	102PS	5-speed manual	£13,156.52	£15,130.00	£15,895.00
1.6 Technik	102PS	5-speed manual	£13,495.65	£15,520.00	£16,285.00
1.4 TFSI	125PS	6-speed manual	£14,586.96	£16,775.00	£17,515.00
1.8 TFSI	160PS	6-speed manual	£16,030.43	£18,435.00	£19,200.00
2.0 TFSI	200PS	6-speed manual	£17,139.13	£19,710.00	£20,475.00

A3 – Diesel

Engines	Power	Transmission	Basic RRP	Total RRP ^{inc. VAT}	Recommended OTR
1.9 TDIe	105PS	5-speed manual	£14,826.09	£17,050.00	£17,705.00
2.0 TDI	140PS	6-speed manual	£16,308.70	£18,755.00	£19,495.00
2.0 TDI	170PS	6-speed manual	£17,100.00	£19,665.00	£20,405.00
2.0 TDI quattro®	170PS	6-speed manual	£18,291.30	£21,035.00	£21,775.00

A3 Sportback – Petrol

Engines	Power	Transmission	Basic RRP	Total RRP ^{inc. VAT}	Recommended OTR
1.6	102PS	5-speed manual	£13,626.09	£15,670.00	£16,435.00
1.6 Technik	102PS	5-speed manual	£13,965.22	£16,060.00	£16,825.00
1.4 TFSI	125PS	6-speed manual	£15,056.52	£17,315.00	£18,055.00
1.8 TFSI	160PS	6-speed manual	£16,500.00	£18,975.00	£19,740.00
2.0 TFSI	200PS	6-speed manual	£17,608.70	£20,250.00	£21,040.00

A3 Sportback – Diesel

Engines	Power	Transmission	Basic RRP	Total RRP ^{inc. VAT}	Recommended OTR
1.9 TDIe	105PS	5-speed manual	£15,295.65	£17,590.00	£18,245.00
2.0 TDI	140PS	6-speed manual	£16,778.26	£19,295.00	£20,035.00
2.0 TDI	170PS	6-speed manual	£17,569.57	£20,205.00	£20,945.00
2.0 TDI quattro®	170PS	6-speed manual	£18,760.87	£21,575.00	£22,315.00

Sport model equipment

In addition to SE model equipment:

Basic RRP	Total RRP ^{inc.} VAT
£1,021.74	£1,175.00
No charge upgrade from Standard on 1.9 TDi models*	

Wheels, tyres and suspension

17 x 6.5J '5-spoke star design' alloy wheels with 225/45 R17 tyres

Sports suspension (lowered by 15mm)

Audio and communication

AUX-IN socket in front-centre compartment

Concert single front-loading CD player with MP3 file compatibility with active front and rear speakers

Seats

'Dynamic' cloth upholstery

Front Sports seats

Interior equipment

3-spoke leather Sports multi-function steering wheel (with gear-change paddles on S tronic models)

Aluminium medial silver inlays and door trims

Door sills with aluminium inlays

Dual-zone electronic climate control

Sun-blind in rear parcel shelf



17 x 6.5J '5-spoke star design' alloy wheels



Front Sports seats



Dual-zone electronic climate control

Sport model prices

A3 – Petrol

Engines	Power	Transmission	Basic RRP	Total RRP ^{inc. VAT}	Recommended OTR
1.6	102PS	5-speed manual	£14,178.26	£16,305.00	£17,070.00
1.4 TFSI	125PS	6-speed manual	£15,608.70	£17,950.00	£18,690.00
1.8 TFSI	160PS	6-speed manual	£17,052.17	£19,610.00	£20,375.00
2.0 TFSI	200PS	6-speed manual	£18,160.87	£20,885.00	£21,650.00
2.0 TFSI quattro®	200PS	6-speed S tronic	£20,586.96	£23,675.00	£24,465.00

A3 – Diesel

Engines	Power	Transmission	Basic RRP	Total RRP ^{inc. VAT}	Recommended OTR
1.9 TDIe	105PS	5-speed manual	£14,273.91	£16,415.00	£17,070.00
2.0 TDI	140PS	6-speed manual	£17,330.43	£19,930.00	£20,670.00
2.0 TDI	170PS	6-speed manual	£18,121.74	£20,840.00	£21,580.00
2.0 TDI quattro®	170PS	6-speed manual	£19,313.04	£22,210.00	£22,950.00

A3 Sportback – Petrol

Engines	Power	Transmission	Basic RRP	Total RRP ^{inc. VAT}	Recommended OTR
1.6	102PS	5-speed manual	£14,647.83	£16,845.00	£17,610.00
1.4 TFSI	125PS	6-speed manual	£16,078.26	£18,490.00	£19,230.00
1.8 TFSI	160PS	6-speed manual	£17,521.74	£20,150.00	£20,915.00
2.0 TFSI	200PS	6-speed manual	£18,630.43	£21,425.00	£22,215.00
2.0 TFSI quattro®	200PS	6-speed S tronic	£21,056.52	£24,215.00	£25,005.00

A3 Sportback – Diesel

Engines	Power	Transmission	Basic RRP	Total RRP ^{inc. VAT}	Recommended OTR
1.9 TDIe	105PS	5-speed manual	£14,743.48	£16,955.00	£17,610.00
2.0 TDI	140PS	6-speed manual	£17,800.00	£20,470.00	£21,210.00
2.0 TDI	170PS	6-speed manual	£18,591.30	£21,380.00	£22,120.00
2.0 TDI quattro®	170PS	6-speed manual	£19,782.61	£22,750.00	£23,490.00

S line model equipment

In addition to Sport model equipment:

Basic RRP	Total RRP ^{inc.} _{VAT}
£1,317.39	£1,515.00

Wheels, tyres and suspension

18 x 7.5J '7 twin-spoke' design alloy wheels with 225/40 R18 tyres

S line suspension (10mm lower than Sport)

Seats

Black Sprint cloth/leather upholstery with embossed S line logo

Exterior equipment

S line body styling comprising sporty front bumper with enhanced fins and chrome front fog lamp surrounds

Sporty rear bumper with platinum grey diffuser insert

S line badges on front wings

Chrome trimmed exhaust tailpipes

Interior equipment

3-spoke leather S line multi-function steering wheel (with gear-change paddles on S tronic models)

Matt-brushed aluminium inlays

Door sills with aluminium inlays and S line lettering

Black leather trimmed handbrake

Black perforated-leather trimmed gear knob

Black headlining

Floor mats with black or silver stitching



Matt-brushed aluminium inlays



Black Sprint cloth/leather upholstery with embossed S line logo



Black leather trimmed gear knob

S line model prices

A3 – Petrol

Engines	Power	Transmission	Basic RRP	Total RRP ^{inc. VAT}	Recommended OTR
1.6	102PS	5-speed manual	£15,495.65	£17,820.00	£18,585.00
1.4 TFSI	125PS	6-speed manual	£16,926.09	£19,465.00	£20,205.00
1.8 TFSI	160PS	6-speed manual	£18,369.57	£21,125.00	£21,890.00
2.0 TFSI	200PS	6-speed manual	£19,478.26	£22,400.00	£23,165.00
2.0 TFSI quattro®	200PS	6-speed S tronic	£21,904.35	£25,190.00	£25,980.00

A3 – Diesel

Engines	Power	Transmission	Basic RRP	Total RRP ^{inc. VAT}	Recommended OTR
2.0 TDI	140PS	6-speed manual	£18,647.83	£21,445.00	£22,185.00
2.0 TDI	170PS	6-speed manual	£19,439.13	£22,355.00	£23,095.00
2.0 TDI quattro®	170PS	6-speed manual	£20,630.43	£23,725.00	£24,465.00

A3 Sportback – Petrol

Engines	Power	Transmission	Basic RRP	Total RRP ^{inc. VAT}	Recommended OTR
1.6	102PS	5-speed manual	£15,965.22	£18,360.00	£19,125.00
1.4 TFSI	125PS	6-speed manual	£17,395.65	£20,005.00	£20,745.00
1.8 TFSI	160PS	6-speed manual	£18,839.13	£21,665.00	£22,430.00
2.0 TFSI	200PS	6-speed manual	£19,947.83	£22,940.00	£23,730.00
2.0 TFSI quattro®	200PS	6-speed S tronic	£22,373.91	£25,730.00	£26,520.00

A3 Sportback – Diesel

Engines	Power	Transmission	Basic RRP	Total RRP ^{inc. VAT}	Recommended OTR
2.0 TDI	140PS	6-speed manual	£19,117.39	£21,985.00	£22,725.00
2.0 TDI	170PS	6-speed manual	£19,908.70	£22,895.00	£23,635.00
2.0 TDI quattro®	170PS	6-speed manual	£21,100.00	£24,265.00	£25,005.00

Black Edition model equipment

In addition to S line model equipment:

Basic RRP	Total RRP ^{inc.} VAT
£786.96	£905.00

Wheels, tyres and suspension

18 x 7.5J '7 twin-spoke titanium finish' alloy wheels with 225/40 R18 tyres

Audio and communication

BOSE® premium sound system. 8 high-performance loudspeakers, 6-channel amplifier, total output of 195 Watts with specially tuned acoustics

Interior equipment

Flat-bottomed S line multi-function steering wheel (with gear change controls on S tronic models)

Piano finish black inlays

Exterior equipment

Black Styling package – radiator grille-frame in highly polished black, with radiator grille and number plate holder in matt black

Privacy glass, dark tinted from B pillar backwards

Xenon Plus headlights with automatic headlamp adjustment, dynamic range and headlamp washers with LED daytime-running lights



18 x 7.5J '7 twin-spoke titanium finish' alloy wheels



Flat-bottomed S line multi-function steering wheel



Piano finish black inlays

Black Edition model prices

A3 – Petrol

Engines	Power	Transmission	Basic RRP	Total RRP ^{inc. VAT}	Recommended OTR
1.8 TFSI	160PS	6-speed manual	£19,156.52	£22,030.00	£22,795.00
2.0 TFSI	200PS	6-speed manual	£20,265.22	£23,305.00	£24,070.00
2.0 TFSI quattro®	200PS	6-speed S tronic	£22,691.30	£26,095.00	£26,885.00

A3 Sportback – Petrol

Engines	Power	Transmission	Basic RRP	Total RRP ^{inc. VAT}	Recommended OTR
1.8 TFSI	160PS	6-speed manual	£19,626.09	£22,570.00	£23,335.00
2.0 TFSI	200PS	6-speed manual	£20,734.78	£23,845.00	£24,635.00
2.0 TFSI quattro®	200PS	6-speed S tronic	£23,160.87	£26,635.00	£27,425.00

A3 – Diesel

Engines	Power	Transmission	Basic RRP	Total RRP ^{inc. VAT}	Recommended OTR
2.0 TDI	140PS	6-speed manual	£19,434.78	£22,350.00	£23,090.00
2.0 TDI	170PS	6-speed manual	£20,226.09	£23,260.00	£24,000.00
2.0 TDI quattro®	170PS	6-speed manual	£21,417.39	£24,630.00	£25,370.00

A3 Sportback – Diesel

Engines	Power	Transmission	Basic RRP	Total RRP ^{inc. VAT}	Recommended OTR
2.0 TDI	140PS	6-speed manual	£19,904.35	£22,890.00	£23,630.00
2.0 TDI	170PS	6-speed manual	£20,695.65	£23,800.00	£24,540.00
2.0 TDI quattro®	170PS	6-speed manual	£21,886.96	£25,170.00	£25,910.00





S3 model equipment (selection)

Even from a distance, the new Audi S3 radiates power and charisma. Athletic body styling, 18" alloy wheels, Xenon headlamps with LED daytime-running lights and a low-slung body all hint at the breathtaking 265PS of power that awaits you. And as you take the flat-bottomed multi-function leather steering wheel and burst from 0 to 62mph in 5.7 seconds, you'll also be

amazed by the striking interior specification. Heated leather Sports seats, aluminium trim and 'S' design instrument dials all complement this model's sporty character perfectly. Just read on to discover more about the standard and optional equipment available in the Audi S3.

Wheels, tyres and suspension

18" parallel 5-spoke 'S' design alloy wheels with 225/40 R18 Y tyres
Space saver spare wheel

Audio and communication

AUX-IN socket in front centre compartment
Concert single front-loading CD player with MP3 file compatibility and active front and rear speakers
Driver's Information System (DIS)

Seats

Black Silk Nappa leather upholstery with embossing
Front Sports seats (optional front bucket seats available)
Heated front seats

Safety and security

quattro® all-wheel-drive

Exterior equipment

2 chrome oval-shaped exhaust pipes
Aluminium-look door mirror housings
Black brake callipers with S3 emblem
'S' body styling
'S' Sports suspension

Xenon Plus headlights with headlight washers and LED daytime-running lights

Interior equipment

6-speed manual transmission with reduced shift travel
Aluminium-look pedals
Dual-zone electronic climate control
Flat-bottomed leather 3-spoke Sports multi-function steering wheel, with 'S' emblem
Front and rear floor mats with silver edging
Front centre armrest
Illuminated vanity mirrors
Matt-brushed aluminium inlays
'S' instrument dials
Scuff plates with S3 logo



18" parallel 5-spoke 'S' design alloy wheels



Flat-bottomed multi-function steering wheel, with 'S' emblem



Aluminium-look pedals

S3 model prices

S3

Engines	Power	Transmission	Basic RRP	Total RRP ^{inc. VAT}	Recommended OTR
2.0 TFSI quattro®	265PS	6-speed manual	£23,169.57	£26,645.00	£27,475.00

S3 Sportback

Engines	Power	Transmission	Basic RRP	Total RRP ^{inc. VAT}	Recommended OTR
2.0 TFSI quattro®	265PS	6-speed manual	£23,639.13	£27,185.00	£28,015.00



Recommended On-The-Road (OTR) retail prices include: delivery charge, half a tank of fuel, number plates at £565.00 (inc. VAT), Road Fund Licence (which may vary depending on model/transmission – see page 66 for details) and first registration fee at £55.00.

Please note images shown are for illustration purposes only and do not necessarily depict UK specification.





Transmission

S tronic (6-speed)

Audi offers a variety of different transmission options to suit your requirements and driving style. In addition to the classic manual gearbox are two innovative, semi-automatic transmission options. To help you come to an informed decision, each of these is described in detail opposite.

The revolutionary S tronic gearbox combines the agility and responsiveness of a conventional 6-speed manual gearbox with the convenience and smooth, uninterrupted power of an automatic transmission. The technical basis of the S tronic gearbox is the double clutch. This consists of two lubricated plates with hydraulically-regulated contact pressure. One engages the odd-numbered gears, the other the even-numbered, enabling gear-shifts to be made in a fraction of a second, with no disruption to the power flow. Depending on how the mood takes you, you can either allow gear-changes to take place automatically or, for a sportier driving style, operate the S tronic system using the gear lever or steering wheel shift-paddles. The choice is yours.

S tronic (7-speed)

The 1.6, 1.4 TFSI and 1.8 TFSI models are now available with the new 7-gear version of our highly-acclaimed S tronic gearbox. The extra gear, along with a dry-clutch set-up, results in improved fuel economy and lower CO₂ emissions. As with the 6-speed S tronic gearbox, this gear system can be operated in fully automatic mode, or using the gear lever or steering wheel gear-change controls for a sportier driving style.

Transmission

	1.6	1.4 TFSI	1.8 TFSI	2.0 TFSI*	2.0 TFSI quattro®	S3	1.9 TDi	2.0 TDi (140 and 170PS)	2.0 TDi quattro®	Basic RRP	Total RRP ^{inc. VAT}
6-speed S tronic	-	-	-	•	S	•	-	•	-	£1,234.78	£1,420.00
7-speed S tronic	•	•	•	-	-	-	-	-	-	£1,234.78	£1,420.00



Options are subject to availability and may extend delivery.
 - = Not available • = Available

RRP – Recommended Retail Price.
 *2.0 TFSI S tronic only available on Sport and S line models.

Paint finishes

Standard colours

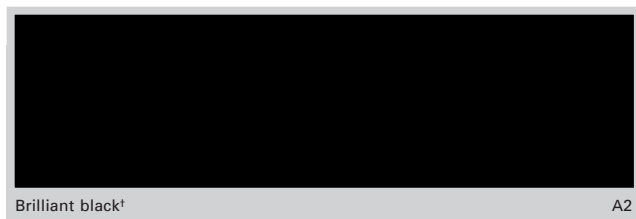
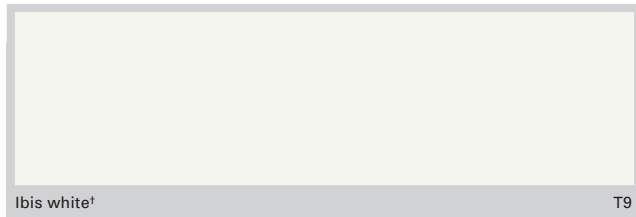

Optional colours

Basic RRP	Total RRP <small>inc. VAT</small>
£426.09	£490.00

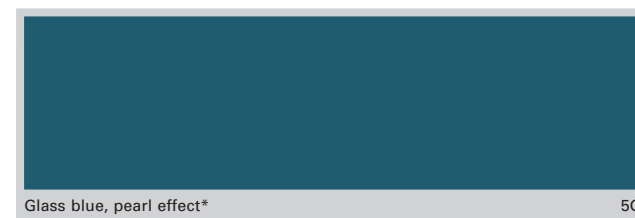
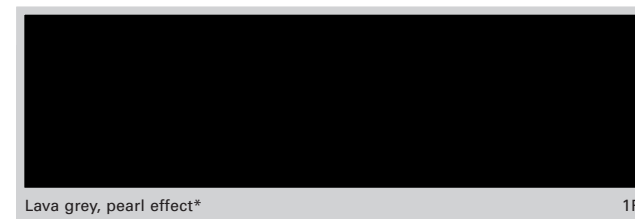
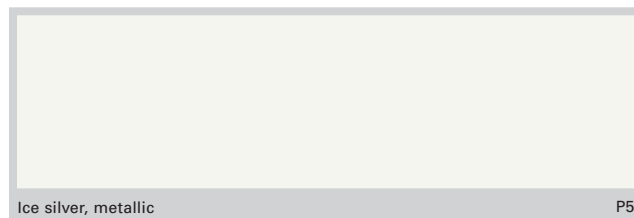

S3 optional colours

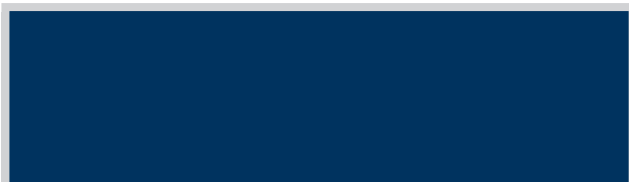

Aruba blue, pearl effect*

Q9



Phantom black, pearl effect†

L8



Solar orange

3F

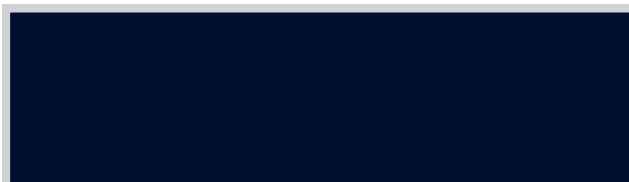

Deep sea blue, pearl effect

8A



Misano red, pearl effect (only available on S line models)*†

N9



Sprint blue, pearl effect

5N

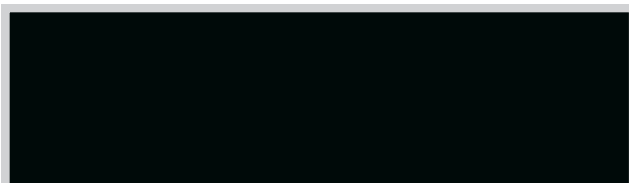

Deep green, pearl effect*

3W



Monza silver, metallic (only available on S line models)*†

U7



Imola yellow

1T







Garnet red, pearl effect*

9C



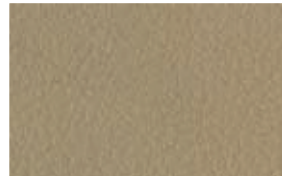

Upholstery

Standard seats

				Standard	SE	Sport	S line	Black Edition	S3	Basic RRP	Total RRP ^{inc. VAT}
				S	S	-	-	-	-	No charge	No charge
Frequency cloth, Black MB	Frequency cloth, Mineral grey BW	Frequency cloth, Light grey BX									
				•	•	-	-	-	-	£1,021.74	£1,175.00
Vienna leather, Black MB	Vienna leather, Mineral grey BW	Vienna leather, Light grey BX	Vienna leather, Luxor beige BU/BV*								

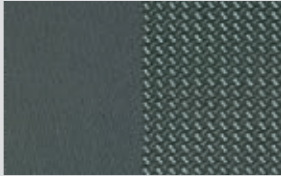
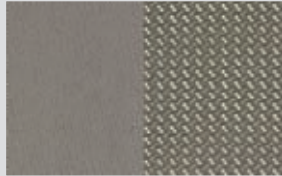
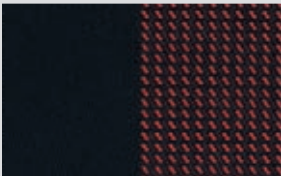
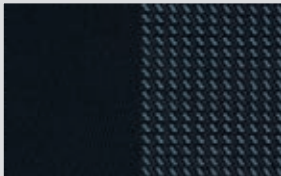
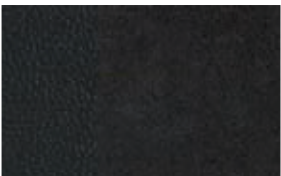
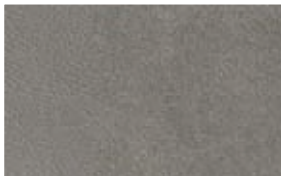
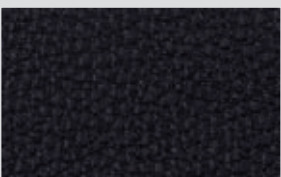
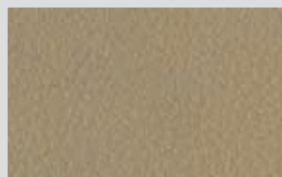
Upholstery

Sports seats

				Standard	SE	Sport	S line	Black Edition	S3	Basic RRP	Total RRP ^{inc. VAT}
	Dynamic cloth, Black/silver	BS		-	-	S	-	-	-	No charge	No charge
	Dynamic cloth, Mineral grey	BW									
	Dynamic cloth, Light grey	BX									
	Dynamic cloth, Black/red	MR									
	Dynamic cloth, Black/blue	MQ									
	Alcantara/leather, Black	MB		-	-	•	-	-	-	£656.52	£755.00
	Alcantara/leather, Light grey	BX									
	Vienna leather, Black	MB		-	-	•	-	-	-	£852.17	£980.00
	Vienna leather, Light grey	BX									
	Vienna leather, Mineral grey	BW									
	Vienna leather, Luxor beige	BU/BV*									
	Fine Nappa leather, Black	MB		-	-	•	-	-	-	£1,021.74	£1,175.00
	Fine Nappa leather, Red	CW									
	Fine Nappa leather, Mustang brown	BT									

Options are subject to availability and may extend delivery.
 - = Not available • = Available S = Standard

RRP – Recommended Retail Price.
 *BU on 3-door/BV on Sportback.



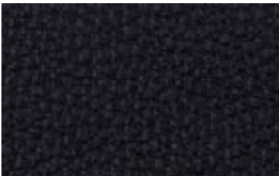
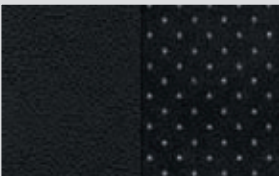

Upholstery

S line and Black Edition seats

	Standard	SE	Sport	S line	Black Edition	S3	Basic RRP	Total RRP ^{inc. VAT}
 <p>Black Sprint cloth/leather QF/QE</p>	-	-	-	S	S	-	No charge	No charge
 <p>Black Vienna leather QE</p>	-	-	-	●	●	-	£595.65	£685.00
 <p>Black Perforated Alcantara/leather QF/QE</p>	-	-	-	●	●	-	£400.00	£460.00

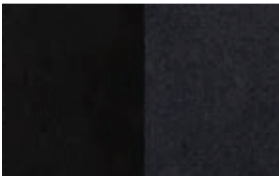
Upholstery

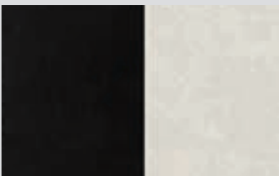
S3 seats

		Standard	SE	Sport	S line	Black Edition	S3	Basic RRP	Total RRP ^{inc. VAT}
	Embossed Silk Nappa leather ZM/ZN	-	-	-	-	-	S	No charge	No charge
	Pearl leather/Alcantara, Black ZM/ZN	-	-	-	-	-	•	No charge	No charge
	Pearl leather/Alcantara, Black/Silver ZW/ZX	-	-	-	-	-	•	No charge	No charge
	Two-tone Silk Nappa leather, Silver/Black ZB/ZA	-	-	-	-	-	•	£256.52	£295.00
	Two-tone Silk Nappa leather, Magma red/Black FA/FD	-	-	-	-	-	•	£256.52	£295.00
	Two-tone Black/Signal orange (exclusive) PYZ (S3G)	-	-	-	-	-	•	£1,660.87	£1,910.00
<p>Audi exclusive leather equipment in Orange/Black with Orange seams. Seat-centre section in Signal orange leather, seat-side sections and head restraints in Black leather with contrasting Orange stitching. Steering wheel, handbrake handle and gear-lever gaiter in Black leather with Orange stitching. Black front and rear floor mats with Orange leather piping</p>		-	-	-	-	-	•	£1,660.87	£1,910.00

Options are subject to availability and may extend delivery.
 - = Not available • = Available S = Standard

RRP – Recommended Retail Price.

Colour and trim guide

To help you choose the right interior for your new Audi A3, please use the guide below, showing the carpet, dashboard and headlining colours that have been matched to your chosen upholstery.

Standard and SE models – Interior trim colours:

Order Code	Upholstery	Carpet	Dashboard (Upper/Lower)	Headlining	Frequency cloth (N5G)	Vienna leather (WLV)	Alcantara/leather (N7U)	Fine Nappa leather (N3Q)
MB	Black	Black	Black/Black	Silver	●	●	–	–
BW	Mineral grey	Mineral grey	Black/Mineral grey	Silver	●	●	–	–
BX	Light grey	Light grey	Black/Light grey	Silver	●	●	–	–
BU*	Luxor beige	Black	Black/Black	Beige	–	●	–	–
BV**	Luxor beige	Luxor beige	Black/Luxor beige	Beige	–	●	–	–

Sport models – Interior trim colours:

Order Code	Upholstery	Carpet	Dashboard (Upper/Lower)	Headlining	Dynamic cloth (N5B)	Vienna leather (N1A)	Alcantara/leather (N7U)	Fine Nappa leather (N3Q)	exclusive line package (WQK)
BS	Black/Silver	Black	Black/Black	Silver	●	–	–	–	–
MQ	Black/Blue	Black	Black/Black	Silver	●	–	–	–	–
MR	Black/Red	Black	Black/Black	Silver	●	–	–	–	–
BW	Mineral grey	Mineral grey	Black/Mineral grey	Silver	●	●	–	–	–
BX	Light grey	Light grey	Black/Light grey	Silver	●	●	●	–	–
MB	Black	Black	Black/Black	Silver	–	●	●	●	–
BU*	Luxor beige	Black	Black/Black	Beige	–	●	–	–	–
BV**	Luxor beige	Luxor beige	Black/Luxor beige	Beige	–	●	–	–	–
BT	Mustang brown	Black	Black/Black	Silver	–	–	–	●	–
CW	Red	Black	Black/Black	Silver	–	–	–	●	–
QY	Crimson red/Black	Black	Black	Black	–	–	–	–	●
QL	Silver/Black	Black	Black	Black	–	–	–	–	●
QX	Cognac/Black	Black	Black	Black	–	–	–	–	●

Options are subject to availability and may extend delivery.
 – = Not available ● = Available

*3-door only.
 **Sportback only.

Colour and trim guide

S line and Black Edition models – Interior trim colours:



Order Code	Upholstery	Carpet	Dashboard (Upper/Lower)	Headlining	Sprint cloth/leather (N7V)	Vienna leather (N1R)	Perforated Alcantara/leather (N7K)	exclusive line package (WQI)
QE	Black (with black stitching)	Black	Black/Black	Black	●	●	●	–
QF	Black (with silver stitching)	Black	Black/Black	Black	●	–	●	–
QY	Crimson red/Black	Black	Black	Black	–	–	–	●
QL	Silver/Black	Black	Black	Black	–	–	–	●
QX	Cognac/Black	Black	Black	Black	–	–	–	●

S3 models – Interior trim colours:

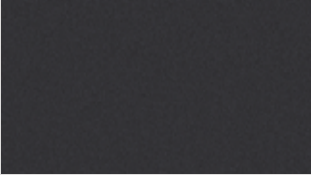
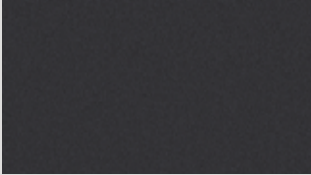
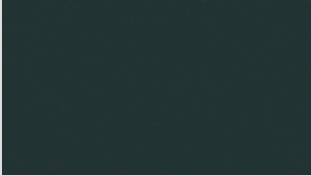

Order Code	Upholstery	Carpet	Dashboard (Upper/Lower)	Headlining	Silk Nappa leather, embossed (N1U)	Two-tone Silk Nappa leather with contrasting stitching (N5X)	Alcantara/Pearl leather (N7U)	Bucket seats in Fine Nappa leather (PS5)
ZM	Black	Black	Black/Black	Black	●	–	●	●
ZN	Black	Black	Black/Black	Silver	●	–	●	●
ZA	Silver/Black	Black	Black/Black	Black	–	●	–	–
ZB	Silver/Black	Black	Black/Black	Silver	–	●	–	–
FA	Magma red/Black	Black	Black/Black	Black	–	●	–	–
FD	Magma red/Black	Black	Black/Black	Silver	–	●	–	–
ZM	Signal orange/Black**	Black	Black/Black	Black	–	●	–	–
ZN	Signal orange/Black**	Black	Black/Black	Silver	–	●	–	–
ZW	Black/silver	Black	Black/Black	Black	–	–	●	–
ZX	Black/silver	Black	Black/Black	Silver	–	–	●	–

**Available through Audi exclusive

Inlays

Order code			Standard	SE	Sport	S line	Black Edition	S3	Basic RRP	Total RRP <small>inc. VAT</small>	
5MC		Granite*		S	S	-	-	-	-	No charge	No charge
		Umbral*									
5TD		Opal*	-	-	S	-	-	-	No charge	No charge	
		Medial aluminium									
5TG		Matt-brushed aluminium	-	-	-	S	•	S	No charge	No charge	

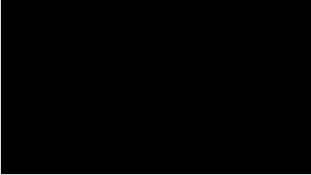
Inlays

Order code			Standard	SE	Sport	S line	Black Edition	S3	Basic RRP	Total RRP <small>inc. VAT</small>
5TL		Piano finish black	-	-	-	•	S	•	No charge	No charge
5TZ		Fine grain birch wood, grey	-	-	-	-	-	•	No charge	No charge
5MG/6Q3		Walnut brown wood (includes wooden gear knob on manual transmission)	• -	• -	- •	- -	- -	- -	£300.00 £147.83	£345.00 £170.00
6Q6	Aluminium gear knob (only available in conjunction with manual transmission)		-	-	•	•	•	-	£86.96	£100.00

Wheels, tyres and suspension

Order code		Standard	SE	Sport	S line	Black Edition	S3	Basic RRP	Total RRP <small>inc. VAT</small>
C4F	17 x 7.5J '5-arm dynamic' design alloy wheels with 225/45 R17 tyres	•	•	-	-	-	-	£426.09	£490.00
		-	-	•	-	-	-	£256.52	£295.00
C4N	17 x 7.5J '16-spoke two-tone' design alloy wheels with 225/45 R17 tyres	•	•	-	-	-	-	£469.57	£540.00
		-	-	•	-	-	-	£300.00	£345.00
CH7	17 x 7.5J '10-spoke' V design alloy wheels with 225/45 R17 tyres	•	•	-	-	-	-	£552.17	£635.00
		-	-	•	-	-	-	£382.61	£440.00



17 x 7.5J '10-spoke' V design alloy wheels (CH7)



17 x 7.5J '5-arm dynamic' design alloy wheels (C4F)



17 x 7.5J '16-spoke two-tone' design alloy wheels (C4N)

Options are subject to availability and may extend delivery.
 - = Not available • = Available S = Standard

Please note: optional alloy wheels not available on 1.9 TDiE.

Wheels, tyres and suspension

Order code		Standard	SE	Sport	S line	Black Edition	S3	Basic RRP	Total RRP <small>inc. VAT</small>
CP4	17 x 7.5J '5-spoke' design alloy wheels with 225/45 R17 tyres	•	•	-	-	-	-	£552.17	£635.00
		-	-	•	-	-	-	£382.61	£440.00
C2Q	18 x 7.5J '20-spoke' design alloy wheels with 225/40 R18 tyres	•	•	-	-	-	-	£926.09	£1,065.00
		-	-	•	-	-	-	£756.52	£870.00
		-	-	-	•	-	-	£169.57	£195.00
		-	-	-	-	-	•	£443.48	£510.00
2H2	Audi magnetic ride. Only available on 2.0 TDI (140 and 170PS), 2.0 TDI quattro®, 1.8 TFSI, 2.0 TFSI and 2.0 TFSI quattro®	-	-	•	•	•	•	£765.22	£880.00



17 x 7.5J '5-spoke' design alloy wheels (CP4)



18 x 7.5J '20-spoke' design alloy wheels (C2Q)

Please note: optional alloy wheels not available on 1.9 TDIe.

Packages

Order code	Standard	SE	Sport	S line	Black Edition	S3	Basic RRP	Total RRP ^{inc. VAT}
Technik upgrade package* <ul style="list-style-type: none"> • Driver's Information System (DIS) • Audi Concert radio with AUX-IN socket • BOSE® premium sound • 17" '5-spoke' design alloy wheels 	•	•	-	-	-	-	£339.13	£390.00

Audio and communication

RCM	Audi Concert radio single front-loading CD player, MP3-compatible with active front and rear speakers. Includes AUX-IN socket in front-centre compartment	•	•	S	S	S	S	£186.96	£215.00
UF7	Audi Music Interface (AMI). Universal connection for use with stereo audio sources, USB and MP3 devices including Apple iPod generation 4 onwards (iPod, iPod classic, iPod mini, iPod nano, iPod photo, iPod video, iPod touch). Provides intuitive control through the audio system and multi-function steering wheel (if fitted). It also replicates the iPod display on the audio screen and Driver's Information System (if fitted), including track titles. The interface provides charging function (dependent on device). Only in combination with DVD Satellite Navigation	•	•	•	•	•	•	£213.04	£245.00
RSM	Audi Symphony radio integrated 6-CD changer with MP3 file compatibility and active front and rear speakers. Includes AUX-IN socket in front-centre compartment	• -	• -	- •	- •	- •	- •	£413.04 £226.09	£475.00 £260.00
PNX	Satellite Navigation System. CD-ROM based route-planning and guidance using voice and pictogram instructions. Includes RDS radio, MP3-compatible CD player, AUX-IN socket, MMI operating logic and UK CD-ROM disc (located in dashboard in lieu of other radio). A CD changer, USB or iPod connection is recommended with this option (only in conjunction with electronic climate control and Driver's Information System). Please note that this option does not include UK TMC functionality	• -	• -	- •	- •	- •	- •	£739.13 £552.17	£850.00 £635.00
PND	Satellite Navigation System Plus. DVD-based route planning and guidance with MMI control logic and 6.5-inch colour monitor, AUX-IN socket, 3D map display, RDS radio, DVD player for Navigation system, audio or MP3 CDs (cannot be used at the same time as Navigation system) and 2 integrated MMC/SD card slots for playing MP3 files. Includes Driver's Information System, European coverage DVD and dynamic route guidance via TMC. Replaces other audio system (only in conjunction with electronic climate control)	• -	• -	- •	- •	- •	- •	£1,591.30 £1,404.35	£1,830.00 £1,615.00
7A2	CD changer for six discs, mounted in the glove box (cannot be combined with Symphony radio, iPod or USB connection)	•	•	•	•	•	•	£273.91	£315.00
UF1	iPod connection, for playing/charging your iPod in the car. Located in glovebox and controllable via radio or multi-function steering wheel (if fitted). Cannot be combined with CD changer or USB connection	•	•	•	•	•	•	£152.17	£175.00

Audio and communication

Order code		Standard	SE	Sport	S line	Black Edition	S3	Basic RRP	Total RRP <small>inc. VAT</small>
UF2	USB connection , for playing your USB stick in the car. Located in glovebox and controlled via radio or multi-function steering wheel (if fitted). Cannot be combined with CD changer or iPod connection	•	•	•	•	•	•	£152.17	£175.00
8RY	BOSE® premium sound system . 8 high-performance loudspeakers, 6-channel amplifier, total output of 195 Watts with specially tuned acoustics (only in combination with Concert or Symphony radio)	•	•	•	•	S	•	£373.91	£430.00
9ZX	Mobile telephone preparation – Bluetooth interface . Provides handsfree connection via Bluetooth using mobile phone aerial. Please contact your Audi centre for phone compatibility. Only in combination with Driver's Information System and multi-function steering wheel	•	•	•	•	•	•	£208.70	£240.00
9ZF	Mobile telephone preparation – low , located on dashboard. Connects to your A3 using Bluetooth interface or cradle. Includes voice control for phone functions, external aerial for optimal reception and charging facility via cradle (required at extra cost – please contact your Audi Centre for details of phone compatibility). A multi-function steering wheel and Driver's Information System are recommended for use with this system	•	-	-	-	-	-	£326.09	£375.00
9ZU	Mobile telephone preparation – low , located in front centre armrest. Connects to your A3 using Bluetooth interface or cradle. Includes voice control for phone functions, external aerial for optimal reception and charging facility via cradle (required at extra cost – please contact your Audi Centre for details of phone compatibility). Only in combination with a multi-function steering wheel, front centre armrest and Driver's Information System	•	•	•	•	•	•	£326.09	£375.00



iPod connection (UF1)



BOSE® premium sound system (8RY)



Mobile telephone preparation (9ZU)

Seats

Order code	Standard	SE	Sport	S line	Black Edition	S3	Basic RRP	Total RRP <small>inc. VAT</small>
PS5	-	-	-	-	-	•	£1,447.83	£1,665.00
3PE	•	•	•	•	•	•	£265.22	£305.00
3L5	•	•	•	•	•	•	£460.87	£530.00
7P1	•	•	•	•	•	•	£160.87	£185.00
4A3	•	•	•	•	•	S	£213.04	£245.00
4A4	•	•	•	•	•	-	£373.91	£430.00
	-	-	-	-	-	•	£160.87	£185.00



Options are subject to availability and may extend delivery.
 - = Not available • = Available S = Standard

Steering wheels

Order code		Standard	SE	Sport	S line	Black Edition	S3	Basic RRP	Total RRP <small>inc. VAT</small>
2ZQ	4-spoke multi-function steering wheel (manual models only – includes Driver's Information System)	•	S	-	-	-	-	£300.00	£345.00
2ZS	4-spoke multi-function steering wheel with gear change paddles (S tronic models only – includes Driver's Information System)	•	S	-	-	-	-	£234.78	£270.00



Safety and security

Order code		Standard	SE	Sport	S line	Black Edition	S3	Basic RRP	Total RRP <small>inc. VAT</small>
7X1	Acoustic parking system (rear only). Aids parking by acoustically indicating distances to obstacles	•	•	•	•	•	•	£256.52	£295.00
7X2	Acoustic parking system plus (front and rear). Aids parking by acoustically indicating distances to obstacles. Includes visual display in combination with DVD Satellite Navigation (where fitted)	•	•	•	•	•	•	£447.83	£515.00
6XE	Exterior door mirrors – electrically folding	•	•	•	•	•	•	£100.00	£115.00
1T3	First-aid kit in storage compartment under front passenger seat	•	•	•	•	•	•	£21.74	£25.00
8N7	High-beam assist. Automatically adjusts headlights from high-beam to dipped-beam when another vehicle is approaching. Only in combination with Driver's Information System and light and rain sensor pack	•	•	•	•	•	•	£86.96	£100.00
7K6	Tyre pressure monitor, gives the driver a visual and acoustic warning when the system detects potential loss of pressure from a tyre. Only in combination with Driver's Information System (price quoted does not include this item)	•	•	•	•	•	•	£65.22	£75.00
8WB	Front fog lights	•	S	S	S	S	S	£113.04	£130.00
PU7 6XJ	Light and rain sensor pack. Auto-dimming rear view mirror and door mirrors, automatic headlights, automatic windscreen wipers and sun band for windscreen	•	•	•	•	•	•	£278.26	£320.00
7X5 UG1	Parallel park assist. Sensor-controlled steering aid to assist parallel parking, with ultrasonic, audible parking sensors on front and rear of car. Includes Audi Hill Hold Assist. Only in combination with Driver's Information System	•	•	•	•	•	•	£617.39	£710.00
4X4	Rear side airbags situated in side of rear seat. Must be combined with through-load system (only available on A3 Sportback models)	•	•	•	•	•	•	£256.52	£295.00



Front fog lights (8WB)



Rear side airbags (4X4)



Interior equipment

Order code		Standard	SE	Sport	S line	Black Edition	S3	Basic RRP	Total RRP <small>inc. VAT</small>
8T2	Cruise control , for holding any speed above 25mph. Only in combination with Driver's Information System	•	•	•	•	•	•	£182.61	£210.00
PI1	Driver's Information System (DIS) , with display for: AutoCheck system, radio frequency (Audi radio only), two adjustable speed-warning thresholds, outside-temperature gauge, on-board computer, gear selected (S tronic models only), doors and boot lid left open, service interval and oil pressure	•	S	S	S	S	S	£169.57	£195.00
9AK	Dual-zone electronic climate control , with separate temperature controls for driver and front passenger	•	•	S	S	S	S	£317.39	£365.00
3FE	Electric tilt-and-slide sunroof with position pre-selection, tinted glass insert, variable sunshield and convenience closing (only available on A3 3-door models)	•	•	•	•	•	•	£491.30	£565.00
6E3	Front centre armrest with storage compartment	•	S	S	S	S	S	£86.96	£100.00
QQ5	Illuminated vanity mirrors	•	•	•	S	S	S	£47.83	£55.00
QQ4	Interior light pack . Illuminated door openers, storage compartment, footwell lighting, active door reflectors and illuminated vanity mirrors	•	•	•	-	-	-	£121.74	£140.00
PKB	Luggage pack , comprising combi-net for fixing into luggage compartment and 12V socket in boot	•	•	•	•	•	•	£73.91	£85.00
9JA	Non-smoking pack , replaces ashtray and cigarette lighter with 12V socket and centre storage compartment	•	•	•	•	•	•	£47.83	£55.00
3FB	Open sky system . Glass roof, electric slide-and-tilt control sunshade front and rear (only available on Sportback models. Not available on 1.9 TDIe Sport Sportback)	•	•	•	•	•	•	No charge	No charge
6SJ	Reversible boot mat	•	•	•	•	•	•	£895.65	£1,030.00
3GD	Reversible load floor . Boot floor can be removed and reversed to form a useful tray area with an easy-to-clean surface (not available on quattro® models)	•	•	•	•	•	-	£43.48	£50.00
QE1	Storage pack comprising nets on back of front seats, storage compartment under driver's seat, map compartment in glovebox, net on side of centre console and bag hooks in luggage compartment. Under-seat storage not available in conjunction with electric seats	•	•	•	•	•	•	£78.26	£90.00
3Y3	Sun screen for rear and side windows , manually operated (only available on Sportback models and built into parcel shelf)	•	•	-	-	-	-	£143.48	£165.00
3Y6	Sun screen for rear window , manually operated	-	-	•	•	•	•	£69.57	£80.00
PZA	Through-load system . Includes removable ski bag and rear centre armrest with cup holder. Holds skis and snowboards and can be removed for transporting long objects	•	•	S	S	S	S	£73.91	£85.00
		•	•	•	•	•	•	£147.83	£170.00

Exterior equipment

Order code		Standard	SE	Sport	S line	Black Edition	S3	Basic RRP	Total RRP <small>inc. VAT</small>
PX4	Adaptive headlights , swivelling headlights for improved illumination of a winding road. Includes Xenon Plus headlights with LED daytime-running lights	●	●	●	-	-	-	£852.17	£980.00
8Q5		-	-	-	●	-	-	£708.70	£815.00
		-	-	-	-	●	●	£243.48	£280.00
3S1	Aluminium roof rails (only available on A3 Sportback models)	●	●	●	●	-	●	£191.30	£220.00
3S2	Black roof rails (only available on A3 Sportback models)	●	●	●	●	●	●	£191.30	£220.00
4ZM	Black Styling package – radiator grille-frame in highly polished black, with radiator grille and numberplate holder in matt black	●	●	●	●	S	●	£256.52	£295.00
6NQ	Black cloth headlining . Only in combination with illuminated vanity mirrors or interior light pack. Price quoted does not include this item	●	●	●	S	S	-	£165.22	£190.00
2Z0	Deletion of model and engine capacity designation at rear	●	●	●	●	●	-	No charge	No charge
VW1	Privacy glass , dark tinted from B pillar backwards	●	●	●	●	S	●	£278.26	£320.00
1D2	Towbar equipment – removable . Factory-fitted towbars (usually require a 13- to 7-pin adaptor. Please consult your Audi Centre for details). Not available on 1.9 TDIe	●	●	●	●	●	-	£473.91	£545.00
PX4	Xenon Plus headlights with automatic headlamp adjustment, dynamic range and headlamp washers with LED daytime-running lights	-	-	-	●	S	S	£465.22	£535.00

Audi Centre-fitted accessories

Audi Centre-fitted accessories offer a range of products that enable you to tailor your Audi A3 to your tastes and requirements. All accessories available on the Audi A3 are covered by a 3-year warranty if ordered and included in the purchase price of the car. All prices exclude fitting, where this is required. Please contact your Audi Centre for further details of accessories available for the Audi A3 or visit www.audi.co.uk/accessories.

Sport and design

	Part number	Basic RRP	Total RRP <small>inc. VAT</small>
18 x 7.5J '5-double-spoke' design alloy wheel , excludes tyres – size required 225/40 R18. (Price shown is for single wheel only)	8P4071498666	£213.04	£245.00
18 x 7.5J '10-spoke' design alloy wheel , excludes tyres – size required 225/40 R18, 225/40 R18. (Price shown is for single wheel only)	8P0071498AW90	£233.91	£269.00
18 x 7.5J '15-multi-spoke' design alloy wheel , excludes tyres – size required 225/40 R18. (Price shown is for single wheel only)	8P0071498B8Z8	£225.22	£259.00
Exhaust tailpipe trims† . Twin pipe	8P0071761	£46.96	£54.00
Exhaust tailpipe trims† . Single pipe	8P0071771	£26.09	£30.00
Body styling package – front blade, front spoiler, rear diffuser, rear roof spoiler and side skirts	Various	£843.48	£970.00

Transport and touring

Roof bar set . Provides a stable base for a variety of touring attachments and incorporates an anti-theft locking mechanism	Various	Please consult your Audi Centre for pricing	
Ski and snowboard holder . A lockable device for convenient transportation of up to 4 pairs of skis or 2 snowboards. Must be used in conjunction with the Roof bar set	4F9071129E	£67.83	£78.00
480l Ski and luggage box . Lockable and can be opened from both sides. Capacity approx. 480 litres. Must be used with the Roof bar set	4L0071175	£382.61	£440.00
Bicycle holder . Lockable holder that is manufactured from specially shaped plastic. Bicycle is secured via a steel-frame bracket. Must be used in conjunction with the Roof bar set	8E0071128A	£64.35	£74.00



18 x 7.5J '10-spoke' design alloy wheel



Front spoiler with Front blade and Side skirts



Ski and snowboard holder

Audi Centre-fitted accessories

Comfort and protection

	Part number	Basic RRP	Total RRP <small>inc. VAT</small>
Front rubber floor mats. Durable and easy-to-clean front rubber floor mats protect the vehicle interior from dirt and moisture	8P2061501041	£25.22	£29.00
Rear rubber floor mats. As above	8P0061511041	£20.87	£24.00

Communication and entertainment

DVD rear seat entertainment system. Roof mounted, flip-down rear seat entertainment system that has an integrated DVD/CD/MP3 player with an 8.5" premium-grade LCD display. Includes wireless infrared headphones and remote control. (Can only be fitted to A3 Sportback. Cannot be fitted to models with open sky sun roof)	ZGB8P0035596B	Please consult your Audi Centre for pricing	
Remote SIM access profile Bluetooth adaptor. An enhancement of the factory-fitted option "Mobile phone preparation – Low". It enables mobile phone handsets to connect to the phone preparation via Bluetooth Remote SIM Access Profile (rSAP). When handsets are connected, the adaptor enables the use of the external GSM car antenna in order to minimise GSM radiation in the car and handset battery consumption. The handset is put into standby mode so battery power drain is minimal. Once connected, the adaptor links to the handset automatically and details of up to four handsets can be saved. Only handsets with Bluetooth rSAP functionality are compatible with this adaptor	8P0051440	£254.78	£293.00

Safety and security

CobraTrak Q tracking device. Thatcham Category TQA rated tracking device that uses GPS and GSM technology to accurately pinpoint the location of a vehicle in up to 36 European countries in the event of theft. Price shown includes one year's subscription to the CobraTrak service	ZGB000054996A	Please consult your Audi Centre for pricing	
Road Angel Professional Connected. Gives you access to the UK's number-one safety camera and accident blackspot database as you drive. It is the world's first Connected safety camera and blackspot alert device which uses a built-in SIM card and GPRS/GSM technology to enable UK wide safety camera location updates every few minutes. The Road Angel Professional Connected is operated via remote control and has a full colour screen that can be customised to your taste. Includes a built-in rechargeable battery with up to 8 hours' battery life*	ZGB000052916A	£256.51	£294.99



Remote SIM access profile Bluetooth adaptor



CobraTrak



Road Angel Professional Connected

*Subsequent subscription charges apply, £4.99 per month payable by Direct Debit, minimum 12 months' contract is required. Includes free trial period of tracking function, additional subscription required for ongoing use. Please note: Road Angel products are only covered by a 1-year warranty. Road Angel warranty terms and conditions can be found at www.roadangel.co.uk.



Every Audi is intrinsically exclusive. It's the breathtaking design, the exceptional engineering, the Vorsprung durch Technik. But for that added element of exclusivity – that distinguishing look that sets you apart from the rest – you can specify your new A3 with options from Audi exclusive. Whether you want a unique, custom-mixed paint colour or seats in a combination of complementary shades, Audi exclusive will enable you to drive the car you've always imagined.

For more information on any of the options over the following pages or to view swatches, simply ask a member of staff at your local Audi Centre.



Upholstery

With Audi exclusive, you can choose between Fine Nappa leather and Alcantara, depending on the texture and flexibility you prefer in your car's upholstery. And once that's decided, you can specify your seats in an array of different colours shown to the left.

Choose just one all-over shade for each seat, or for a sportier look, customise each panel in two or more complementary colours from the distinctive Audi exclusive palette shown here. You can even choose the colour of the decorative stitching – to match or contrast with your chosen upholstery – from this varied collection. Whatever combination you decide upon, you're guaranteed to be extremely comfortable with the result.



*Not available in Alcantara.
 - = Not available • = Available

Order code		Standard	SE	Sport	S line	Black Edition	S3	Basic RRP	Total RRP ^{inc. VAT}
PYA/ S3G	Audi exclusive Fine Nappa leather seat upholstery with Alcantara door inserts and floor mats with leather piping	•	•	-	-	-	-	£2,508.70	£2,885.00
		-	-	•	-	-	-	£2,339.13	£2,690.00
		-	-	-	•	-	-	£2,082.61	£2,395.00
		-	-	-	-	-	•	£1,660.87	£1,910.00
PYC/ S3G	Audi exclusive Alcantara/Fine Nappa leather seat centre section with door inserts in Alcantara and floor mats with leather piping	•	•	-	-	-	-	£2,508.70	£2,885.00
		-	-	•	-	-	-	£2,339.13	£2,690.00
		-	-	-	•	-	-	£2,082.61	£2,395.00
YSI/ S3G	Audi exclusive extended leather, knee pads and door handles in exclusive leather	-	-	-	-	-	•	£678.26	£780.00
PS5	Bucket seats (front) in Audi exclusive leather. Includes first aid kit, through load facility. Not available in conjunction with electric lumbar support or storage pack. Please note this item deletes front side airbags and front seat ISOFIX preparation	-	-	-	-	-	•	£3,130.43	£3,600.00

Audi exclusive line

Audi exclusive is ultimately about choice – but if you’d rather leave some of the decisions in the capable hands of our designers, the expert team at quattro® GmbH have compiled Audi exclusive line, combining some of the most popular elements of the exclusive range in one sporty, beautifully coordinated package.

The package gives you:

- ▶ Sports seats in two-tone Fine Nappa leather, with black seat-side sections with coloured stitching and coloured seat-centre section in Crimson red, Silver or Cognac
- ▶ Black dashboard and carpets
- ▶ Black cloth headlining
- ▶ Door-trim inserts in black to match interior trim
- ▶ Audi exclusive door sill trims*
- ▶ Brushed aluminium inlays
- ▶ Floor mats in black with coloured piping (to match seat-centre section)
- ▶ 3-spoke leather steering wheel (S tronic with shift paddles)
- ▶ Steering wheel rim and gear lever gaiter with coloured stitching in matching colour to seat-centre section
- ▶ Head restraints with coloured stitching in matching colour to seat-centre section



Order code		Standard	SE	Sport	S line	Black Edition	S3	Basic RRP	Total RRP <small>inc. VAT</small>
WQK	Audi exclusive line package	-	-	•	-	-	-	£1,700.00	£1,955.00
WQI	Audi exclusive line package	-	-	-	•	•	-	£852.17	£980.00

*On S line models, S line door sills supersede exclusive line door sills.



Crimson red/Black (QY)



Silver/Black (QL)



Cognac/Black (QX)





Palace blue, pearl effect*



Morning dew, metallic*

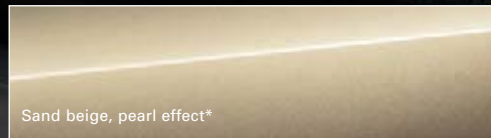

Sand beige, pearl effect*

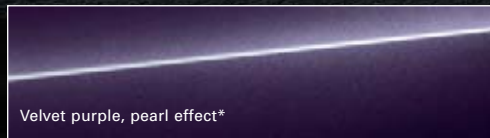

Velvet purple, pearl effect*



Oak green, metallic*

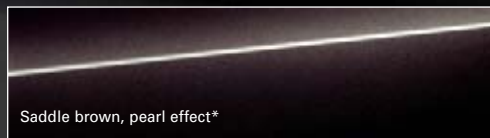

Saddle brown, pearl effect*

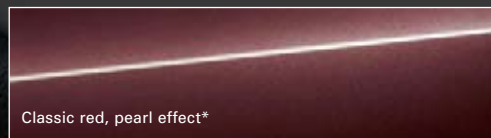

Classic red, pearl effect*

Or any other paint colour in the Audi range

Basic RRP	Total RRP ^{inc. VAT}
£1,447.83	£1,665.00

Paint

Everyone has a favourite colour. No matter what yours is, Audi exclusive provides a range of unique colours that have been designed to set your car apart. Choose from the swatches here, or specify any other paint colour in the Audi range – whether it's Jet blue from the Audi R8 or Alpine white from the original Audi quattro®. The choice is yours.



Customised paint

In a car made with Vorsprung durch Technik, there are no compromises. So if you have a particular colour in mind, we'll mix the exact metallic or pearl-effect shade you want – whether it's the blue of your favourite shirt or the wall colour in your sitting room.

Basic RRP	Total RRP ^{inc.} _{VAT}
£2,043.48	£2,350.00

Inlays

Inlays are the all-important ‘finishing touch’ that add flair and interest to the surfaces inside your car. So Audi exclusive have sourced a hugely varied range of materials from which to craft these elements – from Oak sepia to rich quilted maple wood. You can even customise your gear knob with one of the available woods, all of which are shown opposite.

Order code		Basic RRP	Total RRP <small>inc. VAT</small>
YTA/S3G	Inlays – door trim and gearshift gate surround*	£639.13	£735.00
YTD/YTG /S3G	Wooden gear knob (manual or S tronic*)	£204.35	£235.00

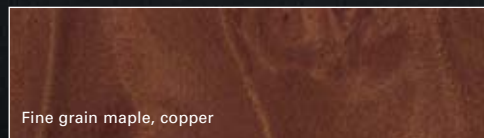

Fine grain maple, copper



Poplar, saffron

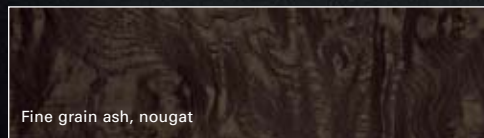

Fine grain ash, nougat

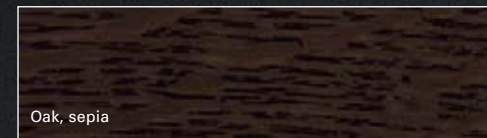

Oak, sepia

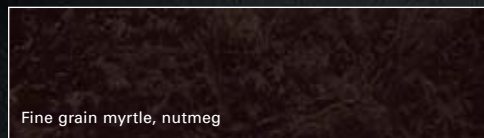

Fine grain myrtle, nutmeg



Quilted maple, gold

*Not available on S line and Black Edition models.

Steering wheels and controls pack

Our fingertips and palms contain more touch receptors than any other part of our body – so shouldn't the parts of our car we handle the most also be the most pleasing to touch? With this in mind, Audi exclusive enables you to customise the steering wheel of your choice in smooth, warm leather, in any of the colours shown on page 47. As with Audi exclusive seats, you even have free choice on the colour of the decorative stitching used. Choose a controls pack and you can extend this exclusive look and feel to your car's handbrake, gearknob and gaiter too.

Order code		Basic RRP	Total RRP <small>inc. VAT</small>
YRH/S3G	Audi exclusive leather steering wheel trim*	£300.00	£345.00
YRB/S3G	Audi exclusive leather controls pack comprising steering wheel, handbrake grip and gearshift gaiter*	£508.70	£585.00

*Not available on Black Edition models.

Technical data

A3

Petrol

Engine	Cylinder	Displacement, cubic cm (valves per cylinder)	Max. power ¹ , PS at rpm	Max. torque, Nm at rpm	Transmission	CO ₂ emissions ² , g/km	0-62mph acceleration, seconds	Top speed ³ , mph	ABI insurance group [†]
1.6	4-cylinder	1595 (2)	102/5600	148/3800	5-speed manual	162	11.8	115	7E [^]
1.6	4-cylinder	1595 (2)	102/5600	148/3800	7-speed S tronic	159	11.7	115	7E [^]
1.4 TFSI	4-cylinder	1390 (4)	125/5000	200/1500-4000	6-speed manual	132	9.4	126	11E*
1.4 TFSI	4-cylinder	1390 (4)	125/5000	200/1500-4000	7-speed S tronic	133	9.3	126	11E*
1.8 TFSI	4-cylinder	1798 (4)	160/5000-6200	250/1500-4200	6-speed manual	155	7.6	138	13E
1.8 TFSI	4-cylinder	1798 (4)	160/5000-6200	250/1500-4200	7-speed S tronic	153	7.5	138	13E
2.0 TFSI	4-cylinder	1984 (4)	200/5100-6000	280/1700-5000	6-speed manual	164	7.0	148	15E
2.0 TFSI	4-cylinder	1984 (4)	200/5100-6000	280/1700-5000	6-speed S tronic	166	6.8	148	15E
2.0 TFSI quattro [®]	4-cylinder	1984 (4)	200/5100-6000	280/1700-5000	6-speed S tronic	174	6.6	147	15E
S3 quattro [®]	4-cylinder	1984 (4)	265/6000	350/2500-5000	6-speed manual	198	5.7	155**	18E
S3 quattro [®]	4-cylinder	1984 (4)	265/6000	350/2500-5000	6-speed S tronic	193	5.5	155**	18E

[^]S line models=8E

*S line models=12E.

**Electronically limited.

[†]2.0 TFSI quattro[®] Black Edition Insurance groups to be confirmed.

¹The given value was obtained in accordance with the specified measurement procedure (the respective current version of the Directive 80/1269/EEC).

²The given values were calculated in accordance with the specified measurement procedure (the respective current version of Directive 80/1268/EEC). This information does not relate to a single vehicle and does not comprise part of the offer but is merely intended for the purpose of comparison between the different vehicle types.

³Top speed is achieved in top gear.

Please note: The maximum power output figures are quoted in PS (or Pferdestärke, which is the metric equivalent of brake horsepower). To convert to brake horsepower, divide the PS figure by 1.0139.

Weights, kg			Max. trailer load ⁵ , kg			Volumes		Fuel tank capacity approx, litres	Fuel consumption, mpg (l/100km)		
Unladen weight ⁴	Gross weight limit	Roof load limit/nose weight	unbraked	with 12% gradient	with 8% gradient	Luggage compartment capacity, litres rear seats upright	rear seats folded		Urban	Extra Urban	Combined
1185	1745	75	630	1200	1500	350	1080	55	29.8 (9.5)	53.3 (5.3)	41.5 (6.8)
1220	1780	75	640	1200	1500	350	1080	55	30.1 (9.4)	55.4 (5.1)	42.2 (6.7)
1255	1815	75	660	1200	1500	350	1080	55	38.7 (7.3)	58.9 (4.8)	49.6 (5.7)
1270	1830	75	670	1200	1500	350	1080	55	38.2 (7.4)	60.1 (4.7)	49.6 (5.7)
1280	1840	75	670	1400	1700	350	1080	55	31.0 (9.1)	53.3 (5.3)	42.2 (6.7)
1295	1855	75	680	1400	1700	350	1080	55	31.7 (8.9)	53.3 (5.3)	42.8 (6.6)
1295	1855	75	680	1500	1800	350	1080	55	28.8 (9.8)	51.4 (5.5)	39.8 (7.1)
1330	1890	75	700	1500	1800	350	1080	55	28.8 (9.8)	49.6 (5.7)	39.2 (7.2)
1415	1975	75	740	1500	1800	281	1011	60	28.5 (9.9)	46.3 (6.1)	37.7 (7.5)
1455	2015	75	-	-	-	281	1011	60	23.9 (11.8)	42.8 (6.6)	33.2 (8.5)
1475	2035	75	-	-	-	281	1011	60	25.4 (11.1)	42.2 (6.7)	34.0 (8.3)

⁴Vehicle's unladen weight without driver (calculated in accordance with the current version of Directive 80/1268/EEC). The fitting of additional equipment may increase the vehicle's unladen weight and drag coefficient, whereupon the potential carrying capacity and top speed will be correspondingly reduced.

⁵The engine's power output always goes down with increasing altitude. At 1000m above sea level, and for every additional 1000m, deduct 10% from the weight of the outfit (trailer load limit + gross weight of the towing vehicle).

Technical data

A3

Diesel

Engine	Cylinder	Displacement, cubic cm (valves per cylinder)	Max. power ¹ , PS at rpm	Max. torque, Nm at rpm	Transmission	CO ₂ emissions ² , g/km	0-62mph acceleration, seconds	Top speed ³ , mph	ABI insurance group ⁴
1.9 TDIe	4-cylinder	1896 (2)	105/4000	250/1900	5-speed manual	119	11.4	120	10E
2.0 TDI	4-cylinder	1968 (4)	140/4200	320/1750-2500	6-speed manual	134	9.4	129	11E
2.0 TDI	4-cylinder	1968 (4)	140/4200	320/1750-2500	6-speed S tronic	143	8.9	129	11E
2.0 TDI	4-cylinder	1968 (4)	170/4200	350/1750-2500	6-speed manual	139	8.0	139	14E
2.0 TDI	4-cylinder	1968 (4)	170/4200	350/1750-2500	6-speed S tronic	147	7.6	139	14E
2.0 TDI quattro®	4-cylinder	1968 (4)	170/4200	350/1750-2500	6-speed manual	148	7.8	138	14E

⁴2.0 TDI quattro® Black Edition Insurance groups to be confirmed.

All diesel engines are fitted with a Diesel Particulate Filter.

¹The given value was obtained in accordance with the specified measurement procedure (the respective current version of the Directive 80/1269/EEC).

²The given values were calculated in accordance with the specified measurement procedure (the respective current version of Directive 80/1268/EEC). This information does not relate to a single vehicle and does not comprise part of the offer but is merely intended for the purpose of comparison between the different vehicle types.

³Top speed is achieved in top gear.

Please note: The maximum power output figures are quoted in PS (or Pferdestärke, which is the metric equivalent of brake horsepower). To convert to brake horsepower, divide the PS figure by 1.0139.

Weights, kg			Max. trailer load ⁵ , kg			Luggage compartment capacity, litres		Fuel tank capacity approx, litres	Fuel consumption, mpg (l/100km)		
Unladen weight ⁴	Gross weight limit	Roof load limit/nose weight	unbraked	with 12% gradient	with 8% gradient	rear seats upright	rear seats folded		Urban	Extra Urban	Combined
1280	1840	75	–	–	–	350	1080	55	48.7 (5.8)	74.3 (3.8)	62.8 (4.5)
1320	1880	75	690	1400	1700	350	1080	55	42.2 (6.7)	67.3 (4.2)	55.4 (5.1)
1345	1905	75	710	1400	1700	350	1080	55	39.2 (7.2)	64.2 (4.4)	52.3 (5.4)
1335	1895	75	690	1400	1700	350	1080	55	40.9 (6.9)	67.3 (4.2)	54.3 (5.2)
1375	1935	75	710	1400	1700	350	1080	55	39.2 (7.2)	61.4 (4.6)	50.4 (5.6)
1425	1985	75	750	1600	1800	281	1011	60	39.2 (7.2)	60.1 (4.7)	50.4 (5.6)

⁴Vehicle's unladen weight without driver (calculated in accordance with the current version of Directive 80/1268/EEC). The fitting of additional equipment may increase the vehicle's unladen weight and drag coefficient, whereupon the potential carrying capacity and top speed will be correspondingly reduced.

⁵The engine's power output always goes down with increasing altitude. At 1000m above sea level, and for every additional 1000m, deduct 10% from the weight of the outfit (trailer load limit + gross weight of the towing vehicle).

Technical data

A3 Sportback

Petrol

Engine	Cylinder	Displacement, cubic cm (valves per cylinder)	Max. power ¹ , PS at rpm	Max. torque, Nm at rpm	Transmission	CO ₂ emissions ² , g/km	0-62mph acceleration, seconds	Top speed ³ , mph	ABI insurance ⁴ group
1.6	4-cylinder	1595 (2)	102/5600	148/3800	5-speed manual	164	12.1	115	7E ^A
1.6	4-cylinder	1595 (2)	102/5600	148/3800	7-speed S tronic	159	12.0	115	7E ^A
1.4 TFSI	4-cylinder	1390 (4)	125/5000	200/1500-4000	6-speed manual	134	9.4	126	11E*
1.4 TFSI	4-cylinder	1390 (4)	125/5000	200/1500-4000	7-speed S tronic	137	9.3	126	11E*
1.8 TFSI	4-cylinder	1798 (4)	160/5000-6200	250/1500-4200	6-speed manual	157	7.8	138	13E
1.8 TFSI	4-cylinder	1798 (4)	160/5000-6200	250/1500-4200	7-speed S tronic	154	7.7	138	13E
2.0 TFSI	4-cylinder	1984 (4)	200/5100-6000	280/1700-5000	6-speed manual	167	7.1	148	15E
2.0 TFSI	4-cylinder	1984 (4)	200/5100-6000	280/1700-5000	6-speed S tronic	166	6.9	148	15E
2.0 TFSI quattro [®]	4-cylinder	1984 (4)	200/5100-6000	280/1700-5000	6-speed S tronic	176	6.7	147	15E
S3 quattro [®]	4-cylinder	1984 (4)	265/6000	350/2500-5000	6-speed manual	199	5.8	155**	18E
S3 quattro [®]	4-cylinder	1984 (4)	265/6000	350/2500-5000	6-speed S tronic	195	5.6	155**	18E

^AS line models=8E

^SS line models=12E.

**Electronically limited.

¹2.0 TFSI quattro[®] Black Edition Insurance groups to be confirmed.

¹The given value was obtained in accordance with the specified measurement procedure (the respective current version of the Directive 80/1269/EEC).

²The given values were calculated in accordance with the specified measurement procedure (the respective current version of Directive 80/1268/EEC). This information does not relate to a single vehicle and does not comprise part of the offer but is merely intended for the purpose of comparison between the different vehicle types.

³Top speed is achieved in top gear.

Please note: The maximum power output figures are quoted in PS (or Pferdestärke, which is the metric equivalent of brake horsepower). To convert to brake horsepower, divide the PS figure by 1.0139.

Weights, kg			Max. trailer load ⁵ , kg			Volumes		Fuel tank capacity approx, litres	Fuel consumption, mpg (l/100km)		
Unladen weight ⁴	Gross weight limit	Roof load limit/nose weight	unbraked	with 12% gradient	with 8% gradient	Luggage compartment capacity, litres rear seats upright	rear seats folded		Urban	Extra Urban	Combined
1225	1785	75	650	1200	1500	370	1100	55	29.7 (9.5)	52.3 (5.4)	40.9 (6.9)
1260	1820	75	660	1200	1500	370	1100	55	30.1 (9.4)	55.4 (5.1)	42.2 (6.7)
1295	1855	75	680	1200	1500	370	1100	55	38.7 (7.3)	57.6 (4.9)	48.7 (5.8)
1310	1870	75	690	1200	1500	370	1100	55	37.2 (7.6)	57.6 (4.9)	47.9 (5.9)
1320	1880	75	690	1400	1700	370	1100	55	31.0 (9.1)	52.3 (5.4)	42.2 (6.7)
1335	1895	75	700	1400	1700	370	1100	55	31.4 (9.0)	53.3 (5.3)	42.8 (6.6)
1335	1895	75	700	1500	1800	370	1100	55	28.5 (9.9)	50.4 (5.6)	39.2 (7.2)
1370	1930	75	720	1500	1800	370	1100	55	28.8 (9.8)	49.6 (5.7)	39.2 (7.2)
1455	2015	75	750	1500	1800	302	1032	60	28.2 (10.0)	45.6 (6.2)	37.2 (7.6)
1495	2055	75	-	-	-	302	1032	60	23.9 (11.8)	42.2 (6.7)	33.2 (8.5)
1515	2075	75	-	-	-	302	1032	60	25.2 (11.2)	41.5 (6.8)	33.6 (8.4)

⁴Vehicle's unladen weight without driver (calculated in accordance with the current version of Directive 80/1268/EEC). The fitting of additional equipment may increase the vehicle's unladen weight and drag coefficient, whereupon the potential carrying capacity and top speed will be correspondingly reduced.

⁵The engine's power output always goes down with increasing altitude. At 1000m above sea level, and for every additional 1000m, deduct 10% from the weight of the outfit (trailer load limit + gross weight of the towing vehicle).

Technical data

A3 Sportback

Diesel

Engine	Cylinder	Displacement, cubic cm (valves per cylinder)	Max. power ¹ , PS at rpm	Max. torque, Nm at rpm	Transmission	CO ₂ emissions ² , g/km	0-62mph acceleration, seconds	Top speed ³ , mph	ABI insurance ⁴ group
1.9 TDIe	4-cylinder	1896 (2)	105/4000	250/1900	5-speed manual	119	11.7	120	10E
2.0 TDI	4-cylinder	1968 (4)	140/4200	320/1750-2500	6-speed manual	134	9.6	129	11E
2.0 TDI	4-cylinder	1968 (4)	140/4200	320/1750-2500	6-speed S tronic	143	9.1	129	11E
2.0 TDI	4-cylinder	1968 (4)	170/4200	350/1750-2500	6-speed manual	139	8.1	139	14E
2.0 TDI	4-cylinder	1968 (4)	170/4200	350/1750-2500	6-speed S tronic	149	7.7	139	14E
2.0 TDI quattro®	4-cylinder	1968 (4)	170/4200	350/1750-2500	6-speed manual	148	7.9	138	14E

¹2.0 TDI 170PS quattro® Black Edition Insurance groups to be confirmed.

All diesel engines are fitted with a Diesel Particulate Filter.

²The given value was obtained in accordance with the specified measurement procedure (the respective current version of the Directive 80/1269/EEC).

³The given values were calculated in accordance with the specified measurement procedure (the respective current version of Directive 80/1268/EEC). This information does not relate to a single vehicle and does not comprise part of the offer but is merely intended for the purpose of comparison between the different vehicle types.

⁴Top speed is achieved in top gear.

Please note: The maximum power output figures are quoted in PS (or Pferdestärke, which is the metric equivalent of brake horsepower). To convert to brake horsepower, divide the PS figure by 1.0139.

Weights, kg			Max. trailer load ⁵ , kg			Luggage compartment capacity, litres		Fuel tank capacity approx, litres	Fuel consumption, mpg (l/100km)		
Unladen weight ⁴	Gross weight limit	Roof load limit/nose weight	unbraked	with 12% gradient	with 8% gradient	rear seats upright	rear seats folded		Urban	Extra Urban	Combined
1320	1880	75	–	–	–	370	1100	55	48.7 (5.8)	74.3 (3.8)	62.8 (4.5)
1360	1920	75	710	1400	1700	370	1100	55	42.8 (6.6)	65.7 (4.3)	55.4 (5.1)
1385	1945	75	730	1400	1700	370	1100	55	39.2 (7.2)	64.2 (4.4)	52.3 (5.4)
1375	1935	75	710	1400	1700	370	1100	55	40.9 (6.9)	67.3 (4.2)	54.3 (5.2)
1395	1955	75	730	1400	1700	370	1100	55	38.2 (7.4)	60.1 (4.7)	49.6 (5.7)
1465	2025	75	750	1600	1800	302	1032	60	39.2 (7.2)	60.1 (4.7)	50.4 (5.6)

⁴Vehicle's unladen weight without driver (calculated in accordance with the current version of Directive 80/1268/EEC). The fitting of additional equipment may increase the vehicle's unladen weight and drag coefficient, whereupon the potential carrying capacity and top speed will be correspondingly reduced.

⁵The engine's power output always goes down with increasing altitude. At 1000m above sea level, and for every additional 1000m, deduct 10% from the weight of the outfit (trailer load limit + gross weight of the towing vehicle).

Dimensions

A3

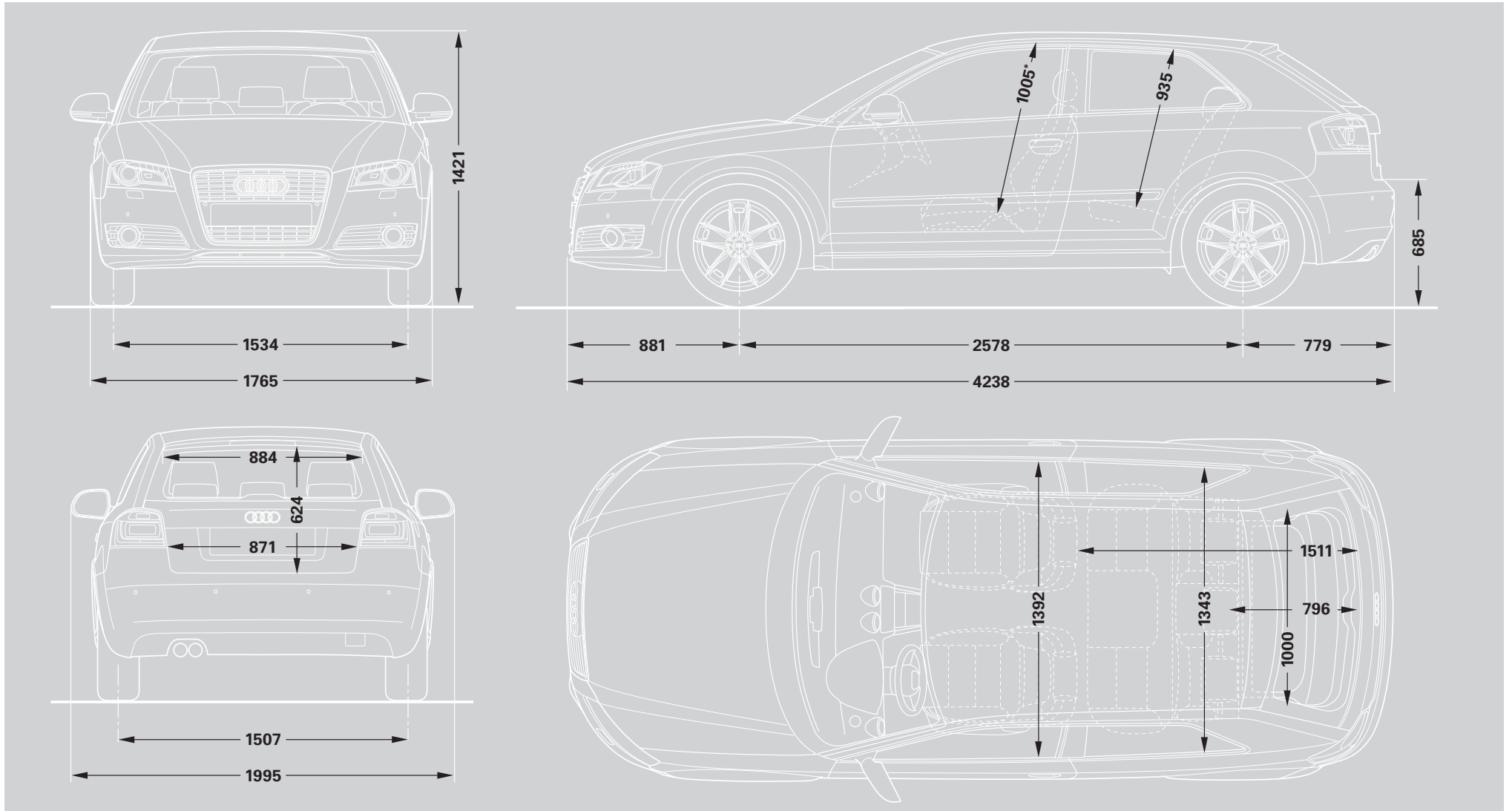

Dimensions

A3 Sportback

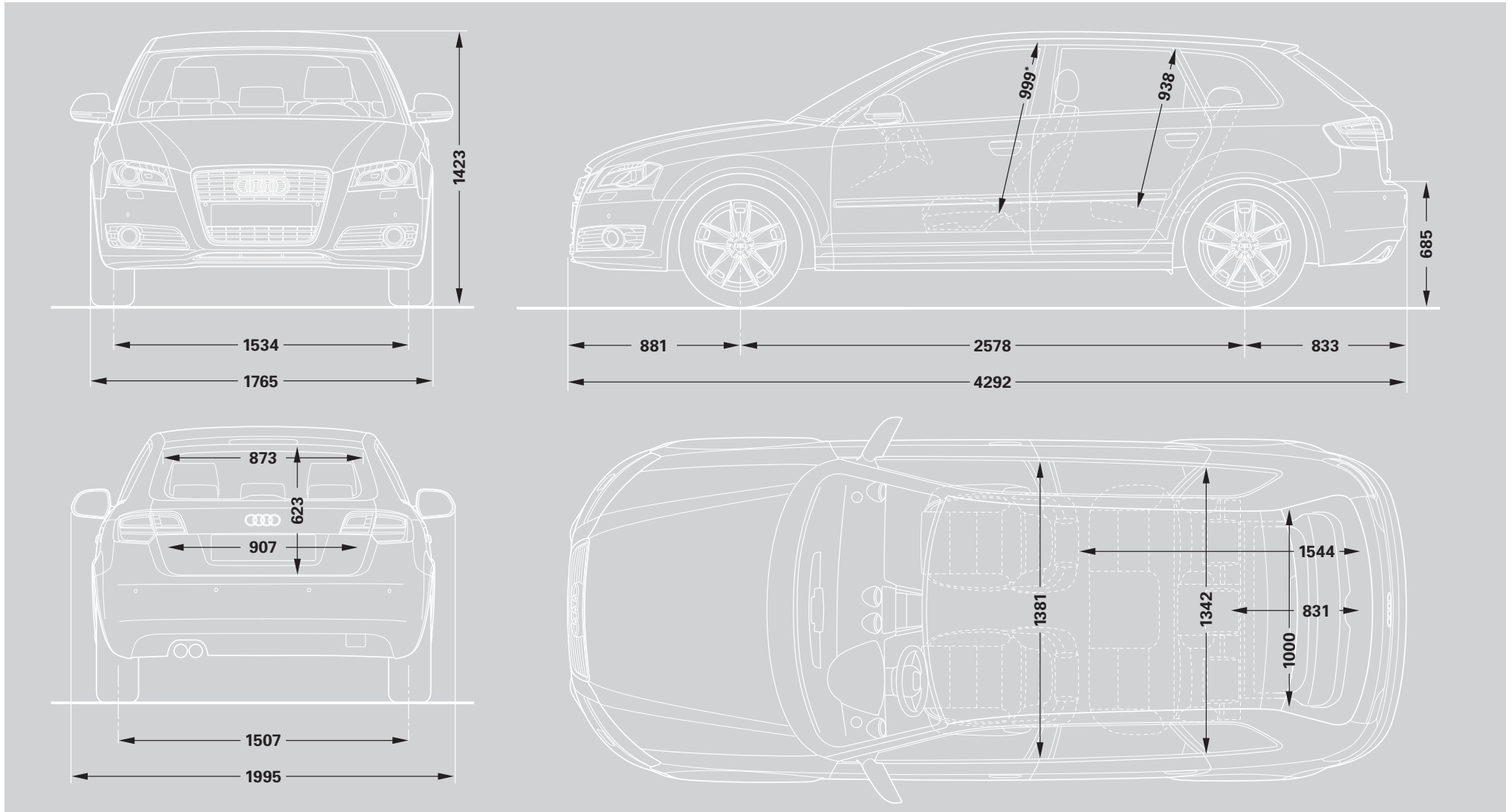

Dimensions were measured with vehicle at unladen weight.
Turning circle approx 10.7m.

Dimensions in millimetres.
*Maximum headroom.

Dimensions

S3

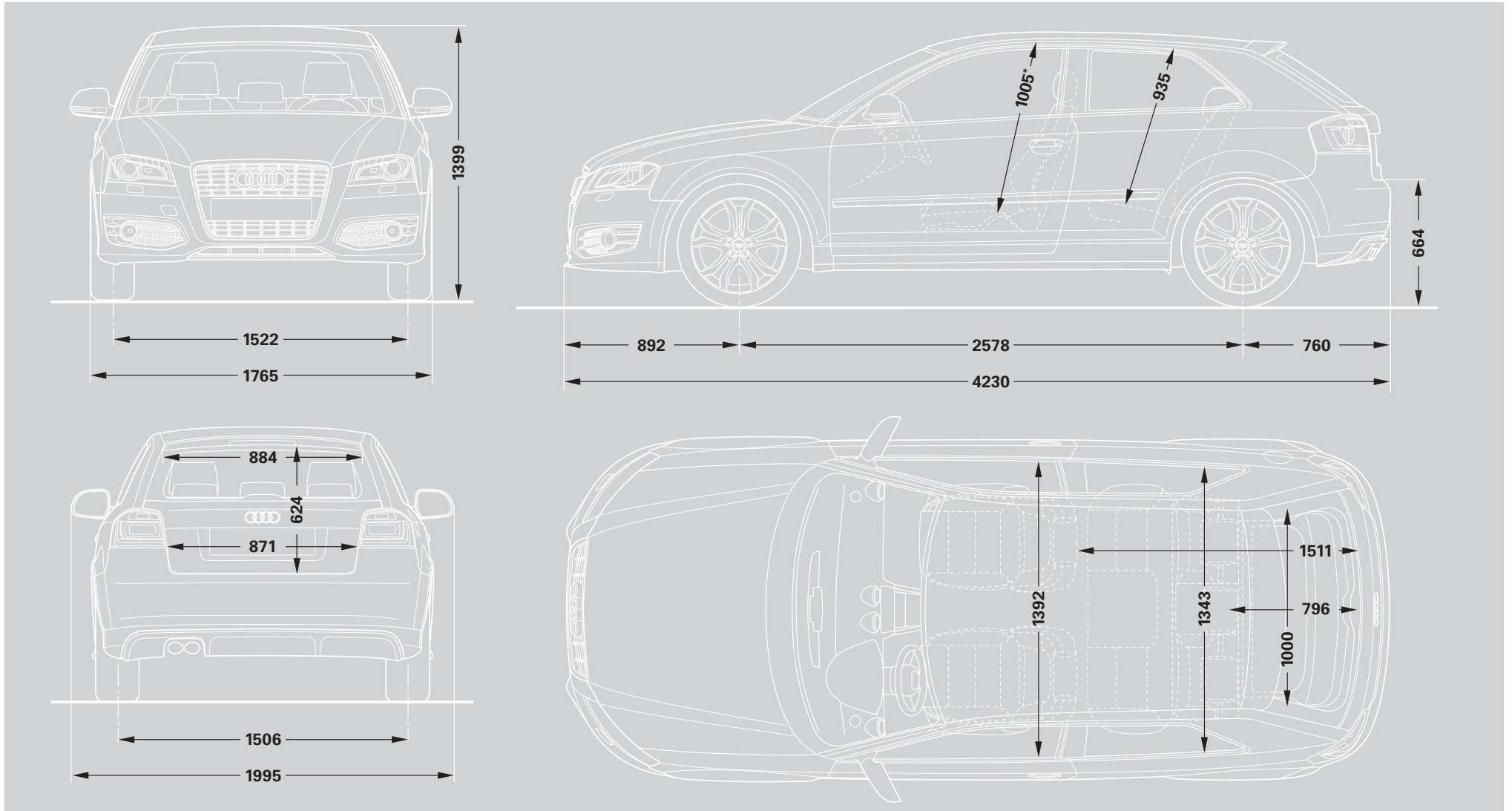

Dimensions

S3 Sportback

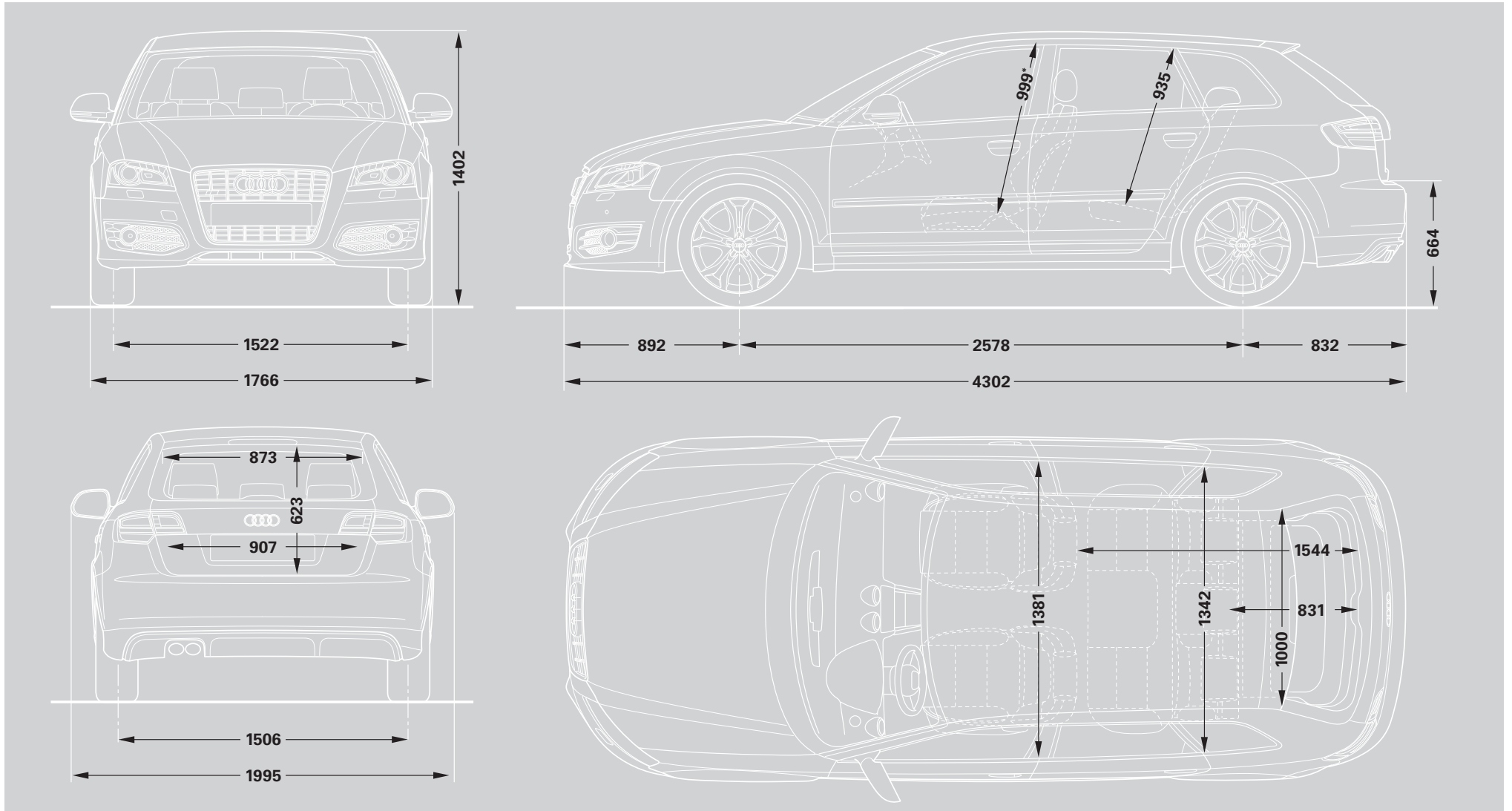

Dimensions were measured with vehicle at unladen weight.
Turning circle approx 10.7m.

Dimensions in millimetres.
*Maximum headroom.

Additional information

CO₂ data and information

CO₂ emissions-based Vehicle Excise Duty

Vehicle Excise Duty (Road Fund Licence) is based upon the amount of Carbon Dioxide (CO₂) a vehicle emits, measured in grams per kilometre (g/km). The DVLA has created seven categories:

Petrol and Diesel engines	
A – up to 100g/km	£0.00
B – 101 to 120g/km	£35.00
C – 121 to 150g/km	£120.00
D – 151 to 165g/km	£145.00
E – 166 to 185g/km	£170.00
F – 186 to 225g/km	£210.00
G – over 225g/km	£400.00

Audi Service

Servicing tailored to your needs

Regular servicing is key to safeguarding your Audi's performance and a full Audi service history could help you preserve the future re-sale value. To make servicing easy, the Audi Service Schedules have been designed to work with your individual driving style and vehicle.

There are two schedules available and your Audi Centre will advise which schedule is most suited to your needs. The conventional fixed Audi Inspection Service schedule

Inspection Service Schedule

Vehicle usage:	
Mileage	Less than 10,000* miles per annum
Type of journey	Mainly city/town centre driving. Short journeys
Conditions	Frequent cold starts. High engine loading – e.g. frequent hill climbs, vehicle fully loaded, towing
Driving style	Uneconomical – e.g. heavy acceleration, heavy braking, constant changes in speed, constant use of high revs, 'sporty' driving

Fixed Audi Inspection Service Intervals:	
Oil-change Service	Fixed to every 10,000* miles/1 year
Inspection Service	Fixed to every 20,000* miles/3 years, then every 20,000* miles/2 years thereafter

has fixed intervals for the Oil Change and Inspection Service that are based on time and distance, whichever comes first. With the Audi LongLife Service schedule, sensors take account of driving style and conditions in which the vehicle is used to indicate when the Oil Change Service is required. Oil Change Service intervals are therefore variable and are conveniently indicated via the on-board service interval display.

LongLife Service Regime

Vehicle usage:	
Mileage	More than 30 miles per day
Type of journey	Motorway and main road driving. Mainly longer distance journeys. Constant speeds
Conditions	Normal engine loading – e.g. with little or no towing, with little or no hill climbs. Normal vehicle loading
Driving style	Moderate acceleration, moderate braking, engine revs mainly below 3,000

Audi LongLife Service Intervals:	
Oil-change Service	Variable to a maximum of every 20,000* miles/2 years
Inspection Service	Fixed to every 20,000* miles/3 years, then every 20,000* miles/2 years thereafter

*As indicated by the service interval display. Mileages are approximate as the Service Indicator system uses kilometres as its distance measurement.

Service by Design

At Audi, we believe our customers can expect excellent service each and every time they make contact with us. To ensure that this happens, we have agreed a set of service standards with our Audi Centre network that governs the way they do business with you. These standards apply to both Sales and Aftersales, and we actively monitor our Centres to ensure that you receive the highest level of customer service. These service standards will ensure a consistent, stress-free experience whenever you are in contact with anyone representing the Audi brand.

Every Audi Centre will be open during the following hours:

Sales: 9am–6pm Monday to Friday
9am–5pm Saturday

Service: 8am–6pm Monday to Friday
8.30am–1pm Saturday

Sunday opening at local discretion.

Test drives

Whilst we cannot always have the desired demonstrator car ready immediately, we will confirm arrangements for a test drive within two working days (subject to status).

New Car delivery

Once we have confirmed a delivery date with you, we will keep you informed of progress. In the unlikely event of a delay, we will provide you with a courtesy car to minimise inconvenience and keep you mobile.

Delivery to any location within the UK

To maximise your Audi experience right from the first day of ownership, we will deliver your car to your preferred location – whether that's home or your place of work (subject to reasonable notice).

Attention to every detail

Your ownership experience starts with half a tank of fuel.

Quotation response

We will answer any quotation request within 1 working day.

Training

We run a continuous training development programme for all our staff so that we consistently deliver a high-quality, professional service.

Formal complaints procedure

We have a complaints procedure designed to ensure any negative issue you raise with us is dealt with properly.

Courtesy cars

When your car is off the road, perhaps due to a scheduled service or MOT, we will offer you an Audi Courtesy Vehicle until yours is ready. We'll even collect from and deliver to your chosen location, keeping hassle to an absolute minimum.

Service bookings

If you do not require a courtesy car, we will service your Audi within a maximum of 5 working days.

If you do choose to take a courtesy car, we will promise to service your vehicle within a maximum of 10 working days.

Cleaning

When your car comes to our workshop, we will wash and vacuum it at no extra cost.

No hidden charges

You will be consulted before we carry out any necessary work on your vehicle, and anything charged for will be itemised on your bill. No extra work will be undertaken without your permission.

A personal service

All work will be done by a named Audi Technician, to whom you can personally direct questions or requests should you need to.

Environmental commitment

We promise to dispose of all non-biodegradable materials from your vehicle in a responsible manner.



Pricing information

Pricing

Prices and specifications given are correct at the time of printing. Always check details with your Audi Centre, as Audi policies are continually developing. We reserve the right to change prices or specifications at any time.

All prices are subject to VAT, currently charged at 15%.

Delivery charges and number plates are not included in the vehicle price.

Delivery charge	£471.30
Number plate	£20.00
VAT	£73.70
Total	£565.00

Audi Roadside Assistance

Your new car comes complete with complimentary roadside assistance and recovery across the UK provided by RAC Motoring Services. Also included is roadside assistance throughout Europe, managed by RAC Motoring Services.

Audi Customer Care

Every new Audi benefits from the comprehensive Audi Customer Care Package, which comprises:

- ▶ A 3-year Audi warranty, which covers you for unlimited mileage in the first 2 years of ownership, with a full mechanical and electrical warranty which covers you for up to 60,000 miles in the 3rd year
- ▶ A 3-year paint warranty
- ▶ A 12-year anti-corrosion warranty
- ▶ Up to 3 years' UK roadside assistance and recovery

This package, together with Audi variable Service intervals, offers a combination unmatched by any other major manufacturer.

Contact your Audi Centre for full details.

Audi Tax-Free Sales

If you are entitled to purchase a vehicle free of VAT, normally through Military or Diplomatic privilege, please contact your local Audi Centre for full details.

Should you have any difficulty obtaining the information you require, please call Freephone 0800 585878.

Audi Finance

Audi Finance specialise in providing funding solutions for Audi drivers. Whether your Audi is for private or business use, there are a range of funding options to choose from.

Below is the full range of finance products.

- ▶ Solutions – a Personal Contract Plan
- ▶ Hire purchase
- ▶ Lease purchase
- ▶ Finance lease
- ▶ Contract hire

With all products, you can choose a fixed-cost maintenance plan designed to help you budget accurately.

No matter what Audi model you choose, your local Audi Centre can provide you with a personalised quote which could fit your budget and motoring needs.

Audi Finance is a trading name of Volkswagen Financial Services (UK) Limited. An offer of finance depends on certain conditions. Available to people over 18 in the UK only.

Audi Insurance

Competitive comprehensive motor insurance designed specially for Audi drivers. All new Audi models come with complimentary seven-day cover upon request – we'll email a cover note directly to your Audi Centre, enabling them to tax your car easily. This way, you can drive straight out of the showroom. Taking out an annual policy is easy and can begin as soon as your free seven-day cover expires.

For more information, contact your local Audi Centre. Alternatively, call 0800 051 3146 for a quote and to receive 7 days' complimentary cover for your new Audi.

Audi Insurance is underwritten and administered by Zurich Insurance Company.

Notes

Notes

Audi UK
Customer Services
Selectapost 29
Sheffield
S97 3FG
0800 699888
www.audi.co.uk

Specifications and prices subject
to change without notice.

© Audi (UK)

Printed in the UK
Edition 3.1. 04/09
2010 Model Year



Mixed Sources
Product group from well-managed
forests and other controlled sources

Cert no. TT-COC-002327
www.fsc.org
© 1996 Forest Stewardship Council