



The new Audi A4, A4 allroad and S4 range
Pricing and Specification Guide
Valid from April 2009



A User's Guide

This guide has been designed to help you tailor and price your chosen A4 model quickly and logically. At the back of this guide, you will also find information on CO2 emissions-based taxation and the other services offered by Audi, including Finance and Insurance.

If you wish, you can also go to audi.co.uk and configure your A4 online.

From the website, you can also access the Audi Channel player and see your potential new car in action on the following programmes:

Drivetime

www.audi.co.uk/A4drivetime

www.audi.co.uk/S4Avantdrivetime

Your Audi

www.audi.co.uk/A4youraudi

Alternatively, tune into the Audi Channel at any time on Sky Guide No. 884 to see a whole range of programmes about the Audi range and our motorsport achievements.



Table of content

	Page number
Introduction	
The new A4	
Engines and quattro®	6
Model details and prices	
Standard models	8
SE models	10
Executive SE models	12
S line models	14
Executive S line models	16
A4 allroad models	18
S4 quattro® models	20
Transmission	24
Colour and upholstery	
Paint finishes	28
Upholstery options	32
Colour and trim guide	42
Inlays	46
Options	
Wheels, tyres and suspension	50
Audio and communication	52
Seats	54
Safety and security	55
Interior equipment	56
Exterior equipment/Steering wheels	57
Audi Centre-fitted accessories	58
Audi exclusive	
Audi exclusive options	60
Technical details	
Technical data	66
Dimensions	72
Additional information	78

The new A4

With its innovative technologies and modern, pioneering design, the new Audi A4 is set to completely redefine your driving experience. Sporty exterior styling and exceptional interior refinement ensure that it creates a long-lasting impression of style and sophistication, which is reinforced when you start to discover the exclusive features that lie beneath its sculpted bodywork.

The Audi drive select system provides agility and control, while retaining directional stability and precise steering in difficult, high-speed driving conditions. What's more, Audi drive select can be tuned by each individual, ensuring a drive that's perfectly customised for your needs. But that's not all. The climate controlled seats add even more comfort, while Audi side assist and Audi lane assist guarantee a safer, more satisfying journey.

In short, the new Audi A4 incorporates the ideal combination of cutting-edge design and advanced technologies, allowing it to deliver one of the most balanced, rewarding driving experiences in the industry. From its sporty appearance to its refined interior features, each aspect has been expertly developed to produce a remarkable vehicle that raises the benchmark for design and driving dynamics.





Engines

Petrol

All A4 petrol engines feature FSI® direct-injection – a unique Audi technology originally developed for the Le Mans 24-hour endurance race to deliver increased power and torque as well as enhanced fuel efficiency. The way it does this is, in theory, very simple. Precisely the right amount of fuel and air are injected directly into the combustion chambers, enabling the engine to ‘breathe’ more easily. At the same time, electronics monitor the engine load and adjust the injection process. The result – reduced heat-loss and increased output, with around a 15% reduction in fuel consumption and significantly lower exhaust emissions. Ideal for the buyer who wants a sporty, exhilarating drive without the drawbacks of excessive fuel costs or high CO₂ emissions.

Diesel

All diesel engines from Audi are known as TDI®. This impressive technology was originally pioneered by Audi in 1989, marking a departure from the noisy, fuel-thirsty diesel engines of the past. Like its FSI petrol counterpart, the TDI® diesel engine is designed for power, performance, low fuel consumption and reduced CO₂ emissions.

All A4 TDI® engines are based on the common rail system. Here, fuel is stored and kept at constant pressures of up to 1,600 bar, ready to feed a series of highly accurate piezo injectors, which control the rate and point of injection.

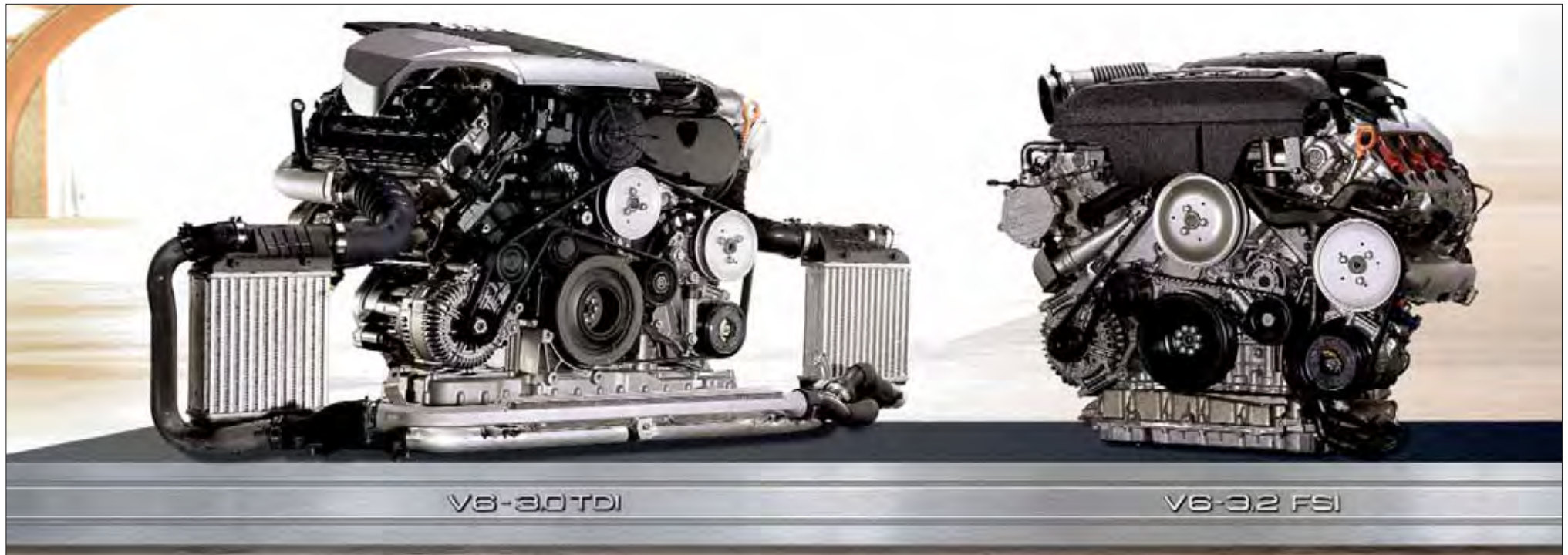

V8-3.0 TDI

V8-3.2 FSI

quattro®

Permanent all-wheel-drive

It's the technology that has given Audi the edge on the racetrack ever since it was first introduced over 25 years ago – a technology that delivers ultimate control whilst enhancing the sporty characteristics which make the A4 so thrilling to drive. It's called quattro® permanent all-wheel-drive. The principle is simple: in the same way that four brakes ensure better deceleration, four permanently-driven wheels deliver better acceleration and road-holding, pushing or pulling the car as needed,

for a driving experience that's both dynamic and safe. In the A4 asymmetric dynamic torque distribution continuously distributes drive power between the front and rear axles depending on weather conditions, road surface and gradient, which increases flexibility for an enhanced, sportier drive.



Standard model equipment

All A4 models have the following items of standard equipment:

Engine

Automatic start/stop function for greater fuel and CO₂ efficiency. Comprising;

- Recuperation for optimal energy utilisation
- Energy saving tips feature in Driver's Information System; including gearshift indicator (only available on the 2.0 TDI/2.0 TFSI manual engines)

Wheels, tyres and suspension

16 x 7.5J '7-arm' design alloy wheels with 225/55 R16 tyres and locking wheel bolts

Space-saver spare wheel

Audio and communication

Audi Chorus audio system – single CD player with 6.5" monochrome display

6 loudspeakers (80 Watts)

Seats

Cosinus cloth seats with manual height adjustment

Split-folding rear seats

Safety and security

ESP

First aid kit

Front and rear fog lights

Front and rear ISOFIX seats with front passenger airbag de-activation switch

Front side airbags

Headlight range adjustment

Thatcham category 1 alarm and immobiliser

Toolkit and car jack

Warning triangle

Interior equipment

1-zone climate control

12V power socket in boot

4-spoke leather steering wheel

Door sill trims in Aluminium optic

Driver's Information System (DIS)

Electric front and rear windows

Electromechanical parking brake

Front and rear floor mats

Intelligent key

Micrometallic inlays

Rear armrest

Steering column adjustment for rake and reach

Servotronic speed-related power-assisted steering

Exterior equipment

Auto-opening boot lid (Saloon models only)

Exterior mirrors – electrically operated and heated

Front grille – Black gloss on 3.0 TDI and 3.2 FSI, Stone grey on all others

Halogen daytime running lights

Roof rails in bright finish (Avant models only)

Exhaust pipes – 4-cylinder models have two exhaust pipes on the left hand side. 6-cylinder models and the 2.0 TFSI Avant model have one exhaust pipe on each side

Tow bar preparation (allows easier retro-fitting of tow bar)



16 x 7.5J '7-arm' design alloy wheels

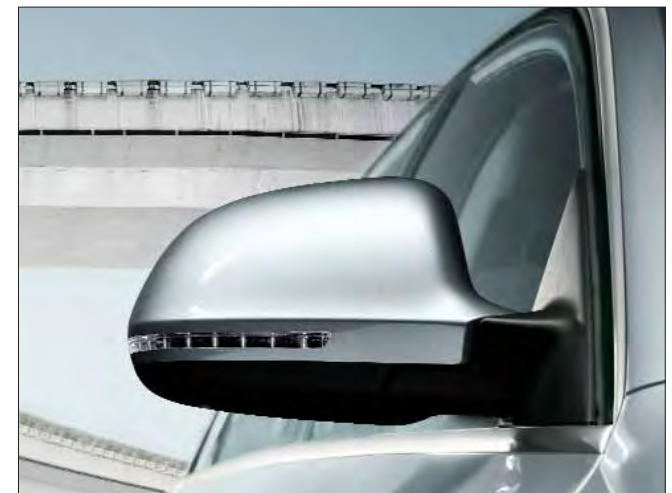

Exterior mirrors – electrically operated and heated

A4 Standard model prices

Petrol – Saloon

Engines	Power	Transmission	Basic RRP	Total RRP ^{inc. VAT}	Recommended OTR
1.8 TFSI	120PS	6-speed manual	£17,147.83	£19,720.00	£20,485.00

Petrol – Avant

Engines	Power	Transmission	Basic RRP	Total RRP ^{inc. VAT}	Recommended OTR
1.8 TFSI	120PS	6-speed manual	£18,147.83	£20,870.00	£21,660.00

Diesel – Saloon

Engines	Power	Transmission	Basic RRP	Total RRP ^{inc. VAT}	Recommended OTR
2.0 TDI	120PS	6-speed manual	£19,130.43	£22,000.00	£22,740.00
2.0 TDI	143PS	6-speed manual	£19,726.09	£22,685.00	£23,425.00

Diesel – Avant

Engines	Power	Transmission	Basic RRP	Total RRP ^{inc. VAT}	Recommended OTR
2.0 TDI	120PS	6-speed manual	£20,130.43	£23,150.00	£23,890.00
2.0 TDI	143PS	6-speed manual	£20,726.09	£23,835.00	£24,575.00



Recommended On-The-Road (OTR) retail prices include: delivery charge, half a tank of fuel, number plates at £565.00 (inc. VAT), Road Fund Licence (which may vary depending on model/transmission – see page 64 for details) and first registration fee at £55.00.

RRP – Recommended Retail Price.

SE model equipment

In addition to Standard model equipment:

Basic RRP	Total RRP ^{inc.} _{VAT}
£852.17	£980.00

Wheels, tyres and suspension

17 x 7.5J '7-arm' design alloy wheels with 225/50 R17 tyres and locking wheel bolts

Space-saver spare wheel

Audio and communication

Audi Concert radio. Single CD with MP3 compatibility, colour centre console screen, SD memory card reader and AUX-IN socket in centre console

Audi sound system speaker package, 10 speakers including subwoofer (180 Watts)

Interior equipment

4-spoke leather multi-function steering wheel

Auto-dimming rear view mirror

Aluminium Hologram Inlays

Deluxe 3-zone climate control with separate air distribution and digital display for driver and front passenger. System includes air-conditioning controls in the rear centre console for rear passenger compartment

Door sill trims in Aluminium optic

Driver's Information System (DIS) in colour

Front centre armrest including 12V power socket

Interior chrome package

Safety and security

Automatic headlight operation

Automatic windscreen wipers

Exterior equipment

Exterior aluminium package



Driver's Information System (DIS) in colour



17 x 7.5J '7-arm' design alloy wheels

SE model prices

Petrol – Saloon

Engines	Power	Transmission	Basic RRP	Total RRP ^{inc. VAT}	Recommended OTR
1.8 TFSI	120PS	6-speed manual	£18,000.00	£20,700.00	£21,465.00
1.8 TFSI	160PS	6-speed manual	£19,386.96	£22,295.00	£23,060.00
2.0 TFSI	211PS	6-speed manual	£21,430.43	£24,645.00	£25,385.00
2.0 TFSI quattro®	211PS	6-speed manual	£22,621.74	£26,015.00	£26,805.00
3.2 FSI	265PS	multitronic®	£25,430.43	£29,245.00	£30,075.00
3.2 FSI quattro®	265PS	6-speed manual	£25,386.96	£29,195.00	£30,025.00

Petrol – Avant

Engines	Power	Transmission	Basic RRP	Total RRP ^{inc. VAT}	Recommended OTR
1.8 TFSI	120PS	6-speed manual	£19,000.00	£21,850.00	£22,640.00
1.8 TFSI	160PS	6-speed manual	£20,386.96	£23,445.00	£24,235.00
2.0 TFSI	211PS	6-speed manual	£22,430.43	£25,795.00	£26,560.00
2.0 TFSI quattro®	211PS	6-speed manual	£23,621.74	£27,165.00	£27,955.00
3.2 FSI	265PS	multitronic®	£26,430.43	£30,395.00	£31,225.00
3.2 FSI quattro®	265PS	6-speed manual	£26,386.96	£30,345.00	£31,175.00

Diesel – Saloon

Engines	Power	Transmission	Basic RRP	Total RRP ^{inc. VAT}	Recommended OTR
2.0 TDI	120PS	6-speed manual	£19,982.61	£22,980.00	£23,720.00
2.0 TDI	143PS	6-speed manual	£20,578.26	£23,665.00	£24,405.00
2.0 TDI	170PS	6-speed manual	£21,430.43	£24,645.00	£25,385.00
2.0 TDI quattro®	170PS	6-speed manual	£22,621.74	£26,015.00	£26,755.00
2.7 TDI	190PS	multitronic®	£24,365.22	£28,020.00	£28,810.00
3.0 TDI quattro®	240PS	6-speed manual	£25,939.13	£29,830.00	£30,620.00

Diesel – Avant

Engines	Power	Transmission	Basic RRP	Total RRP ^{inc. VAT}	Recommended OTR
2.0 TDI	120PS	6-speed manual	£20,982.61	£24,130.00	£24,870.00
2.0 TDI	143PS	6-speed manual	£21,578.26	£24,815.00	£25,555.00
2.0 TDI	170PS	6-speed manual	£22,430.43	£25,795.00	£26,535.00
2.0 TDI quattro®	170PS	6-speed manual	£23,621.74	£27,165.00	£27,930.00
2.7 TDI	190PS	multitronic®	£25,365.22	£29,170.00	£29,960.00
3.0 TDI quattro®	240PS	6-speed manual	£26,939.13	£30,980.00	£31,770.00

Executive SE model equipment

In addition to SE model equipment:

Basic RRP	Total RRP <small>INC. VAT</small>
£552.17	£635.00
No charge upgrade from Standard to Executive SE on 2.0 TDI 143PS models*	

Wheels, tyres and suspension

17 x 8J '10-spoke' design alloy wheels with 245/45 R17 tyres

Audio and communication

Mobile telephone preparation – Low, in front centre armrest
Audi Symphony radio

Interior equipment

Cruise control



17 x 8J '10-spoke' design alloy wheels



Cruise control

Images are for general illustration purposes only and do not necessarily depict UK specification.

*On orders placed after 23 January 2009. Subject to availability.

Executive SE model prices

Petrol – Saloon

Engines	Power	Transmission	Basic RRP	Total RRP ^{inc. VAT}	Recommended OTR
1.8 TFSI	120PS	6-speed manual	£18,552.17	£21,335.00	£22,100.00
1.8 TFSI	160PS	6-speed manual	£19,939.13	£22,930.00	£23,695.00
2.0 TFSI	211PS	6-speed manual	£21,982.61	£25,280.00	£26,020.00
2.0 TFSI quattro®	211PS	6-speed manual	£23,173.91	£26,650.00	£27,440.00
3.2 FSI	265PS	multitronic®	£25,982.61	£29,880.00	£30,710.00
3.2 FSI quattro®	265PS	6-speed manual	£25,939.13	£29,830.00	£30,660.00

Petrol – Avant

Engines	Power	Transmission	Basic RRP	Total RRP ^{inc. VAT}	Recommended OTR
1.8 TFSI	120PS	6-speed manual	£19,552.17	£22,485.00	£23,275.00
1.8 TFSI	160PS	6-speed manual	£20,939.13	£24,080.00	£24,870.00
2.0 TFSI	211PS	6-speed manual	£22,982.61	£26,430.00	£27,195.00
2.0 TFSI quattro®	211PS	6-speed manual	£24,173.91	£27,800.00	£28,590.00
3.2 FSI	265PS	multitronic®	£26,982.61	£31,030.00	£31,860.00
3.2 FSI quattro®	265PS	6-speed manual	£26,939.13	£30,980.00	£31,810.00

Diesel – Saloon

Engines	Power	Transmission	Basic RRP	Total RRP ^{inc. VAT}	Recommended OTR
2.0 TDI	120PS	6-speed manual	£20,534.78	£23,615.00	£24,355.00
2.0 TDI	143PS	6-speed manual	£19,726.09	£22,685.00	£23,425.00
2.0 TDI	170PS	6-speed manual	£21,982.61	£25,280.00	£26,020.00
2.0 TDI quattro®	170PS	6-speed manual	£23,173.91	£26,650.00	£27,390.00
2.7 TDI	190PS	multitronic®	£24,917.39	£28,655.00	£29,445.00
3.0 TDI quattro®	240PS	6-speed manual	£26,491.30	£30,465.00	£31,255.00

Diesel – Avant

Engines	Power	Transmission	Basic RRP	Total RRP ^{inc. VAT}	Recommended OTR
2.0 TDI	120PS	6-speed manual	£21,534.78	£24,765.00	£25,505.00
2.0 TDI	143PS	6-speed manual	£20,726.09	£23,835.00	£24,575.00
2.0 TDI	170PS	6-speed manual	£22,982.61	£26,430.00	£27,170.00
2.0 TDI quattro®	170PS	6-speed manual	£24,173.91	£27,800.00	£28,565.00
2.7 TDI	190PS	multitronic®	£25,917.39	£29,805.00	£30,595.00
3.0 TDI quattro®	240PS	6-speed manual	£27,491.30	£31,615.00	£32,405.00

S line model equipment

In addition to SE model equipment:

Basic RRP	Total RRP <small>inc. VAT</small>
£2,126.09	£2,445.00

Wheels, tyres and suspension

18 x 8J '5-spoke' S line design alloy wheels with 245/40 R18 tyres

Sports suspension 20mm lower than Standard.
(S line suspension 30mm lower than Standard.
Available in lieu of Sports suspension at no charge)

Space-saver spare wheel

Interior equipment

3-spoke S line multi-function steering wheel (paddle shift for automatic models)

Black headlining

Matt-brushed aluminium inlays

Perforated leather gear knob

S line embossed Sports seats in cloth/leather combination

S line sill plates

Exterior equipment

Bumper 'blade' in Platinum optic

Chrome fog light surround

Chrome rolled exhaust

S line exterior styling package including:

- S line side skirts
- S line front bumper
- S line rear diffuser
- S line badges on wings

Rear LED lights

Roof spoiler (Avant models only)

Xenon headlights with LED daytime-running lights

Additional upholstery information

Option of black or silver stitching to upholstery, steering wheel, gearshift gaiters and floor mats



3-spoke S line steering wheel (paddle shift for automatic models)



18 x 8J '5-spoke' S line design alloy wheels

Images are for general illustration purposes only and do not necessarily depict UK specification.

S line model prices

Petrol – Saloon

Engines	Power	Transmission	Basic RRP	Total RRP ^{inc. VAT}	Recommended OTR
1.8 TFSI	120PS	6-speed manual	£20,126.09	£23,145.00	£23,910.00
1.8 TFSI	160PS	6-speed manual	£21,513.04	£24,740.00	£25,505.00
2.0 TFSI	211PS	6-speed manual	£23,556.52	£27,090.00	£27,830.00
2.0 TFSI quattro®	211PS	6-speed manual	£24,747.83	£28,460.00	£29,250.00
3.2 FSI	265PS	multitronic®	£27,556.52	£31,690.00	£32,520.00
3.2 FSI quattro®	265PS	6-speed manual	£27,513.04	£31,640.00	£32,470.00

Petrol – Avant

Engines	Power	Transmission	Basic RRP	Total RRP ^{inc. VAT}	Recommended OTR
1.8 TFSI	120PS	6-speed manual	£21,126.09	£24,295.00	£25,085.00
1.8 TFSI	160PS	6-speed manual	£22,513.04	£25,890.00	£26,680.00
2.0 TFSI	211PS	6-speed manual	£24,556.52	£28,240.00	£29,005.00
2.0 TFSI quattro®	211PS	6-speed manual	£25,747.83	£29,610.00	£30,400.00
3.2 FSI	265PS	multitronic®	£28,556.52	£32,840.00	£33,670.00
3.2 FSI quattro®	265PS	6-speed manual	£28,513.04	£32,790.00	£33,620.00

Diesel – Saloon

Engines	Power	Transmission	Basic RRP	Total RRP ^{inc. VAT}	Recommended OTR
2.0 TDI	120PS	6-speed manual	£22,108.70	£25,425.00	£26,165.00
2.0 TDI	143PS	6-speed manual	£22,704.35	£26,110.00	£26,850.00
2.0 TDI	170PS	6-speed manual	£23,556.52	£27,090.00	£27,830.00
2.0 TDI quattro®	170PS	6-speed manual	£24,747.83	£28,460.00	£29,200.00
2.7 TDI	190PS	multitronic®	£26,491.30	£30,465.00	£31,255.00
3.0 TDI quattro®	240PS	6-speed manual	£28,065.22	£32,275.00	£33,065.00

Diesel – Avant

Engines	Power	Transmission	Basic RRP	Total RRP ^{inc. VAT}	Recommended OTR
2.0 TDI	120PS	6-speed manual	£23,108.70	£26,575.00	£27,315.00
2.0 TDI	143PS	6-speed manual	£23,704.35	£27,260.00	£28,000.00
2.0 TDI	170PS	6-speed manual	£24,556.52	£28,240.00	£28,980.00
2.0 TDI quattro®	170PS	6-speed manual	£25,747.83	£29,610.00	£30,375.00
2.7 TDI	190PS	multitronic®	£27,491.30	£31,615.00	£32,405.00
3.0 TDI quattro®	240PS	6-speed manual	£29,065.22	£33,425.00	£34,215.00

Executive S line model equipment

In addition to S line model equipment:

Basic RRP	Total RRP <small>inc. VAT</small>
£552.17	£635.00
Upgrade charge from the 2.0 TDI 143PS Standard models £2,445.00*	

Audio and communication

Mobile telephone preparation – Low, in front centre armrest

Audi Symphony radio

Interior equipment

Cruise control

Seats

S line embossed Sports seats in leather/Alcantara upholstery



S line embossed Sports seats in leather/Alcantara upholstery

Executive S line model prices

Petrol – Saloon

Engines	Power	Transmission	Basic RRP	Total RRP ^{inc. VAT}	Recommended OTR
1.8 TFSI	120PS	6-speed manual	£20,678.26	£23,780.00	£24,545.00
1.8 TFSI	160PS	6-speed manual	£22,065.22	£25,375.00	£26,140.00
2.0 TFSI	211PS	6-speed manual	£24,108.70	£27,725.00	£28,465.00
2.0 TFSI quattro®	211PS	6-speed manual	£25,300.00	£29,095.00	£29,885.00
3.2 FSI	265PS	multitronic®	£28,108.70	£32,325.00	£33,155.00
3.2 FSI quattro®	265PS	6-speed manual	£28,065.22	£32,275.00	£33,105.00

Petrol – Avant

Engines	Power	Transmission	Basic RRP	Total RRP ^{inc. VAT}	Recommended OTR
1.8 TFSI	120PS	6-speed manual	£21,678.26	£24,930.00	£25,720.00
1.8 TFSI	160PS	6-speed manual	£23,065.22	£26,525.00	£27,315.00
2.0 TFSI	211PS	6-speed manual	£25,108.70	£28,875.00	£29,640.00
2.0 TFSI quattro®	211PS	6-speed manual	£26,300.00	£30,245.00	£31,035.00
3.2 FSI	265PS	multitronic®	£29,108.70	£33,475.00	£34,305.00
3.2 FSI quattro®	265PS	6-speed manual	£29,065.22	£33,425.00	£34,255.00

Diesel – Saloon

Engines	Power	Transmission	Basic RRP	Total RRP ^{inc. VAT}	Recommended OTR
2.0 TDI	120PS	6-speed manual	£22,660.87	£26,060.00	£26,800.00
2.0 TDI	143PS	6-speed manual	£21,852.17	£25,130.00	£25,870.00
2.0 TDI	170PS	6-speed manual	£24,108.70	£27,725.00	£28,465.00
2.0 TDI quattro®	170PS	6-speed manual	£25,300.00	£29,095.00	£29,835.00
2.7 TDI	190PS	multitronic®	£27,043.48	£31,100.00	£31,890.00
3.0 TDI quattro®	240PS	6-speed manual	£28,617.39	£32,910.00	£33,700.00

Diesel – Avant

Engines	Power	Transmission	Basic RRP	Total RRP ^{inc. VAT}	Recommended OTR
2.0 TDI	120PS	6-speed manual	£23,660.87	£27,210.00	£27,950.00
2.0 TDI	143PS	6-speed manual	£22,852.17	£26,280.00	£27,020.00
2.0 TDI	170PS	6-speed manual	£25,108.70	£28,875.00	£29,615.00
2.0 TDI quattro®	170PS	6-speed manual	£26,300.00	£30,245.00	£31,010.00
2.7 TDI	190PS	multitronic®	£28,043.48	£32,250.00	£33,040.00
3.0 TDI quattro®	240PS	6-speed manual	£29,617.39	£34,060.00	£34,850.00

A4 allroad model equipment

In addition to A4 Avant quattro® SE model equipment:

With its 18-inch alloy wheels, exterior aluminium package and wider track, the A4 allroad is designed with all terrains in mind. quattro® all-wheel-drive provides outstanding grip and stability as you drive, while the intelligent ESP adapts to any change in conditions to ensure a smooth ride on and off the road.

Basic RRP	Total RRP ^{INC.} _{VAT}
£1,156.52	£1,330.00

Wheels, tyres and suspension

18 x 8J '10-spoke' design alloy wheels with 245/45 R18 tyres

37mm suspension lift over Standard A4

Collapsible spare wheel

Off road detection system (ORD)

Seats

Tundra cloth

Interior equipment

Load and rail system

Storage package

Full length load mat

Micrometallic inlays

Exterior equipment

Exterior Off-Road Aluminium package

Headlight washers



18 x 8J '10-spoke' design alloy wheels



Load and rail system

Images are for general illustration purposes only and do not necessarily depict UK specification.

A4 allroad model prices

Petrol

Engines	Power	Transmission	Basic RRP	Total RRP ^{inc. VAT}	Recommended OTR
2.0 TFSI quattro*	211PS	7-speed S tronic	£26,013.04	£29,915.00	£30,745.00

Diesel

Engines	Power	Transmission	Basic RRP	Total RRP ^{inc. VAT}	Recommended OTR
2.0 TDI quattro*	170PS	6-speed manual	£24,778.26	£28,495.00	£29,285.00
3.0 TDI quattro*	240PS	7-speed S tronic	£29,330.43	£33,730.00	£34,560.00



Recommended On-The-Road (OTR) retail prices include: delivery charge, half a tank of fuel, number plates at £565.00 (inc. VAT), Road Fund Licence (which may vary depending on model/transmission – see page 64 for details) and first registration fee at £55.00.

RRP – Recommended Retail Price.



S4 quattro® equipment – in addition to SE model equipment:

One look at its muscular body styling, 18" alloy wheels and subtle S4 badging, and it'll come as no surprise that the Audi S4 features a new powerful 3.0-litre V6 supercharged engine, capable of taking you from 0 to 62mph in 5.1 seconds. And from the comfort and stability of a stylish Alcantara/leather Sports seat, you can sit back and enjoy every single unit of this engine's 333PS capability, safe in the knowledge that the quattro®

permanent all-wheel-drive system will keep you exactly where you want to be – on the road. But sleek styling and powerful performance in the S4 don't come at the expense of functional, driver-oriented specifications. Simple yet thoughtful touches, such as the matt-brushed aluminium inlays, S instrument dials and electric front seat have been included to ensure that your fast-paced life runs as smoothly as your Audi does.

Wheels, tyres and suspension

18 x 8.5J '5-double-spoke S' design alloy wheels with 245/40 R18 tyres

Seats

Sports seats with electric adjustment and lumbar support

Alcantara/leather upholstery

Safety and security

'S' model enhanced braking system

Interior equipment

3-spoke 'S' Sports multi-function leather steering wheel (with aluminium-look paddle shift on S tronic models)

Aluminium scuff plates

Interior lighting package

Inlays in matt-brushed aluminium

'S' instrument cluster

Exterior equipment

4-oval, twin tailpipes, in chrome finish

Aluminium-effect door mirror housings

Integrated boot-lid spoiler (Saloon models only)

LED tail-lights

Painted brake callipers with S4 logo (on front brakes only)

Platinum grey matte grille with vertical bars and chrome inserts

Roof spoiler (Avant models only)

'S' front and rear bumpers and side skirt

Xenon headlights with LED daytime-running lights



18 x 8.5J '5-double-spoke S' design alloy wheels



Xenon headlights with LED daytime-running lights

S4 quattro® model prices

Petrol – Saloon

Engines	Power	Transmission	Basic RRP	Total RRP ^{inc. VAT}	Recommended OTR
3.0 TFSI quattro*	333PS	6-speed manual	£29,065.22	£33,425.00	£34,255.00
3.0 TFSI quattro*	333PS	7-speed S tronic	£30,300.00	£34,845.00	£35,675.00

Petrol – Avant

Engines	Power	Transmission	Basic RRP	Total RRP ^{inc. VAT}	Recommended OTR
3.0 TFSI quattro*	333PS	6-speed manual	£30,065.22	£34,575.00	£35,595.00
3.0 TFSI quattro*	333PS	7-speed S tronic	£31,300.00	£35,995.00	£36,825.00



Recommended On-The-Road (OTR) retail prices include: delivery charge, half a tank of fuel, number plates at £565.00 (inc. VAT), Road Fund Licence (which may vary depending on model/transmission – see page 64 for details) and first registration fee at £55.00.

RRP – Recommended Retail Price.





S4 embossed Silk Nappa leather Super Sports seats in Magma red. (Available as a cost option on S4.)

Transmission

multitronic®

Translating a driver's preferences and intentions into road performance, the multitronic® automatic transmission system entertains no compromises – whether in terms of dynamism, convenience or economy. A continuously variable transmission available on front-wheel-drive models, multitronic® operates in an exceptionally wide range of gear ratios thanks to its steel link-plate chain construction. The result is exceptional driving comfort, as well as smooth, powerful acceleration over the entire range of engine speeds. In addition, thanks to its lightweight design and the DRP Dynamic Regulating Programme which monitors gradient, road conditions and the way the driver is using the accelerator pedal, multitronic® also plays an instrumental role in reducing fuel consumption. And with eight simulated gear ratios available, you can enjoy all these benefits whilst adopting the sporty driving style of a manual.

tiptronic®

The 6-speed tiptronic® transmission system is a form of automatic transmission available on A4 models with quattro® permanent all-wheel-drive. The technology incorporates DSP – or the Dynamic Shift Programme which aligns and converts the engine's high power and torque into both sporty performance and operating convenience, with crisp, fast gear-changes, reduced weight and optimised gear shifting. In the 'D' (Drive) and 'S' (Sport) programmes, the advanced electronics used in tiptronic® respond efficiently to every driver input, helping to prevent unwanted gear-changes. The driver can override automatic mode by moving the gear lever into a tiptronic® shift-gate, enabling spontaneous gear-changing for a sportier driving style.

S tronic®

The revolutionary 7-speed S tronic® gearbox combines sporty driving with the convenience and smooth, uninterrupted power of an automatic transmission. The technical basis of S tronic® is the double clutch. This consists of two lubricated plates with hydraulically-regulated contact pressure. It means that S tronic works almost as two separate systems: one engaging the odd-numbered gears, the other the even-numbered gears, enabling gear-shifts to be made in a fraction of a second, with no disruption to the power flow. So with S tronic®, depending on how the mood takes you, you can either allow gear-changes to take place automatically or, for a sportier driving style, operate the system using the gear lever or the optional steering wheel shift-paddles. The choice is yours.



Transmission

A4 and S4 Saloon and Avant

	1.8 TFSI 120PS	1.8 TFSI 160PS	2.0 TFSI	2.0 TFSI quattro*	3.2 FSI	3.2 FSI quattro*	S4 quattro*	2.0 TDI 120PS	2.0 TDI 143PS	2.0 TDI 170PS	2.0 TDI quattro* 170PS	2.7 TDI	3.0 TDI quattro*	Basic RRP	Total RRP ^{inc. VAT}
Automatic 6-speed tiptronic® transmission	-	-	-	-	-	●	-	-	-	-	-	-	●	£1,191.30	£1,370.00
Automatic 8-speed multitronic® transmission	-	●	●	-	S	-	-	-	●	-	-	S	-	£1,234.78	£1,420.00
Automatic 7-speed S tronic® transmission	-	-	-	●	-	-	●	-	-	-	-	-	-	£1,234.78	£1,420.00

A4 allroad

	2.0 TFSI quattro*	2.0 TDI quattro* 170PS	3.0 TDI quattro*	Basic RRP	Total RRP ^{inc. VAT}
Automatic 7-speed S tronic® transmission	S	-	S	£1,234.78	£1,420.00



- = Not available

● = Available

S = Standard



S line Sports seats in leather/Alcantara with silver stitching.



Paint finishes

Standard colours

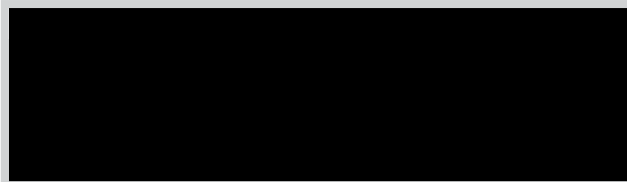

Brilliant black

A2



Brilliant red (not available on A4 allroad)

C8



Ibis white

T9

Optional colours

Basic RRP	Total RRP <small>inc. VAT</small>
£469.57	£540.00

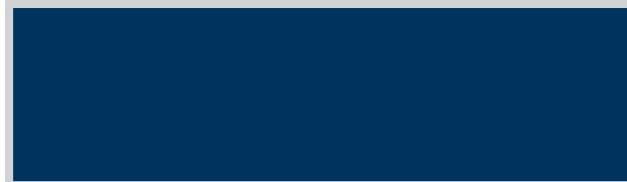

Aruba blue, pearl effect (not available on S4 or A4 allroad)

Q9



Dakar beige, metallic (not available on S4)

9X

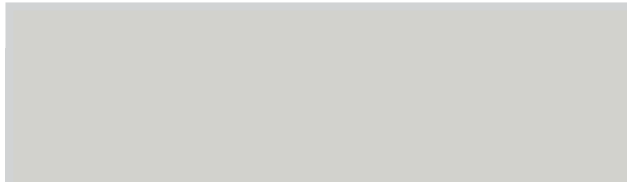

Ice silver, metallic

P5



Garnet red, pearl effect

9C

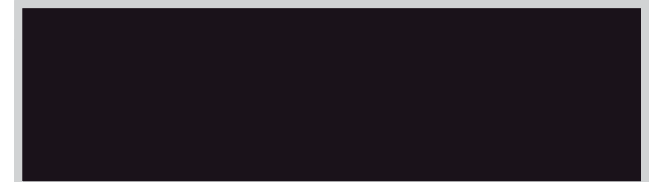

Lava grey, pearl effect (not available on S4)

1R

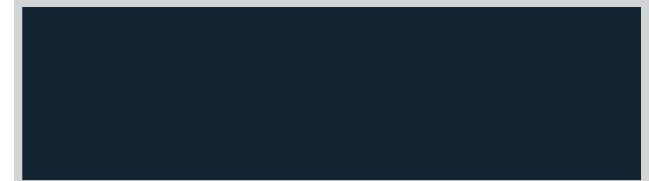

Meteor grey, pearl effect

X5

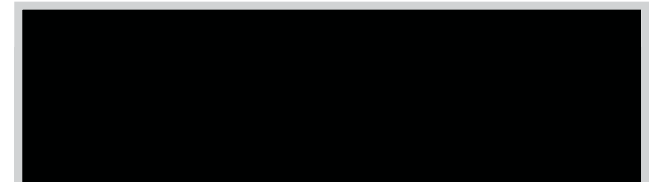

Phantom black, pearl effect

L8



Quartz grey, metallic (not available on A4 allroad)

Q4

S line additional colours

Basic RRP	Total RRP <small>INC. VAT</small>
£469.57	£540.00



Sphere blue, metallic (not available on S4)

9F

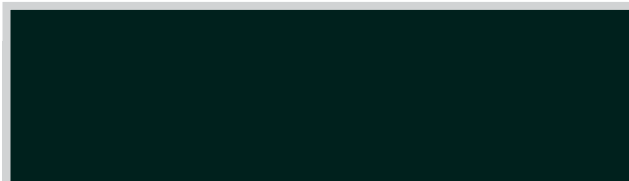

Deep green, pearl effect (not available on S4 or A4 allroad)

3W

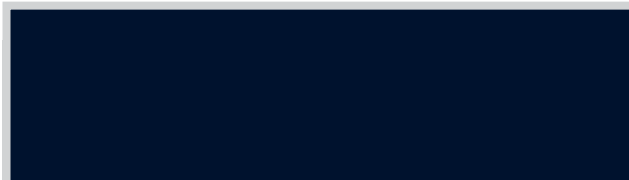

Deep sea blue, pearl effect

8A

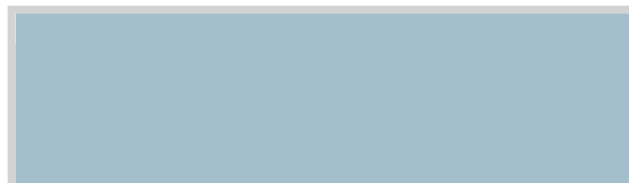

Monza silver, metallic (not available on S4 or A4 allroad)

U7



Misano red, pearl effect (not available on S4 or A4 allroad)

N9

Paint finishes

A4 allroad additional colours

Basic RRP	Total RRP <small>INC. VAT</small>
£469.57	£540.00



Teak brown, metallic

4U



Stratos blue, pearl effect

X4



Condor grey, metallic

5Q

S4 quattro® additional colours

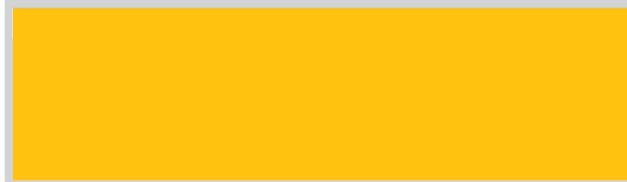

Imola yellow

1T













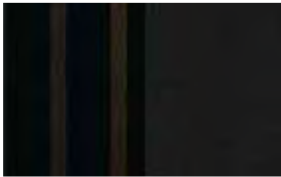

Sprint blue

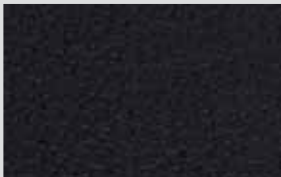
5N















Upholstery

Standard seats

				Standard	SE	Executive SE	S line	Executive S line	A4 allroad	S4 quattro [®]	Basic RRP	Total RRP ^{inc. VAT}		
				S	S	S	-	-	-	-	No charge	No charge		
Cosinus cloth, Black	GD	Cosinus cloth, Light grey	GQ											
					•	•	•	-	-	-	-	£100.00	£115.00	
Arkana cloth, Black	GD	Arkana cloth, Grey	GQ	Arkana cloth, Cardamom beige	GR									
						•	•	•	-	-	-	-	£1,095.65	£1,260.00
Milano leather, Black	GD	Milano leather, Cinnamon brown	CN	Milano leather, Light grey	GQ	Milano leather, Cardamom beige	GR							
						•	•	•	-	-	-	-	£1,395.65	£1,605.00
Valcona leather, Black	GD	Valcona leather, Light grey	GQ	Valcona leather, Luxor beige	GM	Valcona leather, Cinnamon brown	CN							
														
Valcona leather, Cardamom beige	GR													

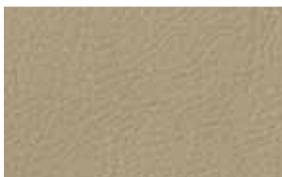
Upholstery

Sports seats (front, with 4-way electrical lumbar adjustment and manual height adjustment)





		Standard	SE	Executive SE	S line	Executive S line	A4 allroad	S4 quattro*	Basic RRP	Total RRP ^{inc. VAT}
	GD									
Atrium cloth, Black	GD	•	•	•	-	-	-	-	£404.35	£465.00
	GQ									
Atrium cloth, Light grey	GQ									
	GD/ZM/SC									
Leather/Alcantara, Black	GD/ZM/SC	•	•	•	-	-	-	S	£1,182.61	£1,360.00
	GQ									
Leather/Alcantara, Light grey*	GQ									
	GD/ZM/SC									
Milano leather, Black	GD/ZM/SC	•	•	•	-	-	-	-	£1,500.00	£1,725.00
	CN									
Milano leather, Cinnamon brown*	CN	-	-	-	-	-	-	•	£317.39	£365.00
	GQ									
Milano leather, Light grey*	GQ									
	GR									
Milano leather, Cardamom beige*	GR									
	GD									
Valcona leather, Black	GD	•	•	•	-	-	-	-	£1,800.00	£2,070.00
	GM									
Valcona leather, Luxor beige	GM									
	CN									
Valcona leather, Cinnamon brown	CN									
	GQ									
Valcona leather, Light grey	GQ									
	GR									
Valcona leather, Cardamom beige	GR									

*Not available on S4.

All leather upholstery choices include seats, head restraints, door inserts and front centre armrest (if fitted) in leather. Alcantara/leather choices include head restraints, seat side bolsters and front centre armrest (if fitted) in leather with the seat centres and door inserts in Alcantara.

Upholstery

S line Sports seats (front, with 4-way electrical lumbar adjustment and manual height adjustment. Front seats with 'S line' logo available with black stitching on all upholsteries and silver stitching on leather/cloth and leather/Alcantara upholsteries)

		Standard	SE	Executive SE	S line	Executive S line	A4 allroad	S4 quattro*	Basic RRP	Total RRP ^{inc. VAT}
	OE	-	-	-	S	-	-	-	No charge	No charge
Leather/cloth, Black* with silver stitching*	QF	-	-	-	-	-	-	-	-	-
	OE	-	-	-	•	S	-	-	£404.35	£465.00
Leather/Alcantara, Black with silver stitching	QF	-	-	-	-	-	-	-	-	-
	OE	-	-	-	•	-	-	-	£691.30	£795.00
Milano leather, Black	OE	-	-	-	-	•	-	-	£286.96	£330.00
	OE	-	-	-	•	-	-	-	£1,021.74	£1,175.00
Valcona leather, Black	OE	-	-	-	-	•	-	-	£617.39	£710.00

Upholstery

Climate Comfort seats. Climate-controlled front seats can be heated or cooled according to the driver's and passenger's requirements. Includes electrically-adjustable front seats and memory function for driver's seat. Also included: door mirrors – electrically folding and auto-dimming with memory function, and auto-dimming rear view mirror. (Only available in Milano leather).



Milano leather, Black



GD

Milano leather, Cinnamon brown

CN



Milano leather, Light grey

GQ



Milano leather, Cardamom beige

GR

Standard	SE	Executive SE	S line	Executive S line	A4 allroad	S4 quattro*	Basic RRP	Total RRP ^{inc. VAT}
•	•	•	–	–	–	–	£3,352.17	£3,855.00









Sports seats in Black Valcona leather (GD), with micrometallic inlays (5MA) and DVD-based Satellite Navigation system

All leather upholstery choices include seats, head restraints, door inserts and front centre armrest (if fitted) in leather.

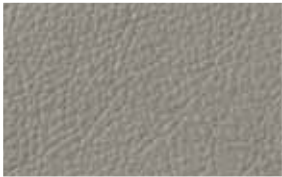
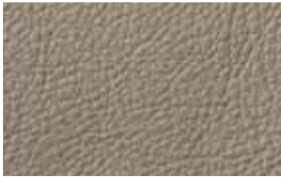

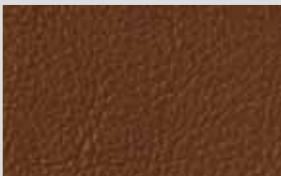











A4 allroad Upholstery

Standard seats

				Standard	SE	Executive SE	S line	Executive S line	A4 allroad	S4 quattro*	Basic RRP	Total RRP ^{inc. VAT}
	GD		CX	-	-	-	-	-	S	-	No charge	No charge
	GD		CX		CN		CT	-	•	-	£1,095.65	£1,260.00
	GD		CX		CN		BY	-	•	-	£1,395.65	£1,605.00
	CT											

A4 allroad Upholstery

Sports seats (front, with 4-way electrical lumbar adjustment and manual height adjustment)

				Standard	SE	Executive SE	S line	Executive S line	A4 allroad	S4 quattro*	Basic RRP	Total RRP ^{inc. VAT}
	GD		CX	-	-	-	-	-	•	-	£404.35	£465.00
	GD		CX	-	-	-	-	-	•	-	£1,182.61	£1,360.00
	GD		CX		CN		CT	-	•	-	£1,500.00	£1,725.00
	GD		CX		CN		BY	-	•	-	£1,800.00	£2,070.00
	CT		CP		BZ							

All leather upholstery choices include seats, head restraints, door inserts and front centre armrest (if fitted) in leather. Alcantara/leather choices include head restraints, seat side bolsters and front centre armrest (if fitted) in leather with the seat centres and door inserts in Alcantara.

A4 allroad Upholstery

Climate Comfort seats. Climate-controlled front seats can be heated or cooled according to the driver's and passenger's requirements. Includes electrically-adjustable front seats and memory function for driver's seat. Also included: door mirrors – electrically folding and auto-dimming with memory function, and auto-dimming rear view mirror. (Only available in Milano leather).



Milano leather, Black

GD

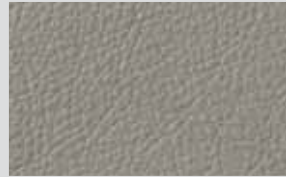

Milano leather, Light grey

CX

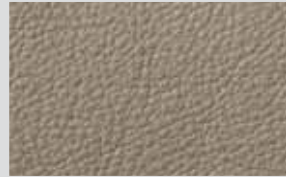

Milano leather, Cardamom beige

CT

Standard	SE	Executive SE	S line	Executive S line	A4 allroad	S4 quattro*	Basic RRP	Total RRP ^{inc. VAT}
					•		£3,352.17	£3,855.00



Climate comfort seats in cardamon beige (AN), Fine grain ash inlays (PDL) and Satellite navigation system Plus (PNA)

All leather upholstery choices include seats, head restraints, door inserts and front centre armrest (if fitted) in leather.



Upholstery

S4 quattro® Super Sports seats S4 embossed seats with electric height adjustment, forwards and backwards position, backrest angle and lumbar support for driver and front-passenger seats (must be combined with Ski bag with through-load facility).



Leather/Alcantara, Black ZM/SC



Silk Nappa leather, Black, with Silver stitching ZM/SC



Two-tone Silk Nappa leather, Pearl silver/Black ZW/SD



Two-tone Silk Nappa leather, Magma red/Black FA/SJ



Two-tone Silk Nappa leather, Mustang brown/Black SH/SK

	Standard	SE	Executive SE	S line	Executive S line	A4 allroad	S4 quattro®	Basic RRP	Total RRP ^{inc. VAT}
Leather/Alcantara, Black	-	-	-	-	-	-	•	£500.00	£575.00
Silk Nappa leather, Black, with Silver stitching	-	-	-	-	-	-	•	£843.48	£970.00





A4/S4 Saloon and Avant colour and trim guide

Please use the guide below to ensure your preferred colours and trims are perfectly matched according to your taste.

Standard seats – Interior trim colours:

Order code	Upholstery	Carpet	Dashboard (upper/lower)	Headlining	Cosinus cloth (N2M)	Arkana cloth (N0L)	Milano leather (N5W)	Valcona leather (N5D)
GD	Black	Black	Black/Black	Star silver	●	●	●	●
GM	Luxor beige	Black	Black/Black	Black	–	–	–	●
CN	Cinnamon brown	Black	Black/Black	Star silver	–	–	●	●
GQ	Light grey	Quartz grey	Graphite grey/Graphite grey	Star silver	●	●	●	●
GR	Cardamom beige	Coriander beige	Tan beige/Tan beige	Linen beige	–	●	●	●

Sports seats – Interior trim colours:

Order code	Upholstery	Carpet	Dashboard (upper/lower)	Headlining	Atrium cloth (N2E)	Alcantara/leather (N7U)	Milano leather (N5W)	Valcona leather (N5D)
GD	Black	Black	Black/Black	Star silver	●	●	●	●
GM	Luxor beige	Black	Black/Black	Black	–	–	–	●
CN	Cinnamon brown	Black	Black/Black	Star silver	–	–	●	●
GQ	Light grey	Quartz grey	Graphite grey/Graphite grey	Star silver	●	●	●	●
GR	Cardamom beige	Coriander beige	Tan beige/Tan beige	Linen beige	–	–	●	●

S line Sports seats – Interior trim colours:

Order code	Upholstery	Carpet	Dashboard (upper/lower)	Headlining	Cloth/leather (N7V)	Alcantara/leather (N7K)	Milano leather (N1Y)	Valcona leather (N1V)
QE (Black stitching)	Black	Black	Black/Black	Black	●	●	●	●
QF (Silver stitching)	Black	Black	Black/Black	Black	●	●	–	–

S4 Sports seats – Interior trim colours:

Order code	Upholstery	Carpet	Dashboard (upper/lower)	Headlining	Alcantara/leather (N7U)	Milano leather (N5W)
ZM/SC	Black	Black	Black/Black	Black/Silver	●	●

A4/S4 Saloon and Avant colour and trim guide

S4 Super Sports seats – Interior trim colours with 'S' embossing:

Order code	Upholstery	Carpet	Dashboard (upper/lower)	Headlining	Alcantara/leather (N7N)	Silk Nappa leather (N1U)
ZM/SC	Black	Black	Black/Black	Black or Silver	●	●
ZW/SD	Pearl silver/Black	Black	Black/Black	Black or Silver	–	●
FA/SJ	Magma red/Black	Black	Black/Black	Black or Silver	–	●
SH/SK	Mustang brown/Black	Black	Black/Black	Black or Silver	–	●

Comfort seats – Interior trim colours:

Order code	Upholstery	Carpet	Dashboard (upper/lower)	Headlining	Milano leather (N5W)
GD	Black	Black	Black/Black	Star silver	●
CN	Cinnamon brown	Black	Black/Black	Star silver	●
GQ	Light grey	Quartz grey	Graphite grey/Graphite grey	Star silver	●
GR	Cardamom beige	Coriander beige	Tan beige/Tan beige	Linen beige	●



A4 allroad colour and trim guide

Please use the guide below to ensure your preferred colours and trims are perfectly matched according to your taste.

Standard seats – Interior trim colours:

Order code	Upholstery	Carpet	Dashboard (upper/lower)	Headlining	Tundra cloth (N2W)	Milano leather (N5W)	Valcona leather (N5D)
GD	Black	Black	Black/Black	Silver	●	●	●
CN	Cinnamon brown	Black	Black/Black	Silver	–	●	●
CX	Light grey	Black	Black/Black	Silver	●	●	●
BY	Luxor beige	Black	Black/Black	Linen beige	–	–	●
CT	Cardamom beige	Tan beige/Tan beige	Coriander beige	Linen beige	–	●	●

Sports seats – Interior trim colours:

Order code	Upholstery	Carpet	Dashboard (upper/lower)	Headlining	Tundra cloth (N2W)	Alcantara/leather (N7U)	Milano leather (N5W)	Valcona leather (N5D)
GD	Black	Black	Black/Black	Silver	●	●	●	●
CN	Cinnamon brown	Black	Black/Black	Silver	–	–	●	–
CP	Cinnamon brown/Black	Black	Black/Black	Silver	–	–	–	●
CX	Light grey	Black	Black/Black	Silver	●	●	●	●
BY	Luxor beige	Black	Black/Black	Linen beige	–	–	–	●
BZ	Linen beige/Cardamom beige	Tan beige/Tan beige	Coriander beige	Linen beige	–	–	–	●
CT	Cardamom beige	Tan beige/Tan beige	Coriander beige	Linen beige	–	–	●	–

Comfort climate seats – Interior trim colours:

Order code	Upholstery	Carpet	Dashboard (upper/lower)	Headlining	Milano leather (N5W)
GD	Black	Black	Black/Black	Silver	●
CX	Light grey	Black	Black/Black	Silver	●
CT	Cardamom beige	Tan beige/Tan beige	Coriander beige	Linen beige	●

A4 allroad exterior colour and bumper guide

Solid paint:

Order code	Exterior colour	Ebony coloured bumper	Platinum grey coloured bumper
T9	Ibis white	●	-
A2	Brilliant black	-	●





Metallic paint:

Order code	Exterior colour	Ebony coloured bumper	Platinum grey coloured bumper
9X	Dakar beige	●	-
9X	Ice silver	●	-
5Q	Condor grey	●	-
9F	Sphere blue	●	-
4U	Teak brown	-	●

Pearl effect paint:

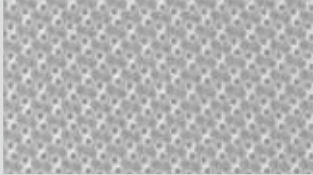



Order code	Exterior colour	Ebony coloured bumper	Platinum grey coloured bumper
X5	Meteor grey	●	-
9C	Garnet red	●	-
X4	Stratos blue	●	-
L8	Phantom black	-	●
8A	Deep sea blue	-	●
1R	Lava grey	-	●

Inlays

Order code			Standard	SE	Executive SE	S line	Executive S line	A4 allroad	S4 quattro*	Basic RRP	Total RRP ^{inc. VAT}
PDC		Aluminium hologram (with Aluminium optics for centre console and electromechanical parking brake)	• -	- S	- S	- -	- -	- -	- -	£126.09 No charge	£145.00 No charge
5MG		Walnut brown (with Aluminium optics for centre console and electromechanical parking brake)	• -	- •	- •	- -	- -	- •	- -	£278.26 £126.09	£320.00 £145.00
5TK		Fine grain ash, Almond beige (with Aluminium optics for centre console and electromechanical parking brake)	• -	- •	- •	- -	- -	- -	- -	£278.26 £126.09	£320.00 £145.00
7TD		Laurel nutmeg (with Aluminium optics for centre console and electromechanical parking brake)	• -	- •	- •	- -	- -	- •	- -	£278.26 £126.09	£320.00 £145.00
7TL		Fine grain ash, natural	- -	- -	- -	- -	- -	• -	- -	£382.60	£440.00

Options are subject to availability and may extend delivery.
 - = Not available • = Available **S** = Standard

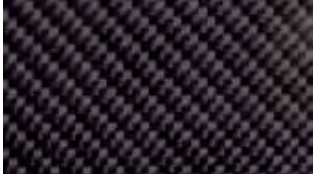
Inlays

Order code			Standard	SE	Executive SE	S line	Executive S line	A4 allroad	S4 quattro*	Basic RRP	Total RRP ^{inc. VAT}
5MU		Aluminium Trigon (with Aluminium optics for light switches, centre console and electromechanical parking brake)	-	-	-	-	-	●	-	£126.09	£145.00
5TL		Piano black (with Aluminium optics for light switches, centre console and electromechanical parking brake)	-	-	-	●	●	-	-	No charge	No charge
5TW		Vavona wood Assam grey (with Aluminium optics for light switches, centre console and electromechanical parking brake)	-	-	-	●	●	-	-	£278.26	£320.00
5MK		Carbon Atlas	-	-	-	-	-	-	●	£213.04	£245.00
5MZ		Stainless steel mesh	-	-	-	-	-	-	●	£300.00	£345.00





Wheels, tyres and suspension

Order code		Standard	SE	Executive SE	S line	Executive S line	A4 allroad	S4 quattro*	Basic RRP	Total RRP ^{inc. VAT}
PRY	17 x 7.5J '7-arm' design alloy wheels with 225/50 R17 tyres	•	S	-	-	-	-	-	£382.61	£440.00
PRE	17 x 7.5J '6-spoke' design alloy wheels with 225/50 R17 tyres	•	-	-	-	-	-	-	£469.57	£540.00
		-	•	-	-	-	-	-	£86.96	£100.00
PRS	17 x 7.5J '6-arm diamond' design alloy wheels with 225/50 R17 tyres	•	-	-	-	-	-	-	£639.13	£735.00
		-	•	-	-	-	-	-	£256.52	£295.00
		-	-	•	-	-	-	-	No charge	No charge
PRT	17 x 8J '10-spoke' design alloy wheels with 245/45 R17 tyres	•	-	-	-	-	-	-	£639.13	£735.00
		-	•	S	-	-	-	-	£256.52	£295.00
PRJ	18 x 8J '5-parallel-spoke' design alloy wheels with 245/40 R18 tyres	-	-	-	-	-	-	•	£469.57	£540.00
PRD	18 x 8J '5-spoke star' design alloy wheels with 245/40 R18 tyres	-	•	-	-	-	-	-	£513.04	£590.00
		-	-	•	-	-	-	-	£256.52	£295.00
PQH	18 x 8J '15-spoke' design alloy wheels with 245/40 R18 tyres	-	•	-	-	-	-	-	£513.04	£590.00
		-	-	•	-	-	-	-	£256.52	£295.00
PQ5	18 x 8J '10-spoke exclusive' design alloy wheels with 245/40 R18 tyres	-	-	-	•	•	-	-	No charge	No charge
PRL	18 x 8J '5-arm rotor' design alloy wheels with 245/45 R18 tyres	-	-	-	-	-	•	-	£130.43	£150.00
PQ6	19 x 8.5J '5-segment-spoke' design alloy wheels with 255/35 R19 tyres	-	-	-	-	-	-	•	£956.52	£1,100.00



17 x 7.5J '6-spoke' design alloy wheels



17 x 8J '10-spoke' design alloy wheels



18 x 8J '5-spoke star' design alloy wheels

Options are subject to availability and may extend delivery.
 - = Not available • = Available **S** = Standard

Wheels, tyres and suspension

Order code		Standard	SE	Executive SE	S line	Executive S line	A4 allroad	S4 quattro*	Basic RRP	Total RRP ^{inc. VAT}
PQF	19 x 8.5J '7-arm double-spoke' design alloy wheels with 255/35 R19 tyres	-	-	-	•	•	-	-	£552.17	£635.00
		-	-	-	-	-	-	•	£300.00	£345.00
PQS	19 x 8.5J '20-spoke' design alloy wheels with 255/35 R19 tyres	-	-	-	•	•	-	-	£552.17	£635.00
		-	-	-	-	-	-	•	£300.00	£345.00
2H1 IN7	Audi drive select with dynamic steering (only available on 143PS models and above)	-	•	•	•	•	•	•	£852.17	£980.00
2H1 1BL	Audi drive select with damper control (only available with servotronic steering)	-	•	•	-	-	-	-	£852.17	£980.00
		-	-	-	•	•	-	•	£513.04	£590.00
2H1 1BL 1N7	Audi drive select – full package with damper control and dynamic steering (only available on 143PS models and above)	-	•	•	-	-	-	-	£1,460.87	£1,680.00
		-	-	-	•	•	-	•	£1,121.74	£1,290.00
GH2	Audi quattro® Sports differential (must be combined with Audi drive select with dynamic steering or the full package. Only available on 3.0 TDI, 3.2 FSI and S4 quattro®)	-	-	-	•	•	-	•	£400.00	£460.00

Dynamic steering

With this new technology, driving is significantly more agile under everyday conditions, while directional stability and precision are increased at high speeds and in demanding driving situations.

Damper control

Formed on the basis of lowered Sports suspension, the optional damper control system makes it possible to tune suspension settings individually for each wheel, using adjustable hydraulic dampers.



18 x 8J '5-arm rotor' design alloy wheels



19 x 8J '5-segment-spoke' design alloy wheels



19 x 8.5J '7-arm double-spoke' design alloy wheels

Audio and communication

Order code		Standard	SE	Executive SE	S line	Executive S line	A4 allroad	S4 quattro*	Basic RRP	Total RRP ^{inc. VAT}
8UD	Audi Concert radio. Single CD with MP3 compatibility, colour centre console screen, SD memory-card reader and AUX-IN socket in centre console	•	S	-	S	-	S	S	£256.52	£295.00
8UM	Audi Symphony radio, with front-loading MP3-compatible 6-CD changer, colour centre console screen, SD memory-card reader and AUX-IN socket in centre console	• -	- •	- S	- •	- S	- •	- •	£482.61 £234.78	£555.00 £270.00
9VK	Bang & Olufsen sound system, designed specifically for the A4, providing surround-sound reproduction with dynamic-noise compensation, 14 high-performance loudspeakers (505 Watt) and 10-channel amplifier	-	•	•	•	•	•	•	£447.83	£515.00
QV3	DAB digital radio	-	•	•	•	•	•	•	£256.52	£295.00
QV9	TV reception – analogue and digital (only in combination with a Technology package)	-	•	•	•	•	•	•	£721.74	£830.00
UF7	Audi Music Interface (AMI). Universal connection for use with stereo audio sources, USB and MP3 devices including Apple iPod generation 4 onwards (iPod, iPod classic, iPod mini, iPod nano, iPod photo, iPod video, iPod touch). Provides intuitive control through the audio system and multi-function steering wheel where fitted. It also replicates the iPod display on the audio screen and DIS, including track titles. The interface provides charging function (dependent on device). Must be combined with Concert or Symphony radio or a Technology package (includes 2 cables to connect your iPod or USB MP3 device)	-	•	•	•	•	•	•	£213.04	£245.00



6-CD in-dash changer – part of Satellite Navigation system Plus



Satellite Navigation system Plus

Audio and communication

Order code		Standard	SE	Executive SE	S line	Executive S line	A4 allroad	S4 quattro*	Basic RRP	Total RRP ^{INC. VAT}
9ZX	Mobile telephone preparation – Bluetooth interface. Provides handsfree connection via Bluetooth using mobile phone aerial. Please contact your Audi centre for phone compatibility	● -	- ●	- -	- ●	- -	- ●	- ●	£217.39 £86.96	£250.00 £100.00
PT5	Mobile telephone preparation – Low. In front centre armrest. Uses Bluetooth interface or cradle to connect to your A4, including roof aerial for optimal reception. Includes centre armrest for Standard trim models. A phone cradle is required for charging your phone, at extra cost. Please contact your Audi Centre for details of phone compatibility (cannot be combined with Chorus radio)	● -	- ●	- S	- ●	- S	- ●	- ●	£447.83 £317.39	£515.00 £365.00
9ZW	Mobile telephone preparation – High. Uses Bluetooth interface with no physical connection to your A4, including roof aerial for optimal reception. Please note that your mobile phone must have SIM-Access Profile facility for full functionality (only in combination with a Technology package)	- -	● -	- ●	● -	- ●	● -	● -	£552.17 £234.78	£635.00 £270.00
PT4	Mobile telephone preparation – High (with privacy handset). The handset allows passengers to make private calls, providing remote control of the telephone functions as well as a convenient SMS text messaging function. The handset is charged from a docking station integrated in the front centre armrest (only in combination with a Technology package)	- -	● -	- ●	● -	- ●	● -	● -	£808.70 £491.30	£930.00 £565.00
9WM	Rear Seat Entertainment Package fitted to the back of the front seats. The package includes 2 detachable DVD players/monitors (supplied by Audi Genuine Accessories) that can be used both inside and outside of the A4. Front seats are fitted with the mountings and power connection for the DVD players for when the entertainment system is used inside the A4. The system can be used outside the car using a rechargeable battery or mains power connection, which is included in the package. Includes individual remote controls (not available in combination with Super Sports seats)	-	●	●	●	●	●	●	£847.83	£975.00
PNG 8T1 UF7	Technology package – HDD Satellite Navigation system with MMI 3G – High, Audi Music Interface and cruise control	- -	● -	- ●	● -	- ●	● -	● -	£1,700.00 £1,304.35	£1,955.00 £1,500.00
PNG 8T4 UF7	Technology package – HDD Satellite Navigation system with MMI 3G – High, Audi Music Interface and adaptive cruise control (only available on 6-cylinder models)	- -	● -	- ●	● -	- ●	● -	● -	£2,473.91 £2,078.26	£2,845.00 £2,390.00

HDD Satellite Navigation with MMI 3G

3rd generation MMI system including single CD/DVD player, 2 FM tuners, high resolution (800x400) 7" colour TFT display, 2 SD card readers and 40GB hard drive, 10GB of which can be used to store up to 4,000 songs. HDD Navigation functionality includes advanced speech recognition, 3D and topographical mapping display and advanced 3D building display (with this feature installed, the MMI controls move from sound system head-unit to around the gear lever).

Seats

Order code		Standard	SE	Executive SE	S line	Executive S line	A4 allroad	S4 quattro*	Basic RRP	Total RRP ^{inc. VAT}
PV1	Electric front seats, with adjustment for height, forwards and backwards position, backrest angle and lumbar support for driver and front-passenger seats	●	●	●	-	-	●	-	£639.13	£735.00
		-	-	-	●	●	-	S	£443.48	£510.00
PV3 6XL	Comfort pack. Comprising electric front seats with lumbar support, memory function on driver's side, door mirrors – electrically folding and auto-dimming with memory function and auto-dimming rear-view mirror	-	●	●	-	-	●	-	£1,191.30	£1,370.00
		-	-	-	●	●	-	-	£995.65	£1,145.00
		-	-	-	-	-	-	●	£552.17	£635.00
7P1	Electric lumbar support for front seats, with horizontal and vertical adjustment	●	●	●	S	S	●	S	£195.65	£225.00
4A3	Heated front seats, individually controlled heating for seat base and bolster with variable temperature adjustment	●	●	●	●	●	●	●	£213.04	£245.00
4A4	Heated front and rear seats, individually controlled seat base and bolster heating with variable temperature adjustment (not available with cloth upholstery)	●	●	●	●	●	●	●	£382.61	£440.00



Options are subject to availability and may extend delivery.
 - = Not available ● = Available **S** = Standard

Safety and security

Order code		Standard	SE	Executive SE	S line	Executive S line	A4 allroad	S4 quattro*	Basic RRP	Total RRP ^{inc. VAT}
7X1	Acoustic Parking System (rear only)	-	•	•	•	•	•	•	£300.00	£345.00
7X4	Audi Parking System Plus. Aids parking by acoustically and graphically indicating distances to obstacles in front of and behind your A4	-	•	•	•	•	•	•	£552.17	£635.00
7X8	Audi Parking System Advanced. Aids parking by acoustically and visually (with guiding lines) indicating distances to obstacles in front of and behind your A4. Measured by ultrasonic sensors with camera integrated discreetly in the boot handle (only in combination with a Technology package)	-	•	•	•	•	•	•	£895.65	£1,030.00
7Y1	Audi side assist. Aids the driver when changing lane. Audi side assist monitors the area behind your A4, using radar sensors located discreetly in the rear bumper, informing the driver with a visual warning signal in the door mirror if there is a vehicle in the driver's blind spot or approaching quickly from behind. The system is activated using a button in the driver's door	-	•	•	•	•	•	•	£382.61	£440.00
PU1	Audi lane assist. Uses a discreet camera at the top of the windscreen to monitor the road ahead. The driver is warned with a vibration of the steering wheel if the vehicle is about to exit its lane unintentionally (only in combination with 4-spoke multi-function steering wheel)	-	•	•	•	•	•	•	£382.61	£440.00
6XK	Exterior mirrors – heated, electrically-folding and with auto-dimming function	-	•	•	•	•	•	•	£126.09	£145.00
VC1	Garage door opener (Homelink®*). Programmable radio-operated remote control for compatible doors/gates. Control buttons integrated in the front roof module	•	•	•	•	•	•	•	£147.83	£170.00
UH2	Audi Hill-Hold assist. Automatically activates electromechanical parking brake when stationary	•	•	•	•	•	•	•	£39.13	£45.00
4X4	Rear side airbags	•	•	•	•	•	•	•	£213.04	£245.00
7K6	Tyre pressure monitoring display	-	•	•	•	•	•	•	£65.22	£75.00

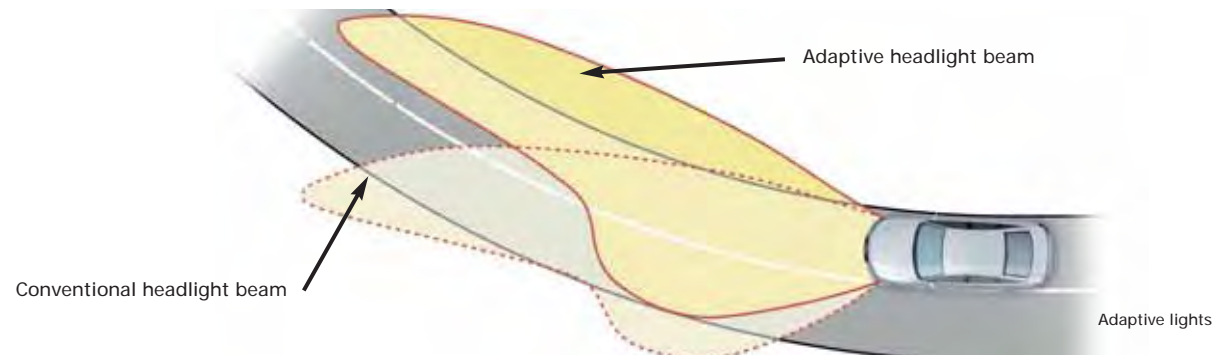

Interior equipment

Order code		Standard	SE	Executive SE	S line	Executive S line	A4 allroad	S4 quattro*	Basic RRP	Total RRP <small>inc. VAT</small>
4F2	Advanced key. Access and authorisation system which automatically exchanges data between key and vehicle, allowing the driver to keep the key in their pocket or bag at all times. To unlock and open, simply lift the exterior door handle. To lock, press the button on the handle. Pressing the start/stop button integrated into the centre console starts and stops the engine	-	•	•	•	•	•	•	£421.74	£485.00
6NQ	Black headlining (only in combination with upholstery codes GD and GP)	•	•	•	S	S	•	S	£169.57	£195.00
QE1	Storage pack. Includes storage nets on the front-seat backrests, storage compartment under the front seats (if memory function is fitted, only under the front-passenger seat), drinks holder in the rear centre armrest and a locking glove compartment	•	•	•	•	•	S	•	£86.96	£100.00
6E3	Front centre armrest including 12V power socket	•	S	S	S	S	S	S	£134.78	£155.00
3X2	Ski bag with through-load facility	•	•	•	•	•	•	•	£134.78	£155.00
3Y2	Blind – electric for rear window (Saloon models only)	•	•	•	•	•	-	•	£200.00	£230.00
3Y4	Blind – manual for rear side windows	•	•	•	•	•	•	•	£86.96	£100.00
8T1	Cruise control	•	•	S	•	S	•	•	£160.87	£185.00
8T4	Audi adaptive cruise control. Automatic distance regulation, using radar sensors to maintain required distance by braking and accelerating. Four programs (distance 1 to distance 4) set via steering column controls of the cruise control system	•	•	-	•	-	•	•	£934.78 £773.91	£1,075.00 £890.00
QQ1	Interior light pack. Includes rear reading lights, entrance lights, front footwell lights, active door reflectors, vanity mirrors and illumination of the glove compartment, vents and internal door controls	•	•	•	•	•	•	S	£139.13	£160.00
6SJ	Reversible load mat with bumper cover. One side in rubber, the other in carpet (Avant models only)	•	•	•	•	•	S	•	£73.91	£85.00
3GN	Load area rail system and fixing kit. Includes load area rails, telescopic bar and securing belt for dividing the luggage compartment (Avant models only)	•	•	•	•	•	S	•	£126.09	£145.00
7HB	Leather Package – includes leather covered armrest on door panel for front and rear	-	•	•	•	•	•	•	£165.22	£190.00



Blind – manual for rear side windows



Ski bag with through-load facility



Load area rail system and fixing kit

Exterior equipment

Order code		Standard	SE	Executive SE	S line	Executive S line	A4 allroad	S4 quattro*	Basic RRP	Total RRP ^{INC. VAT}
8Q5	Adaptive lights – Swivelling headlights for improved illumination of winding roads	-	-	-	●	●	-	●	£278.26	£320.00
PX1	Adaptive Xenon plus headlights with LED daytime running lights. (Includes rear LED lights and headlight washers)	-	●	●	-	-	-	-	£934.78	£1,075.00
8K4		-	-	-	-	-	●	-	£760.87	£875.00
8Q5		-	-	-	-	-	-	-		
1D2	Tow-bar, factory-fitted and removable	●	●	●	●	●	●	●	£552.17	£635.00
2Z0	Deletion of model and engine capacity designation at rear	●	●	●	●	●	●	●	No charge	No charge
2Z7	Deletion of engine capacity at rear	●	●	●	●	●	●	●	No charge	No charge
8N7	High-beam assist Automatically adjusts headlights from high-beam to dipped-beam when another vehicle is approaching	-	●	●	●	●	●	●	£95.65	£110.00
4E9	Power-operated tailgate (Avant models only)	●	●	●	●	●	●	●	£317.39	£365.00
3FE	Electric slide-and-tilt sunroof (Saloon models only)	●	●	●	●	●	-	●	£721.74	£830.00
3FU	Open sky panoramic sunroof (Avant models only)	●	●	●	●	●	●	●	£934.78	£1,075.00
VW1	Privacy glass (Avant models only)	-	●	●	●	●	●	●	£278.26	£320.00
VJ1	Full paint finish. Bumpers are painted in body colour with matt finish	-	-	-	-	-	●	-	£956.52	£1,100.00
4ZM	Black styling pack	-	●	●	●	●	-	●	£300.00	£345.00

Steering wheels

Order code		Standard	SE	Executive SE	S line	Executive S line	A4 allroad	S4 quattro*	Basic RRP	Total RRP ^{INC. VAT}
2ZQ	Steering wheel – leather 4-spoke multi-function (only in combination with Audi lane assist on S line models)	●	-	-	-	-	-	-	£126.09	£145.00
		-	S	S	●	●	S	●	No charge	No charge
2ZS	Steering wheel – leather 4-spoke multi-function with paddle shift for automatic transmission (only in combination with Audi lane assist)	-	●	●	-	-	●	-	£117.39	£135.00
		-	-	-	●	●	-	●	No charge	No charge
1XX	Steering wheel – leather Sports 3-spoke multi-function with paddle shift for automatic transmission	-	●	●	-	-	●	-	£204.35	£235.00
1XW	Steering wheel – leather Sports 3-spoke multi-function	-	●	●	-	-	●	-	£86.96	£100.00

A4 Saloon and Avant Centre-fitted accessories

Audi Centre-fitted accessories offer a range of products that enable you to tailor your Audi A4 to your tastes and requirements. All accessories available for the Audi A4 are covered by a 3-year warranty (excluding Road Angel) if they are ordered and included in the purchase price of the car from new. All prices shown exclude fitting and painting, where this is required. Please contact your Audi Centre for further details of the accessories available for the Audi A4.

	Part number	Basic RRP	Total RRP <small>inc. VAT</small>
19 x 8.5J '5-arm hollow-spoke' design silver or anthracite polished alloy wheels, price shown is for 4 wheels excluding tyres, size required 255/35 R19	Various	£1,700.87	£1,956.00
Exterior body styling package,* includes front spoiler with blade, rear diffuser, rear spoiler and side skirts	Various	£956.52	£1,100.00
Stainless steel tailpipe trims.* For 4-cylinder models. Enhances the exterior appearance and styling of the twin rear tailpipes	8K0071761	£46.96	£54.00
Roof bars. Provides a stable base for a variety of touring attachments and incorporates an anti-theft locking mechanism	Various	Please consult your Audi Centre for pricing	
480l ski and luggage box. Lockable and can be opened from both sides. Capacity approx. 450 litres. Must be used in conjunction with the roof bar set	4L0071175	£382.61	£440.00
Chrome grille trims, enhances the appearance and styling of the Audi A4 single-frame grille	8K0071360ZZ	£63.48	£73.00
Front mud flaps.* Protects the underbody, bumpers and rear of the A4 from severe dirt and stone impacts. Also reduces spray water	8K0075111	£25.22	£29.00
Rear mud flaps.* As above	8K0075101	£25.22	£29.00
Luggage compartment liner – Semi-rigid. High-edged, water-light, flexible plastic liner which is perfect for keeping the Audi A4 luggage compartment clean	Various	£51.30	£59.00
Front rubber floor mats with A4 logo. Durable and easy-to-clean front rubber floor mats protect the vehicle's interior from dirt and moisture. Available in black or grey	Various	£25.22	£29.00
Rear rubber floor mats. As above, no logo. Available in black or grey	Various	£16.52	£19.00



19 x 8.5J '5-arm hollow-spoke' design anthracite polished



Exterior body styling package



Chrome grille trims

A4 Saloon and Avant Centre-fitted accessories

	Part number	Basic RRP	Total RRP ^{inc. VAT}
Remote SIM access profile Bluetooth adaptor. An enhancement of the factory-fitted option "Mobile phone preparation - Low". It enables mobile phone handsets to connect to the phone preparation via Bluetooth remote SIM Access Profile (rSAP). When handsets are connected, the adaptor enables the use of the external GSM car antenna and deactivates the handset antenna in order to minimise GSM radiation in the car and handset battery consumption. The handset is put into standby mode so battery power drain is minimal. Once connected, the adaptor connects to the handset automatically and details of up to four handsets can be saved. Only handsets with Bluetooth rSAP functionality are compatible with this adaptor	8P0051440	£254.78	£293.00
CobraTrak Q tracking device. Thatcham Category TOA rated tracking device that uses GPS and GSM technology to accurately pinpoint the location of a vehicle in up to 36 European countries in the event of theft. Price shown includes one year's subscription to the CobraTrak service	ZGB000054996A	Please consult your Audi Centre for pricing	
CobraTrak Q Attivo tracking device. Includes all the benefits of the CobraTrak Q listed above with the additional advantage of allowing the owner web-based tracking across Europe. Features include: time and distance tracking, positional updates to a mobile phone or fax machine and a user self-setting transport mode. Price shown includes one year's subscription to the CobraTrak Attivo service, and £10 SMS credit	ZGB000054996B	Please consult your Audi Centre for pricing	
Road Angel Professional Connected. Gives you access to the UK's number-one safety camera and accident blackspot database as you drive. It is the world's first Connected safety camera and blackspot alert device which uses a built-in SIM card and GPRS/GSM technology to enable UK-wide safety camera location updates every few minutes. The Road Angel Professional Connected is operated via remote control and has a full colour screen that can be customised to your taste. Includes a built-in rechargeable battery with up to 8 hours' battery life	ZGB000052916A*	£256.51	£294.99



Remote SIM access profile Bluetooth adaptor



CobraTrak



Road Angel Professional Connected

*Subsequent subscription charges apply, £4.99 per month payable by Direct Debit, minimum 12 months' contract is required. Includes free trial period of tracking function, additional subscription required for ongoing use. Please note: Road Angel products are only covered by a 1-year warranty. Road Angel warranty terms and conditions can be found at www.roadangel.co.uk.



Every Audi is intrinsically exclusive. It's the breathtaking design, the exceptional engineering, the Vorsprung durch Technik. But for that added element of exclusivity – that distinguishing look that sets you apart from the rest – you can specify your new A4 with options from Audi exclusive. Whether you want a completely unique, custom-mixed paint colour or seats in a combination of complementary shades, Audi exclusive will enable you to drive the car you've always imagined.

For more information on any of the options over the following pages or to view swatches, simply ask a member of staff at your local Audi Centre.



Upholstery

With Audi exclusive, you can choose between Fine Nappa leather and Alcantara, depending on the texture and flexibility you prefer in your car's upholstery. And once that's decided, you can specify your seats in an array of different colours shown to the left.

Choose just one all-over shade for each seat, or for a sportier look, customise each panel in two or more complementary colours from the distinctive Audi exclusive palette shown here. You can even choose the colour of the decorative stitching – to match or contrast with your chosen upholstery – from this varied collection. Whatever combination you decide upon, you're guaranteed to be extremely comfortable with the result.



	Standard	SE	Executive SE	S line	Executive S line	A4 allroad	S4 quattro*	Basic RRP	Total RRP ^{inc. VAT}
Valcona leather – front and back seats, head restraints, door trim inserts, front centre armrest (if ordered), seat side trims and add-on seat parts are leather-covered and colour-coordinated (only in conjunction with interior code "GD")	-	•	•	•	•	-	•	£3,191.30	£3,670.00
Valcona leather/Alcantara – front and back seats, head restraints, door trim inserts, front centre armrest (if ordered), seat side trims and add-on seat parts are leather-covered and colour-coordinated (only in conjunction with interior code "GD". Cannot be combined with Comfort front seats)	-	•	•	•	•	-	•	£3,191.30	£3,670.00
Valcona leather – front and back seats, head restraints, door trim inserts, front and rear centre armrest, seat side trims and add-on seat parts are leather-covered and colour-coordinated (only in conjunction with interior code "GD")	-	•	•	•	•	-	•	£3,617.39	£4,160.00

*Not available in Alcantara.
 - = Not available • = Available

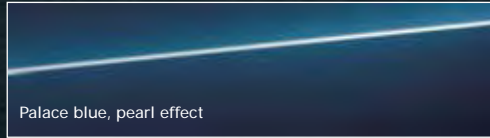

Palace blue, pearl effect

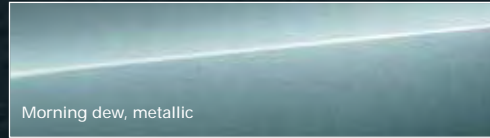

Morning dew, metallic

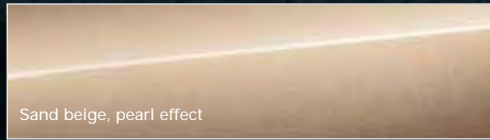

Sand beige, pearl effect

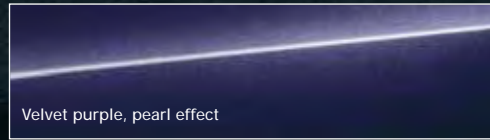

Velvet purple, pearl effect



Oak green, metallic

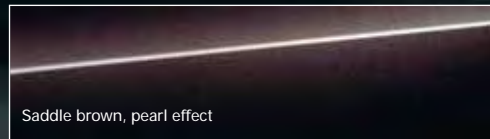

Saddle brown, pearl effect

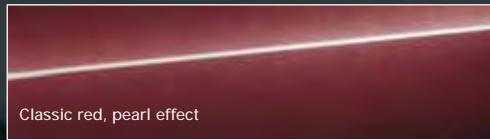

Classic red, pearl effect

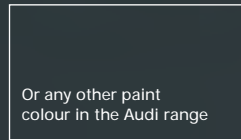

Or any other paint colour in the Audi range

Paint

Everyone has a favourite colour. No matter what yours is, Audi exclusive provides a range of unique colours that have been designed to set your car apart. Choose from the swatches here, or specify any other paint colour in the Audi range – whether it's Jet blue from the Audi R8 or Alpine white from the original Audi quattro®. The choice is yours.

Standard	SE	Executive SE	S line	Executive S line	A4 allroad	S4 quattro*	Basic RRP	Total RRP ^{inc. VAT}
•	•	•	•	•	-	•	£1,447.83	£1,665.00



Customised paint

In a car made from Vorsprung durch Technik, there are no compromises. So if you have a particular colour in mind, we'll mix the exact metallic or pearl-effect shade you want.

Standard	SE	Executive SE	S line	Executive S line	A4 allroad	S4 quattro*	Basic RRP	Total RRP ^{inc. VAT}
•	•	•	•	•	-	•	£2,043.48	£2,350.00

Inlays

Inlays are the all-important 'finishing touch' that add flair and interest to the surfaces inside your car. So Audi exclusive have sourced a hugely varied range of materials from which to craft these elements – from Oak sepia to rich Quilted maple wood. You can even customise your gear knob with one of a choice of woods, all of which are shown opposite.

	Basic RRP	Total RRP <small>inc. VAT</small>
Inlays	£639.13	£735.00

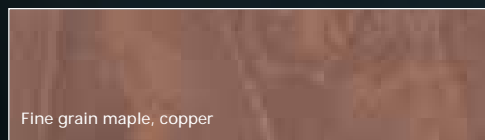

Fine grain maple, copper

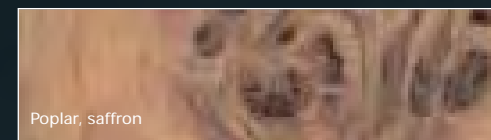

Poplar, saffron

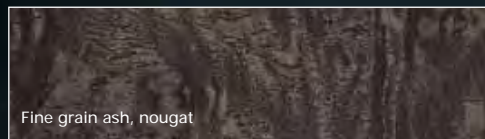

Fine grain ash, nougat

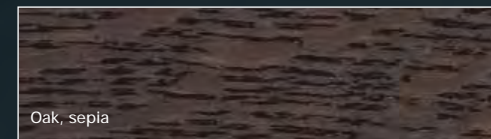

Oak, sepia



Fine grain myrtle, nutmeg



Quilted maple, gold

Steering wheels and controls pack

Our fingertips and palms contain more touch receptors than any other part of our body – so shouldn't the parts of our car we handle the most also be the most pleasing to touch? With this in mind, Audi exclusive enables you to customise the steering wheel of your choice in smooth, warm leather, in any of the colours shown on page 51. As with Audi exclusive seats, you even have free choice on the colour of the decorative stitching used. Choose a controls pack and you can extend this exclusive look and feel to your car's handbrake, gearknob and gaiter too.

	Standard	SE	Executive SE	S line	Executive S line	A4 allroad	S4 quattro*	Basic RRP	Total RRP inc. VAT
Steering wheel	-	•	•	•	•	-	•	£300.00	£345.00
Steering wheel – part-wood, part-leather	-	•	•	•	•	-	•	£508.70	£585.00
Controls pack	-	•	•	•	•	-	•	£508.70	£585.00



Carpets and floor mats

Exclusivity isn't just about choice and individuality – it's about attention to every detail in your A4; and for us, that includes the carpets and floor mats. First, choose from eleven different colours of high-quality velour carpets. Next, choose the colour of your car's floor mats from the same list, whilst using the palette of Audi upholstery colours detailed on page 51 to select a leather colour for the mats' decorative leather piping – matched or contrasting, depending on your personal taste. Floor mats are included when you order Audi exclusive carpet; but if you wish, they can also be purchased separately in a set of four.

	Standard	SE	Executive SE	S line	Executive S line	A4 allroad	S4 quattro*	Basic RRP	Total RRP inc. VAT
Carpets	-	•	•	•	•	-	•	£721.74	£830.00
Floor mats	-	•	•	•	•	-	•	£256.52	£295.00

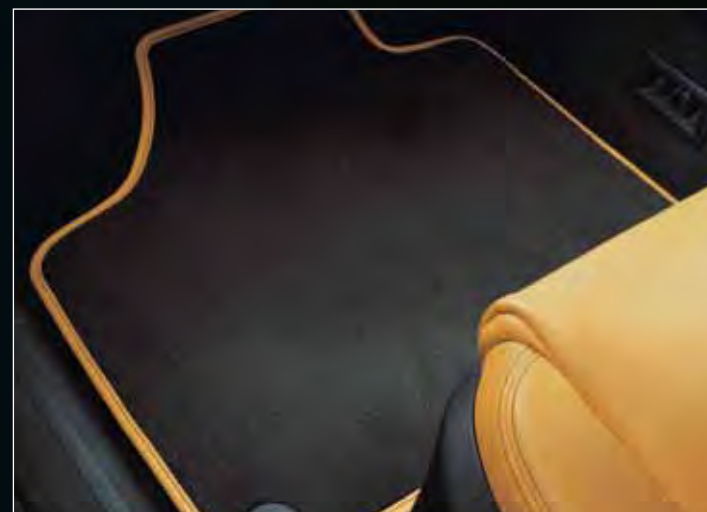

Technical data

A4 Saloon

Petrol

Engine	Cylinder	Displacement, cubic cm (valves per cylinder)	Max. power ¹ , PS	Max. torque, Nm at rpm	Transmission	CO ₂ emissions ² , g/km	0-62mph acceleration, seconds	Top speed, mph	ABI insurance group
1.8 TFSI	4-cylinder	1798	120	230/1500-3650	6-speed manual	164	10.5	130	11E
1.8 TFSI	4-cylinder	1798	160	250/1500-4500	6-speed manual	164	8.6	140	14E
1.8 TFSI	4-cylinder	1798	160	250/1500-4500	multitronic®	169	8.6	140	14E
2.0 TFSI	4-cylinder	1984	211	350/1500-4200	6-speed manual	149	6.9	155	15E
2.0 TFSI	4-cylinder	1984	211	350/1500-4200	multitronic®	167	6.9	150	15E
2.0 TFSI quattro®	4-cylinder	1984	211	350/1500-4200	6-speed manual	169	6.6	153	16E
2.0 TFSI quattro®	4-cylinder	1984	211	350/1500-4200	7-speed S tronic	172	6.5	150	16E
3.2 FSI	V6	3197	265	350/3000-5000	multitronic®	194	6.5	155	16E
3.2 FSI quattro®	V6	3197	265	330/3000-5000	6-speed manual	213	6.2	155	16E
3.2 FSI quattro®	V6	3197	265	330/3000-5000	tiptronic®	215	6.4	155	16E
S4 quattro®	V6	2995	333	440/2900-5300	6-speed manual	225	5.1	155	18E
S4 quattro®	V6	2995	333	440/2900-5300	7-speed S tronic	219	5.3	155	18E

Diesel

2.0 TDI	4-cylinder	1968	120	290/1750-2500	6-speed manual	129	10.7	127	11E
2.0 TDI	4-cylinder	1968	143	320/1750-2500	6-speed manual	134	9.4	134	12E
2.0 TDI	4-cylinder	1968	143	320/1750-2500	multitronic®	149	9.4	134	12E
2.0 TDI	4-cylinder	1968	170	350/1750-2500	6-speed manual	134	8.3*	143	14E
2.0 TDI quattro®	4-cylinder	1968	170	350/1750-2500	6-speed manual	149	8.3*	140	14E
2.7 TDI	V6	2698	190	400/1400-3250	multitronic®	167	7.7	140	15E
3.0 TDI quattro®	V6	2967	240	500/1500-3000	6-speed manual	172	6.1	155	16E
3.0 TDI quattro®	V6	2967	240	500/1500-3000	tiptronic®	182	6.2	155	16E

*Provisional data.

¹The given value was obtained in accordance with the specified measurement procedure (the respective current version of the Directive 80/1269/EEC).

²The given values were calculated in accordance with the specified measurement procedure (the respective current version of Directive 80/1268/EEC). This information does not relate to a single vehicle and does not comprise part of the offer but is merely intended for the purpose of comparison between the different vehicle types.

Technical data

Unladen weight ³	Weights, kg		Max. trailer load ⁴ , kg			Volumes		Fuel tank capacity approx, litres	Fuel consumption, mpg (l/100km)		
	Gross weight limit	Roof load limit/nose weight	unbraked	with 12% gradient	with 8% gradient	Luggage compartment capacity, litres	Rear seats upright		Rear seats folded	Urban	Extra Urban
1410	1960	75/80	740	1300	1500	480	962	65	28.5 (9.9)	51.4 (5.5)	39.8 (7.1)
1410	1960	75/80	740	1300	1500	480	962	65	29.4 (9.6)	49.6 (5.7)	39.8 (7.1)
1410	1960	75/80	740	1300	1500	480	962	65	30.1 (9.4)	47.9 (5.9)	39.2 (7.2)
1440	1990	75/80	750	1500	1700	480	962	65	34.0 (8.3)	53.3 (5.3)	44.1 (6.4)
1475	1985	75/80	750	1500	1700	480	962	65	30.1 (9.4)	50.4 (5.7)	39.8 (7.1)
1525	2075	75/80	750	1700	1900	480	962	65	29.1 (9.7)	48.7 (5.8)	38.7 (7.3)
1550	2050	75/80	750	1700	1900	480	960	64	30.4 (9.3)	44.8 (6.3)	38.2 (7.4)
1530	TBC	75/80	TBC	TBC	TBC	480	962	65	25.2 (12.2)	44.1 (6.2)	34.4 (8.4)
1580	2130	75/80	750	1900	2100	480	962	64	21.7 (13.0)	42.8 (6.6)	31.7 (8.9)
1610	2165	75/80	750	1900	2100	480	962	64	21.7 (13.0)	42.2 (6.7)	31.4 (9.0)
1650	2200	90/80	750	1900	2100	480	962	64	20.6 (13.7)	38.7 (7.3)	29.1 (9.7)
1685	2235	90/80	750	1900	2100	480	962	64	20.9 (13.5)	40.4 (7.0)	30.1 (9.4)
1470	2020	75/80	750	1300	1500	480	962	65	45.6 (6.2)	67.3 (4.2)	57.6 (4.9)
1465	2015	75/80	750	1700	1900	480	962	65	43.5 (6.5)	65.7 (4.3)	55.4 (5.1)
1495	2045	75/80	750	1700	1900	480	962	65	36.2 (7.8)	60.1 (4.7)	48.7 (5.8)
1465	2015	75/80	750	1600*	1800*	480	962	65	45.6 (6.2)	64.2 (4.4)	55.4 (5.1)
1560	2020	75/80	750	1600*	1800*	480	962	64	39.8 (7.1)	57.6 (4.9)	49.6 (5.7)
1595	2145	75/80	750	1700	1900	480	962	65	36.2 (7.8)	51.4 (5.5)	44.1 (6.4)
1655	2205	75/80	750	1900	2100	480	962	64	32.1 (8.8)	53.3 (5.3)	42.8 (6.6)
1690	2240	75/80	750	1900	2100	480	962	64	32.8 (8.6)	47.9 (5.9)	40.9 (6.9)

³Vehicle's unladen weight without driver (calculated in accordance with the current version of Directive 80/1268/EEC). The fitting of additional equipment may increase the vehicle's unladen weight and drag coefficient, whereupon the potential carrying capacity and top speed will be correspondingly reduced.

⁴The engine's power output always goes down with increasing altitude. At 1,000m above sea level, and for every additional 1,000m, deduct 10% from the weight of the outfit (trailer load limit + gross weight of the towing vehicle).

Technical data

A4 Avant

Petrol

Engine	Cylinder	Displacement, cubic cm (valves per cylinder)	Max. power ¹ , PS	Max. torque, Nm at rpm	Transmission	CO ₂ emissions ² , g/km	0-62mph acceleration, seconds	Top speed, mph	ABI insurance group
1.8 TFSI	4-cylinder	1798	120	230/1500-3650	6-speed manual	169	10.8	128	11E
1.8 TFSI	4-cylinder	1798	160	250/1500-4500	6-speed manual	169	8.9	140	14E
1.8 TFSI	4-cylinder	1798	160	250/1500-4500	multitronic®	174	8.9	138	14E
2.0 TFSI	4-cylinder	1984	211	350/1500-4200	6-speed manual	154	7.1	150	15E
2.0 TFSI	4-cylinder	1984	211	350/1500-4200	multitronic®	172	6.9	150	15E
2.0 TFSI quattro®	4-cylinder	1984	211	350/1500-4200	6-speed manual	169	6.7	148	16E
2.0 TFSI quattro®	4-cylinder	1984	211	350/1500-4200	7-speed S tronic	175	6.6	145	16E
3.2 FSI	V6	3197	265	350/3000-5000	multitronic®	199	6.6	155	16E
3.2 FSI quattro®	V6	3197	265	330/3000-5000	6-speed manual	216	6.4	155	16E
3.2 FSI quattro®	V6	3197	265	330/3000-5000	tiptronic®	219	6.6	155	16E
S4 quattro®	V6	2995	333	440/2900-5300	6-speed manual	229	5.2	155	18E
S4 quattro®	V6	2995	333	440/2900-5300	7-speed S tronic	224	5.4	155	18E

Diesel

2.0 TDI	4-cylinder	1968	120	290/1750-2500	6-speed manual	134	11.2	122	11E
2.0 TDI	4-cylinder	1968	143	320/1750-2500	6-speed manual	139	9.7	130	12E
2.0 TDI	4-cylinder	1968	143	320/1750-2500	multitronic®	155	9.7	125	12E
2.0 TDI	4-cylinder	1968	170	350/1750-2500	6-speed manual	144	8.6*	140	14E
2.0 TDI quattro®	4-cylinder	1968	170	350/1750-2500	6-speed manual	154	8.6*	138	14E
2.7 TDI	V6	2698	190	400/1400-3250	multitronic®	169	8.3	140	15E
3.0 TDI quattro®	V6	2967	240	500/1500-3000	6-speed manual	176	6.3	155	16E
3.0 TDI quattro®	V6	2967	240	500/1500-3000	tiptronic®	186	6.3	155	16E

*Provisional data.

¹The given value was obtained in accordance with the specified measurement procedure (the respective current version of the Directive 80/1269/EEC).

²The given values were calculated in accordance with the specified measurement procedure (the respective current version of Directive 80/1268/EEC). This information does not relate to a single vehicle and does not comprise part of the offer but is merely intended for the purpose of comparison between the different vehicle types.

Technical data

Unladen weight ³	Weights, kg		Max. trailer load ⁴ , kg			Luggage compartment capacity, litres		Fuel tank capacity approx, litres	Fuel consumption, mpg (l/100km)		
	Gross weight limit	Roof load limit/nose weight	unbraked	with 12% gradient	with 8% gradient	Rear seats upright	Rear seats folded		Urban	Extra Urban	Combined
1470	2040	90/80	750	1300	1500	490	1430	65	29.4 (9.6)	48.7 (5.8)	39.2 (7.2)
1470	2040	90/80	750	1300	1500	490	1430	65	29.4 (9.6)	48.7 (5.8)	39.2 (7.2)
1510	2080	90/80	750	1300	1500	490	1430	65	29.4 (9.6)	46.3 (6.1)	38.2 (7.4)
1500	2070	90/80	750	1500	1700	490	1430	65	33.6 (8.4)	50.4 (5.6)	42.8 (6.6)
1530	2065	90/80	750	1500	1700	490	1430	65	29.1 (9.8)	47.9 (5.9)	38.7 (7.3)
1570	2140	90/80	750	1700	1900	490	1430	65	29.1 (9.7)	48.7 (5.8)	38.7 (7.3)
1605	2175	90/80	750	1700	1900	490	1430	64	30.1 (9.4)	43.5 (6.5)	37.2 (7.6)
1590	TBC	90/80	TBC	TBC	TBC	490	1430	65	24.8 (12.3)	42.2 (6.5)	33.6 (8.6)
1630	2200	90/80	750	1900	2100	490	1430	64	21.7 (13.0)	41.5 (6.8)	31.0 (9.1)
1660	2230	90/80	750	1900	2100	490	1430	64	21.6 (13.1)	40.9 (6.9)	30.7 (9.2)
1705	2275	90/80	750	1900	2100	490	1430	64	20.5 (13.8)	37.7 (7.5)	28.5 (9.9)
1735	2305	90/80	750	1900	2100	490	1430	64	20.6 (13.7)	39.2 (7.2)	29.4 (9.6)
1530	2100	90/80	750	1300	1500	490	1430	65	44.8 (6.3)	62.8 (4.5)	55.4 (5.1)
1525	2095	90/80	750	1700	1900	490	1430	65	42.8 (6.6)	62.8 (4.5)	53.3 (5.3)
1555	2125	90/80	750	1700	1900	490	1430	65	37.7 (7.5)	54.3 (5.2)	47.1 (6.0)
1525	2095	90/80	750	1600*	1800*	490	1430	65	42.2 (6.2)	60.1 (4.7)	51.4 (5.5)
1600	2170	90/80	750	1600*	1800*	490	1430	65	39.8 (7.1)	55.4 (5.1)	48.7 (5.8)
1620	2190	90/80	750	1600	1800	490	1430	65	36.7 (7.7)	48.7 (5.8)	43.5 (6.5)
1695	2265	90/80	750	1900	2100	490	1430	64	31.7 (8.9)	50.4 (5.6)	41.5 (6.8)
1695	2265	90/80	750	1900	2100	490	1430	64	31.7 (8.9)	45.6 (6.2)	39.2 (7.2)

³Vehicle's unladen weight without driver (calculated in accordance with the current version of Directive 80/1268/EEC). The fitting of additional equipment may increase the vehicle's unladen weight and drag coefficient, whereupon the potential carrying capacity and top speed will be correspondingly reduced.

⁴The engine's power output always goes down with increasing altitude. At 1,000m above sea level, and for every additional 1,000m, deduct 10% from the weight of the outfit (trailer load limit + gross weight of the towing vehicle).

Technical data

A4 allroad

Petrol									
Engine	Cylinder	Displacement, cubic cm (valves per cylinder)	Max. power ¹ , PS	Max. torque, Nm at rpm	Transmission	CO ₂ emissions ² , g/km	0-62mph acceleration, seconds	Top speed, mph	ABI insurance group
2.0 TFSI quattro®	4-cylinder	1984	211	350/1500-4200	7-speed S tronic	189	6.9	144	TBC

Diesel

2.0 TDI quattro®	4-cylinder	1968	170	350/1750-2500	6-speed manual	164	8.9	133	TBC
3.0 TDI quattro®	V6	2967	240	500/1500-3000	7-speed S tronic	189	6.4	148	TBC

*Provisional data.

¹The given value was obtained in accordance with the specified measurement procedure (the respective current version of the Directive 80/1269/EEC).

²The given values were calculated in accordance with the specified measurement procedure (the respective current version of Directive 80/1268/EEC). This information does not relate to a single vehicle and does not comprise part of the offer but is merely intended for the purpose of comparison between the different vehicle types.

Technical data

Unladen weight ³	Weights, kg		Max. trailer load ⁴ , kg			Volumes		Fuel tank capacity approx, litres	Fuel consumption, mpg (l/100km)		
	Gross weight limit	Roof load limit/nose weight	unbraked	with 12% gradient	with 8% gradient	Luggage compartment capacity, litres	Rear seats upright		Rear seats folded	Urban	Extra Urban
1650	2220	90/80	750	1700	1900	490	1430	64	27.7 (10.2)	41.5 (6.8)	34.9 (8.1)
1630	2200	90/80	750	1700	1900	490	1430	64	37.7 (7.5)	51.4 (5.5)	45.2 (6.2)
1730	2300	90/80	750	1900	2100	490	1430	64	32.5 (8.7)	46.3 (6.1)	39.8 (7.1)

³Vehicle's unladen weight without driver (calculated in accordance with the current version of Directive 80/1268/EEC). The fitting of additional equipment may increase the vehicle's unladen weight and drag coefficient, whereupon the potential carrying capacity and top speed will be correspondingly reduced.

⁴The engine's power output always goes down with increasing altitude. At 1,000m above sea level, and for every additional 1,000m, deduct 10% from the weight of the outfit (trailer load limit + gross weight of the towing vehicle).

Dimensions

A4 Saloon

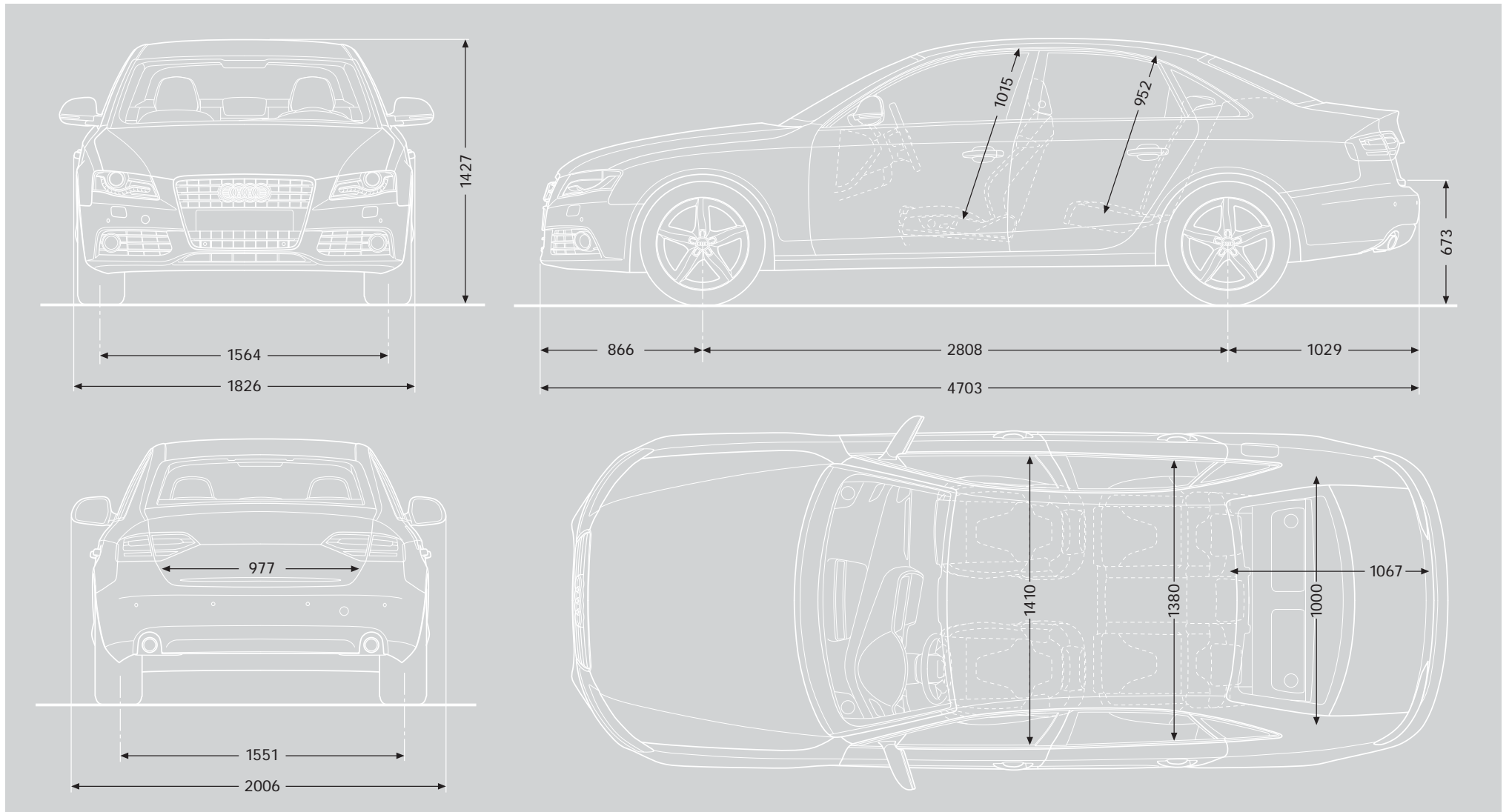

Dimensions were measured with vehicle at unladen weight, ground clearance measured with vehicle carrying its maximum load. Luggage compartment volume in litres: 480/962 (measured by the VDA standard test method using 200 x 100 x 50mm blocks; second value: with rear seat folded down). Turning circle approx 11.4m.

Dimensions in millimetres.
*Maximum headroom.

Dimensions

A4 Avant

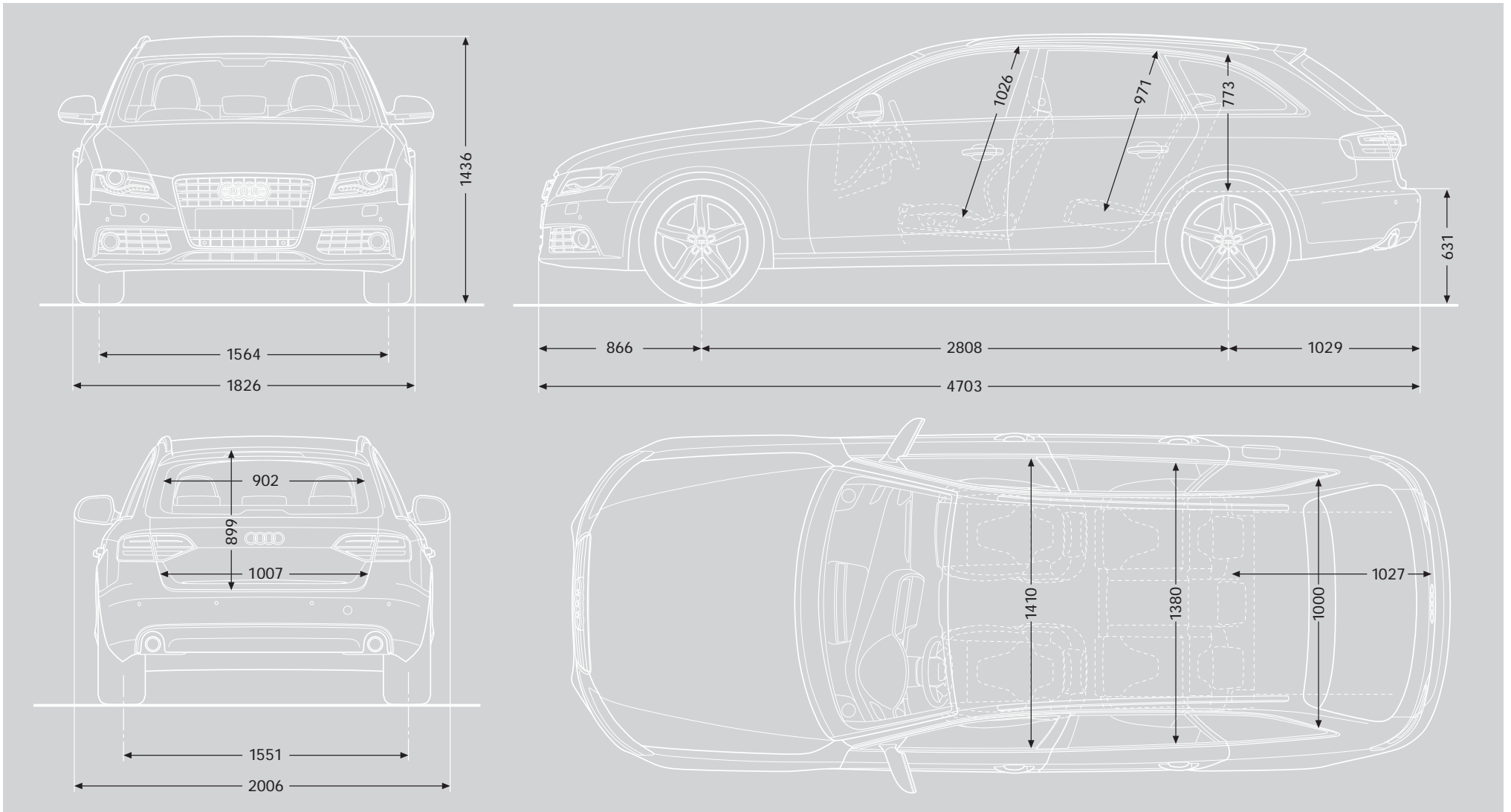

Dimensions were measured with vehicle at unladen weight, ground clearance measured with vehicle carrying its maximum load. Luggage compartment volume in litres: 490/1430 (measured by the VDA standard test method using 200 x 100 x 50mm blocks; second value: with rear seat folded down). Turning circle approx 11.4m.

Dimensions in millimetres.
*Maximum headroom.

Dimensions

A4 allroad

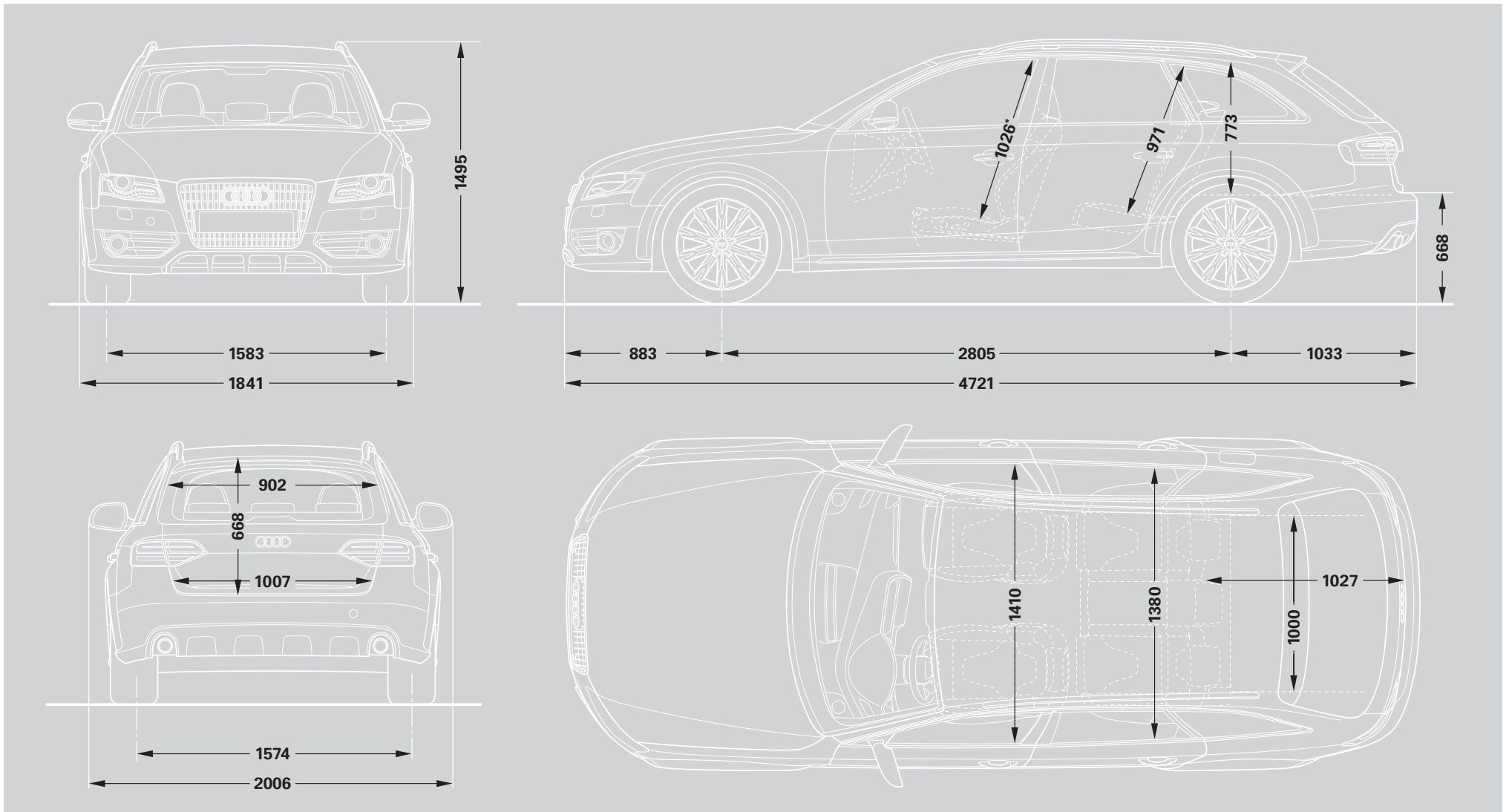

Dimensions were measured with vehicle at unladen weight, ground clearance measured with vehicle carrying its maximum load. Luggage compartment volume in litres: 490/1430 (measured by the VDA standard test method using 200 x 100 x 50mm blocks; second value: with rear seat folded down). Turning circle approx 11.4m.

Dimensions in millimetres.
*Maximum headroom.

Dimensions

S4 quattro® Saloon

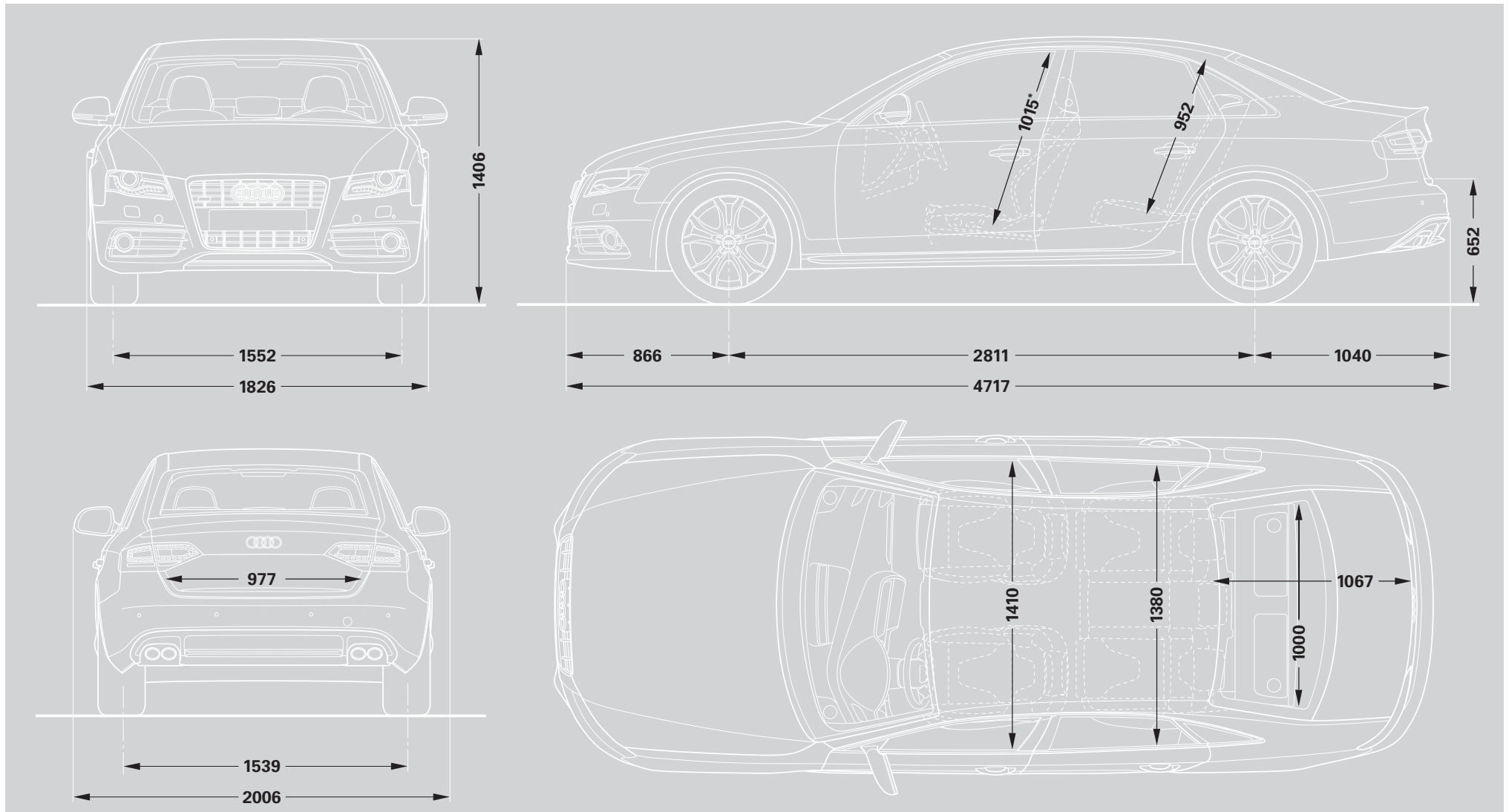

Dimensions were measured with vehicle at unladen weight, ground clearance measured with vehicle carrying its maximum load. Luggage compartment volume in litres: 480/962 (measured by the VDA standard test method using 200 x 100 x 50mm blocks; second value: with rear seat folded down). Turning circle approx 11.4m.

Dimensions in millimetres.
*Maximum headroom.

Dimensions

S4 quattro® Avant

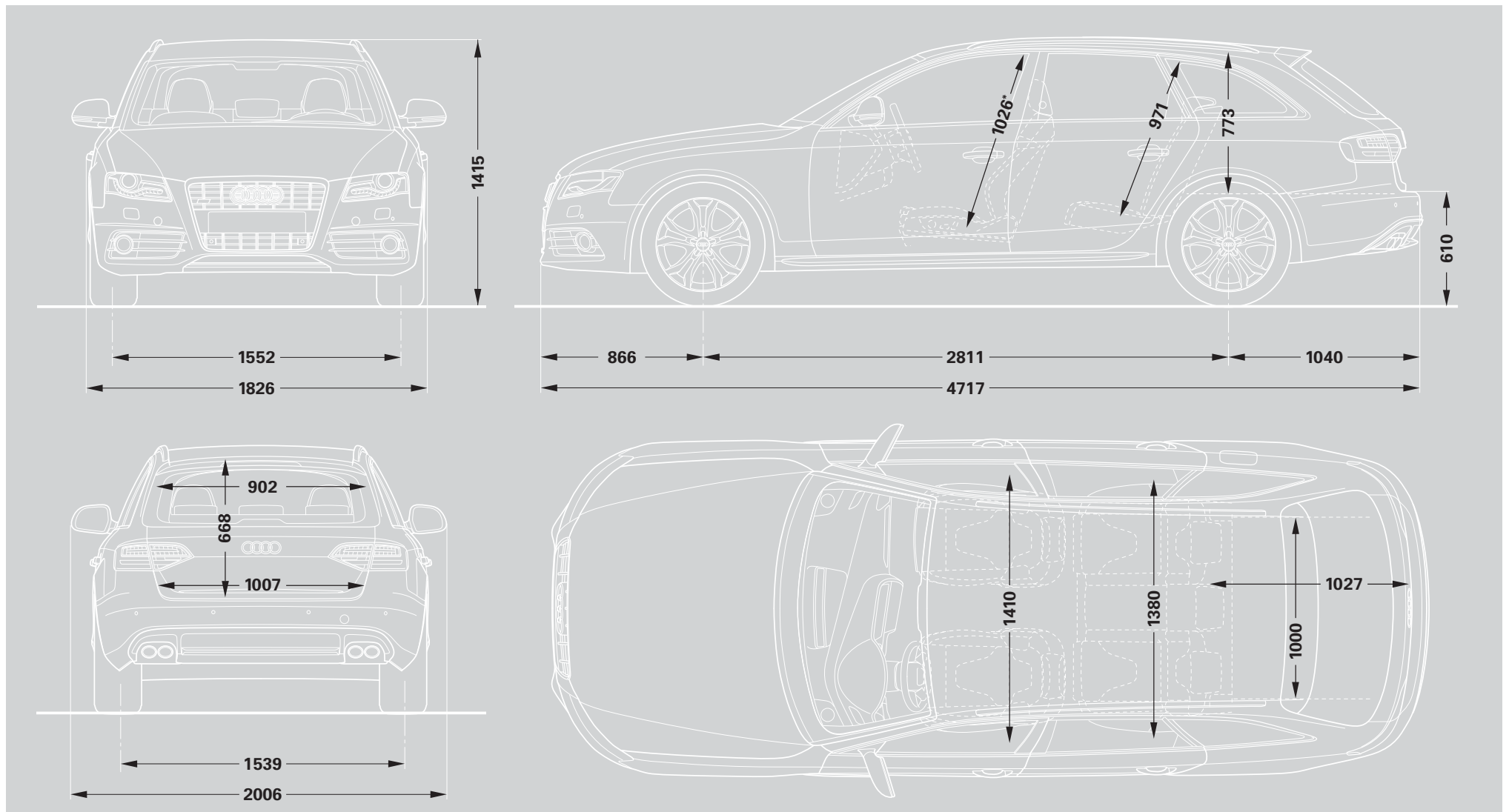

Dimensions were measured with vehicle at unladen weight, ground clearance measured with vehicle carrying its maximum load. Luggage compartment volume in litres: 490/1430 (measured by the VDA standard test method using 200 x 100 x 50mm blocks; second value: with rear seat folded down). Turning circle approx 11.4m.

Dimensions in millimetres.
*Maximum headroom.

Additional information

CO₂ data and information

CO₂ emissions-based Vehicle Excise Duty

Vehicle Excise Duty (Road Fund Licence) is based upon the amount of Carbon Dioxide (CO₂) a vehicle emits, measured in grams per kilometre (g/km). The DVLA has created seven categories:

Petrol and Diesel engines	
A – up to 100g/km	£0.00
B – 101 to 120g/km	£35.00
C – 121 to 150g/km	£120.00
D – 151 to 165 g/km	£145.00
E – 166 to 185 g/km	£170.00
F – 186 to 225g/km	£210.00
G – over 225g/km	£400.00

Audi Service

Servicing tailored to your needs

Regular servicing is key to safeguarding your Audi's performance and a full Audi service history could help you preserve the future re-sale value. To make servicing easy, the Audi Service Schedules have been designed to work with your individual driving style and vehicle.

There are two schedules available and your Audi Centre will advise which schedule is most suited to your needs. The conventional fixed Audi Inspection Service schedule

Inspection Service Schedule

Vehicle usage:	
Mileage	Less than 10,000* miles per annum
Type of journey	Mainly city/town centre driving. Short journeys
Conditions	Frequent cold starts. High engine loading – e.g. frequent hill climbs, vehicle fully loaded, towing
Driving style	Uneconomical – e.g. heavy acceleration, heavy braking, constant changes in speed, constant use of high revs, 'sporty' driving

Fixed Audi Inspection Service Intervals:	
Oil-change Service	Fixed to every 10,000* miles/1 year
Inspection Service	Fixed to every 20,000* miles/3 years, then every 20,000* miles/2 years thereafter

has fixed intervals for the Oil Change and Inspection Service that are based on time and distance, whichever comes first. With the Audi LongLife Service schedule, sensors take account of driving style and conditions in which the vehicle is used to indicate when the Oil Change Service is required. Oil Change Service intervals are therefore variable and are conveniently indicated via the on-board service interval display.

LongLife Service Regime

Vehicle usage:	
Mileage	More than 30 miles per day
Type of journey	Motorway and main road driving. Mainly longer distance journeys. Constant speeds
Conditions	Normal engine loading – e.g. with little or no towing, with little or no hill climbs. Normal vehicle loading
Driving style	Moderate acceleration, moderate braking, engine revs mainly below 3,000

Audi LongLife Service Intervals:	
Oil-change Service	Variable to a maximum of every 20,000* miles/2 years
Inspection Service	Fixed to every 20,000* miles/3 years, then every 20,000* miles/2 years thereafter

*As indicated by the service interval display. Mileages are approximate as the Service Indicator system uses kilometres as its distance measurement.

Additional information

Service by Design

At Audi, we believe our customers have the right to expect excellent service each and every time they make contact with us. To ensure that this happens, we have agreed a set of service standards with our Audi Centre network that governs the way they do business with you. These standards apply to both Sales and Aftersales, and we actively monitor our Centres to ensure that you receive the highest level of customer service. These service standards will ensure a consistent, stress-free experience whenever you are in contact with anyone representing the Audi brand.

Every Audi Centre will be open during the following hours:

Sales: 9am-6pm Monday to Friday
9am-5pm Saturday

Service: 8am-6pm Monday to Friday
8.30am-1pm Saturday

Sunday opening at local discretion.

Test drives

Whilst we cannot always have the desired demonstrator car ready immediately, we will confirm arrangements for a test drive within two working days (subject to status).

New Car delivery

Once we have confirmed a delivery date with you, we will keep you informed of progress. In the unlikely event of a delay, we will provide you with a courtesy car to minimise inconvenience and keep you mobile.

Delivery to any location within the UK

To maximise your Audi experience right from the first day of ownership, we will deliver your car to your preferred location – whether that's home or your place of work (subject to reasonable notice).

Every attention to detail

Your ownership experience starts with half a tank of fuel.

Quotation response

We are committed to answering any quotation request within 1 working day.

Training

We run a continuous training development programme for all our staff so that we consistently deliver a high-quality, professional service.

Formal complaints procedure

We have a complaints procedure designed to ensure any negative issue you raise with us is dealt with properly.

Service bookings

If you do not require a courtesy car, we will service your Audi within a maximum of 5 working days. If you do choose to take a courtesy car, we will promise to service your vehicle within a maximum of 10 working days.

Cleaning

When your car comes to our workshop, we will wash and vacuum it at no extra cost.

No hidden charges

You will be consulted before we carry out any necessary work on your vehicle, and anything charged for will be itemised on your bill. No extra work will be undertaken without your permission.

A personal service

All work will be done by a named Audi Technician, to whom you can personally direct questions or requests should you need to.

Environmental commitment

We promise to dispose of all non-biodegradable materials from your vehicle in a responsible manner.



Additional information

Pricing information

Pricing

Prices and specifications given are correct at the time of printing. Always check details with your Audi Centre, as Audi policies are continually developing. We reserve the right to change prices or specifications at any time.

All prices are subject to VAT, currently charged at 15%.

Delivery charges and number plates are not included in the vehicle price.

<u>Delivery charge</u>	<u>£471.30</u>
<u>Number plates</u>	<u>£20.00</u>
<u>VAT</u>	<u>£73.70</u>
<u>Total</u>	<u>£565.00</u>

Audi Roadside Assistance

Your new car comes complete with complimentary roadside assistance and recovery across the UK provided by RAC Motoring Services. Also included is roadside assistance throughout Europe, managed by RAC Motoring Services.

Audi Customer Care

Every new Audi benefits from the comprehensive Audi Customer Care Package, which comprises:

- A 3-year Audi warranty, which covers you for unlimited mileage in the first 2 years of ownership, with a full mechanical and electrical warranty which covers you for up to 60,000 miles in the third year
- A 3-year paint warranty
- A 12-year anti-corrosion warranty
- Up to 3 years' UK roadside assistance and recovery

This package, together with Audi variable Service intervals, offers a combination unmatched by any other major manufacturer. Contact your Audi Centre for full details.

Audi Tax-Free Sales

If you are entitled to purchase a vehicle free of VAT, normally through Military or Diplomatic privilege, please contact your local Audi Centre for full details.

Should you have any difficulty obtaining the information you require, please call Freephone 0800 585878.

Audi Finance

Audi Finance specialise in providing funding solutions for Audi drivers. Whether your Audi is for private or business use, there are a range of funding options to choose from.

Below is the full range of finance products.

- Solutions – a Personal Contract Plan
- Hire purchase
- Lease purchase
- Finance lease
- Contract hire

With all products, you can choose a fixed-cost maintenance plan designed to help you budget accurately.

No matter what Audi model you choose, your local Audi Centre can provide you with a personalised quote which could fit your budget and motoring needs.

Audi Finance is a trading name of Volkswagen Financial Services (UK) Limited. An offer of finance depends on certain conditions.

Available to people over 18 in the UK only.

Audi Insurance

Competitive comprehensive motor insurance designed specially for Audi drivers. All new Audi models come with complimentary seven-day cover upon request – we'll email a cover note directly to your Audi Centre, enabling them to tax your car easily. This way, you can drive straight out of the showroom. Taking out an annual policy is easy and can begin as soon as your free seven-day cover expires.

For more information, contact your local Audi Centre. Alternatively, call 0800 051 3146 for a quote and to receive 7 days' complimentary cover for your new Audi.

Audi Insurance is underwritten and administered by Zurich Insurance Company.

Notes

Notes

Audi UK
Customer Services
Selectapost 29
Sheffield
S97 3FG
0800 699888
www.audi.co.uk

Specifications and prices subject
to change without notice.

© Audi (UK)

Printed in the UK
Edition 6.1. 04/09
2010 Model Year



FSC

Mixed Sources

Product group from well-managed
forests and other controlled sources

Cert no. TT-COC-002327

www.fsc.org

© 1996 Forest Stewardship Council