



The A8 and S8
Pricing and Specification Guide
Valid from May 2009



A User's Guide

This guide has been designed to help you tailor and price your chosen A8 model quickly and logically. At the back of this guide, you will also find information on CO2 emissions-based vehicle excise duty and the other services offered by Audi, including Finance and Insurance. If you wish, you can also go to audi.co.uk and configure your A8 online.

Tune into the Audi Channel at any time on Sky Guide No. 884 to see a whole range of programmes about the Audi range and our motorsport achievements



Table of content

	Page number
Introduction	
The A8	
Engines	6
quattro®	7
Model details and prices	
SE models	8
Long-wheelbase models	12
Sport models	14
S8 models	16
Transmission	18
Colour and upholstery	
Paint finishes	20
Upholstery options	22
Colour and trim guide	27
Inlays	29
Options	
Wheels, tyres and brakes	32
Audio and communication	36
Steering wheels	38
Safety and security	39
Seats	40
Interior equipment	42
Exterior equipment	44
Service plan	45
Audi exclusive	
Audi exclusive options	46
Technical details	
Technical data	54
Dimensions	56
Additional information	60



The Audi A8

Elegant, powerful and incredibly luxurious, the Audi A8 radiates confidence and poise, with its pure, masculine lines and muscular, athletic stance. There's an incredibly generous amount of cabin space, with opulent interior materials and equipment to deliver the ultimate driver and passenger comfort. Enhancing the driving dynamics is the latest-generation Audi Space Frame ASF® – an incredibly rigid structure which increases safety, handling and agility thanks to its lightweight aluminium construction. A wide choice of engines are available, including the optimised 3.0 TDI and 4.2 litre powerhouses. The extensive use of magnesium and aluminium components reduces engine weight to below 190kg, both aiding propulsion and reducing fuel consumption for an altogether more rewarding drive. The Audi A8 also features adaptive air suspension with variable damping – a system that automatically adjusts the suspension according to different road situations, guaranteeing a superb drive on any surface. Equally intuitive is the MMI Multi Media Interface – an integrated control logic which puts communications, entertainment and vehicle settings at your fingertips. Technology that works for you – just one benefit of driving the epitome of Vorsprung durch Technik.

Engines

Petrol

There are two kinds of engine available on this model – the standard petrol engine and the FSI® direct-injection engine. FSI® is a unique Audi technology, originally developed for the Le Mans 24-hour endurance race to deliver increased power and torque as well as enhanced fuel efficiency. The way it does this is, in theory, very simple. Fuel is injected directly into the combustion chambers, ‘unthrottling’ the engine, reducing heat-loss and increasing output – all whilst reducing fuel consumption and exhaust emissions. Ideal for the buyer who wants a sporty, exhilarating drive without the drawbacks of excessive fuel costs or high emissions-based taxation.

Diesel

All diesel engines from Audi are known as TDI®. This impressive technology was originally pioneered by Audi in 1989, marking a departure from the noisy, fuel-thirsty diesel engines of the past. Like its FSI® petrol counterpart, the TDI® diesel engine is designed for power and performance, with low fuel consumption and CO₂ emissions. The working principle of the TDI® engine is based upon precision and compression. A turbocharger supplies fresh air to the engine, ensuring optimum filling of the cylinder. Immediately after compression, an injector then delivers fuel into the combustion chambers at a very high pressure. The result – you get the most in terms of performance and economy from every drop of fuel that enters the tank.



quattro®

Permanent all-wheel-drive

Cars that deliver as much pulling power as the Audi A8 and S8 need a harness in place – a technology that delivers safety and control whilst enhancing the sporty characteristics which make them so thrilling to drive. That's why quattro® permanent all-wheel-drive comes as standard on all A8 and S8 models (except the 3.2 FSI® and 2.8 FSI® models). The principle is simple: in the same way that four brakes ensure better

deceleration, four permanently-driven wheels deliver better acceleration and road-holding. On quattro® models, drive power is continuously distributed between the front and rear axles depending on weather conditions, road surface and gradient. And what better technology to feature on this sporty model than the one that has given Audi the edge on the racetrack ever since it was first introduced over 25 years ago.

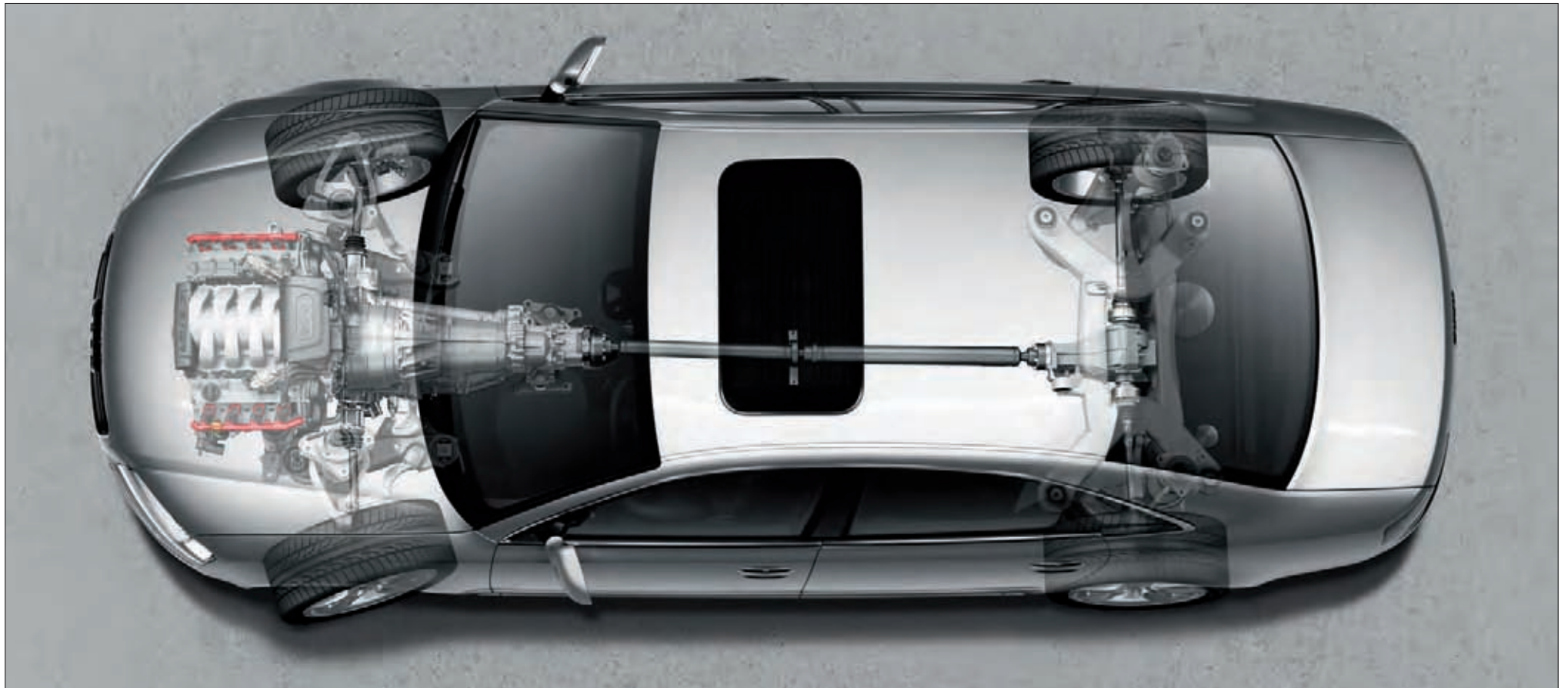

SE model equipment

All A8 and S8 models have the following items of Standard equipment:

Wheels, tyres and suspension

17 x 8J '7-spoke' alloy wheels with 235/55 R17 Y tyres
Full size spare wheel*

Audio and communication

Bluetooth mobile phone connection
Car instruction manual on CD-ROM
(for use with MMI system only)
CD changer (for 6 discs) located in glove compartment
Centre console with MMI terminal, air-conditioning controls,
ashtray and cigarette lighters
DAB digital radio
DSP sound system with 9 loudspeakers (230 Watt total output)
Hard-disk based Satellite Navigation System with TMC
functionality, voice control and advanced 3D mapping
MMI 3G Multi Media Interface with 7" high-resolution screen.
Please see page 37 for further details
Voice control system – key functions of MMI can be operated
by voice control

Seats

Active front head restraints
Front seats – electrically adjustable (14-way), including lumbar
support and memory for both seats
Heated front seats
Upholstery in Valcona leather with Alcantara
door-trim inserts

Safety and security

Advanced Key – access and authorisation system through
automatic data exchange between key and vehicle, allowing
the key to remain in the driver's pocket or bag at all times.
To unlock and open, simply lift the exterior door handle.
To lock, press the button on the handle. Pressing the
start/stop button integrated into the centre console starts and
stops the engine
Airbags, full-size, for driver and front passenger
Anti-theft alarm with tow-away protection including interior
monitoring (Thatcham Category 1 approved)
Child locks, electric for rear doors and windows
Electronic Differential Lock (EDL) traction control
Electronic Stability Program (ESP) networks the ABS, EBD, ASR
and EDL systems, ensuring greater stability at all speeds by
braking individual wheels as required and overriding the
engine-management system
First aid kit
Front passenger airbag deactivation
ISOFIX child-seat mounting (front-left and outer-rear seats)
Seat belts, 3-point for all seats, with front belt-force limiters
Seat belts (front) – electric height adjustment with memory
Side airbags front and rear
Side-impact protection in the doors
Sideguard head airbag system
Side protection strips (body-coloured) with aluminium
trim strips
Visible Vehicle Identification Number (VIN)
Warning triangle and tool kit



Interior equipment

Aluminium trim strips framing side windows and bumper details

Aluminium-look trim in the interior (including gear knob and gaiter)

Auto-dimming rear view mirror

Automatic 4-zone air-conditioning. Separate air distribution for front and rear passengers, with digital temperature displays, automatic air recirculation via air-quality sensor, combined pollutant and pollen filter and air-humidity sensor

Coat hooks, 2 recessed in rear roof area and one on each B-pillar

Comfort front centre armrest

Cruise control maintains any speed from approx. 20 mph

Cup holders, 2 at the front integrated into the centre console, 2 at the rear integrated into the rear centre armrest

Driver's Information System (DIS)

Electric front and rear windows

Exit lights and active reflectors on all doors

Floor mats, front and rear

Footwell lights at front and rear

Illuminated vanity mirrors integrated into the front sun visors

Inlays, wood trim in Walnut brown

Interior and exterior lighting package

Luggage net with four lashing eyes in the luggage compartment

Reading lights, 2 at front and 2 at rear

Servotronic steering – power steering with speed-dependent control

Socket, 12V, in the boot area

Steering column – safety, including electric height-and-reach adjustment with memory

Steering wheel – 4-spoke, leather-covered multi-function, with audio and primary MMI controls

Tool kit in luggage compartment

Exterior equipment

Acoustic and optical parking system – front and rear

Adaptive air suspension. Electronically-controlled air suspension with continuously adaptive system for all four wheels, which regulates ride height and damping automatically. Choice of four modes (automatic, comfort, dynamic and lift) selected via the MMI system

Audi Space Frame (ASF III) construction with aluminium chassis and body panels with increased rigidity

Body-coloured door mirrors, handles and bumpers

Brake lights with LED technology and third high-level brake light in rear window

Double glazing (green-tinted) with additional break-in protection (not on S8 or W12 models)

Electrically adjustable and heated door mirrors, auto-dimming, folding with memory

Electromechanical parking brake

Exhaust pipes – twin, polished

Fog lights, integrated into front apron

Light sensor for automatic activation of headlights

Metallic or pearl-effect paint

Power-assisted boot closing – automatically draws a lid that has not fully engaged into the lock

quattro® permanent all-wheel drive (quattro® models only)

Rain sensor for automatic activation of front wipers

Torsen centre differential (quattro® models only)

Windscreen washer jets, heated

Xenon headlights with gas discharge technology for low and main beams, with automatic dynamic beam-angle control (includes headlight-cleaning system)

Additional equipment on V8 models:

18 x 8.5J '5-arm' high-gloss alloy wheels with 255/45 R18 Y tyres





SE model prices

Petrol

Engines	Cylinder	Power	Transmission	Basic RRP	Total RRP ^{inc VAT}	Recommended OTR
2.8 FSI	V6	210PS	7-speed multitronic	£42,730.43	£49,140.00	£49,975.00
3.2 FSI	V6	260PS	7-speed multitronic	£45,091.30	£51,855.00	£52,880.00
3.2 FSI quattro®	V6	260PS	6-speed tiptronic	£46,708.70	£53,715.00	£54,740.00
4.2 FSI quattro®	V8	350PS	6-speed tiptronic	£51,878.26	£59,660.00	£60,685.00

Diesel

Engines	Cylinder	Power	Transmission	Basic RRP	Total RRP ^{inc VAT}	Recommended OTR
3.0 TDI quattro®	V6	233PS	6-speed tiptronic	£45,352.17	£52,155.00	£52,990.00
4.2 TDI quattro®	V8	326PS	6-speed tiptronic	£53,243.48	£61,230.00	£62,255.00



Please note: The maximum power output figures are quoted in PS (or Pferdestärke, which is the metric equivalent of brake horsepower). To convert to brake horsepower, divide the PS figure by 1.0139.

Recommended On-The-Road (OTR) retail prices include: delivery charge, half a tank of fuel, number plates at £565.00 (inc. VAT) and Road Fund Licence (which may vary depending on model/transmission – see page 60 for details) and first registration fee at £55.00.

RRP – Recommended Retail Price.

Long-wheelbase model equipment

In addition to SE model equipment:

Additional equipment on long-wheelbase models:

- 130mm of additional leg-room for rear passengers
- Electric rear-window blind and manual rear-side blind
- Electric front passenger seat adjustment from rear
- Hinged storage compartment in rear doors
- Seat heating for rear seats

Additional equipment on W12 long-wheelbase model:

- 18 x 8.5J '12-spoke' alloy wheels with 255/45 R18 Y tyres
- Adaptive light – dynamic cornering light, including Xenon Plus headlights with headlight-washer system and coming-home function with LED daytime-running lights
- BOSE® surround sound
- Comfort seats with memory function
- Electric rear-window and rear side-blinds

- Extended leather upholstery package 2 – centre console and armrest in the doors, upholstered in Fine Nappa leather with decorative seam. Underside of dashboard, including glove box and door trims, also in Fine Nappa leather
- Heat- and UV-insulating double glazing
- Lumbar supports for outer-rear seats
- Power-assisted closing for the doors



SE long-wheelbase model prices

Petrol

Engines	Cylinder	Power	Transmission	Basic RRP	Total RRP <small>inc. VAT</small>	Recommended OTR
3.2 FSI LWB	V6	260PS	7-speed multitronic	£47,960.87	£55,155.00	£56,180.00
4.2 FSI quattro® LWB	V8	350PS	6-speed tiptronic	£54,747.83	£62,960.00	£63,985.00
W12 6.0 quattro® LWB	W12	450PS	6-speed tiptronic	£68,900.00	£79,235.00	£80,260.00

Diesel

Engines	Cylinder	Power	Transmission	Basic RRP	Total RRP <small>inc. VAT</small>	Recommended OTR
3.0 TDI quattro® LWB	V6	233PS	6-speed tiptronic	£48,221.74	£55,455.00	£56,290.00
4.2 TDI quattro® LWB	V8	326PS	6-speed tiptronic	£56,113.04	£64,530.00	£65,555.00



Please note: The maximum power output figures are quoted in PS (or Pferdestärke, which is the metric equivalent of brake horsepower). To convert to brake horsepower, divide the PS figure by 1.0139.

Recommended On-The-Road (OTR) retail prices include: delivery charge, half a tank of fuel, number plates at £565.00 (inc. VAT) and Road Fund Licence (which may vary depending on model/transmission – see page 60 for details) and first registration fee at £55.00.

RRP – Recommended Retail Price.

Sport model equipment

In addition to SE model equipment:

Wheels, tyres and suspension

19 x 8.5J '5-spoke' design alloy wheels
with 255/40 R19 Y tyres

Adaptive air suspension – Sport

Seats

Sports seats with memory and bi-colour Valcona leather from S8. (Single-colour Valcona leather available at no extra cost)

Interior equipment

1/3 Aluminium inlay

Fascia trim – Vavona wood, Assam grey

Sports design multi-function steering wheel,
gear change paddles, in perforated leather

Exterior equipment

Adaptive light with LED daytime-running light

Audi exclusive colour 'Daytona grey' available for no extra cost

S8 boot lid with integrated spoiler



Sport model prices

Petrol

Engines	Cylinder	Power	Transmission	Basic RRP	Total RRP <small>inc. VAT</small>	Recommended OTR
2.8 FSI	V6	210PS	7-speed multitronic	£45,413.04	£52,225.00	£53,060.00
3.2 FSI	V6	260PS	7-speed multitronic	£47,773.91	£54,940.00	£55,965.00
3.2 FSI quattro®	V6	260PS	6-speed tiptronic	£49,391.30	£56,800.00	£57,825.00
4.2 FSI quattro®	V8	350PS	6-speed tiptronic	£54,047.83	£62,155.00	£63,180.00
3.2 FSI LWB	V6	260PS	7-speed multitronic	£50,643.48	£58,240.00	£59,265.00
4.2 FSI quattro® LWB	V8	350PS	6-speed tiptronic	£56,917.39	£65,455.00	£66,480.00

Diesel

Engines	Cylinder	Power	Transmission	Basic RRP	Total RRP <small>inc. VAT</small>	Recommended OTR
3.0 TDI quattro®	V6	233PS	6-speed tiptronic	£48,034.78	£55,240.00	£56,075.00
4.2 TDI quattro®	V8	350PS	6-speed tiptronic	£55,413.04	£63,725.00	£64,750.00
3.0 TDI quattro® LWB	V6	233PS	6-speed tiptronic	£50,904.35	£58,540.00	£59,375.00
4.2 TDI quattro® LWB	V8	350PS	6-speed tiptronic	£58,282.61	£67,025.00	£68,050.00



Please note: The maximum power output figures are quoted in PS (or Pferdestärke, which is the metric equivalent of brake horsepower). To convert to brake horsepower, divide the PS figure by 1.0139.

Recommended On-The-Road (OTR) retail prices include: delivery charge, half a tank of fuel, number plates at £565.00 (inc. VAT) and Road Fund Licence (which may vary depending on model/transmission – see page 60 for details) and first registration fee at £55.00.

RRP – Recommended Retail Price.



S8 quattro® model equipment – in addition to SE models:

The Audi S8 takes the equation of style, refinement and luxury that is the Audi A8 and transforms it with an array of sporting features. First, the engine. A colossally powerful 5.2 FSI®, 450PS powerhouse, capable of reaching 62mph in just 5.1 seconds. Hardly surprising, however, considering that this V10 FSI® was developed in conjunction with the supercar specialists at Lamborghini. With Alcantara roof lining, BOSE® sound system, one-touch memory and power closing doors joining the performance line-up, the Audi S8 leaves very little to be desired.

Second, the interior. Exceptionally well-appointed, with supremely comfortable, bi-colour leather electric Sports seats, 3-spoke Sports steering wheel, an aluminium gear-lever and DVD-based Navigation system, controlled via the MMI's 7-inch colour screen. A Bang & Olufsen Sound System can even be included as an option – although for some, the breathtaking rhythm of the almighty V10 is entertainment enough.

Third, the exterior. Muscular and confident, yet subtle enough to leave the extent of this car's searing performance capabilities to the imagination. Over 5 metres long, with its imposing single-frame grille, integrated rear spoiler and massive 20-inch 'S' style alloy wheels, the Audi S8 is unique – an elegant Saloon with the character of a supercar.

Petrol

Engines	Cylinder	Power	Transmission	Basic RRP	Total RRP ^{inc. VAT}	Recommended OTR
S8 quattro®	V10	450PS	6-speed tiptronic	£61,852.17	£71,130.00	£72,155.00

Wheels, tyres and suspension

20 x 9J 'S' style '5-parallel-spoke wing' design alloy wheels with 265/35 R20 Y tyres

Brake callipers painted black with 'S8' logo on titanium-coloured trim

Seats

Valcona leather Sports seats in either solid or bi-colour look (four colour combinations for seat surface/back and seat-side sections/head restraints)

Safety and security

'S' adaptive air suspension (Sport) – with firmer shock absorbers

Tyre-pressure monitor

Exterior equipment

Adaptive lights – dynamic cornering lights, including Xenon Plus headlights with coming-home function and LED daytime-running lights

Aluminium-look wing-mirror housings

Dual-branch oval exhaust system

Power-closing doors and boot lid

'S' grille (Platinum grey): double vertically-oriented chrome struts and S8 badge

'S' rear spoiler

Space-saver spare wheel

Spoiler lip. 3-part air intake beneath single-frame grille

Interior equipment

Alcantara package (rear parcel-shelf, upper trim of A, B, C and D pillars, roof lining and sun visors in Alcantara)

BOSE® surround sound

Carbon Atlas and brushed aluminium inlays (combination)

Extended leather upholstery package 2 – centre console and armrest in the doors upholstered in Fine Nappa leather with decorative seam. Underside of dashboard including glove box and door trims in Fine Nappa leather

Heat- and UV-insulating double glazing

Leather-trimmed multi-function steering wheel (3-spoke) with 'S' logo and shift paddles in aluminium look

'S' gear knob in leather and aluminium

'S' instrument dials with white needles

S8 door-sill trim in aluminium look

V10 badge on wheel arch above indicator



Transmission

multitronic®

Translating a driver's preferences and intentions into road performance, the multitronic® transmission system entertains no compromises – whether in terms of dynamism, convenience or economy. multitronic® automatic transmission is available on models without quattro® permanent all-wheel-drive. A continuously variable transmission, multitronic® can transmit up to 310 Nm of torque and permits an exceptionally wide range of gear ratios. The result is smooth, powerful acceleration and a high level of driving comfort. And thanks to its lightweight design and a number of advanced electronic control systems that monitor gradient, road conditions and the way the driver is using the accelerator pedal, multitronic® also plays an instrumental role in reducing fuel consumption.

tiptronic®

The 6-speed tiptronic® transmission system is a form of automatic transmission available on Audi models with quattro® permanent all-wheel-drive. The technology converts high-torque engine power into both sporty performance and operating convenience, with crisp, fast gear changes, reduced weight and an optimised gearshift strategy. More spontaneous gear changes are a particular benefit, especially when downshifting. Both in the 'D' (Drive) and 'S' (Sport) programme, the advanced electronics used in tiptronic® respond efficiently to every driver input, helping to prevent unwanted upshifts when cornering.





Paint finishes

Standard colours



Brilliant black

A2



Ice silver, metallic

P5

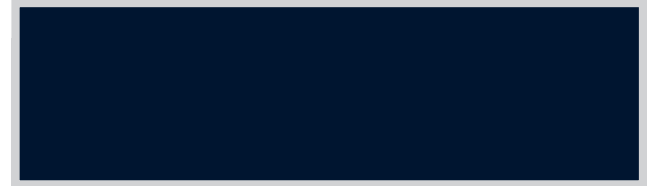

Night blue, pearl effect

7X



Avus silver, pearl effect

C2



Aqua blue, pearl effect

N5



Impala beige, pearl effect

T2

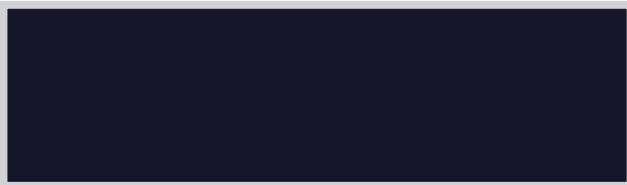

Oyster grey, metallic

X1

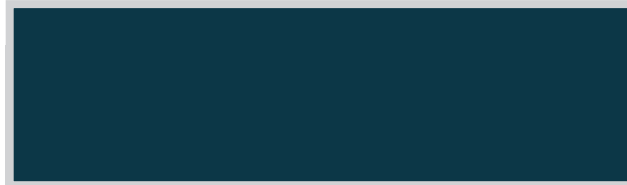

Aurora blue, pearl effect

9U



Phantom black, pearl effect

L8



Quartz grey, metallic

Q4

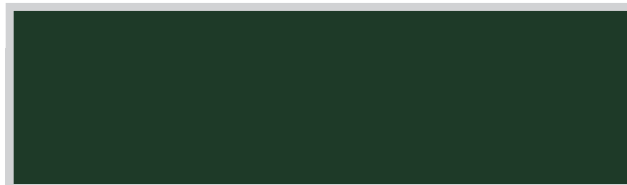

Deep green, pearl effect

3W



Cherry black, pearl effect

8C

S8 and Sport model additional colours



Daytona grey, pearl effect

6Y



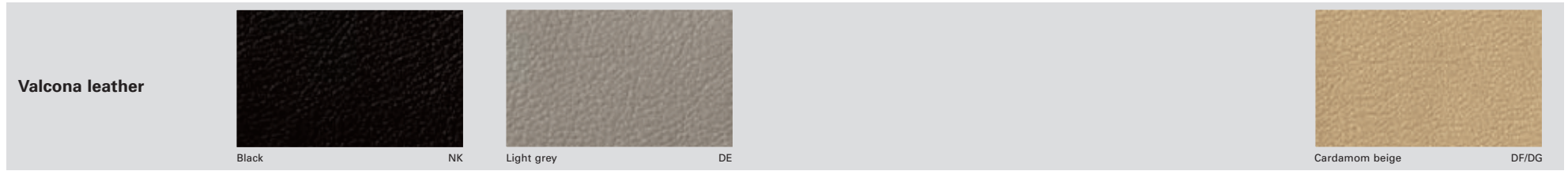

Upholstery

Standard seats

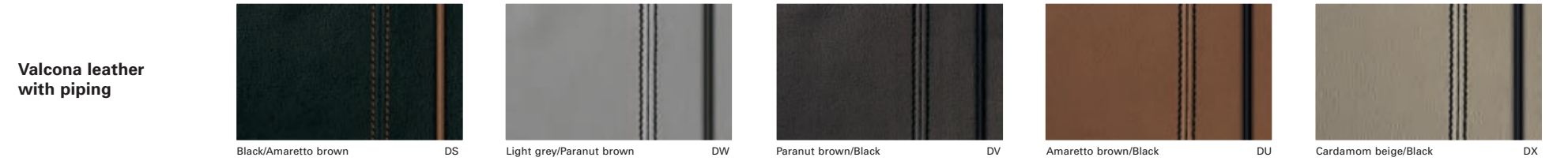

Comfort seats*



	V6 models	V8 models	V6 LWB models	V8 LWB models	W12 LWB models	S8 models	Basic RRP	Total RRP ^{inc. VAT}
Standard on non-Sport models	S	S	S	S	-	-	No charge	No charge
 Linen beige DH	•	•	•	•	S	•	No charge	No charge
 Cardamom beige/Tan beige DY	• -	• -	• -	• -	- NC	- •	£508.70 £426.09	£585.00 £490.00
Natural-grained leather with excellent breathing properties for seat covers, head restraints and centre armrests – door inserts in colour-matched Alcantara	•	•	•	•	•	•	£256.52	£295.00
Fine-grained, supple leather with excellent breathing properties for seat covers, head restraints and centre armrests – door inserts in colour-matched Alcantara	•	•	•	•	•	•	£552.17	£635.00

Options are subject to availability and may extend delivery.
 - = Not available • = Available S = Standard





NC = No charge

*Price does not include cost of comfort seat, please see page 40 for further information.
 RRP – Recommended Retail Price.

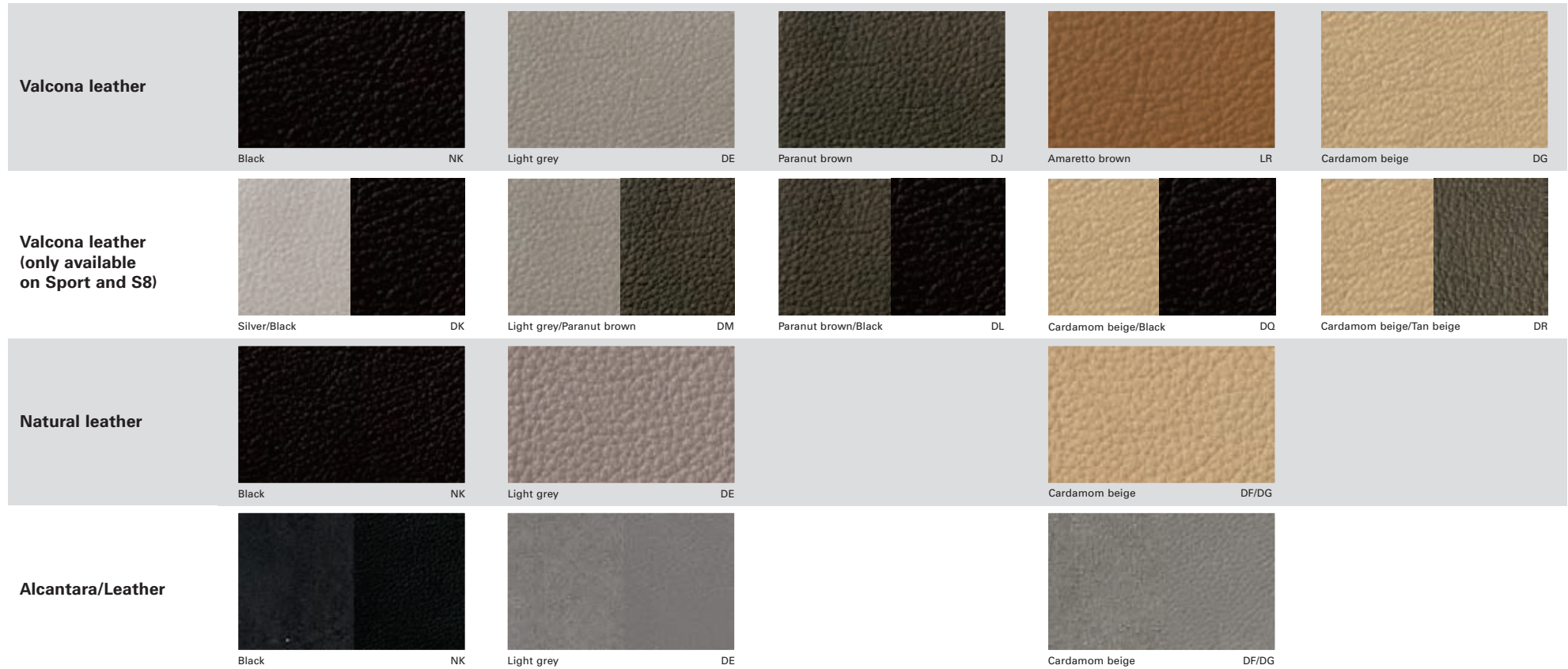
Upholstery

Sports seats*

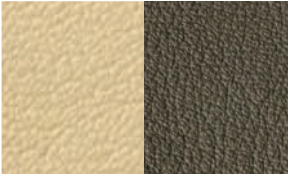

		V6 models	V8 models	V6 LWB models	V8 LWB models	W12 LWB models	S8 models	Basic RRP	Total RRP ^{inc. VAT}
	DH	•	•	•	•	•	•	No charge	No charge
	LX	•	•	•	•	•	•	No charge	No charge
	DZ	S	S	S	S	-	S	No charge	No charge
	DN	•	•	•	•	•	•	£256.52	£295.00
Standard on Sport models and S8. Lighter colour for seat centre panels, darker colours for seat bolsters									
Natural-grained leather with excellent breathing properties for seat covers, head restraints and centre armrests – door inserts in colour-matched Alcantara									
Not available on Sport models		•	•	•	•	•	•	No charge	No charge



Colour and trim guide

To help you choose the right colours for you and your Audi A8, please use the guide below to ensure your preferred colours and trims are well-matched.

Sport seats – Interior trim colours (not available on S8):

Order code	Upholstery	Carpet	Dashboard	Headlining	Valcona leather	Alcantara/leather	Natural leather	Satin Nappa leather
NK	Black	Black	Black/Black	Silver	●	–	–	–
DE	Light grey	Graphite grey	Grey/Light grey	Silver	●	–	–	–
DF	Cardamom beige	Black	Black/Cardamom beige	Linen beige	●	–	–	–
DG*	Cardamom beige	Tan beige	Tan beige/Cardamom beige	Linen beige	●	–	–	–

Comfort seats – Interior trim colours:

Order code	Upholstery	Carpet	Dashboard	Headlining	Valcona leather	Alcantara/leather	Natural leather	Satin Nappa leather
NK	Black	Black	Black/Black	Silver	●	–	●	●
DE	Light grey	Graphite grey	Grey/Light grey	Silver	●	–	●	●
LR	Amaretto brown	Black	Black/Black	Amaretto brown	●	–	–	●
DF	Cardamom beige	Black	Black/Cardamom beige	Linen beige	●	–	●	–
DG*	Cardamom beige	Tan beige	Tan beige/Cardamom beige	Linen beige	●	–	●	–
DH*	Linen beige	Tan beige	Tan beige/Cardamom beige	Linen beige	●	–	–	–
DJ	Paranut brown	Black	Black/Black	Silver	●	–	–	–
DS	Black with Amaretto brown piping	Black	Black/Black	Silver	●	–	–	–
DU	Amaretto brown with black piping	Black	Black/Black	Amaretto brown	●	–	–	–
DV	Paranut brown with black piping	Black	Black/Black	Silver	●	–	–	–
DW	Light grey with Paranut brown piping	Graphite grey	Grey/Light grey	Silver	●	–	–	–
DX	Cardamom beige with black piping	Black	Black/Cardamom beige	Linen beige	●	–	–	–
DY	Cardamom beige with Tan beige piping	Tan beige	Tan beige/Cardamom beige	Linen beige	●	–	–	–

– = Not available

● = Available

S = Standard

*On Sport models upholstery codes DG, DH, DR and DZ (with Tan beige upper dashboard) must be combined with Audi lane assist (7Y2) and a 4-spoke steering wheel with gear shift paddles (2ZS) at extra cost.

Colour and trim guide

Sports seats – Interior trim colours. Bi-colour available on S8 or Sport models only:

Order code	Upholstery	Carpet	Dashboard	Headlining	Valcona leather	Alcantara/leather	Natural leather
NK	Black	Black	Black/Black	Silver	●	●	●
DE	Light grey	Graphite grey	Grey/Light grey	Silver	●	●	●
LR	Amaretto brown	Black	Black/Black	Amaretto brown	●	–	–
DF	Cardamom beige	Black	Black/Cardamom beige	Linen beige	●	●	●
DG*	Cardamom beige	Tan beige	Tan beige/Cardamom beige	Linen beige	●	●	●
DH*	Linen beige	Tan beige	Tan beige/Cardamom beige	Linen beige	●	–	–
DJ	Paranut brown	Black	Black/Black	Silver	●	–	–
LX	Silver	Light grey	Grey/Silver	Silver	●	–	–
DK	Silver/Black bi-colour	Black	Black/Black	Silver	●	–	–
DL	Paranut brown/Black bi-colour	Black	Black/Black	Silver	●	–	–
DM	Light grey/Paranut brown bi-colour	Graphite grey	Grey/Light grey	Silver	●	–	–
DN	Silver/Light grey bi-colour	Graphite grey	Grey/Light grey	Silver	●	–	–
DQ	Cardamom beige/Black bi-colour	Black	Black/Cardamom beige	Linen beige	●	–	–
DR*	Cardamom beige/Tan beige bi-colour	Tan beige	Tan beige/Cardamom beige	Linen beige	●	–	–
DZ*	Linen beige/Tan beige bi-colour	Tan beige	Tan beige/Cardamom beige	Linen beige	●	–	–

A8 Inlays

Order code				V6 models	V8 models	V6 LWB models	V8 LWB models	W12 LWB models	S8 models	Basic RRP	Total RRP <small>inc. VAT</small>
5MG		Walnut brown	Sport models	S •	S •	S •	S •	S -	NC -	No charge No charge	No charge No charge
5ME		Vavona wood, Bernstein	Sport models	• •	• •	• •	• •	• -	NC -	£191.30 No charge	£220.00 No charge
7TC		Fine-grain Birch wood, Beige	Sport models	• •	• •	• •	• •	• -	NC -	£191.30 No charge	£220.00 No charge
5TW		Vavona wood, Assam grey	Sport models	• S	• S	• S	• S	• -	NC -	£191.30 No charge	£220.00 No charge
5MS		Walnut, Matt mid-brown	Sport models	• •	• •	• •	• •	• -	NC -	£191.30 No charge	£220.00 No charge

S8 Inlay

5MK		Carbon atlas		-	-	-	-	-	S	No charge	No charge
-----	---	--------------	--	---	---	---	---	---	---	-----------	-----------

- = Not available • = Available S = Standard NC = No charge

Sport model 2.8 FSI and 3.2 FSI non-quattro® are only available with Vavona wood Assam Grey (5TW).
Note that with wood inlay upgrades on all other Sport models the 1/3 aluminium inlay becomes 'Brushed aluminium titanium grey'.





Wheels, tyres and brakes

Order code		V6 models	V8 models	V6 LWB models	V8 LWB models	W12 LWB models	S8 models	Basic RRP	Total RRP <small>inc. VAT</small>
PRF	17 x 8J '7-spoke' design alloy wheels with 235/55 R17 Y tyres	S	•	S	•	-	-	No charge	No charge
PRL	18 x 8.5J '5-arm' design high-gloss alloy wheels with 255/45 R18 Y tyres (not available on Sport models)	•	S	•	S	-	-	£595.65	£685.00
PQW	18 x 8J '9-spoke' design alloy wheels (two-colour, polished) with 235/50 R18 Y tyres	• -	- •	• -	- •	- -	- -	£808.70 £213.04	£930.00 £245.00



17 x 8J '7-spoke' design alloy wheels



18 x 8.5J '5-arm' design high-gloss alloy wheels



18 x 8J '9-spoke' design alloy wheels

Wheels, tyres and brakes

Order code		V6 models	V8 models	V6 LWB models	V8 LWB models	W12 LWB models	S8 models	Basic RRP	Total RRP <small>inc. VAT</small>		
PRT	18 x 8.5J '10-spoke' design alloy wheels with 255/40 R19 Y tyres	• -	- •	• -	- •	- -	- -	£595.65 No charge	£685.00 No charge		
PRV	19 x 8.5J '5-spoke' design alloy wheels 255/40 R19 Y tyres	Sport models		S -	S -	S -	S -	- •	- -	No charge £426.09	No charge £490.00
PRQ	19 x 8.5J '12-spoke' design alloy wheels, (two-colour, polished) with 255/40 R19 Y tyres	• - -	- • -	• - -	- • -	- - •	- - -	£1,065.22 £469.57 £213.04	£1,225.00 £540.00 £245.00		



18 x 8.5J '10-spoke' design alloy wheels



19 x 8.5J '5-spoke' design alloy wheels



19 x 8.5J '12-spoke' design alloy wheels

Options are subject to availability and may extend delivery.
 - = Not available • = Available S = Standard

RRP – Recommended Retail Price.

Wheels, tyres and brakes

Order code		V6 models	V8 models	V6 LWB models	V8 LWB models	W12 LWB models	S8 models	Basic RRP	Total RRP <small>inc. VAT</small>
PQG	19 x 9J '5-arm' design alloy wheels with 255/40 R19 Y tyres	•	-	•	-	-	-	£1,700.00	£1,955.00
		-	•	-	•	-	-	£1,104.35	£1,270.00
		-	-	-	-	•	-	£852.17	£980.00
		•	•	•	•	-	-	£765.22	£880.00
	Sport models								
PQS	19 x 9J '20-spoke' design alloy wheels with 255/40 R19 Y tyres	•	-	•	-	-	-	£1,700.00	£1,955.00
		-	•	-	•	-	-	£1,104.35	£1,270.00
		-	-	-	-	•	-	£852.17	£980.00
		•	•	•	•	-	-	£765.22	£880.00
	Sport models								
PQU	20 x 9J '9-spoke' design alloy wheels with 275/35 R20 ZR tyres (includes 18" emergency spare wheel)	•	-	•	-	-	-	£2,043.48	£2,350.00
		-	•	-	•	-	-	£1,447.83	£1,665.00
		-	-	-	-	•	-	£1,191.30	£1,370.00
		•	•	•	•	-	-	£1,104.35	£1,270.00
	Sport models								



19 x 9J '5-arm' design alloy wheels



19 x 9J '20-spoke' design alloy wheels



20 x 9J '9-spoke' design alloy wheels

Wheels, tyres and brakes

Order code		V6 models	V8 models	V6 LWB models	V8 LWB models	W12 LWB models	S8 models	Basic RRP	Total RRP <small>inc. VAT</small>	
PQF	20 x 9J '7-arm twin-spoke' design polished two-colour alloy wheels with 275/35 ZR20 tyres	Sport models	•	-	•	-	-	-	£2,043.48	£2,350.00
			-	•	-	•	-	-	£1,447.83	£1,665.00
			-	-	-	-	•	-	£1,191.30	£1,370.00
			•	•	•	•	-	-	£1,104.35	£1,270.00
			-	-	-	-	-	•	£852.17	£980.00
CS6	20 x 9J '5-parallel spoke S' design alloy wheels with 275/35 ZR20 tyres	-	-	-	-	-	S	No charge	No charge	
PC5	Ceramic brakes. Lightweight, ventilated ceramic brake-discs to all four wheels, 380mm discs at front, 356mm at rear, 6-piston monobloc aluminium callipers at front and sliding calliper brakes at rear. Audi ceramic logo on front callipers	-	-	-	-	•	•	£5,104.35	£5,870.00	



20 x 9J '7-arm twin-spoke' design polished two-colour alloy wheels



20 x 9J '5-parallel spoke S' design alloy wheels



Ceramic brakes

Audio and communication

Order code		V6 models	V8 models	V6 LWB models	V8 LWB models	W12 LWB models	S8 models	Basic RRP	Total RRP <small>inc. VAT</small>
7D3	Audi Music Interface – universal connection for use with stereo audio sources and Apple iPod generation 4 onwards (iPod, iPod mini, iPod nano, iPod photo, iPod video). Provides intuitive control of an iPod through the MMI and multi-function steering wheel. It also replicates the iPod display on the MMI screen, including track titles. The interface provides power for an iPod as well as a convenient rubberised storage tray (only in combination with MMI High)	•	•	•	•	•	•	£213.04	£245.00
8RF	Bang & Olufsen Advanced Sound System – surround sound reproduction with dynamic compensation for road noise, 5-channel amplifier, 14 loudspeakers (total output 1,000 Watts), motorised acoustic lens speakers in the dashboard, aluminium loudspeaker grilles for all other visible speakers and 14-channel Digital Signal Processing (DSP)	•	•	•	•	-	-	£3,830.43 £3,213.04	£4,405.00 £3,695.00
8RY	BOSE® surround sound – 5-channel surround sound reproduction with dynamic compensation for road noise, 8-channel amplifier, 10 loudspeakers (total output of 350 Watts) and high-resolution Digital Signal Processing (DSP)	•	•	•	•	S	S	£617.39	£710.00



iPod display on the MMI screen



Speakers, part of Bang & Olufsen Advanced Sound System



Dashboard-mounted retractable speakers, part of Bang & Olufsen Advanced Sound System

Audio and communication

Order code		V6 models	V8 models	V6 LWB models	V8 LWB models	W12 LWB models	S8 models	Basic RRP	Total RRP <small>inc. VAT</small>
PNG	MMI 3G , 3rd Generation of MMI including 2 FM tuners, high-resolution (800x400) 7" colour TFT display, 2 SD card readers, DVD player, 40GB hard drive, 10GB of which can be used to store up to 4,000 songs. HDD Navigation functionality includes advanced speech recognition, 3D and topographical mapping display and advanced 3D building display	S	S	S	S	S	S	No charge	No charge
PT4	Mobile phone preparation – High (with privacy handset) . The handset allows passengers to make private calls, provides remote control of the telephone functions as well as convenient SMS text messaging function. The handset is charged from a docking station integrated into the front centre armrest	•	•	•	•	S	•	£256.52	£295.00
9ZF	GSM mobile phone preparation – with hands-free function . Located in front centre armrest, with Bluetooth interface and roof-mounted aerial for optimum reception. A Generation 2 mobile phone cradle is required at extra cost	•	•	•	•	•	•	No charge	No charge
QU1	TV reception, analogue and digital – for improved reception of ‘free-to-air’ TV channels . Picture reception only possible when the vehicle is stationary – sound reception at all times	•	•	•	•	•	•	£808.70	£930.00



Steering wheels

Order code		V6 models	V8 models	V6 LWB models	V8 LWB models	W12 LWB models	S8 models		Basic RRP	Total RRP <small>inc. VAT</small>
2ZS	4-spoke multi-function steering wheel with gear-shift paddles, incorporating control paddles for manual gear selection	•	•	•	•	S	-		£69.57	£80.00
2ZM	4-spoke multi-function steering wheel, heated (must be combined with seat heating)	•	•	•	•	-	-		£86.96	£100.00
2ZD	4-spoke multi-function steering wheel, heated with gear-shift paddles, incorporating control paddles for manual gear selection (must be combined with seat heating)	•	•	•	•	-	-		£152.17	£175.00
1XX	3-spoke Sports multi-function steering wheel with gear-shift paddles, in 3-spoke design, incorporating control paddles for manual gear selection (standard on Sport models)	•	•	•	•	•	S		£134.78	£155.00
P32	Wooden 3-spoke Sports multi-function steering wheel, with gear-shift paddles for manual gear selection – includes matching gear-selector knob (must be combined with matching Walnut or Vavona Bernstein inlays)	•	•	•	•	-	-		£278.26	£320.00
P33		-	-	-	-	•	-		£208.70	£240.00
1XL	Wooden segment design multi-function steering wheel, in 4-spoke design, incorporating gear-shift paddles for manual gear selection (must be combined with matching Walnut or Vavona Bernstein finish inlays)	•	•	•	•	-	-		£526.09	£605.00
		-	-	-	-	•	-		£460.87	£530.00



4-spoke multi-function wheel



3-spoke Sports multi-function wheel



Wooden 3-spoke Sports multi-function steering wheel

Safety and security

Order code		V6 models	V8 models	V6 LWB models	V8 LWB models	W12 LWB models	S8 models	Basic RRP	Total RRP <small>inc. VAT</small>
2MA	Adaptive air suspension – Sport. Sports suspension based on the standard adaptive air suspension system – with firmer damping and car level lowered by up to 20mm according to mode (standard on Sport models)	•	•	•	•	•	-	£508.70	£585.00
8T4	Adaptive cruise control. Automatic distance regulation, using radar sensors to maintain required distance by braking and accelerating. Four programmes (distance 1 to distance 4) set via steering column controls of the cruise control system	•	•	•	•	•	•	£1,278.26	£1,470.00
8Q6 PXF	Adaptive light , including Xenon Plus: dynamic cornering light-function with pivoting headlight units that follow steering wheel movement from speeds of 7mph upwards (includes headlight washers). Turning-light function integrated into headlights, activated when indicator is switched on, steering wheel is turned considerably or when ‘reverse’ is selected. Only works with low-beam headlights and at speeds up to 45mph	•	•	•	•	S	S	£339.13	£390.00
		S	S	S	S	-	-	No charge	No charge
7X8	Audi Parking System Advanced – Facilitates parking the car by acoustically indicating the distance to obstacles in front of and behind the car, by showing the distance and by providing a visual image of the area behind the vehicle on the MMI display. Includes guiding lines. Measured by ultrasonic sensors and camera integrated discreetly in the boot handle	•	•	•	•	S	•	£317.39	£365.00
7K3	Electronic tyre-pressure monitoring , monitors air pressure and temperature level for each wheel (including the spare wheel if fitted) while the car is driving. Air pressure and temperature levels are displayed via the MMI	•	•	•	•	•	S	£339.13	£390.00
7Y1	Audi side assist. Aids the driver when changing lane. Audi side assist monitors the area behind your A8, using radar sensors located discreetly in the rear bumper and informs the driver via a visual warning signal in the door mirror if there is a vehicle in the driver's blind spot or approaching quickly from behind. The system is activated via a button on the dashboard	•	•	•	•	•	•	£382.61	£440.00
7Y2	Audi lane assist – Uses a discreet camera mounted at the top of the windscreen to monitor the road ahead. The driver is warned via a vibration of the steering wheel if the vehicle is about to exit the lane unintentionally (only available in combination with a 4-spoke steering wheel) To order 7Y1 and 7Y2 in combination, please use order code 7Y3	•	•	•	•	•	•	£339.13	£390.00

Seats

Order code		V6 models	V8 models	V6 LWB models	V8 LWB models	W12 LWB models	S8 models	Basic RRP	Total RRP <small>inc. VAT</small>
WS7	Comfort seats , with softer seat upholstery and special seam pattern; electric memory adjustment as per standard seats plus electric thigh support and front seat-head angle with memory (only in conjunction with Valcona, Natural or Satin Nappa leather, please see pages 22 and 23 for available colours)	• -	• -	• -	• -	S -	- •	£473.91 No charge	£545.00 No charge
PE6	Electrically adjustable outer rear seats , for adjustment of seat-head angle, forwards and backwards position of seat base and seat base angle; includes easy-exit function for rear seats, lumbar support and front passenger seat adjustment from rear (not in combination with Sports seats). Please note that rear centre seat belt and headrest are deleted. Car only suitable for 4 people. Only in combination with front Comfort seats and comfort head restraints at rear	• -	• -	• -	• -	- •	- -	£2,300.00 £1,878.26	£2,645.00 £2,160.00
4V1	Front passenger seat adjustment from rear , electrically operated with operating controls on the rear seat	•	•	S	S	S	•	£113.04	£130.00
7P3	Lumbar support for rear seats , electrically adjustable	•	•	•	•	S	•	£221.74	£255.00
WMA	Massage function for front seats , includes Comfort seats (not available on Sport models)	• -	• -	• -	• -	- •	- -	£747.83 £278.26	£860.00 £320.00
PMA	Massage function for front and outer rear seats , includes Comfort seats, lumbar support for outer rear seats (not available on Sport models)	• - -	• - -	• - -	• - -	- - •	- • -	£1,260.87 £786.96 £565.22	£1,450.00 £905.00 £650.00



Electric front seats



Electrically adjustable outer seats



Through-load facility

Seats

Order code		V6 models	V8 models	V6 LWB models	V8 LWB models	W12 LWB models	S8 models	Basic RRP	Total RRP <small>inc. VAT</small>
WME	Massage and ventilation function for front seats , includes Comfort seats with perforated leather (only in combination with Valcona or Natural leather. Not available on Sport models)	•	•	-	-	-	-	£1,608.70	£1,850.00
		-	-	•	•	-	-	£1,352.17	£1,555.00
		-	-	-	-	•	•	£730.43	£840.00
PMC	Massage and ventilation function for front and outer rear seats , includes Comfort seats with perforated leather, electrically adjustable outer rear seats including lumbar support, seat heating for rear seats (only in combination with Valcona or Natural leather. Not available on Sport models)	•	•	-	-	-	-	£4,834.78	£5,560.00
		-	-	•	•	-	-	£4,226.09	£4,860.00
		-	-	-	-	-	•	£4,113.04	£4,730.00
		-	-	-	-	•	-	£3,147.83	£3,620.00
4A4	Seat heating for outer rear seats , individually controlled with variable temperature adjustment	•	•	S	S	S	•	£247.83	£285.00
WS5	Sports seats , with contoured side sections at the front and a special seam pattern; electric memory adjustment as per standard seat plus electric thigh support and front seat-head angle (only in combination with Valcona leather). Standard on Sport models. Cannot be combined with massage or ventilation function packages	•	•	•	•	NC	S	£473.91	£545.00
3X1	Through-load facility (ski bag), for transporting long objects	•	•	•	•	•	•	£191.30	£220.00
WMC	Ventilation function for front seats , includes Comfort seats with perforated leather (only in combination with Valcona or Natural leather)	•	•	-	-	-	-	£1,173.91	£1,350.00
		-	-	•	•	-	-	£926.09	£1,065.00
		-	-	-	-	•	•	£456.52	£525.00
PMB	Ventilation function for front and outer rear seats , includes Comfort seats with perforated leather, electrically adjustable outer rear seats including lumbar support, seat heating for rear seats (only in combination with Valcona or Natural leather)	•	•	-	-	-	-	£4,321.74	£4,970.00
		-	-	•	•	-	-	£3,713.04	£4,270.00
		-	-	-	-	-	•	£3,604.35	£4,145.00
		-	-	-	-	•	-	£2,639.13	£3,035.00

Interior equipment

Order code		V6 models	V8 models	V6 LWB models	V8 LWB models	W12 LWB models	S8 models	Basic RRP	Total RRP <small>inc. VAT</small>
PL7	Alcantara package , comprising rear parcel shelf, upper trim of A, B, C and D-pillars, roof lining and sun visors in Alcantara	•	•	•	•	•	S	£852.17	£980.00
1W7	Cool box , compressor-based cooling located in the through-load facility (ski bag) with temperature range from +10°C to -15°C, capacity of two 0.75l bottles horizontally, shelf and LED interior lighting. Can be converted back to ski bag at any time (must be combined with through-load facility)	•	•	•	•	•	•	£852.17	£980.00
1W4	Cool box with bar compartment , with additional bar compartment including 2 upright glass tumblers (not chilled). Must also be combined with electrically adjustable outer rear seats	•	•	•	•	•	•	£1,234.78	£1,420.00
7HB	Extended leather upholstery pack 1 . Centre console and armrest upholstery in the doors in Fine Nappa leather with decorative seams	•	•	•	•	-	-	£552.17	£635.00
7HC	Extended leather upholstery pack 2 , includes contents of pack 1 plus underside of instrument panel, glovebox lid and door facings	•	•	•	•	S	S	£1,191.30	£1,370.00
PE7	Extended rear centre-console , including electrically adjustable outer rear seats, lumbar support for rear seats, and extended leather upholstery pack 1	-	-	•	•	-	-	£4,339.13	£4,990.00
		-	-	-	-	•	-	£2,765.22	£3,180.00



Alcantara package



Cool box with bar compartments



Extended rear centre-console

Interior equipment

Order code		V6 models	V8 models	V6 LWB models	V8 LWB models	W12 LWB models	S8 models	Basic RRP	Total RRP <small>inc. VAT</small>
VC1	Garage door opener (HomeLink®)* , programmable radio-operated remote control, with control buttons integrated into the roof module at the front	•	•	•	•	•	•	£147.83	£170.00
6Q3	Gear knob in wood , to match fascia trim	•	•	•	•	•	•	£65.22	£75.00
6NQ (OVY on Sport)	Headlining in black cloth	•	•	•	•	•	•	£234.78	£270.00
VA5	Rear additional cushion/pillow in matching leather to seat upholstery, for attachment to rear seat headrests. Priced individually	•	•	•	•	•	•	£104.35	£120.00
OTR	Rear footrests , finished in same colour as vehicle carpet. Priced as a pair	-	-	•	•	•	-	£147.83	£170.00
VE1	Rear vanity mirrors . 2 folding and illuminated vanity mirrors recessed into roof lining (only in combination with glass or solar sunroof)	-	-	•	•	•	-	£152.17	£175.00
3Y2	Rear window blind , electrically operated from front or rear	•	•	-	-	-	•	£256.52	£295.00
3Y5	Rear window blind , electrically operated from front or rear with manual side blinds for rear doors	•	•	S	S	-	•	£404.35	£465.00
3Y8	Rear window blind and side blinds for rear doors , electrically operated from front or rear	•	•	-	-	S	•	£595.65	£685.00
		-	-	•	•	-	-	£191.30	£220.00



Electric rear window blind



Rear vanity mirrors

Options are subject to availability and may extend delivery.
 - = Not available • = Available S = Standard

RRP – Recommended Retail Price.
 *HomeLink® is a registered trademark of Johnson Controls. For information on compatibility, visit www.homelink.com.

Exterior equipment

Order code		V6 models	V8 models	V6 LWB models	V8 LWB models	W12 LWB models	S8 models	Basic RRP	Total RRP <small>inc. VAT</small>
4E7	Automatically-activated boot lid. Opens and closes the boot lid electrically, opened via radio-operated remote car key, button in the driver's door or the soft-touch button in the boot lid recess; closed by pressing the button on the inside of the boot lid	•	•	•	•	S	S	£317.39	£365.00
2Z7	Deletion of engine displacement badge on boot lid	•	•	•	•	•	-	No charge	No charge
2Z0	Deletion of model and engine displacement badges on boot lid	•	•	•	•	•	-	No charge	No charge
3FE	Electric slide-and-tilt glass sunroof, with position pre-selection, tinted glass insert, variable sunshield and convenient closing	•	•	•	•	•	•	£765.22	£880.00
3FR	Electric slide-and-tilt solar-panel sunroof, with position pre-selection and convenient closing. Uses the sun's energy to supply a constant flow of air to reduce the temperature inside a parked car	•	•	•	•	•	•	£1,000.00	£1,150.00
GZ2	Power door-closure. Electrically operated power doors with soft-close feature	•	•	•	•	S	S	£360.87	£415.00
1D2	Towing equipment – removable. (Factory-fitted towbars usually require a 13- to 7-pin adaptor. Please consult your Audi Centre for details.) Not available on 2.8 FSI models	•	•	•	•	•	•	£526.09	£605.00
PDU	Twin-pane heat and UV insulating glass, with additional reflective coating on outer pane to reduce interior heat build-up	•	•	•	•	S	S	£313.04	£360.00
PDB	Twin-pane heat and UV insulating glass and heated windscreen, as above with invisible heating element in windscreen. Operates automatically below +5°C when climate control is in 'Auto' mode	•	•	•	•	-	-	£595.65	£685.00
		-	-	-	-	•	•	£282.61	£325.00
4KS VW5	Privacy Glass. Dark-tinted glass from B-pillar backwards including rear screen	•	•	•	•	-	•	£278.26	£320.00

Service Plan

	V6 models	V8 models	V6 LWB models	V8 LWB models	W12 LWB models	S8 models		
							Basic RRP	Total RRP <small>inc. VAT</small>
<p>Service Plan. Comprehensive service package, valid for 3 years or 60,000 miles (whichever occurs sooner) including parts and labour charges. Servicing is provided as defined in the Audi Service Schedules. Transferable between owners (within period of original agreement). For full details of cover and exclusions, please speak to a member of staff at your Audi Centre</p>	•	•	•	•	•	•	£239.13	£275.00





Every Audi is intrinsically exclusive. It's the breathtaking design, the exceptional engineering, the Vorsprung durch Technik. But for that added element of exclusivity – that distinguishing look that sets you apart from the rest – you can specify your Audi A8 with options from Audi exclusive. Whether you want a completely unique, custom-mixed paint colour, seats in a combination of complementary shades or even individualised carpets and floor mats, Audi exclusive will enable you to drive the car you've always imagined.

For more information on any of the options over the following pages or to view swatches, simply ask a member of staff at your local Audi Centre.



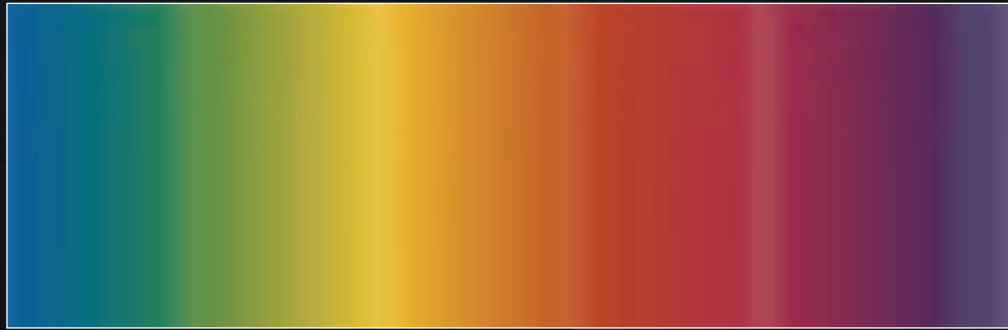

Customised Paint

In a car made from Vorsprung durch Technik, there are no compromises. So if you have a particular colour in mind, we'll mix the exact water-based metallic or pearl-effect shade you want – whether it's the blue of your favourite shirt or the wall colour in your sitting room.

Basic RRP	Total RRP ^{inc.} _{VAT}
£2,043.48	£2,350.00

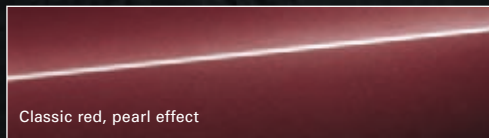
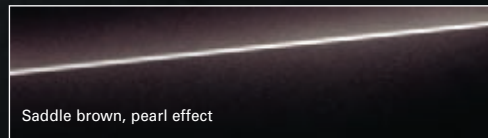
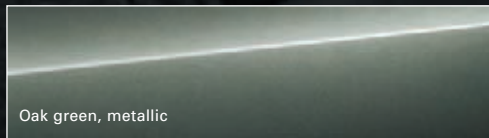
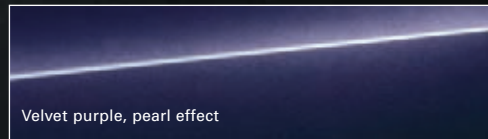
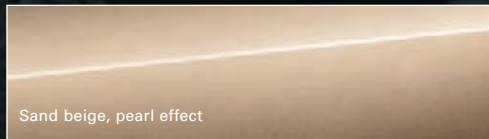
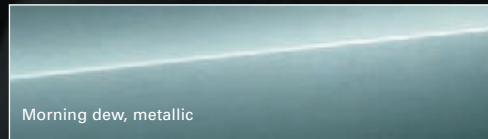
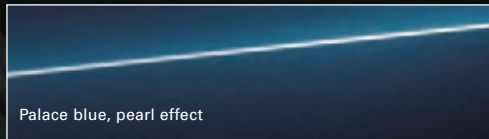

Or any other paint colour in the Audi range

Basic RRP	Total RRP ^{inc.} _{VAT}
£1,447.83	£1,665.00

Paint

Everyone has a favourite colour. No matter what yours is, Audi exclusive provides a range of unique colours that have been designed to set your car apart. Choose from the swatches here, or specify any other paint colour in the Audi range – whether it's Jet blue from the Audi R8 or Alpine white from the original Audi quattro. The choice is yours.

Upholstery

With Audi exclusive, you can choose between Fine Nappa leather and Alcantara, depending on the texture and flexibility you prefer in your car's upholstery. And once that's decided, you can specify your seats in an array of different colours.

Choose just one all-over shade for each seat, or for a sportier look, customise each panel in two or more complementary colours from the distinctive Audi exclusive palette shown here. You can even choose the colour of the decorative stitching – to match or contrast with your chosen upholstery – from this varied collection. Whatever combination you decide upon, you're guaranteed to be extremely comfortable with the result.

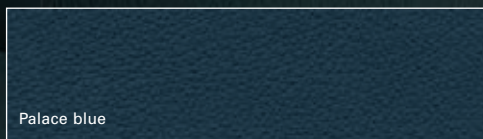
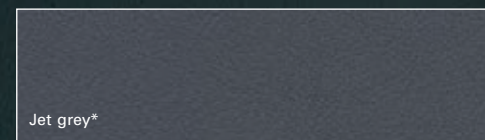
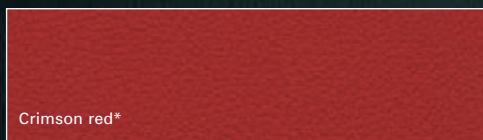
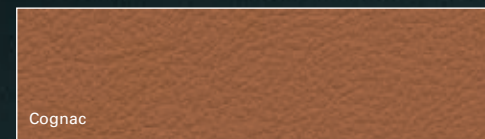
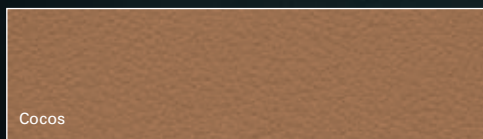
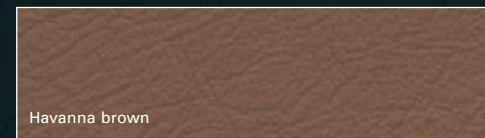
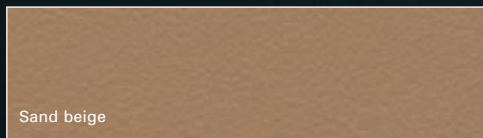
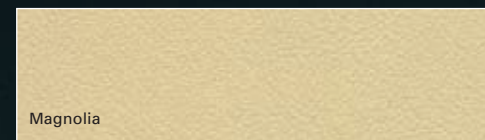
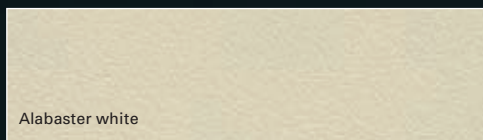

	Basic RRP	Total RRP ^{inc.} VAT
Door inserts Valcona leather instead of Alcantara	£639.13	£735.00
Seat belts colour-matched to seat upholstery or any colour from exclusive range	£934.78	£1,075.00

*Not available in Alcantara.

			V6	V8	V6 LWB	V8 LWB	6.0 LWB	S8	Basic RRP	Total RRP ^{inc. VAT}
Package 1 includes seat upholstery and backrest, front and rear centre armrests and door trim inserts in leather. Seat adjustment switch and seat side trims colour-matched to chosen leather. (Alcantara inserts where chosen and only available with Sport seats)	Nappa leather	PYA*	●	●	●	●	●	●	£2,978.26	£3,425.00
	Valcona leather/Alcantara	PYC*	●	●	●	●	●	●	£2,978.26	£3,425.00
	Valcona leather	PYB	●	●	●	●	●	●	£3,234.78	£3,720.00
Package 2 as package 1 plus centre console and armrests in door panels in leather, underneath of front centre armrest and switch panel in door handle colour-matched to chosen leather	Nappa leather	PYD*	●	●	●	●	●	—	£5,104.35	£5,870.00
			—	—	—	—	—	●	£4,256.52	£4,895.00
	Valcona leather/Alcantara	PYF*	●	●	●	●	●	—	£5,104.35	£5,870.00
			—	—	—	—	—	●	£4,256.52	£4,895.00
	Valcona leather	PYE	●	●	●	●	●	—	£5,360.87	£6,165.00
			—	—	—	—	—	●	£4,508.70	£5,185.00
Package 3 as package 1 and 2 plus lower section of dashboard on driver's side and glove box lid in leather, door trim element (without top shoulder) and B post attachment in leather. Lid of fuse box, speaker grill and lower section of A, B and C-posts colour-matched to chosen leather	Nappa leather	PYG*	●	●	—	—	—	—	£8,426.09	£9,690.00
			—	—	●	●	—	—	£8,934.78	£10,275.00
			—	—	—	—	●	—	£7,234.78	£8,320.00
			—	—	—	—	—	●	£7,660.87	£8,810.00
	Valcona leather/Alcantara	PYI*	●	●	—	—	—	—	£8,426.09	£9,690.00
			—	—	●	●	—	—	£8,934.78	£10,275.00
			—	—	—	—	●	—	£7,234.78	£8,320.00
			—	—	—	—	—	●	£7,660.87	£8,810.00
	Valcona leather	PYH	●	●	—	—	—	—	£8,682.61	£9,985.00
			—	—	●	●	—	—	£9,191.30	£10,570.00
			—	—	—	—	●	—	£7,491.30	£8,615.00
			—	—	—	—	—	●	£7,913.04	£9,100.00

*Not available in combination with massage function or seat air-conditioning.

Controls pack and steering wheel

Our fingertips and palms contain more touch receptors than any other part of our body – so shouldn't the parts of our car we handle the most also be the most pleasing to touch? With this in mind, Audi exclusive enables you to customise your steering wheel and gear knob in smooth, warm leather, in any of the colours shown on page 48. As with Audi exclusive seats and you even have free choice on the colour of the decorative stitching used.

Order code		Basic RRP	Total RRP <small>inc. VAT</small>
YRH	Leather steering wheel	£256.52	£295.00
YRB	Controls pack (includes steering wheel rim and gear knob in leather)	£382.61	£440.00



Carpets and floor mats

Exclusivity isn't just about choice and individuality – it's about attention to every detail in your Audi A8; and for us, that includes the carpets and floor mats. First, choose from nine different colours of high-quality velour carpets. Next, choose the colour of your car's floor mats from the same list, whilst using the palette of Audi upholstery colours detailed on page 48 to select a leather colour for the mats' decorative leather piping – matched or contrasting, depending on your personal taste.

Order code		Basic RRP	Total RRP <small>inc. VAT</small>
YSQ	Carpets and floor mats with leather piping	£1,191.30	£1,370.00
YSR	Floor mats with leather piping	£300.00	£345.00

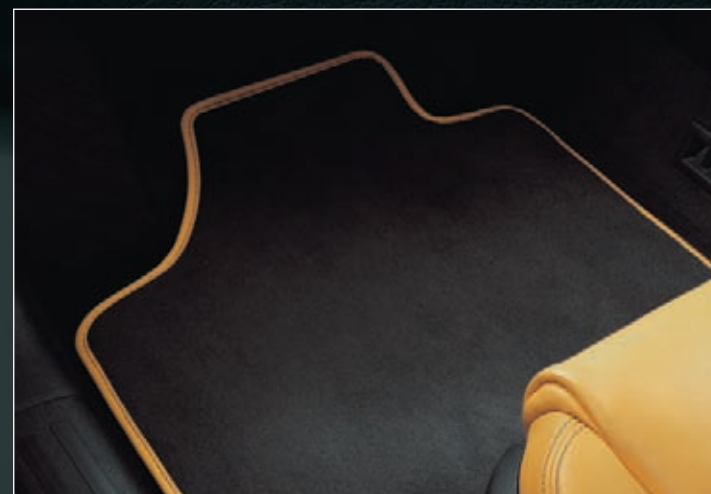

Carpet colours

- ▶ Alabaster white
- ▶ Magnolia
- ▶ Sand beige
- ▶ Havana brown
- ▶ Cocos
- ▶ Cognac
- ▶ Chestnut brown
- ▶ Palace blue
- ▶ Amethyst grey

Inlays

Inlays are the all-important ‘finishing touch’ that add flair and interest to the surfaces inside your car. So Audi exclusive have sourced a hugely varied range of materials from which to craft these elements – from rich quilted maple wood to clean, contemporary brushed aluminium. You can even customise your gear knob and steering wheel with one of the available woods, all of which are shown opposite.

Order code		Basic RRP	Total RRP ^{inc. VAT}
YTA	Inlays	£978.26	£1,125.00
YTD	Wood gear lever (tiptronic/multitronic)	£213.04	£245.00
YRI	3-spoke part-wood design steering wheel*	£552.17	£635.00
YTC	Personalised MMI trim panel	£360.87	£415.00

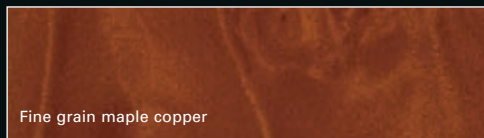

Fine grain maple copper

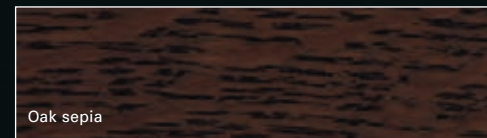

Oak sepia

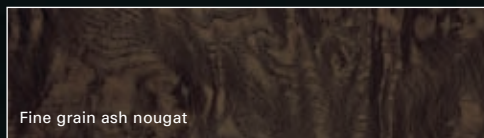

Fine grain ash nougat

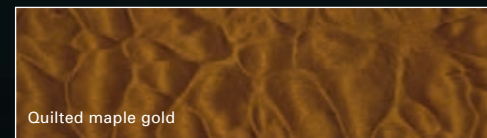

Quilted maple gold

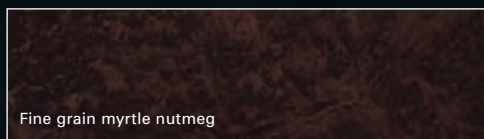

Fine grain myrtle nutmeg

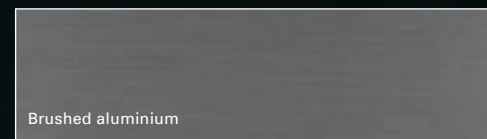

Brushed aluminium



Poplar saffron

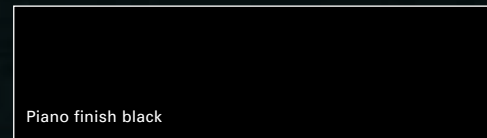

Piano finish black



*Cannot be combined with heated steering wheel or Audi lane assist.

Interior equipment

The comfortable luxury of the Audi A8 can be extended by adding practical rear reading lights and a folding table. The ideal extras for long journeys, the optional rear reading lights are perfect for illuminating maps in the dark, whilst the folding table keeps the rear uncluttered. It's these additional features that are the finishing touches to your A8's already impressive interior.

Order code		Basic RRP	Total RRP ^{inc.} _{VAT}
YZV	Rear reading lights	£508.70	£585.00
YZQ	Folding table, electrically operated. Located behind passenger seat*	£1,873.91	£2,155.00



*Only in combination with Comfort seats.

Audio and communication

Complementing your Audi with an audio and communication system is the ideal way to customise your car. The selection ranges from a simple mobile phone installation in the rear of your car to a state-of-the-art Rear Seat Entertainment system. So whether you opt for mobile communications or would like to benefit from having your own personal music collection close by, you're sure to appreciate the versatile extras.

Order code		Basic RRP	Total RRP ^{inc.} _{VAT}
YQE	Preparation for mobile-phone installation in the rear	£1,191.30	£1,370.00
9WP	Rear seat entertainment – comprising 6-disc DVD player in luggage compartment, 2 x 7" monitors in the front head restraints with separate TV/DVD/AUX input for each screen, connections for AUX input such as games console, sound output through vehicle sound system or headphones and analogue and digital TV reception	£4,256.52	£4,895.00
QW4	MMI remote control	£339.13	£390.00



Technical data

A8

Petrol

Engine	Cylinder	Displacement, cubic cm (valves per cylinder)	Max. power ¹ , PS at rpm	Max. torque, Nm at rpm	Transmission	CO ₂ emissions ² , g/km	0-62mph acceleration, seconds	Top speed ³ , mph	ABI insurance group
2.8 FSI	V6	2773 (4)	210/5500	280/3000	7-speed multitronic	199	8.0	147	17E
3.2 FSI	V6	3123 (4)	260/6500	330/3250	7-speed multitronic	234	7.7	155	17E
3.2 FSI quattro®	V6	3123 (4)	260/6500	330/3250	6-speed tiptronic	259	7.7	155	17E
4.2 FSI quattro®	V8	4163 (4)	350/6800	440/3500	6-speed tiptronic	259	6.1	155	19E
3.2 FSI LWB	V6	3123 (4)	260/6500	330/3250	7-speed multitronic	234	7.9	155	17E
4.2 FSI quattro® LWB	V8	4163 (4)	350/6800	440/3500	6-speed tiptronic	259	6.3	155	19E
W12 quattro® LWB	W12	5998 (4)	450/6200	580/4000	6-speed tiptronic	324	5.2	155	20E
S8 quattro	V10	5204 (4)	450/7000	540/3500	6-speed tiptronic	314	5.1	155	20E

Diesel

3.0 TDI quattro®	V6	2967 (4)	233/4000	450/1400	6-speed tiptronic	224	7.8	150	17E
4.2 TDI quattro®	V8	4134 (4)	326/3750	650/1600	6-speed tiptronic	249	5.9	155	19E
3.0 TDI quattro® LWB	V6	2967 (4)	233/4000	450/1400	6-speed tiptronic	224	7.9	151	17E
4.2 TDI quattro® LWB	V8	4134 (4)	326/3750	650/1600	6-speed tiptronic	249	6.1	155	19E

¹The given value was obtained in accordance with the specified measurement procedure (the respective current version of the Directive 80/1269/EEC).

²The given values were calculated in accordance with the specified measurement procedure (the respective current version of the Directive 80/1268/EEC). This information does not relate to a single vehicle and does not comprise part of the offer but is merely intended for the purpose of comparison between different vehicle types.

³Regulated (excludes 2.8 FSI and 3.0 TDI).

Unladen weight ⁴	Weights, kg		Max. trailer load ⁵ , kg			Volumes		Fuel consumption, mpg (l/100km)		
	Gross weight limit	Roof load limit/nose weight	unbraked	with 12% gradient	with 8% gradient	Luggage compartment capacity, litres	Fuel tank capacity approx, litres	Urban	Extra Urban	Combined
1690	2290	N/A	N/A	N/A	N/A	500	90	23.9 (11.8)	44.8 (6.3)	34.0 (8.3)
1690	2290	100/95	750	1900	2100	500	90	19.2 (14.7)	39.8 (7.1)	28.5 (9.9)
1785	2385	100/95	750	1900	2100	500	90	17.7 (16.0)	36.2 (7.8)	25.9 (10.9)
1800	2400	100/95	750	2300	2300	500	90	18.0 (15.7)	34.4 (8.2)	25.9 (10.9)
1740	2340	100/95	750	1900	2100	500	90	19.2 (14.7)	39.8 (7.1)	28.5 (9.9)
1850	2450	100/95	750	2300	2300	500	90	18.0 (15.7)	34.4 (8.2)	25.9 (10.9)
1995	2545	100/95	750	2300	2300	500	90	14.1 (20.1)	28.8 (9.8)	20.8 (13.6)
1940	2540	100/95	750	2300	2300	500	90	14.5 (19.5)	29.7 (9.5)	21.4 (13.2)
1830	2430	100/95	750	2300	2300	500	90	23.5 (12.0)	44.1 (6.4)	33.6 (8.4)
1945	2545	100/95	750	2300	2300	500	90	21.2 (13.3)	39.2 (7.2)	30.1 (9.4)
1880	2480	100/95	750	2200	2200	500	90	23.3 (12.1)	43.5 (6.5)	33.2 (8.5)
1995	2595	100/95	750	2300	2300	500	90	21.2 (13.3)	39.2 (7.2)	30.1 (9.4)

⁴Vehicle unladen weight without driver (calculated in accordance with the current version of Directive 80/1268/EEC). The fitting of additional equipment may increase the vehicle's unladen weight and drag coefficient, whereupon the potential carrying capacity and top speed will be correspondingly reduced.

⁵The engine's power output always goes down with increasing altitude. At 1000m above the sea level, and for every additional 1000m from the weight of the outfit (trailer load limit + gross weight of the towing vehicle).

⁶Regulated (excludes 2.8 FSI).

Dimensions

A8

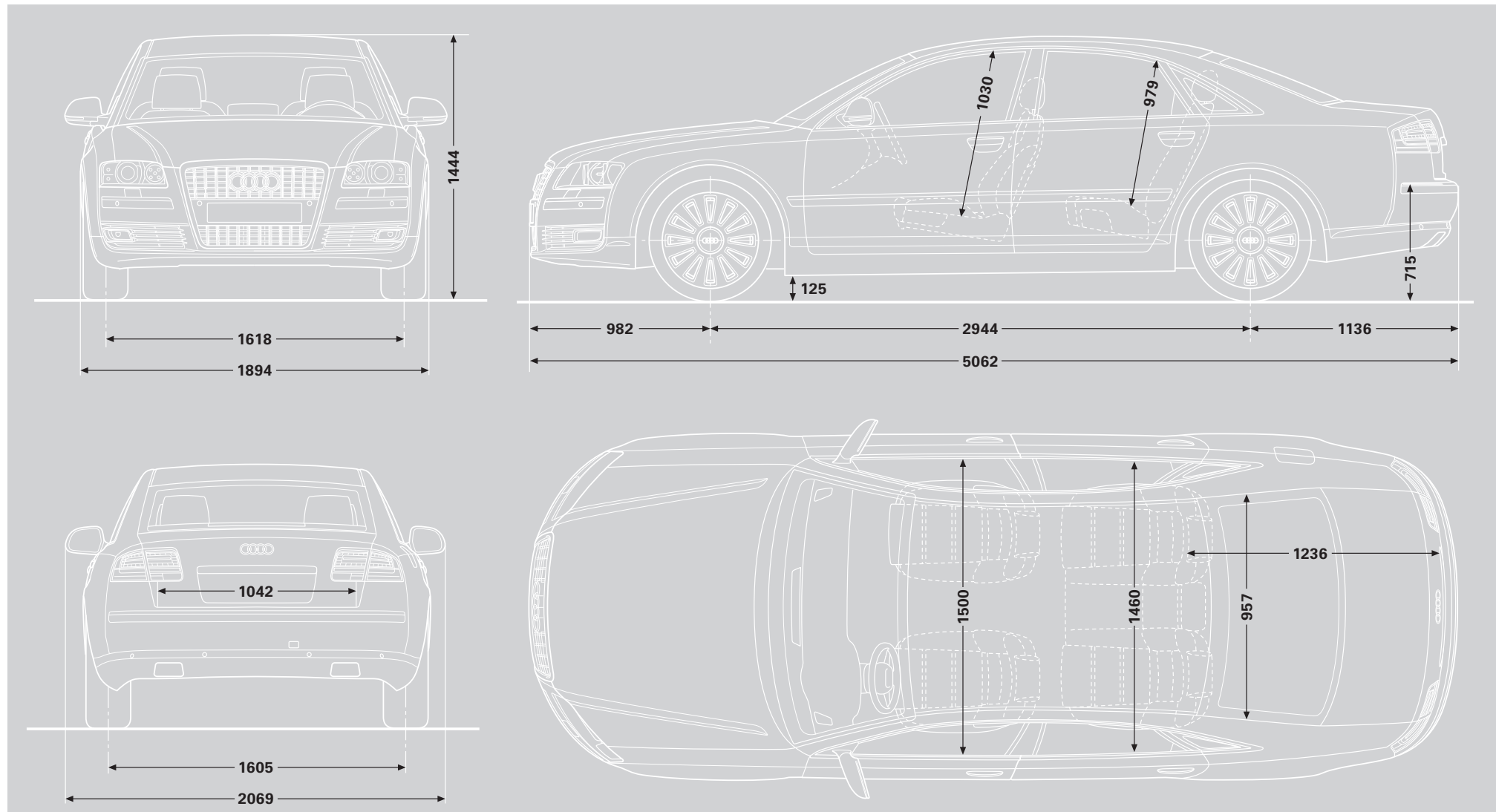

A8 long-wheelbase

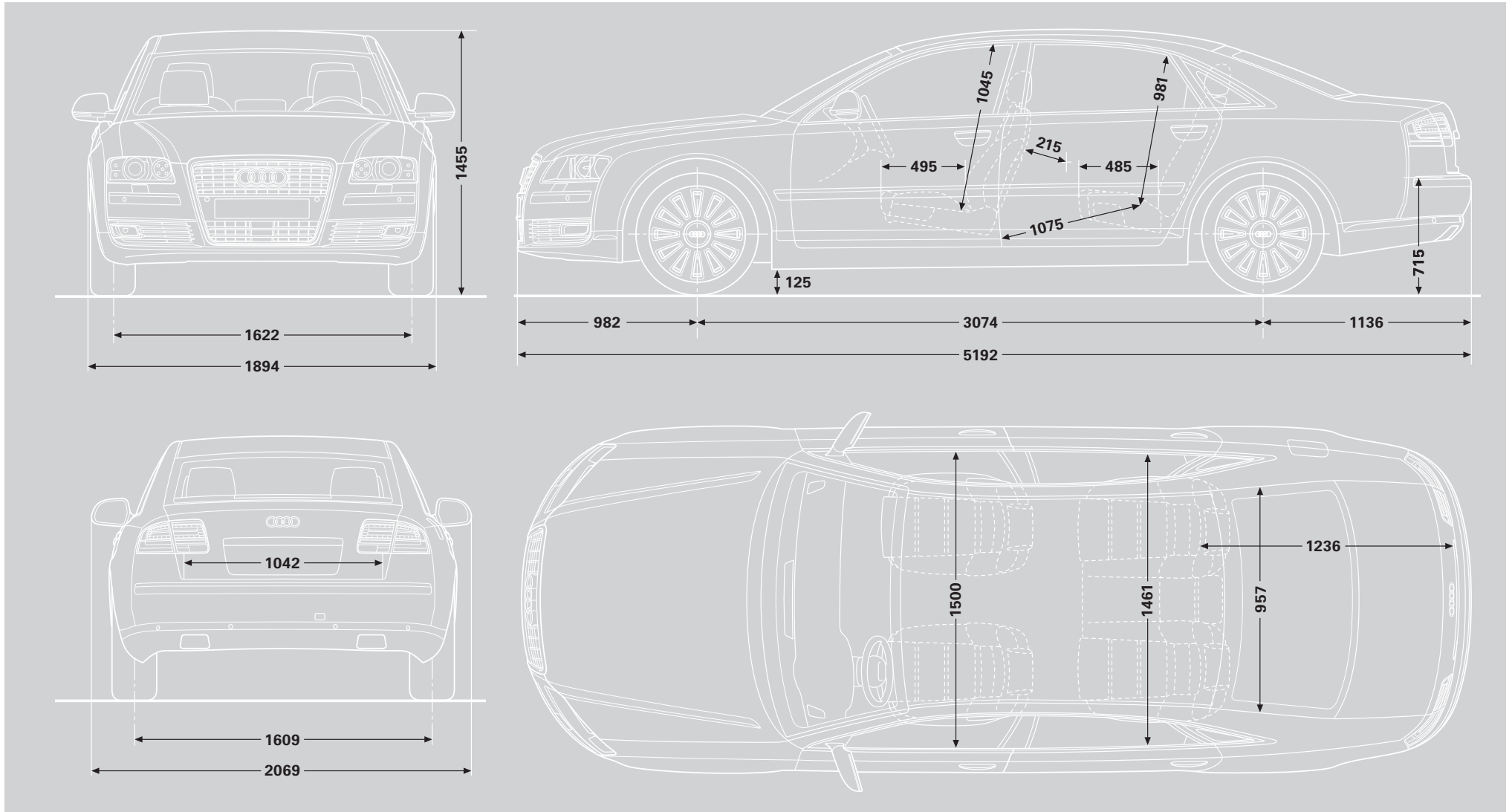

Dimensions were measured with vehicle at unladen weight, ground clearance measured with vehicle carrying its maximum load. Luggage compartment volume in litres: 500 (as measured by the VDA standard test method using 200 x 100 x 50 mm blocks; Second value: with rear seat folded down). Turning circle approx 12.5 metres.

Dimensions in millimetres.

Dimensions

A8 W12 long-wheelbase

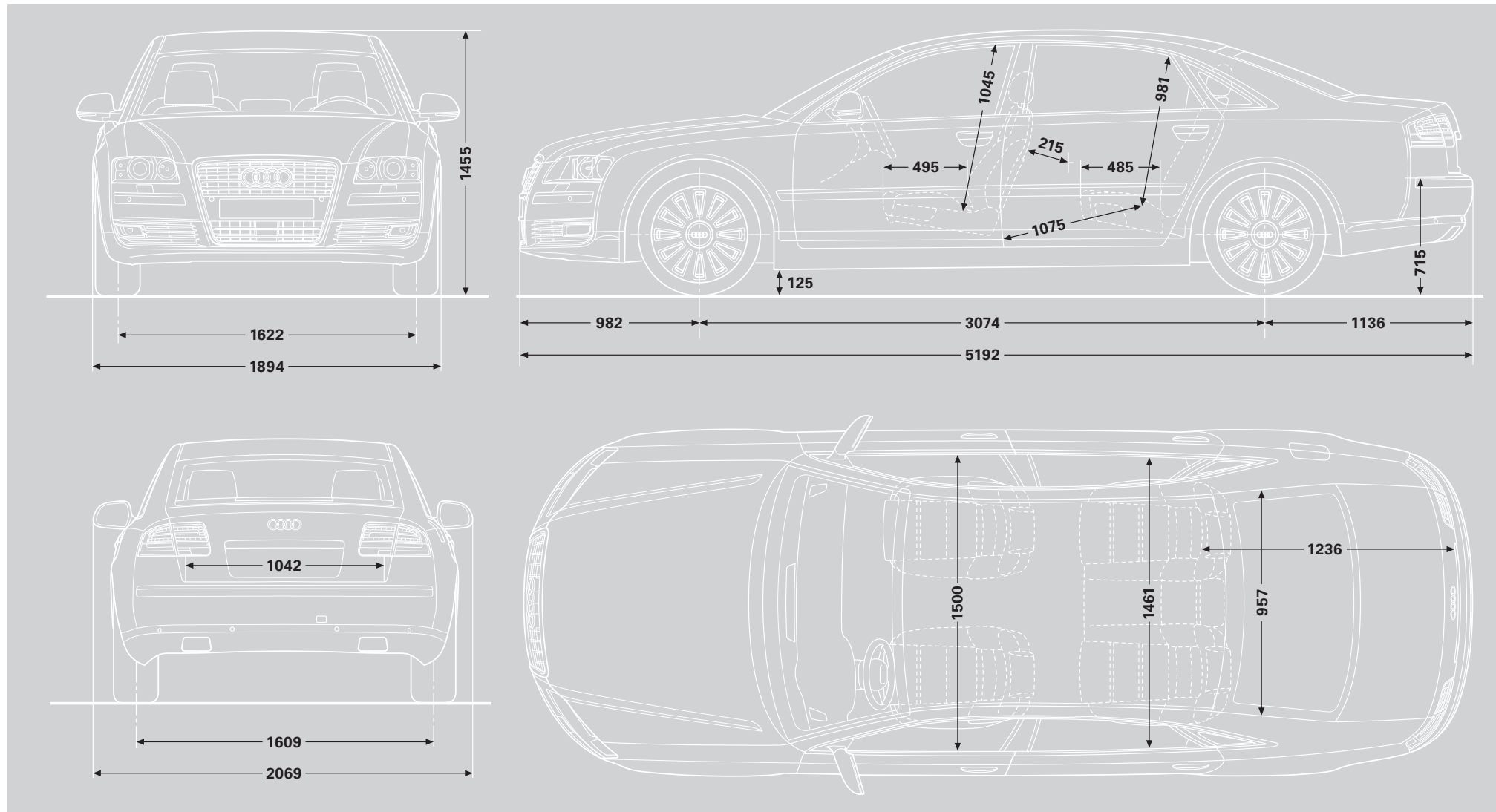

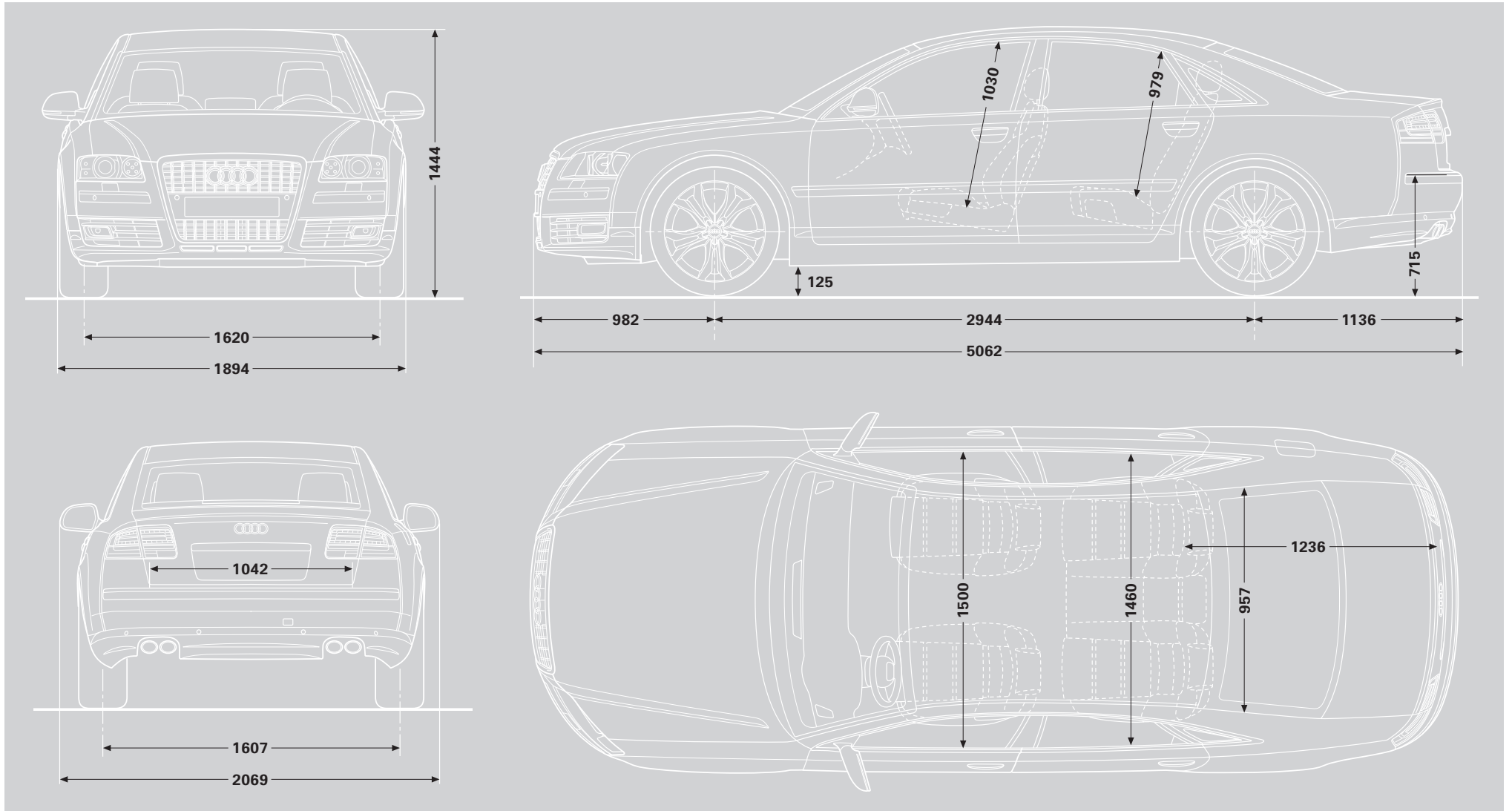

Dimensions were measured with vehicle at unladen weight, ground clearance measured with vehicle carrying its maximum load. Luggage compartment volume in litres: 500 (as measured by the VDA standard test method using 200 x 100 x 50 mm blocks; Second value: with rear seat folded down). Turning circle approx 12.5 metres.

Dimensions in millimetres.

Additional information

CO₂ data and information

CO₂ emissions-based Vehicle Excise Duty

Vehicle Excise Duty (Road Fund Licence) is based upon the amount of Carbon Dioxide (CO₂) a vehicle emits, measured in grams per kilometre (g/km). The DVLA has created thirteen categories:

Petrol and Diesel engines	
A – up to 100g/km	£0.00
B – 101 to 110g/km	£35.00
C – 111 to 120g/km	£35.00
D – 121 to 130g/km	£120.00
E – 131 to 140g/km	£120.00
F – 141 to 150g/km	£125.00
G – 151 to 165g/km	£150.00
H – 166 to 175g/km	£175.00
I – 176 to 185g/km	£175.00
J – 186 to 200g/km	£215.00
K* – 201 to 225g/km	£215.00
L – 226 to 255g/km	£405.00
M – over 255g/km	£405.00

*Band K includes cars that have a CO₂ figure over 225g/kg but were registered before 23 March 2006.

Audi Servicing

Servicing tailored to your needs

Prior to the 2000 model year, almost all Audi models followed a traditional fixed Service Schedule similar to that of other major car manufacturers: a Lubrication Service every 10,000 miles and an Inspection Service every 12 months or 20,000 miles – whichever occurred sooner. Since then, Audi has introduced a more flexible maintenance system that works in accordance with how, where and how much an individual uses their car.

The two Servicing Regimes available are the conventional 'Inspection Service Regime' and the flexible 'LongLife Service Regime'. When you purchase a new car, we will recommend one of these regimes to you depending on your own individual driving style and journey-type. The tables below should give you an indication of which regime might be more appropriate for you.

With the LongLife Service Regime, on-board sensors continuously monitor the condition of the engine oil in terms of temperature, level and oil degradation. The monitoring system also checks mileage, brake-pad wear and battery condition. Using this information, the car's on-board

computer calculates its own maintenance interval, providing you with ample warning of a due Service via the 'distance to Service' display.

In practice, this means that every Audi gets the maintenance it needs, when it needs it. For companies and private owners alike, there are many advantages to the LongLife Service Regime. Longer service intervals mean lower maintenance costs, and thus lower whole-life costs. According to company car mileage monitored at Audi since the introduction of LongLife, petrol engines are typically achieving an average of at least 17,500 miles and diesel engines around 20,000 miles between services.

One of the factors that makes this kind of servicing regime possible is the advanced engineering and technology that goes into Audi engines. Furthermore, Audi use high-grade long-life oils such as Castrol SLX LongLife III, which are designed to withstand ageing and high loads without deterioration. Compared to conventional oils, these advanced-formulation oils also give exceptional levels of engine protection, are kinder to the environment and deliver average fuel savings of 2.7%.

Inspection Service Schedule

	Vehicle usage:
Mileage	Less than 10,000* miles per annum
Type of journey	Mainly city/town centre driving. Short journeys
Conditions	Frequent cold starts. High engine loading – e.g. frequent hill climbs, vehicle fully loaded, towing
Driving style	Uneconomical – e.g. heavy acceleration, heavy braking, constant changes in speed, constant use of high revs, 'sporty' driving

	Service intervals:
Oil-change Service	Fixed to every 10,000* miles/1 year
Inspection Service	Fixed to every 20,000* miles/2 years

LongLife Service Regime

	Vehicle usage:
Mileage	More than 30 miles per day
Type of journey	Motorway and main road driving. Mainly longer distance journeys. Constant speeds
Conditions	Normal engine loading – e.g. with little or no towing, with little or no hill climbs. Normal vehicle loading
Driving style	Moderate acceleration, moderate braking, engine revs mainly below 3,000

	Service intervals:
Inspection Service**	Variable to a maximum of every 20,000* miles/2 years

*As indicated by the service interval display. Mileages are approximate as the Service Indicator system uses kilometres as its distance measurement.

**Always includes an oil change.

Service by Design

At Audi, we believe our customers have the right to expect excellent service each and every time they make contact with us. To ensure that this happens, we have agreed a set of service standards with our Audi Centre network that governs the way they do business with you. These standards apply to both Sales and Aftersales, and we actively monitor our Centres to ensure that you receive the highest level of customer service. These service standards will ensure a consistent, stress-free experience whenever you are in contact with anyone representing the Audi brand.

Every Audi Centre will be open during the following hours:

Sales: 9am-6pm Monday to Friday
9am-5pm Saturday

Service: 8am-6pm Monday to Friday
8.30am-1pm Saturday

Sunday opening at local discretion.

Test drives

Whilst we cannot always have the desired demonstrator car ready immediately, we will confirm arrangements for a test drive within two working days (subject to status).

New Car delivery

Once we have confirmed a delivery date with you, we will keep you informed of progress. In the unlikely event of a delay, we will provide you with a courtesy car to minimise inconvenience and keep you mobile.

Delivery to any location within the UK

To maximise your Audi experience right from the first day of ownership, we will deliver your car to your preferred location – whether that's home or your place of work (subject to reasonable notice).

Every attention to detail

Your ownership experience starts with half a tank of fuel.

Quotation response

We are committed to answering any quotation request within 1 working day.

Training

We run a continuous training development programme for all our staff so that we consistently deliver a high-quality, professional service.

Formal complaints procedure

We have a complaints procedure designed to ensure any negative issue you raise with us is dealt with properly.

Courtesy cars

When your car is off the road, perhaps due to a scheduled service or MOT, we will offer you an Audi Courtesy Vehicle until yours is ready. We'll even collect from and deliver to your chosen location, keeping hassle to an absolute minimum.

Service bookings

If you do not require a courtesy car, we will service your Audi within a maximum of 5 working days.

If you do choose to take a courtesy car, we will promise to service your vehicle within a maximum of 10 working days.

Cleaning

When your car comes to our workshop, we will wash and vacuum it at no extra cost.

No hidden charges

You will be consulted before we carry out any necessary work on your vehicle, and anything charged for will be itemised on your bill. No extra work will be undertaken without your permission.

A personal service

All work will be done by a named Audi technician, to whom you can personally direct questions or requests should you need to.

Environmental commitment

We promise to dispose of all non-biodegradable materials from your vehicle in a responsible manner.



Pricing information

Pricing

Prices and specifications given are correct at the time of printing. Always check details with your Audi Centre, as Audi policies are continually developing. We reserve the right to change prices or specifications at any time.

All prices are subject to VAT, currently charged at 15%.

Delivery charges and number plates are not included in the vehicle price.

Delivery charge	£471.30
Number plates	£20.00
VAT	£73.70
Total	£565.00

Audi Roadside Assistance

Your new car comes complete with complimentary roadside assistance and recovery across the UK provided by RAC Motoring Services. Also included is roadside assistance throughout Europe, managed by RAC Motoring Services.

Audi Customer Care

Every new Audi benefits from the comprehensive Audi Customer Care Package, which comprises:

- ▶ A 3-year Audi warranty, which covers you for unlimited mileage in the first 2 years of ownership, with a full mechanical and electrical warranty which covers you for up to 60,000 miles in the 3rd year
- ▶ A 3-year paint warranty
- ▶ A 12-year anti-corrosion warranty
- ▶ Up to 3 years' UK roadside assistance and recovery

This package, together with Audi variable Service intervals, offers a combination unmatched by any other major manufacturer. Contact your Audi Centre for full details.

Audi Tax-Free Sales

If you are entitled to purchase a vehicle free of VAT, normally through Military or Diplomatic privilege, please contact your local Audi Centre for full details.

Should you have any difficulty obtaining the information you require, please call Freephone 0800 585878.

Audi Finance

Audi Finance specialise in providing funding solutions for Audi drivers. Whether your Audi is for private or business use, there are a range of funding options to choose from.

Below is our full range of finance products.

- ▶ Solutions – a Personal Contract Plan
- ▶ Hire purchase
- ▶ Lease purchase
- ▶ Finance lease
- ▶ Contract hire

With all our finance products, you can choose one of our fixed-cost maintenance plans, which are designed to help you budget accurately.

No matter what Audi model you choose, your local Audi Centre can provide you with a personalised quote which could fit your budget and motoring needs.

Audi Finance is a trading name of Volkswagen Financial Services (UK) Limited. An offer of finance depends on certain conditions. Available to people over 18 in the UK only.

Audi Insurance

Competitive comprehensive motor insurance designed specially for Audi drivers. All new Audi models come with complimentary seven-day cover upon request – we'll email a cover note directly to your Audi Centre, enabling them to tax your car easily. This way, you can drive straight out of the showroom. Taking out an annual policy is easy and can begin as soon as your free seven-day cover expires.

For more information, contact your local Audi Centre. Alternatively, call 0800 051 3146 for a quote and to receive 7 days' complimentary cover for your new Audi.

Audi Insurance is underwritten and administered by Zurich Insurance Company.

Audi UK

Customer Service
P.O. Box 400
Walsall
WS5 4XX
0800 699888
www.audi.co.uk

Specifications and prices subject
to change without notice.

© Audi UK

Printed in the UK
Edition 2.0. 05/09
2010 Model Year



Mixed Sources
Product group from well-managed
forests and other controlled sources

Cert no. TT-COC-002327
www.fsc.org
© 1996 Forest Stewardship Council