

**RS 6**

Pricing and Specification Guide  
Valid from October 2009

Audi  
Vorsprung durch Technik



# A User's Guide

This guide has been designed to help you tailor and price your RS 6 quickly and logically. At the back of this guide, you will also find information on CO<sub>2</sub> emissions-based vehicle excise duty and the other services offered by Audi, including Finance and Insurance. If you wish, you can also go to [audi.co.uk](http://audi.co.uk) and configure your RS 6 online.

From the website, you can also access the Audi Channel player and see your potential new car in action on the following programmes:

## Drivetime

[www.audi.co.uk/RS6drivetime](http://www.audi.co.uk/RS6drivetime)

Alternatively, you can tune into the Audi Channel at any time on Sky Guide No. 884 to see a whole range of programmes about Audi and our motorsport achievements.



# Table of content

	Page number
<b>Introduction</b>	
<b>The new RS 6 Saloon and Avant</b>	
Engines	6
quattro®	7
<b>Model details and prices</b>	
Standard equipment	8
Transmission	10
<b>Colour and upholstery</b>	
Paint finishes	12
Upholstery options and colour and trim guide	14
Inlays	16
<b>Options</b>	
Wheels and tyres	18
Audio and communication	19
Seats	20
Safety and security	20
Interior equipment	22
Exterior equipment	23
<b>Audi exclusive</b>	
Audi exclusive options	24
<b>Technical details</b>	
Technical data	30
Dimensions	32
Additional information	34

# The new RS 6

It doesn't get much better than the RS 6. For a start, this is the single most powerful model ever to be produced by Audi. Not simply because it features a massive V10 TFSI engine which accelerates from 0 to 62mph in 4.6 seconds, but because it's capable of moving even the most laid-back of motorists to complete and utter awe.

Its predecessor certainly did. Launched by Audi over 4 years ago, the first-generation RS 6 was so revered for its incredible performance potential that it created a cult all of its own. It's no surprise, then, that this updated 580PS 5.0-litre TFSI model has already brought automotive enthusiasts to their knees. The perfect position from which to admire a supremely sporty set of 20" alloy wheels, glinting braking system and enlarged front air-intakes.

Allow us to introduce you to the superlative of Vorsprung durch Technik – the Audi RS 6.



## Engine

The power plant. The heart of the RS 6. This ten-cylinder engine generates impressive torque of up to 650 Nm all the way from 1,500 to 6,250 rpm. The enhanced 6-speed tiptronic gearbox with shortened shift times adds dynamism to your drive, reacting to your every impulse in just fractions of a second.

A twin-turbocharged 10-cylinder 580PS TFSI engine. The words alone are enough to set the adrenaline coursing through your veins. So just imagine the thrill when you find yourself pinned back into your Satin Nappa leather Sports seat by the sheer force of 650 Nm of torque – accelerating the RS 6 from a standing start to 62mph in just 4.6 seconds.

Not so long ago, that kind of power was unimaginable. Until TFSI® came onto the scene, that is. This unique Audi technology, which injects fuel directly and precisely into the engine's combustion chambers, was originally developed for Le Mans to deliver increased power and torque as well as enhanced fuel efficiency. It's seen Audi win the world-famous 24-hour endurance race year after year after year, leaving the competition trailing far behind. And it does exactly the same in the Audi RS 6.



# quattro

## Permanent all-wheel-drive

It's the technology that has given Audi the edge on the racetrack ever since it was first introduced over 25 years ago – a technology that delivers ultimate control whilst enhancing the sporty characteristics which make the RS 6 so thrilling to drive. It's called quattro® permanent all-wheel-drive. The principle is simple: in the same way that four brakes ensure better deceleration, four permanently-driven wheels deliver better acceleration and road-holding, pushing or pulling the car as needed, for a driving experience that's both dynamic and safe. In the RS 6, asymmetric-dynamic torque distribution continuously distributes drive power between the front and rear axles depending on weather conditions, road surface and gradient, which increases flexibility for an enhanced, sportier drive.





## All RS 6 models have the following items of standard equipment:

The equipment for the Audi RS 6 builds upon the standard equipment for the Audi S6. The typical characteristics of the Audi RS models emphasise the exclusive, dynamic and sporty character of the Audi RS 6. It is unmistakable.

### Wheels, tyres and suspension

20 x 9.5J '5-segment-spoke' design alloy wheels with 275/35 R20 tyres

Dynamic Ride Control (DRC) Sports suspension system with 3-level control

High-performance braking system

RS-specific quattro® Sports chassis

Tyre Mobility System

### Safety and security

Audi Parking System Plus with front and rear sensors

Cruise control

Electromechanical parking brake

Front and rear ISOFIX child-seat preparation with front passenger airbag de-activation switch

Front and rear side airbags with Sideguard curtain airbags

Light and rain sensor for automatic activation of lights and windscreen wipers

Tyre Pressure Monitoring System

### Seats

Electric lumbar support for both front seats

Front and rear seat heating

RS-specific front Sports seats, electrically adjustable, driver's side with memory

Silk Nappa leather with contrast stitching and RS embossing

Through-load facility

### Audio and Communication

6-disc CD-changer – compatible with .mp3 and .wma files

Audi Music Interface (AMI)

Bluetooth mobile phone connection

BOSE® surround sound

DAB digital Radio

Hard disk-based Satellite Navigation system with TMC functionality and 3D mapping

MMI 3G Multi Media Interface with 7" high-resolution screen, please see page 19 for further information

### Interior equipment

Auto-dimming rear view mirror

Carbon inlays

Colour Driver's Information System (DIS)

Front and rear floor mats

Headlining in black cloth

Instrument surround in high-gloss Piano Black finish

Interior lighting package

RS flat-bottom multi-function steering wheel with aluminium-look gearshift paddles

Luggage compartment net (Avant models only)

### Exterior equipment

Adaptive light including Xenon headlights, LED daytime running lights, headlight washer system and automatic range-adjustment

Auto-dimming, heated, folding door mirrors with memory function

Automatically-actuated electric tailgate

Coming-home and leaving-home lighting function, selectable through MMI

Matt-finish aluminium wing-mirror housings, roof rails, (Avant only) window trims and grille

Paint finish in metallic or pearl-effect

Rear lights featuring LED technology

Twin oval exhausts



## RS 6 model prices

### Saloon

Engine	Power	Transmission	Basic RRP	Total RRP <sup>inc.</sup> VAT	Recommended OTR
5.0 TFSI	580PS	6-speed tiptronic®	£63,939.13	£73,530.00	£74,550.00

### Avant

Engine	Power	Transmission	Basic RRP	Total RRP <sup>inc.</sup> VAT	Recommended OTR
5.0 TFSI	580PS	6-speed tiptronic®	£65,273.91	£75,065.00	£76,085.00



Recommended On-The-Road (OTR) retail prices include: delivery charge, half a tank of fuel, number plates at £565.00 (inc. VAT) and Road Fund Licence (which may vary depending on model/transmission. See page 34 for details) and first registration fee at £55.00.

RRP – Recommended Retail Price.



# Transmission

## tiptronic®

The 6-speed tiptronic® transmission system is a form of automatic transmission, standard on all Audi RS 6 models. The technology incorporates DSP – or the Dynamic Shift Programme – which aligns and converts the engine's high power and torque into both sporty performance and operating convenience, with crisp, fast gear changes, reduced weight and optimised gear-shifting.

In the 'D' (Drive) and 'S' (Sport) programmes, the advanced electronics used in tiptronic® respond efficiently to every driver input, helping to prevent unwanted gear-changes. The driver can override automatic mode by moving the gear lever into a tiptronic® shift-gate, enabling spontaneous gear-changing for a sportier driving style.





## Standard colours

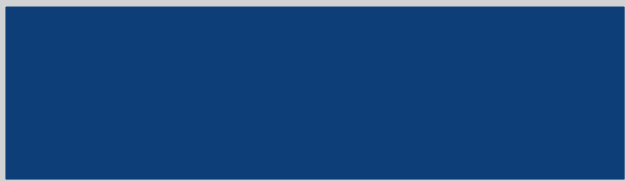

Sepang blue, pearl effect

E9

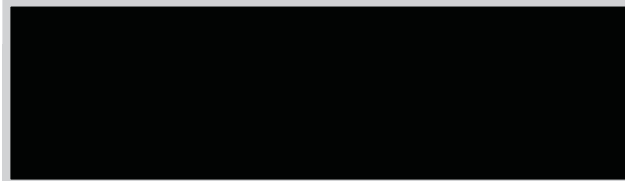

Phantom black, pearl effect

L8

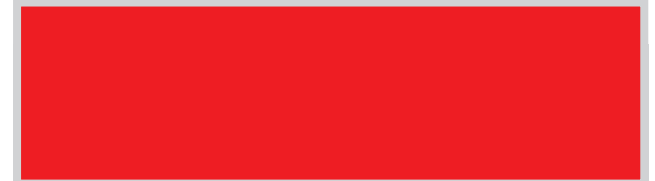

Misano red, pearl effect

N9

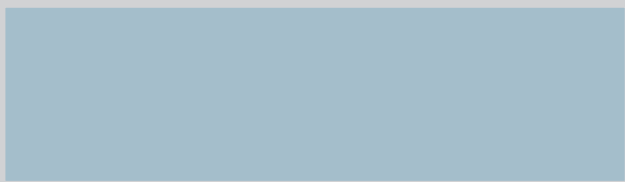

Monza silver, metallic

U7

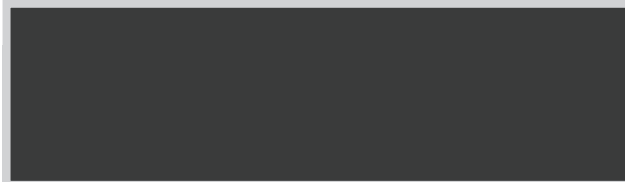

Daytona grey, pearl effect

6Y

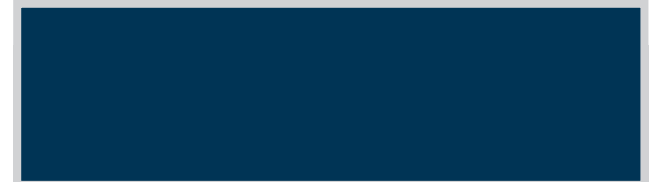

Mugello blue, pearl effect

5W

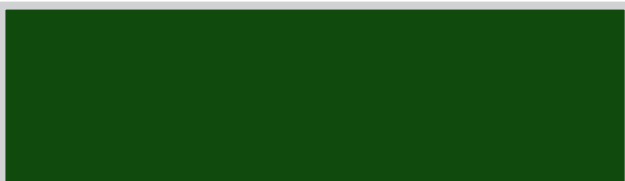

Monterey green, pearl effect

3R



# RS 6 upholstery

## Sports seats (RS 6 embossed)

		RS 6	Basic RRP	Total RRP <small>inc. VAT</small>
	Leather/Alcantara, Black QH	•	No charge	No charge
	Valcona leather, Metallic black with Jet grey stitching QH	•	No charge	No charge
	Silk Nappa leather, Black with Silver stitching QH	S	No charge	No charge
	Silk Nappa leather, Silver with Black stitching SB			

## Colour and trim guide

To help you choose the right interior for your Audi RS 6, please use the guide below which shows the carpet, dashboard and headlining colours that have been matched to your chosen upholstery. (Note that the door inserts will match the colour and material of the seat centre section).

### Standard seats – Interior trim colours

Order code	Upholstery	Carpet	Dashboard	Headlining	Silk Nappa leather N0Q	Valcona leather N5M	Leather/Alcantara N7S
QH	Black	Black	Black	Black	•	•	•
SB	Pearl silver	Black	Black	Black	•	-	-



Image shows optional bucket seats in Valcona leather, Metallic black with Jet grey stitching

# Inlays

Order code

			RRP S	Basic RRP	Total RRP <sup>inc. VAT</sup>
5MB		<b>Carbon</b>	S	No charge	No charge
5TG		<b>Matt-brushed aluminium</b>	•	No charge	No charge
5TL		<b>Piano finish black</b>	•	No charge	No charge
5MR		<b>Fine grain myrtle nutmeg</b>	•	No charge	No charge





## Wheels and tyres

Order code		RRP	Basic RRP	Total RRP <sup>inc. VAT</sup>
CW3 HX7	19 x 9J '10-spoke' design alloy wheels with 255/40 R19 tyres	•	No charge	No charge
PQK	20 x 9.5J '5-segment-spoke' design alloy wheels in titanium finish with 275/35 R20 tyres	•	£173.91	£200.00
PQ1	20 x 9.5J '7-arm double-spoke' design alloy wheels with 275/35 R20 tyres	•	No charge	No charge

## Performance

Order code				
PQQ	Top speed restricted to 174mph (280km/h) including carbon design package for engine bay	•	£1,147.83	£1,320.00
PC5	Ceramic brakes – high-performance brake system with carbon-fibre reinforced, vented and perforated ceramic brake discs. Brake callipers in 'Anthracite' with 'Audi ceramic' logo on front (only in combination with 20" wheels)	•	£5,317.39	£6,115.00



19 x 9J '10-spoke' design alloy wheels



20 x 9.5J '7-arm double-spoke' design alloy wheels



20 x 9.5J '5-segment-spoke' design alloy wheels in titanium finish

Options are subject to availability and may extend delivery.  
• = Available

# Audio and communication

Order code		RRP	Basic RRP	Total RRP <sup>inc. VAT</sup>
9ZW	<b>Bluetooth mobile phone connection</b> , operated via the MMI system and integrated telephone voice-control system, roof-mounted aerial for optimal reception. Please note that your mobile phone must have a SIM-Access profile facility for full functionality	S	No charge	No charge
PT4	<b>Bluetooth mobile phone connection with privacy handset</b> . As bluetooth mobile phone connection with additional cordless privacy handset. The handset allows passengers to make private phone calls, provides remote control of the telephone functions, as well as convenient SMS text-message function. The handset is charged from a docking station, integrated into the front centre armrest (included)	•	£256.52	£295.00
9ZF	<b>GSM mobile-telephone preparation</b> , with hands-free and speech dialogue system for main functions, located in front centre armrest. Bluetooth interface and roof-mounted aerial are included for optimum reception (a phone adaptor is required at extra cost. Please consult your Audi Centre for details)	•	No charge	No charge
PNG	<b>MMI 3G</b> , 3rd Generation of MMI including 2 FM tuners, high resolution (800x400) 7" colour TFT display, 2 SD card readers, DVD-player, 40GB hard drive, 10GB of which can be used to store up to 4,000 songs. HDD Navigation functionality includes advanced speech recognition, 3D and topographical mapping display and advanced 3D building display	S	No charge	No charge
QU1	<b>TV reception, analogue and digital</b> , for reception of 'free-to-air' TV channels. Picture display only possible when the vehicle is stationary. Sound reception at all times	•	£682.61	£785.00



## Seats

Order code		RRP	Basic RRP	Total RRP <sup>inc. VAT</sup>
PS5 6C1	<b>Bucket seats with manual seat adjustment.</b> Electric width adjustment of base and backrest side bolsters and lumbar support. Without front side airbags. Only in combination with Valcona leather (memory function is deleted with this option)	•	£1,691.30	£1,945.00

## Safety and security

Order code				
8T4	<b>Audi adaptive cruise control.</b> Automatic distance regulation, using radar sensors to maintain required distance by braking and accelerating. Four programmes (distance 1 to distance 4) set via steering column controls of the cruise control system	•	£934.78	£1,075.00
7X8	<b>Audi parking system advanced,</b> aids car parking by indicating the distance to obstacles in front of and behind the car – providing an image of the area behind the vehicle on the MMI display. Includes guiding lines. Measured by ultrasonic sensors and camera integrated discreetly in the boot handle	•	£317.39	£365.00
7Y1	<b>Audi side assist.</b> Aids the driver when changing lane. Informs the driver via a visual warning signal in the door mirror if there is a vehicle in the driver's blind spot	•	£382.61	£440.00
4X3	<b>Deletion of rear side airbags</b>	•	No charge	No charge
8N7	<b>High beam assistant,</b> automatically switches between headlamp dipped and high beams	•	£95.65	£110.00





## Interior equipment

Order code		Basic RRP	Total RRP <sup>inc. VAT</sup>
4K7	<b>Advanced key.</b> Access and authorisation system which automatically exchanges data between key and vehicle, allowing the driver to keep the key in their pocket or bag at all times. To unlock and open, simply lift the exterior door handle. To lock, press the button on the handle. Pressing the start/stop button integrated into the centre console starts and stops the engine	£682.61	£785.00
3LE	<b>Door armrest in leather</b>	£178.26	£205.00
2C7	<b>Electrically-adjustable steering column,</b> with memory and adjustment for height, reach and easy-exit function	£256.52	£295.00
VC1	<b>Garage door opener (HomeLink®**).</b> Programmable radio-operated remote control for compatible doors/gates. Control buttons integrated in the roof module at the front	£147.83	£170.00
6NA	<b>Headlining in microfibre Nardia, Black</b>	£1,021.74	£1,175.00
6NT	<b>Headlining in microfibre Nardia, Star silver</b>	£1,021.74	£1,175.00
6NL	<b>Headlining in silver cloth</b>	No charge	No charge
3GN	<b>Load-area fixing kit,</b> with telescopic bar and securing belt for dividing up luggage compartment (Avant only)	£104.35	£120.00
4Y2	<b>Load-area lockable side compartment.</b> Storage compartment cover to right of luggage area, lockable with vehicle key (Avant only)	£34.78	£40.00
PKH	<b>Luggage compartment package,</b> comprising luggage net and 12V socket. (Package standard on Avant models)	£65.22	£75.00
PV6	<b>Memory function for front passenger seat</b> (not available with bucket seats)	£152.17	£175.00
3Y2	<b>Rear window blind,</b> electric (Saloon models only)	£200.00	£230.00
3Y5	<b>Rear window blind,</b> electric, with manual side blinds (Saloon models only)	£278.26	£320.00
6SJ	<b>Reversible mat for luggage compartment,</b> one side in rubber and the other in fabric. Covers whole load-area floor, even when rear seats are folded down	£65.22	£75.00
3Y3	<b>Roll-up sunscreen for rear window and rear side windows</b> (Avant only)	£169.57	£195.00
3Y1	<b>Roll-up sunscreen for rear window</b> (Avant only)	£86.96	£100.00
3X2	<b>Through-load system including removable ski-bag</b>	£134.78	£155.00

## Exterior equipment

Order code		RRP	Basic RRP	Total RRP <small>inc. VAT</small>
PQE	<b>Black styling pack.</b> Radiator grille, number plate holder and frame around radiator grille in high-gloss black, window surround and roof rails (Avant only) in matt black, trim strips on door handles and rear bumper (Saloon only) in body colour. Also includes matt black exhausts pipes	•	£382.61	£440.00
3FE	<b>Electric slide-and-tilt glass sunroof,</b> with position pre-selection and convenience closing	•	£721.74	£830.00
3FR	<b>Electric slide-and-tilt solar panel sunroof,</b> with position pre-selection and convenience closing. Uses the sun's energy to supply a constant flow of air to reduce the temperature inside a parked car	•	£1,000.00	£1,150.00
6FH	<b>Exterior mirrors in vehicle paint colour</b>	•	£73.91	£85.00
PZH	<b>Power door closure.</b> Electrically-operated power doors with soft-close feature	•	£360.87	£415.00
4KF	<b>Privacy glass.</b> Dark-tinted glass from B-pillar backwards	•	£278.26	£320.00
PDG	<b>Twin-pane heat and UV insulating glass,</b> reflective layer reduces interior heat build-up, and provides additional break-in protection (not available in combination with privacy glass)	•	£721.74	£830.00





Every Audi is intrinsically exclusive. It's the breathtaking design, the exceptional engineering, the Vorsprung durch Technik. But for that added element of exclusivity – that distinguishing look that sets you apart from the rest – you can specify your RS 6 with options from Audi exclusive. Whether you want a unique, custom-mixed paint colour, seats in a combination of complementary shades or even individualised carpets and floor mats, Audi exclusive will enable you to drive the car you've always imagined.

For more information on any of the options over the following pages or to view swatches, simply ask a member of staff at your local Audi Centre.

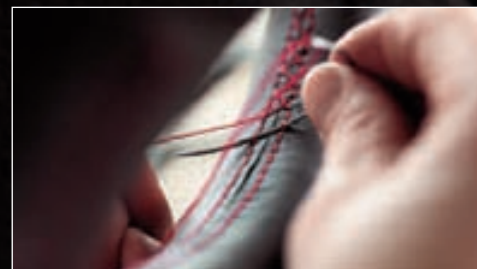
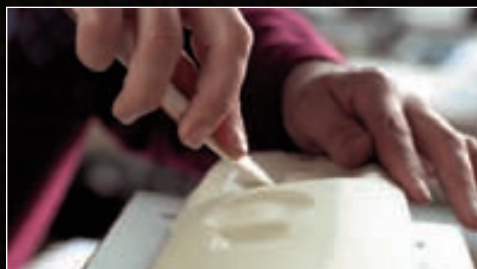



## Upholstery

With Audi exclusive, you can choose between Fine Nappa leather and Alcantara, depending on the texture and flexibility you prefer in your car's upholstery. And once that's decided, you can specify your seats in an array of different colours.

Choose just one all-over shade for each seat, or for a sportier look, customise each panel in two or more complementary colours from the distinctive Audi exclusive palette shown here. You can even choose the colour of the decorative stitching – to match or contrast with your chosen upholstery – from this varied collection. Whatever combination you decide upon, you're guaranteed to be extremely comfortable with the result.

Order code		RS 6	Basic RRP	Total RRP <sup>inc. VAT</sup>
S3G PYC	<b>Leather/Alcantara (package 1)</b> Head restraints, seat side bolsters, front and rear centre armrests in Fine Nappa, leather seat centre section and door trim inserts in Alcantara	●	£2,126.09	£2,445.00
S3G PYB	<b>Valcona leather (package 1)</b> Seat upholstery (with contrasting stitching), head restraints, door trim inserts, front and rear centre armrests in leather	●	£2,126.09	£2,445.00
S3G PYE	<b>Valcona leather (package 2)</b> As above also including armrests in the door panels and backrest covers for front seats. Add-on parts colour matched to chosen leather	●	£4,256.52	£4,895.00
S3G YTO	<b>Seat belts</b> Colour matched to seat upholstery or any colour from exclusive range	●	£1,065.22	£1,225.00

\*Not available in Alcantara.



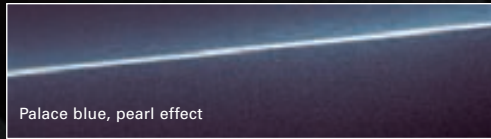

Palace blue, pearl effect

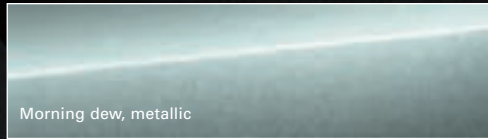

Morning dew, metallic



Sand beige, pearl effect

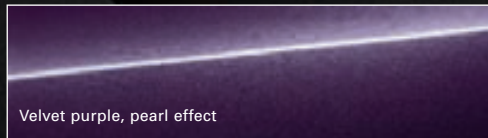

Velvet purple, pearl effect

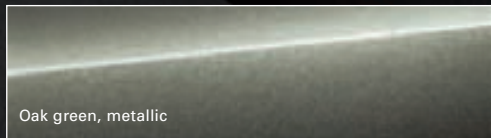

Oak green, metallic

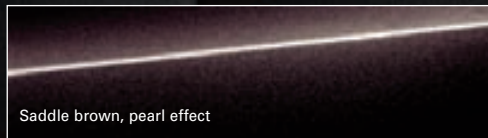

Saddle brown, pearl effect

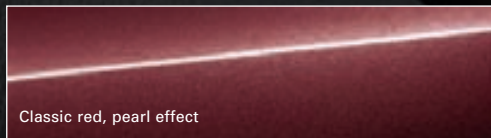

Classic red, pearl effect

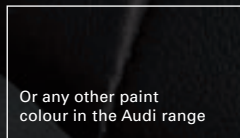

Or any other paint colour in the Audi range

Basic RRP	Total RRP <sup>inc.</sup> <sub>VAT</sub>
£934.78	£1,075.00

## Paint

Everyone has a favourite colour. No matter what yours is, Audi exclusive provides a range of unique colours that have been designed to set your car apart. Choose from the swatches here, or specify any other paint colour in the Audi range – whether it's Jet blue from the Audi R8 or Alpine white from the original Audi quattro®. The choice is yours.

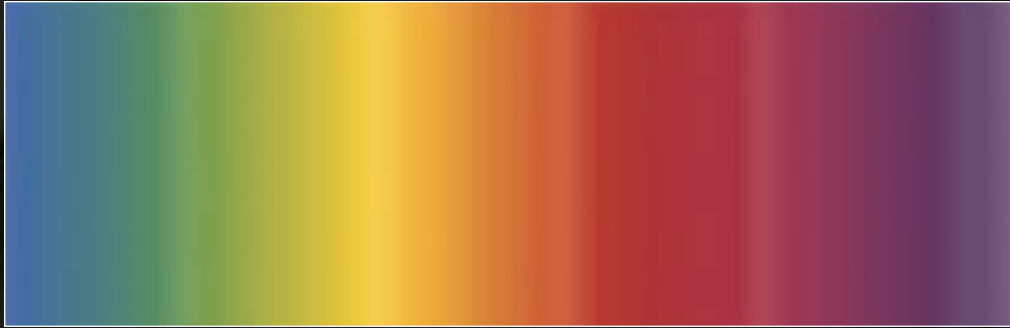

## Customised paint

In a car made from Vorsprung durch Technik, there are no compromises. So if you have a particular colour in mind, we'll mix the exact water-based metallic or pearl-effect shade you want – whether it's the blue of your favourite shirt or the wall colour in your sitting room.

Basic RRP	Total RRP <sup>inc.</sup> <sub>VAT</sub>
£1,530.43	£1,760.00

## Carpets and floor mats

Exclusivity isn't just about choice and individuality – it's about attention to every detail in your Audi RS 6; and for us, that includes the carpets and floor mats. First, choose from nine different colours of high-quality velour carpets. Next, choose the colour of your car's floor mats from the same list, whilst using the palette of Audi upholstery colours detailed on page 25 to select a leather colour for the mats' decorative leather piping – matched or contrasting, depending on your personal taste. Floor mats are included when you order Audi exclusive carpet; but if you wish, floor mats can also be purchased separately as a set.

Order code		RS 6	Basic RRP	Total RRP <small>inc. VAT</small>
S3G YSO	Carpets	•	£1,278.26	£1,470.00
S3G YSR	Floor mats	•	£256.52	£295.00
S3G YTZ	Floor mats in black with RS 6 logo (specify black or silver piping)	•	£317.39	£365.00



## Carpet colours

- ▶ Alabaster white
- ▶ Magnolia
- ▶ Sand beige
- ▶ Havana brown
- ▶ Cocos
- ▶ Cognac
- ▶ Chestnut brown
- ▶ Palace blue
- ▶ Amethyst grey

## Steering wheels and controls pack

Our fingertips and palms contain more touch receptors than any other part of our body – so shouldn't the parts of our car we handle the most also be the most pleasing to touch? With this in mind, Audi exclusive enables you to customise your steering wheel, gear knob and gaiter in smooth, warm leather, in any of the colours shown on page 25. As with Audi exclusive seats, you even have free choice on the colour of the decorative stitching used.

Order code		RS 6	Basic RRP	Total RRP <small>inc. VAT</small>
YRB	Controls pack	•	£382.61	£440.00
S3G YUC	RS leather multi-function Sports steering wheel. Black suede, including selector lever in suede	•	£256.52	£295.00
S3G YRH	Leather steering wheel rim from exclusive colour range (not available in conjunction with controls pack)	•	£326.09	£375.00

# Inlays

Inlays are the all-important ‘finishing touch’ that add flair and interest to the surfaces inside your car. So Audi exclusive has sourced a hugely varied range of materials from which to craft these elements – from rich quilted maple wood to clean, contemporary brushed aluminium. You can even customise your gear knob and steering wheel with one of the available woods, all of which are shown opposite.

Order code		RS 6	Basic RRP	Total RRP <sup>inc. VAT</sup>
S3G YTA	Inlays	•	£765.22	£880.00
S3G YSN	Leather cockpit driver’s side (black only)	•	£765.22	£880.00

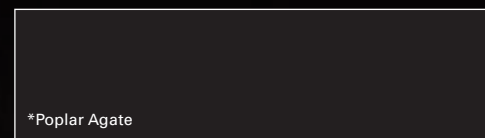
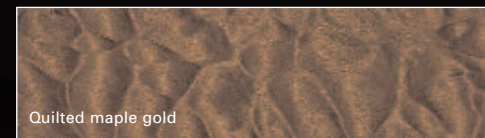
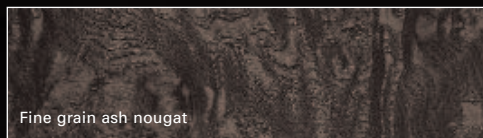
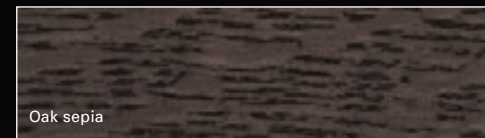
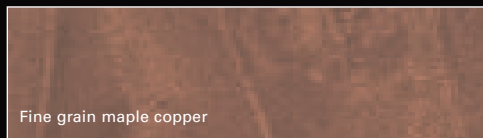

\*No swatch available at time of publication.

# Technical data

## RS 6 Petrol

### Saloon

Engine	Cylinder	Displacement, cubic cm (valves per cylinder)	Max. power PS <sup>1</sup>	Max. torque, Nm at rpm	Transmission	CO <sub>2</sub> emissions, g/km <sup>2</sup>	0-62mph acceleration, seconds	Top speed, mph	ABI insurance group
5.0 TFSI	10-cylinder	4991 (4)	580	650/1500-6250	6-speed tiptronic®	331	4.5	155*	20E

### Avant

5.0 TFSI	10-cylinder	4991 (4)	580	650/1500-6250	6-speed tiptronic®	333	4.6	155*	20E
----------	-------------	----------	-----	---------------	--------------------	-----	-----	------	-----

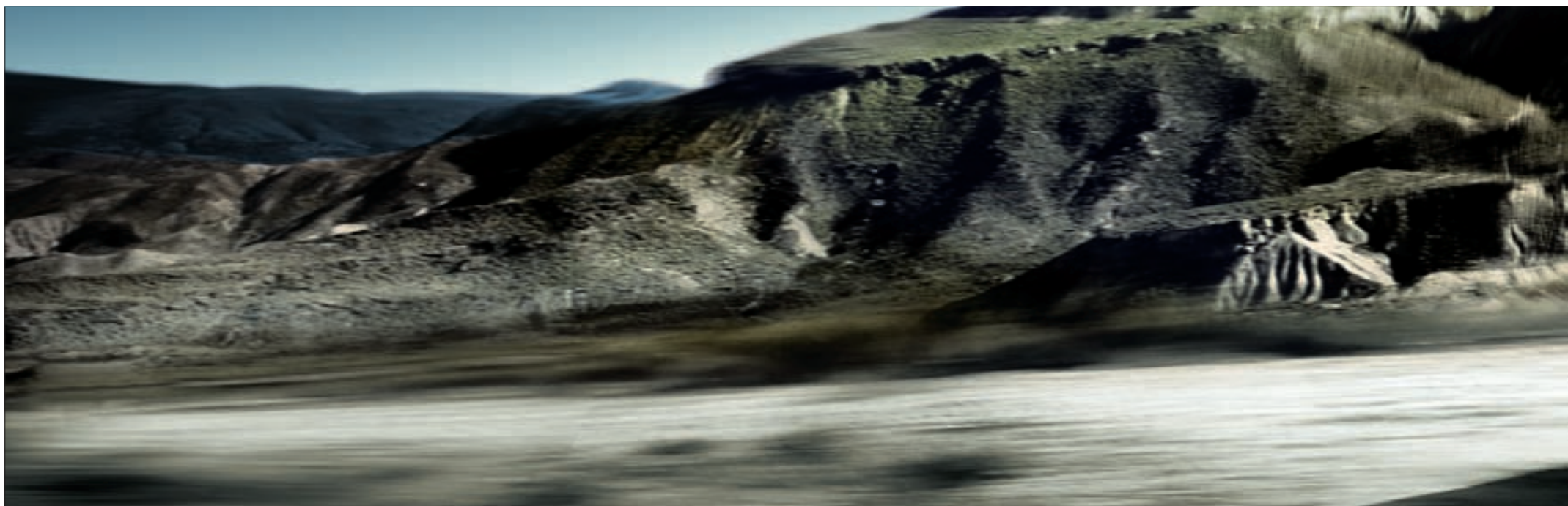

<sup>1</sup> The given value was obtained in accordance with the specified measurement procedure (the respective current version of Directive 80/1269/EEC).

<sup>2</sup> The given values were calculated in accordance with the specified measurement procedure (the respective current version of Directive 80/1268/EEC). This information does not relate to a single vehicle and does not comprise part of the offer but is merely intended for the purpose of comparison between the different vehicle types.

Unladen weight <sup>3</sup>	Weights, kg		Max. trailer load, kg <sup>4</sup>			Volumes		Fuel consumption, mpg (l/100km)		
	Gross weight limit	Roof load limit	unbraked	with 12% gradient	with 8% gradient	Luggage compartment capacity, litres	Fuel tank capacity approx, litres	Urban	Extra Urban	Combined
1985	2565	100	n/a	n/a	n/a	546	80	13.9 (20.3)	27.7 (10.2)	20.3 (13.9)
2025	2655	100	n/a	n/a	n/a	565, 1660 <sup>5</sup>	80	13.8 (20.4)	27.4 (10.3)	20.2 (14.0)



<sup>3</sup> Vehicle's unladen weight without driver (calculated in accordance with the current version of Directive 92/21/EEC). The fitting of additional equipment may increase the vehicle's unladen weight and drag coefficient, whereupon the potential carrying capacity and top speed will be correspondingly reduced.

<sup>4</sup> Vehicle not suitable for towing equipment.  
<sup>5</sup> Loaded up to roof with rear seat folded down.

\*Electronically limited

# Dimensions

## RS 6 Saloon

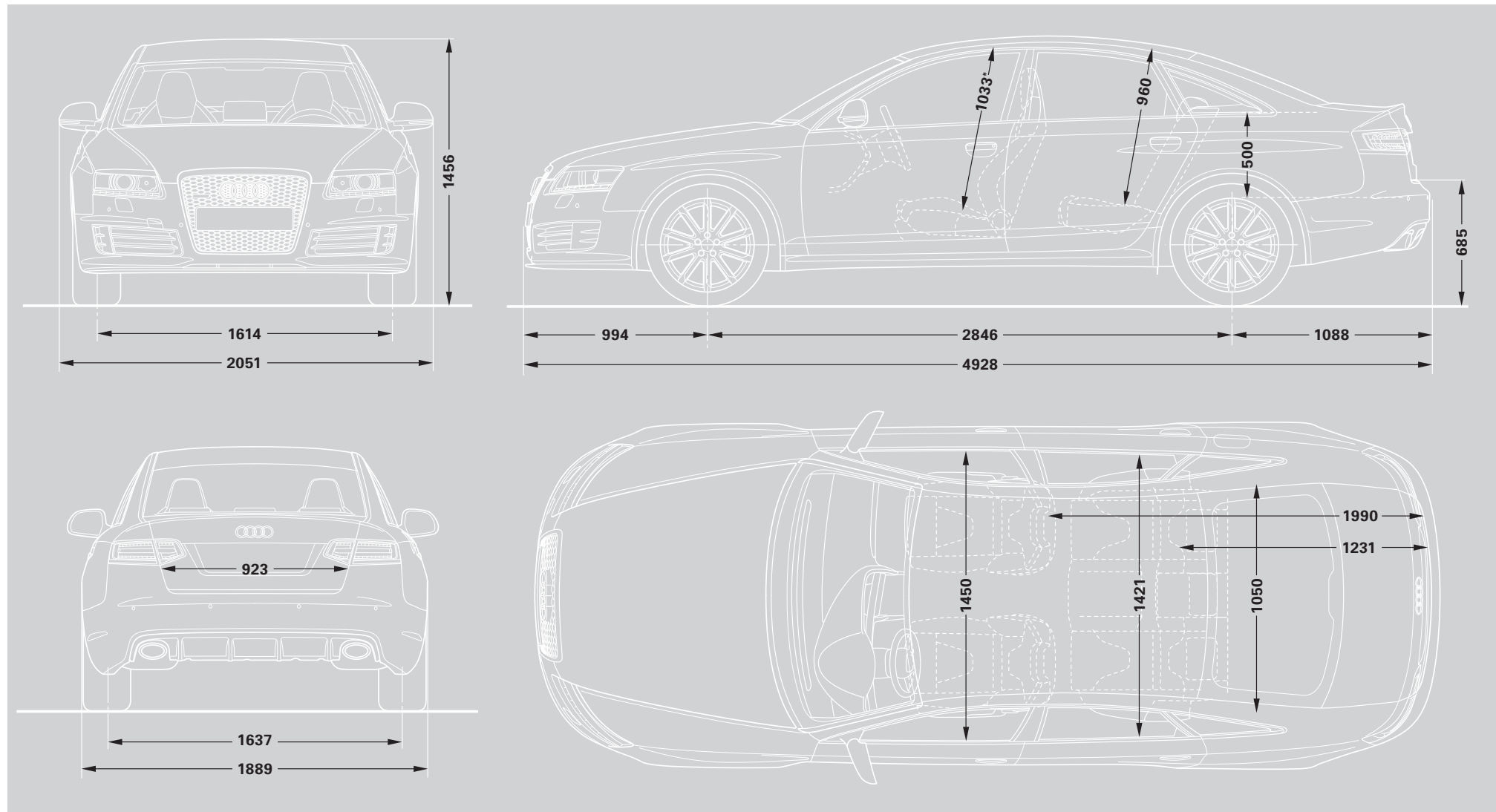

Dimensions were measured with vehicle at unladen weight, ground clearance measured with vehicle carrying its maximum load. Luggage compartment volume in litres: 565/1660 (measured by the VDA standard test method using 200 x 100 x 50mm blocks; second value: with rear seat folded down). Turning circle approx 12.2m

Dimensions in millimetres  
\*Maximum headroom

# RS 6 Avant

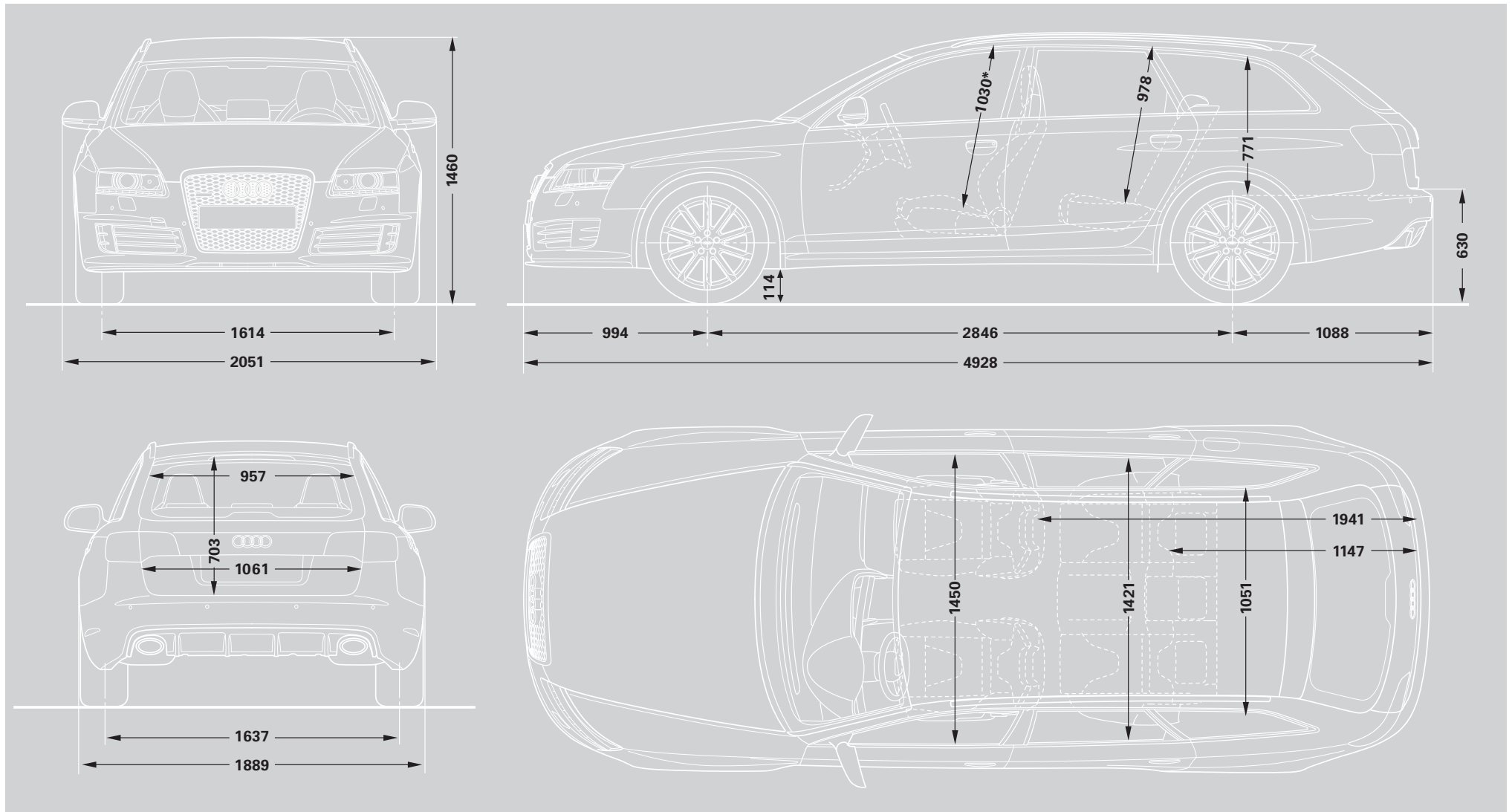

Dimensions were measured with vehicle at unladen weight, ground clearance measured with vehicle carrying its maximum load. Luggage compartment volume in litres: 565/1660 (measured by the VDA standard test method using 200 x 100 x 50mm blocks; second value: with rear seat folded down). Turning circle approx 12.2m

Dimensions in millimetres  
\*Maximum headroom



# Additional information

## CO<sub>2</sub> data and information

### CO<sub>2</sub> emissions-based Vehicle Excise Duty

Vehicle Excise Duty (Road Fund Licence) is based upon the amount of Carbon Dioxide (CO<sub>2</sub>) a vehicle emits, measured in grams per kilometre (g/km). The DVLA has created seven categories:

Petrol and Diesel engines	
A – up to 100g/km	£0.00
B – 101 to 120g/km	£35.00
C – 121 to 150g/km	£120.00
D – 151 to 165 g/km	£145.00
E – 166 to 185 g/km	£170.00
F – 186 to 225g/km	£210.00
G – over 225g/km	£400.00

## Audi Service

### Servicing tailored to your needs

Regular servicing is key to safeguarding your Audi's performance and a full Audi service history could help you preserve the future re-sale value. To make servicing easy, the Audi Service Schedules have been designed to work with your individual driving style and vehicle.

There are two schedules available and your Audi Centre will advise which schedule is most suited to your needs.

The conventional fixed Audi Inspection Service schedule has fixed intervals for the Oil-change and Inspection Service that are based on time and distance, whichever comes first. With the Audi LongLife Service schedule, sensors take account of driving style and conditions in which the vehicle is used to indicate when the Oil-change Service is required. Oil-change Service intervals are therefore variable and are conveniently indicated via the on-board service interval display.

Fixed Audi Inspection Service intervals:	
<b>Oil-change Service</b>	Fixed to approximately every 10,000* miles/1 year
<b>Inspection Service</b>	Fixed to approximately every 20,000* miles/3 years, then approximately every 20,000* miles/2 years thereafter

Audi Longlife Service intervals:	
<b>Oil-change Service</b>	Variable to a maximum of approximately every 20,000* miles/2 years
<b>Inspection Service</b>	Fixed to approximately every 20,000* miles/3 years, then approximately every 20,000* miles/2 years thereafter

\*As indicated by the service interval display. Mileages are approximate as the Service Indicator system uses kilometres as its distance measurement.

## Service by Design

At Audi, we believe our customers can expect excellent service each and every time they make contact with us. To ensure that this happens, we have agreed a set of service standards with our Audi Centre network that governs the way they do business with you. These standards apply to both Sales and Aftersales, and we actively monitor our Centres to ensure that you receive the highest level of customer service. These service standards will ensure a consistent, stress-free experience whenever you are in contact with anyone representing the Audi brand.

### Every Audi Centre will be open during the following hours:

**Sales:** 9am-6pm Monday to Friday  
9am-5pm Saturday

**Service:** 8am-6pm Monday to Friday  
8.30am-1pm Saturday

Sunday opening at local discretion.

### Test drives

Whilst we cannot always have the desired demonstrator car ready immediately, we will confirm arrangements for a test drive within two working days (subject to status).

### New Car delivery

Once we have confirmed a delivery date with you, we will keep you informed of progress. In the unlikely event of a delay, we will provide you with a courtesy car to minimise inconvenience and keep you mobile.

### Delivery to any location within the UK

To maximise your Audi experience right from the first day of ownership, we will deliver your car to your preferred location – whether that's home or your place of work (subject to reasonable notice).

### Attention to every detail

Your ownership experience starts with half a tank of fuel.

### Quotation response

We are committed to answering any quotation request within 1 working day.

### Training

We run a continuous training development programme for all our staff so that we consistently deliver a high-quality, professional service.

### Formal complaints procedure

We have a complaints procedure designed to ensure any negative issue you raise with us is dealt with properly.

### Courtesy cars

When your car is off the road, perhaps due to a scheduled service or MOT, we will offer you an Audi Courtesy Vehicle until yours is ready. We'll even collect from and deliver to your chosen location, keeping hassle to an absolute minimum.

### Service bookings

If you do not require a courtesy car, we will service your Audi within a maximum of 5 working days. If you do choose to take a courtesy car, we will promise to service your vehicle within a maximum of 10 working days.

### Cleaning

When your car comes to our workshop, we will wash and vacuum it at no extra cost.

### No hidden charges

You will be consulted before we carry out any necessary work on your vehicle, and anything charged for will be itemised on your bill. No extra work will be undertaken without your permission.

### A personal service

All work will be done by a named Audi Technician, to whom you can personally direct questions or requests should you need to.

### Environmental commitment

We promise to dispose of all non-biodegradable materials from your vehicle in a responsible manner.



## Pricing information

### Pricing

Prices and specifications given are correct at the time of printing. Always check details with your Audi Centre, as Audi policies are continually developing. We reserve the right to change prices or specifications at any time.

All prices are subject to VAT, currently charged at 15%.

Delivery charges and number plates are not included in the vehicle price.

<u>Delivery charge</u>	<u>£471.30</u>
<u>Number plates</u>	<u>£20.00</u>
<u>VAT</u>	<u>£73.70</u>
<u>Total</u>	<u>£565.00</u>

### Audi Roadside Assistance

Your new car comes complete with complimentary roadside assistance and recovery across the UK provided by RAC Motoring Services. Also included is roadside assistance throughout Europe, managed by RAC Motoring Services

### Audi Customer Care

Every new Audi benefits from the comprehensive Audi Customer Care Package, which comprises:

- ▶ A 3-year Audi warranty, which covers you for unlimited mileage in the first 2 years of ownership, with a full mechanical and electrical warranty which covers you for up to 60,000 miles in the third year
- ▶ A 3-year paint warranty
- ▶ A 12-year anti-corrosion warranty
- ▶ Up to 3 years' UK roadside assistance and recovery

This package, together with Audi variable Service intervals, offers a combination unmatched by any other major manufacturer. Contact your Audi Centre for full details.

### Audi Tax-Free Sales

If you are entitled to purchase a vehicle free of VAT, normally through Military or Diplomatic privilege, please contact your local Audi Centre for full details.

Should you have any difficulty obtaining the information you require, please call Freephone 0800 585878.

### Audi Finance

Audi Finance specialise in providing funding solutions for Audi drivers. Whether your Audi is for private or business use, there is a range of funding options to choose from.

Below is the full range of finance products.

- ▶ Solutions – a Personal Contract Plan
- ▶ Hire purchase
- ▶ Lease purchase
- ▶ Finance lease
- ▶ Contract hire

With all products, you can choose a fixed-cost maintenance plan designed to help you budget accurately.

No matter what Audi model you choose, your local Audi Centre can provide you with a personalised quote which could fit your budget and motoring needs.

Audi Finance is a trading name of Volkswagen Financial Services (UK) Limited. An offer of finance depends on certain conditions. Available to people over 18 in the UK only.

### Audi Insurance

Competitive comprehensive motor insurance designed specially for Audi drivers. All new Audi models come with complimentary seven-day cover upon request – we'll email a cover note directly to your Audi Centre, enabling them to tax your car easily. This way, you can drive straight out of the showroom. Taking out an annual policy is easy and can begin as soon as your free seven-day cover expires.

For more information, contact your local Audi Centre. Alternatively, call 0800 051 3146 for a quote and to receive 7 days' complimentary cover for your new Audi.

Audi Insurance is underwritten and administered by Zurich Insurance Company.

## Notes

## Notes

**Audi UK**

Customer Services  
Selectapost 29  
Sheffield  
S97 3FG  
0800 699888  
audi.co.uk

Specifications and prices subject  
to change without notice.

© Audi UK

Printed in the UK  
Edition 3.3 10/09  
2009 Model year



**Mixed Sources**  
Product group from well-managed  
forests and other controlled sources

Cert no. TT-COC-002327  
[www.fsc.org](http://www.fsc.org)  
© 1996 Forest Stewardship Council