



The TT Coupé and Roadster
Pricing and Specification Guide
Valid from May 2009

A User's Guide

This guide has been designed to help you tailor and price your TT quickly and logically. At the back of this guide you will find information on CO2 emissions-based vehicle excise duty and the other services offered by Audi, including Finance and Insurance.

Alternatively, you can go to audi.co.uk and configure your TT online.

From the website, you can also access the Audi Channel player and see your potential new car in action on the following programmes:

Drivetime

www.audi.co.uk/TTRoadsterdrivetime

www.audi.co.uk/TTCoupedrivetime

Your Audi

www.audi.co.uk/TTCoupeyouraudi

Alternatively, you can tune into the Audi Channel at any time on Sky Guide No. 884 to see a range of programmes about Audi and our motorsport achievements.



Table of content

Page Number

Introduction	
TT	
Engines	6
quattro®	7
Model details and prices	
Standard models	8
S line models	10
TTS models	12
Transmission	16
Colour and upholstery	
Paint finishes	18
Hood colours	20
Upholstery options	22
Colour and trim guide	26
Inlays	30
Options	
Wheels, tyres and suspension	32
Audio and communication	34
Seats	36
Safety and security	38
Interior equipment	40
Audi Centre-fitted Accessories	42
Audi exclusive	
Audi exclusive options	44
Audi exclusive line	48
Technical details	
Technical data	50
Dimensions	52
Additional information	56

TT

When the first Audi TT launched back in 1999, an icon was born. Unique, distinctive, unmistakably Audi. Not an easy achievement to follow – but Vorsprung durch Technik demands that we never stand still, never stop innovating, never cease to evolve. So we created the next generation Audi TT. Everything that was great about its predecessor made greater.

Two different body styles are available – Coupé and Roadster. Both of which are offered with quattro® and the innovative S tronic automatic transmission technology, described in more detail on pages 16 and 17. In addition to a 3-spoke flat-bottom leather steering wheel and aluminium interior detailing, all TT models feature front Sports seats, climate control and an aerodynamic rear spoiler which automatically extends as soon as the car reaches 74 mph.* And the driving experience is equally sporty. The TTS quattro is capable of reaching an electrifying top speed of 155mph,** producing 272PS and accelerating from 0-62mph in just 5.4 seconds (5.2 seconds for the S tronic version). That's the kind of power that will press your tingling spine back into its Fine Nappa leather Sports seat.

Read on to discover more about the awesome Audi TT, including standard and optional equipment, paint colours and prices.



Engines

Petrol

There are two kinds of petrol engines available on the TT – the standard petrol engine and the TFSI® turbo-charged direct-injection engine. TFSI® is a unique Audi innovation, combining turbo-charging with the FSI® technology originally developed for the Le Mans 24-hour endurance race to deliver increased power and torque as well as enhanced fuel efficiency. The way it does this is, in theory, very simple. Precisely the right amount of fuel and air are injected directly into the combustion chambers, enabling the engine to 'breathe' more easily. At the same time, electronics monitor the engine load and adjust the injection process. The result – reduced heat-loss and increased output, with around a 15% reduction in fuel consumption and significantly lower exhaust emissions. Ideal for the buyer who wants a sporty, exhilarating drive without the drawbacks of excessive fuel costs or high emissions.

Diesel

We introduced TDI to the roads in 1989, marking a departure from the noisy, fuel-thirsty diesel engines of the past. And since then, we've continuously refined it, recently developing common-rail technology for even more efficiency and power. Under this system, a series of piezo injectors use electrical charge to control precisely the amount of fuel injected into the engine. As well as reducing noise, this allows combustion to happen at a lower temperature, with less oxygen, which cuts down emissions. In fact, it means that the new 2.0 TDI engine already complies with the proposed EU 5 emission limits planned for 2010. So not only does common-rail technology help to protect the environment, it also enables us to future-proof our cars.



quattro®

It's the technology that has given Audi the edge on the racetrack ever since it was first introduced over 25 years ago – a technology that delivers ultimate control whilst enhancing the sporty characteristics which make the TT so thrilling to drive. It's called quattro® all-wheel-drive. The principle is simple: in the same way that four brakes ensure better deceleration, four driven wheels deliver better acceleration and road-holding, pushing or pulling the car as needed, for a driving experience that's both dynamic and safe. In the TT, drive power is continuously distributed between the front and rear axles depending on weather conditions, road surface and gradient.



Standard model equipment

All TT models have the following items of standard equipment:

Wheels, tyres and suspension

17 x 8.5J '7-Y-spoke' design alloy wheels with 245/45 R17 Y tyres (1.8 TFSI Roadster only)

Tyre Mobility System

Audio and communication

Audi Chorus radio, with front loading CD player (1.8 TFSI Roadster only)

Seats

Front Sports seats

Tetrus cloth (1.8 TFSI Roadster only)

Safety and security

Anti-lock Braking System (ABS)

Anti-Slip Regulation (ASR) – traction control

Anti-theft device – Thatcham Category 1 approved

Driver and front passenger airbags

Electronic Differential Lock (EDL) – traction control

Electronic Stability Programme (ESP)

First-aid kit

Front ISOFIX and front passenger airbag de-activation switch

Locking wheel bolts

Roll-over protection hoops (Roadster only)

Servotronic – electro-mechanical, speed-sensitive, power-assisted steering

Side airbags for front seats

Tool kit and car jack

Warning triangle

Interior equipment

3-spoke Sports 'flat-bottom' design leather steering wheel

Aluminium Laser interior detailing

Black leather handbrake grip, centre console armrest pad and door handle

Driver's Information System (DIS)

Electronic climate control

Front floor mats

Fully automatic electrically-operated soft-top which opens in 12 seconds, with integrated wind deflector (Roadster only)

Exterior equipment

Door mirrors – electrically operated and heated

Electric front windows

Exhaust pipes – twin on left-hand side

Front and rear fog lights

Halogen headlights

Retractable rear spoiler, which deploys and retracts automatically at set speeds or with centre console button

Additional items for 2.0 TFSI, 2.0 TFSI quattro® and 2.0 TDI quattro® models:

17 x 8J '5-arm Trapezé' design alloy wheels with 225/50 R17 Y tyres

Concert audio system – MP3 file-compatible single CD player and radio with 9 loud speakers (140 Watt) and 5-channel amplifier including aux-in socket

Leather/Alcantara upholstery

Split-folding rear seat (Coupé only)

Additional equipment for 3.2 quattro® models:

18 x 9J 10-spoke design alloy wheels with 245/40 R18 Y tyres

Enhanced braking system

Exhaust pipes – single on left and right-hand side in chrome rolled finish

Exterior light styling pack – chrome detailed headlight-surrounds and darkened rear light clusters

Fine Nappa leather upholstery

Heated front seats

Phantom black painted grille

quattro® all-wheel-drive



Aluminium foot pedals – part of Aluminium Laser interior detailing



Fine Nappa leather upholstery and integrated wind deflector (Roadster only) – standard on 3.2 models

Standard model prices

Coupé – Petrol

Engines	Power	Transmission	Basic RRP	Total RRP ^{inc. VAT}	Recommended OTR
2.0 TFSI	200PS	6-speed manual	£21,413.04	£24,625.00	£25,420.00
2.0 TFSI quattro®	200PS	6-speed S tronic®	£23,839.13	£27,415.00	£28,210.00
3.2 quattro®	250PS	6-speed manual	£25,326.09	£29,125.00	£30,150.00

Coupé – Diesel

Engines	Power	Transmission	Basic RRP	Total RRP ^{inc. VAT}	Recommended OTR
2.0 TDI quattro®	170PS	6-speed manual	£22,421.74	£25,785.00	£26,525.00

Roadster – Petrol

Engines	Power	Transmission	Basic RRP	Total RRP ^{inc. VAT}	Recommended OTR
1.8 TFSI	160PS	6-speed manual	£20,126.09	£23,145.00	£23,915.00
2.0 TFSI	200PS	6-speed manual	£23,065.22	£26,525.00	£27,360.00
2.0 TFSI quattro®	200PS	6-speed S tronic®	£25,491.30	£29,315.00	£30,110.00
3.2 quattro®	250PS	6-speed manual	£26,978.26	£31,025.00	£32,050.00

Roadster – Diesel

Engines	Power	Transmission	Basic RRP	Total RRP ^{inc. VAT}	Recommended OTR
2.0 TDI quattro®	170PS	6-speed manual	£24,073.91	£27,685.00	£28,430.00



17 x 8.5J '7-Y spoke' design alloy wheels – standard on 1.8 TFSI Roadster



17 x 8J '5-arm Trapez' design alloy wheels – standard on 2.0 TFSI and 2.0 TDI models



18 x 9J '10-spoke' design alloy wheels – standard on 3.2 models



In addition to Standard model equipment:

	Basic RRP	Total RRP <small>inc. VAT</small>
4-cylinder	£1,404.35	£1,615.00
6-cylinder	£895.65	£1,030.00

Wheels, tyres and suspension

18 x 9J '5-spoke design' alloy wheels with 245/40 R18 tyres
S line Sports suspension lowered by 10mm

Seats

S line embossed front Sports seats. Fine Nappa leather (6-cylinder models); leather/Alcantara (4-cylinder models)

Interior equipment

3-spoke S line multi-function leather steering wheel (includes paddle shift gear for S tronic models)
Black headlining
Short-shift manual gearbox
Matt-brushed aluminium inlays
Door sill trims with S line badge

Exterior equipment

Chrome plated tailpipe (for 4-cylinder models)
Headlight washers
S line exterior package:
- S line design front and rear bumpers, side grilles and diffusers in platinum grey



18 x 9J '5-spoke design' alloy wheels



3-spoke S line multi-function leather steering wheel

S line model prices

Coupé – Petrol

Engines	Power	Transmission	Basic RRP	Total RRP ^{inc. VAT}	Recommended OTR
2.0 TFSI	200PS	6-speed manual	£22,817.39	£26,240.00	£27,035.00
2.0 TFSI quattro®	200PS	6-speed S tronic	£25,243.48	£29,030.00	£29,825.00
3.2 quattro®	250PS	6-speed manual	£26,221.74	£30,155.00	£31,180.00

Coupé – Diesel

Engines	Power	Transmission	Basic RRP	Total RRP ^{inc. VAT}	Recommended OTR
2.0 TDI quattro®	170PS	6-speed manual	£23,826.09	£27,400.00	£28,140.00

Roadster – Petrol

Engines	Power	Transmission	Basic RRP	Total RRP ^{inc. VAT}	Recommended OTR
2.0 TFSI	200PS	6-speed manual	£24,469.57	£28,140.00	£28,975.00
2.0 TFSI quattro®	200PS	6-speed S tronic	£26,895.65	£30,930.00	£31,725.00
3.2 quattro®	250PS	6-speed manual	£27,873.91	£32,055.00	£33,080.00

Roadster – Diesel

Engines	Power	Transmission	Basic RRP	Total RRP ^{inc. VAT}	Recommended OTR
2.0 TDI quattro®	170PS	6-speed manual	£25,478.26	£29,300.00	£30,045.00



TTS model equipment:

Since its launch, the Audi TT has become a motoring icon. There's no mistaking its sleek curves and unique form, but there's something extra-special about the new TTS. Not only does it feature 18" alloy wheels and a sports exhaust system, but it also happens to be the most powerful TT we've ever made. Its athletic 2.0-litre TFSI engine

delivers 350Nm of torque and is capable of taking you from 0 to 62mph in 5.2 exhilarating seconds. For this model, a number of key engine components were re-engineered in order to optimise performance and handling. The result: an even more dynamic and responsive TT.

Wheels, tyres and suspension

18 x 9J '5 parallel-spoke' design alloy wheels with 245/40 R18 tyres

Audi magnetic ride – 'S' version – 10mm lower ride height

Seats

Silk Nappa leather upholstery – two-tone with seat centres in Silver, Magma red or Signal orange. Seat side sections and head restraints in black with decorative stitching to match seat centres. Seats also available in all-over black with silver stitching

Safety and security

ESP – with Sport mode

TTS enhanced braking system with black painted brake callipers with TTS logo

Xenon Plus headlights with LED daytime-driving lights and headlight washer system

Interior equipment

3-spoke 'flat-bottom' multi-function steering wheel with TTS badge (with paddle-shift gear-change on S tronic models)

Extended leather package – black with decorative stitching to match seat centres

Front floor mats with leather piping to match seat centres

Instrument dials in grey with white illumination and TTS logo

Leather and aluminium gear knob with TTS logo

Matt-brushed aluminium interior detailing

Short-shift manual gearbox

Exterior equipment

Aluminium-look door mirror housings

'S' Platinum grey grille with double vertical chrome struts and TTS badge

Scuff plates with TTS logo

Sports exhaust system with twin exhaust pipes on left and right-hand side in chrome rolled finish

TTS body styling – re-styled front and rear bumpers and side sill extensions



Leather and aluminium gear knob with TTS logo



Instrument dials in grey with white illumination



18 x 9J '5 parallel-spoke' design alloy wheels

TTS model prices

Coupé

Engines	Power	Transmission	Basic RRP	Total RRP <small>inc. VAT</small>	Recommended OTR
TTS quattro®	272PS	6-speed manual	£28,339.13	£32,590.00	£33,425.00

Roadster

Engines	Power	Transmission	Basic RRP	Total RRP <small>inc. VAT</small>	Recommended OTR
TTS quattro®	272PS	6-speed manual	£29,991.30	£34,490.00	£35,325.00



Recommended On-The-Road (OTR) retail prices include: delivery charge, half a tank of fuel, number plates at £565.00 (inc. VAT) and Road Fund Licence (which may vary depending on model/transmission. See page 56 for details) and first registration fee at £55.00.

RRP – Recommended Retail Price.





Transmission

S tronic

The revolutionary S tronic gearbox combines the agility and responsiveness of a conventional 6-speed manual gearbox with the convenience and smooth, uninterrupted power of an automatic transmission. The technical basis of the S tronic gearbox is the double clutch. This consists of two lubricated plates with hydraulically-regulated contact pressure. One engages the odd-numbered, the other the

even-numbered gears, enabling gear-shifts to be made in a fraction of a second, with no disruption to the power flow. Depending on how the mood takes you, you can either allow gear-changes to take place automatically or, for a sportier driving style, operate the S tronic system using the gear lever or steering wheel shift-paddles. The choice is yours.

Short-shift manual transmission

For fast, crisp gear changes in a sporty, manual set-up, you can choose to specify your Audi TT with short-shift manual transmission. This simple yet effective gear-change pattern means that the gearstick has a shorter distance to travel between each shift-gate, minimising the effort you have to make with each up or down-shift, whilst maximising your driving enjoyment.



Transmission

	1.8 TFSI Roadster	2.0 TDI quattro®	2.0 TFSI	2.0 TFSI quattro®	3.2 quattro®	TTS quattro®	Basic RRP	Total RRP ^{inc. VAT}
Automatic S tronic transmission (6-speed)	-	-	•	S	•	•	£1,234.78	£1,420.00
Short-shift manual gearbox (Standard on S line models with manual transmission)	•	•	•	-	•	S	£126.09	£145.00

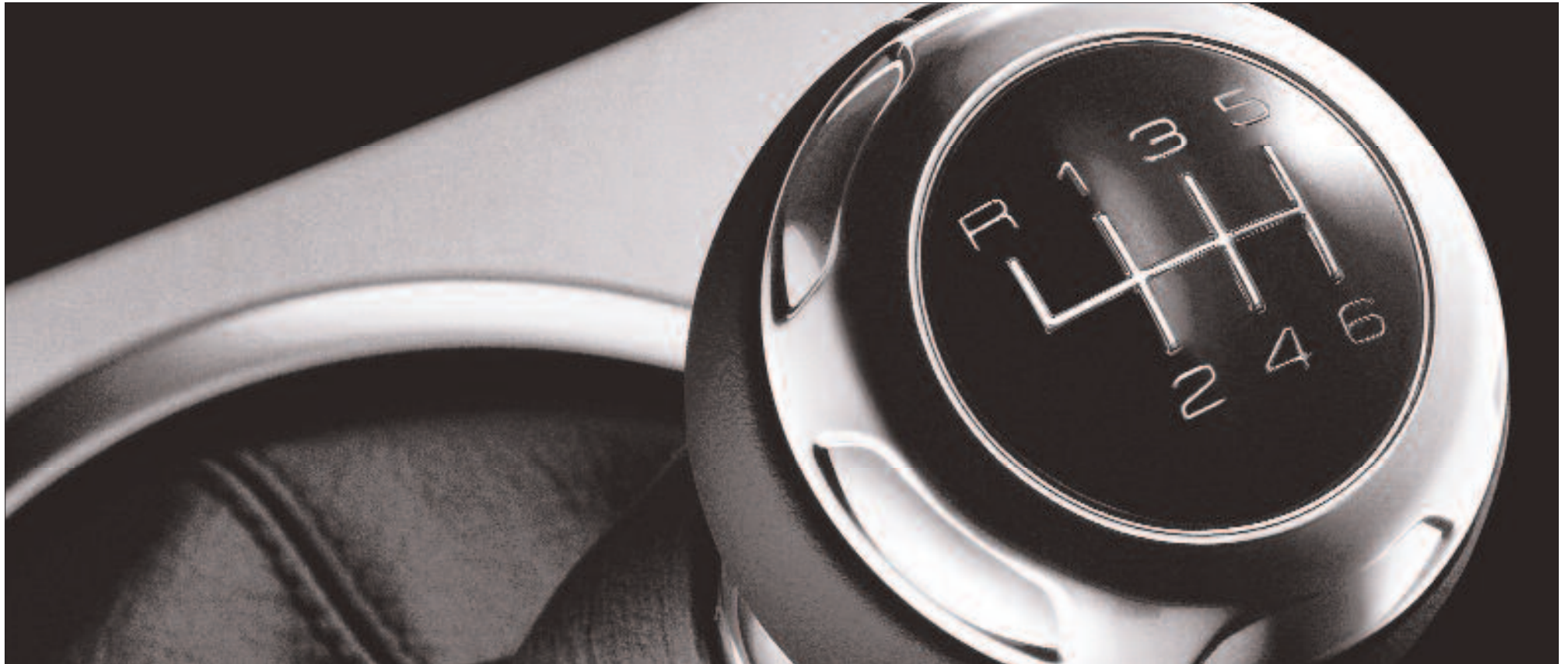

- = Not available

• = Available

S = Standard

RRP – Recommended Retail Price.

Paint finishes

Standard colours



Brilliant black

A2



Brilliant red

C8



Ibis white

T9

Optional colours

Basic RRP	Total RRP <small>inc. VAT</small>
£426.09	£490.00



Condor grey, metallic

5Q

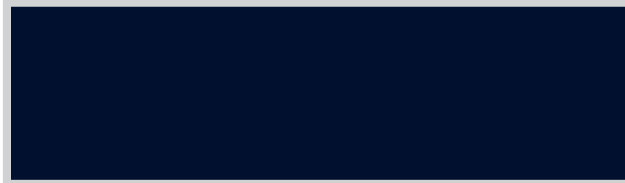

Deep Sea blue, pearl effect

8A

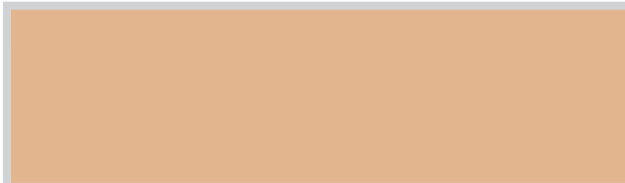

Dakar beige, metallic (not available on TTS)

9X



Ice silver, metallic (not available on Roadster)

P5

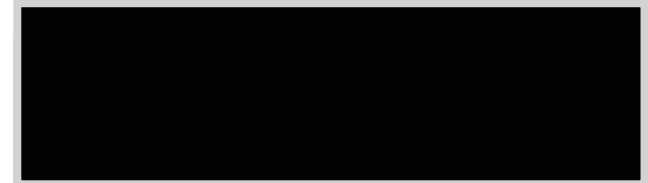

Phantom black, pearl effect

L8

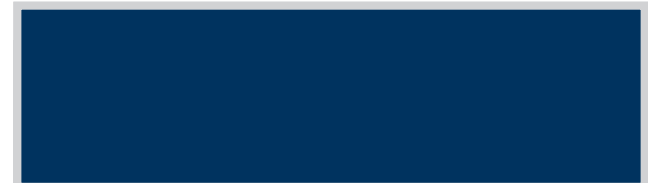

Aruba blue, pearl effect (not available on TTS or Roadster)

Q9

S line colours

Basic RRP	Total RRP <small>inc. VAT</small>
£426.09	£490.00



Sahara silver, metallic

9T

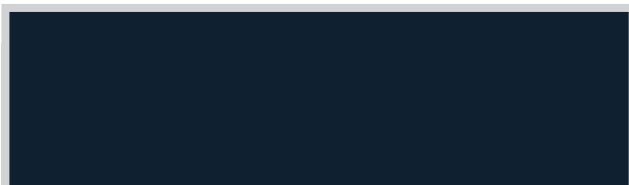

Meteor grey, pearl effect

X5

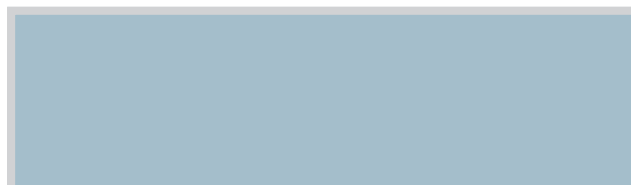

Monza silver, metallic

U7



Misano red, pearl effect

N9

TTS additional colours

Basic RRP	Total RRP <small>inc. VAT</small>
£426.09	£490.00



Solar orange

3F

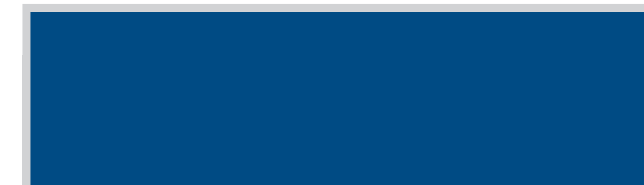

Sprint blue, pearl effect

5N



Imola yellow

1T

Hood colours



Black

PA

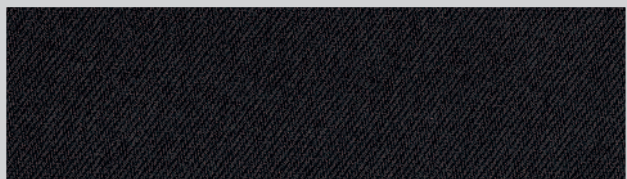

Dark grey

SW

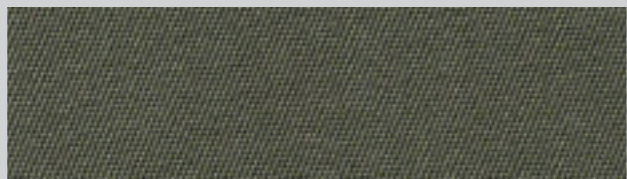

Beige

PD





Upholstery options

Here is a selection of upholstery options for your Audi TT



Fine Nappa leather, Magma red (TR) with Extended leather pack – coloured







Impulse leather, Chennai brown (TZ) with Extended leather pack – coloured

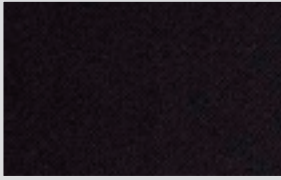
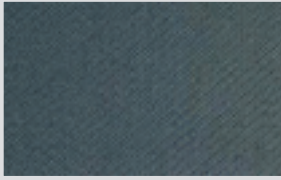

Upholstery

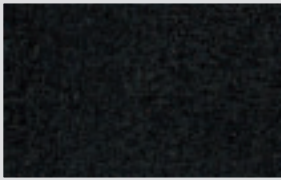
Standard Sports seats

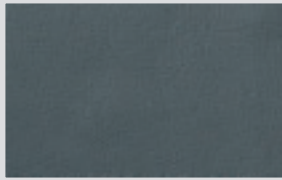
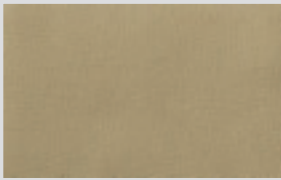
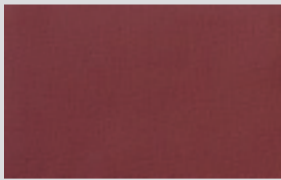
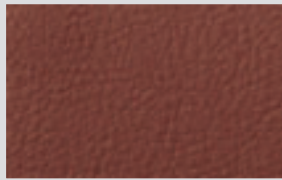

						1.8 TFSI Roadster	2.0 TFSI / 2.0 TDI	3.2 quattro	TTS quattro	Basic RRP	Total RRP <small>inc. VAT</small>
	JN/JW		TP/TF			S	-	-	-	No charge	No charge
Tetrus cloth, Black	JN/JW	Tetrus cloth, Mineral grey	TP/TF								
	JN/JW		TN/TH			•	S	-	-	£852.17	£980.00
Leather/Alcantara, black	JN/JW	Leather/Alcantara, light grey	TN/TH								
	JN/JW		TN/TH		TP/TF	•	-	-	-	£1,317.39	£1,520.00
Fine Nappa leather, black	JN/JW	Fine Nappa leather, light grey	TN/TH	Fine Nappa leather, Mineral grey	TP/TF						
	TQ/TB		TR		JZ	-	•	S	-	£469.57	£540.00
Fine Nappa leather, Luxor beige	TQ/TB	Fine Nappa leather, Magma red	TR	Fine Nappa leather, Mustang brown	JZ						

Options are subject to availability and may extend delivery.
 - = Not available • = Available S = Standard



RRP – Recommended Retail Price.
 All leather upholstery choices include seats, head restraints and door panels in leather.

Upholstery

S line Sport seats

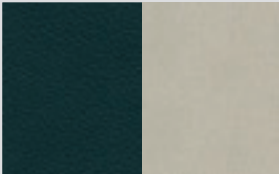

		2.0 TFSI / 2.0 TDI*	3.2 quattro*	TTS quattro	Basic RRP	Total RRP ^{inc. VAT}
	QE	S	•	-	No charge	No charge
Leather/Alcantara, Black						
	QF					
Leather/Alcantara, Black with silver stitching						
	QE	• -	- S	- -	£469.57 No charge	£540.00 No charge
Fine Nappa leather, Black						

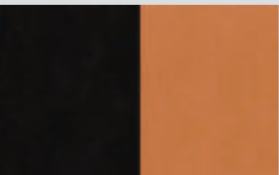
TTS Sports seats

	ZM/FF	-	-	S	No charge	No charge
Silk Nappa leather, black, with Silver stitching						
	ZR/FE					
Silk Nappa leather, black/silver, with Silver stitching						
	FA/FB					
Silk Nappa leather, black/Magma red, with Magma red stitching						
	ZC/ZD					
Silk Nappa leather, black/Signal orange, with Signal orange stitching						

Upholstery

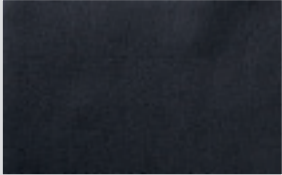
Standard Sport seats

	1.8 TFSI Roadster	2.0 TFSI / 2.0 TDI	3.2 quattro	TTS quattro	Basic RRP	Total RRP ^{inc. VAT}
 <p>Impulse leather – Coupé, seats in Black Fine Nappa leather with moccasin seams in black/grey and silver stitching. Steering wheel, gear-shift gaiter, handbrake grip and centre console armrest pad in black leather with coloured stitching. Must be combined with a multi-function steering wheel (not available on S line)</p> <p>Impulse leather, black ZM</p>	-	•	-	-	£682.61	£785.00
	-	-	•	•	£213.04	£245.00
 <p>Impulse leather – Roadster, seats in Chennai brown Fine Nappa leather with moccasin seams in Chennai brown and Espresso brown stitching. Steering wheel, gear-shift gaiter, handbrake grip and centre console armrest pad in black leather with coloured stitching. Must be combined with a multi-function steering wheel (not available on S line)</p> <p>Impulse leather, Chennai brown TZ</p>	•	-	-	-	£1,530.47	£1,760.00
	-	•	-	-	£682.61	£785.00
	-	-	•	•	£213.04	£245.00



Impulse leather, Chennai brown (TZ) with Extended leather pack – coloured



Impulse leather, Black (ZM)

Options are subject to availability and may extend delivery.
 - = Not available • = Available S = Standard

RRP – Recommended Retail Price.
 All leather upholstery choices include seats, head restraints and door inserts in leather.

Colour and trim guide

To help you choose the right interior for your TT, please use the guide below which shows what carpet, dashboard and headlining colours have been matched to your chosen upholstery.

Coupé

Interior trim colours:

Order code	Upholstery	Carpet	Dashboard	Headlining	Leather/Alcantara (N7U)	Fine Nappa leather (N3Q)	Impulse leather (N1W)
JN	Black	Black	Black	Black	●	●	–
JW	Black	Black	Black	Light grey	●	●	–
TH	Light grey	Light grey	Black	Black	●	●	–
TN	Light grey	Light grey	Black	Light grey	●	●	–
TF	Mineral grey	Mineral grey	Black	Black	–	●	–
TP	Mineral grey	Mineral grey	Black	Mineral grey	–	●	–
TB	Luxor beige	Luxor beige	Black	Black	–	●	–
TQ	Luxor beige	Luxor beige	Black	Luxor beige	–	●	–
TR	Magma red	Black	Black	Black	–	●	–
JZ	Mustang brown	Black	Black	Black	–	●	–
ZM	Black	Black	Black	Black	–	–	●

S line interior trim colours:

Order code	Upholstery	Carpet	Dashboard	Headlining	Alcantara/leather (N7K)	Fine Nappa leather (N2R)
QE	Black with black stitching	Black	Black	Black	●	●
QF	Black with silver stitching	Black	Black	Black	●	–

Colour and trim guide

Coupé

TTS interior trim colours:

Order code	Upholstery	Carpet	Dashboard	Headlining	Silk Nappa leather (N1U)	Impulse leather (N1W)
FF	Black	Black	Black	Light grey	●	—
ZR	Black/Silver	Black	Black	Black	●	—
FE	Black/Silver	Black	Black	Light grey	●	—
FA	Black/Magma red	Black	Black	Black	●	—
FB	Black/Magma red	Black	Black	Light grey	●	—
ZC	Black/Signal orange	Black	Black	Black	●	—
ZD	Black/Signal orange	Black	Black	Light grey	●	—
ZM	Black	Black	Black	Black	●	●



Silk Nappa leather, Black/Magma red with Extended leather pack – coloured

Colour and trim guide

Roadster

Interior trim colours:

Order code	Upholstery	Carpet	Dashboard	Headlining	Tetrus cloth* (N2J)	Leather/Alcantara (N7U)	Fine Nappa leather (N3Q)	Impulse leather (N1W)
JN	Black	Black	Black	Black	●	●	●	—
TH	Light grey	Black	Light grey	Black	—	●	●	—
TF	Mineral grey	Black	Mineral grey	Black	●	—	●	—
TB	Luxor beige	Black	Luxor beige	Black	—	—	●	—
TR	Magma red	Black	Black	Black	—	—	●	—
JZ	Mustang brown	Black	Black	Black	—	—	●	—
TZ	Chennai brown	Black	Black	Black	—	—	—	●

S line interior trim colours:

Order code	Upholstery	Carpet	Dashboard	Headlining	Alcantara/leather (N7K)	Fine Nappa leather (N2R)
QE	Black with black stitching	Black	Black	Black	●	●
QF	Black with silver stitching	Black	Black	Black	●	—



Roadster

TTS interior trim colours:

Order code	Upholstery	Carpet	Dashboard	Headlining	Leather/Alcantara (N7U)	Silk nappa leather (N1U)	Impulse leather (N1W)
ZM	Black	Black	Black	Black	●	●	—
ZR	Black/Silver	Black	Black	Black	●	●	—
FA	Black/Magma red	Black	Black	Black	—	●	—
ZC	Black/Signal orange	Black	Black	Black	—	●	—
TZ	Chennai brown	Black	Black	Black	—	—	●

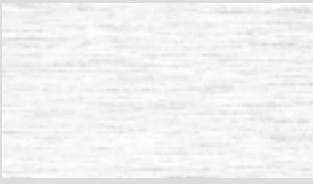

Inlays

Order code			1.8 TFSI Roadster	2.0 TFSI / 2.0 TDI*	3.2 quattro*	TTS quattro	Basic RRP	Total RRP <small>inc. VAT</small>
5MU		Aluminium Laser	S	S	S	-	No charge	No charge
5TG		Matt-brushed aluminium	-	-	-	S	No charge	No charge



- = Not available • = Available S = Standard

RRP – Recommended Retail Price.



Wheels, tyres and suspension

Order code		1.8 TFSI Roadster	2.0 TFSI / 2.0 TDI*	3.2 quattro*	TTS quattro	Basic RRP	Total RRP <small>inc. VAT</small>
PRE CK1	17 x 8.5J '7 Y-spoke' design alloy wheels with 245/40 R17 Y tyres	S	-	-	-	No charge	No charge
PRD	18 x 9J '5-spoke star' design alloy wheels, with 245/40 R18 tyres	•	-	-	-	£1,234.78	£1,420.00
		-	•	-	-	£1,065.22	£1,225.00
		-	-	•	-	£300.00	£345.00
PRT	18 x 9J '10-spoke' design alloy wheels with 245/40 R18 Y tyres*	•	-	-	-	£934.78	£1,075.00
		-	•	S	-	£765.22	£880.00
PQ5	18 x 9J '10-spoke' design alloy wheels with 245/40 R18 Y tyres	•	-	-	-	£1,234.78	£1,420.00
		-	•	-	-	£1,065.22	£1,225.00
		-	•	-	-	£300.00	£345.00
		-	-	•	•	£300.00	£345.00
PRC	18 x 9J '10-spoke' design alloy wheels in bi-colour finish with 245/40 R18 Y tyres*	•	-	-	-	£1,104.35	£1,270.00
		-	•	-	-	£934.78	£1,075.00
		-	-	•	-	£169.57	£195.00
PRW	18 x 9J 'Turbine' design alloy wheels with 245/40 R18 Y tyres*	•	-	-	-	£1,234.78	£1,420.00
		-	•	-	-	£1,065.22	£1,225.00
		-	-	•	-	£300.00	£345.00



18 x 9J '10-spoke' design alloy wheels in bi-colour finish (PRC)



18 x 9J 'Turbine' design alloy wheels (PRW)



18 x 9J '10-spoke' design alloy wheels (PQ5)

Wheels, tyres and suspension

Order code		1.8 TFSI Roadster	2.0 TFSI / 2.0 TDI	3.2 quattro	TTS quattro	Basic RRP	Total RRP <small>inc. VAT</small>
PQS	19 x 9J '20-spoke' design two-piece alloy wheels with 255/35 R19 Y tyres	●	-	-	-	£1,573.91	£1,810.00
		-	●	-	-	£1,404.35	£1,615.00
		S line	-	●	●	£639.13	£735.00
PQF	19 x 9J '7-arm double-spoke' design alloy wheels with 255/35 R19 Y tyres	●	-	-	-	£1,573.91	£1,810.00
		-	●	-	-	£1,404.35	£1,615.00
		S line	-	●	●	£639.13	£735.00
PQ6	19 x 9J '5-segment-spoke' design alloy wheels with 255/35 R19 Y tyres	●	-	-	-	£1,573.91	£1,810.00
		-	●	-	-	£1,404.35	£1,615.00
		S line	-	●	●	£639.13	£735.00
PQG	19 x 9J '5-spoke Star' design alloy wheels with 255/35 R19 Y tyres	●	-	-	-	£1,573.91	£1,810.00
		-	●	-	-	£1,404.35	£1,615.00
		S line	-	●	●	£639.13	£735.00
1BL PC2	Audi Magnetic Ride. Adaptive suspension system with two selectable modes (Normal or Sport). Sensors in the car monitor the road conditions and adjust the damping effect by varying a magnetic charge which passes through a fluid-based shock absorber for improved road handling, outstanding chassis control and excellent driving comfort. Includes painted brake callipers in grey (cannot be combined with Sports suspension)	●	●	●	S**	£978.26	£1,125.00
		S line	●	●	●	-	£360.87
1BV	Sports suspension. 10mm lower ride height with stiffer damper and spring rates (cannot be combined with Audi Magnetic Ride)	-	S	S	-	No charge	No charge



19 x 9J '7-arm double-spoke' design alloy wheels (PQF)



19 x 9J '5-spoke Star' design alloy wheels (PQG)



19 x 9J '5-segment-spoke' design alloy wheels (PQ6)

**Audi Magnetic Ride on TTS has a 10mm lower ride height than standard Audi Magnetic Ride.

Audio and communication

Order code		1.8 TFSI Roadster	2.0 TFSI / 2.0 TDI*	3.2 quattro*	TTS quattro	Basic RRP	Total RRP <small>inc. VAT</small>
RAL 8UL	Audi Chorus radio , with front-loading CD player	S	-	-	-	No charge	No charge
RCL 8UD	Audi Concert radio , with single front loading CD player, MP3 file compatability and active front and rear speakers. Includes AUX IN socket in front centre compartment	•	S	S	S	£186.96	£215.00
UF7	Audi Music Interface , for connecting generation 4 and higher Apple iPods (iPod mini, iPod nano, iPod photo, iPod video,) and USB storage media and MP3 players (USB 2.0 only); operated via Navigation Plus system or multi-function steering wheel. AMI situated in glove compartment. Can only be ordered in conjunction with Satellite Navigation system Plus	•	•	•	•	£213.04	£245.00
RSL	Audi Symphony radio , with front-loading MP3-compatible 6-CD changer including aux-in socket	• -	- •	- •	- •	£413.04 £226.09	£475.00 £260.00
8RY	BOSE Surround Sound system . High-performance loudspeakers with total output of 255 Watts and 8-channel amplifier with Audio Pilot noise compensation	•	•	•	•	£404.35	£465.00
7A2	CD changer for six discs, located in glovebox (cannot be combined with iPod connection or USB connection)	•	•	•	•	£273.91	£315.00
UF1	iPod connection , for playing and charging your iPod in your TT, located in glovebox and controlled via radio or multi-function steering wheel (if fitted). (Cannot be combined with CD changer or USB connection)	•	•	•	•	£152.17	£175.00
9ZX	Mobile telephone preparation – Bluetooth interface . Provides handsfree connection via Bluetooth using mobile phone aerial. Please contact your Audi Centre for phone compatability (only in combination with multi-function steering wheel)	•	•	•	•	£208.70	£240.00



Symphony radio



iPod connection

Audio and communication

Order code		1.8 TFSI Roadster	2.0 TFSI / 2.0 TDI	3.2 quattro	TTS quattro	Basic RRP	Total RRP ^{inc. VAT}
9ZF	Mobile telephone preparation – Low , located on centre console between front seats. Uses Bluetooth interface or cradle to connect to your TT. Includes voice control for phone functions (Coupé only), external aerial for optimal reception and charging facility via cradle (required at extra cost, please see your Audi Centre for phone compatibility. Only in combination with multi-function steering wheel)	•	•	•	•	£326.09	£375.00
PNX	Satellite Navigation system. CD-ROM based route-planning and guidance with MMI operating logic, using voice and pictogram instructions. Includes RDS radio and CD player for navigation system, audio CDs or MP3 file CDs. Includes UK CD-ROM disc. Located in dashboard in lieu of Concert radio. Please note that the navigation system cannot be used at the same time as the CD player, therefore a CD Changer, iPod connection or USB connection is recommended with this option. Please note this option does not include TMC functionality	•	-	-	-	£739.13	£850.00
		-	•	•	•	£552.17	£635.00
PNC	Satellite Navigation system Plus. DVD-based route-planning and guidance with MMI control logic, using 6.5" colour monitor and 'birds-eye' mapping. Includes RDS radio, two integrated memory-card readers (compatible with 2 x 1GB MMC/SD memory cards) and DVD player for navigation system, audio CDs or MP3 file CDs. Includes European coverage disc and dynamic route guidance via TMC. Located in dashboard in lieu of Concert radio. Please note that the navigation system cannot be used at the same time as the CD player therefore a CD changer, iPod connection or USB connection is recommended with this option	•	-	-	-	£1,591.30	£1,830.00
		-	•	•	•	£1,404.35	£1,615.00
QV9	TV tuner. Analog and digital for reception of 'free-to-air' TV channels. Picture reception only possible when vehicle is stationary, sound reception at all times. Quality of reception is dependent on local digital network availability (only in combination with Satellite Navigation system Plus)	•	•	•	•	£682.61	£785.00
UF2	USB connection , for playing your USB stick in your TT, located in glovebox and controlled via radio or multi-function steering wheel (if fitted). (Cannot be combined with CD changer or iPod connection)	•	•	•	•	£152.17	£175.00



Satellite Navigation system Plus



Mobile telephone preparation – Low

Seats

Order code		1.8 TFSI Roadster	2.0 TFSI / 2.0 TDI*	3.2 quattro*	TTS quattro	Basic RRP	Total RRP <small>inc. VAT</small>
7P1	Electric lumbar support	•	•	•	•	£160.87	£185.00
PV1	Electrically-adjustable front seats with adjustment for height, forwards and backwards position, backrest angle and lumbar support	•	•	•	•	£617.39	£710.00
PS5	Front bucket seats in black Fine Nappa leather with manual adjustment. (Please note this option deletes front ISOFIX and front airbag de-activation. Not available in combination with storage pack, electric front seats or any other seat upholstery option)	•	-	-	-	£2,765.22	£3,180.00
		-	•	-	-	£1,913.04	£2,200.00
		-	-	•	•	£1,447.83	£1,665.00
4A3	Heated front seats. Individually-controlled heating for seat base and bolster with variable temperature adjustment	•	•	S	S	£213.04	£245.00



Electric front seats



Heated front seats



Safety and security

Order code		1.8 TFSI Roadster	2.0 TFSI / 2.0 TDI*	3.2 quattro*	TTS quattro	Basic RRP	Total RRP <small>inc. VAT</small>
7X1	Acoustic parking system (rear only)	•	•	•	•	£256.52	£295.00
UGI	Audi hill hold assist	•	•	•	•	£78.26	£90.00
6XK 4L6 4GP	Auto-dimming, folding, electrically-operated and heated door mirrors , including auto-dimming rear-view mirror, light and rain sensors, and windscreen sunband	•	•	•	•	£382.61	£440.00
8N7	High beam assist. Automatically adjusts headlights from high-beam to dipped beam when another vehicle is approaching or when entering a highly-lit area such as towns (can only be ordered in conjunction with light and rain sensor)	•	•	•	•	£86.96	£100.00
3B4	ISOFIX child-seat preparation for outer rear seats (Coupé only)	-	•	•	•	£30.43	£35.00
7K6	Tyre-pressure monitoring with display in the DIS	•	•	•	•	£65.22	£75.00

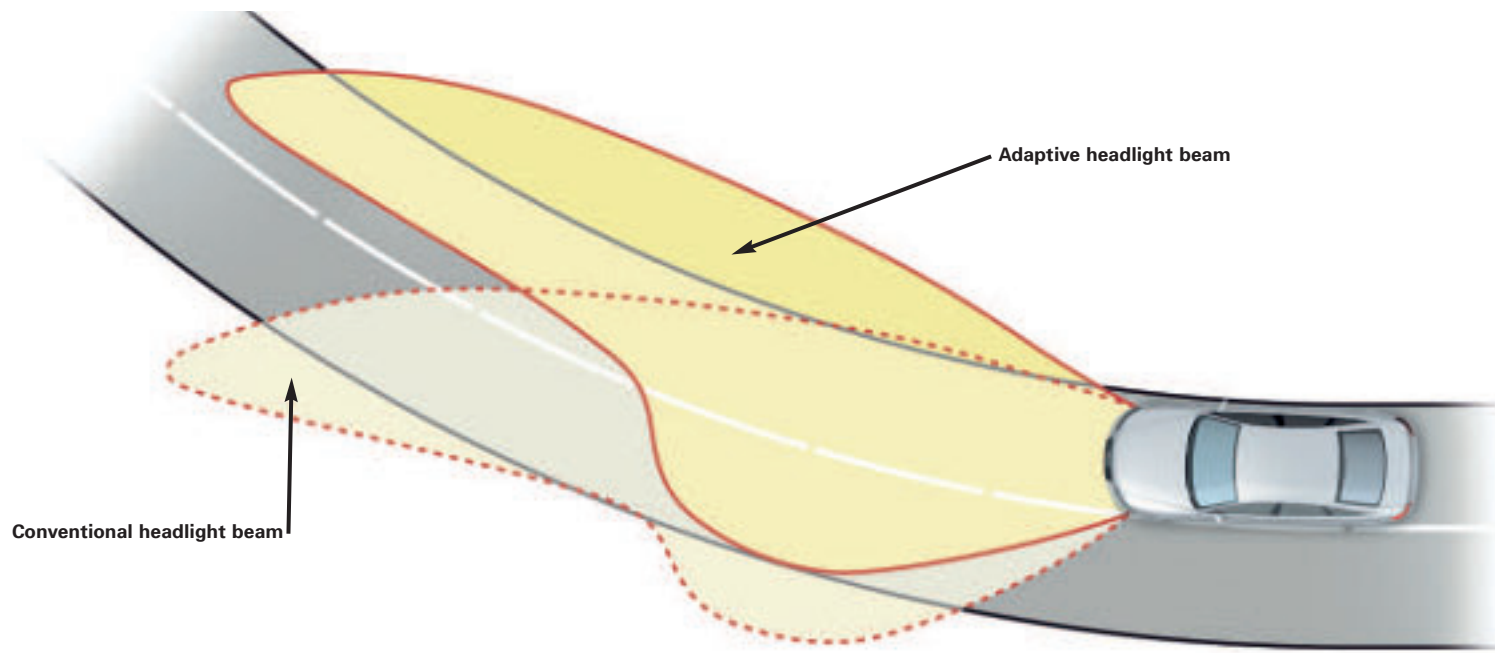

Adaptive lights

Exterior equipment

Order code		1.8 TFSI Roadster	2.0 TFSI / 2.0 TDI	3.2 quattro	TTS quattro	Basic RRP	Total RRP ^{inc. VAT}
PX4	Xenon Plus headlights with Adaptive light. Xenon Plus headlights for dipped and main beam with swivelling headlights for improved illumination of a winding road. Includes headlight-washer system, automatic-dynamic headlight levelling and exterior light styling pack including chrome-detailed headlight surrounds and darkened rear-light clusters	•	•	•	-	£830.43	£955.00
8Q5		-	-	-	•	£278.26	£320.00
4GP	Windscreen sunband	•	•	•	•	£47.83	£55.00
VW1	Privacy glass dark tinted rear and rear side (from B pillar backwards)	-	•	•	•	£278.26	£320.00



Exterior light styling pack – part of Xenon plus headlights



Interior equipment

Order code		1.8 TFSI Roadster	2.0 TFSI / 2.0 TDI*	3.2 quattro*	TTS quattro	Basic RRP	Total RRP <small>inc. VAT</small>
8T2	Cruise control , for holding any speed above 25mph	•	•	•	•	£182.61	£210.00
7HC	Extended leather package – black . Instrument-panel cover, door armrest and side of centre console in black leather	•	•	•	S	£300.00	£345.00
7HD	Extended leather package – Coloured , side of centre console in coloured leather to match seat upholstery, instrument panel cover in black leather. In combination with Magma red or Mustang brown – door armrest and door handle in black leather. In combination with Chennai brown, TTS Silk Nappa leather interior colours or exclusive line – door armrest and door handle in black leather with colour stitching to match seat centres. In combination with Mineral grey, Light grey and Luxor beige interior colours – door armrest and door handle in coloured leather to match seat upholstery 5(not available in combination with black leather interior)	•	•	•	–	£382.61	£440.00
		–	–	–	•	£86.96	£100.00
VC1	Garage door opener (HomeLink®)** . Programmable radio-operated remote control for up to three compatible doors/gates. Control buttons integrated in the roof module at the front	•	•	•	•	£147.83	£170.00
QQ1	Interior light package , including illuminated door handles, vanity mirrors and glove box, foot-well lighting, puddle lighting and ambient lighting	•	•	•	•	£100.00	£115.00
1XW	Multi-function flat-bottom design steering wheel . For control of audio equipment and telephone (if fitted). Includes paddle-shift gear change on S tronic models	•	•	•	S	£152.17	£175.00
1XX		–	S	S	–	No charge	No charge
QE1	Storage pack , comprising underseat storage box, luggage net in boot and luggage net in passenger footwell (Coupé only)	–	–	–	–	£121.74	£140.00
		–	•	•	•	£100.00	£115.00
3X2	Through-load facility (ski bag) for transporting long objects (Roadster only)	•	•	•	•	£82.61	£95.00



Through-load



Extended leather pack – coloured



Cruise control



Audi Centre-fitted accessories

Audi Centre-fitted accessories offer a range of products that enable you to tailor your Audi TT to your tastes and requirements. All prices exclude fitting and painting, where this is required. Please contact your Audi Centre for further details of accessories available for the Audi TT.

Sport and design

	Part number	Basic RRP	Total RRP ^{inc. VAT}
19 x 9J '5-arm' design alloy wheels, wheels only	8J0071499W90 x 4	£1,019.13	£1,172.00
19 x 9J '5-arm' design alloy wheels, with Continental Sport Contact 3 255/35 R19 96Y high-performance tyres	8J0073011BW90 x 4	£1,700.87	£1,956.00
Body styling package , adds subtly-aggressive and sporty design to the exterior of the TT through the following components:			
Front skirt	8J00716099AX	£169.57	£195.00
Side skirts	8J00716859AX	£213.04	£245.00
Rear diffuser, for 2.0 TFSI and 2.0 TDI models	8J00716119AX	£126.96	£146.00
Rear diffuser, for 3.2 quattro® models	8J0071611B9AX	£126.96	£146.00
Rear spoiler	8J00716459AX	£169.57	£195.00
Stainless steel tailpipe trims. For 4-cylinder models. Enhances the exterior appearance and styling of the twin rear tailpipes (cannot be fitted to S line models)	8J0071761	£46.96	£54.00

Safety

Road Angel Professional Connected , gives you access to the UK's number-one safety camera and accident blackspot database as you drive. It is the world's first connected safety camera and blackspot alert device which uses a built-in SIM card and GPRS/GSM technology to enable UK-wide safety camera location updates every few minutes. The Road Angel Professional Connected is operated via remote control and has a full colour screen that can be customised to your taste. Includes a built-in rechargeable battery with up to 8-hours battery life*	ZGB00005216A	£256.51	£294.99
--	--------------	---------	---------



19 x 9J '5-arm' design alloy wheels



Front skirt



Stainless steel tailpipe trims

Audi Centre-fitted accessories

Comfort and protection

	Part number	Basic RRP	Total RRP ^{inc. VAT}
Front mud flaps , protects the underbody, bumpers and rear of the TT from severe dirt and stone impacts. Also reduces spray water	8J0075111	£29.57	£34.00
Rear mud flaps , as above	8J0075101	£29.57	£34.00
Premium front carpet mats with TT logo , in black velour with silver TT logo	8J2061275MNO	£42.61	£49.00
Front rubber floor mats , durable and easy to clean front rubber floor mats protect the vehicle footwells from dirt and moisture	8J2061501041	£33.91	£39.00
Luggage compartment liner – Flexible . High edged, water tight, foam liner which is a perfect fit for keeping the TT luggage compartment clean	8J0061160	£29.57	£34.00
Luggage compartment liner – Semi rigid . As above but made from stiffer, stronger and wipeable plastic	8J0061180	£50.43	£58.00

Security

CobraTrak Q tracking device . Thatcham Category TOA rated tracking device that uses GPS and GSM technology to accurately pinpoint the location of a vehicle in up to 36 European countries in the event of the vehicles theft. Price shown includes one year's subscription to the CobraTrak service	ZGB000054996A	£365.22	£420.00
---	---------------	---------	---------



Premium front carpet mats with TT logo



Front rubber floor mats



Luggage compartment liner – Semi rigid



Every Audi is intrinsically exclusive. It's the breathtaking design, the exceptional engineering, the Vorsprung durch Technik. But for that added element of exclusivity – that distinguishing look that sets you apart from the rest – you can specify your TT with options from Audi exclusive. Whether you want unique, complementary shades or even individualised carpets and floor mats, Audi exclusive will enable you to drive the car you've always imagined.

For more information on any of the options over the following pages or to view swatches, simply ask a member of staff at your local Audi Centre.

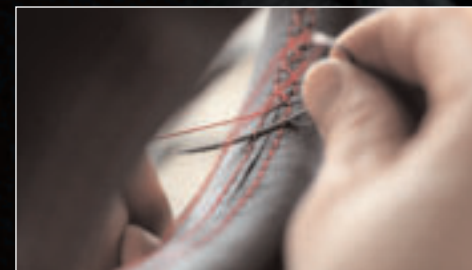
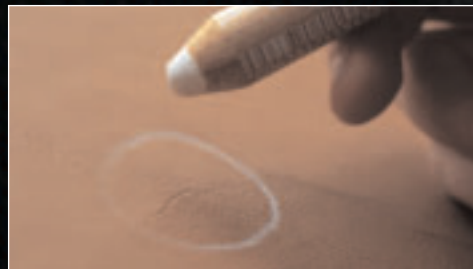

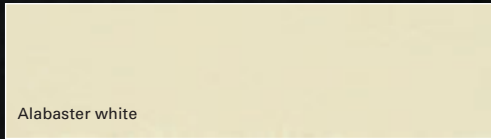

Alabaster white

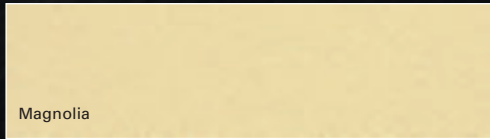

Magnolia



Sand beige



Havanna brown



Cocos



Cognac



Saddle brown

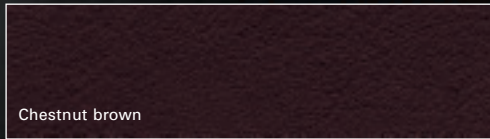

Chestnut brown

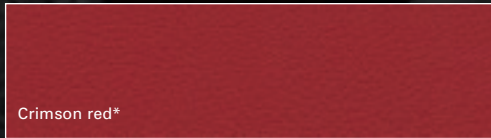

Crimson red*

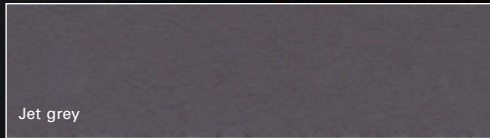

Jet grey



Palace blue

Upholstery

With Audi exclusive, you can specify your seats in an array of different colours shown to the left in Fine Nappa leather.

Choose just one all-over shade for each seat, or for a sportier look, customise each panel in two or more complementary colours from the distinctive Audi exclusive palette shown here. You can even choose the colour of the decorative stitching – to match or contrast with your chosen upholstery – from this varied collection. Whatever combination you decide upon, you're guaranteed to be extremely comfortable with the result.

	1.8 TFSI Roadster	2.0 TFSI / 2.0 TDI	3.2 quattro	TTS quattro	Basic RRP	Total RRP ^{inc.} VAT
Fine Nappa leather – seat upholstery and door panel inserts in leather, floor mats with leather piping	–	●	–	–	£1,617.39	£1,860.00
	●	–	–	–	£1,530.43	£1,760.00
	–	–	●	–	£1,147.83	£1,320.00
– with front bucket seats (Not available on S line)	–	●	–	–	£3,530.43	£4,060.00
	●	–	–	–	£3,360.87	£3,865.00
	–	–	●	–	£2,595.65	£2,985.00
Fine Nappa leather Extended – As above, extended with handbrake handle, centre armrest pad, door armrests and handles, side of centre console and dashboard hood in leather	–	●	–	–	£2,000.00	£2,300.00
	●	–	–	–	£1,913.04	£2,200.00
	–	–	●	–	£1,530.43	£1,760.00
	–	–	–	●	£1,147.83	£1,320.00
	–	●	–	–	£3,913.04	£4,500.00
– with front bucket seats (Not available on S line)	–	–	●	–	£2,978.26	£3,425.00
	–	–	–	●	£2,595.65	£2,985.00
	●	–	–	–	£1,404.35	£1,615.00

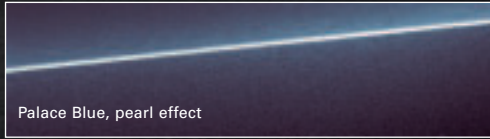

Palace Blue, pearl effect



Morning Dew, metallic



Sand Beige, pearl effect

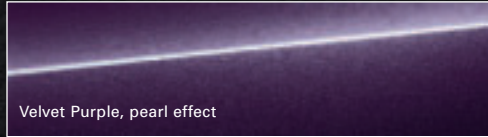

Velvet Purple, pearl effect

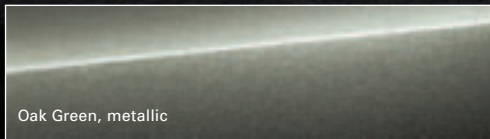

Oak Green, metallic

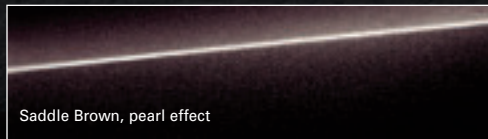

Saddle Brown, pearl effect

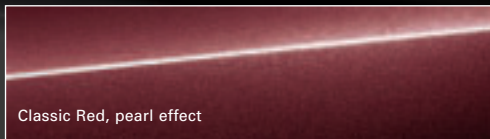

Classic Red, pearl effect

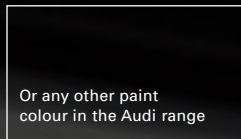

Or any other paint colour in the Audi range

Basic RRP	Total RRP ^{inc.} _{VAT}
£1,447.83	£1,665.00

Paint

Everyone has a favourite colour. No matter what yours is, Audi exclusive provides a range of unique colours that have been designed to set your car apart. Choose from the swatches here, or specify any other paint colour in the Audi range – whether it's Jet blue from the Audi R8 or Alpine white from the original Audi quattro®. The choice is yours.

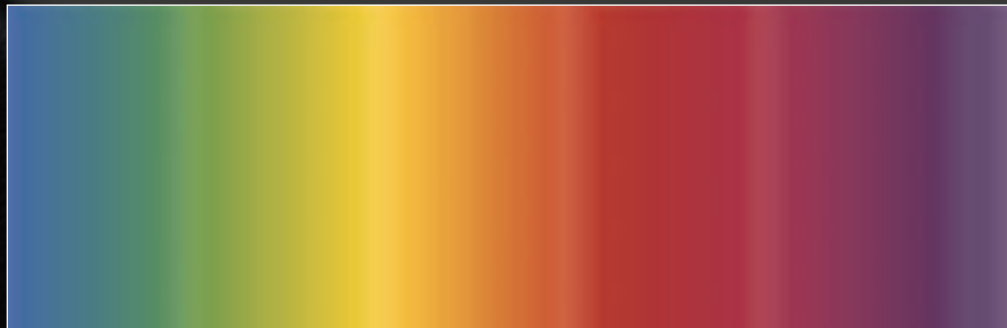

Customised paint

In a car made from Vorsprung durch Technik, there are no compromises. So if you have a particular colour in mind, we'll mix the exact water-based metallic or pearl-effect shade you want – whether it's the blue of your favourite shirt or the wall colour in your sitting room.

Basic RRP	Total RRP ^{inc.} _{VAT}
£2,043.48	£2,350.00

Controls pack and inlays

Our fingertips and palms contain more touch receptors than any other part of our body – so shouldn't the parts of our car we handle the most also be the most pleasing to touch? With this in mind, controls pack enables you to customise the steering wheel, handbrake grip, gear knob and gaiter in smooth, warm leather, in any of the colours shown on page 45. As with Audi exclusive seats, you even have free choice on the colour of the decorative stitching used.



	Basic RRP	Total RRP <small>inc. VAT</small>
Controls pack	£508.70	£585.00
Steering wheel only	£291.30	£335.00
Roll hoops in Audi exclusive leather	£426.09	£490.00
Audi exclusive headlining in Alcantara (only available on Coupé models)	£1,347.83	£1,550.00

Audi exclusive line

Audi exclusive is ultimately about choice – but if you’d rather leave some of the decisions in the capable hands of our designers, the expert team at quattro® GmbH have compiled Audi exclusive line, combining some of the most popular elements of the exclusive range in one sporty, beautifully coordinated package. The package gives you:

- ▶ Two-tone Fine Nappa leather upholstery. Seat centres in Silver (QL), Crimson red (QY), Saddle brown (XA) or Signal orange (XB). Seat side sections and head restraints in black with stitching to match the seat centres
- ▶ Front door panels in Fina Nappa leather to match seat centres. Rear door panels in black (Coupé only)
- ▶ 3-spoke Sports ‘flat-bottom’ design leather multi-function steering wheel with steering wheel, handbrake grip and gear-lever gaiter stitching to match seat centres
- ▶ Front floor mats with coloured stitching to match seat centres
- ▶ Extended leather package (instrument panel cover, door armrest and sides of centre console) in black leather with stitching to match seat centres
- ▶ Black headlining
- ▶ Audi exclusive scuff plates



	1.8 TFSI Roadster	2.0 TFSI / 2.0 TDI	3.2 quattro	TTS quattro	Basic RRP	Total RRP <small>inc. VAT</small>
Audi exclusive line	•	•	•		£1,491.30	£1,715.00
					£1,404.35	£1,615.00
			•		£1,021.74	£1,175.00

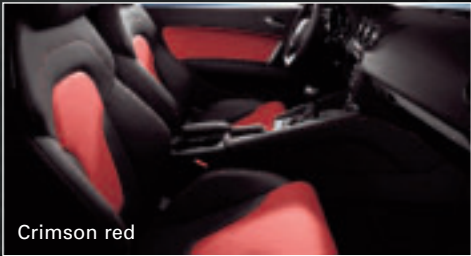

Crimson red

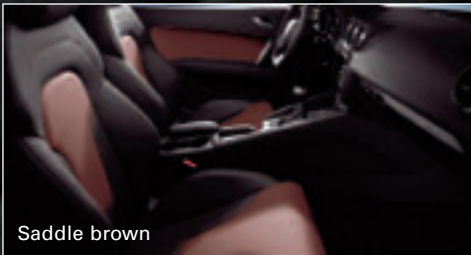

Saddle brown

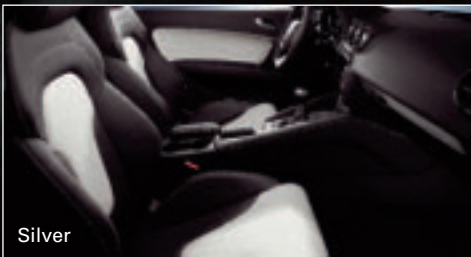

Silver

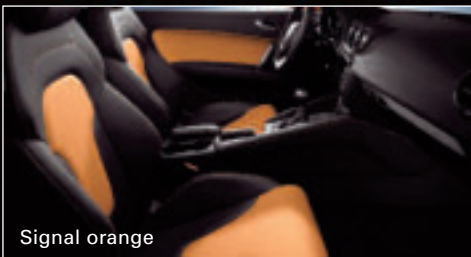

Signal orange



Technical data

Coupé – Petrol

Engine	Cylinder	Displacement, cubic cm (valves per cylinder)	Max. power ¹ , PS at rpm	Max. torque, Nm at rpm	Transmission	CO ₂ emissions ² , g/km	CO ₂ company car tax ³ , percent	0-62mph acceleration, seconds
2.0 TFSI	4-cylinder	1984 (4)	200/5100-6000	280/1800-5000	6-speed manual	183	24	6.6
2.0 TFSI	4-cylinder	1984 (4)	200/5100-6000	280/1800-5000	6-speed S tronic®	183	24	6.4
2.0 TFSI quattro®	4-cylinder	1984 (4)	200/5100-6000	280/1800-5000	6-speed S tronic®	181	24	6.2
3.2 quattro®	V6	3189 (4)	250/6300	320/2500-3000	6-speed manual	247	35	5.9
3.2 quattro®	V6	3189 (4)	250/6300	320/2500-5000	6-speed S tronic®	224	32	5.7
TTS quattro®	4-cylinder	1984 (4)	272/6000	350/2500-5000	6-speed manual	191	26	5.4
TTS quattro®	4-cylinder	1984 (4)	272/6000	350/2500-5000	6-speed S tronic®	188	25	5.2

Coupé – Diesel

2.0 TDI quattro®	4-cylinder	1968 (4)	170/4200	350/1750-2500	6-speed manual	139	18	7.5
------------------	------------	----------	----------	---------------	----------------	-----	----	-----

Roadster – Petrol

1.8 TFSI	4-cylinder	1798 (4)	160/4500-6200	250/1500-4500	6-speed manual	159	19	7.4
2.0 TFSI	4-cylinder	1984 (4)	200/5100-6000	280/1800-5000	6-speed manual	186	25	6.7
2.0 TFSI	4-cylinder	1984 (4)	200/5100-6000	280/1800-5000	6-speed S tronic®	186	25	6.5
2.0 TFSI quattro®	4-cylinder	1984 (4)	200/5100-6000	280/1800-5000	6-speed S tronic®	184	24	6.4
3.2 quattro®	V6	3189 (4)	250/6300	320/2500-3000	6-speed manual	250	35	6.1
3.2 quattro®	V6	3189 (4)	250/6300	320/2500-3000	6-speed S tronic®	227	33	5.9
TTS quattro®	4-cylinder	1984 (4)	272/6000	350/2500-5000	6-speed manual	194	26	5.6
TTS quattro®	4-cylinder	1984 (4)	272/6000	350/2500-5000	6-speed S tronic®	190	26	5.4

Roadster – Diesel

2.0 TDI quattro®	4-cylinder	1968 (4)	170/4200	350/1750-2500	6-speed manual	144	19	7.7
------------------	------------	----------	----------	---------------	----------------	-----	----	-----

¹The given values have been determined according to the prescribed measurement process (the latest version of Directive 80/1269/EEC).

²The given values were calculated in accordance with the specified measurement procedure (the respective current version of Directive 80/1268/EEC). This information does not relate to a single vehicle and does not comprise part of the offer but is merely intended for the purpose of comparison between the different vehicle types. The data does not relate to any single vehicle and does not comprise part of the offer but is merely intended for the purpose of comparison between the different vehicle types.

³The percentage is based on the 2008/9 tax year.

Top speed, mph	ABI insurance group	Unladen weight ⁵	Weights, kg		Roof/Boot lid load limit	Volumes		Fuel consumption, mpg (l/100km)		
			Gross weight limit			Luggage compartment capacity, litres	Fuel tank capacity approx, litres	Urban	Extra Urban	Combined
149	17E	1260	1660	75	290/700	55	26.4 (10.7)	47.1 (6.0)	36.7 (7.7)	
149	17E	1280	1680	75	290/700	55	26.6 (10.6)	47.1 (6.0)	36.7 (7.7)	
148	TBC	1360	1760	75	290/700	60	26.9 (10.5)	46.3 (6.1)	36.7 (7.7)	
155 ⁴	18E	1410	1810	75	290/700	60	19.2 (14.7)	36.2 (7.8)	27.4 (10.3)	
155 ⁴	18E	1430	1830	75	290/700	60	21.9 (12.9)	38.7 (7.3)	30.1 (9.4)	
155 ⁴	19E	1395	1795	75	290/700	60	25.9 (10.9)	44.8 (6.3)	35.3 (8.0)	
155 ⁴	19E	1415	1815	75	290/700	60	25.7 (11.0)	46.3 (6.1)	35.8 (7.9)	
140	16E	1370	1770	75	290/700	60	40.4 (7.0)	65.7 (4.3)	53.3 (5.3)	
139	TBC	1285	1605	20	250	55	25.8 (9.1)	42.0 (5.6)	34.0 (6.9)	
147	17E	1295	1615	20	250	55	26.4 (10.7)	45.6 (6.2)	36.2 (7.8)	
147	17E	1315	1635	20	250	55	26.2 (10.8)	46.3 (6.1)	36.2 (7.8)	
146	TBC	1405	1725	20	250	60	26.9 (10.5)	44.8 (6.3)	36.2 (7.8)	
155 ⁴	18E	1470	1790	20	250	60	19.1 (14.8)	36.2 (7.8)	27.2 (10.4)	
155 ⁴	18E	1490	1810	20	250	60	21.7 (13.0)	38.2 (7.4)	29.7 (9.5)	
155 ⁴	19E	1455	1775	20	250	60	25.7 (11.0)	43.5 (6.5)	34.4 (8.2)	
155 ⁴	19E	1475	1795	20	250	60	25.0 (11.3)	45.6 (6.2)	35.3 (8.0)	
139	16E	1415	1735	20	250	60	39.2 (7.2)	62.8 (4.5)	51.4 (5.5)	

⁴Regulated.

⁵Vehicle unladen weight without driver (calculated in accordance with the current applicable version of Directive 92/21/EEC).

Optional equipment may increase the car's unladen weight and drag coefficient, whereby the possible payload limit and top speed will be correspondingly reduced.

Dimensions

TT Coupé

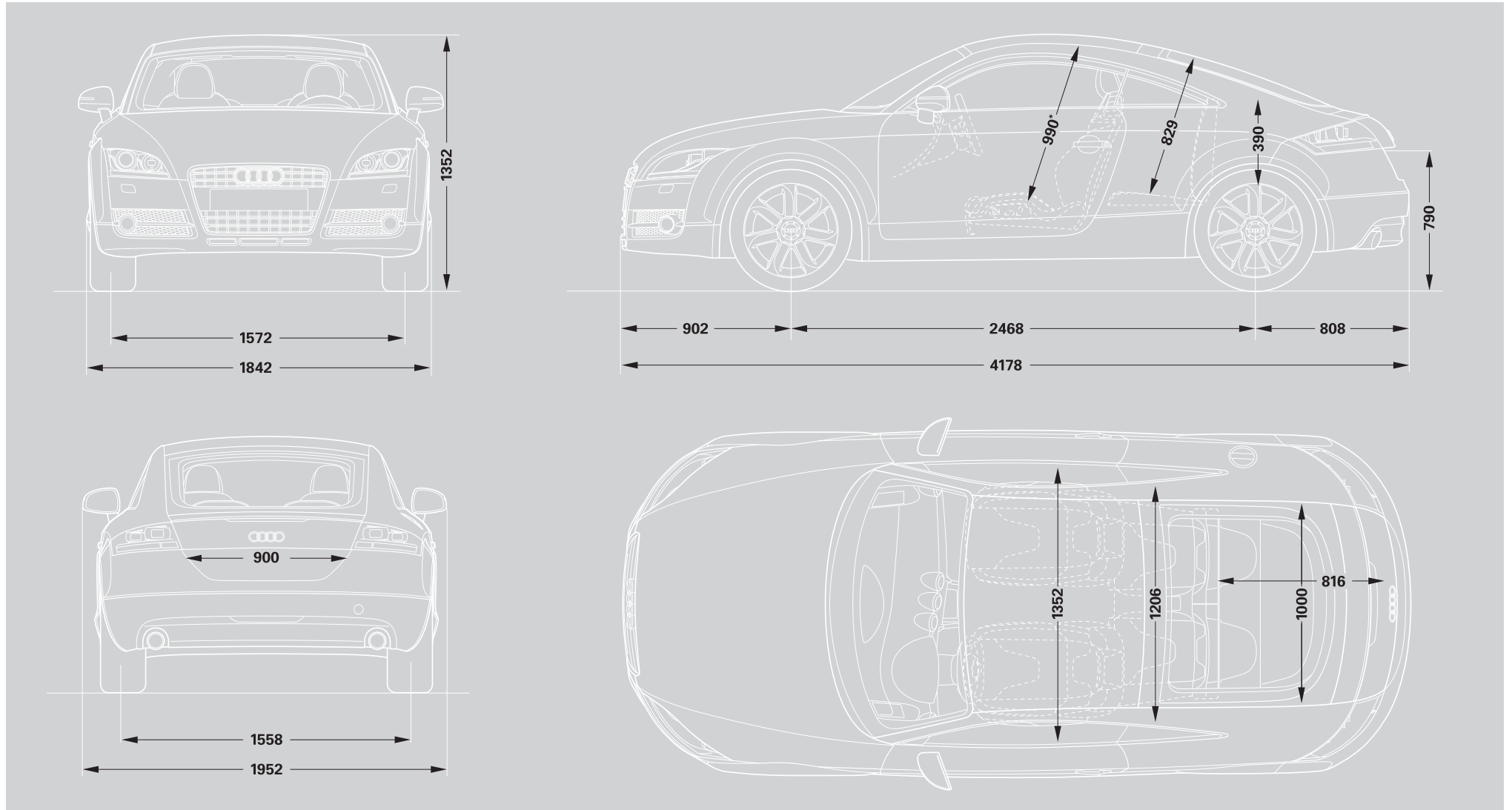

TT Roadster

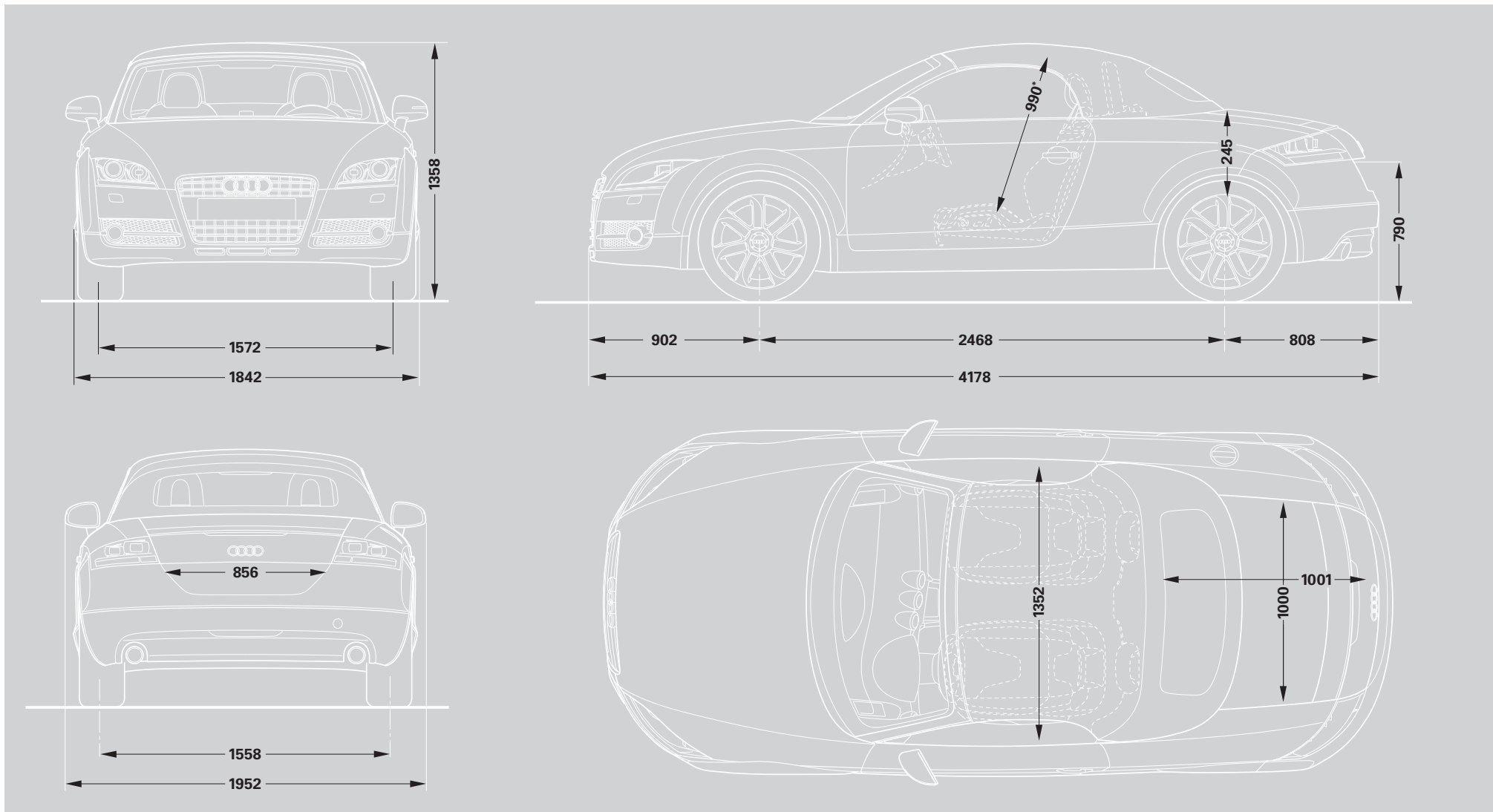

Dimensions were measured at unladen weight. Luggage compartment volume 250l (measured in accordance with the VDA method using 200 x 100 x 50mm blocks)
Turning circle approx. 10.9m. *Maximum headroom.

Dimensions in millimetres.

Dimensions

TTS Coupé

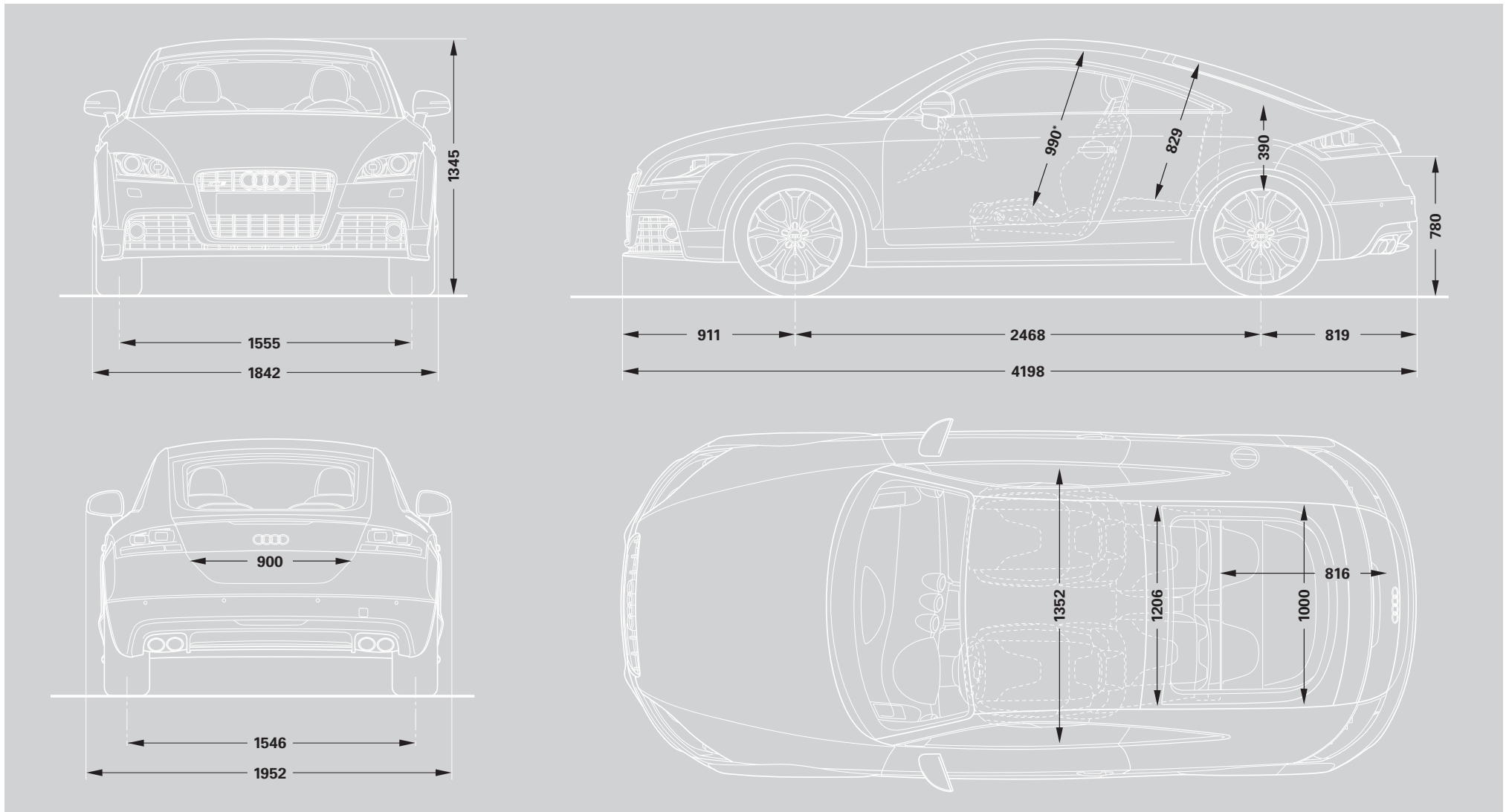

Dimensions were measured at unladen weight. Luggage compartment volume 250/700l (measured in accordance with the VDA method using 200 x 100 x 50mm blocks; second figure: with rear seat folded down and the vehicle loaded up to roof height). Turning circle approx. 10.9m. *Maximum headroom.

Dimensions in millimetres.

TTS Roadster

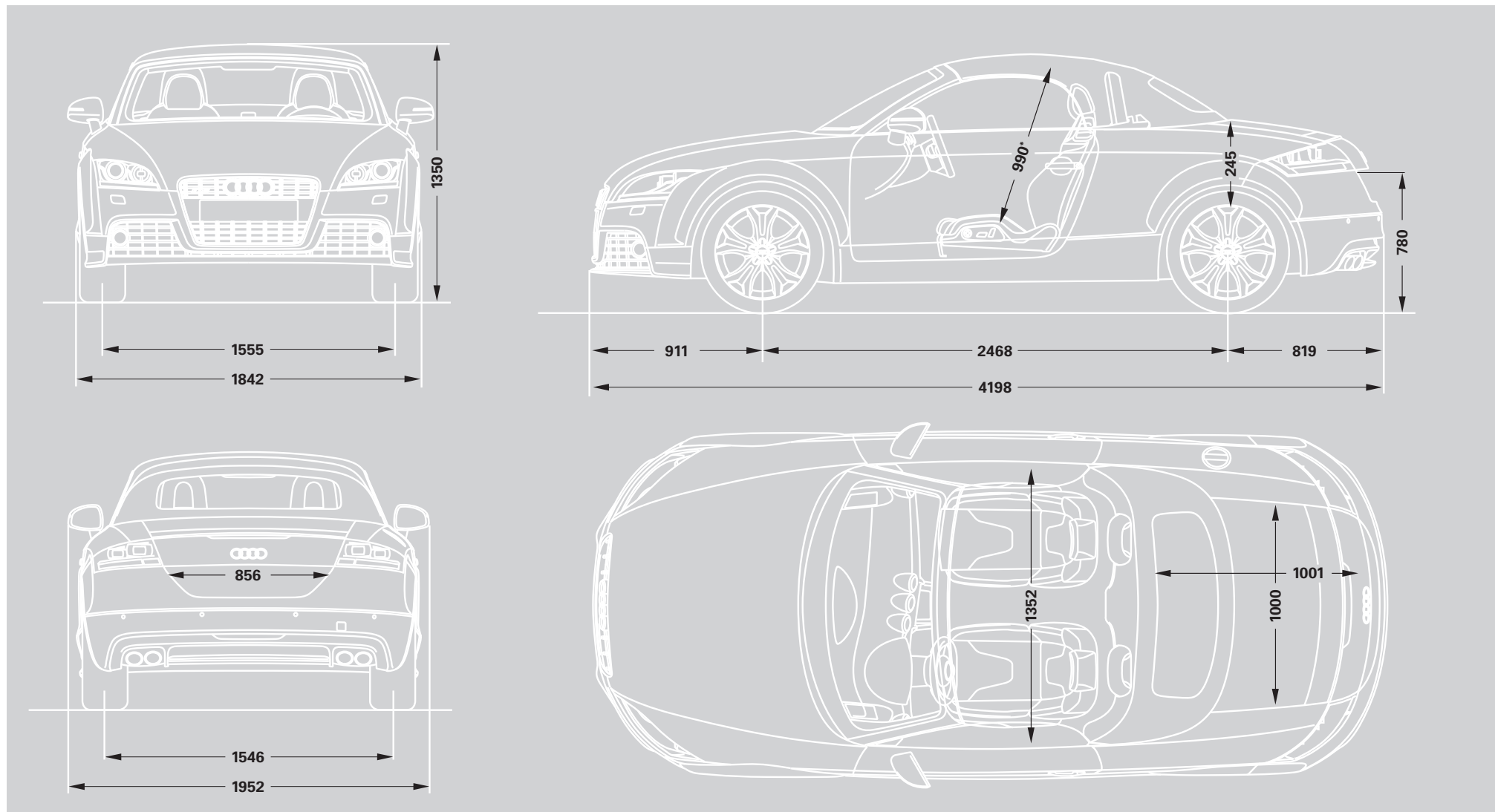

Dimensions were measured at unladen weight. Luggage compartment volume 250l (measured in accordance with the VDA method using 200 x 100 x 50mm blocks)
Turning circle approx. 10.9m. *Maximum headroom.

Dimensions in millimetres.

Additional information

CO₂ data and information

CO₂ emissions-based Vehicle Excise Duty

Vehicle Excise Duty (Road Fund Licence) is based upon the amount of Carbon Dioxide (CO₂) a vehicle emits, measured in grams per kilometre (g/km). The DVLA has created seven categories:

Petrol and Diesel engines	
A – up to 100g/km	£0.00
B – 101 to 110g/km	£35.00
C – 111 to 120g/km	£35.00
D – 121 to 130g/km	£120.00
E – 131 to 140g/km	£120.00
F – 141 to 150g/km	£125.00
H – 166 to 175g/km	£175.00
I – 176 to 185g/km	£175.00
J – 186 to 200g/km	£215.00
K* – 201 to 225g/km	£215.00
L – 226 to 255g/km	£405.00
M – over 255g/km	£405.00

*Band K includes cars that have a CO₂ figure over 225g/kg but were registered before 23 March 2006.

CO₂ emission figures

The CO₂ emission figures quoted in the technical data section on pages 48-49 are based on a fully-laden vehicle, including the driver, and the heaviest possible options configuration. Actual CO₂ emissions may be lower depending on options selected.

Audi Service

Servicing tailored to your needs

Regular servicing is key to safeguarding your Audi's performance and a full Audi service history could help you preserve the future re-sale value. To make servicing easy, the Audi Service Schedules have been designed to work with your individual driving style and vehicle.

There are two schedules available and your Audi Centre will advise which schedule is most suited to your needs. The conventional fixed Audi Inspection Service schedule

Inspection Service Schedule

Vehicle usage:	
Mileage	Less than 10,000* miles per annum
Type of journey	Mainly city/town centre driving. Short journeys
Conditions	Frequent cold starts. High engine loading – e.g. frequent hill climbs, vehicle fully loaded, towing
Driving style	Uneconomical – e.g. heavy acceleration, heavy braking, constant changes in speed, constant use of high revs, 'sporty' driving

Fixed Audi Inspection Service Intervals:	
Oil-change Service	Fixed to every 10,000* miles/1 year
Inspection Service	Fixed to every 20,000* miles/3 years, then every 20,000* miles/2 years thereafter

has fixed intervals for the Oil Change and Inspection Service that are based on time and distance, whichever comes first. With the Audi LongLife Service schedule, sensors take account of driving style and conditions in which the vehicle is used to indicate when the Oil Change Service is required. Oil Change Service intervals are therefore variable and are conveniently indicated via the on-board service interval display.

LongLife Service Regime

Vehicle usage:	
Mileage	More than 30 miles per day
Type of journey	Motorway and main road driving. Mainly longer distance journeys. Constant speeds
Conditions	Normal engine loading – e.g. with little or no towing, with little or no hill climbs. Normal vehicle loading
Driving style	Moderate acceleration, moderate braking, engine revs mainly below 3,000

Audi LongLife Service Intervals:	
Oil-change Service	Variable to a maximum of every 20,000* miles/2 years
Inspection Service	Fixed to every 20,000* miles/3 years, then every 20,000* miles/2 years thereafter

*As indicated by the service interval display. Mileages are approximate as the Service Indicator system uses kilometres as its distance measurement.

Service by Design

At Audi, we believe our customers can expect excellent service each and every time they make contact with us. To ensure that this happens, we have agreed a set of service standards with our Audi Centre network that governs the way they do business with you. These standards apply to both Sales and Aftersales, and we actively monitor our Centres to ensure that you receive the highest level of customer service. These service standards will ensure a consistent, stress-free experience whenever you are in contact with anyone representing the Audi brand.

Every Audi Centre will be open during the following hours:

Sales: 9am-6pm Monday to Friday
9am-5pm Saturday

Service: 8am-6pm Monday to Friday
8.30am-1pm Saturday

Sunday opening at local discretion.

Test drives

Whilst we cannot always have the desired demonstrator car ready immediately, we will confirm arrangements for a test drive within two working days (subject to status).

New Car delivery

Once we have confirmed a delivery date with you, we will keep you informed of progress. In the unlikely event of a delay, we will provide you with a courtesy car to minimise inconvenience and keep you mobile.

Delivery to any location within the UK

To maximise your Audi experience right from the first day of ownership, we will deliver your car to your preferred location – whether that's home or your place of work (subject to reasonable notice).

Attention to every detail

Your ownership experience starts with half a tank of fuel.

Quotation response

We are committed to answering any quotation request within 1 working day.

Training

We run a continuous training development programme for all our staff so that we consistently deliver a high-quality, professional service.

Formal complaints procedure

We have a complaints procedure designed to ensure any negative issue you raise with us is dealt with properly.

Courtesy cars

When your car is off the road, perhaps due to a scheduled service or MOT, we will offer you an Audi Courtesy Vehicle until yours is ready. We'll even collect from and deliver to your chosen location, keeping hassle to an absolute minimum.

Service bookings

If you do not require a courtesy car, we will service your Audi within a maximum of 5 working days. If you do choose to take a courtesy car, we will promise to service your vehicle within a maximum of 10 working days.

Cleaning

When your car comes to our workshop, we will wash and vacuum it at no extra cost.

No hidden charges

You will be consulted before we carry out any necessary work on your vehicle, and anything charged for will be itemised on your bill. No extra work will be undertaken without your permission.

A personal service

All work will be done by a named Audi technician, to whom you can personally direct questions or requests should you need to.

Environmental commitment

We promise to dispose of all non-biodegradable materials from your vehicle in a responsible manner.



Pricing information

Pricing

Prices and specifications given are correct at the time of printing. Always check details with your Audi Centre, as Audi policies are continually developing. We reserve the right to change prices or specifications at any time.

All prices are subject to VAT, currently charged at 15%.

Delivery charges and numberplates are not included in the vehicle price.

<u>Delivery charge</u>	<u>£471.30</u>
<u>Numberplates</u>	<u>£20.00</u>
<u>VAT</u>	<u>£73.70</u>
<u>Total</u>	<u>£565.00</u>

Audi Roadside Assistance

Your new car comes complete with complimentary roadside assistance and recovery across the UK provided by RAC Motoring Services. Also included is roadside assistance throughout Europe, managed by RAC Motoring Services.

Audi Customer Care

Every new Audi benefits from the comprehensive Audi Customer Care Package, which comprises:

- ▶ A 3-year Audi warranty, which covers you for unlimited mileage in the first 2 years of ownership, with a full mechanical and electrical warranty which covers you for up to 60,000 miles in the third year
- ▶ A 3-year paint warranty
- ▶ A 12-year anti-corrosion warranty
- ▶ Up to 3 years' UK roadside assistance and recovery

This package, together with Audi variable Service intervals, offers a combination unmatched by any other major manufacturer. Contact your Audi Centre for full details.

Audi Tax-Free Sales

If you are entitled to purchase a vehicle free of VAT, normally through Military or Diplomatic privilege, please contact your local Audi Centre for full details.

Should you have any difficulty obtaining the information you require, please call Freephone 0800 585878.

Audi Finance

Audi Finance specialise in providing funding solutions for Audi drivers. Whether your Audi is for private or business use, there is a range of funding options to choose from.

Below is the full range of finance products.

- ▶ Solutions – a Personal Contract Plan
- ▶ Hire purchase
- ▶ Lease purchase
- ▶ Finance lease
- ▶ Contract hire

With all products, you can choose a fixed-cost maintenance plan designed to help you budget accurately.

No matter what Audi model you choose, your local Audi Centre can provide you with a personalised quote which could fit your budget and motoring needs.

Audi Finance is a trading name of Volkswagen Financial Services (UK) Limited. An offer of finance depends on certain conditions. Available to people over 18 in the UK only.

Audi Insurance

Competitive comprehensive motor insurance designed specially for Audi drivers. All new Audi models come with complimentary seven-day cover upon request – we'll email a cover note directly to your Audi Centre, enabling them to tax your car easily. This way, you can drive straight out of the showroom. Taking out an annual policy is easy and can begin as soon as your free seven-day cover expires.

For more information, contact your local Audi Centre. Alternatively, call 0800 051 3146 for a quote and to receive 7 days' complimentary cover for your new Audi.

Audi Insurance is underwritten and administered by Zurich Insurance Company.

Audi UK

Customer Services
Selectapost 29
Sheffield
S97 3FG
0800 699888
www.audi.co.uk

Specifications and prices subject
to change without notice.

© Audi (UK)

Printed in the UK
Edition 4.2. 05/09
2010 Model Year



Mixed Sources
Product group from well-managed
forests and other controlled sources

Cert no. TT-COC-002327
www.fsc.org
© 1996 Forest Stewardship Council